

2022 Price List

High Point Furniture Industries, Inc.
Effective **09.01.22**



GSA **GS-27F-0017V** & **GS-27F-0016V**

HPFi

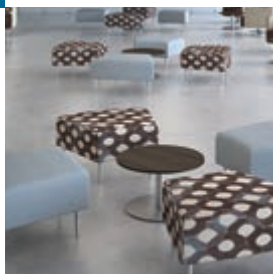

Table of Contents

General References

How to Order	2
Lead Times	3
NOW Accelerated Response	4
Term and Conditions	5
Warranty	8
Sustainability	9

Finishes & Fabrics

Casegoods Finishes	12
Seating Finishes	13
Technical Specification: Wood Finishes	14
Technical Specification: Upholstery	16
COM/COL Program	18
COM/COL Order Form	19
Leather	20
Graded-In: Leather	21
Graded-In: Culp Contract	22
Graded-In: UltraFabrics	22
Graded-In: CF Stinson	23
Graded-In: Douglass Industries	26
Graded-In: Mayer Fabrics	30
Graded-In: Momentum	32
Technical Specification: Seating	34
Seating Controls	35

Power Options

Powerflex	36
-----------	----

Casegoods

Bedford	40
Hyperwork	50
Hyperwork Education	82
Vision	94
Vitality	110

Meeting Tables

Bedford	120
Hyperwork	124
Hyperwork Education	128
Matrix	132
Vitality	136
Accessories	138

Training Tables

Boost Multi-Height (Adjustable)	140
Clique	144
Duality	148
Spencer	150

Occasional Tables

Bedford	153
Eve	154
Flex	154
Hyperwork	155
Malibu	156
Parsec	157
Spencer	158
Trados Metal	158
6700 Series	160
9100 Series	161
Finishes	162

Breakroom Tables

Milan	164
-------	-----

Lounge Seating

Accompany	168
Chesterfield	178
Claudia	180
Eve	182
Eve Harbor	194
Eve Oasis	198
Evette	202
Flex Lounge	206
Flex Mobile	210
Flex Ottoman	214
Flex Tiered	220
Genesis	226
Himalaya	230
Kimberly	234
Lauren	236
Rebecca	238
Scarlet	240
Steps	242
Traditional	246
7300/7400 Series	248
9100 Series	252

Office Seating

HPFi Classic Collection:	254
Quick Silver Contemporary	255
Quick Silver Traditional	255
Scoop Contemporary	256
Scoop Traditional	257
Traditional Series	257
ETC	260
Nexstep	262
Orbit	264

Guest/Ganging Seating

Axxess	266
Contempo	270
Trados	276
Trados Metal	280
Unos	284
700 Series	288
9100 Series	290

Breakroom Seating

Flex Stool	292
Milan	294
Stax	298
Timbre	300

Healthcare

Haley Recliner	304
Hannah Patient Treatment Chair	310
Harmony Daybed/Sleeper	316
Helix Dr. Stool	320

Product Indexes

Casegoods	322
Tables	326
Seating	327
Healthcare	330

How to Order

Authorized Dealers Only

HPFi sells to authorized dealers and resellers of office furniture and only Authorized HPFi Dealers can place orders. To become an Authorized Dealer, you must:

- Have written approval by both the local HPFi Sales Representative and HPFi Sales Management
- Establish a line of credit (or pay for all orders with certified check, Visa or Mastercard or cash prior to order entry)
- Be prepared when Rosenthal & Rosenthal Southeast, Inc. (who acts as the HPFi credit department) contacts you for credit information. Time is of the essence in supplying this data. Purchase Orders cannot be entered until credit processing is completed and a line of credit is established. Allow up to two (2) weeks for processing.

Purchase Orders

To ensure prompt processing of your order, all purchase orders must clearly state the following:

- Dealer Name
Purchase Order Number
Contact Name and Phone Number
Complete Bill To and Ship To Addresses
- Complete Product Numbers, including:
Seating: Model Number + Finish + Options + Upholstery Pattern/Color Number/Color Name.
Casegoods: Model/Finish Number + Options
- Quantities

Order Placement

All orders may be mailed, faxed or e-mailed to HPFi as follows:

Mail

HPFi
1104 Bedford Street
High Point, NC 27263

Fax

800.231.6784

Email

orderentry@hpfi.com

Order Entry

We want to process your order on a timely basis and will make every attempt to enter all orders within two (2) business days of receipt. Inability to clearly read an order or the lack of any of the above information will delay order entry. Clarification of any missing or unclear information will be promptly requested via fax or e-mail. Once all information is received, HPFi will complete order entry.

Your discount and net prices will be automatically calculated. **If your purchase order prices do not match HPFi calculated net prices, you will be notified via e-mail, telephone or fax. It is the customer's responsibility to review Order Acknowledgements for accuracy and pricing. Any corrections must be noted immediately and e-mailed or faxed to your Customer Service Representative at 336.434.5280.**

- Minimum order \$500 net, except for parts.
- Only credit-approved orders are released to production. If an order is held due to credit reasons, you will be informed via fax or e-mail.
- Published lead times start on the first business day **after** entry of a clean, credit-approved order.

HPFi has made every effort to ensure the accuracy of this Price List. HPFi cannot be responsible for typographical errors. Pricing and product specifications are subject to change and can be verified through our HPFi Customer Service Department at 800.447.3462, ext. 2120.

Lead Times

Choose from two (2) lead time options: NOW Accelerated Response or Standard Lead Time. HPFi® lead times are measured from the date the order is entered (complete and credit-approved) to the date the order ships. Transit time is not included as it varies by carrier and destination.

Standard Lead Time

Assigned to all orders unless the purchase order specifically *requests* and meets the NOW Accelerated Response program requirements. Large orders, custom features, COM upholstery, factory-installed options, combination upholsteries and any other special product requests may increase lead time.

Standard lead time is four (4) to six (6) weeks. Orders placed to ship in standard lead times are normally acknowledged to ship thirty (30) business days from the date of order entry. HPFi reserves the right to ship prior to the acknowledged date unless otherwise specified. Occasionally, due to seasonal demand or holiday schedules, standard lead times may be adjusted. To verify lead time, contact your Customer Service Representative.

Many casegood and table items are available with high pressure laminate tops in the finishes listed for those individual series in an extended lead time.

Order Acknowledgements indicate the approximate ship date you can expect. Most orders ship complete by the indicated date. However, we cannot guarantee every order will ship by the date acknowledged. Occasionally, due to circumstances beyond our control, we may ship after the acknowledged date. We will make every effort to anticipate and inform you in advance of any late shipment situations.

NOW Accelerated Response Lead Time

Orders must be complete and credit approved to be released to production. Full details of the NOW Accelerated Response program are outlined in detail on page 4.

Casegood products in this Price Book are marked with the **NOW** symbol. Only the model numbers and finishes indicated are available in the NOW Accelerated Response lead time.

Numerous seating products are available in NOW Accelerated Response program in standard HPFi finishes. Those items are marked with the **NOW** symbol. NOW upholsteries are identified in the NOW Upholsteries Catalog and listed on the HPFi web site. Items ordered with installed options will not be available for NOW Accelerated Response.

NOW Accelerated Response orders must have:

- NOW clearly stated/marked on the purchase order.
- NOW items only on the purchase order requesting accelerated response. Orders including both NOW items and standard lead time items will ship at standard lead-time.
- A limit of eight (8) each of any NOW items per day. Orders exceeding the maximum for the same item cannot be ordered consecutively in the same week without prior approval from an HPFi Customer Service Representative. See page 4 for additional information.

NOW Accelerated Response

HPFi can ship many of our products in less than fifteen (15) business days after the credit-approved order is entered. Products selected for the NOW Accelerated Response program are noted by the NOW symbol. Occasionally, due to seasonal demand or holiday schedules, lead times may be adjusted. To verify lead time, contact your Customer Service Representative.

Finishes & Options

CASEGOODS: Finish and pull options are designated for each applicable casegood product.

SEATING: Seating products available for NOW lead time are only in the selections listed in the NOW Accelerated Response Upholsteries catalog and on the HPFi web site. All other graded-in upholstery are available at standard lead times.

Products ordered with installed options will only be available in standard lead time.

Order Tags

Orders must be clearly marked with NOW and include only those items identified as being available through the NOW program. HPFi will make every effort to ship all credit-approved NOW orders in less than fifteen (15) business days from the date that a complete order is entered with all required details and is credit approved.

Order Quantities

The maximum order size for NOW program is 8 pieces of any item (per dealer, per day) and \$30,000 list regardless of the number of items. Orders for the same item(s) cannot be ordered consecutively in the same week without prior approval from HPFi. Should your product needs exceed these maximums, please contact your Customer Service Representative for manufacturing time. HPFi reserves the right to limit quantities based on material availability.

Changes / Cancellations

CASEGOODS: Contact Customer Service to verify whether a change or cancellation can be made on a casegood products order. If a change is made, the cycle of the number of business days for NOW items begins anew from the date the change was made. No cancellations are allowed once an order ships. HPFi is not responsible for any loss of sale or contract resulting from failure to ship in less than fifteen (15) business days.

SEATING: Due to the breadth of upholstery and finishes available, seating items cannot be changed or cancelled once the NOW order has been entered.

Upholsteries

The list of NOW upholstery available is on the HPFi web site.

Correspondence

Direct all correspondence to:

Mail

HPFi
1104 Bedford Street
High Point, NC 27263

Phone

800.447.3462

Fax

800.231.6784

Email

orderentry@hpfi.com

Website

hpfi.com

Terms & Conditions

All orders are subject to the terms and conditions presented in this price list. The term HPFi refers to High Point Furniture Industries, Inc., High Point, North Carolina - USA.

Terms

Payment for all orders is due Net thirty (30) days from date of invoice.

Ordering

See **How To Order** information on page 2. For clarification of any question pertaining to ordering, contact HPFi's Customer Service Department prior to placing your initial order.

Leasing

Please contact HPFi Sales to learn about leasing options

Conditions of Sale

Possession and/or distribution of this price list or HPFi brochures does not in itself constitute an offer to sell. Orders can be received only from authorized HPFi dealers.

Accepted orders will be acknowledged in writing with approximate shipping dates. Orders will be invoiced at pricing prevailing at time of order entry.

Pricing

This price list contains Zone pricing, including freight prepaid and allowed to the forty-eight (48) contiguous states. HPFi reserves the right to implement and/or pass along a freight surcharge when necessary. All pricing shown are suggested retail. Pricing, specifications and materials are subject to change without notice.

Zones

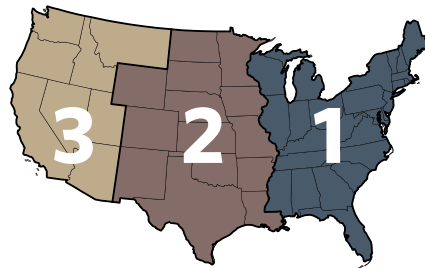

Packaging

Pricing quoted herein includes normal packaging. HPFi products are carefully inspected and are packed one to a carton, except where indicated. All packaging conforms to or exceeds specifications as outlined in the Uniform Freight classification. Special packaging (e.g. palletization) if specified, requires an upcharge.

Palletization

Casegood products ordered in LTL quantities may be palletized prior to shipment for enhanced protection and further assurance of safe delivery. Pallets are one per product, in most cases, and sized per casegood product. Seating is not palletized. All pallets are \$55 net per pallet. Add 40 lb. to the ship weight per pallet. Contact your Customer Service Representative for additional details and a quote.

Palletization is not generally offered on truckload quantities or volume shipments of 14 feet or more (e.g. 4 or more desks). Contact Customer Service for a custom quote if this option is required.

Special Product Orders

We welcome the opportunity to quote special products. Any changes in look, build, finish or options must be processed through the Custom Product Order Program. Please contact our Customer Service Department for pricing and lead times.

NOTE: Due to the cost of creating custom products, a minimum charge per order may apply. Special product orders are non-returnable and non-refundable. A 50% deposit may be required with order placement for special products.

Terms & Conditions

Shipping

All HPFi products ship as follows: **F.O.B. ORIGIN, HIGH POINT, NC - USA, FREIGHT PREPAID** - this means that ownership and the responsibility of the merchandise becomes that of the buyer upon delivery to the freight company. The zone list pricing shown herein reflect the delivered price to the 48 contiguous states. It includes **dock-to-dock** shipment, with normal delivery accomplished in three (3) to ten (10) business days, after shipment. HPFi reserves the right to implement and/or pass along a freight surcharge when necessary.

HPFi also reserves the right to select the carrier and routing. The transportation company assumes full responsibility for safe delivery upon acceptance of the shipment from HPFi.

Orders of less than 500 lbs. will be assessed a minimum freight charge of \$125.00 net per order (excluding items shipped via small package ground service). Shipments outside the USA are prepaid to point of departure.

Acknowledged ship dates are our best estimates of when the product will leave the factory. Actual ship dates may vary.

Third Party Logistics

HPFi can adapt a program for business partners that use a logistics company to manage shipments. Contact the [HPFi Vice President of Sales](#) for terms and conditions.

SPECIAL SERVICES

Shipments requiring special services (such as expedited delivery, delivery appointments, non-dock, residential, school, military base, inside delivery, etc.) are not included in this freight prepaid pricing. The additional charges for these special shipments will be quoted on a pre-pay and add, case-by-case basis. Contact Customer Service for details.

In-Transit Damage

HPFi does not own or operate its own transportation equipment. All shipments made by HPFi are made using third party carriers or customer transportation. HPFi manufactures and packages its products to withstand the normal handling incurred during transportation to provide for safe transit. HPFi ships only top quality undamaged merchandise. Title and ownership of merchandise is transferred to the dealer/customer when the freight carrier signs the bill of lading. The carrier assumes complete responsibility for delivering merchandise to the consignee in good condition.

It is the responsibility of the dealer/customer to inspect all merchandise upon delivery to the customer-designated ship-to address. Any visible damage upon delivery must be noted on the bill of lading when the merchandise is signed for. Freight carriers will accept responsibility for damage which upon their inspection they deem to be their fault. It is the buyers' responsibility to file freight claims with the responsible carrier.

HPFi will provide advice and assistance to its customers with the freight claim process and will use its influence to encourage carriers to accept their responsibility.

Concealed Damage Claims must be filed within 5 days of delivery and original cartons must be retained. Most carriers will not accept a claim for concealed damage if the claim is made more than 5 days after receipt, or if the merchandise is moved from the original delivery location. It is the buyers' responsibility to file claims for concealed damage with the freight carrier.

Terms

An error made by HPFi resulting in shipment of an incorrect or defective product may be allowed for return to HPFi.

Such returns require prior authorization from the HPFi Customer Service

Department. Please call 800.447.3462 to request a Return Authorization and shipping instructions. **All returned products must be properly packaged to ensure safe transit.**

Certain products may not be returned under any circumstances:

- Any non-defective upholstered furniture
- Any seating product made using customer owned material (COM or COL)
- Any product made using special materials or custom finishes
- Any product made to custom specifications of customer

Returns for any other reason will be allowed at the sole discretion of HPFi. These returns will be assessed a restocking charge of up to 30% of product list price plus the cost of return freight. Some products (special order or adapted) will not qualify for return.

Return Authorizations (R.A.s) are valid for forty-five (45) days from the issue date. Authorized returns must have the R.A. number clearly marked on all cartons and the bill of lading. All cartons must arrive at the HPFi designated ship-to location within 45 days of the authorization. Failure to return merchandise within 45 days will result in the cancellation of the Return Authorization and demand

Return Guidelines

- Merchandise must be returned in appropriate packaging to ensure safe transportation. Use the original packaging or the packaging from the replacement units including all inner and outer packaging to repack the returned product. If return is not HPFi's responsibility, repackaging and restocking charges will apply.
- All casegoods must be strapped Top-Side-Up to correct size pallet for return. DO NOT place upside down.
- All shipping documents and product cartons must be clearly marked with HPFi's Return Authorization number.
- You must use the carrier noted on the Return Authorization.
- Failure to comply with requirements will void the Return Authorization; no money will be credited; full payment will be due HPFi.

All returned product shipments received by HPFi will be promptly inspected to verify:

- The product was authorized for return
- The accuracy of counts/quantity
- The reason for return is valid

If approved, HPFi will issue credit to the customer less (where applicable) the restocking charge, return freight and any costs incurred by HPFi to return the products to like new condition.

Cancellations

Acknowledged orders are considered firm and final. No cancellations or changes will be allowed without the express written authorization of HPFi management. Changes may be subject to additional charges. Upholstered items may not be cancelled after the fabrics or other upholstery cover material has been cut. Quick Ship orders cannot be cancelled.

Repair Charges

Authorization must be obtained from HPFi's Customer Service Department prior to incurring repair charges if HPFi is expected to pay any portion of the costs.

Correspondence

Direct all correspondence to:

Mail

HPFi
1104 Bedford Street
High Point, NC 27263

Phone

800.447.3462

Fax

800.231.6784

Email

orderentry@hpfi.com

Website

hpfi.com

Warranty

Subject to the terms, conditions and exceptions stated below, High Point Furniture Industries, Inc. ("HPFi"), warrants that each new finished product, separate component or part ("Product") will be free from defects in material and workmanship, when subject to normal commercial usage, for so long as the Product is owned by the original purchaser. If the Product is sold by HPFi to a retailer or dealer, the "original purchaser" shall be the purchaser of the Product from the retailer or dealer. Otherwise, the "original purchaser" shall be the purchaser of the Product from HPFi. The original purchaser may not assign this warranty to any other person or entity.

Exceptions

HIGH-WEAR PARTS - High-wear parts such as glides, gas cylinders, casters, ergonomic chair components, polymer-based components, and user-adjustable work surface mechanisms are warranted against defects in material and workmanship only for a period of five years (three years on recliner mechanisms and casters) from the date on which the Product is sold by HPFi or until the product is no longer owned by the original purchaser, whichever is the shorter time period.

VENEER FINISHES - Veneer finishes are warranted against defects in material and workmanship only for a period of three years from the date on which the Product is sold by HPFi or until the product is no longer owned by the original purchaser, whichever is the shorter time period.

ELECTRICAL COMPONENTS - Electrical components are not warranted by HPFi, but may have warranties from the electrical component manufacturer.

UPHOLSTERIES - Careful consideration is given to our presentation of upholstery offerings. The upholsteries we offer feature the best in appearance, durability and value. However, we have no control over the environment, cleaning or other conditions which may affect colorfastness or durability. Puddling may occur as a result of certain climate conditions and/or the natural stretch inherent in upholsteries and is not a flaw in the upholstery or manufacturing process. HPFi cannot predict or be held responsible for upholstery performance in an installation and does not guarantee against puddling. Customer's Own Materials (COM) selected by and used at the request of a customer are not warranted. We cannot warrant upholsteries beyond the stated warranty provided by the specific upholstery supplier for that specific material whether it is an HPFi core supplier or COM.

CUSTOMER'S OWN MATERIAL - If HPFi agrees to use the customer's own material (COM) or leather (COL) on HPFi brand products, or build a custom product:

- HPFi shall have no responsibility for the condition, quality, value, performance, physical properties or any other aspect of the COM or COL.
- HPFi shall have no liability for any damages, injuries or losses to the customer or to any third party that shall be caused by any COM or COL and the customer shall hold HPFi harmless for all liability.

For complete COM/COL order requirements and warranty information see the HPFi COM/COL Order Form on pages 18-19.

Exclusions

THIS WARRANTY DOES NOT APPLY AND NO OTHER WARRANTY APPLIES TO:

- Normal wear and tear, which is to be expected over the course of ownership.
- Damage caused by the carrier in-transit, which will be handled under freight policy.
- Damage caused by or during installation.
- Modifications or attachments to the Product that do not have the prior written approval of HPFi.
- Products that are not installed or used or maintained in accordance with Product instructions and warnings.
- Damage caused by neglect or misuse of a Product.
- Products used for personal or household use (all products are intended for commercial usage) or for rental purposes.
- Normal Commercial Usage - The Products are designed and manufactured for normal commercial usage. Normal commercial usage for seating is defined as the equivalent of a single shift, forty (40) hour workweek. To the extent that a Product is used in a manner exceeding normal commercial usage, the warranty will be invalidated or HPFi may, at its option, elect to reduce the applicable warranty period on a pro-rated basis.
- Chairs designated 24/7 have a warranty of five (5) years.
- Color Variations and Finishes - Some natural variations occurring in wood, leather or other natural materials are inherent to their character, and cannot be avoided. Therefore they are not considered defects in material or workmanship and are not the basis for a warranty claim. HPFi does not warrant the color-fastness or matching of colors or grains or textures of such materials.

EXCEPT AS SET FORTH ABOVE, HPFi MAKES NO OTHER EXPRESS WARRANTIES WITH RESPECT TO ITS PRODUCTS. HPFi MAKES NO IMPLIED REPRESENTATIONS OR WARRANTIES WITH RESPECT TO ITS PRODUCTS, THEIR CONDITION, MERCHANTABILITY, FITNESS FOR ANY PARTICULAR PURPOSE OR USE BY THE PURCHASER. HPFi FURNISHES THE ABOVE LIMITED EXPRESS WARRANTY IN LIEU OF ALL OTHER WARRANTIES, EXPRESSED OR IMPLIED, INCLUDING THE WARRANTIES OF MERCHANTABILITY AND FITNESS FOR A PARTICULAR PURPOSE. NO ORAL REPRESENTATIONS OR SAMPLES PROVIDED BY HPFi TO ANY RETAILER, DEALER OR PURCHASER WILL CREATE ANY EXPRESS OR IMPLIED WARRANTIES WITH RESPECT TO PRODUCTS SOLD BY HPFi.

Remedies

If any defect in the workmanship and material of any Product appears within the applicable warranty period, HPFi will, at its option, repair or replace the Product, at no charge, upon examination of the Product and verification by HPFi or its authorized representative of the defect and of compliance with the warranty requirements and conditions. The Purchaser must provide such cooperation and information as HPFi or the authorized representative may reasonably request to process the warranty claim.

IN THE EVENT OF ANY DEFECT IN ANY PRODUCT SOLD BY HPFi OR ANY BREACH OF THE LIMITED EXPRESS WARRANTY DESCRIBED ABOVE, THE SOLE REMEDY FOR SUCH DEFECT AND/OR BREACH SHALL BE AS STATED IN THIS PARAGRAPH, AND IN NO EVENT SHALL THE DEALER OR RETAILER THAT PURCHASED THE PRODUCT FROM HPFi OR THE ORIGINAL PURCHASER OF THE PRODUCT FROM THE DEALER OR RETAILER, BE ENTITLED TO RECOVER FROM HPFi ANY DAMAGES, INCLUDING DIRECT, CONSEQUENTIAL OR INCIDENTAL DAMAGES, LOST PROFITS, DOWNTIME OR OTHER DAMAGES OF ANY NATURE WHATSOEVER ARISING FROM BREACH OF WARRANTY OR THE CONDITION, FUNCTION OR USE OF THE PRODUCT.

Application of Current Warranty and Prior Warranties

This express limited warranty applies only to Products manufactured and sold by HPFi on or after April 1, 2001. Products manufactured and sold by HPFi before April 1, 2001 were covered by the warranty in effect at that time and have expired. Further information concerning terms and conditions of prior warranties are available upon request to HPFi.

These warranties are made by HPFi only to authorized dealers and retailers acquiring Products directly from HPFi and the original purchaser of the Product as defined above.

Sustainability

For more than 60 years, HPFi® (High Point Furniture Industries) has been building furniture in the United States with respect to our environment and our community. As a world-class manufacturing operation, we strive to reduce and to eliminate impact on our environment.

- We recycle and reuse wherever possible. When viable and acceptable to our customers, we incorporate recycled and recyclable materials into our finished products.
 - Laminated panels used in our casegood products come from suppliers that meet Sustainable Forestry Initiatives (SFI) standards and/or Forestry Stewardship Council (FSC). The boards exceed 80% pre-consumer recycled wood fibers and meet EPA and California Air Resource Board standards (Phase 2) for formaldehyde emissions.
 - Engineered wood components for upholstered seating products also meet SFI standards and meet EPA and California Air Resource Board Standards. Seating foam is CFC-free and includes rapidly renewable bio-based materials.
 - Dust collection systems are in place to collect residual wood released during processing of raw wood materials into finished components for final assembly. The collected sawdust is reused for generating fuel, reducing waste as well as conserving another valuable resource, petroleum.
 - Proper finishing equipment is installed and maintained to appropriately collect any negative-impact materials. These are turned over to environmental professionals that specialize in safe and effective handling of such materials, further protecting our world.
 - HPFi actively markets fabrics that are both 100% recycled (or bio-based) as well as completely recyclable (or compostable). These fabrics are manufactured from post-consumer polyester (waste material left over once a consumer has used a product, such as a soda bottle) and post-industrial polyester (waste generated by an industrial process before the polyester is used by a consumer). In Life Cycle Assessments, some recycled fabrics showed significantly lower environmental impact than fabrics made with virgin polyester across all twelve of the categories studied.
 - All corrugated cardboard material and containers used in the packaging and transport of our furniture products are made with a minimum of 41% recycled material (post-consumer and/or post-industrial) and meets standard performance requirements.
- All of our associates are involved in environmentally-friendly practices:
- We utilize a 4-day manufacturing week, thereby reducing fuel consumption in both operations and commuting
 - Our sales brochures are printed on FSC-certified paper
 - Multiple collection bins are throughout our facilities for recycling and diversion of all production materials from landfills
 - Office paper, bottles, cans, etc. are collected in our offices for recycling

At HPFi, we understand the future does not belong to us, nor does the earth, nor its resources. The maintenance of our environment and a commitment to sustainability is an ongoing responsibility that we share with every person, organization and industry enjoying the abundance of this earth. We pledge to continually respect our resources and build community for those of us here today and for those who will follow.

Our sustainability efforts extend beyond the materials and processes involved in the manufacture and fabrication of our products. We also address end-of-life opportunities for our furniture with the Second Life program providing a solution for disposal of unwanted furniture (when no other avenue is available) while preserving our environment. HPFi works with local charitable and non-profit organizations to help furniture find a Second Life. Those organizations are helped in furthering their purpose with needed furniture that may otherwise be unattainable.

Additionally, our efforts involve social responsibility with HPFi associates as well as our business partners.

For additional information and the most up to date details, visit http://www.hpfi.com/about_sustainability_overview.php.



Finishes & Fabrics



Casegoods Finishes

	Black	Boardwalk (Smooth)	Boardwalk (Textured)	Driftwood (Smooth)	Driftwood (Textured)	Espresso	Graphite	Mahogany	Monticello Maple	Natural Maple	Shoreline (Smooth)	Shoreline (Textured)	Windsor Cherry
CASEGOODS SERIES													
Bedford (HPL top)								•					•
Hyperwork	•	••	•	••	•	•	•	•	•	•	••	•	•
Hyperwork Education	•		•		•	•	•	•					
Vision	•	••	•	••	•	•	•	•	•	•	••	•	•
Vitality (HPL top)								•					•

MEETING/TRAINING/BREAKROOM TABLES													
Bedford (HPL top)								•					•
Boost	•	•	•	•	•	•	•	•	•	•	•	•	•
Clique	•	•	•	•	•	•	•	•	•	•	•	•	•
Duality	•	•	•	•	•	•	•	•	•	•	•	•	•
Hyperwork	•	••	•	••	•	•	•	•	•	•	••	•	•
Matrix	•	••	•	••	•	•	•	•	•	•	••	•	•
Milan	•	•	•	•	•	•	•	•	•	•	•	•	•
Vitality (HPL top)								•					•

OCCASIONAL TABLES													
6700 Series (TFL top)	•	•	•	•	•	•	•	•	•	•	•	•	•
6700 Series (Veneer top)	•	•		•		•		•		•			•
Bedford								•					•
Eve	•		•		•	•	•	•	•	•		•	•
Flex	•		•		•	•	•	•	•	•		•	•
Hyperwork	•	••	•	••	•	•	•	•	•	•	••	•	•
Malibu	•		•		•	•	•	•	•	•		•	•
Trados Metal	•	•	•	•	•	•	•	•	•	•	•	•	•

- available
- tops only

Finish Coordination

	Black	Boardwalk	Driftwood	Espresso	Mahogany	Monticello Maple	Natural Maple	Shoreline	Windsor Cherry
CASEGOODS/TABLES LAMINATE FINISH									
Code	E	BW, SB	DW, SD	X	M	MM	FM	SL, SS	WC
SEATING FINISH									
Code	BLK	BW	DW	ESP	MAH	MM	FM	SL	WC

The HPFi Finishes Card provides comprehensive visual reference to laminate, seating and veneer occasional table finishes for quick, easy selection. Request a copy through your local sales representative.

Seating Finishes

	Black	Boardwalk	Driftwood	Espresso	Graphite	Mahogany	Natural	Moab	Monticello Maple	Shoreline	Windsor Cherry
LOUNGE											
7300-7400 Series			•				•				•
Accompany	•	•	•	•	•	•	•	•	•	•	•
Chesterfield	•	•	•	•	•	•	•	•	•	•	•
Eve (wood leg option)	•	•	•	•	•	•	•	•	•	•	•
Genesis	•	•	•	•	•	•	•	•	•	•	•
Himalaya	•	•	•	•	•	•	•	•	•	•	•
Kimberly	•	•	•	•	•	•	•	•	•	•	•
Lauren	•	•	•	•	•	•	•	•	•	•	•
Rebecca	•	•	•	•	•	•	•	•	•	•	•
Scarlet	•	•	•	•	•	•	•	•	•	•	•
Traditional	•	•	•	•	•	•	•		•	•	•

CLASSIC COLLECTION											
Quick Silver Contemporary	•	•	•	•	•	•	•	•	•	•	•
Quick Silver Traditional	•	•	•	•	•	•	•	•	•	•	•
Scoop Contemporary	•	•	•	•	•	•	•	•	•	•	•
Scoop Traditional	•	•	•	•	•	•	•	•	•	•	•
Traditional	•	•	•	•	•	•	•	•	•	•	•

GUEST/GANGING											
9100 Series	•	•	•	•	•	•	•	•	•	•	•
Axxess	•	•	•	•	•	•	•	•	•	•	•
Contempo	•	•	•	•	•	•	•	•	•	•	•
Trados	•	•	•	•	•	•	•	•	•	•	•
Unos	•	•	•	•	•	•	•	•	•	•	•

BREAKROOM											
Milan Chairs						•					

HEALTHCARE											
Haley	•	•	•	•	•	•	•	•	•	•	•
Arm Cap Option	•	•	•	•	•	•	•	•	•	•	•
Tablet Option	•	•	•	•	•	•	•	•	•	•	•

Technical Specifications: Wood Finishes

Wood Finishes

Finishes available as standard on our wood seating products are for the exposed wood components. This wood is kiln dried maple and similar hardwoods.

Standard Colors

- **Black** - a fade resistant black stain with a low-gloss lacquer top coat. *Specify wood finish code **BLK**.*
- **Boardwalk** - a fade resistant light brown/taupe stain with a medium gloss lacquer top coat formulated to be compatible with Boardwalk casegoods finish. *Specify wood finish code **BW**.*
- **Driftwood** - a fade resistant dark gray stain with a medium gloss lacquer top coat formulated to be compatible with the Driftwood laminate casegoods finish. *Specify wood finish code **DW**.*
- **Espresso** - a fade resistant dark Walnut stain with a medium gloss lacquer top coat. *Specify wood finish code **ESP**.*
- **Mahogany** - a fade resistant mahogany stain with a medium gloss lacquer top coat. *Specify wood finish code **MAH**.*
- **Natural** - a clear lacquer gloss top coat. *Specify wood finish code **FM**.*
- **Moab** - a fade resistant medium-brown stain with a medium-gloss top coat. *Specify wood finish code **MOB**.*
- **Monticello Maple** - a fade resistant beige stain with a medium gloss lacquer top coat. *Specify wood finish code **MM**.*
- **Shoreline** - a fade resistant grey stain with a medium gloss lacquer top coat. Formulated to be compatible with Shoreline casegoods finish. *Specify wood finish code **SL**.*
- **Windsor Cherry** - a fade resistant red-brown cherry stain with a medium gloss lacquer top coat. *Specify wood finish code **WC**.*

Ordering

When ordering, please specify the quantity of each model, the complete model number, followed by a dash, the wood finish code, followed by the fabric name and fabric number. Example: To order 12 of model 1271 in a Driftwood finish in CF Stinson's Satellite 62826 Domino, your order should read:

12 1271 DW Satellite Domino

The standard finishes available for each seating product are specified by a wood finish code suffix. Wood finishes are available as noted on each page of this Price Book. The following legend for the wood finish code is listed on each page of products available with a wood finish.

Special Finishes

Please contact our Customer Service Department for additional information.

Technical Specifications: Wood Finishes

Antimicrobial/Antibacterial

HPFi employs a proprietary seating finish under the name, Sentinel™. Our finish employs silver ions - a powerful, natural antimicrobial, antibacterial which assists in preventing the spread of infections without harm to human health. Disease-causing organisms on wood chair frames with Sentinel™ antimicrobial silver remain latent, thereby unable to propagate and soon naturally expire. Sentinel™ antimicrobial finish cannot be washed away, worn off or depleted overtime. Its effectiveness is as powerful at the end of the life cycle as it is at its start.

Color Variations

Variations in wood color and grain pattern, contribute to the natural beauty of wood. The natural characteristics of the different species of wood, add to the distinctiveness of furniture and cannot be considered defects.

Some examples of these natural characteristics include:

- **Pitch pockets.** These are common in fruit woods such as cherry. They appear as a dark spot in the grain that may not always accept finishing materials.
- **End-grain.** This occurs on the edges of chair frames and desk tops. They appear as a color variation of the tree's growth ring, commonly called "tiger striping".
- **Color variations.** All real wood products exhibit a certain amount of color variation when finished. This color variation is most often caused by the natural difference of initial color of the raw wood. This initial color, as with many other of the characteristics of real wood, is naturally occurring and contributes to the beauty of the finished product. These color variations are more noticeable in light colored woods finished with a clear lacquer finish.

HPFi strives to control variations in color as much as practical. However, slight variations do occur naturally and should not be considered defects.

Dimensions

All size dimensions listed are nominal and subject to change. If you must have exact dimensions, please contact your Customer Service Representative. Worksurface dimensions will vary due to edge profile treatment. Always measure the actual top before ordering glass or another cover to fit table tops.

Technical Specifications: Upholstery

Cleaning Codes

Each upholstery utilized by HPFi has a cleaning code letter, assigned by the manufacturer for a specific pattern and is listed on the swatch card. The cleaning codes are as follows:

- W** - Water based cleaners recommended.
- S** - Solvent based cleaners recommended.
- WS** - Water or solvent based cleaners recommended.
- X** - Do not use any cleaning fluids.
- C** - 10% Bleach, 90% Water, rinse

To prevent overall soiling, frequent vacuuming or light brushing to remove dust and grime is recommended. Always pre-test a small inconspicuous area before proceeding to remove the stain.

Fabrics

HPFi strives to offer the best in appearance, durability, and value. Please refer to the seating warranty section on page 4 for more information. Most fabrics are ordered at the time we receive your order. Therefore no cancellations or changes are allowed once your order is entered and the fabrics are ordered. Please make certain that your clients know this when they are making their fabric selections.

OVERVIEW: Man-made fibers such as acrylic, olefin, polyester and nylon have achieved new levels of performance with current changes necessitating a true evaluation of each fabric on its own merit. Do not assume that a specific fabric is always the best. Consult the test results on the fabric specification sheet or sample card and evaluate its performance for your particular application. HPFi chooses only those fabrics that attain the upper portion of the durability spectrum.

Vinyl

OVERVIEW: Vinyl coverings are normally 100% virgin PVC (Polyvinyl Chloride) supported by a man-made backing. They are sometimes textured and then surface finished or capped with a chemical film. Some vinyl upholsteries are formulated to include silver ion particles, to provide an antibacterial and antimicrobial surface. Consult the technical information on the back of the vinyl swatch cards to choose the desired characteristics for the environmental setting in which the seating units will be used.

PROTECTION: Periodic cleaning of the vinyl by washing with lukewarm water and a mild soap will prevent hardening, cracking and peeling due to body oils and body care products. Clean with wet sponge and dry with dampened cloth or sponge. Certain commercially available products clean routine spills effectively without causing the material to exude (lose) the softening agents which keep the vinyl soft and pliable. Improper cleaning products can break those softening agents and cause the vinyl to crack and peel.

Faux Leather

OVERVIEW: Faux Leather is the term most commonly used for man-made polymers such as polyurethane or vinyl. It is a resilient, flexible and durable material that offers textures and a soft feel similar to that of leather. Like genuine leather, polyurethanes do offer some breathability (vapor transmission) whereas vinyl normally doesn't.

PROTECTION: The greatest advantage of a faux leather over genuine cowhide leather is the cleanability and consistency of appearance

Leather

OVERVIEW: Leather, by virtue of its natural inherent beauty, warmth and durability, creates aesthetic appeal for those individuals desiring the very finest in office seating. The exclusive use of top grain cowhides by HPFi in Grades L and LL, assures the customer of genuine leather as opposed to split or bonded leather substitutes.

The growth marks and healed scars which occur during the animals' lifetime give leather its distinguishing "character". These signatures will appear on the chair leather, assuring the customer of the use of authentic top grain hides. Genuine top grain leather mellows with age and gains a quality and value which is unlike any man-made substitute.

FULL AND TOP GRAIN LEATHER VS. SPLIT LEATHER:

When the hide is separated from the animal, it can be as much as 3/4" thick. A splitting machine then splits the hide into layers of desired thickness. Only the first cut is used on HPFi seating to insure maximum strength and beauty.

PROTECTION: To remove spots and spills, wipe excess liquid up immediately with a clean absorbent cloth or sponge. If necessary, use clean lukewarm water only and let air dry naturally. If water is used, clean the entire area where the spot occurred. An example would be the entire seat cushion or entire arm. DO NOT dry wet areas with hair dryers, etc. For butter, oil or grease, wipe excess butter, oil or grease off the leather with a clean dry cloth, then leave it alone as the spot should dissipate into the leather in a short period of time. DO NOT apply water or try to wash such spots.

Please Note: These are recommended or suggested methods of cleaning. HPFi is not responsible for damage incurred while cleaning.

Upholstery Testing Terms

SURFACE ABRASION: Abrasion resistance is the ability of a fabric to resist surface wear caused by flat rubbing contact with another fabric. There are two different methods commonly used to test abrasion, referred to as Wyzenbeek and Martindale. Most contract grade fabrics are tested using the Wyzenbeek method. Fabrics with abrasion results below 15,000 Wyzenbeek double rubs / 20,000 Martindale cycles may prove unsatisfactory in contract upholstery application. Abrasion results exceeding 100,000 double rubs / cycles are not meaningful in providing additional value in use. Higher abrasion resistance does not necessarily indicate a significant extension of the service life of the fabric. A fabric with double the number of abrasion cycles does not indicate double the service life. There is no correlation between different test methods. It is not possible to estimate the results that might be achieved on one test, by reviewing the results from another (e.g., Martindale & Wyzenbeek.)

The following guide is a general rule of thumb for upholsteries on HPFI furniture using the Wyzenbeek test method:

Light Duty - 15,000 cycles (double rubs)
Medium Duty - 35,000 cycles (double rubs)
Heavy Duty - 50,000 plus cycles (double rubs)

For more information on surface abrasion, visit the web site for Association for Contract Textiles at www.contracttextiles.org.

CROCKING: The degree of resistance of material to change color characteristics, or transfer its color to other materials in any environment during the life of the fabric.

TEAR STRENGTH: The force necessary to tear a fabric, usually expressed in pounds or in grams. The most commonly used method for determination of tear strength is the Elmendorf test procedure.

TENSILE STRENGTH: The actual number of pounds of resistance that a fabric will give to a breaking machine before the material is broken.

FADOMETER/COLOR FASTNESS: The fadometer (light) test determines the resistance of a specific fabric color to prolonged exposure to sunlight utilizing a water-cooled xenon lamp fading apparatus for simulation. The color fastness test determines the degree of color retention and change in shade (or lack of) during the normal life of the fabric.

FIRE RETARDANT: Fabrics treated with special chemical agents or finishes to make them retardant or resistant to burning. Fabrics may also achieve this property by using fibers with these properties built directly into the polymer. Fire retardant coatings or specifications vary according to code requirement. Please consult fabric specifications listed with each pattern in upholstery catalog for specific code acceptability. Upholsteries offered or recommended by HPFI do not contain polybrominated diphenyl ethers (PBDE).

Flammability & Fire Codes

Treatment or finishing of fabrics is varied as many states and municipalities have developed their own criteria for fire retardant coverings. Although attempts have been made to offer a fabric which will pass as many of these codes as a group (e.g. Boston Fire Dept. Std., The Port Authority of N.Y. and N.J., and California Technical Bulletin 117), it may be necessary to specifically treat a fabric for a special code. If special treatment is required, or if treatment of a current fabric offered by HPFI to meet a certain code is required, please contact our Customer Service Department for quotation.

All upholsteries offered by HPFI supplier partners meet California Technical Bulletin 117. The current version is California TB 117-2013. Any upholstery that meets this standard will also meet similar test methods ASTM, UFAC or NFPA260.

Consult specifications on our upholsteries partners' web sites for pertinent fire code ratings and specifications. These specification sheets are also available from our Customer Service Department.

Please remember that a fire retardant fabric isn't fireproof or flameproof. The purpose of the retardant is to make fabrics flame resistant to a smoldering cigarette in order to provide time for egress.

COM/COL Program

Customer's Own Material/ Customer's Own Leather

Upholstery material(s) furnished to HPFi by the customer requires special processing. Prior to HPFi accepting any COM orders, the COM/COL Order Form (see next page) must be submitted to HPFi for yardage requirements. Once this form is returned to you, you may accurately order your upholsteries for shipment to HPFi.

Any order received without the accompanying fabric will be entered and acknowledged with an open shipping date until fabric is received.

Inquiries should be sent to:
HPFi COM/COL Coordinator
1104 Bedford Street
High Point, NC 27263
(t) 800.447.3462
(f) 800.231.6784
(e) info@HPFi.com

Shipping Address

All COM/COL fabrics and leather must be shipped prepaid to:

HPFi COM/COL Coordinator
1104 Bedford Street
High Point, NC 27263

Make sure a copy of the COM/COL order form is attached to the upholstery (see form on following page). COD's are not accepted on customer's own material (COM) or customer's own leather (COL).

Shipping Dates

If an acknowledged order contains both graded-in and COM/COL upholstered items on the same order, the order will be processed with an open ship date. Once the COM/COL upholstery is received, standard lead times will apply to the entire order.

General Information

- Upholsteries used on the horizontal "step" surfaces of Flex Tiered seating must be a minimum seam slippage / seam strength of 40 lbs. warp and 40 lbs. weft (fill). HPFi will not upholster any Flex Tiered seating without test data to substantiate that the materials meet this criteria.
- For specific yardage requirement, send the COM/COL order form request (see next page) to the HPFi Customer Service department. Seating model numbers, quantities and upholstery application orientation are required. A timely reply will be forwarded with yardage required.
- Do not fold any upholstery (textile, coated fabric, vinyl, polyurethane or leather) for shipment. All upholsteries must be rolled on a cardboard tube for shipment to HPFi. Folded fabric or leather may sustain permanent creasing, rendering it unsuitable for upholstering. HPFi will not apply creased goods to any upholstered item(s).
- COM orders are priced at Grade 2.
- COL orders are priced at Grade 3.

Warranty and Application of Upholsteries

- Upholsteries received from the supplier or customer for COM/COL applications are not covered by any warranties expressed or implied by HPFi including but not limited to wearability, light fastness or tailoring.
- Do not estimate COM yardage from yardage in this Price Book. The yardage requirements shown in this Price Book are based on the use of non-directional upholstery, 54" wide applied in a "Topped" orientation.
- While we make every effort to check and cut COM material in the most appropriate manner, claims for flaws, insufficient yardage, discrepancies in the fabric, imperfections in the material, dye lot variations, or wearing quality of material furnished by the customer cannot be honored.
- Please fill COM/COL form completely including topped out or railroaded applications also add horizontal and vertical repeats.

Combination Upholsteries

Many seating items may be selected with multiple upholstery covers on a single unit, such as vinyl arms and fabric seat/back or solid color fabric arms with a pattern seat/back. HPFi can accommodate these special requests as outlined below.

Indicate clearly on original order the combination of desired fabrics as follows:

- Chair Model
- Finish (if applicable)
- Seat fabric
- Back fabric
- Arm fabric

If seat and back will be same fabric, the order can list it as such.

Be certain to provide complete description of upholsteries, including pattern name, color name, and color number (if available).

Combinations are available on all graded-in upholsteries at standard lead time. Combinations using COM upholsteries may require additional lead time and must follow the COM order process.

COM/COL Order Form

All information on this form is required to accurately calculate the COM yardage/COL sq. ft. needed. Please complete and send to the HPFI COM/COL Coordinator. Email: CustomersOwnMaterial@hpfi.com Fax: 800.231.6784

CUSTOMER INFORMATION

Account Number (if known)	Date	Dealer Name	
Street Address	City	State	Zip
Phone	Fax	Email	

UPHOLSTERY INFORMATION

Mill / Distributor	Pattern Name	Pattern Number
Material Content	Color Name	Color Number

Description

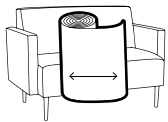

Railroad Orientation

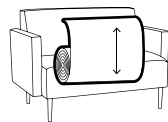

Topped Orientation

Repeat Size (inches)		Seam Slippage / Strength (Flex Tier only)	
Vertical	Horizontal	Warp	Weft/Fill

• Yardage requirements shown in the HPFI Price Book are based upon the use of 54" wide, non-directional upholstery applied in the "Topped" orientation.

ORDER INFORMATION

Quantity	HPFI Seating Item Number	Description	PO #

• COM/COL orders will not be scheduled for production until all upholsteries have been received.

• When combination upholsteries are required, line art indicating the specific location of each upholstery must be submitted.

WARRANTY INFORMATION

• Please see Technical Specifications in HPFI Price Book for complete COM/COL specifications.

• HPFI does not warranty the quality of COM/COL materials. It is the responsibility of the supplier of the material.

• COM/COL upholsteries are not covered by any warranties expressed or implied by HPFI including, but not limited to wearability, light fastness or tailoring.

SHIPPING INFORMATION

Ship Prepaid To: **HPFI c/o COM Coordinator
1104 Bedford Street,
High Point, NC 27263**

• Please include reseller (dealer) **name** and **PO #** on COM supplier packing list.

Section Below to be Completed by HPFI

COM / COL Yardage Requirements (as requested)	Date	Signature
---	------	-----------

Leather

REAL.

When you specify *LEATHER* furnishings from *HPFi*, each piece is *100% LEATHER*. All are real, top-grain leathers. No synthetics. No substitutes. Just real leather selected for quality and characteristics that create unique furnishings.

NATURAL.

Leather is a *NATURAL MATERIAL*. It is an environmentally conscious upholstery cover salvaged as a by-product from meat production processes. Incorporating leather into multiple products – from furniture to clothes – is consistent with sustainability efforts to reduce environmental impact.

LEATHER.

Leather is *UNIQUE*. Each hide features characteristics developed in nature, distinguishing it from any other hide. Even within a leather hide, variations in color, texture and markings (scars, scratches, wrinkles, etc.) are natural and will appear within a given upholstered piece of furniture. These variations are not imperfections, rather they are the very essence of what makes leather an exquisite and preferred upholstery material.

HPFi can work with our leather supplier partners to color match an existing leather installation. There is a minimum of 500 square feet. Lead time to color match will take 5 - 6 weeks.

Note: HPFi leather seating employs multi-piece backs and sides to improve yield of natural leather hides.

Leather Advantages

History and tradition of use generate a special affinity and emotional preference for leather. Also consider:

- Leather breathes. It can absorb up to 25% of its own weight in humidity and release that humidity, so the body does not perspire on leather as it does on vinyl.
- Leather adapts to the closest temperature. An untouched leather chair remains room temperature. Once you sit down, the leather reaches body temperature, no higher!
- Leather is less permeable than fabrics. This barrier feature protects internal chair components from spills, inhibits dust collection by a chair's cushioning material and provides easily cleanable surfaces.

The Language of Leather

Leather hides are processed in many different fashions, creating a variety of appearances, tactile qualities and performance capabilities. These processes and the resulting characteristics create a leather language used to classify leathers:

FULL VS. CORRECTED GRAIN.

Full grain leathers exhibit more of the natural variation, texture and markings of the animal. These leathers are generally softer than corrected leathers. Corrected grain leathers have been mechanically altered through buffing, sanding or embossing to create more consistent grain pattern and uniform appearance.

TOP GRAIN.

All are *TOP-GRAIN LEATHER* taken from the *OUTERMOST LAYER* of the hide, providing the *STRONGEST*, softest and most breathable leather from the hide. Additionally, top grains show the natural markings (wrinkles, scratches, scars, etc.) that make each leather unique.

SEMI-ANILINE.

Starting with the same base as full aniline, the semi-aniline is a soft leather featuring a transparent finish that improves light and stain resistance. Slight pigmentation may be added to minimize color variation within the hide.

HAND ANTIQUED.

As the name implies, these leathers are handcrafted using traditional leather techniques.

PIGMENTED.

These leathers feature pigment dye applied by machine spray or roller coating, then followed by a finish coat to seal the pigment. Pigment/sealer increases a leather's resistance to fading and wearing while decreasing the softness of the material. Pigmented leathers are easier to clean and care for than non-pigmented leathers.

PULLUP.

Pullup leathers derive their color from waxes or oils, which dissipate and become lighter in color when the leather is pulled, as done during the upholstery process. This creates worn, weathered, distressed appearance typically found only on furnishings subjected to years of use.

SAUVAGE.

Subtle, abstract two-tone finishes on leather provide visual depth and interest to a leather and are known as *Sauvage*.

Graded-In: Leather

Due to the natural characteristics of leather, finished furnishings may vary from original swatches. HPFi neither guarantees nor warrants leather for color, color consistency, grain or other characteristics. We cannot accept return of leather furnishings for such issues.

Grade L

BAROQUE (CONNEAUT)

Code	Color
AL03	Black
AL04	Blackberry
AL05	Midnight
AL06	Hunter
AL07	Spruce

CLASSICO (OPTIMA)

Code	Color
Black	Black
Chocolate	Chocolate
Henna	Henna
Wine	Wine

CRACKLE (CONNEAUT)

Code	Color
AL12	Chianti
AL13	Coffee
AL14	Walnut

MAMMUT (WOLLSDORF)

Code	Color
AL18	Black
AL15	Parchment
AL20	Burgundy
AL16	Hunter Green
AL19	Navy
AL17	Fawn
AL22	Tan
AL23	Espresso

Grade LL

FOC EARTH (WOLLSDORF)

Code	Color
560001	Black
560007	Tobacco
560029	Parchment
560032	Chocolate
560035	Fawn

KINGSLAND (CONNEAUT)

Code	Color
AL21	Coffee
AL24	Navy
AL27	Chaps
AL29	Jalapeno

LENA (GREENHIDE)

Code	Color
2500	Pewter
3338	Navy
3364	Sequoia
3368	Chateau
3396	Linen
5454	Celtic
8000	White
9000	Black

Name	Number of colors	100% Top Grain	Full Grain	Semi-Aniline	Pigmented	Machine Spray	Sauvage	Chrome-Free
Baroque	5	▪		▪	▪	▪	▪	
Classico	30	▪		▪	▪	▪		
Crackle	3	▪		▪	▪	▪	▪	
FOC Earth	31	▪		▪	▪	▪		▪
Kingsland	4	▪		▪	▪	▪	▪	
Lena	48	▪	▪	▪	▪	▪		
Mammut	8	▪		▪	▪	▪		▪

PLEASE NOTE: Only fabrics included in the graded-in list are approved for usage on HPFi products from that manufacturer. Refer to website for current list of fabrics available in the **now** program.

Graded-In: Fabrics

Updated 09/01/22

HPFi seating is available in the following upholsteries from these mills/distributors. Patterns have been graded in to simplify quoting/ordering as well as save time versus the Customer's Own Material processes. Please visit the suppliers' web sites or www.hpfi.com for the most up to date list as materials may vary throughout the year.

Culp Contract

Pattern	Grade	Pattern	Color
AB	2	Marchmount	3
Antic	2	Montgomery	2
Aptitude	3	Moretti	3
Archetype	3	Morticia	3
Benday	2	Palance	3
Book Club	3	Petal Pusher	3
Boothby	2	Plot Line	3
Bravo	3	Punch Card	2
Brouhaha	3	Purl	3
Bunnyhop	2	Ribby	3
Cantina Recycled Leather	3	Ridgecrest	2
Castillo Faux Leather	3	Rushmore	3
Chronicle	3	Short Cut	3
City Park	3	Smith	3
Connelly	3	Stancil	3
Critic's Choice	3	Suave	3
Demure	3	Swanky	2
Dillon Faux Leather	1	Tabby	4
Dorset	1	Tome	3
Dot Com Faux Leather	3	Truman	3
Fandango	2	Utmost	2
Feather Grain	3	Viceroy	3
Fine Tune	3	Warrington	3
First Dibs	3	Weehawken	4
Golly	4	Winslow	3
Ground Control	3	Yosemite Faux Leather	1
Gunslinger Recy. Leather	3		
Halyard	3		
Hathaway Vinyl	2		
High Cotton	3		
Ion	4		
Kedar	2		
Legato	3		
Linette	2		
Lorna	3		

UltraFabrics

Pattern	Grade
Brisa	13
Brisa (Outdoor)	13
Brisa Distressed	13
Brisa Frontier (Outdoor)	13
Fresco	13
Mokume	13
Spectra	13
Coast	13
Cove	13
Cora Outdoor	13
Dwell	13
Eco Tech	13
Fusion	13
Fusion Shimmer	13
Geom	13
Helix	13
Pearlized	13
Pony	13
Promessa	9
Pebble (Outdoor)	13
Pumice (Outdoor)	13
Reef Pro	13
Summit (UL Distressed, Outdoor)	13
Tottori	13
UF Select Impasto	7
UF Select Lino	7
UF Select Montage	7
Ultraleather	13
Ultraleather Antistatic	13
Ultraleather Pro	9
Volar Bio	15
Wired	13

PLEASE NOTE: Only fabrics included in the graded-in list are approved for usage on HPFi products from that manufacturer. Patterns in bold are available in the **now** program.

Graded-In: Anzea

All HPFi seating products are available in Anzea fabrics. Patterns have been graded in to simplify quoting/ordering as well as save time versus Customer's Own Material processes. Contact Customer Service with HPFi models, quantities and selected Anzea patterns. Patterns not listed must be priced per project. Visit www.HPfi.com or www.anzea.com for the most up to date list as materials may vary throughout the year.

Woven Textiles

Pattern	Grade
Alameda	11
Alexandria	12
April	17
Baby Bear	10
Bacci	13
Baltic- O	14
Beach Blanket	12
Bleecker	6
Bloom	12
Bonnie	9
Boswell	6
Catwalk	20
Chimera	11
Conga	12
Cornered	12
Cosmic Expressions	14
Essex	7
Fionna	9
Fulton	7
Garden Gems	16
Gazebo	15
Greenwich	7
Greenwood	7
Grit	13
Halsey	14
Handloom	12
Hansel	12
Haywire	14
Henderson	6
Horizon	13
Hudson	6
Kapow	9
Kazam	8
La Piazza	12
Lafayette	9
Lancaster	7
Landfall	16

Coated Fabrics

Pattern	Grade	Pattern	Grade
Limerick	17	A New Twist	8
Loomis	15	Big Bang	8
Lucid Lines	14	Bronte	12
Ludlow	7	Buckaroo	16
Lumber Jack	17	Bull's Eye	17
Lumber Jane	17	Bye Bye Birdie	11
Mesa	12	Calf Crazy	16
Metro	11	Canyon	7
Mindbender	12	Cheap Seats	10
Miragi - O	15	City Slicker	10
Mohair Magic	call	Copy Cow	7
Morph	12	Cowtown	11
My Way	14	Crosshatch	8
Outer Limits	18	Dash of Color	10
Pacific-O	14	Dazzler	15
Palms	12	Extra Celestial	13
Party Boat	14	Gelato	11
Phantasea	16	Glaze	9
Renna	12	Hemingway	12
Ritzi	9	Hemp Canvas	11
Simply Chenille	10	Highland	10
Stitch In Time	12	Hitch	8
Suits	14	Hues	8
Technohound	10	Hula Hoop	11
Top Coats	11	Huxley	12
Undercover	10	Interlace	8
Varick	7	Jigsaw	10
Velvet Gloves	11	Kaleidoscope	9
Zoots	14	Mammoth Deception	16
		Metal Mesh	18
		Minotaurus	15
		Mock Croc	10
		Nightingale	11
		Not-A-Hide	9
		Out and About	14
		Parley	7
		Persuasion	7
		Phoenix	7
		Plastic Basket	9
		Ripple in Time	11
		Roseus Regatta	19
		Shagreen	9
		Shiki Silk	8
		Shiny Hide	16
		Silicone Grid	16
		Silicone Mountain	16
		Silicone Prime	16
		Silicone Slopes	16
		Silvertex	8
		Simply Hyde	11
		Sistine	10
		Sky Writing	11
		Sleek	11
		Space Cow	11
		Splash	10
		Spree	15
		Sticks and Strings	10
		Stripes	15
		Tartan	15
		Taurus	15
		Tolstoy	12
		Travel Roadies	8
		Tumbleweed	12
		Twinkle Sky	11
		Twinkle Tapestry	12
		Udderly Perfected	14
		Ultra Air	15
		Vintage Glaze	11
		Westerly	12
		Western Willie	11
		Wishes	8
		Wow	8
		Zyon	10

PLEASE NOTE: Only fabrics included in the graded-in list are approved for usage on HPFi products from that manufacturer. Patterns in bold are available in the **now** program.

Graded-In: CF Stinson

Updated 09/01/22

All HPFI seating products are available in C.F. Stinson fabrics. Patterns have been graded in to simplify quoting/ordering as well as save time versus Customer's Own Material processes. Contact Customer Service with HPFI models, quantities and selected C.F. Stinson patterns. Patterns not listed must be priced per project. Visit www.HPFI.com or www.cfstinson.com for the most up to date list as materials may vary throughout the year.

Performance Fabric

Pattern	Grade	Pattern	Grade	Pattern	Grade	Pattern	Grade
Ace	6	Converge	13	Harrison - MB	9	Maze	13
Acrobat	13	Current	14	Haven	10	Menagerie	14
Adagio	9	Cush	6	Helix	13	Migration	15
Aero	7	Cyma	12	Hexie	14	Moby	4
Alfresco	11	Dart	6	Hi-Fi	6	Mod	12
Alignment	12	Deflection	11	Highlands	7	Modernist	15
Anagram	10	Detail	8	Highlight	6	Monhegan	11
Armature	13	Deza	15	Hive	6	Montage	9
Artisan	7	Divvy	15	Honeycomb Shag	6	Multiply	16
Basket Too!	13	Donegal	9	Hush	12	Myth	13
Bass Line	11	Drift	10	I Spy	12	Nest	12
Batik	12	Drizzle	14	Infinity Plush	14	Network	8
Baxter	9	Duet	10	Inked	13	New Hempstead	6
Bespoke	8	Eddy	15	Inside Track	6	Nimble	10
Blip	4	Elderberry	13	Ishi	14	Nova	8
Bliss	14	Equator	12	Jala	17	Nubbly	11
Bloom	17	Equinox	10	Jambi Stripe Too!	11	Obscura	8
Boomerang	13	Euclid	6	Jillian	5	Offset	12
Borderline	12	Fast Lane	6	Kalahari	11	Olivia	5
Breton	12	Feature	16	Kennebunk	12	Outlander	7
Brilliant	6	Fenestra Too	13	Kinetic	10	Pacifica	14
Brixton	14	Fidget	8	Kingsman	8	Paloma	7
Broadband	12	Figment	12	Knot	10	Paradox	12
Brushwork	12	Finley	9	Lateral	5	Park Avenue	12
Bryant Park	6	Fleck	6	Lexie	13	Penelope	9
Calibration	12	Flex	5	Lifecycle	15	Pergola	9
Cannon Beach	15	Fractal	12	Lift	14	Perimeter	8
Catalina	12	Full Turn	13	Lorelai - MB	10	Picadilly	10
Ceremony	12	Furrows	6	Lucent	17	Pinball	10
Charlotte	5	Gesture	15	Luster	10	Polka	6
Cinema	12	Graph	7	Mandala	10	Posey	9
Colorblock	13	Gravity	9	Mantra	14	Posh	9
Comeback	14	Handwork	11	Marquetry	12	Power Grid	10
Continuum	8	Happy Tappy	14	Maxwell	6	Prodigy	15

PLEASE NOTE: Only fabrics included in the graded-in list are approved for usage on HPFI products from that manufacturer. Patterns in bold are available in the **now** program.

Performance Fabric (cont.)

Pattern	Grade	Pattern	Grade
Profile	6	Swivel	13
Progression	10	Sync	14
Queue	11	System	8
Radiance	17	Tangram	9
Raquette	11	Thrive	14
Realm	10	Tidbit	11
Retrograde	5	Torus	11
Revolution	9	Touch Base	6
Rhythm	16	Tranquility	12
Riddle	6	Transcend	5
Ritz	10	Traverse	15
Roadmap	6	Tribeca	6
Rubric	12	Trio	13
Salinas	16	Tuft	12
San Simeon	15	Twiggy	9
Sarto	9	Vanish	14
Scintillate	13	Vapor	13
Season	14	Voltage	14
Semaphore	8	Whirl	12
Sensor	12	Wish	18
Sequence	6	Zanzibar	15
Serene	15	Zoom	10
Shift	6		
Shimmy	9		
Shuffle	16		
Sideline	8		
Sleeping Bear Dunes	11		
Splice	14		
Sprint	5		
Square One	6		
Squire	10		
Stellar	7		
Steppe	12		
Storyboard	15		
Stratford	19		
Stuff	19		
Summit	10		
Sunburst	12		
Supersillyness	15		
Swipe	12		
Switchboard	8		

PLEASE NOTE: Only fabrics included in the graded-in list are approved for usage on HPFi products from that manufacturer. Patterns in bold are available in the **now** program.

Coated Fabrics

Pattern	Grade	Pattern	Grade	Pattern	Grade	Pattern	Grade
Affinity	12	Fizz	7	Orbit	6	Stitch in Time	6
Alamo	4	Flanders	5	Orvilla	13	Strand	6
Amplify	4	Frequency	8	Overlay	9	Stride	6
Arbor	8	Fuse	5	Oxford	6	Sundance w/ StaKleen™	10
Ardent	5	Galileo	11	Patriot Plus II	5	Symphony Classic	6
Arioso	11	GeoMet	9	Perspective	12	Tender	18
Avant	6	Glisten	18	Petal Dots	13	Tendril	5
Bandwidth	13	Grand Sierra	5	Ping Pong	13	Tessuto	6
Banyan	11	Grille	6	Plexus	11	Threads	13
Bari	12	Hashtag	10	Pod	10	Touchstone	6
Bistro	5	Hopsack	6	Polygon	13	Twist	14
Bond	12	Impress w/ StaKleen™	11	Prisma	11	Valise	5
Box Chain	4	Juxy	12	Promenade	10	Vector	7
Bubblerake	14	Kid	10	Raffia	9	Verge	14
Budget Black	2	Kilkenny Tweed	6	Rally	4	Volterra - HC	18
Burkshire	6	Kusari	6	Raya	14	Vortexia	14
Carlisle	5	La Scalina	13	Revolve	14	Walk the Line	13
Casablanca	13	Lara	4	Rialto	6	Waterwand	14
Cassidy	6	Laredo	4	Ripple	14	Weft	5
Channel	7	Latitude	5	Rivera	11	Whisper	5
Chaos	16	Lattice	5	Rogue II	5	Wicker	12
Chroma	10	Lava	14	Round Trip	13	Winnly	9
Cirque	10	Level	7	Route	5	Wyatt	8
Citadel	4	Livewire	12	Satchel	6	Ybor	11
Clean Slate	6	Loophole	9	Scoprena	14	Ziggy	5
Colorguard	4	Lunaria	13	Scout	6		
Connect	5	Martini	12	Script	7		
Core	4	Matrix	10	Sedona	18		
Corium	11	Median	12	Sentry - HC	6		
Criss Cross	6	Mesa	18	Shantung	5		
Dakota	7	Meteor	10	Silicone - Avail	14		
Didi	10	Mica	6	Silicone - Downtown	15		
Effervescence	13	Moccasin	5	Silicone - Max - One	16		
Eli	12	Modena	11	Silicone - Uptown	15		
English Pub	6	Montana	5	Sirocco	13		
Entrada	7	Natural World	13	Sleek	7		
Essential	4	Naugaleather	6	Smoothie	6		
Etch	8	Naugasoft	5	Solitaire	5		
Excursion	5	Nishiki	5	Spirit Millennium	6		
Expressions	6	Odeon	14	Staple	3		
Fiberdrill	10	Olympus	12	Stat-Con	11		

PLEASE NOTE: Only fabrics included in the graded-in list are approved for usage on HPFi products from that manufacturer. Patterns in bold are available in the **now** program.

Graded-In: Douglass Fabrics

All HPFi seating products are available in Douglass Industries' upholsteries. Patterns have been graded in to simplify quoting/ordering as well as to save time versus Customer's Own Material processes. Contact Customer Service with HPFi models, quantities and selected Douglass Industries' patterns. Patterns not listed must be priced per project. Visit www.HPFI.com or www.dougind.com for the most up to date list as materials may vary throughout the year.

Woven Fabric

Pattern	Grade	Pattern	Grade	Pattern	Grade	Pattern	Grade
Abacus	5	Chronicle	5	Fiesta	8	Monolith	7
Abode	5	Cohansey	4	Fissure	7	Mural	5
Adams	3	Columbia	4	Flagstaff	5	Namaste	8
Alfresco	5	Como	6	Florida Straits	5	Newton	7
Amazement	3	Cornell	4	Flounce	7	Nia	7
Amherst	4	Courage	3	Forage	6	Novel	3
Applique	5	Craftsman	9	Funfair	8	Nuru	7
Arbor	5	Craze	5	Fuse	7	OM	8
Archetype	3	Dartmouth	4	Gamut	7	Origami	8
Arrondi	6	Dayo	7	Gauge	3	Paddle	6
Asana	8	Deck House	9	Geode	7	Palmyra	6
Axl	6	Del Mar	3	Gizmo	6	Parade	8
Bainbridge	7	Desert	7	Glacial	7	Parasail	3
Balance	3	Drama	3	Glee	3	Parkside	6
Banter	8	Droplet	5	Glide	3	Passion	3
Berkeley	4	Duke	4	Greenhouse	9	Pavilion	5
Berman	6	Duma	7	Guild	5	Pembroke	6
Bimini	5	Duplex	6	Hartwell	5	Penobscot	6
Boat House	9	Echelon	4	Harvard	4	Pentel	7
Botswana	7	Echo	4	Haven	5	Persia	8
Bowie	6	Electron	4	Henry	3	Petroglyph	7
Breezeway	5	Elite	4	Hewitt	3	Pinnacle	7
Bungalow	8	Embassy	4	Hijinks	8	Pomona	6
Cabo	5	Embellish	4	Icon	3	Ponder	5
Caboodle	6	Emcee	4	Iggy	6	Ponset	6
Calm	7	Energize	3	Incense	8	Portland	6
Canson	6	Entice	4	Lanai	5	Precedent	3
Cape Cod	9	Envy	3	Lavish	5	Primary	3
Carriage House	9	Escort	3	Market	5	Prudential	6
Calvalcade	8	Essence	6	Mercer	6	Psyche	6
Cavort	8	Exemplar	3	Merry	8	Purdue	4
Centrum	5	Fable	6	Mesa	7	Rappel	3
Chateaux	9	Fascination	3	Metamorphic	7	Reflection	8
Chatter	6	Fete	8	Mezzanine	5	Relax	8

PLEASE NOTE: Only fabrics included in the graded-in list are approved for usage on HPFi products from that manufacturer. Patterns in bold are available in the **now** program.

Douglass Fabrics

Woven Fabric (cont.)

Pattern	Grade	Pattern	Grade
Revere	3	Tatami	8
Riddle	6	Tembo	7
Rima	6	Temple	4
Rio	8	Token	5
Ritzzy	7	Touchstone	3
Romp	8	Tranquil	8
Scoop	7	Tree House	9
Scree	7	Tributary	7
Serene	8	Trifle	5
Sherpa	3	Trinket	7
Shire	3	Unwind	8
Shoji	8	Usher	3
Shuffle	7	Utley	5
Simba	7	Vanguard	6
Slalom	7	Veranda	5
Soffit	7	Video	3
Solenoid	7	Volute	7
Sophie	7	Wayfare	5
Soul	7	Wellesley	4
Spartan	3	Wink	5
Spencer	7	Yale	4
Sprite	8	Yara	6
Squire	3	Yoga	8
Stacatto	3	Zanzibar	5
Straightaway	7	Zappa	6
Strathmore	7	Zip Line	3
Sunshade	5		
Swahili	7		
Swarthmore	4		
Swizzle	7		
Taboret	7		
Tadala	7		
Tailor Made	5		
Tangle	6		

PLEASE NOTE: Only fabrics included in the graded-in list are approved for usage on HPFi products from that manufacturer. Patterns in bold are available in the **now** program.

Coated Fabric

Pattern	Grade	Pattern	Grade	Pattern	Grade	Pattern	Grade
A Capalla	6	Ezy Sierra	1	Persuasion	4	Zodiac	7
All-American	4	Ezy Wallaby	1	Phoenix	4		
Allante	4	Flair	6	Promessa	16		
Allante Free	4	Foundation	4	Reflex NEO	6		
Andante	6	Gavotte	6	Repertoire	6		
Arc	6	Glissando	6	Rialto	6		
Aristo	6	Grand Sierra	5	Rogue II	4		
Arturo	6	Grand Sierra NFR	5	Salinger	8		
Benjamin	5	Hawthorne	8	San Remo	6		
Berwick Tweed	5	Hemingway	8	Seduction	call		
Brisa	15	Heritage	4	Shagreen	6		
Brisa Distressed	15	Hitch NEO	6	Silvertex NEO	5		
Canyon	4	Huxley	8	Spirit Millennium	5		
Casablanca	6	Hyde	4	Spotlight	7		
Chainmaille	6	Impression	5	Steps	6		
Chaise	8	Independence II	3	Stratosphere NEO	5		
Chambray NEO	6	Interlace NEO	6	Surrey	5		
Chamea II	4	Invision NEO	6	Symphony Classic	5		
Clarke	8	Kaleidoscope NEO	6	Symphony Glaze	5		
Clutch	6	Kilkenny Tweed NEO	6	Symphony Vintage	5		
Colorguard	4	Kimono	6	Tolstoy	8		
Colorguard NFR	4	Maestoso	6	Traveler	6		
Connect	4	Maglia	6	Trex NEO	4		
Crafted Grids	7	Marble NEO	5	Twist	6		
Dimension	6	Modena	3	Ultraleather	15		
Dolce	8	Muse	5	Vermillion	5		
Edgeline	6	Natural Linen	3	Vibe	4		
English Pub	5	Nauga Soft	5	Vibrato	6		
Ezy Corinthian	1	Naugaleather	5	Vitality	6		
Ezy Elk	1	Neochrome III	5	Vivace	6		
Ezy Heidi	1	Notion	5	Whisper NEO	4		
Ezy Madrid	1	Palm Harbor	5	Wilde	7		
Ezy Monticello	1	Patriot Plus NEO	4	Wish	5		
Ezy Oxen	1	Pearlized	15	Woven Hues	6		

PLEASE NOTE: Only fabrics included in the graded-in list are approved for usage on HPFi products from that manufacturer. Patterns in bold are available in the **now** program.

Graded-In: Mayer Fabrics

Updated 09/01/22

All HPFi seating products are available in Mayer Fabrics' upholsteries. Patterns have been graded in to simplify quoting/ordering as well as to save time versus Customer's Own Material processes. Contact Customer Service with HPFi models, quantities and selected Mayer Fabrics' patterns. Patterns not listed must be priced per project. Visit www.HPfi.com or www.mayerfabrics.com for the most up to date list as materials may vary throughout the year.

Textiles

Pattern	Grade	Pattern	Grade	Pattern	Grade	Pattern	Grade
Abbey	8	Ephesus	10	Lotus	13	Shantung	6
Acclaim	7	FanFare	12	Malibu	7	Signs	14
Acuco	13	Fedora	2	Mandala	15	Social Network	4
Align	5	Fiji	4	Marathon II	3	Soho	8
Ankara	9	Finale	7	Marmara	8	Soleil	12
Arabesque	4	Form	9	Mayfair	9	Sophisticate	6
Aristocrat	4	Forte	3	Meander	5	Spacer Mesh	5
Ascension	9	Foundation 10	2	Metal Strips	12	Spokes	12
Avenue	9	Fretwork	12	Milagro	13	Static	11
Bali	5	Function	5	Moonscape	5	Sula	14
Batik	5	Gatsby	5	Mosaic	4	Suna	13
Boro	11	Gem	5	Mosaic + NanoGuard	6	Sutra	11
Botany	10	Genesis	4	Nirvana	12	Sydney	3
Boteh	15	Genesis + NanoGuard	6	Nostalgia	6	Tango	3
Centric	9	Gravity	10	Nylon-Stat ESD	11	Tattersall	7
Channel	5	Haarlem	13	Odessa	8	Textura	13
Circumference	12	Havana	4	Optic 10	5	Theory 10	5
Collage	13	Haven	6	Patio	5	Time Line	4
Comalapa	13	Hexagon	7	Plaza	8	Turnabout	8
Continuum	5	Huipil	11	Polygon	6	Variant 10	5
Cosmopolitan	7	Infinity	11	Positive Thoughts	10	Venetian	20
Crazy Quilt	12	Intrigue	6	Prism 10	5	Vibrant	6
Cross Check	1	Jitterbug	4	Puno	12	Viewpoint	11
Cuddle Up	9	Jive	4	Quattro	1	Villa	9
Darning	12	Journey	4	Reflector	12	Vintage Mohair	call
Debonair	9	Kantha	12	Refuge	9	Vogue	7
Destiny	4	Kensington	7	Relativity	11	Volante	20
Destiny + NanoGuard	6	Labyrinth	13	Reverb	5	Whirligig	13
Disco	4	Landscape	9	Rumba	3	Wilson	12
Duraweave 10	3	Latitude	8	Samba	4	Wool Boucle	14
Echo	7	Lavish	8	Saori	12	Xanadu	12
Editor	8	Legacy	6	Scout	6	Zazen	11
Elevation	8	London	8	Sequel	4		
Engrave	3	Longitude	7	Sequel + NanoGuard	6		

PLEASE NOTE: Only fabrics included in the graded-in list are approved for usage on HPFi products from that manufacturer. Patterns in bold are available in the **now** program.

Coated Fabrics

Pattern	Grade	Pattern	Grade
All Seasons FR	5	Mode	7
Antique	6	Molecule	12
Apollo Silicone	12	Neo	8
Arcade	10	Niche	9
Balance	7	Noble	5
Bolero	8	Nomad	8
Caressa FR	6	Outback	5
Carousel	13	Oxen SP Black	2
Catwalk	7	Palermo	8
Chaps FR	6	Ranchero	3
Chequers	9	Score	8
Cirque	5	Sierra SP Black	2
Contempo	6	Silverweave	4
Curlicue	6	Sketch	6
Dande	6	Slick	7
Durango	5	Splendor	9
Essence	7	Vector	12
Etch	5	Verona	Call
Florentino	Call	Vinyl Stat ESD	8
Gala	4	Voyager	8
Galveston	7	Wallaby SP Black	2
Icon	7	Zen	10
Imprint	5	Zip	5
Interlace	6		
Jekyll & Hyde	6		
Key Largo	5		
Links	7		
Longhorn	8		
Madrid SP Black	2		
Matka	7		
Matter	9		
Maverick	5		
Microdot	6		
Midway	6		
Milano	7		
Mingle	7		

PLEASE NOTE: Only fabrics included in the graded-in list are approved for usage on HPFi products from that manufacturer. Patterns in bold are available in the **now** program.

Graded-In: Momentum

Updated 09/01/22

All HPFI seating products are available in Momentum upholsteries. Patterns have been graded in to simplify quoting/ordering as well as save time versus Customer's Own Material processes. Contact Customer Service with HPFI models, quantities and selected Momentum patterns. Patterns not listed must be priced per project. Visit www.hpfi.com or www.memosamples.com for the most up to date list as materials may vary throughout the year.

Fabric

Pattern	Grade	Pattern	Grade	Pattern	Grade	Pattern	Grade
3D Grid	17	Current	7	Insight	5	Parenthesis	5
Ace	6	Cutout	18	Interim	14	Pax	13
Aldo	18	Dart	6	Interlock	17	Perk	5
Amenity II	13	Dash	13	Intermix II	9	Photon	14
Amuse	9	Dayspell	13	Iota	12	Phrase	13
April	10	Decode	7	Jitney	12	Pierre	18
Audubon	15	Drawing Lines	15	Jot	6	Ping	8
Bandwidth II	13	Drift	13	Journal	14	Pip	8
Bangle	5	Ebb	15	Kinney	9	Pique	7
Banter	15	Edison	14	Knack	7	Places Spaces Faces	17
Beep	7	Embark	11	Lateral	10	Plan	9
Beta	8	Epic	6	Ledge	9	Platform	12
Bloko	16	Essay	14	Lella	15	Point	7
Bobby	3	Explore	14	Lens	7	Polka	14
Boom II	9	Expo	1	Level	12	Pop UP	20
Borders	13	Fleet	11	Lina	16	Propel	13
Brink	12	Float	7	Lineup	7	Propensity II	7
Brisk	14	Flow	13	Lloyd	17	Proximity	15
Build	9	Flux	15	Lore	14	Pursue	13
Buoy	13	Focal	7	Lucio	20	Quince	15
Cairns	16	Fold	16	Ludwig	17	Raft	13
Camber	15	Foundation	12	Mandala	12	Revolve	16
Carlo	17	Free	7	Mapping Ideas	16	Riga	15
Centric	13	Fuse	2	Marcel	16	Ring	12
Chipper	15	Geo	16	Memory	16	Rise	7
Chromatic	12	Glide	10	Mezzanine	12	Rivet	7
Cityscape	16	Graph	3	Mikro	12	Rombu	14
Civil	12	Grid	3	Mixology	8	Ronda	14
Clang	7	Guideline	13	Nagoya	15	Rubato	13
Climb	14	Guild	6	Nimble	15	Rush Hour	14
Collect	9	Habit	7	Origin	2	Sail	14
Colorwheel	12	Hearsay	14	Otto	7	Scrabble	7
Croquet	14	Highline	13	Painting Strokes	16	Site Line	15
Crossing Colors	17	Hitch	10	Panorama	15	Sketching Air	16
Cube	12	Hop	12	Pantheon	14	Skip	7
Culture	10	Hue	5	Parable	13	Slice	6

PLEASE NOTE: Only fabrics included in the graded-in list are approved for usage on HPFI products from that manufacturer. Patterns in bold are available in the **now** program.

Fabric (cont.)

Pattern	Grade
Small Talk	14
Smart Soft	6
Solace	9
Spontaneous	15
Starboard	13
Story	14
Stroll	7
Strum	12
Strut	8
Subdivide	13
Sunny	11
Swim	6
Syntax	6
Tack	7
Tactic	15
Tech Weave	Call
Tesla	13
Tilt	12
Toggle	6
Traction	15
Trapeze	14
Trivia	14
Tufted	15
Turin	15
Uplift	12
Via	7
Vox	5
Wander	13
Weaving Palettes	14
Well Well Well	18
Whim	13
Why Why Why	17
Widget	4

Crypton

Pattern	Grade
Acrobat	10
Almanac	15
Analog	14
Ascend	10
Byways	14
Central	10
Channel	10
Cover Cloth	5
Crosswise	9
Docket	15
Domain	11
Etude	15
Evolve	14
Faux Felt	6
Faux MO	10
Flock	9
Hobnob	9
Infinity C-Zero	3
Infusion	12
Kayak	15
Keynote	8
Kit	9
Marathon C-Zero	5
Millennium C-Zero	5
Oath	10
Odyssey C-Zero	3
Overpass	11
Phase	15
Reverb	15
Roster	15
Score	10
Shuttle	10
Solitaire	9
Sport	8
Synergy	10
Tag	13
Tradition C-Zero	5
Trefoil	11
Trilogy	10
Viva II	11
Waver	10

Coated Fabric

Pattern	Grade	Pattern	Grade
Acoustic	13	Silica Cusp	11
Agora II	8	Silica Deflect	13
Anthology CV	9	Silica Effloresce	13
Archer	13	Silica Etc.	11
Cashmere II	8	Silica Etch	9
Cycle	10	Silica Excursion	13
Dexter EPU	6	Silica Fiona	13
Dome CV	7	Silica Flick	13
Endurance EPU	5	Silica Fresco	13
Evo CV	5	Silica Fritz	13
Follow CV	10	Silica Gidget	13
Foray	10	Silica Hiatus	13
Frida CV	10	Silica Hoop	13
Groove EPU	8	Silica Jig	13
Halo	13	Silica Kip	11
Hyde CV	7	Silica Leather	9
Improv CV	7	Silica Likely	13
Kindred	12	Silica Motive	13
Lasso CV	10	Silica Reach	13
Leno	14	Silica Roam	13
Linen CV	8	Silica Scout	13
Mixology CV	7	Silica Spoke	13
Mogul EPU	6	Silica Strata	11
Nifty	8	Silica Stride	11
Poetic CV	7	Silica Suede	11
Printwork EPU	8	Silica Tao	13
Rein II	8	Silica Tech	9
Row	6	Silica Thatch	13
Sanya CV	8	Silica Today Here Now	13
Sensory CV	7	Silica Triad	11
Sidestep	13	Silica Waltz	11
Silica	9	Silica Wifi	13
Silica Andy	13	Speakeasy CV	8
Silica Arc	13	Spunk CV	9
Silica Bauble	13	Tanner	6
Silica Blend	11	Tribeca CV	6
Silica Bracket	13	Vanguard CV	6
Silica Bubbler	13	Velocity	9
Silica Checker	11	Whit EPU	6
Silica Chopsticks	13	Zipped	14
Silica Compass	13		

PLEASE NOTE: Only fabrics included in the graded-in list are approved for usage on HPFi products from that manufacturer. Patterns in bold are available in the **now** program.

Technical Specifications: Seating

Ergonomic Features and Applications

Ergonomics, also referred to as Biotechnology of Human Engineering, is an applied science concerned with the characteristics of people that need to be considered in designing and arranging things that they use in order that people and things will interact more effectively, comfortably, and safely.

With respect to the office worker, ergonomics is applied to accommodate specific work postures that reduce or eliminate static loading of muscles, particularly in the neck, shoulder and lower back regions. These are the primary areas where musculo-skeletal illnesses occur, causing discomfort and pain.

- Front of seat is a “waterfall” shape which avoids restriction of circulation of blood in thighs and lower legs.
- Back support is designed with a compound curve to support lumbar vertebrae and help back hold a slightly forward arch. Fixed Lumbar Support has been incorporated into various chairs. Permanent fixed support allows proper passive ergonomic alignment of the skeletal frame.
- The seat cushion has only light, but relatively firm padding so the posterior can change pressure areas easily. Most seats are constructed with matrix support, as opposed to a platform (solid) seat pan. This increases comfort and works to reduce or eliminate pressure areas.
- Seat heights are adjustable to accommodate a wider range of user heights.
- Seat controls are designed to be able to adjust both the back and the seat for varying positions and tasks.
- For safety, chair bases have 5 prongs. This also makes lateral movement easier.
- As well as having all of the above features and benefits required to satisfy tasks that need to be performed. HPFi seating blends into the most discriminating office environment. Actuating paddles and knobs are positioned within easy reach from the seated position and placed to avoid injury or inadvertent operation.

Bases

WOOD BASE:

A five prong steel understructure is continuously welded to a steel center hub for strength and durability. The center hub is equipped with a nylon hub liner to provide smooth and quiet swivel operation. Hardwood caps are secured to the steel understructure. The base is furnished with a black metal sleeve and features black polyimide, non-abrasive, non-marking dual wheel casters. These bases meet or exceed all BIFMA requirements.

LOW-PROFILE BASE:

Optional Leaders base features 5-prong die-cast aluminum under structure. Flat hardwood caps are finished and affixed to the aluminum under structure. This option meets or exceeds all BIFMA requirements.

BLACK NYLON BASE:

Black five prong base of reinforced nylon resin. The base features integrated two inch hooded dual wheel casters. These bases meet or exceed all BIFMA requirements.

NOTE: The black nylon five prong base can be substituted for a five prong wood base at no up-charge.

IMPORTANT: When ordering a replacement base or casters, please list the seating model number and the date of purchase (if known), found on the manufacturer label under the seat.

Packing

Prices shown in this Price Book include packaging. All items are packed one to a carton except where indicated. All packaging meets or exceeds the specifications outlined in the Uniform Freight Classification.

HPFi reserves the right to change or modify any of our products, pricing or packaging without advance notice.

Seating Controls

All Swivel Seating includes 360° Swivel and Pneumatic Seat Height Adjustment.

Swivel Tilt Mechanism

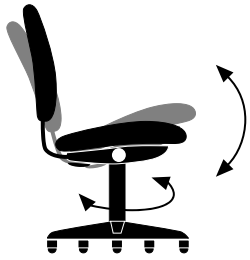

- Seat and back tilt as one unit
- Tilt pivot point is at top of cylinder/column
- Adjustable tilt tension

STANDARD ON:
All

Synchro Tilt Mechanism

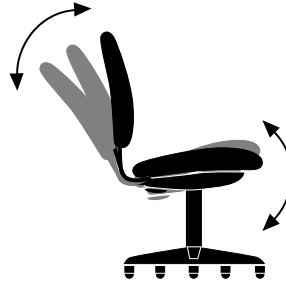

- Back tilt/reclines at 2:1 ratio to seat angle
- Tilt pivot point is at top of cylinder/column
- Adjustable tilt tension

STANDARD ON:
461, 752

Knee Tilt Mechanism

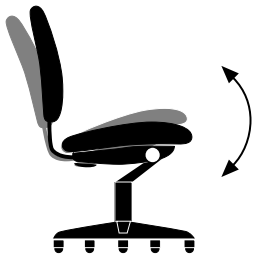

- Feet remain on floor when reclining
- Seat and back tilt as one unit
- Tilt pivot point is toward seat front
- Adjustable tilt tension and tilt lock

OPTIONAL ON:
Quick Silver, Scoop, Traditional

Seat Slider

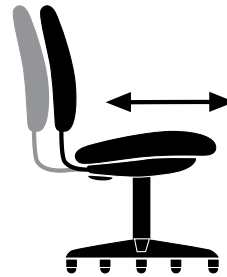

- Adjust front to back to allow for optimum comfort for varying heights of occupants
- Lift lever to engage slider mechanism

STANDARD ON:
461

Adjustable Width Arms

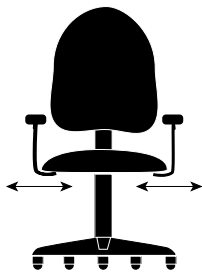

- Adjust side to side for individual comfort
- Loosen knobs under seat to adjust

STANDARD ON:
461

Adjustable Height Arms

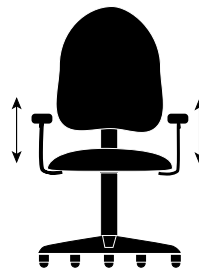

- Adjust up and down for individual comfort

STANDARD ON:
461, 752

Jury Base

A 9.25" base with a 90° swivel (45° to each side) with automatic return to the front, forward position is available on several of our management swivel chairs. Option code JB is listed for chairs which this option is available.

Caster Kit

To convert a chair (already in use) from carpet casters to hard floor casters, order a Hard Floor Caster Kit.

Caster Options

HPFi swivel seating features standard dual-wheel carpet casters appropriate for most business environments.

PowerFlex

POWER OPTIONS - SIN 33721

	Zone 1	Zone 2	Zone 3								
C_	589	610	630								
Cove Flush Mount Charging											
											
<ul style="list-style-type: none"> • Two (2) 110-volt power outlets and two (2) active USB charging ports • Spill-resistant receptacles • 108" cord • 90° flat plug on 45° rotation • UL and CSA listed 											
<table border="1"> <thead> <tr> <th>Shp. Wt.</th> <th>Overall</th> </tr> </thead> <tbody> <tr> <td>2.3</td> <td>5.75" W x 2.5" D x 3.25" H</td> </tr> </tbody> </table>				Shp. Wt.	Overall	2.3	5.75" W x 2.5" D x 3.25" H				
Shp. Wt.	Overall										
2.3	5.75" W x 2.5" D x 3.25" H										
<table border="1"> <thead> <tr> <th>Available Colors</th> <th>Code</th> </tr> </thead> <tbody> <tr> <td>Black</td> <td>CB</td> </tr> <tr> <td>Silver</td> <td>CS</td> </tr> <tr> <td>White</td> <td>CW</td> </tr> </tbody> </table>				Available Colors	Code	Black	CB	Silver	CS	White	CW
Available Colors	Code										
Black	CB										
Silver	CS										
White	CW										
<table border="1"> <thead> <tr> <th>Recommended For</th> </tr> </thead> <tbody> <tr> <td>Desks, Tables and Lounge Seating in which installation is an option.</td> </tr> </tbody> </table>				Recommended For	Desks, Tables and Lounge Seating in which installation is an option.						
Recommended For											
Desks, Tables and Lounge Seating in which installation is an option.											

• Must be factory installed in table/ desk tops, side surfaces or in select lounge seating. Contact HPFI Customer Service for details.

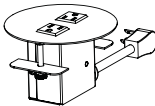
	Zone 1	Zone 2	Zone 3								
CRP_	392	406	419								
Cove Round, Power Only											
											
<ul style="list-style-type: none"> • Two (2) 110-volt power outlets • Spill resistant receptacles • 110 volt power outlets • 108" cord • 90° flat plug on 45° rotation • UL and CSA listed 											
<table border="1"> <thead> <tr> <th>Shp. Wt.</th> <th>Overall</th> </tr> </thead> <tbody> <tr> <td>3</td> <td>6" W x 6" D x 3.25" H</td> </tr> </tbody> </table>				Shp. Wt.	Overall	3	6" W x 6" D x 3.25" H				
Shp. Wt.	Overall										
3	6" W x 6" D x 3.25" H										
<table border="1"> <thead> <tr> <th>Available Colors</th> <th>Code</th> </tr> </thead> <tbody> <tr> <td>Black</td> <td>CRPB</td> </tr> <tr> <td>Silver</td> <td>CRPS</td> </tr> <tr> <td>White</td> <td>CRPW</td> </tr> </tbody> </table>				Available Colors	Code	Black	CRPB	Silver	CRPS	White	CRPW
Available Colors	Code										
Black	CRPB										
Silver	CRPS										
White	CRPW										
<table border="1"> <thead> <tr> <th>Recommended For</th> </tr> </thead> <tbody> <tr> <td>Round Tables with perimeter legs (not center column or X-base)</td> </tr> </tbody> </table>				Recommended For	Round Tables with perimeter legs (not center column or X-base)						
Recommended For											
Round Tables with perimeter legs (not center column or X-base)											

• Must be factory installed in table/ desk tops, side surfaces or in select lounge seating. Contact HPFI Customer Service for details.

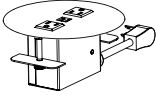
	Zone 1	Zone 2	Zone 3								
CR2_	589	610	630								
Cove Round, 2 Power, 2 USB											
											
<ul style="list-style-type: none"> • Two (2) 110-volt power outlets • Two (2) 2.1 amp active USB charging ports • Spill-resistant receptacles • 108" cord • 90° flat plug on 45° rotation • UL and CSA listed 											
<table border="1"> <thead> <tr> <th>Shp. Wt.</th> <th>Overall</th> </tr> </thead> <tbody> <tr> <td>3</td> <td>6" W x 6" D x 3.25" H</td> </tr> </tbody> </table>				Shp. Wt.	Overall	3	6" W x 6" D x 3.25" H				
Shp. Wt.	Overall										
3	6" W x 6" D x 3.25" H										
<table border="1"> <thead> <tr> <th>Available Colors</th> <th>Code</th> </tr> </thead> <tbody> <tr> <td>Black</td> <td>CR2B</td> </tr> <tr> <td>Silver</td> <td>CR2S</td> </tr> <tr> <td>White</td> <td>CR2W</td> </tr> </tbody> </table>				Available Colors	Code	Black	CR2B	Silver	CR2S	White	CR2W
Available Colors	Code										
Black	CR2B										
Silver	CR2S										
White	CR2W										
<table border="1"> <thead> <tr> <th>Recommended For</th> </tr> </thead> <tbody> <tr> <td>Round Tables</td> </tr> <tr> <td>Ottoman Tables</td> </tr> </tbody> </table>				Recommended For	Round Tables	Ottoman Tables					
Recommended For											
Round Tables											
Ottoman Tables											

• Must be factory installed in table/ desk tops, side surfaces or in select lounge seating. Contact HPFI Customer Service for details.

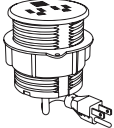
	Zone 1	Zone 2	Zone 3																		
SD_	288	298	308																		
Sand Dollar, 2 Power, 2 USB																					
																					
<ul style="list-style-type: none"> • Two (1) 110-volt power outlet • Two (2) 2.1 amp active USB charging ports • 15 amp total receptacles • 108" cord with straight plug • UL and CSA listed • Must be factory installed. Contact HPFI Customer Service for details. 																					
<table border="1"> <thead> <tr> <th>Shp. Wt.</th> <th>Overall</th> </tr> </thead> <tbody> <tr> <td>2</td> <td>3" W x 3" D x 3.4" H</td> </tr> </tbody> </table>				Shp. Wt.	Overall	2	3" W x 3" D x 3.4" H														
Shp. Wt.	Overall																				
2	3" W x 3" D x 3.4" H																				
<table border="1"> <thead> <tr> <th>Available Colors</th> <th>Code</th> </tr> </thead> <tbody> <tr> <td>Black</td> <td>SDK</td> </tr> <tr> <td>Gray</td> <td>SDG</td> </tr> <tr> <td>Light Blue</td> <td>SDB</td> </tr> <tr> <td>Light Green</td> <td>SDN</td> </tr> <tr> <td>Orange</td> <td>SDO</td> </tr> <tr> <td>Red</td> <td>SDR</td> </tr> <tr> <td>White</td> <td>SDW</td> </tr> <tr> <td>Yellow</td> <td>SDY</td> </tr> </tbody> </table>				Available Colors	Code	Black	SDK	Gray	SDG	Light Blue	SDB	Light Green	SDN	Orange	SDO	Red	SDR	White	SDW	Yellow	SDY
Available Colors	Code																				
Black	SDK																				
Gray	SDG																				
Light Blue	SDB																				
Light Green	SDN																				
Orange	SDO																				
Red	SDR																				
White	SDW																				
Yellow	SDY																				
<table border="1"> <thead> <tr> <th>Recommended For</th> </tr> </thead> <tbody> <tr> <td>Flex Wall</td> </tr> <tr> <td>Vertical surfaces of Lounge Seating</td> </tr> </tbody> </table>				Recommended For	Flex Wall	Vertical surfaces of Lounge Seating															
Recommended For																					
Flex Wall																					
Vertical surfaces of Lounge Seating																					

ECL

Tripod Portable Power Base

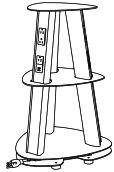

- Twelve (12) 110-volt power outlets
- Six (6) 2.1 amp active USB charging ports
- Spill-resistant receptacles
- 108" cord with straight plug
- UL and CSA listed

Zone 1	Zone 2	Zone 3
3172	3283	3394

Cu. Ft.	Shp. Wt.	Fr. Cls.
11.0	35	125

Overall
18" W x 18" D x 25.5" H

Available Colors	Code
Black	ECIB
Silver	ECIS
White	ECIW

Recommended For
Furnished areas where additional or portable power is needed

PNP

Plug 'n Play

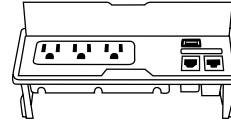

- Three (3) 110-volt power outlets
- One (1) RJ45 data pass-through
- One (1) RJ11 phone pass-through
- One (1) USB pass-through (not powered)

Zone 1	Zone 2	Zone 3
249	258	266

Shp. Wt.	Overall
3	5.7" W x 3.4" D x 2.2" H

Available Colors
Black

Recommended For
Rectangular meeting table tops
Collaborative table tops
Training table tops



Casegoods





Bedford

TRADITIONAL CASEGOODS - SIN 33721

Classic Styling, Modern Function

Bedford brings old world excellence to the contemporary office with a complete collection of office, conference and reception solutions. High pressure laminate tops feature solid hardwood edges that withstand everyday abuse from chair "bumps." Bridges and returns feature common grain direction and reversed coped edges for a matched woodgrain direction usually found only on the most expensive furnishings. Enhance any traditional environment with beautifully crafted lounge and office HPFi seating.

Tops

- 1.188" thick high gloss, high pressure laminate (HPL) surfaces
- Rounded wood/lumber-banded edges

Finishes

- High pressure laminate top
- Thermally fused laminate on all case surfaces

Edge Profile



How to Specify:

- 1 Series
- 2 Laminate finish
- 3 Model number
- 4 Options

Finishes	Code
Mahogany	M
Windsor Cherry	WC

Power
PowerFlex power modules can be installed in many locations. See page 36 for options.

Options	Code	Price
Factory Installed Center Drawer	C	Varies
Factory Installed Keyboard Shelf	K	Varies
Locks Doors	Y	95 (per pair)
Heavy Duty Lateral File Bottom	H	101 (per drawer)
Additional Grommet	G	138

Finished Example

TR/M/3030/C

Pedestals & File Cabinets

- 1" thick end panels, .75" thick modesty panel
- Pedestal is .75"-thick core with thermally fused laminate on both sides
- 1mm AdvantEdge PVC edge banding on all exposed case and drawer front edges
- Full height pedestals
- Fully assembled with dowels, glue, metal brackets, screws and mechanical fasteners
- Pre-installed filing hardware holds letter- and legal-size hanging files

- Drawer bottoms .125" thick rated to 25 lbs.
- File drawers are 5-sided, oak woodgrain vinyl wrapped, .5" thick
- 3/4 extension steel, ball-bearing slides on box and center drawers
- Full extension steel, ball-bearing slides on file drawers
- Solid metal, antique brass finish knobs and pulls standard

Wire Management

- See individual product features for standard number of 3.25" x 1.875 grommets and location(s)
- Additional grommets for extended wire management capability available

Locks

- Locks are "keyed alike" as standard
- "Keyed different" locks are available at \$25 per lock. Contact HPFi Customer Service for custom option code per order

Desks

	Model	Overall	Cu. Ft.	Shp. Wt.	Fr. Cls.	Zone 1	Zone 2	Zone 3
Bow Front Double Pedestal Desk	TR_3030B	72" W x 36" D x 29" H	51.6	333	110	3670	3798	3927
						216	224	231
						249	258	266



- NOW finish M

- Utility/Box/File Drawer in each pedestal

- Two pullout writing shelves

- Individually locking pedestals

	Model	Overall	Cu. Ft.	Shp. Wt.	Fr. Cls.	Zone 1	Zone 2	Zone 3
Bow Front Left Pedestal Desk	TR_30721LB	72" W x 36" D x 29" H	51.6	296	110	3735	3866	3996



- Locking Utility/Box/File Drawers in left pedestal

- One pullout writing shelf

- Center drawer included

- Open storage right pedestal

	Model	Overall	Cu. Ft.	Shp. Wt.	Fr. Cls.	Zone 1	Zone 2	Zone 3
Bow Front Right Pedestal Desk	TR_30721RB	72" W x 36" D x 29" H	51.6	296	110	3735	3866	3996



- Locking Utility/Box/File Drawers in right pedestal

- One pullout writing shelf

- Center drawer included

- Open storage left pedestal

	Model	Overall	Cu. Ft.	Shp. Wt.	Fr. Cls.	Zone 1	Zone 2	Zone 3
Rectangular Double Pedestal Desk	TR_3020	60" W x 30" D x 29" H	36.7	300	110	3177	3288	3399
	TR_3025	66" W x 30" D x 29" H	40.2	326	110	3399	3518	3637
	TR_3030	72" W x 36" D x 29" H	51.6	346	110	3491	3613	3735
						216	224	231
					249	258	266	



- NOW finish M

- Utility/Box/File Drawer in each pedestal

- Two pullout writing shelves

- Individually locking pedestals

Bedford

	Model	Overall	Cu. Ft.	Shp. Wt.	Fr. Cls.	Zone 1	Zone 2	Zone 3
Left Pedestal Desk	TR_3045ALH NOW	66" W x 30" D x 29" H	40.2	267	110	2902	3004	3105
	TR_3048ALH NOW	72" W x 36" D x 29" H	51.6	308	110	3515	3638	3761
	• NOW finish M	• Locking Utility/Box/File Drawers in left pedestal	• One pullout writing shelf	• Open storage right pedestal		• Center drawer included		

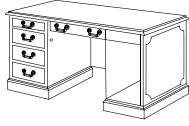

	Model	Overall	Cu. Ft.	Shp. Wt.	Fr. Cls.	Zone 1	Zone 2	Zone 3
Right Pedestal Desk	TR_3045ARH NOW	66" W x 30" D x 29" H	40.2	267	110	2902	3004	3105
	TR_3048ARH NOW	72" W x 36" D x 29" H	51.6	308	110	3515	3638	3761
	• NOW finish M	• Locking Utility/Box/File Drawers in right pedestal	• One pullout writing shelf	• Open storage left pedestal		• Center drawer included		



Credenzas

	Model	Overall	Cu. Ft.	Shp. Wt.	Fr. Cls.	Zone 1	Zone 2	Zone 3
Executive Storage Credenza	TR_3072 NOW	72" W x 24" D x 29" H	35.7	316	125	3593	3719	3845
					Optional Door Lock Y	95	95	95
	• NOW finish M	• Utility/Box/File Drawer in each pedestal	• Adjustable shelf in center storage	• Individually locking pedestals				





	Model	Overall	Cu. Ft.	Shp. Wt.	Fr. Cls.	Zone 1	Zone 2	Zone 3
Kneespace Credenza	TR_3064 NOW	66" W x 24" D x 29" H	32.8	268	110	3283	3398	3513
	TR_3074 NOW	72" W x 24" D x 29" H	35.7	302	110	3331	3448	3564
	• NOW finish M	• Locking Utility/Box/File Drawers in each pedestal	• Grommet in top, center of back panel					

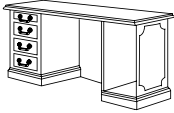

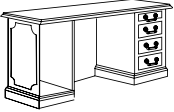
	Model	Overall	Cu. Ft.	Shp. Wt.	Fr. Cls.	Zone 1	Zone 2	Zone 3
Left Pedestal Credenza 	TR_3076L NOW	72" W x 24" D x 29" H	35.7	200	125	2613	2704	2796
	TR_3064L	66" W x 24" D x 29" H	32.8	182	125	2226	2304	2382
					Keyboard Shelf K	249	258	266
	• NOW finish M	• Two side locking file drawers in left pedestal			• Open storage with two grommets in right pedestal			• One grommet in back panel

	Model	Overall	Cu. Ft.	Shp. Wt.	Fr. Cls.	Zone 1	Zone 2	Zone 3
Right Pedestal Credenza 	TR_3076R NOW	72" W x 24" D x 29" H	35.7	200	125	2613	2704	2796
	TR_3064R	66" W x 24" D x 29" H	32.8	182	125	2226	2304	2382
					Keyboard Shelf K	249	258	266
	• NOW finish M	• Two side locking file drawers in right pedestal			• Open storage with two grommets in left pedestal			• One grommet in back panel

	Model	Overall	Cu. Ft.	Shp. Wt.	Fr. Cls.	Zone 1	Zone 2	Zone 3
Storage Credenza 	TR_3042 NOW	38" W x 24" D x 29" H	19.5	140	125	1658	1716	1774
	• NOW finish M	• One adjustable shelf			• Hinged doors			

	Model	Overall	Cu. Ft.	Shp. Wt.	Fr. Cls.	Zone 1	Zone 2	Zone 3
Left Twin Pedestal Credenza 	TR_3075L NOW	72" W x 24" D x 29" H	35.7	277	125	3075	3183	3290
	• NOW finish M	• Two Utility/Box/File Drawers in left pedestal - inside set of drawers lock			• One grommet in back panel			• Open storage in right pedestal with two grommets

	Model	Overall	Cu. Ft.	Shp. Wt.	Fr. Cls.	Zone 1	Zone 2	Zone 3
Right Twin Pedestal Credenza 	TR_3075R NOW	72" W x 24" D x 29" H	35.7	277	125	3075	3183	3290
	• NOW finish M	• Two Utility/Box/File Drawer in right pedestal - inside set of drawers lock			• One grommet in back panel			• Open storage in left pedestal with two grommets

Bedford

	Model	Overall	Cu. Ft.	Shp. Wt.	Fr. Cls.	Zone 1	Zone 2	Zone 3
Left Lateral File Credenza	TR_3033L	72" W x 24" D x 29" H	35.7	254	125	3036	3142	3249
						Heavy Duty Bottom H	202	202



- Two side locking lateral file drawers on left
- Side locking drawer pedestal
- One grommet in top of back panel
- Open storage in right pedestal with two grommets

	Model	Overall	Cu. Ft.	Shp. Wt.	Fr. Cls.	Zone 1	Zone 2	Zone 3
Right Lateral File Credenza	TR_3033R	72" W x 24" D x 29" H	35.7	254	125	3036	3142	3249
						Heavy Duty Bottom H	202	202



- Two side locking lateral file drawers on right
- Side locking drawer pedestal
- One grommet in top of back panel
- Open storage in left pedestal with two grommets

	Model	Overall	Cu. Ft.	Shp. Wt.	Fr. Cls.	Zone 1	Zone 2	Zone 3
Double Lateral File Credenza	TR_733	73.75" W x 24" D x 29" H	35.7	368	125	4124	4268	4413
						Heavy Duty Bottom H	404	404

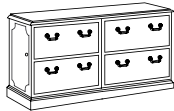

- Four lateral file drawers
- Side locking

	Model	Overall	Cu. Ft.	Shp. Wt.	Fr. Cls.	Zone 1	Zone 2	Zone 3
Double Bookcase Credenza	TR_734	72" W x 24" D x 29" H	35.7	340	125	2968	3072	3176
						Heavy Duty Bottom H	404	404



- Two bookcase compartments
- One adjustable shelf in each compartment

	Model	Overall	Cu. Ft.	Shp. Wt.	Fr. Cls.	Zone 1	Zone 2	Zone 3
Buffet Credenza	TR_734BC	72" W x 25" D x 36" H	46.0	388	125	3830	3964	4098
						Heavy Duty Bottom H	404	404

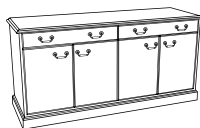

- Two utility drawers in top
- Two bookcase compartments in bottom
- One adjustable shelf in each compartment

Returns & Bridges

	Model	Overall	Cu. Ft.	Shp. Wt.	Fr. Cls.	Zone 1	Zone 2	Zone 3
Left Desk Return 	TR_3048BLH NOW	48" W x 24" D x 29" H	25.3	178	110	2165	2241	2317
	TR_3040BLH	42" W x 24" D x 29" H	21.8	158	110	2144	2219	2294
	TR_3452L	36" W x 24" D x 29" H	21.8	138	110	2139	2214	2289
	• NOW finish M	• Utility/Box/File Drawer in pedestal	• Grommet in modesty panel	• Reverse coped for smooth transition/matches desk woodgrain direction				

	Model	Overall	Cu. Ft.	Shp. Wt.	Fr. Cls.	Zone 1	Zone 2	Zone 3
Right Desk Return 	TR_3048BRH NOW	48" W x 24" D x 29" H	25.3	178	110	2165	2241	2317
	TR_3040BRH	42" W x 24" D x 29" H	21.8	158	110	2144	2219	2294
	TR_3452R	36" W x 24" D x 29" H	21.8	138	110	2139	2214	2289
	• NOW finish M	• Utility/Box/File Drawer in pedestal	• Grommet in modesty panel	• Reverse coped for smooth transition/matches desk woodgrain direction				

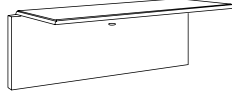
	Model	Overall	Cu. Ft.	Shp. Wt.	Fr. Cls.	Zone 1	Zone 2	Zone 3
Bridge 	TR_3041 NOW	48" W x 24" D x 29" H	4.0	89	100	926	958	991
	TR_3040 NOW	42" W x 24" D x 29" H	4.0	80	100	862	892	922
	• NOW finish M	• Connects single pedestal desks and credenzas	• Grommet in modesty panel	• Reverse coped for smooth transition/matches desk woodgrain direction				

Files, Overheads, Bookcases & Storage

	Model	Overall	Cu. Ft.	Shp. Wt.	Fr. Cls.	Zone 1	Zone 2	Zone 3
Two Drawer File 	TR_302DF NOW	18" W x 24" D x 29" H	10	111	100	1647	1705	1762
	• NOW finish M	• Side locking	• Anti-tilt mechanism allows only one drawer to open at one time					

	Model	Overall	Cu. Ft.	Shp. Wt.	Fr. Cls.	Zone 1	Zone 2	Zone 3
Two Drawer Lateral File 	TR_3026DF NOW	32" W x 21.5" D x 29" H	14.0	152	100	1790	1853	1915
		• NOW finish M	• Side locking	Heavy Duty Bottom H			202	202
			• Anti-tilt mechanism allows only one drawer to open at one time					

Bedford

	Model	Overall	Cu. Ft.	Shp. Wt.	Fr. Cls.	Zone 1	Zone 2	Zone 3
Executive Lateral File 	TR_3032DF NOW	38" W x 24" D x 29" H	19.5	183	100	2150	2225	2301
			Heavy Duty Bottom H			202	202	202
	• NOW finish M	• Side locking	• Anti-tilt mechanism allows only one drawer to open at one time					

	Model	Overall	Cu. Ft.	Shp. Wt.	Fr. Cls.	Zone 1	Zone 2	Zone 3
Three Drawer Lateral File 	TR_3036DF NOW	32" W x 21.5" D x 44.5" H	27.9	219	125	2938	3041	3144
			Heavy Duty Bottom H			303	303	303
	• NOW finish M	• Central locking	• Anti-tilt mechanism allows only one drawer to open at one time					

	Model	Overall	Cu. Ft.	Shp. Wt.	Fr. Cls.	Zone 1	Zone 2	Zone 3
Four Drawer Lateral File 	TR_4026DF NOW	32" W x 21.5" D x 56" H	27.9	252	125	3497	3619	3742
			Heavy Duty Bottom H			404	404	404
	• NOW finish M	• Central locking	• Anti-tilt mechanism allows only one drawer to open at one time					

	Model	Overall	Cu. Ft.	Shp. Wt.	Fr. Cls.	Zone 1	Zone 2	Zone 3
Open Single Hutch 	TR_3066 NOW	36" W x 16" D x 48" H	22.9	108	125	1174	1215	1256
	• NOW finish M	• Fits TR_3032DF	• Three adjustable shelves		• One grommet in lower back panel			

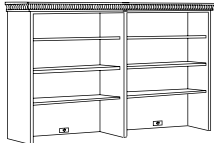
	Model	Overall	Cu. Ft.	Shp. Wt.	Fr. Cls.	Zone 1	Zone 2	Zone 3
Open Double Hutch 	TR_3068 NOW	72" W x 16" D x 48" H	43.6	207	125	2297	2377	2458
	• NOW finish M	• Open storage	• Six adjustable shelves		• Two grommets in lower back panel			

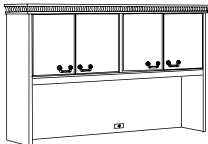
	Model	Overall	Cu. Ft.	Shp. Wt.	Fr. Cls.	Zone 1	Zone 2	Zone 3
Overhead Storage Unit 	TR_3071 NOW	72" W x 16" D x 48" H	43.6	261	125	2370	2453	2536
						2048	2120	2191
						216	224	231
	• NOW finish M	• Two overhead storage compartments	Task Light T			190	190	190
			Lock Y					
			• 25.25" clearance to desk top surface		• One grommet in lower back panel			

Model	Overall	Cu. Ft.	Shp. Wt.	Fr. Cls.	Zone 1	Zone 2	Zone 3
TL2P	19.5" W x 3.25" D x 1.25" H	1.2	3	200	216	224	231

Task Light

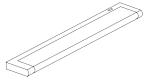

- 600 lumen, 8 watts
- 10' power cord
- Can be factory installed on overheads; specify **T** on item number

Overall	St. Ydg.	Cu. Ft.	Shp. Wt.	Fr. Cls.
61.25" W x 0.5" D x 12.75" H	2	2	6	100

TBBP62

Tackboard for TR_3077



	1	2/COM	3	4	5	6	7	8	9	10	11	12	13	14	15
Zone 1	279	297	323	339	357	384	409	436	459	491	519	553	588	617	652
Zone 2	289	307	334	351	369	397	423	451	475	508	537	572	609	639	675
Zone 3	299	318	346	363	382	411	438	467	491	525	555	592	629	660	698

Overall	St. Ydg.	Cu. Ft.	Shp. Wt.	Fr. Cls.
67.5" W x 0.5" D x 14" H	2	3	7	100

TBBF70

Tackboard for TR_3071



	1	2/COM	3	4	5	6	7	8	9	10	11	12	13	14	15
Zone 1	279	297	323	339	357	384	409	436	459	491	519	553	588	617	652
Zone 2	289	307	334	351	369	397	423	451	475	508	537	572	609	639	675
Zone 3	299	318	346	363	382	411	438	467	491	525	555	592	629	660	698

Model	Overall	Cu. Ft.	Shp. Wt.	Fr. Cls.	Zone 1	Zone 2	Zone 3
TR_362D	36" W x 16" D x 36" H	15.4	125	125	1262	1306	1350

Bookcase Storage



- One 1" thick adjustable shelf
- Crown molding on front and sides

Model	Overall	Cu. Ft.	Shp. Wt.	Fr. Cls.	Zone 1	Zone 2	Zone 3
TR_B36	36" W x 16" D x 36" H	15.4	91	125	1013	1048	1084
TR_B52	NOW 36" W x 16" D x 52" H	22.5	134	125	1119	1158	1197
TR_B76	NOW 36" W x 16" D x 77" H	31.9	191	125	1531	1585	1638

Bookcase

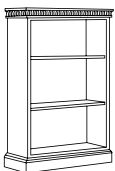

- NOW finish M
- 36" - one adjustable shelf
- 52" - two adjustable shelves
- 76" - three adjustable shelves
- 76" fixed middle shelf
- Crown molding on front and sides

Bedford

	Model	Overall	Cu. Ft.	Shp. Wt.	Fr. Cls.	Zone 1	Zone 2	Zone 3
--	-------	---------	---------	----------	----------	--------	--------	--------

Two Door Bookcase



TR_762D	NOW	36" W x 16" D x 77" H	31.9	218	125	1783	1845	1908
----------------	------------	-----------------------	------	-----	-----	-------------	-------------	-------------

- NOW finish M
- Two adjustable shelves in top
- Fixed middle shelf
- Crown molding on front and sides
- One adjustable shelf in lower storage behind doors

	Model	Overall	Cu. Ft.	Shp. Wt.	Fr. Cls.	Zone 1	Zone 2	Zone 3
--	-------	---------	---------	----------	----------	--------	--------	--------

Bookcase Wall Unit



TR_W72	NOW	34" W x 16" D x 72" H	30.3	176	125	1396	1445	1494
TR_W72NH		34" W x 16" D x 72" H	30.3	176	125	1396	1445	1494

- NOW finish M
- Three adjustable shelves
- Fixed middle shelf
- Crown molding on front only
- TR_W72 pre-bored, includes hardware to connect units
- TR_W72NH is not pre-bored

	Model	Overall	Cu. Ft.	Shp. Wt.	Fr. Cls.	Zone 1	Zone 2	Zone 3
--	-------	---------	---------	----------	----------	--------	--------	--------

Two Door Bookcase Wall Unit

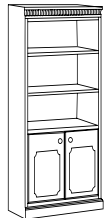

TR_W722D	NOW	34" W x 16" D x 72" H	30.3	208	125	1683	1742	1801
TR_W722DNH		34" W x 16" D x 72" H	30.3	208	125	1683	1742	1801

- NOW finish M
- Two adjustable 1" thick shelves in top compartment
- Fixed 1" thick middle shelf
- Crown molding on front only
- One adjustable shelf in lower compartment behind doors
- TR_W722 pre-bored, includes hardware to connect units
- TR_W722NH is not pre-bored

	Model	Overall	Cu. Ft.	Shp. Wt.	Fr. Cls.	Zone 1	Zone 2	Zone 3
--	-------	---------	---------	----------	----------	--------	--------	--------

Storage Cabinet

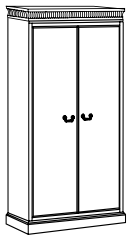

TR_76DS		36" W x 24" D x 77" H	31.9	309	125	2707	2802	2896
----------------	--	-----------------------	------	-----	-----	-------------	-------------	-------------

- Four full-width adjustable shelves
- Crown molding on front and sides

	Model	Overall	Cu. Ft.	Shp. Wt.	Fr. Cls.	Zone 1	Zone 2	Zone 3
--	-------	---------	---------	----------	----------	--------	--------	--------

Wardrobe/Storage Cabinet

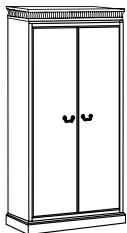

TR_76DWD		36" W x 24" D x 77" H	31.9	309	125	2916	3018	3120
-----------------	--	-----------------------	------	-----	-----	-------------	-------------	-------------

- Coat rod on left
- Four adjustable shelves fit left or right compartment
- Crown molding on front and sides
- Individually locking doors

Reception Screens

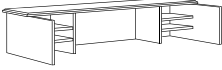
	Model	Overall	Cu. Ft.	Shp. Wt.	Fr. Cls.	Zone 1	Zone 2	Zone 3
Reception Screen Main Desk 	TR_3010 NOW	66" W x 28" D x 14" H	28.9	129	70	1462	1513	1564
	TR_3009	72" W x 28" D x 14" H	28.9	129	70	1920	1987	2054
	• NOW finish M	• 3010 fits 66" W desk • 3009 fits 72" W desk			• Includes four adjustable shelves			• Non-skid strips on bottom prohibit movement

	Model	Overall	Cu. Ft.	Shp. Wt.	Fr. Cls.	Zone 1	Zone 2	Zone 3
Reception Screen Return 	TR_3011L NOW	48" W x 22" D x 13" H	1.5	25	100	334	346	357
	TR_3011R NOW	48" W x 22" D x 13" H	1.5	25	100	334	346	357
	• NOW finish M	• 3011L fits TR_3048BLH • 3011R fits TR_3048BRH			• Assembly required			• Hardware included to connect to Main Screen

Center Drawers & Keyboard Platforms

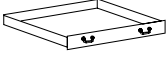
	Model	Overall	Cu. Ft.	Shp. Wt.	Fr. Cls.	Zone 1	Zone 2	Zone 3
Center Drawer 	TR_29 NOW	26.75" W x 18.75" D x 3.75" H	1.5	12	100	216	224	231
	TR_30 NOW	38.75" W x 18.75" D x 3.75" H	2.2	13	100	216	224	231
	TR_32 NOW	32.75" W x 18.75" D x 3.75" H	2.2	13	100	216	224	231
	• NOW finish M	• TR_29 Fits 60" double pedestal desks			• TR_30 Fits 72" double pedestal desks			• TR_32 Fits 66" double pedestal desks

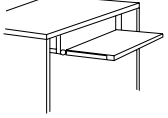
	Model	Overall	Cu. Ft.	Shp. Wt.	Fr. Cls.	Zone 1	Zone 2	Zone 3
21" Pullout Keyboard Platform 	TR_3096 NOW	21" W x 18" D x 3" H	1.5	12	92.5	249	258	266
	• NOW finish M	• 26" W kneespace required						

	Model	Overall	Cu. Ft.	Shp. Wt.	Fr. Cls.	Zone 1	Zone 2	Zone 3
Wire Management Channel 	MDWM	12" W x 2.25" D x 1.25" H	0.4	3	70	37	38	40
	• Attaches under tops or to back panels	• Peel and stick self-adhesive			• Front opening for easy access			



Hyperwork

CONTEMPORARY CASEGOODS - SIN 33721

Make a statement

Hyperwork modular casegoods offer extensive choices for design flexibility, adapting to various building layouts, business structures and personal work requirements.

Tops

- Thermally fused laminate (TFL) surfaces
- 3mm AdvantEdge PVC edge banding
- Bridge / return tops feature common grain direction with connecting units
- High pressure laminate top option available, adds 15% and lead time

Edge Profile



Finishes

- Thermally fused laminate on all surfaces
- Boardwalk, Driftwood and Shoreline are textured laminate, smooth finish available on tops only
- Color combination available with contrasting top and base
- Monocolor for same top and base use a single finish designator

How to Specify:

- 1** Series
- 2** Pulls
- 3** Laminate finish top
- 4** Laminate finish base (if different)
- 5** Model number
- 6** Options

Finished Example

H/V/DW/720F2BF/C

Finishes	Code
Black	E
Boardwalk	BW
Driftwood	DW
Espresso	X
Graphite	GP
Mahogany	M
Monticello Maple	MM
Natural Maple	FM
Shoreline	SL
Windsor Cherry	WC

Smooth Top Finishes	Code
Boardwalk	SB
Driftwood	SD
Shoreline	SS

Pulls	Code
Brushed Chrome	W
Ebony	E
Oval Nickel	D
Ribbon	R
Swoosh	S
T-Bar Nickel	V

Options	Code	Price
Factory Installed Center Drawer	C	Varies
Factory Installed Keyboard Shelf	K	Varies
Locks Doors	Y	95 (per pair)
Heavy Duty Lateral File Bottom	H	101 (per drawer)
Additional Grommet	G	138
High Pressure Laminate Top	4	15%

Power

PowerFlex power modules can be installed in many locations. See page 36 for options.

Pedestals & File Cabinets

- 0.75" thick core with thermally fused laminate on both sides
- 3mm AdvantEdge PVC edge banding
- Full or ¾ height pedestals
- Fully assembled with dowels, glue, metal brackets, screws and mechanical fasteners
- Pre-installed filing hardware holds letter- and legal-size hanging files
- Drawer bottoms 0.125" thick rated to 25 lbs.
- Steel, ball-bearing slides on all drawers - ¾ extension on box and center drawers, full extension on file drawers

Wire Management

- See individual product features for standard number of 2.5" grommet(s) and location(s)
- Additional grommets for extended wire management capability available

Locks

- Locks are "keyed alike" as standard
- "Keyed different" locks are available at \$25 per lock. Contact HPFi Customer Service for custom option code per order

End Panels

- 1" thick core with thermally fused laminate on both sides
- Heavy-duty nylon leveling glides in 5" steel plates prevent "blowout"
- .75" thick core full height modesty panels, thermally fused laminate on both sides
- 3mm AdvantEdge PVC edge banding

Desks

	Model	Overall	Knee Space	Ovrhng.	Cu. Ft.	Shp. Wt.	Fr. Cls.	Zone 1	Zone 2	Zone 3	
Bow Front, Double Pedestal Desk	H_720B NOW	72" W x 36" D x 29" H	38-1/4"	13"	51.6	280	200	2350	2432	2515	
								Center Drawer C	216	224	231
								Keyboard Platform K	249	258	266

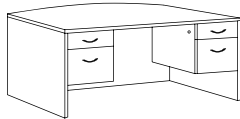

- NOW finish WC

- Side locking Box/File drawer in each pedestal

	Model	Overall	Knee Space	Ovrhng.	Cu. Ft.	Shp. Wt.	Fr. Cls.	Zone 1	Zone 2	Zone 3	
Bow Front, Double Full Pedestal Desk	H_720BF2BF	72" W x 36" D x 29" H	38-1/4"	13"	51.6	330	110	2987	3092	3196	
								Center Drawer C	216	224	231
								Keyboard Platform K	249	258	266

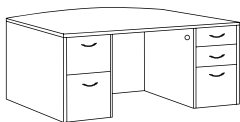

- Side locking Box/Box/File drawer in right pedestal

- Side locking File/File drawer in left pedestal

	Model	Overall	Knee Space	Ovrhng.	Cu. Ft.	Shp. Wt.	Fr. Cls.	Zone 1	Zone 2	Zone 3	
Bow Front, Double Full Pedestal Desk	H_701BF2BF	72" W x 36" D x 29" H	38-1/4"	13"	51.6	325	110	3763	3895	4026	
								Center Drawer C	216	224	231
								Keyboard Platform K	249	258	266

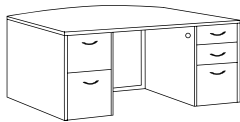

- Aluminum/frosted modesty panel

- Side locking Box/Box/File drawer in right pedestal

- Side locking File/File Drawer in left pedestal

	Model	Overall	Knee Space	Ovrhng.	Cu. Ft.	Shp. Wt.	Fr. Cls.	Zone 1	Zone 2	Zone 3	
Bow Front, Left Pedestal Desk	H_721LB	72" W x 36" D x 29" H	38-1/4"	13"	51.6	250	200	2063	2135	2207	
								Center Drawer C	216	224	231
								Keyboard Platform K	249	258	266



- Side locking Box/File drawer in left pedestal

Hyperwork

	Model	Overall	Knee Space	Ovrhng.	Cu. Ft.	Shp. Wt.	Fr. Cls.	Zone 1	Zone 2	Zone 3
Bow Front, Right Pedestal Desk 	H_721RB	72" W x 36" D x 29" H	38-1/4"	13"	51.6	250	200	2063	2135	2207
								216	224	231
								249	258	266

• Side locking Box/File drawer in right pedestal

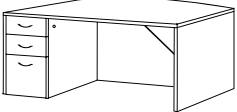
	Model	Overall	Knee Space	Ovrhng.	Cu. Ft.	Shp. Wt.	Fr. Cls.	Zone 1	Zone 2	Zone 3
Bow Front, Left Full Pedestal Desk 	H_721LB2BF	72" W x 36" D x 29" H	38-1/4"	13"	51.6	275	200	2363	2446	2528
								216	224	231
								249	258	266

• Side locking Box/Box/File drawer in left pedestal

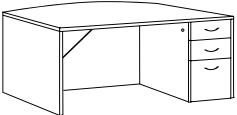
	Model	Overall	Knee Space	Ovrhng.	Cu. Ft.	Shp. Wt.	Fr. Cls.	Zone 1	Zone 2	Zone 3
Bow Front, Right Full Pedestal Desk 	H_721RB2BF	72" W x 36" D x 29" H	38-1/4"	13"	51.6	275	200	2363	2446	2528
								216	224	231
								249	258	266

• Side locking Box/Box/File drawer in right pedestal

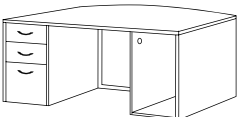
	Model	Overall	Knee Space	Ovrhng.	Cu. Ft.	Shp. Wt.	Fr. Cls.	Zone 1	Zone 2	Zone 3
Bow Front, Left Full Pedestal Desk 	H_701LB2BF	72" W x 36" D x 29" H	38-1/4"	13"	51.6	282	110	3248	3362	3475
								216	224	231
								249	258	266

• Aluminum/frosted modesty panel

• Side locking Box/Box/File drawer in left pedestal

• Open storage in right pedestal

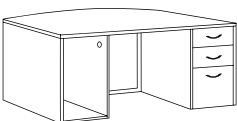
	Model	Overall	Knee Space	Ovrhng.	Cu. Ft.	Shp. Wt.	Fr. Cls.	Zone 1	Zone 2	Zone 3
Bow Front, Right Full Pedestal Desk 	H_701RB2BF	72" W x 36" D x 29" H	38-1/4"	13"	51.6	282	110	3248	3362	3475
								216	224	231
								249	258	266

• Aluminum/frosted modesty panel

• Side locking Box/Box/File drawer in right pedestal

• Open storage in left pedestal

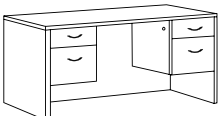
	Model	Overall	Knee Space	Ovrhng.	Cu. Ft.	Shp. Wt.	Fr. Cls.	Zone 1	Zone 2	Zone 3
Rectangular Double Pedestal Desk 	H_720	NOW 72" W x 36" D x 29" H	38-1/4"	13"	51.6	289	200	2028	2099	2170
	H_700	72" W x 30" D x 29" H	38-1/4"	13"	44.4	259	110	1812	1875	1939
	H_660	66" W x 30" D x 29" H	32-1/4"	7"	40.2	249	110	1773	1835	1897
	H_600	60" W x 30" D x 29" H	26-1/4"	7"	36.7	235	110	1712	1772	1832
								216	224	231
							249	258	266	

• NOW finish WC

• Side locking Box/File drawer in each pedestal

	Model	Overall	Knee Space	Ovrhng.	Cu. Ft.	Shp. Wt.	Fr. Cls.	Zone 1	Zone 2	Zone 3
Rectangular Double Full Pedestal Desk 	H_720F2BF NOW	72" W x 36" D x 29" H	38-1/4"	13"	51.6	330	110	2603	2694	2785
	H_700F2BF	72" W x 30" D x 29" H	38-1/4"	13"	44.4	299	110	2543	2632	2721
	H_660F2BF	66" W x 30" D x 29" H	32-1/4"	7"	40.2	299	110	2445	2531	2616
	H_600F2BF	60" W x 30" D x 29" H	26-1/4"	7"	36.7	285	110	2370	2453	2536
								Center Drawer C	216	224
							Keyboard Platform K	249	258	266

- NOW finish WC
- Side locking Box/Box/File drawer in right pedestal
- Side locking File/File drawer in left pedestal

	Model	Overall	Knee Space	Ovrhng.	Cu. Ft.	Shp. Wt.	Fr. Cls.	Zone 1	Zone 2	Zone 3	
Rectangular Double Full Pedestal Desk 	H_701F2BF	72" W x 36" D x 29" H	38-1/4"	13"	51.6	330	110	3370	3488	3606	
								Center Drawer C	216	224	231
								Keyboard Platform K	249	258	266

- Aluminum/frosted modesty panel
- Box/Box/File drawer in right pedestal
- File/File drawer in left pedestal

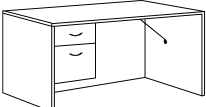
	Model	Overall	Knee Space	Ovrhng.	Cu. Ft.	Shp. Wt.	Fr. Cls.	Zone 1	Zone 2	Zone 3
Rectangular, Left Pedestal Desk 	H_721L NOW	72" W x 36" D x 29" H	38-1/4"	13"	51.6	250	200	1773	1835	1897
	H_700L	72" W x 30" D x 29" H	38-1/4"	13"	44.4	225	200	1630	1687	1744
	H_651L NOW	66" W x 30" D x 29" H	32-1/4"	7"	40.2	218	200	1611	1667	1724
	H_641L	60" W x 30" D x 29" H	26-1/4"	7"	36.7	199	200	1414	1463	1513
	H_431L	48" W x 30" D x 29" H	26-1/4"	7"	30.1	179	110	1293	1338	1384
								Center Drawer C	216	224
							Keyboard Platform K	249	258	266

- NOW finish WC
- Side locking Box/File drawer in left pedestal

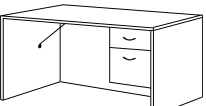
	Model	Overall	Knee Space	Ovrhng.	Cu. Ft.	Shp. Wt.	Fr. Cls.	Zone 1	Zone 2	Zone 3
Rectangular, Right Pedestal Desk 	H_721R NOW	72" W x 36" D x 29" H	38-1/4"	13"	51.6	250	200	1773	1835	1897
	H_700R	72" W x 30" D x 29" H	38-1/4"	13"	44.4	225	200	1630	1687	1744
	H_651R NOW	66" W x 30" D x 29" H	32-1/4"	7"	40.2	218	200	1611	1667	1724
	H_641R	60" W x 30" D x 29" H	26-1/4"	7"	36.7	199	200	1414	1463	1513
	H_431R	48" W x 30" D x 29" H	26-1/4"	7"	30.1	179	110	1293	1338	1384
								Center Drawer C	216	224
							Keyboard Platform K	249	258	266

- NOW finish WC
- Side locking Box/File drawer in right pedestal

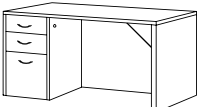
	Model	Overall	Knee Space	Ovrhng.	Cu. Ft.	Shp. Wt.	Fr. Cls.	Zone 1	Zone 2	Zone 3
Rectangular, Left Full Pedestal Desk 	H_721L2BF NOW	72" W x 36" D x 29" H	38-1/4"	13"	51.6	275	200	1980	2049	2119
	H_700L2BF	72" W x 30" D x 29" H	38-1/4"	13"	44.4	250	110	1916	1983	2050
	H_651L2BF NOW	66" W x 30" D x 29" H	32-1/4"	7"	40.2	243	110	1851	1916	1981
	H_641L2BF	60" W x 30" D x 29" H	26-1/4"	7"	36.7	224	110	1580	1635	1691
	H_431L2BF	48" W x 30" D x 29" H	26-1/4"	7"	30.1	192	110	1442	1492	1543
								Center Drawer C	216	224
							Keyboard Platform K	249	258	266

- NOW finish WC
- Side locking Box/Box/File drawer in left pedestal

Hyperwork

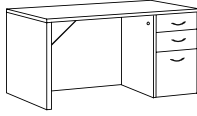
	Model	Overall	Knee Space	Ovrhng.	Cu. Ft.	Shp. Wt.	Fr. Cls.	Zone 1	Zone 2	Zone 3
Rectangular, Right Full Pedestal Desk 	H_<u>721R2BF</u> NOW	72" W x 36" D x 29" H	38-1/4"	13"	51.6	275	200	1980	2049	2119
	H_<u>700R2BF</u>	72" W x 30" D x 29" H	38-1/4"	13"	44.4	250	110	1916	1983	2050
	H_<u>651R2BF</u> NOW	66" W x 30" D x 29" H	32-1/4"	7"	40.2	243	110	1851	1916	1981
	H_<u>641R2BF</u>	60" W x 30" D x 29" H	26-1/4"	7"	36.7	224	110	1580	1635	1691
	H_<u>431R2BF</u>	48" W x 30" D x 29" H	26-1/4"	7"	30.1	192	110	1442	1492	1543
					Center Drawer C			216	224	231
					Keyboard Platform K			249	258	266

• Side locking Box/Box/File drawer in right pedestal

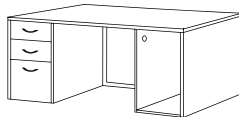
	Model	Overall	Knee Space	Ovrhng.	Cu. Ft.	Shp. Wt.	Fr. Cls.	Zone 1	Zone 2	Zone 3
Rectangular, Left Full Pedestal Desk 	H_<u>701L2BF</u> NOW	72" W x 36" D x 29" H	38-1/4"	13"	51.6	295	110	3086	3194	3302
					Center Drawer C			216	224	231
					Keyboard Platform K			249	258	266

• Aluminum/frosted modesty panel

• Side locking Box/Box/File drawer in left pedestal

• Open storage pedestal on right

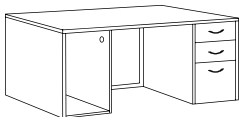
	Model	Overall	Knee Space	Ovrhng.	Cu. Ft.	Shp. Wt.	Fr. Cls.	Zone 1	Zone 2	Zone 3
Rectangular, Right Full Pedestal Desk 	H_<u>701R2BF</u>	72" W x 36" D x 29" H	38-1/4"	13"	51.6	295	110	3086	3194	3302
					Center Drawer C			216	224	231
					Keyboard Platform K			249	258	266

• Aluminum/frosted modesty panel

• Side locking Box/Box/File drawer in right pedestal

• Open storage pedestal on left

Corner Desks

	Model	Overall	Knee Space	Ovrhng.	Cu. Ft.	Shp. Wt.	Fr. Cls.	Zone 1	Zone 2	Zone 3
Left Pedestal Corner Desk 	H_<u>451L</u>	72" W x 36/24" D x 29" H	38-1/4"	13"	51.6	269	200	2466	2552	2639
					Keyboard Platform K			249	258	266

• Side locking Box/File drawer in left pedestal

• Grommets in top, modesty panel (approach side) and support panel

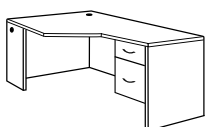
	Model	Overall	Knee Space	Ovrhng.	Cu. Ft.	Shp. Wt.	Fr. Cls.	Zone 1	Zone 2	Zone 3
Right Pedestal Corner Desk 	H_<u>451R</u>	72" W x 36/24" D x 29" H	38-1/4"	13"	51.6	269	200	2466	2552	2639
					Keyboard Platform K			249	258	266

• Side locking Box/File drawer in right pedestal

• Grommets in top, modesty panel (approach side) and support panel

	Model	Overall	Knee Space	Ovrhng.	Cu. Ft.	Shp. Wt.	Fr. Cls.	Zone 1	Zone 2	Zone 3
Left Full Pedestal Corner Desk	H_451L2BF	72" W x 36/24" D x 29" H	38-1/4"	13"	51.6	294	110	2707	2802	2896
								Keyboard Platform K		



- Side locking Box/Box/File drawer in left pedestal
- Grommets in top, modesty panel (approach side) and support panel

	Model	Overall	Knee Space	Ovrhng.	Cu. Ft.	Shp. Wt.	Fr. Cls.	Zone 1	Zone 2	Zone 3
Right Full Pedestal Corner Desk	H_451R2BF	72" W x 36/24" D x 29" H	38-1/4"	13"	51.6	294	110	2707	2802	2896
								Keyboard Platform K		

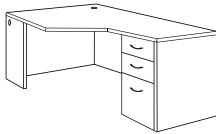

- Side locking Box/Box/File drawer in right pedestal
- Grommets in top, modesty panel (approach side) and support panel

	Model	Overall	Knee Space	Ovrhng.	Cu. Ft.	Shp. Wt.	Fr. Cls.	Zone 1	Zone 2	Zone 3
Left Pedestal Curved Corner Desk	H_462L	72" W x 42/30" D x 29" H	38-1/4"	13"	58.9	299	200	2466	2552	2639



- Side locking Box/File drawer in left pedestal
- Grommets in top, modesty panel (approach side) and support panel

	Model	Overall	Knee Space	Ovrhng.	Cu. Ft.	Shp. Wt.	Fr. Cls.	Zone 1	Zone 2	Zone 3
Right Pedestal Curved Corner Desk	H_462R	72" W x 42/30" D x 29" H	38-1/4"	13"	58.9	299	200	2466	2552	2639

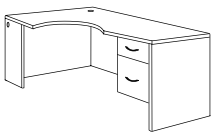

- Side locking Box/File drawer in right pedestal
- Grommets in top, modesty panel (approach side) and support panel

	Model	Overall	Knee Space	Ovrhng.	Cu. Ft.	Shp. Wt.	Fr. Cls.	Zone 1	Zone 2	Zone 3
Left Full Pedestal Curved Corner Desk	H_462L2BF	72" W x 42/30" D x 29" H	38-1/4"	13"	58.9	324	110	2707	2802	2896

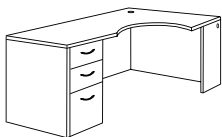

- Side locking Box/Box/File drawer in left pedestal
- Grommets in top, modesty panel (approach side) and support panel

	Model	Overall	Knee Space	Ovrhng.	Cu. Ft.	Shp. Wt.	Fr. Cls.	Zone 1	Zone 2	Zone 3
Right Full Pedestal Curved Corner Desk	H_462R2BF	72" W x 42/30" D x 29" H	38-1/4"	13"	58.9	324	110	2707	2802	2896

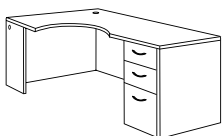

- Side locking Box/Box/File drawer in right pedestal
- Grommets in top, modesty panel (approach side) and support panel

Hyperwork

Peninsula & P-Top Desks

	Model	Overall	Knee Space	Ovrhng.	Cu. Ft.	Shp. Wt.	Fr. Cls.	Zone 1	Zone 2	Zone 3
Peninsula Desk	HW_799 NOW	72" W x 36" D x 29" H	38-1/4"	13"	51.6	155	250	1252	1296	1340

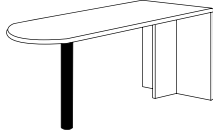

- NOW finish WC
- Panel end leg
- 4" diameter steel column with adjustable glide

	Model	Overall	Knee Space	Ovrhng.	Cu. Ft.	Shp. Wt.	Fr. Cls.	Zone 1	Zone 2	Zone 3
Peninsula Desk	HW_798	72" W x 36" D x 29" H	38-1/4"	13"	51.6	185	250	1304	1350	1395

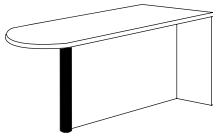

- Panel end leg
- 4" diameter steel column with adjustable glide
- Full height modesty panel

	Model	Overall	Knee Space	Ovrhng.	Cu. Ft.	Shp. Wt.	Fr. Cls.	Zone 1	Zone 2	Zone 3
Peninsula Top	HW_797	72" W x 36" D x 29" H	38-1/4"	13"	15.6	115	125	1026	1062	1098

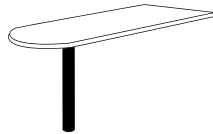

- 4" diameter steel column with adjustable glide
- Unsupported end must connect to single pedestal desk, credenza or shell

	Model	Overall	Knee Space	Ovrhng.	Cu. Ft.	Shp. Wt.	Fr. Cls.	Zone 1	Zone 2	Zone 3
Left P-Shape Desk	HW_899L	72" W x 42/30" D x 29" H	38-1/4"	13"	58.9	160	250	1438	1488	1539

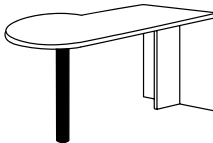

- Panel end leg
- 4" diameter steel column with adjustable glide

	Model	Overall	Knee Space	Ovrhng.	Cu. Ft.	Shp. Wt.	Fr. Cls.	Zone 1	Zone 2	Zone 3
Right P-Shape Desk	HW_899R	72" W x 42/30" D x 29" H	38-1/4"	13"	58.9	160	250	1438	1488	1539

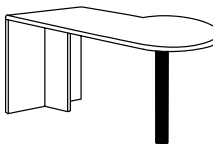

- Panel end leg
- 4" diameter steel column with adjustable glide

	Model	Overall	Knee Space	Ovrhng.	Cu. Ft.	Shp. Wt.	Fr. Cls.	Zone 1	Zone 2	Zone 3
Left P-Shape Desk	HW_898L	72" W x 42/30" D x 29" H	38-1/4"	13"	58.9	190	250	1523	1576	1630

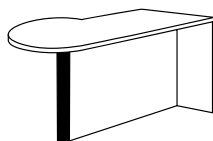

- Panel end leg
- 4" diameter steel column with adjustable glide
- Full height modesty panel

	Model	Overall	Knee Space	Ovrhng.	Cu. Ft.	Shp. Wt.	Fr. Cls.	Zone 1	Zone 2	Zone 3
--	-------	---------	------------	---------	---------	----------	----------	--------	--------	--------

Right P-Shape Desk

HW_898R	72" W x 42/30" D x 29" H	38-1/4"	13"	58.9	190	250		1523	1576	1630
----------------	--------------------------	---------	-----	------	-----	-----	--	-------------	-------------	-------------

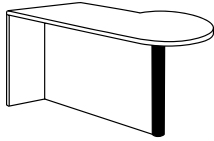

- Panel end leg
- 4" diameter steel column with adjustable glide
- Full height modesty panel

	Model	Overall	Knee Space	Ovrhng.	Cu. Ft.	Shp. Wt.	Fr. Cls.	Zone 1	Zone 2	Zone 3
--	-------	---------	------------	---------	---------	----------	----------	--------	--------	--------

Left P-Shape Top

HW_897L	72" W x 42/30" D x 29" H	38-1/4"	13"	18.2	120	125		1258	1302	1346
----------------	--------------------------	---------	-----	------	-----	-----	--	-------------	-------------	-------------

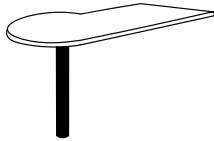

- 4" diameter steel column with adjustable glide
- Unsupported end must connect to single pedestal desk, credenza or shell

	Model	Overall	Knee Space	Ovrhng.	Cu. Ft.	Shp. Wt.	Fr. Cls.	Zone 1	Zone 2	Zone 3
--	-------	---------	------------	---------	---------	----------	----------	--------	--------	--------

Right P-Shape Top

HW_897R	72" W x 42/30" D x 29" H	38-1/4"	13"	18.2	120	125		1258	1302	1346
----------------	--------------------------	---------	-----	------	-----	-----	--	-------------	-------------	-------------

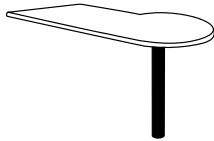

- 4" diameter steel column with adjustable glide
- Unsupported end must connect to single pedestal desk, credenza or shell

Credenzas

	Model	Overall	Knee Space	Ovrhng.	Cu. Ft.	Shp. Wt.	Fr. Cls.	Zone 1	Zone 2	Zone 3
--	-------	---------	------------	---------	---------	----------	----------	--------	--------	--------

Lateral File Credenza

H_733	72.5" W x 24" D x 29" H	38-1/4"	13"	35.7	299	125		2649	2742	2834
--------------	-------------------------	---------	-----	------	-----	-----	--	-------------	-------------	-------------



- Four front locking lateral file drawers

Heavy Duty Bottom H	404	404	404
----------------------------	------------	------------	------------

	Model	Overall	Knee Space	Ovrhng.	Cu. Ft.	Shp. Wt.	Fr. Cls.	Zone 1	Zone 2	Zone 3
--	-------	---------	------------	---------	---------	----------	----------	--------	--------	--------

Lateral File/Bookcase Credenza

H_BK733L	72.5" W x 24" D x 29" H	38-1/4"	13"	35.7	306	125		2380	2463	2547
-----------------	-------------------------	---------	-----	------	-----	-----	--	-------------	-------------	-------------



- Two front locking lateral file drawers on left
- Enclosed bookcase storage on right

Heavy Duty Bottom H	202	202	202
----------------------------	------------	------------	------------

Door Lock Y	95	95	95
--------------------	-----------	-----------	-----------

	Model	Overall	Knee Space	Ovrhng.	Cu. Ft.	Shp. Wt.	Fr. Cls.	Zone 1	Zone 2	Zone 3
--	-------	---------	------------	---------	---------	----------	----------	--------	--------	--------

Lateral File/Bookcase Credenza

H_BK733R	72.5" W x 24" D x 29" H	38-1/4"	13"	35.7	306	125		2380	2463	2547
-----------------	-------------------------	---------	-----	------	-----	-----	--	-------------	-------------	-------------



- Two front locking lateral file drawers on right
- Enclosed bookcase storage on left

Heavy Duty Bottom H	202	202	202
----------------------------	------------	------------	------------

Door Lock Y	95	95	95
--------------------	-----------	-----------	-----------

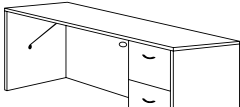
	Model	Overall	Knee Space	Ovrhng.	Cu. Ft.	Shp. Wt.	Fr. Cls.	Zone 1	Zone 2	Zone 3
Right Full Pedestal Credenza 	H_725RF	72" W x 24" D x 29" H	38-1/4"	13"	35.7	199	125	1841	1905	1970
	H_625RF	66" W x 24" D x 29" H	38-1/4"	13"	35.7	189	125	1817	1881	1944
	H_615RF	60" W x 24" D x 29" H	38-1/4"	13"	30.5	179	125	1795	1858	1921
								216	224	231
								249	258	266

- Side locking File/File drawer in right pedestal
- Grommet in center, top of back panel
- Must use H_384 Bridge with H_615R

	Model	Overall	Knee Space	Ovrhng.	Cu. Ft.	Shp. Wt.	Fr. Cls.	Zone 1	Zone 2	Zone 3
Left Lateral File Credenza 	H_733L	72" W x 24" D x 29" H	38-1/4"	13"	35.7	229	125	1954	2022	2091
	H_633L	66" W x 24" D x 29" H	38-1/4"	13"	32	219	125	1887	1953	2019
								202	202	202

- Two front locking lateral file drawers on left

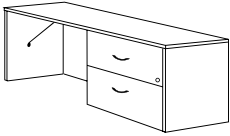
	Model	Overall	Knee Space	Ovrhng.	Cu. Ft.	Shp. Wt.	Fr. Cls.	Zone 1	Zone 2	Zone 3
Right Lateral File Credenza 	H_733R	72" W x 24" D x 29" H	38-1/4"	13"	35.7	229	125	1954	2022	2091
	H_633R	66" W x 24" D x 29" H	38-1/4"	13"	32	219	125	1887	1953	2019
								202	202	202

- Two front locking lateral file drawers on right

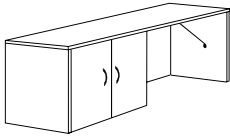
	Model	Overall	Knee Space	Ovrhng.	Cu. Ft.	Shp. Wt.	Fr. Cls.	Zone 1	Zone 2	Zone 3
Left Bookcase Credenza 	H_734L	72" W x 24" D x 29" H	38-1/4"	13"	35.7	225	125	1954	2022	2091
	H_634L	66" W x 24" D x 29" H	38-1/4"	13"	32	219	125	1887	1953	2019

- Enclosed bookcase storage area on left

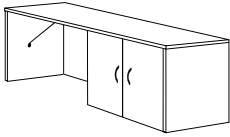
	Model	Overall	Knee Space	Ovrhng.	Cu. Ft.	Shp. Wt.	Fr. Cls.	Zone 1	Zone 2	Zone 3
Right Bookcase Credenza 	H_734R	72" W x 24" D x 29" H	38-1/4"	13"	35.7	225	125	1954	2022	2091
	H_634R	66" W x 24" D x 29" H	38-1/4"	13"	32	219	125	1887	1953	2019

- Enclosed bookcase storage area on right

	Model	Overall	Knee Space	Ovrhng.	Cu. Ft.	Shp. Wt.	Fr. Cls.	Zone 1	Zone 2	Zone 3
Multi File Credenza 	H_735L (Shown)	72" W x 24" D x 29" H	38-1/4"	13"	35.7	261	125	2071	2143	2216
	H_735R	72" W x 24" D x 29" H	38-1/4"	13"	35.7	261	125	2071	2143	2216
								101	101	101

- Two box, one file drawer at top
- "Hot project" slot between top drawers
- Front locking lateral file drawer at bottom

Hyperwork

Returns and Bridges

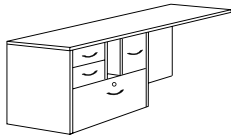
	Model	Overall	Knee Space	Ovrhng.	Cu. Ft.	Shp. Wt.	Fr. Cls.	Zone 1	Zone 2	Zone 3
	H_<u>735LRT</u>	72" W x 24" D x 29" H	38-1/4"	13"	35.7	250	110	2071	2143	2216
								101	101	101
								249	258	266
	<ul style="list-style-type: none"> • Two box, one file drawer at top • "Hot project" slot between top drawers • Front locking lateral file drawer at bottom 									

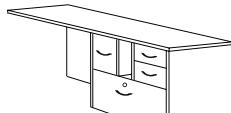
	Model	Overall	Knee Space	Ovrhng.	Cu. Ft.	Shp. Wt.	Fr. Cls.	Zone 1	Zone 2	Zone 3
	H_<u>735RRT</u>	72" W x 24" D x 29" H	38-1/4"	13"	35.7	250	110	2071	2143	2216
								101	101	101
								249	258	266
	<ul style="list-style-type: none"> • Two box, one file drawer at top • "Hot project" slot between top drawers • Front locking lateral file drawer at bottom 									

	Model	Overall	Knee Space	Ovrhng.	Cu. Ft.	Shp. Wt.	Fr. Cls.	Zone 1	Zone 2	Zone 3
	H_<u>733LRT</u>	72" W x 24" D x 29" H	38-1/4"	13"	35.7	220	110	1862	1927	1992
								202	202	202
								249	258	266
	<ul style="list-style-type: none"> • Two front locking lateral file drawers on left 									

	Model	Overall	Knee Space	Ovrhng.	Cu. Ft.	Shp. Wt.	Fr. Cls.	Zone 1	Zone 2	Zone 3
	H_<u>733RRT</u>	72" W x 24" D x 29" H	38-1/4"	13"	35.7	220	110	1862	1927	1992
								202	202	202
								249	258	266
	<ul style="list-style-type: none"> • Two front locking lateral file drawers on right 									

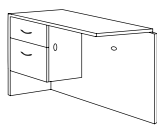
	Model	Overall	Knee Space	Ovrhng.	Cu. Ft.	Shp. Wt.	Fr. Cls.	Zone 1	Zone 2	Zone 3
	H_<u>762L</u>	60" W x 24" D x 29" H	38-1/4"	13"	32	161	110	1365	1413	1461
	H_<u>722L</u> NOW	48" W x 24" D x 29" H	38-1/4"	13"	24.3	149	110	1238	1281	1325
	H_<u>622L</u>	42" W x 24" D x 29" H	38-1/4"	13"	21.5	140	110	1207	1249	1291
	H_<u>452L</u> NOW	36" W x 24" D x 29" H	38-1/4"	13"	21.5	132	110	1204	1246	1288
								249	258	266
	<ul style="list-style-type: none"> • NOW finish WC • Side locking Box/File drawer in left pedestal • Grommet in center, top of back panel • Keyboard platform cannot be installed on H_<u>452L</u> 									

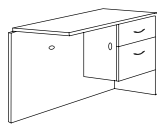
	Model	Overall	Knee Space	Ovrhng.	Cu. Ft.	Shp. Wt.	Fr. Cls.	Zone 1	Zone 2	Zone 3
	H_<u>762R</u>	60" W x 24" D x 29" H	38-1/4"	13"	32	161	110	1365	1413	1461
	H_<u>722R</u> NOW	48" W x 24" D x 29" H	38-1/4"	13"	24.3	149	110	1238	1281	1325
	H_<u>622R</u>	42" W x 24" D x 29" H	38-1/4"	13"	21.5	140	110	1207	1249	1291
	H_<u>452R</u> NOW	36" W x 24" D x 29" H	38-1/4"	13"	21.5	132	110	1204	1246	1288
								249	258	266
	<ul style="list-style-type: none"> • NOW finish WC • Side locking Box/File drawer in right pedestal • Grommet in center, top of back panel • Keyboard platform cannot be installed on H_<u>452R</u> 									

	Model	Overall	Knee Space	Ovrhng.	Cu. Ft.	Shp. Wt.	Fr. Cls.	Zone 1	Zone 2	Zone 3
Left Desk Return 	H_<u>762</u>LF	60" W x 24" D x 29" H	38-1/4"	13"	32	179	110	1637	1694	1752
	H_<u>722</u>LF	48" W x 24" D x 29" H	38-1/4"	13"	24.3	163	110	1516	1569	1622
	H_<u>622</u>LF	42" W x 24" D x 29" H	38-1/4"	13"	21.5	156	110	1495	1547	1600
	H_<u>452</u>LF	36" W x 24" D x 29" H	38-1/4"	13"	21.5	148	110	1465	1516	1568
	Keyboard Platform K								249	258

- Side locking File/File drawer in left pedestal
- Grommet in center, top of back panel
- Keyboard platform cannot be installed on H_452LF

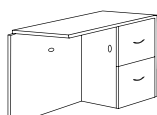
	Model	Overall	Knee Space	Ovrhng.	Cu. Ft.	Shp. Wt.	Fr. Cls.	Zone 1	Zone 2	Zone 3
Right Desk Return 	H_<u>762</u>RF	60" W x 24" D x 29" H	38-1/4"	13"	32	179	110	1637	1694	1752
	H_<u>722</u>RF	48" W x 24" D x 29" H	38-1/4"	13"	24.3	163	110	1516	1569	1622
	H_<u>622</u>RF	42" W x 24" D x 29" H	38-1/4"	13"	21.5	156	110	1495	1547	1600
	H_<u>452</u>RF	36" W x 24" D x 29" H	38-1/4"	13"	21.5	148	110	1465	1516	1568
	Keyboard Platform K								249	258

- Side locking File/File drawer in right pedestal
- Grommet in center, top of back panel
- Pullout keyboard shelf cannot be installed on H_452RF

	Model	Overall	Knee Space	Ovrhng.	Cu. Ft.	Shp. Wt.	Fr. Cls.	Zone 1	Zone 2	Zone 3
Bridge 	HW_<u>485</u> NOW	48" W x 24" D x 29" H	38-1/4"	13"	4	66	100	615	637	658
	HW_<u>484</u>	42" W x 24" D x 29" H	38-1/4"	13"	4	58	100	603	624	645
	HW_<u>384</u>	42" W x 19" D x 29" H	38-1/4"	13"	4	48	100	610	631	653

- NOW finish WC
- Two grommets in top of modesty panel
- Connects single pedestal desks/credenzas
- H_384 recommended for use with 60" wide units

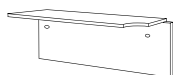
	Model	Overall	Knee Space	Ovrhng.	Cu. Ft.	Shp. Wt.	Fr. Cls.	Zone 1	Zone 2	Zone 3
Left Asymmetrical Bridge 	HW_<u>496</u>L	48" W x 24/19" D x 29" H	38-1/4"	13"	4	66	100	704	729	753
	HW_<u>495</u>L	42" W x 24/19" D x 29" H	38-1/4"	13"	4	56	100	682	706	730

- Two grommets in top of modesty panel
- Connects with 462 Curved Corner Desks and 448 Curved Front Corner Module
- Not freestanding

	Model	Overall	Knee Space	Ovrhng.	Cu. Ft.	Shp. Wt.	Fr. Cls.	Zone 1	Zone 2	Zone 3
Right Asymmetrical Bridge 	HW_<u>496</u>R	48" W x 24/19" D x 29" H	38-1/4"	13"	4	66	100	704	729	753
	HW_<u>495</u>R	42" W x 24/19" D x 29" H	38-1/4"	13"	4	56	100	682	706	730

- Two grommets in top of modesty panel
- Connects with 462 Curved Corner Desks and 448 Curved Front Corner Module
- Not freestanding

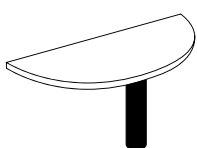
	Model	Overall	Knee Space	Ovrhng.	Cu. Ft.	Shp. Wt.	Fr. Cls.	Zone 1	Zone 2	Zone 3
Spanner Island 	HW_<u>ST60</u>	60" W x 30" D x 29" H	38-1/4"	13"	7.21	96	85	1130	1170	1209
	HW_<u>ST48</u>	48" W x 24" D x 29" H	38-1/4"	13"	4.8	66	85	936	969	1002

- 5" diameter black steel column
- Transitions ends of back-to-back units
- ST60 Connects to 30" D units
- ST48 Connects to 24" D units

Hyperwork

Corner Units

	Model	Overall	Cu. Ft.	Shp. Wt.	Fr. Cls.	Zone 1	Zone 2	Zone 3
Curved Front Corner Module	HW_449	42" W x 42" D x 29" H	34.3	152	200	1074	1112	1149
	HW_448	36" W x 36" D x 29" H	27.2	122	200	948	981	1014

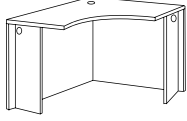

- Grommets in top, modesty panel and support panels
- H_449 connects to 24" deep adjoining surfaces
- H_448 connects to 19" deep adjoining surface

	Model	Overall	Cu. Ft.	Shp. Wt.	Fr. Cls.	Zone 1	Zone 2	Zone 3
Straight Front Corner Module	HW_449S	42" W x 42" D x 29" H	34.3	152	200	1074	1112	1149

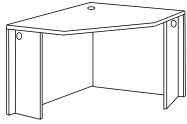

- Grommets in top, modesty panel and support panels
- Connects to 24" deep adjoining surfaces

	Model	Overall	Cu. Ft.	Shp. Wt.	Fr. Cls.	Zone 1	Zone 2	Zone 3
Left Dual-Depth Corner Module	HW_44930L	42" W x 42" D x 29" H	34.3	162	200	982	1016	1051

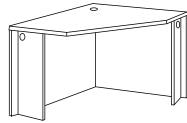

- Grommets in top, modesty panel and support panels
- Connects to 30" deep adjoining surface on left
- Connects to 24" deep adjoining surface on right

	Model	Overall	Cu. Ft.	Shp. Wt.	Fr. Cls.	Zone 1	Zone 2	Zone 3
Right Dual-Depth Corner Module	HW_44930R	42" W x 42" D x 29" H	34.3	162	200	982	1016	1051

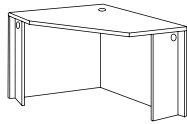

- Grommets in top, modesty panel and support panels
- Connects to 30" deep adjoining surface on right
- Connects to 24" deep adjoining surface on left

Rectangular Shells

	Model	Overall	Cu. Ft.	Shp. Wt.	Fr. Cls.	Zone 1	Zone 2	Zone 3
30" D Rectangular Shell	HW_RS3072	72" W x 30" D x 29" H	44.4	200	200	967	1001	1035
	HW_RS3066	66" W x 30" D x 29" H	40.2	192	200	936	969	1002
	HW_RS3060	60" W x 30" D x 29" H	36.7	184	200	893	924	956
	HW_RS3048	48" W x 30" D x 29" H	30.1	179	110	824	853	882
	HW_RS3042	42" W x 30" D x 29" H	30.1	171	110	772	799	826
	HW_RS3036	36" W x 30" D x 29" H	23	163	110	740	766	792
	HW_RS3030	30" W x 30" D x 29" H	23	155	110	701	726	750

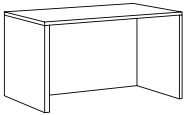

- Freestanding shell with full panel legs

24" D Rectangular Shell

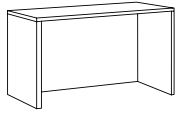

Model	Overall	Cu. Ft.	Shp. Wt.	Fr. Cls.	Zone 1	Zone 2	Zone 3
HW_RS2472Z	72" W x 24" D x 29" H	35.7	169	200	967	1001	1035
HW_RS2466Z	66" W x 24" D x 29" H	32	159	200	936	969	1002
HW_RS2460Z	60" W x 24" D x 29" H	30.5	149	200	893	924	956
HW_RS2454Z	54" W x 24" D x 29" H	28	139	200	834	863	892
HW_RS2448Z	48" W x 24" D x 29" H	24.3	129	110	824	853	882
HW_RS2442Z	42" W x 24" D x 29" H	21.7	119	110	772	799	826
HW_RS2436Z	36" W x 24" D x 29" H	19.8	109	110	740	766	792
HW_RS2430Z	30" W x 24" D x 29" H	19.8	99	110	701	726	750

- Freestanding shell with full panel legs

24" D Left Return Shell

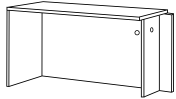

Model	Overall	Cu. Ft.	Shp. Wt.	Fr. Cls.	Zone 1	Zone 2	Zone 3
HW_RS2472L	72" W x 24" D x 29" H	169	35.7	200	967	1001	1035
HW_RS2466L	66" W x 24" D x 29" H	159	32	200	936	969	1002
HW_RS2460L	60" W x 24" D x 29" H	149	30.5	200	893	924	956
HW_RS2454L	54" W x 24" D x 29" H	138	28	200	834	863	892
HW_RS2448L	48" W x 24" D x 29" H	129	24.3	110	824	853	882
HW_RS2442L	42" W x 24" D x 29" H	119	21.7	110	772	799	826
HW_RS2436L	36" W x 24" D x 29" H	109	19.8	110	740	766	792
HW_RS2430L	30" W x 24" D x 29" H	99	19.8	110	701	726	750

Support Leg Placement



Support Leg placement for 72", 66", 60" and 54" lengths relocated inward (12" from end) for increased support



48", 42", 36" and 30" lengths located close to ends

- Left side connecting shell
- Half depth right support panel
- Full depth left panel leg
- Grommet in top of support and modesty panels

24" D Right Return Shell

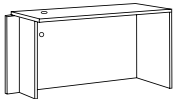

Model	Overall	Cu. Ft.	Shp. Wt.	Fr. Cls.	Zone 1	Zone 2	Zone 3
HW_RS2472R	72" W x 24" D x 29" H	169	35.7	200	967	1001	1035
HW_RS2466R	66" W x 24" D x 29" H	159	32	200	936	969	1002
HW_RS2460R	60" W x 24" D x 29" H	149	30.5	200	893	924	956
HW_RS2454R	54" W x 24" D x 29" H	138	28	200	834	863	892
HW_RS2448R	48" W x 24" D x 29" H	129	24.3	110	824	853	882
HW_RS2442R	42" W x 24" D x 29" H	119	21.7	110	772	799	826
HW_RS2436R	36" W x 24" D x 29" H	109	19.8	110	740	766	792
HW_RS2430R	30" W x 24" D x 29" H	99	19.8	110	701	726	750

Support Leg Placement



Support Leg placement for 72", 66", 60" and 54" lengths relocated inward (12" from end) for increased support



48", 42", 36" and 30" lengths located close to ends

- Right side connecting shell
- Half depth left support panel
- Full depth right panel leg
- Grommet in top of support and modesty panels

Asymmetrical Shells

	Model	Overall	Cu. Ft.	Shp. Wt.	Fr. Cls.	Zone 1	Zone 2	Zone 3
24" D Left Asymmetrical Shell	HW_197224L	72" W x 24" D x 29" H	165	35.7	200	975	1009	1043
	HW_196624L	66" W x 24" D x 29" H	155	32	200	935	968	1000
	HW_196024L	60" W x 24" D x 29" H	145	30.5	200	903	935	966
	HW_195424L	54" W x 24" D x 29" H	135	27.6	200	876	907	937
	HW_194824L	48" W x 24" D x 29" H	125	24.3	200	857	887	917
	HW_194224L	42" W x 24" D x 29" H	115	21.7	200	815	844	872
	HW_193624L	36" W x 24" D x 29" H	105	19.8	200	782	809	837
	HW_193024L	30" W x 24" D x 29" H	95	19.8	200	731	757	782

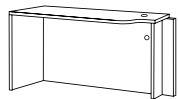

Support Leg Placement

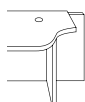

Support Leg placement for 72", 66", 60" and 54" lengths relocated inward (12" from end) for increased support

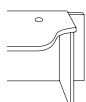

48", 42", 36" and 30" lengths located close to ends

- Left side connecting shell
- Half depth right support panel
- Full depth left panel leg
- Grommet in top of support and modesty panels

	Model	Overall	Cu. Ft.	Shp. Wt.	Fr. Cls.	Zone 1	Zone 2	Zone 3
24" D Right Asymmetrical Shell	HW_197224R	72" W x 24" D x 29" H	165	35.7	200	975	1009	1043
	HW_196624R	66" W x 24" D x 29" H	155	32	200	935	968	1000
	HW_196024R	60" W x 24" D x 29" H	145	30.5	200	903	935	966
	HW_195424R	54" W x 24" D x 29" H	135	27.6	200	876	907	937
	HW_194824R	48" W x 24" D x 29" H	125	24.3	200	857	887	917
	HW_194224R	42" W x 24" D x 29" H	115	21.7	200	815	844	872
	HW_193624R	36" W x 24" D x 29" H	105	19.8	200	782	809	837
	HW_193024R	30" W x 24" D x 29" H	95	19.8	200	731	757	782

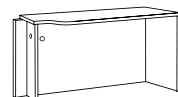

Support Leg Placement

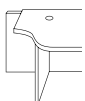

Support Leg placement for 72", 66", 60" and 54" lengths relocated inward (12" from end) for increased support

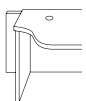

48", 42", 36" and 30" lengths located close to ends

- Right side connecting shell
- Half depth left support panel
- Full depth right panel leg
- Grommet in top of support and modesty panels

Modular Filing

	Model	Overall	Cu. Ft.	Shp. Wt.	Fr. Cls.	Zone 1	Zone 2	Zone 3
Utility Pedestal	H_UP NOW	15.75" W x 22" D x 17.75" H	7	61	100	838	867	897



- NOW finish WC
- Front locking Box/File drawer pedestal

	Model	Overall	Cu. Ft.	Shp. Wt.	Fr. Cls.	Zone 1	Zone 2	Zone 3
Utility Pedestal	H_UP2BF	15.75" W x 22" D x 27.25" H	10.1	83	100	1012	1047	1083



- Front locking Box/Box/File drawer pedestal

	Model	Overall	Cu. Ft.	Shp. Wt.	Fr. Cls.	Zone 1	Zone 2	Zone 3
Utility Pedestal	H_UPF	15.75" W x 22" D x 27.25" H	10.1	83	100	1012	1047	1083



- Front locking File/File drawer pedestal

	Model	Overall	Cu. Ft.	Shp. Wt.	Fr. Cls.	Zone 1	Zone 2	Zone 3
Utility Pedestal	H_ULF	30.5" W x 22" D x 27.25" H	19.8	165	100	1271	1315	1360

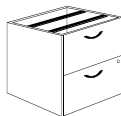

- Lateral File Drawer Pedestal
- Front locking

Hyperwork

Reception Stations

	Model	Overall	Cu. Ft.	Shp. Wt.	Fr. Cls.	Zone 1	Zone 2	Zone 3	
Left Pedestal Reception Desk	H_7230L NOW	72" W x 36" D x 42" H	63.9	343	200	2271	2350	2430	
	• NOW finish WC	• Single key side locking Box/File pedestal on left				Center Drawer C	216	224	231
							Keyboard Platform K	249	258



	Model	Overall	Cu. Ft.	Shp. Wt.	Fr. Cls.	Zone 1	Zone 2	Zone 3	
Right Pedestal Reception Desk	H_7230R NOW	72" W x 36" D x 42" H	63.9	343	200	2271	2350	2430	
	• NOW finish WC	• Single key side locking Box/File pedestal on right				Center Drawer C	216	224	231
							Keyboard Platform K	249	258



	Model	Overall	Cu. Ft.	Shp. Wt.	Fr. Cls.	Zone 1	Zone 2	Zone 3	
Left Pedestal Reception Return	H_2442L NOW	42" W x 24" D x 41" H	63.9	195	110	1516	1569	1622	
	• NOW finish WC	• Single key side locking Box/File pedestal on left				Keyboard Platform K	249	258	266

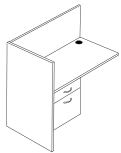

	Model	Overall	Cu. Ft.	Shp. Wt.	Fr. Cls.	Zone 1	Zone 2	Zone 3	
Right Pedestal Reception Return	H_2442R NOW	42" W x 24" D x 41" H	63.9	195	110	1516	1569	1622	
	• NOW finish WC	• Single key side locking Box/File pedestal on right				Keyboard Platform K	249	258	266

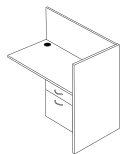

	Model	Overall	Cu. Ft.	Shp. Wt.	Fr. Cls.	Zone 1	Zone 2	Zone 3	
Left Pedestal Reception Desk	H_7230L2BF	72" W x 36" D x 42" H	63.9	368	110	2701	2796	2890	
	• Single key side locking Box/Box/File pedestal on left				Center Drawer C	216	224	231	
							Keyboard Platform K	249	258



	Model	Overall	Cu. Ft.	Shp. Wt.	Fr. Cls.	Zone 1	Zone 2	Zone 3
Right Pedestal Reception Desk	H_7230R2BF	72" W x 36" D x 42" H	63.9	368	110	2701	2796	2890
						216	224	231
						249	258	266

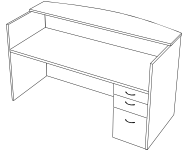

- Single key side locking Box/Box/File pedestal on right

	Model	Overall	Cu. Ft.	Shp. Wt.	Fr. Cls.	Zone 1	Zone 2	Zone 3
Left Pedestal Reception Return	H_2442LF	42" W x 24" D x 41" H	63.9	220	110	1774	1836	1898
						249	258	266

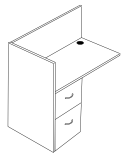

- Single key side locking File/File pedestal on left
- Grommet in top and modesty panel

	Model	Overall	Cu. Ft.	Shp. Wt.	Fr. Cls.	Zone 1	Zone 2	Zone 3
Right Pedestal Reception Return	H_2442RF	42" W x 24" D x 41" H	63.9	220	110	1774	1836	1898
						249	258	266

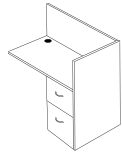

- Single key side locking File/File pedestal on right
- Grommet in top and modesty panel

	Model	Overall	Cu. Ft.	Shp. Wt.	Fr. Cls.	Zone 1	Zone 2	Zone 3
Reception Screen for Main	HW_710	72" W x 36" D x 14" H	33.6	150	70	1406	1455	1504
	HW_610	66" W x 36" D x 14" H	28.9	130	70	1359	1407	1454



- HW_710 fits 72" W desks
- HW_610 fits 66" W desks

	Model	Overall	Cu. Ft.	Shp. Wt.	Fr. Cls.	Zone 1	Zone 2	Zone 3
Left Return Reception Screen	HW_611L	42" W x 24" D x 13" H	1.5	27	100	311	322	333



- Fits 42" x 24" left returns
- Single key, side locking pedestal

	Model	Overall	Cu. Ft.	Shp. Wt.	Fr. Cls.	Zone 1	Zone 2	Zone 3
Right Return Reception Screen	HW_611R	42" W x 24" D x 13" H	1.5	27	100	311	322	333



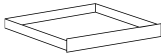

- Fits 42" x 24" right returns
- Single key, side locking pedestal

Center Drawers & Accessories

	Model	Overall	Cu. Ft.	Shp. Wt.	Fr. Cls.	Zone 1	Zone 2	Zone 3
Center Drawer 	HW_CD19	19.5" W x 18" D x 3" H	1.5	11	100	216	224	231
	HW_CD25	25.5" W x 18" D x 3" H	1.5	12	100	216	224	231
	HW_CD32	32" W x 18" D x 3" H	2.2	13	100	216	224	231
	HW_CD38	38" W x 18" D x 3" H	2.2	13	100	216	224	231
	<ul style="list-style-type: none"> •HW_CD19 fits 66" single pedestal units •HW_CD25 fits 48" & 72" single pedestal, 60" double pedestal units •HW_CD32 fits 66" double pedestal units •HW_CD38 fits 72" double pedestal units 							

	Model	Overall	Cu. Ft.	Shp. Wt.	Fr. Cls.	Zone 1	Zone 2	Zone 3
Pullout Keyboard Shelf 	HW_K25	25" W x 18" D x 3" H	2.0	15	100	249	258	266
	HW_K21	21" W x 18" D x 3" H	2.0	12	92.5	249	258	266
	HW_K29	29" W x 18" D x 3" H	2.0	17	92.5	249	258	266
	<ul style="list-style-type: none"> •HW_K21 fits 60" double pedestal units, 66" or 72" single pedestal units •HW_K25 fits 66" or 72" double pedestal units •HW_K29 fits 66" or 72" double pedestal units 							

	Model	Overall	Cu. Ft.	Shp. Wt.	Fr. Cls.	Zone 1	Zone 2	Zone 3
Wire Management Channel 	MDWM	12" W x 2.25" D x 1.25" H	0.4	3	70	37	38	40
	<ul style="list-style-type: none"> •Attaches under tops or to back panels •Peel and stick self-adhesive •Front opening for easy access 							

	Model	Overall	Cu. Ft.	Shp. Wt.	Fr. Cls.	Zone 1	Zone 2	Zone 3
Task Light 	TL2P	19.5" W x 3.25" D x 1.25" H	1.2	3	200	216	224	231
	<ul style="list-style-type: none"> •720 lumen, 8 watts •10' power cord 							

	Model	Overall	Cu. Ft.	Shp. Wt.	Fr. Cls.	Zone 1	Zone 2	Zone 3
Acrylic Privacy Screen 	XDAS48	48" W x 4" D x 8" H	2.0	16	N/A	634	656	678
	XDAS42	42" W x 4" D x 8" H	2.0	15	N/A	615	637	658
	XDAS36	36" W x 4" D x 8" H	1.0	15	N/A	597	618	639
	<ul style="list-style-type: none"> •Sits on work surface to add privacy •XDAS36 recommended for 60" W surfaces •XDAS42 recommended for 66" W surfaces •XDAS48 recommended for 72" W surfaces 							

Overhead Storage and Hutches

	Model	Overall	Cu. Ft.	Shp. Wt.	Fr. Cls.	Zone 1	Zone 2	Zone 3
Overhead Storage Unit, Aluminum Doors	HW_738AD	72" W x 16" D x 36.5" H	33.6	235	125	3254	3368	3482
					Task Light T	216	224	231

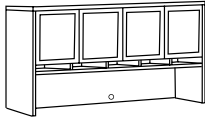

- 18.5" clearance to desk top surface
- Two storage compartments behind doors with paper storage slots underneath

	Model	Overall	Cu. Ft.	Shp. Wt.	Fr. Cls.	Zone 1	Zone 2	Zone 3
Overhead Storage Unit	H_7838	78" W x 16" D x 36.5" H	35.2	252	125	2333	2415	2496
	H_738	72" W x 16" D x 36.5" H	33.6	240	125	2227	2305	2383
	H_678	66" W x 16" D x 36.5" H	28.3	215	125	1863	1928	1993
	H_676	60" W x 16" D x 36.5" H	28.3	200	125	1839	1903	1968
	H_538	54" W x 16" D x 36.5" H	28.0	180	125	1816	1880	1943
					Task Light T	216	224	231
				Door Locks Y	190	190	190	

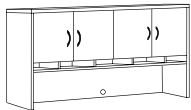

- 18.5" clearance to desk top surface
- Two storage compartments behind doors with paper storage slots underneath

	Model	Overall	Cu. Ft.	Shp. Wt.	Fr. Cls.	Zone 1	Zone 2	Zone 3
Overhead Storage Unit	H_478	48" W x 16" D x 36.5" H	24.3	183	125	1465	1516	1568
					Task Light T	216	224	231
					Door Locks Y	190	190	190

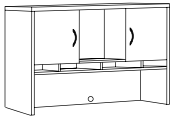

- 18.5" clearance to desk top surface
- One open compartment in center
- Two storage compartments behind doors with paper storage slots underneath

	Model	Overall	Cu. Ft.	Shp. Wt.	Fr. Cls.	Zone 1	Zone 2	Zone 3
Overhead Storage Unit	H_456	42" W x 16" D x 36.5" H	24.3	163	125	1360	1408	1455
	H_338	36" W x 16" D x 36.5" H	15.3	145	125	1313	1359	1405
	H_336	30" W x 16" D x 36.5" H	15.3	140	125	1236	1279	1323
					Task Light T	216	224	231
					Door Lock Y	95	95	95

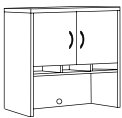

- 18.5" clearance to desk top surface
- Paper storage slots
- One storage compartment behind doors

	Model	Overall	Cu. Ft.	Shp. Wt.	Fr. Cls.	Zone 1	Zone 2	Zone 3
Overhead Storage Unit, Aluminum Doors	HW_737AD	72" W x 16" D x 36.5" H	33.6	220	125	2773	2870	2967
					Task Light T	216	224	231

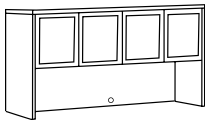

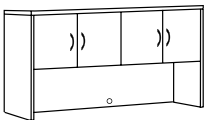

	Model	Overall	Cu. Ft.	Shp. Wt.	Fr. Cls.	Zone 1	Zone 2	Zone 3
Overhead Storage Unit	H_7837	78" W x 16" D x 36.5" H	35.2	235	125	1883	1949	2015
	H_737	Now 72" W x 16" D x 36.5" H	33.6	221	125	1748	1809	1870
	H_677	66" W x 16" D x 36.5" H	28.3	198	125	1388	1437	1485
	H_675	60" W x 16" D x 36.5" H	28.3	180	125	1367	1415	1463
	H_537	54" W x 16" D x 36.5" H	28.0	170	125	1356	1403	1451
					Task Light T	216	224	231
				Door Locks Y	190	190	190	

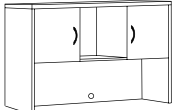

- NOW finish WC
- 18.5" clearance to desk top surface
- Two storage compartments behind doors

Hyperwork

	Model	Overall	Cu. Ft.	Shp. Wt.	Fr. Cls.	Zone 1	Zone 2	Zone 3
Overhead Storage Unit 	H_477	48" W x 16" D x 36.5" H	24.3	163	125	1110	1149	1188
						216	224	231
						190	190	190
		<ul style="list-style-type: none"> •18.5" clearance to desk top surface •Two storage compartments behind doors •One open compartment in center 						

	Model	Overall	Cu. Ft.	Shp. Wt.	Fr. Cls.	Zone 1	Zone 2	Zone 3
Overhead Storage Unit 	H_455	42" W x 16" D x 36.5" H	24.3	143	125	1005	1040	1075
	H_337	36" W x 16" D x 36.5" H	15.3	125	125	961	995	1028
	H_335	30" W x 16" D x 36.5" H	15.3	120	125	884	915	946
						216	224	231
					95	95	95	

	Model	Overall	Cu. Ft.	Shp. Wt.	Fr. Cls.	Zone 1	Zone 2	Zone 3
Reception Organizer 	HW_4818	48" W x 18" D x 14" H	12.0	50	125	1056	1093	1130

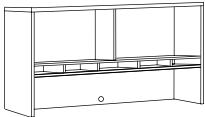
	Model	Overall	Cu. Ft.	Shp. Wt.	Fr. Cls.	Zone 1	Zone 2	Zone 3
Open Overhead Storage Unit 	HW_7818	78" W x 16" D x 36.5" H	35.2	221	125	2029	2100	2171
	HW_718	72" W x 16" D x 36.5" H	33.6	200	125	1965	2034	2103
	HW_618	66" W x 16" D x 36.5" H	28.3	178	125	1437	1487	1538
	HW_616	60" W x 16" D x 36.5" H	28.3	160	125	1400	1449	1498
	HW_518	54" W x 16" D x 36.5" H	26.2	160	125	1388	1437	1485
						216	224	231
		<ul style="list-style-type: none"> •18.5" clearance to desk top surface •Two open compartments with paper storage slots underneath •Grommet in lower back panel 						

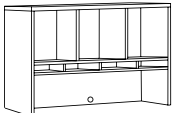
	Model	Overall	Cu. Ft.	Shp. Wt.	Fr. Cls.	Zone 1	Zone 2	Zone 3
Open Overhead Storage Unit 	HW_418	48" W x 16" D x 36.5" H	24.3	158	125	1198	1240	1282
						216	224	231
		<ul style="list-style-type: none"> •18.5" clearance to desk top surface •Three open compartments with paper storage slots underneath •Grommet in lower back panel 						

	Model	Overall	Cu. Ft.	Shp. Wt.	Fr. Cls.	Zone 1	Zone 2	Zone 3
Open Overhead Storage Unit 	HW_416	42" W x 16" D x 36.5" H	24.3	140	125	1095	1133	1172
	HW_318	36" W x 16" D x 36.5" H	15.3	125	125	1075	1113	1150
	HW_316	30" W x 16" D x 36.5" H	15.3	120	125	1055	1092	1129
						216	224	231
		<ul style="list-style-type: none"> •18.5" clearance to desk top surface •One open compartment with paper storage slots underneath •Grommet in lower back panel 						

	Model	Overall	Cu. Ft.	Shp. Wt.	Fr. Cls.	Zone 1	Zone 2	Zone 3
Open Overhead Storageet	HW_7817	78" W x 16" D x 36.5" H	35.2	206	125	1700	1760	1819
	HW_717 NOW	72" W x 16" D x 36.5" H	33.6	181	125	1490	1542	1594
	HW_617	66" W x 16" D x 36.5" H	28.3	158	125	970	1004	1038
	HW_615	60" W x 16" D x 36.5" H	28.3	140	125	938	971	1004
	HW_517	54" W x 16" D x 36.5" H	26.0	138	125	924	956	989
	Task Light T						216	224

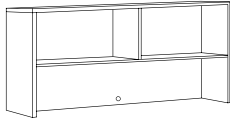

- NOW finish WC
- 21" clearance to desk top surface
- Grommet in lower back panel
- Two open compartments

	Model	Overall	Cu. Ft.	Shp. Wt.	Fr. Cls.	Zone 1	Zone 2	Zone 3
Open Overhead Storage	HW_417	48" W x 16" D x 36.5" H	24.3	138	125	849	879	908
	Task Light T						216	224

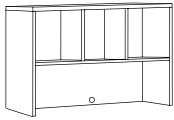

- 21" clearance to desk top surface
- Grommet in lower back panel
- Three open compartments

	Model	Overall	Cu. Ft.	Shp. Wt.	Fr. Cls.	Zone 1	Zone 2	Zone 3
Open Overhead Storage	HW_415	42" W x 16" D x 36.5" H	24.3	123	125	748	774	800
	HW_317	36" W x 16" D x 36.5" H	15.3	105	125	727	752	778
	HW_315	30" W x 16" D x 36.5" H	15.3	100	125	706	731	755
	Task Light T						216	224

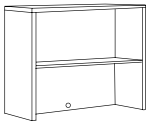

- 21" clearance to desk top surface
- Grommet in lower back panel
- One open compartment

	Model	Overall	Cu. Ft.	Shp. Wt.	Fr. Cls.	Zone 1	Zone 2	Zone 3
Overhead Bookcase	HW_319	36" W x 16" D x 36.5" H	15.3	115	125	1017	1053	1088



- Fits H_346, H_735 or H_732
- Two adjustable shelves 1" thick

	Model	Overall	Cu. Ft.	Shp. Wt.	Fr. Cls.	Zone 1	Zone 2	Zone 3
Corner Hutch with Doors	H_CH7272	72" W x 72" D x 36.5" H	61.9	316	125	3384	3502	3621
	Task Light T						216	224

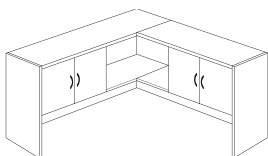

- 21" clearance to desk top surface
- 72" x 72" footprint
- Enclosed storage on right and left, open in center

Hyperwork

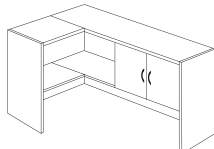
	Model	Overall	Cu. Ft.	Shp. Wt.	Fr. Cls.	Zone 1	Zone 2	Zone 3
Left Corner Hutch with Doors	H_<u>CH7236L</u>	72" W x 36" D x 36.5" H	45.2	253	125	2380	2463	2547
	H_<u>CH6636L</u>	66" W x 36" D x 36.5" H	39.9	223	125	2071	2143	2216
	Task Light T						216	224
	• 21" clearance to desk top surface	• CH7236 has 72" x 36" footprint	• CH6636 has 66" x 36" footprint	• Enclosed storage on right, open in center				

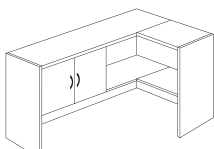
	Model	Overall	Cu. Ft.	Shp. Wt.	Fr. Cls.	Zone 1	Zone 2	Zone 3
Right Corner Hutch with Doors	H_<u>CH7236R</u>	72" W x 36" D x 36.5" H	45.2	253	125	2380	2463	2547
	H_<u>CH6636R</u>	66" W x 36" D x 36.5" H	39.9	223	125	2071	2143	2216
	Task Light T						216	224
	• 21" clearance to desk top surface	• CH7236 has 72" x 36" footprint	• CH6636 has 66" x 36" footprint	• Enclosed storage on left, open in center				

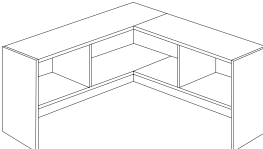
	Model	Overall	Cu. Ft.	Shp. Wt.	Fr. Cls.	Zone 1	Zone 2	Zone 3
Open Corner Hutch	HW_<u>CHO7272</u>	72" W x 72" D x 36.5" H	45.2	233	125	2946	3049	3152
	HW_<u>CHO4242</u>	42" W x 42" D x 36.5" H	35.9	180	125	1340	1387	1434
	HW_<u>CHO3636</u>	36" W x 36" D x 36.5" H	26.8	165	125	1249	1293	1336
	• 21" clearance to desk top surface	• Open storage compartments						
Task Light T						216	224	231

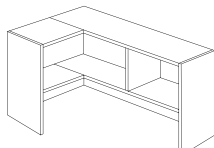
	Model	Overall	Cu. Ft.	Shp. Wt.	Fr. Cls.	Zone 1	Zone 2	Zone 3
Left Open Corner Hutch	HW_<u>CHO7236L</u>	72" W x 36" D x 36.5" H	45.2	233	125	1902	1969	2035
	HW_<u>CHO6636L</u>	66" W x 36" D x 36.5" H	39.9	203	125	1661	1719	1777
	Task Light T						216	224
	• 21" clearance to desk top surface	• Open storage compartments						

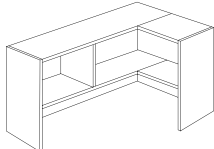
	Model	Overall	Cu. Ft.	Shp. Wt.	Fr. Cls.	Zone 1	Zone 2	Zone 3
Right Open Corner Hutch	HW_<u>CHO7236R</u>	72" W x 36" D x 36.5" H	45.2	233	125	1902	1969	2035
	HW_<u>CHO6636R</u>	66" W x 36" D x 36.5" H	39.9	203	125	1661	1719	1777
	Task Light T						216	224
	• 21" clearance to desk top surface	• Open storage compartments						

Overall		St. Ydg.	Cu. Ft.	Shp. Wt.	Fr. Cls.										
HWTB1478 14" H Tack Board		74.75" W x 0.5" D x 14" H	2	2.6	6	100									
	1	2/COM	3/COM	4	5	6	7	8	9	10	11	12/L	13	14	15/LL
Zone 1	313	331	356	374	391	417	443	470	492	525	552	587	623	651	686
Zone 2	324	343	368	387	405	432	459	486	509	543	571	608	645	674	710
Zone 3	335	354	381	400	418	446	474	503	526	562	591	628	667	697	734

• Fits 78" W overhead units



Overall		St. Ydg.	Cu. Ft.	Shp. Wt.	Fr. Cls.										
HWTB1472 14" H Tack Board		68.75" W x 0.5" D x 14" H	2	2.6	6	100									
	1	2/COM	3/COM	4	5	6	7	8	9	10	11	12/L	13	14	15/LL
Zone 1	313	331	356	374	391	417	443	470	492	525	552	587	623	651	686
Zone 2	324	343	368	387	405	432	459	486	509	543	571	608	645	674	710
Zone 3	335	354	381	400	418	446	474	503	526	562	591	628	667	697	734

• Fits 72" W overhead units



Overall		St. Ydg.	Cu. Ft.	Shp. Wt.	Fr. Cls.										
HWTB1466 14" H Tack Board		63.25" W x 0.5" D x 14" H	2	2.6	6	100									
	1	2/COM	3/COM	4	5	6	7	8	9	10	11	12/L	13	14	15/LL
Zone 1	313	331	356	374	391	417	443	470	492	525	552	587	623	651	686
Zone 2	324	343	368	387	405	432	459	486	509	543	571	608	645	674	710
Zone 3	335	354	381	400	418	446	474	503	526	562	591	628	667	697	734

• Fits 66" W overhead units



Overall		St. Ydg.	Cu. Ft.	Shp. Wt.	Fr. Cls.										
HWTB1460 14" H Tack Board		57.25" W x 0.5" D x 14" H	2	2.6	6	100									
	1	2/COM	3/COM	4	5	6	7	8	9	10	11	12/L	13	14	15/LL
Zone 1	313	331	356	374	391	417	443	470	492	525	552	587	623	651	686
Zone 2	324	343	368	387	405	432	459	486	509	543	571	608	645	674	710
Zone 3	335	354	381	400	418	446	474	503	526	562	591	628	667	697	734

• Fits 60" W overhead units



Overall		St. Ydg.	Cu. Ft.	Shp. Wt.	Fr. Cls.										
HWTB1454 14" H Tack Board		51.25" W x 0.5" D x 14" H	2	2.6	6	100									
	1	2/COM	3/COM	4	5	6	7	8	9	10	11	12/L	13	14	15/LL
Zone 1	313	331	356	374	391	417	443	470	492	525	552	587	623	651	686
Zone 2	324	343	368	387	405	432	459	486	509	543	571	608	645	674	710
Zone 3	335	354	381	400	418	446	474	503	526	562	591	628	667	697	734

• Fits 54" W overhead units



Hyperwork

Overall													St. Ydg.	Cu. Ft.	Shp. Wt.	Fr. Cls.
HWTB1448 45.25" W x 0.5" D x 14" H													2	2.6	6	100
14" H Tack Board																
	1	2/COM	3/COM	4	5	6	7	8	9	10	11	12/L	13	14	15/LL	
Zone 1	279	297	323	339	357	384	409	436	459	491	519	553	588	617	652	
Zone 2	289	307	334	351	369	397	423	451	475	508	537	572	609	639	675	
Zone 3	299	318	346	363	382	411	438	467	491	525	555	592	629	660	698	



• Fits 48" W overhead units

Overall													St. Ydg.	Cu. Ft.	Shp. Wt.	Fr. Cls.
HWTB1442 39.25" W x 0.5" D x 14" H													2	2.6	6	100
14" H Tack Board																
	1	2/COM	3/COM	4	5	6	7	8	9	10	11	12/L	13	14	15/LL	
Zone 1	279	297	323	339	357	384	409	436	459	491	519	553	588	617	652	
Zone 2	289	307	334	351	369	397	423	451	475	508	537	572	609	639	675	
Zone 3	299	318	346	363	382	411	438	467	491	525	555	592	629	660	698	



• Fits 42" W overhead units

Overall													St. Ydg.	Cu. Ft.	Shp. Wt.	Fr. Cls.
HWTB1436 33.25" W x 0.5" D x 14" H													2	2.6	6	100
14" H Tack Board																
	1	2/COM	3/COM	4	5	6	7	8	9	10	11	12/L	13	14	15/LL	
Zone 1	279	297	323	339	357	384	409	436	459	491	519	553	588	617	652	
Zone 2	289	307	334	351	369	397	423	451	475	508	537	572	609	639	675	
Zone 3	299	318	346	363	382	411	438	467	491	525	555	592	629	660	698	



• Fits 36" W overhead units

Overall													St. Ydg.	Cu. Ft.	Shp. Wt.	Fr. Cls.
HWTB1430 27.25" W x 0.5" D x 14" H													2	2.6	6	100
14" H Tack Board																
	1	2/COM	3/COM	4	5	6	7	8	9	10	11	12/L	13	14	15/LL	
Zone 1	279	297	323	339	357	384	409	436	459	491	519	553	588	617	652	
Zone 2	289	307	334	351	369	397	423	451	475	508	537	572	609	639	675	
Zone 3	299	318	346	363	382	411	438	467	491	525	555	592	629	660	698	



• Fits 30" W overhead units

Overall													St. Ydg.	Cu. Ft.	Shp. Wt.	Fr. Cls.
HWTB1424 21.25" W x 0.5" D x 14" H													2	2.6	6	100
14" H Tack Board																
	1	2/COM	3/COM	4	5	6	7	8	9	10	11	12/L	13	14	15/LL	
Zone 1	279	297	323	339	357	384	409	436	459	491	519	553	588	617	652	
Zone 2	289	307	334	351	369	397	423	451	475	508	537	572	609	639	675	
Zone 3	299	318	346	363	382	411	438	467	491	525	555	592	629	660	698	





• Fits 24" W overhead units

Storage & Filing

	Model	Overall	Cu. Ft.	Shp. Wt.	Fr. Cls.	Zone 1	Zone 2	Zone 3
Lateral File 	H_346 NOW	36.5" W x 24" D x 29" H	19.8	185	100	1432	1482	1532
	H_326	30.75" W x 20.75" D x 29" H	14.0	140	100	1344	1391	1438
			Heavy Duty Bottom H			202	202	202
	• NOW finish WC	• Two lateral file drawers	• Front central locking			• Anti-tilt counter weight		

	Model	Overall	Cu. Ft.	Shp. Wt.	Fr. Cls.	Zone 1	Zone 2	Zone 3
Lateral File 	H_3036 NOW	30.75" W x 20.75" D x 44.5" H	27.9	208	100	2653	2746	2839
			Heavy Duty Bottom H			303	303	303
	• NOW finish WC	• Three lateral file drawers	• Front central locking			• Anti-tilt mechanism allows only one drawer to open at one time to avoid tipping		

	Model	Overall	Cu. Ft.	Shp. Wt.	Fr. Cls.	Zone 1	Zone 2	Zone 3
Lateral File 	H_426 NOW	30.75" W x 20.75" D x 56.75" H	27.9	252	100	3044	3151	3257
			Heavy Duty Bottom H			404	404	404
	• NOW finish WC	• Four lateral file drawers	• Front central locking			• Anti-tilt mechanism allows only one drawer to open at one time to avoid tipping		

	Model	Overall	Cu. Ft.	Shp. Wt.	Fr. Cls.	Zone 1	Zone 2	Zone 3
Multi File Cabinet 	H_735	36.5" W x 24" D x 29" H	19.8	196	100	1696	1755	1815
			Heavy Duty Bottom H			101	101	101
	• Two box, one file drawer at top	• "Hot project" slot between top drawers	• Front locking lateral file drawer at bottom					

	Model	Overall	Cu. Ft.	Shp. Wt.	Fr. Cls.	Zone 1	Zone 2	Zone 3
Mobile Pedestal 	H_212BF	16" W x 22.25" D x 27.25" H	10.3	105	100	1247	1291	1334
			Heavy Duty Bottom H					
	• Box/Box/File drawers	• Letter/legal-size filing	• Single key front locking					

	Model	Overall	Cu. Ft.	Shp. Wt.	Fr. Cls.	Zone 1	Zone 2	Zone 3
Mobile Pedestal 	H_21F	16" W x 22.25" D x 27.25" H	7.0	85	100	1247	1291	1334
			Heavy Duty Bottom H					
	• File/File Drawers	• Letter/legal-size filing	• Single key front locking					

	Model	Overall	Cu. Ft.	Shp. Wt.	Fr. Cls.	Zone 1	Zone 2	Zone 3
Mobile Pedestal 	H_20	16" W x 22.25" D x 23.5" H	7.0	87	100	1134	1174	1213
			Heavy Duty Bottom H					
	• Box/File Drawers	• Letter/legal-size filing	• Single key front locking					

Hyperwork

	Model	Overall	Cu. Ft.	Shp. Wt.	Fr. Cls.	Zone 1	Zone 2	Zone 3
Two-Drawer Legal File	H_2DLF	19" W x 24" D x 29" H	12.2	111	100	1415	1465	1514

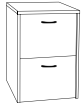

- File/File Drawers
- Legal-size filing
- Single key side locking

	Overall	St. Ydg.	Cu. Ft.	Shp. Wt.	Fr. Cls.
H_20S	16" W x 22.25" D x 23.5" H	N/A	7.0	87	100

Mobile Pedestal with Upholstered Top

Now



	1	2/COM	3/COM	4	5	6	7	8	9	10	11	12/L	13	14	15/LL
Zone 1	1417	1434	1461	1479	1495	1521	1547	1573	1596	1628	1657	1691	1727	1755	1789
Zone 2	1467	1484	1512	1531	1547	1574	1601	1628	1652	1685	1715	1750	1787	1816	1852
Zone 3	1516	1534	1563	1583	1600	1627	1655	1683	1708	1742	1773	1809	1848	1878	1914

	Model	Overall	Cu. Ft.	Shp. Wt.	Fr. Cls.	Zone 1	Zone 2	Zone 3
Open Pedestal	HW_36B-O	36" W x 24" D x 21" H	12.5	103	100	1288	1333	1378

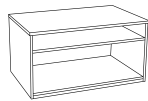

- Open lower storage area 12.5" H

	Model	Overall	Cu. Ft.	Shp. Wt.	Fr. Cls.	Zone 1	Zone 2	Zone 3
Open Pedestal, Project Drawer	H_36B-PD	36" W x 24" D x 21" H	12.5	114	100	1317	1363	1409



- Open lower storage area 12.5" H

	Model	Overall	Cu. Ft.	Shp. Wt.	Fr. Cls.	Zone 1	Zone 2	Zone 3
Pedestal, Project Drawer, Storage Drawer	H_36B-PDD	36" W x 24" D x 21" H	12.5	121	100	1580	1635	1691



	Model	Overall	Cu. Ft.	Shp. Wt.	Fr. Cls.	Zone 1	Zone 2	Zone 3
Pedestal, Project Drawer, Lateral File Drawer	H_36B-PDFD	36" W x 24" D x 21" H	12.5	136	100	1753	1814	1876



Heavy Duty Bottom **H** **101** **101** **101**

	Overall	St. Ydg.	Cu. Ft.	Shp. Wt.	Fr. Cls.
H36	36" W x 24" D x 2.5" H	1.75	4.5	6	100

Seat Cushion

Now



	1	2/COM	3/COM	4	5	6	7	8	9	10	11	12/L	13	14	15/LL
Zone 1	431	462	507	538	568	614	659	705	744	800	851	912	972	1023	1083
Zone 2	446	478	525	557	588	635	682	730	770	828	881	944	1006	1059	1121
Zone 3	461	494	542	576	608	657	705	754	796	856	911	976	1040	1095	1159

- Fits all H_36 pedestals above

Bookcases

	Model	Overall	Cu. Ft.	Shp. Wt.	Fr. Cls.	Zone 1	Zone 2	Zone 3
Bookcase	HW_36	36" W x 12" D x 36" H	13.0	85	125	820	849	877
	HW_48	36" W x 12" D x 48" H	16.8	107	125	870	900	931
	HW_60	36" W x 12" D x 60" H	21.0	121	125	1196	1238	1280
	HW_72	36" W x 12" D x 72" H	24.7	149	125	1358	1406	1453
	HW_84	36" W x 12" D x 84" H	29.0	178	125	1453	1504	1555

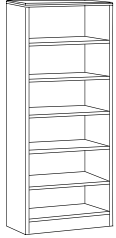

- Fixed bottom shelf on all sizes
- One (1) adjustable 1" thick shelves in HW_36
- Two (2) adjustable 1" thick shelves in HW_48
- Three (3) adjustable 1" thick shelves in HW_60
- Four (4) adjustable 1" thick shelves in HW_72
- Five (5) adjustable 1" thick shelves in HW_84

	Model	Overall	Cu. Ft.	Shp. Wt.	Fr. Cls.	Zone 1	Zone 2	Zone 3
Bookcase	HW_65 NOW	36" W x 16" D x 65.5" H	31.8	205	125	1262	1306	1350

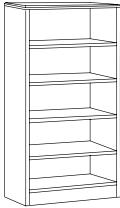

- NOW finish WC
- Fixed 1" thick bottom and middle shelves
- Three (3) adjustable shelves
- Finished back panel for use as room divider

	Model	Overall	Cu. Ft.	Shp. Wt.	Fr. Cls.	Zone 1	Zone 2	Zone 3
Two Door Bookcase	H_652D	36" W x 16" D x 65.5" H	31.8	222	125	1639	1696	1754



- One fixed, two adjustable shelves above doors
- One fixed, one adjustable shelf behind doors

	Model	Overall	Cu. Ft.	Shp. Wt.	Fr. Cls.	Zone 1	Zone 2	Zone 3
Corner Bookcase	HW_CB65	24" W x 24" D x 65.5" H	31.6	182	125	1554	1608	1663

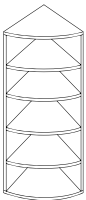

- Height matches adjacent Overhead Storage unit on work surface
- Four adjustable shelves 1" thick

	Model	Overall	Cu. Ft.	Shp. Wt.	Fr. Cls.	Zone 1	Zone 2	Zone 3
Corner Bookcase	HW_CB29	24" W x 24" D x 29" H	19.4	115	125	956	989	1023

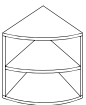

- Height matches adjacent 24" deep units
- One adjustable shelf 1" thick

	Model	Overall	Cu. Ft.	Shp. Wt.	Fr. Cls.	Zone 1	Zone 2	Zone 3
Corner Bookcase	HW_CB2930	30" W x 30" D x 29" H	19.4	140	125	1144	1184	1224

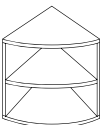

- Height matches adjacent 30" deep units
- One adjustable shelf 1" thick

Hyperwork

Storage & Meeting Accessories

	Model	Overall	Cu. Ft.	Shp. Wt.	Fr. Cls.	Zone 1	Zone 2	Zone 3
Mobile Audio/Visual Cabinet	H_65AV	36.5" W x 24" D x 65.5" H	43.1	326	125	3629	3756	3883

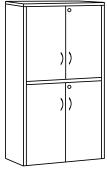

	Model	Overall	Cu. Ft.	Shp. Wt.	Fr. Cls.	Zone 1	Zone 2	Zone 3
Mobile Media Stand	HW_MMS	24" W x 24" D x 65.5" H	31.6	192	125	1802	1865	1928

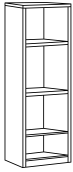

	Model	Overall	Cu. Ft.	Shp. Wt.	Fr. Cls.	Zone 1	Zone 2	Zone 3
Storage Cabinet	H_65STOR NOW	36.5" W x 24" D x 65.5" H	40.3	300	125	2432	2517	2602
					Heavy Duty Bottom H	202	202	202



- NOW finish WC
- Two locking lateral files at bottom
- Two adjustable shelves in upper compartment

	Model	Overall	Cu. Ft.	Shp. Wt.	Fr. Cls.	Zone 1	Zone 2	Zone 3
Wardrobe Cabinet	H_65WDL	24" W x 24" D x 65.5" H	31.6	130	125	1714	1774	1834
	H_65WDR	24" W x 24" D x 65.5" H	31.6	130	125	1714	1774	1834

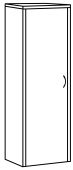

- H_65WDL door opens left
- H_65WDR door opens right
- Rod for hangers across top (side to side)
- Adjustable shelf at bottom

	Model	Overall	Cu. Ft.	Shp. Wt.	Fr. Cls.	Zone 1	Zone 2	Zone 3
3-in-1 Storage, Left	H_65TL	24" W x 24" D x 65.5" H	31.6	208	125	2141	2216	2291

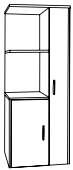

- Rod for hangers at top of full height enclosed storage
- One fixed, one adjustable shelf in top storage area
- One adjustable shelf in enclosed storage area

	Model	Overall	Cu. Ft.	Shp. Wt.	Fr. Cls.	Zone 1	Zone 2	Zone 3
3-in-1 Storage, Right	H_65TR	24" W x 24" D x 65.5" H	31.6	208	125	2141	2216	2291

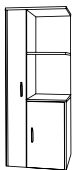

- Rod for hangers at top of full height enclosed storage
- One fixed, one adjustable shelf in top storage area
- One adjustable shelf in enclosed storage area

	Model	Overall	Cu. Ft.	Shp. Wt.	Fr. Cls.	Zone 1	Zone 2	Zone 3
Personal Tower, Left	H_65PTL	24" W x 24" D x 65.5" H	31.6	255	125	2640	2732	2825
	H_65PTL2BF	24" W x 24" D x 65.5" H	31.8	255	125	2791	2889	2986

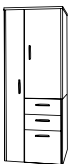

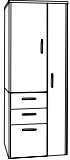

- Rod for hangers on left
- One fixed, two adjustable shelves in top storage area
- Box/Box/File drawers in H_65PTL2BF
- File/File drawers in H_65PTL

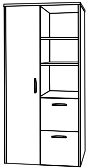
	Model	Overall	Cu. Ft.	Shp. Wt.	Fr. Cls.	Zone 1	Zone 2	Zone 3
Personal Tower, Right	H_65PTR	24" W x 24" D x 65.5" H	31.6	255	125	2640	2732	2825
	H_65PTR2BF	24" W x 24" D x 65.5" H	31.8	255	125	2791	2889	2986
	• Rod for hangers on right	• One fixed, two adjustable shelves in top storage area	• Box/Box/File drawers in H_65PTR2BF	• File/File drawers in H_65PTR				

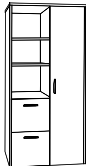
	Model	Overall	Cu. Ft.	Shp. Wt.	Fr. Cls.	Zone 1	Zone 2	Zone 3
Full-Size Personal Tower, Left	H_65PTLS	30" W x 24" D x 65.5" H	31.6	262	125	2793	2891	2989
	H_65PTL2BFS	30" W x 24" D x 65.5" H	31.8	262	125	2946	3049	3152
	• Rod for hangers on left	• One fixed, two adjustable shelves in top storage area	• Box/Box/File drawers in H_65PTL2BFS	• File/File drawers in H_65PTLS				

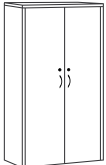
	Model	Overall	Cu. Ft.	Shp. Wt.	Fr. Cls.	Zone 1	Zone 2	Zone 3
Full-Size Personal Tower, Right	H_65PTRS	30" W x 24" D x 65.5" H	31.6	262	125	2793	2891	2989
	H_65PTR2BFS	30" W x 24" D x 65.5" H	31.8	262	125	2946	3049	3152
	• Rod for hangers on right	• One fixed, two adjustable shelves in top storage area	• Box/Box/File drawers in H_65PTR2BFS	• File/File drawers in H_65PTRS				

	Model	Overall	Cu. Ft.	Shp. Wt.	Fr. Cls.	Zone 1	Zone 2	Zone 3
Wardrobe/Storage Cabinet	H_65DWD	36.5" W x 24" D x 65.5" H	40.3	350	125	2904	3006	3107
	• Rod for hangers in left compartment	• Four adjustable shelves in right compartment	• .75" thick shelves					

	Model	Overall	Cu. Ft.	Shp. Wt.	Fr. Cls.	Zone 1	Zone 2	Zone 3
Storage Cabinet	H_65DS	36.5" W x 24" D x 65.5" H	40.3	300	125	2754	2850	2947
	• Adjustable floor glides	• Four adjustable shelves	• 1" thick shelves					

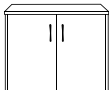
	Model	Overall	Cu. Ft.	Shp. Wt.	Fr. Cls.	Zone 1	Zone 2	Zone 3
Storage Cabinet	H_732	36.5" W x 24" D x 29" H	19.2	133	100	1300	1346	1391
	• Adjustable floor glides	• One adjustable shelf	• Hinged doors	• Inside dimensions 34" W x 21" D x 25" H				

Wall Mount Cabinets

	Model	Overall	Cu. Ft.	Shp. Wt.	Fr. Cls.	Zone 1	Zone 2	Zone 3
Wall Mount Cabinet, Open 	H_30WM	30" W x 15.75" D x 16.5" H	7.6	48	125	784	811	839
	H_36WM	36" W x 15.75" D x 16.5" H	8.3	55	125	931	964	996
	• One open storage compartment	• Includes mounting cleat	• Must be secured to wall studs					

	Model	Overall	Cu. Ft.	Shp. Wt.	Fr. Cls.	Zone 1	Zone 2	Zone 3
Wall Mount Cabinet, Open 	H_42WM	42" W x 15.75" D x 16.5" H	10.4	63	125	1031	1067	1103
	H_48WM	48" W x 15.75" D x 16.5" H	11.8	70	125	1119	1158	1197
	H_54WM	54" W x 15.75" D x 16.5" H	13.2	77	125	1220	1263	1305
	H_60WM	60" W x 15.75" D x 16.5" H	14.6	96	125	1302	1348	1393
	H_66WM	66" W x 15.75" D x 16.5" H	16.0	103	125	1433	1483	1533
	H_72WM	72" W x 15.75" D x 16.5" H	17.4	110	125	1512	1565	1618
	• Two open storage compartments	• Includes mounting cleat	• Must be secured to wall studs					

	Model	Overall	Cu. Ft.	Shp. Wt.	Fr. Cls.	Zone 1	Zone 2	Zone 3
Wall Mount Cabinet, Two Doors 	H_30WMS	30" W x 16.5" D x 16.5" H	7.6	68	125	902	934	965
	H_36WMS	36" W x 16.5" D x 16.5" H	8.3	76	125	1088	1126	1164
	H_42WMS	42" W x 16.5" D x 16.5" H	10.4	85	125	1212	1254	1297
	• One storage compartment	• No pulls	• Includes mounting cleat		• Must be secured to wall studs			

	Model	Overall	Cu. Ft.	Shp. Wt.	Fr. Cls.	Zone 1	Zone 2	Zone 3
Wall Mount Cabinet, Three Doors 	H_48WMSL	48" W x 16.5" D x 16.5" H	11.8	102	125	1310	1356	1402
	H_54WMSL	54" W x 16.5" D x 16.5" H	13.2	110	125	1383	1431	1480
	• Two storage compartments	• No pulls	• Two left hinged, one right hinged doors		• Includes mounting cleat			

	Model	Overall	Cu. Ft.	Shp. Wt.	Fr. Cls.	Zone 1	Zone 2	Zone 3
Wall Mount Cabinet, Three Doors 	H_48WMSR	48" W x 16.5" D x 16.5" H	11.8	102	125	1310	1356	1402
	H_54WMSR	54" W x 16.5" D x 16.5" H	13.2	110	125	1383	1431	1480
	• Two storage compartments	• No pulls	• Two right hinged, one left hinged doors		• Includes mounting cleat, must be secured to wall studs			

	Model	Overall	Cu. Ft.	Shp. Wt.	Fr. Cls.	Zone 1	Zone 2	Zone 3
Wall Mount Cabinet, Four Doors	H_60WMS	60" W x 24" D x 16.5" H	14.6	126	125	1485	1537	1589
	H_66WMS	66" W x 24" D x 16.5" H	16.0	135	125	1658	1716	1774
	H_72WMS	72" W x 24" D x 16.5" H	17.4	150	125	1746	1807	1868
	<ul style="list-style-type: none"> • Two storage compartments • No pulls 		<ul style="list-style-type: none"> • Includes mounting cleat 		<ul style="list-style-type: none"> • Must be secured to wall studs 			

	Model	Overall	Cu. Ft.	Shp. Wt.	Fr. Cls.	Zone 1	Zone 2	Zone 3
Wall Mount Cabinet, Two Doors, Pulls	H_30WMS	30" W x 16.5" D x 16.5" H	7.6	69	125	952	985	1019
	H_36WMS	36" W x 16.5" D x 16.5" H	8.3	77	125	1136	1176	1216
	H_42WMS	42" W x 16.5" D x 16.5" H	10.4	86	125	1262	1306	1350
	<ul style="list-style-type: none"> • One storage compartment • Two doors with pulls 		<ul style="list-style-type: none"> • Includes mounting cleat 		<ul style="list-style-type: none"> • Must be secured to wall studs 			

	Model	Overall	Cu. Ft.	Shp. Wt.	Fr. Cls.	Zone 1	Zone 2	Zone 3
Wall Mount Cabinet, Three Doors, Pulls	H_48WMSL	48" W x 16.5" D x 16.5" H	11.8	103	125	1384	1432	1481
	H_54WMSL	54" W x 16.5" D x 16.5" H	13.2	111	125	1458	1509	1560
	<ul style="list-style-type: none"> • Two storage compartments • Two left hinged, one right hinged doors 		<ul style="list-style-type: none"> • Includes mounting cleat 		<ul style="list-style-type: none"> • Must be secured to wall studs 			

	Model	Overall	Cu. Ft.	Shp. Wt.	Fr. Cls.	Zone 1	Zone 2	Zone 3
Wall Mount Cabinet, Three Doors, Pulls	H_48WMSR	48" W x 16.5" D x 16.5" H	11.8	103	125	1384	1432	1481
	H_54WMSR	54" W x 16.5" D x 16.5" H	13.2	111	125	1458	1509	1560
	<ul style="list-style-type: none"> • Two storage compartments • Two right hinged, one left hinged doors 		<ul style="list-style-type: none"> • Includes mounting cleat 		<ul style="list-style-type: none"> • Must be secured to wall studs 			

	Model	Overall	Cu. Ft.	Shp. Wt.	Fr. Cls.	Zone 1	Zone 2	Zone 3
Wall Mount Cabinet, Four Doors, Pulls	H_60WMS	60" W x 16.5" D x 16.5" H	14.6	127	125	1583	1638	1694
	H_66WMS	66" W x 16.5" D x 16.5" H	16.0	136	125	1756	1817	1879
	H_72WMS	72" W x 16.5" D x 16.5" H	17.4	151	125	1845	1910	1974
	<ul style="list-style-type: none"> • Two storage compartments • Four doors with pulls 		<ul style="list-style-type: none"> • Includes mounting cleat 		<ul style="list-style-type: none"> • Must be secured to wall studs 			



Hyperwork Education

CONTEMPORARY CASEGOODS - SIN 33712

Modular Storage for Education

Hyperwork Education provides modular storage furniture for the classroom. Cubby storage modules create storage and auxiliary seating within the K-3 classroom. They can also be adapted to the specific needs of individual classrooms by adding doors to conceal or secure personal items. Locker cabinets feature finished backs for a flexible and modular approach as room dividers. Mobile Bookcases available in either single-sided or double-sided shelf storage models bring book and media storage off the wall in libraries and media centers.

Tops

- 1" thick thermally fused laminate (TFL) surfaces on cabinets
- 1" thick thermally fused laminate (TFL) throughout on mobile bookcases
- .75" thick thermally fused laminate (TFL) surfaces on cubbies
- 3mm AdvantEdge PVC edge banding

Edge Profile



Finishes

- Thermally fused laminate on all surfaces
- Boardwalk, Driftwood and Shoreline are textured laminate

Cases & Cabinets

- .75"-thick core with thermally fused laminate on both sides
- 3mm AdvantEdge PVC edge banding
- Fully assembled with dowels, glue, metal brackets, screws and mechanical fasteners
- Drawer bottoms .125" thick rated to 25 lbs.
- Steel, ball-bearing slides on all drawers - ¾ extension on utility drawers, full extension on file drawers
- 6 total 2.5" diameter casters on mobile bookcases

Locks

- Optional locks are "keyed alike" as standard
- "Keyed different" locks are available at \$25 per lock. Contact HPFi Customer Service for custom option code per order

How to Specify:

- 1 Series
- 2 Pulls (where applicable)
- 3 Laminate finish
- 4 Model number
- 5 Options

Finished Example

H/E/DW/03106/Y

Finishes	Code
Black	E
Boardwalk	BW
Driftwood	DW
Espresso	X
Graphite	GP
Mahogany	M
Monticello Maple	MM
Natural Maple	FM
Shoreline	SL
Windsor Cherry	WC

Pulls	Code
Brushed Chrome	W
Ebony	E
Oval Nickel	D
Ribbon	R
Swoosh	S
T-Bar Nickel	V

Options	Code	Price
Locking Doors (per pair)	Y	95
Heavy Duty Lateral File Bottom	H	101
Additional Grommet	G	138

Power

PowerFlex power modules can be installed in many locations. See page 36 for options.

Cubby Storage

	Model	Overall	Cu. Ft.	Shp. Wt.	Fr. Cls.	Zone 1	Zone 2	Zone 3
--	-------	---------	---------	----------	----------	--------	--------	--------

1 x 1 Open Ottoman/
Cubby Storage



H_1-1	19" W x 20" D x 21.25" H	6.2	35	175	710	735	760
--------------	--------------------------	-----	----	-----	------------	------------	------------

- Single storage area
- Holds one 1517 ottoman
- Pre-bored for optional shelves

	Model	Overall	Cu. Ft.	Shp. Wt.	Fr. Cls.	Zone 1	Zone 2	Zone 3
--	-------	---------	---------	----------	----------	--------	--------	--------

1 x 2 Open Ottoman/
Cubby Storage



H_1-2	37" W x 20" D x 21.25" H	11.4	55	175	1008	1043	1079
--------------	--------------------------	------	----	-----	-------------	-------------	-------------

- Two storage areas
- Holds up to two 1517 ottomans
- Pre-bored for optional shelves

	Model	Overall	Cu. Ft.	Shp. Wt.	Fr. Cls.	Zone 1	Zone 2	Zone 3
--	-------	---------	---------	----------	----------	--------	--------	--------

1 x 3 Open Ottoman/
Cubby Storage



H_1-3	55" W x 20" D x 21.25" H	16.1	75	175	1195	1237	1279
--------------	--------------------------	------	----	-----	-------------	-------------	-------------

- Three storage areas
- Holds up to three 1517 ottomans
- Pre-bored for optional shelves

	Model	Overall	Cu. Ft.	Shp. Wt.	Fr. Cls.	Zone 1	Zone 2	Zone 3
--	-------	---------	---------	----------	----------	--------	--------	--------

2 x 1 Open Ottoman/
Cubby Storage



H_2-1	19" W x 20" D x 37.5" H	10.4	55	175	883	914	945
--------------	-------------------------	------	----	-----	------------	------------	------------

- Two storage areas
- Holds up to two 1517 ottomans
- Pre-bored for optional shelves

	Model	Overall	Cu. Ft.	Shp. Wt.	Fr. Cls.	Zone 1	Zone 2	Zone 3
--	-------	---------	---------	----------	----------	--------	--------	--------

2 x 2 Open Ottoman/
Cubby Storage



H_2-2	37" W x 20" D x 37.5" H	19.4	95	175	1287	1332	1377
--------------	-------------------------	------	----	-----	-------------	-------------	-------------

- Four storage areas
- Holds up to four 1517 ottomans
- Pre-bored for optional shelves

	Model	Overall	Cu. Ft.	Shp. Wt.	Fr. Cls.	Zone 1	Zone 2	Zone 3
--	-------	---------	---------	----------	----------	--------	--------	--------

2 x 3 Open Ottoman/
Cubby Storage



H_2-3	55" W x 20" D x 37.5" H	28.3	135	175	1587	1643	1698
--------------	-------------------------	------	-----	-----	-------------	-------------	-------------

- Six storage areas
- Holds up to six 1517 ottomans
- Pre-bored for optional shelves

Hyperwork Education

	Model	Overall	Cu. Ft.	Shp. Wt.	Fr. Cls.	Zone 1	Zone 2	Zone 3
3 x 1 Open Ottoman/ Cubby Storage	H_3-1	19" W x 20" D x 53.75" H	14.7	75	175	1035	1071	1107



- Three storage areas
- Holds up to three 1517 ottomans
- Pre-bored for optional shelves

	Model	Overall	Cu. Ft.	Shp. Wt.	Fr. Cls.	Zone 1	Zone 2	Zone 3
3 x 2 Open Ottoman/ Cubby Storage	H_3-2	37" W x 20" D x 53.75" H	27.3	135	175	1516	1569	1622



- Six storage areas
- Holds up to six 1517 ottomans
- Pre-bored for optional shelves

	Model	Overall	Cu. Ft.	Shp. Wt.	Fr. Cls.	Zone 1	Zone 2	Zone 3
3 x 3 Open Ottoman/ Cubby Storage	H_3-3	55" W x 20" D x 53.75" H	39.9	195	175	1932	2000	2067



- Nine storage areas
- Holds up to nine 1517 ottomans
- Pre-bored for optional shelves

	Model	Overall	Cu. Ft.	Shp. Wt.	Fr. Cls.	Zone 1	Zone 2	Zone 3
4 x 1 Open Ottoman/ Cubby Storage	H_4-1	19" W x 20" D x 70" H	19.2	120	175	1202	1244	1286



- Four storage areas
- Holds up to four 1517 ottomans
- Pre-bored for optional shelves

	Model	Overall	Cu. Ft.	Shp. Wt.	Fr. Cls.	Zone 1	Zone 2	Zone 3
4 x 2 Open Ottoman/ Cubby Storage	H_4-2	37" W x 20" D x 70" H	35.7	200	175	2013	2083	2154



- Eight storage areas
- Holds up to eight 1517 ottomans
- Pre-bored for optional shelves

Seat Cushions

Overall													St. Ydg.	Cu. Ft.	Shp. Wt.	Fr. Cls.			
XD2019 Seat Cushion													19" W x 20" D x 2.5" H	1	4.5	6	100		
NOW																			
	1	2/COM	3/COM	4	5	6	7	8	9	10	11	12/L	13	14	15/LL				
Zone 1	365	383	408	425	443	469	494	520	544	576	604	639	673	702	738				
Zone 2	378	396	422	440	459	485	511	538	563	596	625	661	697	727	764				
Zone 3	391	410	437	455	474	502	529	556	582	616	646	684	720	751	790				



- Fits on H_1-1
- Available in any fabric

Overall													St. Ydg.	Cu. Ft.	Shp. Wt.	Fr. Cls.			
XD2037 Seat Cushion													37" W x 20" D x 2.5" H	1.25	4	7	100		
NOW																			
	1	2/COM	3/COM	4	5	6	7	8	9	10	11	12/L	13	14	15/LL				
Zone 1	487	504	529	547	564	589	616	641	665	696	725	761	795	824	859				
Zone 2	504	522	548	566	584	610	638	663	688	720	750	788	823	853	889				
Zone 3	521	539	566	585	603	630	659	686	712	745	776	814	851	882	919				

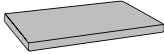

- Fits on H_1-2
- Available in any fabric

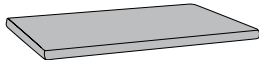

Overall													St. Ydg.	Cu. Ft.	Shp. Wt.	Fr. Cls.			
XD2055 Seat Cushion													55" W x 20" D x 2.5" H	1.75	5	14	100		
NOW																			
	1	2/COM	3/COM	4	5	6	7	8	9	10	11	12/L	13	14	15/LL				
Zone 1	607	625	651	668	686	712	738	763	787	818	848	882	916	946	981				
Zone 2	628	647	674	691	710	737	764	790	815	847	878	913	948	979	1015				
Zone 3	649	669	697	715	734	762	790	816	842	875	907	944	980	1012	1050				







- Fits on H_1-3
- Available in any fabric

Hyperwork Education

Lockers

	Model	Overall	Cu. Ft.	Shp. Wt.	Fr. Cls.	Zone 1	Zone 2	Zone 3
Single Locker	H_1L	19" W x 20" D x 53.75" H	10.4	95	100	940	973	1006
		<ul style="list-style-type: none"> Fixed shelf on top and bottom Two coat hooks 						
Double Locker	H_2L	37" W x 20" D x 53.75" H	19.4	175	100	1401	1450	1499
		<ul style="list-style-type: none"> Fixed shelf on top and bottom of each locker Two coat hooks in each locker 						
Triple Locker	H_3L	55" W x 20" D x 53.75" H	28.3	255	100	1759	1821	1882
		<ul style="list-style-type: none"> Fixed shelf on top and bottom of each locker Two coat hooks in each locker 						

Optional Accessories

	Model	Overall	Cu. Ft.	Shp. Wt.	Fr. Cls.	Zone 1	Zone 2	Zone 3
Single Height Door	H_1D	18.5" W x 0.75" D x 18.25" H	0.7	8	70	174	180	186
		<ul style="list-style-type: none"> Encloses single height cubby Includes hinges and pulls which can be installed for right or left orientation 						
					Door Locks Y	48	48	48
Double Height Door	H_2D	18.5" W x 0.75" D x 36.5" H	1.3	14	70	206	213	220
		<ul style="list-style-type: none"> Encloses double height cubby Includes hinges and pulls which can be installed for right or left orientation 						
					Door Locks Y	48	48	48
Triple Height Door	H_3D	18.5" W x 0.75" D x 48.75" H	2.0	22	70	307	318	328
		<ul style="list-style-type: none"> Encloses triple height cubby or lockers Includes hinges and pulls which can be installed for right or left orientation 						
					Door Locks Y	48	48	48
Adjustable Shelves	H_2S	17.125" W x 18" D x 0.75" H	0.6	12	70	216	224	231
		<ul style="list-style-type: none"> Two adjustable shelves and support pins Fits in all cubby openings 						

Multi-Carrels

	Model	Overall	Cu. Ft.	Shp. Wt.	Fr. Cls.	Zone 1	Zone 2	Zone 3
Freestanding Carrel	UWSC_3630	36" W x 30" D x 48" H	3.1	117	100	1097	1135	1174



- 1" thick TFL work surface is 34" W x 26" D, 29" from floor
- .75" thick TFL shelf is 34" W x 11" D, 42" from floor
- Adjustable level glides
- Assembly required

	Model	Overall	Cu. Ft.	Shp. Wt.	Fr. Cls.	Zone 1	Zone 2	Zone 3
Add-On Carrel	UWSC_3630A	35" W x 30" D x 48" H	3.1	89	100	907	939	970



- Must be attached to UWSC_3630
- 1" thick TFL work surface is 34" W x 26" D, 29" from floor
- .75" thick TFL shelf is 34" W x 11" D, 42" from floor
- Adjustable level glides
- Assembly required

Mobile Bookcases

	Model	Overall	Cu. Ft.	Shp. Wt.	Fr. Cls.	Zone 1	Zone 2	Zone 3
Single Side Bookcase Storage	HW_SSBK6048	60" W x 16" D x 48" H	28.7	162	125	3214	3326	3439



- Two adjustable shelves in each compartment
- Six casters, two locking

	Model	Overall	Cu. Ft.	Shp. Wt.	Fr. Cls.	Zone 1	Zone 2	Zone 3
Double Side Bookcase Storage	HW_DSBK6048	60" W x 24" D x 48" H	30.4	194	125	3867	4002	4138



- Two adjustable shelves in each compartment
- Six casters, two locking

Perimeter Storage Cabinets

	Model	Overall	Cu. Ft.	Shp. Wt.	Fr. Cls.	Zone 1	Zone 2	Zone 3
Open Storage 	H_01101	24" W x 24" D x 30" H	12.5	89	125	1046	1083	1119
	H_01102	24" W x 24" D x 36" H	14.9	93	125	1141	1181	1221
	H_01103	24" W x 30" D x 30" H	15.4	99	125	1108	1147	1186
	H_01104	24" W x 30" D x 36" H	18.3	105	175	1252	1296	1340
	H_01105	30" W x 24" D x 30" H	15.4	102	125	1111	1150	1189
	H_01106	30" W x 24" D x 36" H	18.3	102	175	1249	1293	1336
	H_01107	30" W x 30" D x 30" H	19.0	111	175	1242	1285	1329
	H_01108	30" W x 30" D x 36" H	22.5	120	175	1395	1444	1493
	H_01109	36" W x 24" D x 30" H	18.3	129	125	1154	1194	1235
	H_01110	36" W x 24" D x 36" H	21.7	137	125	1296	1341	1387
	H_01111	36" W x 30" D x 30" H	22.5	149	125	1304	1350	1395
	H_01112	36" W x 30" D x 36" H	26.7	159	175	1455	1506	1557
	H_01113	42" W x 24" D x 30" H	21.2	170	100	1512	1565	1618
	H_01114	42" W x 24" D x 36" H	25.2	179	125	1631	1688	1745
	H_01115	42" W x 30" D x 30" H	26.0	190	125	1544	1598	1652
	H_01116	42" W x 30" D x 36" H	31.0	201	125	1768	1830	1892
	H_01117	48" W x 24" D x 30" H	24.1	212	100	1571	1626	1681
	H_01118	48" W x 24" D x 36" H	28.6	225	125	1696	1755	1815
	H_01119	48" W x 30" D x 30" H	29.6	238	100	1607	1663	1719
	H_01120	48" W x 30" D x 36" H	35.2	263	125	1837	1901	1966

• One adjustable shelf in 30" H cabinets 24", 30" and 36" W

• Two adjustable shelves in 30" H cabinets 42" and 48" W

• Two adjustable shelves in 36" H cabinets 24", 30" and 36" W

• Four adjustable shelves in 36" H cabinets 42" and 48" W

	Model	Overall	Cu. Ft.	Shp. Wt.	Fr. Cls.	Zone 1	Zone 2	Zone 3
Enclosed Storage 	H_02101L	24" W x 24" D x 30" H	12.5	104	100	1195	1237	1279
	H_02101R	24" W x 24" D x 30" H	12.5	104	100	1195	1237	1279
	H_02102L	24" W x 24" D x 36" H	14.9	111	125	1289	1334	1379
	H_02102R	24" W x 24" D x 36" H	14.9	111	125	1289	1334	1379
	H_02103L	24" W x 30" D x 30" H	15.4	113	125	1258	1302	1346
	H_02103R	24" W x 30" D x 30" H	15.4	113	125	1258	1302	1346
	H_02104L	24" W x 30" D x 36" H	18.3	120	125	1402	1451	1500
	H_02104R	24" W x 30" D x 36" H	18.3	120	125	1402	1451	1500
	H_02105	30" W x 24" D x 30" H	15.4	138	125	1376	1424	1472
	H_02106	30" W x 24" D x 36" H	18.3	154	100	1523	1576	1630
	H_02107	30" W x 30" D x 30" H	19.0	156	125	1507	1560	1612
	H_02108	30" W x 30" D x 36" H	22.5	163	125	1670	1728	1787
	H_02109	36" W x 24" D x 30" H	18.3	178	100	1418	1468	1517
	H_02110	36" W x 24" D x 36" H	21.7	190	100	1591	1647	1702
	H_02111	36" W x 30" D x 30" H	22.5	206	100	1569	1624	1679
	H_02112	36" W x 30" D x 36" H	26.7	218	100	1752	1813	1875
	H_02113	42" W x 24" D x 30" H	21.2	234	92.5	1767	1829	1891
	H_02114	42" W x 24" D x 36" H	25.2	242	100	1910	1977	2044
	H_02115	42" W x 30" D x 30" H	26.0	243	100	1800	1863	1926
	H_02116	42" W x 30" D x 36" H	31.0	251	100	2047	2119	2190
H_02117	48" W x 24" D x 30" H	24.1	253	92.5	1855	1920	1985	
H_02118	48" W x 24" D x 36" H	28.6	259	100	2006	2076	2146	
H_02119	48" W x 30" D x 30" H	29.6	273	100	1891	1957	2023	
H_02120	48" W x 30" D x 36" H	35.2	283	100	2150	2225	2301	
			Optional Lock Y			48	48	48

• 24" W cabinets available with either left or right hinged single door

• One adjustable shelf in 30" H cabinets 24", 30" and 36" W, two in cabinets 42" and 48" W

• Two adjustable shelves in 36" H cabinets 24", 30" and 36" W, four in cabinets 42" and 48" W

Utility Drawer Storage



Model	Overall	Cu. Ft.	Shp. Wt.	Fr. Cls.	Zone 1	Zone 2	Zone 3
H_03101	24" W x 24" D x 30" H	12.5	116	100	1608	1664	1721
H_03102	24" W x 24" D x 36" H	14.9	123	100	1841	1905	1970
H_03103	24" W x 30" D x 30" H	15.4	136	100	1670	1728	1787
H_03104	24" W x 30" D x 36" H	18.3	142	125	1954	2022	2091
H_03105	30" W x 24" D x 30" H	15.4	169	92.5	1851	1916	1981
H_03106	30" W x 24" D x 36" H	18.3	173	100	2175	2251	2327
H_03107	30" W x 30" D x 30" H	19.0	180	100	1982	2051	2121
H_03108	30" W x 30" D x 36" H	22.5	189	100	2318	2399	2480
H_03109	36" W x 24" D x 30" H	18.3	203	82.5	2097	2170	2244
H_03110	36" W x 24" D x 36" H	21.7	208	100	2458	2544	2630
H_03111	36" W x 30" D x 30" H	22.5	213	100	2245	2324	2402
H_03112	36" W x 30" D x 36" H	26.7	220	100	2631	2723	2815
H_03113	42" W x 24" D x 30" H	21.1	228	92.5	2590	2681	2771
H_03114	42" W x 24" D x 36" H	25.2	237	100	2980	3084	3189
H_03115	42" W x 30" D x 30" H	26.0	246	100	2624	2716	2808
H_03116	42" W x 30" D x 36" H	31.0	258	100	3116	3225	3334
Optional Lock Y					48	48	48

•30" H cabinets include four utility drawers

•36" H cabinets include five utility drawers

Open Storage with Top Drawer(s)



Model	Overall	Cu. Ft.	Shp. Wt.	Fr. Cls.	Zone 1	Zone 2	Zone 3
H_04101	24" W x 24" D x 30" H	12.5	93	125	1187	1229	1270
H_04102	24" W x 24" D x 36" H	14.9	99	125	1279	1324	1369
H_04103	24" W x 30" D x 30" H	15.4	107	125	1248	1292	1335
H_04104	24" W x 30" D x 36" H	18.3	115	125	1250	1294	1338
H_04105	30" W x 24" D x 30" H	15.4	112	125	1296	1341	1387
H_04106	30" W x 24" D x 36" H	18.3	120	125	1434	1484	1534
H_04107	30" W x 30" D x 30" H	19.0	118	125	1428	1478	1528
H_04108	30" W x 30" D x 36" H	22.5	127	175	1579	1634	1690
H_04109	36" W x 24" D x 30" H	18.3	135	125	1390	1439	1487
H_04110	36" W x 24" D x 36" H	21.7	146	125	1531	1585	1638
H_04111	36" W x 30" D x 30" H	22.5	158	125	1540	1594	1648
H_04112	36" W x 30" D x 36" H	26.7	169	125	1639	1696	1754
H_04113	42" W x 24" D x 30" H	21.2	187	100	1780	1842	1905
H_04114	42" W x 24" D x 36" H	25.2	198	125	1901	1968	2034
H_04115	42" W x 30" D x 30" H	26.0	203	125	1781	1843	1906
H_04116	42" W x 30" D x 36" H	31.0	215	125	1768	1830	1892
Optional Lock Y					48	48	48

•One utility drawer, one adjustable shelf in 30" H cabinets 24", 30" and 36" W

•One utility drawer, two adjustable shelves in 36" H cabinets 24", 30" and 36" W

•One utility drawer, two adjustable shelves in 30" H cabinets 42" W

•One utility drawer, four adjustable shelves in 36" H cabinets 42" W

Hyperwork Education

	Model	Overall	Cu. Ft.	Shp. Wt.	Fr. Cls.	Zone 1	Zone 2	Zone 3
Enclosed Storage with Top Drawer(s)	H_05101L	24" W x 24" D x 30" H	12.5	101	100	1336	1383	1430
	H_05101R	24" W x 24" D x 30" H	12.5	101	100	1336	1383	1430
	H_05102L	24" W x 24" D x 36" H	14.9	107	125	1429	1479	1529
	H_05102R	24" W x 24" D x 36" H	14.9	107	125	1429	1479	1529
	H_05103L	24" W x 30" D x 30" H	15.4	118	125	1399	1448	1497
	H_05103R	24" W x 30" D x 30" H	15.4	118	125	1399	1448	1497
	H_05104L	24" W x 30" D x 36" H	18.3	127	125	1543	1597	1651
	H_05104R	24" W x 30" D x 36" H	18.3	127	125	1543	1597	1651
	H_05105	30" W x 24" D x 30" H	15.4	131	100	1560	1615	1669
	H_05106	30" W x 24" D x 36" H	18.3	136	125	1710	1770	1830
	H_05107	30" W x 30" D x 30" H	19.0	141	125	1693	1752	1812
	H_05108	30" W x 30" D x 36" H	22.5	173	125	1854	1919	1984
	H_05109	36" W x 24" D x 30" H	18.3	156	100	1654	1712	1770
	H_05110	36" W x 24" D x 36" H	21.7	162	125	1827	1891	1955
	H_05111	36" W x 30" D x 30" H	22.5	173	125	1803	1866	1929
	H_05112	36" W x 30" D x 36" H	26.7	180	125	1985	2054	2124
	H_05113	42" W x 24" D x 30" H	21.2	199	92.5	2037	2108	2180
H_05114	42" W x 24" D x 36" H	25.2	213	100	2180	2256	2333	
H_05115	42" W x 30" D x 30" H	26.0	220	100	2070	2142	2215	
H_05116	42" W x 30" D x 36" H	31.0	231	125	2317	2398	2479	
			Optional Lock Y			95	95	95

•One utility drawer, one adjustable shelf in 30" H cabinets 24", 30" and 36" W
 •One utility drawer, two adjustable shelves in 36" H cabinets 24", 30" and 36" W
 •One utility drawer, two adjustable shelves in 30" H cabinets 42" W
 •One utility drawer, four adjustable shelves in 36" H cabinets 42" W



	Model	Overall	Cu. Ft.	Shp. Wt.	Fr. Cls.	Zone 1	Zone 2	Zone 3
File Drawer Storage	H_06105	30" W x 24" D x 30" H	15.4	138	100	1810	1873	1937
	H_06106	30" W x 24" D x 36" H	18.3	142	125	1948	2016	2084
	H_06107	30" W x 30" D x 30" H	19.0	148	125	1941	2009	2077
	H_06108	30" W x 30" D x 36" H	22.5	153	125	2092	2165	2238
			Optional Lock Y			95	95	95

•Four standard file drawers in all models



	Model	Overall	Cu. Ft.	Shp. Wt.	Fr. Cls.	Zone 1	Zone 2	Zone 3
Lateral File Drawer Storage	H_07105	30" W x 24" D x 30" H	15.4	143	100	1619	1676	1732
	H_07106	30" W x 24" D x 36" H	18.3	148	100	1757	1818	1880
	H_07107	30" W x 30" D x 30" H	19.0	153	100	1752	1813	1875
	H_07108	30" W x 30" D x 36" H	22.5	158	125	1903	1970	2036
	H_07109	36" W x 24" D x 30" H	18.3	167	100	1765	1827	1889
	H_07110	36" W x 24" D x 36" H	21.7	173	125	1904	1971	2037
	H_07111	36" W x 30" D x 30" H	22.5	185	100	1912	1979	2046
	H_07112	36" W x 30" D x 36" H	26.7	191	125	2064	2136	2208
			Optional Lock Y			48	48	48

•Two lateral file drawers in all models



Open Left, Drawers
Right Storage



Model	Overall	Cu. Ft.	Shp. Wt.	Fr. Cls.	Zone 1	Zone 2	Zone 3
H_08105	30" W x 24" D x 30" H	15.4	175	92.5	1757	1818	1880
H_08106	30" W x 24" D x 36" H	18.3	186	92.5	2065	2137	2210
H_08107	30" W x 30" D x 30" H	19.0	191	92.5	1884	1950	2016
H_08108	30" W x 30" D x 36" H	22.5	198	100	2204	2281	2358
H_08109	36" W x 24" D x 30" H	18.3	203	92.5	1992	2062	2131
H_08110	36" W x 24" D x 36" H	21.7	211	100	2348	2430	2512
H_08111	36" W x 30" D x 30" H	22.5	216	100	2134	2209	2283
H_08112	36" W x 30" D x 36" H	26.7	220	100	2499	2586	2674
H_08113	42" W x 24" D x 30" H	21.2	224	92.5	2459	2545	2631
H_08114	42" W x 24" D x 36" H	25.2	229	100	2830	2929	3028
H_08115	42" W x 30" D x 30" H	26.0	235	100	2492	2579	2666
H_08116	42" W x 30" D x 36" H	31.0	240	125	2960	3064	3167
H_08117	48" W x 24" D x 30" H	24.1	247	92.5	2584	2674	2765
H_08118	48" W x 24" D x 36" H	28.6	251	100	2972	3076	3180
H_08119	48" W x 30" D x 30" H	29.6	254	100	2617	2709	2800
H_08120	48" W x 30" D x 36" H	35.2	261	125	3109	3218	3327
				Optional Lock Y	48	48	48

•30" H cabinets include one adjustable shelf and four utility drawers

•36" H cabinets include two adjustable shelves and five utility drawers

Enclosed Left, Drawers
Right Storage



Model	Overall	Cu. Ft.	Shp. Wt.	Fr. Cls.	Zone 1	Zone 2	Zone 3
H_09105	30" W x 24" D x 30" H	15.4	182	92.5	1944	2012	2080
H_09106	30" W x 24" D x 36" H	18.3	193	92.5	2283	2363	2443
H_09107	30" W x 30" D x 30" H	19.0	201	92.5	2083	2156	2229
H_09108	30" W x 30" D x 36" H	22.5	213	100	2435	2520	2605
H_09109	36" W x 24" D x 30" H	18.3	220	85	2201	2278	2355
H_09110	36" W x 24" D x 36" H	21.7	233	92.5	2595	2686	2777
H_09111	36" W x 30" D x 30" H	22.5	240	92.5	2359	2442	2524
H_09112	36" W x 30" D x 36" H	26.7	248	100	2763	2860	2956
H_09113	42" W x 24" D x 30" H	21.2	252	92.5	2719	2814	2909
H_09114	42" W x 24" D x 36" H	25.2	260	92.5	3130	3240	3349
H_09115	42" W x 30" D x 30" H	26.0	270	92.5	2757	2853	2950
H_09116	42" W x 30" D x 36" H	31.0	276	100	3273	3388	3502
H_09117	48" W x 24" D x 30" H	24.1	288	92.5	2856	2956	3056
H_09118	48" W x 24" D x 36" H	28.6	295	92.5	3285	3400	3515
H_09119	48" W x 30" D x 30" H	29.6	307	92.5	2894	2995	3097
H_09120	48" W x 30" D x 36" H	35.2	312	100	3437	3557	3678
				Optional Lock Y	95	95	95

•30" H cabinets include one adjustable shelf and four utility drawers

•36" H cabinets include two adjustable shelves and five utility drawers

Hyperwork Education

Open Storage with Top Drawers



Model	Overall	Cu. Ft.	Shp. Wt.	Fr. Cls.	Zone 1	Zone 2	Zone 3
H_10105	30" W x 24" D x 30" H	15.4	115	100	1582	1637	1693
H_10106	30" W x 24" D x 36" H	18.3	126	100	1858	1923	1988
H_10107	30" W x 30" D x 30" H	19.0	131	100	1696	1755	1815
H_10108	30" W x 30" D x 36" H	22.5	140	125	1982	2051	2121
H_10109	36" W x 24" D x 30" H	18.3	149	100	1791	1854	1916
H_10110	36" W x 24" D x 36" H	21.7	153	100	2115	2189	2263
H_10111	36" W x 30" D x 30" H	22.5	166	100	1921	1988	2055
H_10112	36" W x 30" D x 36" H	26.7	178	125	2251	2330	2409
H_10113	42" W x 24" D x 30" H	21.2	190	100	2213	2290	2368
H_10114	42" W x 24" D x 36" H	25.2	202	100	2547	2636	2725
H_10115	42" W x 30" D x 30" H	26.0	212	100	2244	2323	2401
H_10116	42" W x 30" D x 36" H	31.0	221	100	2665	2758	2852
H_10117	48" W x 24" D x 30" H	24.1	230	92.5	2303	2384	2464
H_10118	48" W x 24" D x 36" H	28.6	241	100	2649	2742	2834
H_10119	48" W x 30" D x 30" H	29.6	248	100	2334	2416	2497
H_10120	48" W x 30" D x 36" H	35.2	267	125	2771	2868	2965
	Optional Lock Y				48	48	48

•30" H cabinets include one full-width adjustable shelf

•36" H cabinets include two full-width adjustable shelves

•Two utility drawers

Enclosed Storage with Top Drawers



Model	Overall	Cu. Ft.	Shp. Wt.	Fr. Cls.	Zone 1	Zone 2	Zone 3
H_11105	30" W x 24" D x 30" H	15.4	122	125	1749	1810	1871
H_11106	30" W x 24" D x 36" H	18.3	133	125	2056	2128	2200
H_11107	30" W x 30" D x 30" H	19.0	142	125	1873	1939	2004
H_11108	30" W x 30" D x 36" H	22.5	159	125	2193	2270	2347
H_11109	36" W x 24" D x 30" H	18.3	170	100	1981	2050	2120
H_11110	36" W x 24" D x 36" H	21.7	183	100	2336	2418	2500
H_11111	36" W x 30" D x 30" H	22.5	198	100	2122	2196	2271
H_11112	36" W x 30" D x 36" H	26.7	205	125	2487	2574	2661
H_11113	42" W x 24" D x 30" H	21.2	211	100	2449	2535	2620
H_11114	42" W x 24" D x 36" H	25.2	221	100	2816	2915	3013
H_11115	42" W x 30" D x 30" H	26.0	232	100	2480	2567	2654
H_11116	42" W x 30" D x 36" H	31.0	248	100	2945	3048	3151
H_11117	48" W x 24" D x 30" H	24.1	260	92.5	2569	2659	2749
H_11118	48" W x 24" D x 36" H	28.6	277	100	2956	3059	3163
H_11119	48" W x 30" D x 30" H	29.6	280	100	2603	2694	2785
H_11120	48" W x 30" D x 36" H	35.2	286	100	3093	3201	3310
	Optional Lock Y				95	95	95

•30" H cabinets include one full-width adjustable shelf

•36" H cabinets include two full-width adjustable shelves

•Two utility drawers

Open Top, Drawer Bottom Storage



Model	Overall	Cu. Ft.	Shp. Wt.	Fr. Cls.	Zone 1	Zone 2	Zone 3
H_15201	30" W x 24" D x 72" H	35.6	330	100	2516	2604	2692
H_15202	30" W x 24" D x 84" H	41.4	340	100	2923	3025	3128
H_15203	30" W x 30" D x 72" H	43.9	358	100	2728	2823	2919
H_15204	30" W x 30" D x 84" H	51.0	363	125	3157	3267	3378
H_15205	36" W x 24" D x 72" H	42.3	378	100	2789	2887	2984
H_15206	36" W x 24" D x 84" H	49.2	385	100	3249	3363	3476
H_15207	36" W x 30" D x 72" H	52.1	390	100	3027	3133	3239
H_15208	36" W x 30" D x 84" H	60.5	401	125	3503	3626	3748
	Optional Lock Y				48	48	48

•72" H cabinets include two full-width adjustable shelves

•84" H cabinets include three full-width adjustable shelves

•Four utility drawers

	Model	Overall	Cu. Ft.	Shp. Wt.	Fr. Cls.	Zone 1	Zone 2	Zone 3
Enclosed Top, Drawer Bottom Storage 	H_16201	30" W x 24" D x 72" H	35.6	343	100	2817	2916	3014
	H_16202	30" W x 24" D x 84" H	41.4	358	100	3237	3350	3464
	H_16203	30" W x 30" D x 72" H	43.9	370	100	3027	3133	3239
	H_16204	30" W x 30" D x 84" H	51.0	381	125	3469	3590	3712
	H_16205	36" W x 24" D x 72" H	42.3	392	100	3106	3215	3323
	H_16206	36" W x 24" D x 84" H	49.2	403	100	3587	3713	3838
	H_16207	36" W x 30" D x 72" H	52.1	414	100	3345	3462	3579
	H_16208	36" W x 30" D x 84" H	60.5	419	125	3841	3975	4110
			Optional Lock Y				95	95

• 72" H cabinets include two full-width adjustable shelves

• 84" H cabinets include three full-width adjustable shelves

• Four utility drawers

	Model	Overall	Cu. Ft.	Shp. Wt.	Fr. Cls.	Zone 1	Zone 2	Zone 3
Open Storage 	H_17201	30" W x 24" D x 72" H	35.6	313	100	1776	1838	1900
	H_17202	30" W x 24" D x 84" H	41.4	322	125	2000	2070	2140
	H_17203	30" W x 30" D x 72" H	43.9	330	125	1988	2058	2127
	H_17204	30" W x 30" D x 84" H	51.0	321	125	2231	2309	2387
	H_17205	36" W x 24" D x 72" H	42.3	340	100	1848	1913	1977
	H_17206	36" W x 24" D x 84" H	49.2	330	125	2071	2143	2216
	H_17207	36" W x 30" D x 72" H	52.1	352	125	2087	2160	2233
	H_17208	36" W x 30" D x 84" H	60.5	368	125	2328	2409	2491

• 72" H cabinets include four full-width adjustable shelves

• 84" H cabinets include five full-width adjustable shelves

	Model	Overall	Cu. Ft.	Shp. Wt.	Fr. Cls.	Zone 1	Zone 2	Zone 3
Enclosed Door Storage 	H_18201	30" W x 24" D x 72" H	35.6	331	100	2151	2226	2302
	H_18202	30" W x 24" D x 84" H	41.4	340	100	2392	2476	2559
	H_18203	30" W x 30" D x 72" H	43.9	352	100	2363	2446	2528
	H_18204	30" W x 30" D x 84" H	51.0	360	125	2622	2714	2806
	H_18205	36" W x 24" D x 72" H	42.3	375	100	2244	2323	2401
	H_18206	36" W x 24" D x 84" H	49.2	382	125	2495	2582	2670
	H_18207	36" W x 30" D x 72" H	52.1	380	125	2484	2571	2658
	H_18208	36" W x 30" D x 84" H	60.5	393	125	2751	2847	2944
			Optional Lock Y				48	48

• 72" H cabinets include four full-width adjustable shelves

• 84" H cabinets include five full-width adjustable shelves

	Model	Overall	Cu. Ft.	Shp. Wt.	Fr. Cls.	Zone 1	Zone 2	Zone 3
Enclosed Wardrobe Storage 	H_19201	30" W x 24" D x 72" H	35.6	346	100	2586	2677	2767
	H_19202	30" W x 24" D x 84" H	41.4	355	100	2902	3004	3105
	H_19203	30" W x 30" D x 72" H	43.9	367	100	2813	2911	3010
	H_19204	30" W x 30" D x 84" H	51.0	375	125	3152	3262	3373
	H_19205	36" W x 24" D x 72" H	42.3	390	100	2708	2803	2898
	H_19206	36" W x 24" D x 84" H	49.2	397	100	3050	3157	3264
	H_19207	36" W x 30" D x 72" H	52.1	395	125	2967	3071	3175
	H_19208	36" W x 30" D x 84" H	60.5	408	125	3325	3441	3558
			Optional Lock Y				48	48

• Fixed shelf top left above coat rod

• 72" H cabinets include four adjustable shelves

• 84" H cabinets include five adjustable shelves



Vision

CONTEMPORARY CASEGOODS - SIN 33721

Modern, Clean, Fresh

Vision brings together the best in American manufacturing and European design. Comfortable to work with as it is beautiful and as advanced as the best ideas of tomorrow. Modular and flexible components are ideally suited for business - large, small and at home. Private office spaces with ample storage options maximize every square foot of space. Modular components provide flexibility in open office environments to easily adapt to growing and changing work force.

Tops

- 1" thick thermally fused laminate (TFL) surfaces
- 3mm AdvantEdge PVC edge banding

Edge Profile



Finishes

- Thermally fused laminate on all surfaces
- Boardwalk, Driftwood and Shoreline are textured laminate, smooth finish available on tops only
- Color combination available with contrasting top and base
- Monocolor for same top and base use a single finish designator

How to Specify:

- 1 Series
- 2 Laminate finish top
- 3 Laminate finish base (if different)
- 4 Model number
- 5 Options

Finished Example

VC/DW/7230DL3/Y

Finishes	Code
Black	E
Boardwalk	BW
Driftwood	DW
Espresso	X
Graphite	GP
Mahogany	M
Monticello Maple	MM
Natural Maple	FM
Shoreline	SL
Windsor Cherry	WC

Smooth Top Finishes	Code
Boardwalk	SB
Driftwood	SD
Shoreline	SS

Options	Code	Price
Locking Doors	Y	95 (per pair)
Heavy Duty Lateral File Bottom	H	101 (per drawer)
Additional Grommet	G	138
High Pressure Laminate Top	4	15%

Power

PowerFlex power modules can be installed in many locations. See page 36 for options.

Pedestals & File Cabinets

- Contemporary T-Bar nickel pulls in vertical orientation are standard
- Heavy-duty leveling glides in 2" H x 1" D steel feet
- .75"-thick core with thermally fused laminate on both sides
- 3mm AdvantEdge PVC edge banding
- Full height pedestals
- Fully assembled with dowels, glue, metal brackets, screws and mechanical fasteners
- Pre-installed filing hardware holds letter- and legal-size hanging files
- Drawer bottoms .125" thick rated to 25 lbs.
- Steel, ball-bearing slides on all drawers - ¾ extension on box and center drawers, full extension on file drawers
- .125" thick, 8" H satin acrylic modesty panels

Wire Management

- See individual product features for standard number of 1.5" grommet(s) and location(s)
- Additional grommets for extended wire management capability available





Locks

- Locks are "keyed alike" as standard
- "Keyed different" locks are available at \$25 per lock. Contact HPFI Customer Service for custom option code per order

End Panels/Legs

- .75" thick core with thermally fused laminate on both sides
- 3mm AdvantEdge PVC edge banding
- 1" diameter, 2" H polished aluminum feet in end panels
- 2" diameter tubular steel legs on table desks

Pre-Configured Workstations

	Model	Overall	Cu. Ft.	Shp. Wt.	Fr. Cls.	Zone 1	Zone 2	Zone 3
"L" Workstation, Left Return 	VC_72LL42	72" W x 72" D x 29" H	26.0	253	100	2695	2789	2884
	VC_66LL42	66" W x 72" D x 29" H	25.0	246	100	2656	2749	2842
	VC_60LL42	60" W x 72" D x 29" H	25.0	241	100	2620	2712	2803
	• Specify -2 suffix for front locking File/File drawer pedestal on return	• Specify -3 suffix for front locking Box/Box/File drawer pedestal on return	• 30" D main work surface, 42" W x 20" return surface			• 8" raised satin acrylic modesty panel		
	VC_72LL48	72" W x 72" D x 29" H	28.0	239	100	2592	2683	2773
	VC_66LL48	66" W x 72" D x 29" H	27.0	234	100	2563	2653	2742
	VC_60LL48	60" W x 72" D x 29" H	27.0	230	100	2531	2620	2708
	• Specify -2 suffix for front locking File/File drawer pedestal on return	• Specify -3 suffix for front locking Box/Box/File drawer pedestal on return	• 24" D main work surface, 48" W x 20" D return surface			• 8" raised satin acrylic modesty panel		
"L" Workstation, Right Return 	VC_72LR42	72" W x 72" D x 29" H	26.0	253	100	2695	2789	2884
	VC_66LR42	66" W x 72" D x 29" H	25.0	246	100	2656	2749	2842
	VC_60LR42	60" W x 72" D x 29" H	25.0	241	100	2620	2712	2803
	• Specify -2 suffix for front locking File/File drawer pedestal on return	• Specify -3 suffix for front locking Box/Box/File drawer pedestal on return	• 30" D main work surface, 42" W x 20" return surface			• 8" raised satin acrylic modesty panel		
	VC_72LR48	72" W x 72" D x 29" H	28.0	239	100	2592	2683	2773
	VC_66LR48	66" W x 72" D x 29" H	27.0	234	100	2563	2653	2742
	VC_60LR48	60" W x 72" D x 29" H	27.0	230	100	2531	2620	2708
	• Specify -2 suffix for front locking File/File drawer pedestal on return	• Specify -3 suffix for front locking Box/Box/File drawer pedestal on return	• 24" D main work surface, 48" W x 20" D return surface			• 8" raised satin acrylic modesty panel		

Vision

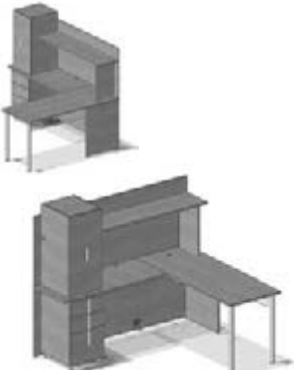
	Model	Overall	Cu. Ft.	Shp. Wt.	Fr. Cls.	Zone 1	Zone 2	Zone 3
"L" Workstation, Left Return with Overhead Storage	VC_72LL42H	72" W x 72" D x 62" H	56.0	395	125	4012	4152	4293
	VC_66LL42H	66" W x 72" D x 62" H	55.0	388	125	3959	4098	4236
	VC_60LL42H	60" W x 72" D x 62" H	55.0	383	125	3902	4039	4175
	• Specify -2 suffix for front locking File/File drawer pedestal on return	• Specify -3 suffix for front locking Box/Box/File drawer pedestal on return	• 30" D main work surface, 42" W x 20" D return surface with overhead storage			• 8" raised satin acrylic modesty panel on main desk		
	VC_72LL48H	72" W x 72" D x 62" H	58.0	381	125	3911	4048	4185
	VC_66LL48H	66" W x 72" D x 62" H	57.0	371	125	3882	4018	4154
VC_60LL48H	60" W x 72" D x 62" H	57.0	361	125	3849	3984	4118	
		• Specify -2 suffix for front locking File/File drawer pedestal on return	• Specify -3 suffix for front locking Box/Box/File drawer pedestal on return	• 24" D main work surface, 48" W x 20" D return surface with overhead storage			• 8" raised satin acrylic modesty panel on main desk	

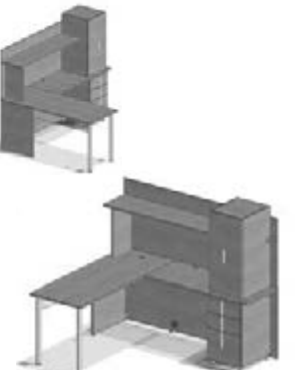
	Model	Overall	Cu. Ft.	Shp. Wt.	Fr. Cls.	Zone 1	Zone 2	Zone 3
"L" Workstation, Right Return with Overhead Storage	VC_72LR42H	72" W x 72" D x 62" H	56.0	395	125	4012	4152	4293
	VC_66LR42H	66" W x 72" D x 62" H	55.0	388	125	3959	4098	4236
	VC_60LR42H	60" W x 72" D x 62" H	55.0	383	125	3902	4039	4175
	• Specify -2 suffix for front locking File/File drawer pedestal on return	• Specify -3 suffix for front locking Box/Box/File drawer pedestal on return	• 30" D main work surface, 42" W x 20" D return surface with overhead storage			• 8" raised satin acrylic modesty panel on main desk		
	VC_72LR48H	72" W x 72" D x 62" H	58.0	381	125	3911	4048	4185
	VC_66LR48H	66" W x 72" D x 62" H	57.0	371	125	3882	4018	4154
VC_60LR48H	60" W x 72" D x 62" H	57.0	361	125	3849	3984	4118	
		• Specify -2 suffix for front locking File/File drawer pedestal on return	• Specify -3 suffix for front locking Box/Box/File drawer pedestal on return	• 24" D main work surface, 48" W x 20" D return surface with overhead storage			• 8" raised satin acrylic modesty panel on main desk	

	Model	Overall	Cu. Ft.	Shp. Wt.	Fr. Cls.	Zone 1	Zone 2	Zone 3
"U" Workstation, Left Bridge	VC_72UL48	72" W x 98" D x 29" H	41.0	350	100	3424	3544	3664
	VC_66UL48	66" W x 98" D x 29" H	38.0	335	100	3370	3488	3606
	VC_60UL48	60" W x 98" D x 29" H	35.0	323	100	3311	3427	3543
	• Specify -2 suffix for front locking File/File drawer pedestal on return	• Specify -3 suffix for front locking Box/Box/File drawer pedestal on return	• 30" D main work surface, 48" W x 20" D bridge			• 8" raised satin acrylic modesty panel on main desk		
	VC_72UL42	72" W x 92" D x 29" H	41.0	345	100	3374	3492	3610
	VC_66UL42	66" W x 92" D x 29" H	38.0	330	100	3319	3435	3551
VC_60UL42	60" W x 92" D x 29" H	35.0	318	100	3263	3377	3491	
		• Specify -2 suffix for front locking File/File drawer pedestal on return	• Specify -3 suffix for front locking Box/Box/File drawer pedestal on return	• 30" D main work surface, 42" W x 20" D bridge			• 8" raised satin acrylic modesty panel on main desk	

"U" Workstation, Right Bridge



Model	Overall	Cu. Ft.	Shp. Wt.	Fr. Cls.	Zone 1	Zone 2	Zone 3
VC_72UR48	72" W x 98" D x 29" H	41.0	350	100	3424	3544	3664
VC_66UR48	66" W x 98" D x 29" H	38.0	335	100	3370	3488	3606
VC_60UR48	60" W x 98" D x 29" H	35.0	323	100	3311	3427	3543
	<ul style="list-style-type: none"> Specify -2 suffix for front locking File/File drawer pedestal on credenza 	<ul style="list-style-type: none"> Specify -3 suffix for front locking Box/Box/File drawer pedestal on credenza 	<ul style="list-style-type: none"> 30" D main work surface, 48" W x 20" D bridge 	<ul style="list-style-type: none"> 8" raised satin acrylic modesty panel on main desk 			
VC_72UR42	72" W x 92" D x 29" H	41.0	345	100	3374	3492	3610
VC_66UR42	66" W x 92" D x 29" H	38.0	330	100	3319	3435	3551
VC_60UR42	60" W x 92" D x 29" H	35.0	318	100	3263	3377	3491
	<ul style="list-style-type: none"> Specify -2 suffix for front locking File/File drawer pedestal on credenza 	<ul style="list-style-type: none"> Specify -3 suffix for front locking Box/Box/File drawer pedestal on credenza 	<ul style="list-style-type: none"> 30" D main work surface, 42" W x 20" D bridge 	<ul style="list-style-type: none"> 8" raised satin acrylic modesty panel on main desk 			

"U" Workstation, Left Bridge with Overhead Storage

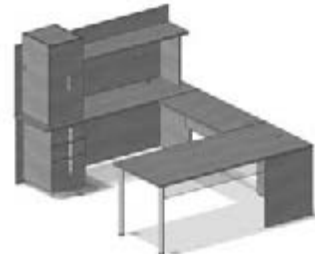

Model	Overall	Cu. Ft.	Shp. Wt.	Fr. Cls.	Zone 1	Zone 2	Zone 3
VC_72UL48H	72" W x 98" D x 62" H	71.0	492	125	4740	4906	5072
VC_66UL48H	66" W x 98" D x 62" H	65.0	472	125	4672	4836	4999
VC_60UL48H	60" W x 98" D x 62" H	60.0	454	125	4595	4756	4917
	<ul style="list-style-type: none"> Specify -2 suffix for front locking File/File drawer pedestal on credenza 	<ul style="list-style-type: none"> Specify -3 suffix for front locking Box/Box/File drawer pedestal on credenza 	<ul style="list-style-type: none"> 30" D main work surface, 48" W x 20" D bridge Overhead storage on credenza 	<ul style="list-style-type: none"> 8" raised satin acrylic modesty panel on main desk 			
VC_72UL42H	72" W x 92" D x 62" H	71.0	487	125	4692	4856	5020
VC_66UL42H	66" W x 92" D x 62" H	65.0	467	125	4623	4785	4947
VC_60UL42H	60" W x 92" D x 62" H	60.0	449	125	4546	4705	4864
	<ul style="list-style-type: none"> Specify -2 suffix for front locking File/File drawer pedestal on credenza 	<ul style="list-style-type: none"> Specify -3 suffix for front locking Box/Box/File drawer pedestal on credenza 	<ul style="list-style-type: none"> 30" D main work surface, 42" W x 20" D bridge Overhead storage on credenza 	<ul style="list-style-type: none"> 8" raised satin acrylic modesty panel on main desk 			

"U" Workstation, Right Bridge with Overhead Storage

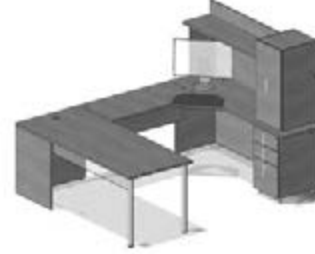

Model	Overall	Cu. Ft.	Shp. Wt.	Fr. Cls.	Zone 1	Zone 2	Zone 3
VC_72UR48H	72" W x 98" D x 62" H	71.0	492	125	4740	4906	5072
VC_66UR48H	66" W x 98" D x 62" H	65.0	472	125	4672	4836	4999
VC_60UR48H	60" W x 98" D x 62" H	60.0	454	125	4595	4756	4917
	<ul style="list-style-type: none"> Specify -2 suffix for front locking File/File drawer pedestal on credenza 	<ul style="list-style-type: none"> Specify -3 suffix for front locking Box/Box/File drawer pedestal on credenza 	<ul style="list-style-type: none"> 30" D main work surface, 48" W x 20" D bridge Overhead storage on credenza 	<ul style="list-style-type: none"> 8" raised satin acrylic modesty panel on main desk 			
VC_72UR42H	72" W x 92" D x 62" H	71.0	487	125	4692	4856	5020
VC_66UR42H	66" W x 92" D x 62" H	65.0	467	125	4623	4785	4947
VC_60UR42H	60" W x 92" D x 62" H	60.0	449	125	4546	4705	4864
	<ul style="list-style-type: none"> Specify -2 suffix for front locking File/File drawer pedestal on credenza 	<ul style="list-style-type: none"> Specify -3 suffix for front locking Box/Box/File drawer pedestal on credenza 	<ul style="list-style-type: none"> 30" D main work surface, 42" W x 20" D bridge Overhead storage on credenza 	<ul style="list-style-type: none"> 8" raised satin acrylic modesty panel on main desk 			

Vision

Desks

	Model	Overall	Cu. Ft.	Shp. Wt.	Fr. Cls.	Zone 1	Zone 2	Zone 3
Double Pedestal Desk	VC_7230DL3	72" W x 30" D x 29" H	42.0	295	110	2419	2504	2588
	VC_6630DL3	66" W x 30" D x 29" H	39.0	286	110	2391	2475	2558



- Front locking Box/Box/File drawers in each pedestal
- 30" D left pedestal
- 24" D right pedestal
- Ships fully assembled

	Model	Overall	Cu. Ft.	Shp. Wt.	Fr. Cls.	Zone 1	Zone 2	Zone 3
Double Pedestal Desk	VC_7230DR3	72" W x 30" D x 29" H	42.0	295	125	2419	2504	2588
	VC_6630DR3	66" W x 30" D x 29" H	39.0	286	125	2391	2475	2558



- Front locking Box/Box/File drawers in each pedestal
- 24" D left pedestal
- 30" D right pedestal
- Ships fully assembled

	Model	Overall	Cu. Ft.	Shp. Wt.	Fr. Cls.	Zone 1	Zone 2	Zone 3
Left Pedestal Desk	VC_7230L3	72" W x 30" D x 29" H	42.0	222	150	1902	1969	2035



- Front locking Box/Box/File drawers in left pedestal
- Full width end panel on right
- 8" raised satin acrylic modesty panel
- Ships fully assembled

	Model	Overall	Cu. Ft.	Shp. Wt.	Fr. Cls.	Zone 1	Zone 2	Zone 3
Right Pedestal Desk	VC_7230R3	72" W x 30" D x 29" H	42.0	222	150	1902	1969	2035

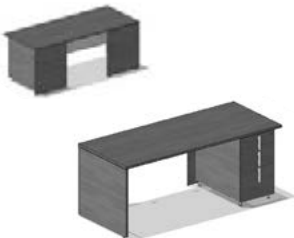

- Front locking Box/Box/File drawers in right pedestal
- Full width end panel on left
- 8" raised satin acrylic modesty panel
- Ships fully assembled

	Model	Overall	Cu. Ft.	Shp. Wt.	Fr. Cls.	Zone 1	Zone 2	Zone 3
Left Pedestal Table Desk	VC_7230TL3	72" W x 30" D x 29" H	42.0	192	150	1978	2047	2116
	VC_6630TL3	66" W x 30" D x 29" H	39.0	186	150	1941	2009	2077
	VC_6030TL3	60" W x 30" D x 29" H	36.0	181	150	1903	1970	2036



- Front locking Box/Box/File drawers in left pedestal
- Column legs on right
- 8" raised satin acrylic modesty panel
- Ships fully assembled

	Model	Overall	Cu. Ft.	Shp. Wt.	Fr. Cls.	Zone 1	Zone 2	Zone 3
Right Pedestal Table Desk	VC_7230TR3	72" W x 30" D x 29" H	42.0	192	150	1978	2047	2116
	VC_6630TR3	66" W x 30" D x 29" H	39.0	186	150	1941	2009	2077
	VC_6030TR3	60" W x 30" D x 29" H	36.0	181	150	1903	1970	2036
	• Front locking Box/Box/File drawers in right pedestal	• Column legs on left	• 8" raised satin acrylic modesty panel	• Ships fully assembled				



	Model	Overall	Cu. Ft.	Shp. Wt.	Fr. Cls.	Zone 1	Zone 2	Zone 3
Table Desk	VC_7230TL	72" W x 30" D x 29" H	9.0	124	85	1441	1491	1542
	VC_6630TL	66" W x 30" D x 29" H	8.0	117	85	1405	1454	1503
	VC_6030TL	60" W x 30" D x 29" H	8.0	112	85	1366	1414	1462
	VC_7224TL	72" W x 24" D x 29" H	8.0	104	85	1320	1366	1412
	VC_6624TL	66" W x 24" D x 29" H	7.0	99	85	1292	1337	1382
	VC_6024TL	60" W x 24" D x 29" H	7.0	95	85	1260	1304	1348
	• Full width panel end on left	• Column legs on right	• 8" raised satin acrylic modesty panel	• Assembly required				



	Model	Overall	Cu. Ft.	Shp. Wt.	Fr. Cls.	Zone 1	Zone 2	Zone 3
Table Desk	VC_7230TR	72" W x 30" D x 29" H	9.0	124	85	1441	1491	1542
	VC_6630TR	66" W x 30" D x 29" H	8.0	117	85	1405	1454	1503
	VC_6030TR	60" W x 30" D x 29" H	8.0	112	85	1366	1414	1462
	VC_7224TR	72" W x 24" D x 29" H	8.0	104	85	1320	1366	1412
	VC_6624TR	66" W x 24" D x 29" H	7.0	99	85	1292	1337	1382
	VC_6024TR	60" W x 24" D x 29" H	7.0	95	85	1260	1304	1348
	• Full width panel end on right	• Column legs on left	• 8" raised satin acrylic modesty panel	• Assembly required				



	Model	Overall	Cu. Ft.	Shp. Wt.	Fr. Cls.	Zone 1	Zone 2	Zone 3
Table Desk	VC_7230T	72" W x 30" D x 29" H	8.0	109	85	1446	1497	1547
	VC_6630T	66" W x 30" D x 29" H	7.0	101	85	1394	1443	1492
	VC_6030T	60" W x 30" D x 29" H	7.0	95	85	1340	1387	1434
	• Four column legs	• 8" satin acrylic modesty panel	• 8" raised satin acrylic modesty panel	• Assembly required				



Bridges and Returns

	Model	Overall	Cu. Ft.	Shp. Wt.	Fr. Cls.	Zone 1	Zone 2	Zone 3
Bridge	VC_2048B	48" W x 20" D x 29" H	8.0	109	70	466	482	499
	VC_2042B	42" W x 20" D x 29" H	7.0	101	70	418	433	447



- Connects desk and credenza
- Not freestanding
- Assembly required

	Model	Overall	Cu. Ft.	Shp. Wt.	Fr. Cls.	Zone 1	Zone 2	Zone 3
Left Desk Return	VC_2048L3	48" W x 20" D x 29" H	20.0	135	125	1272	1317	1361
	VC_2042L3	42" W x 20" D x 29" H	17.0	129	125	1251	1295	1339



- Box/Box/File drawers in left pedestal
- Front locking drawers
- Ships fully assembled

	Model	Overall	Cu. Ft.	Shp. Wt.	Fr. Cls.	Zone 1	Zone 2	Zone 3
Right Desk Return	VC_2048R3	48" W x 20" D x 29" H	20.0	135	125	1272	1317	1361
	VC_2042R3	42" W x 20" D x 29" H	17.0	129	125	1251	1295	1339



- Box/Box/File drawers in right pedestal
- Front locking drawers
- Ships fully assembled

	Model	Overall	Cu. Ft.	Shp. Wt.	Fr. Cls.	Zone 1	Zone 2	Zone 3
Left Desk Return	VC_2048L2	48" W x 20" D x 29" H	20.0	135	125	1272	1317	1361
	VC_2042L2	42" W x 20" D x 29" H	17.0	129	125	1251	1295	1339



- File/File drawers in left pedestal
- Front locking drawers
- Ships fully assembled

	Model	Overall	Cu. Ft.	Shp. Wt.	Fr. Cls.	Zone 1	Zone 2	Zone 3
Right Desk Return	VC_2048R2	48" W x 20" D x 29" H	20.0	135	125	1272	1317	1361
	VC_2042R2	42" W x 20" D x 29" H	17.0	129	125	1251	1295	1339



- File/File drawers in left pedestal
- Front locking drawers
- Ships fully assembled

Credenzas

	Model	Overall	Cu. Ft.	Shp. Wt.	Fr. Cls.	Zone 1	Zone 2	Zone 3
Double Pedestal Credenza	VC_7220-4	72" W x 20" D x 29" H	29.0	237	110	2070	2142	2215
	VC_6620-4	66" W x 20" D x 29" H	27.0	229	110	2054	2126	2198
	VC_6020-4	60" W x 20" D x 29" H	24.0	222	110	2034	2105	2176



- File/File drawers in each pedestal
- Front locking drawers
- Ships fully assembled

	Model	Overall	Cu. Ft.	Shp. Wt.	Fr. Cls.	Zone 1	Zone 2	Zone 3
Left Pedestal Credenza	VC_7220L2	72" W x 20" D x 29" H	29.0	178	110	1516	1569	1622
	VC_6620L2	66" W x 20" D x 29" H	27.0	170	110	1498	1550	1603
	VC_6020L2	60" W x 20" D x 29" H	24.0	163	110	1479	1531	1583



- File/File drawers in left pedestal
- Front locking drawers
- Ships fully assembled

	Model	Overall	Cu. Ft.	Shp. Wt.	Fr. Cls.	Zone 1	Zone 2	Zone 3
Right Pedestal Credenza	VC_7220R2	72" W x 20" D x 29" H	29.0	178	110	1516	1569	1622
	VC_6620R2	66" W x 20" D x 29" H	27.0	170	110	1498	1550	1603
	VC_6020R2	60" W x 20" D x 29" H	24.0	163	110	1479	1531	1583



- File/File drawers in right pedestal
- Front locking drawers
- Ships fully assembled

	Model	Overall	Cu. Ft.	Shp. Wt.	Fr. Cls.	Zone 1	Zone 2	Zone 3
Left Pedestal Credenza	VC_7220L3	72" W x 20" D x 29" H	29.0	178	125	1516	1569	1622
	VC_6620L3	66" W x 20" D x 29" H	27.0	170	125	1498	1550	1603
	VC_6020L3	60" W x 20" D x 29" H	24.0	163	125	1479	1531	1583





- Box/Box/File drawers in left pedestal
- Front locking drawers
- Ships fully assembled

Vision

	Model	Overall	Cu. Ft.	Shp. Wt.	Fr. Cls.	Zone 1	Zone 2	Zone 3
Right Pedestal Credenza 	VC_7220R3	72" W x 20" D x 29" H	29.0	178	125	1516	1569	1622
	VC_6620R3	66" W x 20" D x 29" H	27.0	170	125	1498	1550	1603
	VC_6020R3	60" W x 20" D x 29" H	24.0	163	125	1479	1531	1583
	• Box/Box/File drawers in right pedestal	• Front locking drawers	• Ships fully assembled					

	Model	Overall	Cu. Ft.	Shp. Wt.	Fr. Cls.	Zone 1	Zone 2	Zone 3
Storage Credenza 	VC_7220-4S	72" W x 20" D x 29" H	29.0	277	100	2490	2577	2664
	VC_6620-4S	66" W x 20" D x 29" H	27.0	264	100	2456	2542	2628
	VC_6020-4S	60" W x 20" D x 29" H	24.0	252	100	2421	2506	2590
	• File/File drawers in each pedestal	• Storage compartment in center	• Front locking drawers			• Ships fully assembled		
			Optional Door Lock Y			95	95	95

	Model	Overall	Cu. Ft.	Shp. Wt.	Fr. Cls.	Zone 1	Zone 2	Zone 3
Double Lateral File Credenza 	VC_7220DLF	72" W x 20" D x 29" H	29.0	367	92.5	2897	2998	3100
			Heavy Duty Bottom H			404	404	404
	• Four lateral file drawers	• Front locking drawers	• Ships fully assembled					

	Model	Overall	Cu. Ft.	Shp. Wt.	Fr. Cls.	Zone 1	Zone 2	Zone 3
Double Storage Credenza 	VC_7220DS	72" W x 20" D x 29" H	29.0	297	125	2004	2074	2144
			Optional Door Locks Y			190	190	190
	• Two bookcase storage compartments	• One adjustable shelf in each compartment	• Ships fully assembled					

	Model	Overall	Cu. Ft.	Shp. Wt.	Fr. Cls.	Zone 1	Zone 2	Zone 3
Lateral File / Storage Credenza 	VC_7220LFS	72" W x 20" D x 29" H	29.0	332	92.5	2450	2536	2622
			Optional Door Lock Y			95	95	95
			Heavy Duty Bottom H			202	202	202
	• Two lateral file drawers on left	• Bookcase storage compartment on right	• Ships fully assembled					

	Model	Overall	Cu. Ft.	Shp. Wt.	Fr. Cls.	Zone 1	Zone 2	Zone 3
Left Lateral File Credenza	VC_7220LF	72" W x 20" D x 29" H	29.0	243	100	1872	1938	2003
	VC_6620LF	66" W x 20" D x 29" H	27.0	235	100	1854	1919	1984
	VC_6020LF	60" W x 20" D x 29" H	24.0	228	100	1836	1900	1965
				Heavy Duty Bottom H			202	202



- Two lateral file drawers on left
- Front locking drawers
- Ships fully assembled

	Model	Overall	Cu. Ft.	Shp. Wt.	Fr. Cls.	Zone 1	Zone 2	Zone 3
Right Lateral File Credenza	VC_7220RF	72" W x 20" D x 29" H	29.0	243	100	1872	1938	2003
	VC_6620RF	66" W x 20" D x 29" H	27.0	235	100	1854	1919	1984
	VC_6020RF	60" W x 20" D x 29" H	24.0	228	100	1836	1900	1965
				Heavy Duty Bottom H			202	202



- Two lateral file drawers on right
- Front locking drawers
- Ships fully assembled

	Model	Overall	Cu. Ft.	Shp. Wt.	Fr. Cls.	Zone 1	Zone 2	Zone 3
Left Storage Credenza	VC_7220LS	72" W x 20" D x 29" H	29.0	208	125	1438	1488	1539
	VC_6620LS	66" W x 20" D x 29" H	27.0	200	125	1423	1473	1523
	VC_6020LS	60" W x 20" D x 29" H	24.0	193	125	1403	1452	1501



- Bookcase storage compartment on left
- One adjustable shelf
- Ships fully assembled

	Model	Overall	Cu. Ft.	Shp. Wt.	Fr. Cls.	Zone 1	Zone 2	Zone 3
Right Storage Credenza	VC_7220RS	72" W x 20" D x 29" H	29.0	208	125	1438	1488	1539
	VC_6620RS	66" W x 20" D x 29" H	27.0	200	125	1423	1473	1523
	VC_6020RS	60" W x 20" D x 29" H	24.0	193	125	1403	1452	1501



- Bookcase storage compartment on right
- One adjustable shelf
- Ships fully assembled

Overhead Storage

	Model	Overall	Cu. Ft.	Shp. Wt.	Fr. Cls.	Zone 1	Zone 2	Zone 3
Double Tower Overhead	VC_OH7220	72" W x 18" D x 32" H	30.0	198	125	1839	1903	1968
	VC_OH6620	66" W x 18" D x 32" H	27.0	193	125	1826	1890	1954
	VC_OH6020	60" W x 18" D x 32" H	25.0	187	125	1806	1869	1932



- Hinged doors
- One adjustable shelf in each tower, fixed shelf in center
- 62" height from top of Overhead to floor when placed on work surface
- Ships fully assembled

	Model	Overall	Cu. Ft.	Shp. Wt.	Fr. Cls.	Zone 1	Zone 2	Zone 3
Task Light	TL2P	19.5" W x 3.25" D x 1.25" H	1.2	3	200	216	224	231



- 720 lumen, 8 watts
- 10' power cord

XDTB2023

Double Tower Tackboard



Overall	St. Ydg.	Cu. Ft.	Shp. Wt.	Fr. Cls.
22.75" W x 1" D x 19.75" H	1	1	9	100

	1	2/COM	3/COM	4	5	6	7	8	9	10	11	12/L	13	14	15/LL
Zone 1	322	337	365	382	398	424	451	476	500	531	561	596	630	659	693
Zone 2	333	349	378	395	412	439	467	493	518	550	581	617	652	682	717
Zone 3	345	361	391	409	426	454	483	509	535	568	600	638	674	705	742

- Fits VC_OH6020
- Fully tackable
- Must be field installed

XDTB2029

Double Tower Tackboard



Overall	St. Ydg.	Cu. Ft.	Shp. Wt.	Fr. Cls.
28.75" W x 1" D x 19.75" H	1	1	9	100

	1	2/COM	3/COM	4	5	6	7	8	9	10	11	12/L	13	14	15/LL
Zone 1	322	337	365	382	398	424	451	476	500	531	561	596	630	659	693
Zone 2	333	349	378	395	412	439	467	493	518	550	581	617	652	682	717
Zone 3	345	361	391	409	426	454	483	509	535	568	600	638	674	705	742

- Fits VC_OH6620
- Fully tackable
- Must be field installed

XDTB2035

Double Tower Tackboard



Overall	St. Ydg.	Cu. Ft.	Shp. Wt.	Fr. Cls.
34.75" W x 1" D x 19.75" H	1	1	9	100

	1	2/COM	3/COM	4	5	6	7	8	9	10	11	12/L	13	14	15/LL
Zone 1	322	337	365	382	398	424	451	476	500	531	561	596	630	659	693
Zone 2	333	349	378	395	412	439	467	493	518	550	581	617	652	682	717
Zone 3	345	361	391	409	426	454	483	509	535	568	600	638	674	705	742

- Fits VC_OH7220
- Fully tackable
- Must be field installed

	Model	Overall	Cu. Ft.	Shp. Wt.	Fr. Cls.	Zone 1	Zone 2	Zone 3
Left Single Tower Overhead	VC_OH7220L	72" W x 18" D x 32" H	30.0	147	125	1318	1364	1410
	VC_OH6620L	66" W x 18" D x 32" H	27.0	142	125	1302	1348	1393
	VC_OH6020L	60" W x 18" D x 32" H	25.0	136	125	1283	1328	1373



- One tower storage on left
- One adjustable shelf in tower
- One fixed shelf on right

	Model	Overall	Cu. Ft.	Shp. Wt.	Fr. Cls.	Zone 1	Zone 2	Zone 3
Right Single Tower Overhead	VC_OH7220R	72" W x 18" D x 32" H	30.0	147	125	1318	1364	1410
	VC_OH6620R	66" W x 18" D x 32" H	27.0	142	125	1302	1348	1393
	VC_OH6020R	60" W x 18" D x 32" H	25.0	136	125	1283	1328	1373



- One tower storage on right
- One adjustable shelf in tower
- One fixed shelf on left

Overall	St. Ydg.	Cu. Ft.	Shp. Wt.	Fr. Cls.
XDTB2036 37.25" W x 1" D x 19.75" H	1	1	10	100

Single Tower Tackboard



	1	2/COM	3/COM	4	5	6	7	8	9	10	11	12/L	13	14	15/LL
Zone 1	322	337	365	382	398	424	451	476	500	531	561	596	630	659	693
Zone 2	333	349	378	395	412	439	467	493	518	550	581	617	652	682	717
Zone 3	345	361	391	409	426	454	483	509	535	568	600	638	674	705	742

- Fits VC_OH6020L and VC_OH6020R
- Fully tackable
- Must be field installed

Overall	St. Ydg.	Cu. Ft.	Shp. Wt.	Fr. Cls.
XDTB2042 43.25" W x 1" D x 19.75" H	1	1	13	100

Single Tower Tackboard



	1	2/COM	3/COM	4	5	6	7	8	9	10	11	12/L	13	14	15/LL
Zone 1	322	337	365	382	398	424	451	476	500	531	561	596	630	659	693
Zone 2	333	349	378	395	412	439	467	493	518	550	581	617	652	682	717
Zone 3	345	361	391	409	426	454	483	509	535	568	600	638	674	705	742

- Fits VC_OH6620L and VC_OH6620R
- Fully tackable
- Must be field installed

Overall	St. Ydg.	Cu. Ft.	Shp. Wt.	Fr. Cls.
XDTB2048 49.25" W x 1" D x 19.75" H	1	1	13	100

Single Tower Tackboard



	1	2/COM	3/COM	4	5	6	7	8	9	10	11	12/L	13	14	15/LL
Zone 1	322	337	365	382	398	424	451	476	500	531	561	596	630	659	693
Zone 2	333	349	378	395	412	439	467	493	518	550	581	617	652	682	717
Zone 3	345	361	391	409	426	454	483	509	535	568	600	638	674	705	742

- Fits VC_OH7220L and VC_OH7220R
- Fully tackable
- Must be field installed

Storage and Filing

	Model	Overall	Cu. Ft.	Shp. Wt.	Fr. Cls.	Zone 1	Zone 2	Zone 3
Mobile Pedestal	VC_20	16" W x 20" D x 22" H	6.00	85	100	938	971	1004



- Front locking Box/File drawer
- Convenience pull on top for easy mobility
- Four casters, two lock

	Overall	St. Ydg.	Cu. Ft.	Shp. Wt.	Fr. Cls.
XD1618SC	16" W x 18" D x 1.5" H	1	1	2	250

Seat Cushion for VC_20



	1	2/COM	3/COM	4	5	6	7	8	9	10	11	12/L	13	14	15/LL
Zone 1	273	292	316	334	352	377	404	429	452	484	513	548	582	611	646
Zone 2	283	302	327	346	364	390	418	444	468	501	531	567	602	632	669
Zone 3	292	312	338	357	377	403	432	459	484	518	549	586	623	654	691

- Anti-skid backing

	Model	Overall	Cu. Ft.	Shp. Wt.	Fr. Cls.	Zone 1	Zone 2	Zone 3
Stationary Drawer Pedestal	VC_1620P	16" W x 20" D x 19" H	5.0	78	85	1070	1107	1145



- One front locking drawer File drawer
- Four 2" legs with leveling glides

	Overall	St. Ydg.	Cu. Ft.	Shp. Wt.	Fr. Cls.
XD1620SC	16" W x 20" D x 1.5" H	1	1	2	250

Seat Cushion for VC_1620P



	1	2/COM	3/COM	4	5	6	7	8	9	10	11	12/L	13	14	15/LL
Zone 1	273	292	316	334	352	377	404	429	452	484	513	548	582	611	646
Zone 2	283	302	327	346	364	390	418	444	468	501	531	567	602	632	669
Zone 3	292	312	338	357	377	403	432	459	484	518	549	586	623	654	691

- Anti-skid backing

	Model	Overall	Cu. Ft.	Shp. Wt.	Fr. Cls.	Zone 1	Zone 2	Zone 3
Stationary Open Pedestal	VC_2020	20" W x 20" D x 19" H	6.0	61	85	787	815	842



- Open storage cube
- Four 2" legs with leveling glides
- Ships fully assembled

	Overall	St. Ydg.	Cu. Ft.	Shp. Wt.	Fr. Cls.
XD2020SC	20" W x 20" D x 1.5" H	1	1	3	250

Seat Cushion for VC_2020



	1	2/COM	3/COM	4	5	6	7	8	9	10	11	12/L	13	14	15/LL
Zone 1	365	383	408	425	443	469	494	520	544	576	604	639	673	702	738
Zone 2	378	396	422	440	459	485	511	538	563	596	625	661	697	727	764
Zone 3	391	410	437	455	474	502	529	556	582	616	646	684	720	751	790

- Anti-skid backing

Vision

	Model	Overall	Cu. Ft.	Shp. Wt.	Fr. Cls.	Zone 1	Zone 2	Zone 3
--	-------	---------	---------	----------	----------	--------	--------	--------

Bookcase

VC_BK3672

36" W x 15" D x 72" H

28.0 215 125

941

974

1007

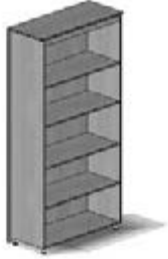

- Fixed bottom and middle shelves

- Three adjustable shelves

- Four 2" legs with leveling glides

	Model	Overall	Cu. Ft.	Shp. Wt.	Fr. Cls.	Zone 1	Zone 2	Zone 3
--	-------	---------	---------	----------	----------	--------	--------	--------

Media Station

VC_MDS3648

84" W x 20" D x 75" H

31.0 325 125

3002

3107

3212

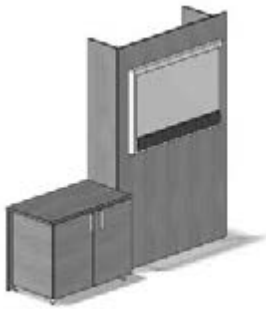

- 75" H wall provides video monitor mounting surface

- Storage cabinet includes one adjustable shelf

- Cabinet must be assembled to wall

Optional Door Lock **Y**

95

95

95

	Model	Overall	Cu. Ft.	Shp. Wt.	Fr. Cls.	Zone 1	Zone 2	Zone 3
--	-------	---------	---------	----------	----------	--------	--------	--------

Collaborative Table Console

VC_798

72" W x 42" D x 29" H

60.5 189 250

2174

2250

2326



- Attaches to VC_MDS3648

- Hinged door console cabinet stores electronic components

	Model	Overall	Cu. Ft.	Shp. Wt.	Fr. Cls.	Zone 1	Zone 2	Zone 3
--	-------	---------	---------	----------	----------	--------	--------	--------

Mobile Teaming Board

VC_MTB

36" W x 24" D x 72" H

10.4 158 125

1466

1517

1569

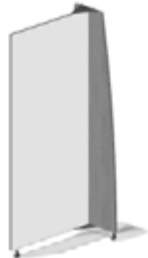

- 36" W x 72" H dry erase surface on two sides

- Casters for easy mobility

- Includes dry-erase markers and eraser

- Assembly required

	Model	Overall	Cu. Ft.	Shp. Wt.	Fr. Cls.	Zone 1	Zone 2	Zone 3
--	-------	---------	---------	----------	----------	--------	--------	--------

Wall Mount Storage Cabinet

V_3610SDW

36" W x 13.75" D x 10" H

4.2 30 125

1103

1142

1180

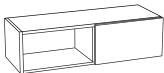

- Two storage compartments

- One sliding door

- Includes mounting cleat, but no screws

- Must be affixed to wall stud

	Model	Overall	Cu. Ft.	Shp. Wt.	Fr. Cls.	Zone 1	Zone 2	Zone 3
--	-------	---------	---------	----------	----------	--------	--------	--------

Center Drawer

	HW_CD19	19.5" W x 18" D x 3" H	1.5	11	100	216	224	231
--	----------------	------------------------	-----	----	-----	------------	------------	------------

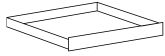

	Model	Overall	Cu. Ft.	Shp. Wt.	Fr. Cls.	Zone 1	Zone 2	Zone 3
--	-------	---------	---------	----------	----------	--------	--------	--------

Pullout Keyboard Shelf

	HW_K21	21" W x 18" D x 3" H	2.0	12	92.5	249	258	266
--	---------------	----------------------	-----	----	------	------------	------------	------------



	Model	Overall	Cu. Ft.	Shp. Wt.	Fr. Cls.	Zone 1	Zone 2	Zone 3
--	-------	---------	---------	----------	----------	--------	--------	--------

Acrylic Privacy Screen

	XDAS48	48" W x 4" D x 8" H	2.0	16	N/A	634	656	678
	XDAS42	42" W x 4" D x 8" H	2.0	15	N/A	615	637	658
	XDAS36	36" W x 4" D x 8" H	1.0	15	N/A	597	618	639



- Sits on work surface to add privacy

- XDAS36 recommended for 60" W surfaces

- XDAS42 recommended for 66" W surfaces

- XDAS48 recommended for 72" W surfaces

	Model	Overall	Cu. Ft.	Shp. Wt.	Fr. Cls.	Zone 1	Zone 2	Zone 3
--	-------	---------	---------	----------	----------	--------	--------	--------

Wire Management Channel

	MDWM	12" W x 2.25" D x 1.25" H	0.4	3	70	37	38	40
--	-------------	---------------------------	-----	---	----	-----------	-----------	-----------



- Attaches under tops or to back panels

- Peel and stick self-adhesive

- Front opening for easy access



Vitality

TRANSITIONAL CASEGOODS - SIN 33721

Bring New Life to Your Work Space

Collaborative work areas with transitional style coordinates with executive or open plan designs. A variety of configurations address all areas of an organization with a single finely crafted collection. High pressure laminate tops for executive level perception and front-line performance. Solid wood edges are shaped and finished for a handcrafted appearance. Ships fully assembled!

Tops

- 1.188" thick high gloss, high pressure laminate (HPL) surfaces
- Rounded wood/lumber-banded edges

Finishes

- High pressure laminate (HPL) top
- Thermally fused laminate (TFL) on all case surfaces

Edge Profile



How to Specify:

- 1 Series
- 2 Pulls
- 3 Laminate finish
- 4 Model number
- 5 Options

Finished Example

V/E/WC/720B2BF/G

Finishes	Code
Mahogany	M
Windsor Cherry	WC

Power
PowerFlex power modules can be installed in many locations. See page 36 for options.

Pulls	Code
Antique Brass	A
Ebony	E
Silver	W

Options	Code	Price
Factory Installed Center Drawer	C	Varies
Factory Installed Keyboard Shelf	K	Varies
Locks Doors	Y	95 (per pair)
Heavy Duty Lateral File Bottom	H	101 (per drawer)
Additional Grommet	G	138

Pedestals & File Cabinets

- 1" thick end panels, .75" thick modesty panel
- Pedestal is .75"-thick core with thermally fused laminate (TFL) on both sides
- 1mm AdvantEdge PVC edgbanding on all exposed case and drawer front edges
- Full height pedestals
- Antique brass
- Fully assembled with dowels, glue, metal brackets, screws and mechanical fasteners
- Pre-installed filing hardware holds letter- and legal-size hanging files

- Drawer bottoms .125" thick rated to 25 lbs.
- File drawers are 5-sided, oak woodgrain vinyl wrapped, .5" thick
- 3/4 extension steel, ball-bearing slides on box and center drawers
- Full extension steel, ball-bearing slides on file drawers
- 5" diameter veneer column on peninsula desk





Wire Management

- See individual product features for standard number of 3.25" x 1.875 grommets and location(s)
- Additional grommets for extended wire management capability available

Locks

- Locks are "keyed alike" as standard
- "Keyed different" locks are available at \$25 per lock. Contact HPFi Customer Service for custom option code per order

Desks

	Model	Overall	Cu. Ft.	Shp. Wt.	Fr. Cls.	Zone 1	Zone 2	Zone 3
Bow Front Double Pedestal Desk 	V__720B2BF	72" W x 36" D x 29" H	51.6	360	110	4359	4512	4664
	• Box/Box/File drawer in each pedestal	• Individually locking pedestals	• Two grommets in top	• Two pullout writing shelves				
Bow Front Left Pedestal Desk 	V__721LB2BF	72" W x 36" D x 29" H	51.6	289	110	3939	4077	4215
	• Box/Box/File drawer in left pedestal	• Side locking pedestal	• Two grommets in top	• One pullout writing shelf				
Bow Front Right Pedestal Desk 	V__721RB2BF	72" W x 36" D x 29" H	51.6	289	110	3939	4077	4215
	• Box/Box/File drawer in right pedestal	• Side locking pedestal	• Two grommets in top	• One pullout writing shelf				
Rectangular Double Pedestal Desk 	V__7202BF V__6602BF	72" W x 36" D x 29" H 66" W x 30" D x 29" H	51.6 40.2	370 330	110 110	3947 3591	4085 3717	4223 3842
	• Box/Box/File Drawer in each pedestal	• Individually locking pedestals	• Two grommets in top	• Two pullout writing shelves				

Vitality

	Model	Overall	Cu. Ft.	Shp. Wt.	Fr. Cls.	Zone 1	Zone 2	Zone 3
Left Pedestal Desk 	V_721L2BF	72" W x 36" D x 29" H	51.6	298	110	3414	3533	3653
	V_651L2BF	66" W x 30" D x 29" H	40.2	262	110	2983	3087	3192
	• Box/Box/File Drawer in left pedestal	• Side locking pedestal	• Two grommets in top	• One pullout writing shelf				

	Model	Overall	Cu. Ft.	Shp. Wt.	Fr. Cls.	Zone 1	Zone 2	Zone 3
Right Pedestal Desk 	V_721R2BF	72" W x 36" D x 29" H	51.6	298	110	3414	3533	3653
	V_651R2BF	66" W x 30" D x 29" H	40.2	262	110	2983	3087	3192
	• Box/Box/File Drawer in right pedestal	• Side locking pedestal	• Two grommets in top	• One pullout writing shelf				

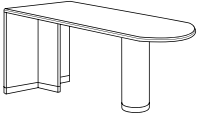
	Model	Overall	Cu. Ft.	Shp. Wt.	Fr. Cls.	Zone 1	Zone 2	Zone 3
Peninsula Desk 	V_799	72" W x 36" D x 29" H	51.6	162	125	2711	2806	2901
	• Use with bridge or return	• 1" thick end support panel	• 6" cylinder base					

Credenzas

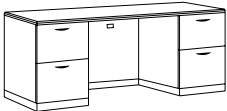
	Model	Overall	Cu. Ft.	Shp. Wt.	Fr. Cls.	Zone 1	Zone 2	Zone 3
Kneespace Credenza 	V_704F	72" W x 24" D x 29" H	35.7	279	110	3491	3613	3735
	V_604F	66" W x 24" D x 36" H	32.8	270	110	3273	3388	3502
	• File/File Drawer in each pedestal	• Individually locking pedestals	• One grommet in top of modesty panels					

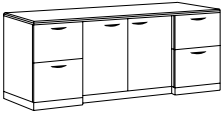
	Model	Overall	Cu. Ft.	Shp. Wt.	Fr. Cls.	Zone 1	Zone 2	Zone 3
Storage Credenza 	V_714F	72" W x 24" D x 29" H	35.7	333	125	4172	4318	4464
	V_614F	66" W x 24" D x 29" H	32.8	300	125	3950	4088	4227
			Optional Door Lock Y			95	95	95
	• Four File/File drawers (two left, two right)	• Individually locking pedestals	• Center storage compartment with one adjustable shelf					

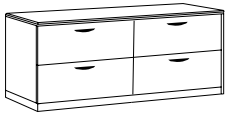
	Model	Overall	Cu. Ft.	Shp. Wt.	Fr. Cls.	Zone 1	Zone 2	Zone 3
Double Lateral File Credenza 	V_733	72" W x 24" D x 29" H	35.7	299	125	3430	3550	3670
						404	404	404
	• Four lateral file drawers	• Individually locking drawers						

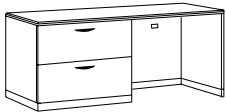

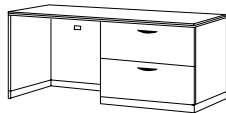
	Model	Overall	Cu. Ft.	Shp. Wt.	Fr. Cls.	Zone 1	Zone 2	Zone 3
Left Lateral File Credenza 	V_733L	72" W x 24" D x 29" H	35.7	253	125	3105	3214	3322
	V_633L	66" W x 24" D x 29" H	32.8	233	125	2987	3092	3196
						202	202	202
	• Two individually locking lateral file drawers on left	• One grommet in top of modesty panel						

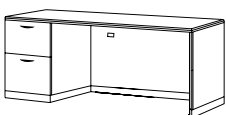
	Model	Overall	Cu. Ft.	Shp. Wt.	Fr. Cls.	Zone 1	Zone 2	Zone 3
Right Lateral File Credenza 	V_733R	72" W x 24" D x 29" H	35.7	253	125	3105	3214	3322
	V_633R	66" W x 24" D x 29" H	32.8	233	125	2987	3092	3196
						202	202	202
	• Two individually locking lateral file drawers on right	• One grommet in top of modesty panel						

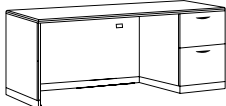

	Model	Overall	Cu. Ft.	Shp. Wt.	Fr. Cls.	Zone 1	Zone 2	Zone 3
Left Pedestal Credenza 	V_725LF	72" W x 24" D x 29" H	35.7	235	125	2843	2943	3042
	V_625LF	66" W x 24" D x 29" H	32.8	195	125	2699	2793	2888
	• Two side locking file drawers on left	• One grommet in top of modesty panel						

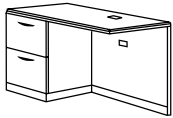
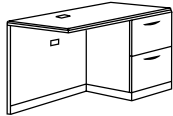
	Model	Overall	Cu. Ft.	Shp. Wt.	Fr. Cls.	Zone 1	Zone 2	Zone 3
Right Pedestal Credenza 	V_725RF	72" W x 24" D x 29" H	35.7	235	125	2843	2943	3042
	V_625RF	66" W x 24" D x 29" H	32.8	195	125	2699	2793	2888
	• Two side locking file drawers on right	• One grommet in top of modesty panel						

Returns & Bridges

	Model	Overall	Cu. Ft.	Shp. Wt.	Fr. Cls.	Zone 1	Zone 2	Zone 3
Left Pedestal Return	V_722LF	48" W x 24" D x 29" H	24.3	173	110	2315	2396	2477
	<ul style="list-style-type: none"> Two side locking file drawers on left 	<ul style="list-style-type: none"> Reverse coped for smooth transition/matches desk woodgrain direction 	<ul style="list-style-type: none"> One grommet in top of modesty panel 					
Right Pedestal Return	V_722RF	48" W x 24" D x 29" H	24.3	173	110	2315	2396	2477
	<ul style="list-style-type: none"> Two side locking file drawers on right 	<ul style="list-style-type: none"> Reverse coped for smooth transition/matches desk woodgrain direction 	<ul style="list-style-type: none"> One grommet in top of modesty panel 					
Bridge	V_485	48" W x 24" D x 29" H	4.0	80	110	1153	1193	1234
	<ul style="list-style-type: none"> Connects single drawer pedestal desks and credenzas 	<ul style="list-style-type: none"> Reverse coped for smooth transition/matches desk woodgrain direction 	<ul style="list-style-type: none"> Two grommets in modesty panel 					

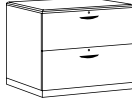
File & Storage

	Model	Overall	Cu. Ft.	Shp. Wt.	Fr. Cls.	Zone 1	Zone 2	Zone 3
Mobile Pedestal	V_21	16" W x 22" D x 22" H	6.0	87	100	1049	1086	1122
	<ul style="list-style-type: none"> Box and file drawer Side locking pedestal Dual wheel locking casters Top mounted pull for easy mobility 							
Two Drawer Lateral File	V_326	30.75" W x 20" D x 29" H	14.0	140	100	2192	2269	2345
	<ul style="list-style-type: none"> Two lateral file drawers Individually locking drawers Anti-tilt mechanism allows only one drawer to open at one time to avoid tipping 							
Executive Lateral File	V_346	36" W x 24" D x 29" H	18.8	197	100	2407	2491	2575
	<ul style="list-style-type: none"> Two lateral file drawers Individually locking drawers Counter weight prevents unit from tipping forward 							

	Model	Overall	Cu. Ft.	Shp. Wt.	Fr. Cls.	Zone 1	Zone 2	Zone 3
Three Drawer Lateral File 	V_336	30.75" W x 20" D x 44.5" H	21.7	208	100	2968	3072	3176
						303	303	303
		<ul style="list-style-type: none"> • Three lateral file drawers • Central locking 						<ul style="list-style-type: none"> • Anti-tilt mechanism allows only one drawer to open at one time to avoid tipping

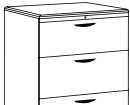
	Model	Overall	Cu. Ft.	Shp. Wt.	Fr. Cls.	Zone 1	Zone 2	Zone 3
Four Drawer Lateral File 	V_426	30.75" W x 20" D x 56" H	27.9	252	100	3986	4126	4265
						404	404	404
		<ul style="list-style-type: none"> • Four lateral file drawers • Central locking 						<ul style="list-style-type: none"> • Anti-tilt mechanism allows only one drawer to open at one time to avoid tipping

Bookcases

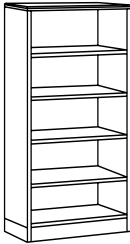
	Model	Overall	Cu. Ft.	Shp. Wt.	Fr. Cls.	Zone 1	Zone 2	Zone 3
Bookcase 	V_129	36" W x 18" D x 29" H	18.5	90	125	1019	1055	1090
	V_36	36" W x 18" D x 36" H	18.5	90	125	1088	1126	1164
	V_48	36" W x 18" D x 48" H	24.2	110	125	1155	1195	1236
	V_65	36" W x 18" D x 66.5" H	31.1	221	125	1321	1367	1413
	V_72	36" W x 18" D x 72" H	35.5	241	125	1495	1547	1600
	V_84	36" W x 18" D x 84" H	41.3	261	125	1697	1756	1816
		<ul style="list-style-type: none"> • One 1" thick adjustable shelf, fixed bottom in V_129 and V_36 • Two 1" thick adjustable shelves, fixed bottom shelf in V_48 • Three 1" thick adjustable shelves, fixed middle and bottom shelves in V_65 and V_72 • Four 1" adjustable shelves, fixed middle and bottom shelves in V_84 						

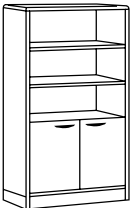
	Model	Overall	Cu. Ft.	Shp. Wt.	Fr. Cls.	Zone 1	Zone 2	Zone 3
Two Door Bookcase 	V_652D	36" W x 18" D x 66.5" H	31.9	230	125	1749	1810	1871
		<ul style="list-style-type: none"> • Two 1" thick adjustable shelves on top • Fixed shelf at top of doors • One 1" thick adjustable shelf behind doors 						

Overhead Storage

	Model	Overall	Cu. Ft.	Shp. Wt.	Fr. Cls.	Zone 1	Zone 2	Zone 3
Overhead Storage Unit	V_737	71" W x 18" D x 36.5" H	33.6	229	125	2772	2869	2966
	V_677	65" W x 18" D x 36.5" H	28.3	198	125	2618	2710	2801

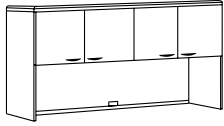

- Two overhead storage compartments
- One grommet in lower back panel
- 21" clearance to desk top surface
- Includes 720 lumen, 8 watt task light with 10' power cord

HWTB1472

14"H Tackboard for V_737



Overall	St. Ydg.	Cu. Ft.	Shp. Wt.	Fr. Cls.
68.75" W x 0.5" D x 14" H	2	2.6	6	100

	1	2/COM	3	4	5	6	7	8	9	10	11	12	13	14	15
Zone 1	313	331	356	374	391	417	443	470	492	525	552	587	623	651	686
Zone 2	324	343	368	387	405	432	459	486	509	543	571	608	645	674	710
Zone 3	335	354	381	400	418	446	474	503	526	562	591	628	667	697	734

- Fully tackable surface
- Field installation required

HWTB1466

14"H Tackboard for V_677



Overall	St. Ydg.	Cu. Ft.	Shp. Wt.	Fr. Cls.
63.25" W x 0.5" D x 14" H	2	2.6	6	100

	1	2/COM	3	4	5	6	7	8	9	10	11	12	13	14	15
Zone 1	313	331	356	374	391	417	443	470	492	525	552	587	623	651	686
Zone 2	324	343	368	387	405	432	459	486	509	543	571	608	645	674	710
Zone 3	335	354	381	400	418	446	474	503	526	562	591	628	667	697	734

- Fully tackable surface
- Field installation required

Reception Screens

	Model	Overall	Cu. Ft.	Shp. Wt.	Fr. Cls.	Zone 1	Zone 2	Zone 3
Reception Screen Main Desk	V_610	66" W x 28" D x 14" H	28.9	129	70	1673	1732	1790

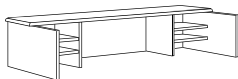

- Fits 66" W desks (V_6602BF, V_651L2BF, V_651R2BF)
- Four adjustable shelves
- Non-skid strips on bottom prohibit movement

	Model	Overall	Cu. Ft.	Shp. Wt.	Fr. Cls.	Zone 1	Zone 2	Zone 3
Reception Screen for Return	V_611L	48" W x 22" D x 13" H	1.5	25	70	375	388	401
	V_611R	48" W x 22" D x 13" H	1.5	25	70	375	388	401

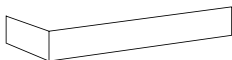

- V_611L fits on V_722LF
- V_611R fits on V_722RF
- Non-skid strips on bottom prohibit movement
- Hardware included to connect to V_61-

Accessories

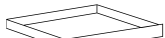
	Model	Overall	Cu. Ft.	Shp. Wt.	Fr. Cls.	Zone 1	Zone 2	Zone 3
Center Drawer 	V_22	22.5" W x 19" D x 3" H	1.5	10	100	216	224	231
	V_28	28" W x 19" D x 3" H	1.5	11	100	216	224	231
	V_34	38" W x 19" D x 3" H	2.2	14	100	216	224	231

- V_22 fits 66" single pedestal desks/credenza
- V_28 fits 72" single pedestal or 66" double pedestal desk/credenza
- V_34 fits 72" double pedestal desks/credenza

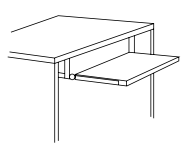
	Model	Overall	Cu. Ft.	Shp. Wt.	Fr. Cls.	Zone 1	Zone 2	Zone 3
Pullout Keyboard Platform 	PKP25_	25" W x 18" D x 3" H	2.0	15	100	249	258	266
	PKP35_	22" W x 18" D x 3" H	2.0	12	100	249	258	266
	PKMP36_	29" W x 18" D x 3" H	2.0	17	100	249	258	266

- PKP25 fits V_485 and double pedestal desks/credenzas
- PKP35 fits single pedestal desks/credenzas
- PKMP36 fits V_485 and double pedestal desks/credenzas

	Model	Overall	Cu. Ft.	Shp. Wt.	Fr. Cls.	Zone 1	Zone 2	Zone 3
Wire Management Channel 	MDWM	12" W x 2.25" D x 1.25" H	0.4	3	70	37	38	40

- Attaches under tops or to back panels
- Peel and stick self-adhesive
- Front opening for easy access



Tables





Bedford

MEETING TABLES - SIN 33721

Classic Styling, Modern Function

Bedford brings old world excellence to the contemporary office with a complete collection of meeting solutions. High pressure laminate tops feature solid hardwood edges that withstand everyday abuse from chair "bumps." Enhance any traditional environment with beautifully crafted lounge and office HPFi seating products.

Assembly

- Tables ship with top and base(s) in separate cartons
- Assembly is quick and easy by attaching bases to tops with bolts provided

Finishes

- High gloss, high pressure laminate (HPL) top
- Thermally fused laminate (TFL) on panel and square bases
- Finished solid wood on Queen Anne style base

Wire Management

- Add 3.25" x 1.875" rectangular diameter grommets for extended wire management capability

Edge Profile



How to Specify:

- 1 Series
- 2 Laminate finish
- 3 Model number
- 4 Option

Finished Example

TR/WC/T96

Top & Base Finishes	Code
Mahogany	M
Windsor Cherry	WC

Options	Code	Price
Additional Grommet	G	138

Power

PowerFlex power modules can be installed in many locations. See page 36 for options.

Laminate Tops

- Traditional design
- 1.188" thick tops with hardwood edge
- High-gloss, high pressure laminate (HPL) surface

- Work surface dimensions will vary due to edge profile treatment



Round
36", 42", 48"
Freight Class 85

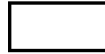

Rectangular
72", 96"
Freight Class 100

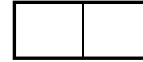

Rectangular
(Two Piece Top)
120", 144"
Freight Class 92.5

Laminate Bases

- Straight Leg, Square and X Bases are 1" thick thermally fused laminate (TFL)

- Freight Class is same for 2 or 3 piece bases



Straight Leg
Freight Class 85



Straight Leg
Freight Class 85



Square Base
Freight Class 125

Wood Bases

- Queen Anne Style Bases are carved solid wood

- Bases have four fluted feet with brass foot caps



Queen Anne Style
Freight Class 300

Round Table with
Four-Footed Pedestal



Model	Overall	Cu. Ft.	Shp. Wt.	Fr. Cls.	Zone 1	Zone 2	Zone 3
TR_TR36	36" W x 29" H	18.6	73	300	1703	1763	1822
TR_TR42 NOW	42" W x 29" H	18.8	85	300	2101	2175	2248
TR_TR48 NOW	48" W x 29" H	20.0	96	300	2353	2435	2518

- NOW finish M

- Ships in two cartons

Bedford

	Model	Overall	Cu. Ft.	Shp. Wt.	Fr. Cls.	Zone 1	Zone 2	Zone 3
Rectangular Table, Four-footed Pedestal Bases	TR_T72P4	72" W x 36" D x 29" H	52.6	170	300	4169	4315	4461
	TR_T96P4	96" W x 42" D x 29" H	56.1	224	300	4853	5023	5193

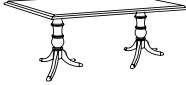

- One-piece top
- Ships in three cartons

	Model	Overall	Cu. Ft.	Shp. Wt.	Fr. Cls.	Zone 1	Zone 2	Zone 3
Rectangular Table, Four-Footed Pedestal Base	TR_T120P4	120" W x 42" D x 29" H	83.6	327	300	8236	8524	8813
	TR_T144P4	144" W x 42" D x 29" H	87.7	371	300	8958	9272	9585

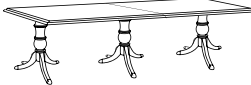

- Two-piece top, wood grain will not match at seam
- Ships in four cartons

	Model	Overall	Cu. Ft.	Shp. Wt.	Fr. Cls.	Zone 1	Zone 2	Zone 3
Rectangular Table, Square Bases	TR_T72SQ	72" W x 36" D x 29" H	31.8	230	125	2886	2987	3088
	TR_T96SQ	96" W x 42" D x 29" H	34.6	295	125	3531	3655	3778



- One-piece top
- Ships in three cartons

	Model	Overall	Cu. Ft.	Shp. Wt.	Fr. Cls.	Zone 1	Zone 2	Zone 3
Rectangular Table, Square Bases	TR_T120SQ	120" W x 42" D x 29" H	50.6	402	125	6287	6507	6727
	TR_T144SQ	144" W x 42" D x 29" H	54.7	446	125	7085	7333	7581

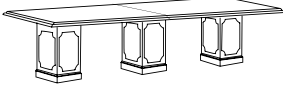

- Two-piece top, wood grain will not match at seam
- Ships in four cartons

	Model	Overall	Cu. Ft.	Shp. Wt.	Fr. Cls.	Zone 1	Zone 2	Zone 3
Rectangular Table 	TR_T72 NOW	72" W x 36" D x 29" H	15.3	181	100	2226	2304	2382
	TR_T96 NOW	96" W x 42" D x 29" H	18.9	235	100	3001	3106	3211
	• NOW finish M	• One-piece top	• Ships in two cartons					

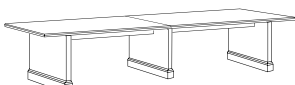
	Model	Overall	Cu. Ft.	Shp. Wt.	Fr. Cls.	Zone 1	Zone 2	Zone 3
Rectangular Table 	TR_T120	120" W x 42" D x 29" H	27.3	322	92.5	5065	5242	5420
	TR_T144	144" W x 42" D x 29" H	31.6	366	92.5	5613	5809	6006
	• Two-piece top, wood grain will not match at seam	• Ships in two cartons						

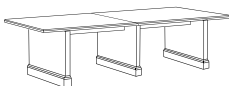
	Model	Overall	Cu. Ft.	Shp. Wt.	Fr. Cls.	Zone 1	Zone 2	Zone 3
Expandable Rectangular Table 	TE_T4896	96" W x 48" D x 29" H	20.0	316	100	4243	4392	4540
	• Two-piece top, vertical grain will not match at seam	• Ships in two cartons						

	Model	Overall	Cu. Ft.	Shp. Wt.	Fr. Cls.	Zone 1	Zone 2	Zone 3
Extension for Expandable Rectangular Table 	TE_T4848A	48" W x 48" D x 29" H	12.4	149	100	2051	2123	2195
	• One-piece top, vertical grain will not match adjoining top	• Ships in two cartons						



Hyperwork

MEETING TABLES - SIN 33721

Contemporary design

As on all Hyperwork casegoods and Educational furnishings, Hyperwork conference furnishings feature high durability AdvantEdge 3mm PVC edge banding. AdvantEdge provides an increased impact resistance for long-lasting beauty and performance. Expandable Hyperwork tables allow you to extend table size in 48" increments as the need for meeting space grows. Expandable Hyperwork tables feature a cross grain pattern on woodgrain laminates to eliminate matching issues with table top add-ons.

Assembly

- Tables ship with top and base(s) in separate cartons
- Assembly is quick and easy by attaching bases to tops with bolts or screws provided

Finishes

- Select a color combination with contrasting top and base, or choose monocolor for same top and base
- Monocolor models use a single finish designator

Wire Management

- Add 2.5" diameter grommets for extended wire management capability

Edge Profile



How to Specify:

- 1 Series
- 2 Laminate finish top
- 3 Laminate finish base (if different)
- 4 Model number
- 5 Options

Finished Example

HW/FM/RT12048

Top and Base Finishes	Code
Black	E
Boardwalk	SB
Boardwalk (Textured)	BW
Driftwood	SD
Driftwood (Textured)	DW
Espresso	X
Graphite	GP
Mahogany	M
Monticello Maple	MM
Natural Maple	FM
Shoreline	SS
Shoreline (Textured)	SL
Windsor Cherry	WC

Options	Code	Price
Box Base	B	477 (per base)
Grommet	G	138

Power

PowerFlex power modules can be installed in many locations. See page 36 for options.

Laminate Tops

- Contemporary design
- 1" thick tops with 3mm PVC AdvantEdge
- 1" thick smooth top option for textured laminates

- Thermally fused laminate
- High Pressure Laminate surface optional



Round
36", 42", 48"
Freight Class 85



Racetrack
72", 96" Length
Freight Class 100

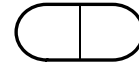

Racetrack
(Two Piece Top)
120", 144" Length
Freight Class 92.5

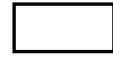

Rectangular
72", 96"
Freight Class 100



Boat-Shaped
72", 96" Length
Freight Class 100

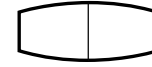

Boat-Shaped
(Two Piece Top)
120", 144" Length
Freight Class 92.5

Laminate Bases

- 1" thick thermally fused laminate on X-Base and Straight Base
- 6.25" Box Base (B option) is hollow for easy wire management

- 3 mm PVC AdvantEdge banding
- Freight Class is same for 2 or 3 piece bases



X Base
Freight Class 175



Straight Leg
Freight Class 85



Box Base (B)
Freight Class 175

Round Table



Model	Overall	Cu. Ft.	Shp. Wt.	Fr. Cls.	Zone 1	Zone 2	Zone 3
HW_TR36	36" W x 29" H	10.7	85	175	994	1029	1064
HW_TR42	42" W x 29" H	14.8	109	175	1203	1245	1287
HW_TR48	48" W x 29" H	17.1	120	175	1268	1312	1357

- X-Base
- Ships in two cartons

Rectangular Table

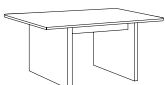

Model	Overall	Cu. Ft.	Shp. Wt.	Fr. Cls.	Zone 1	Zone 2	Zone 3
HW_T7236	72" W x 36" D x 29" H	13.8	159	100	1249	1293	1336
HW_T9648	96" W x 48" D x 29" H	21.6	245	100	1603	1659	1715
Box Bases B					954	954	954

- One-piece top
- Ships in two cartons
- Straight legs ship in one carton
- Optional Box Bases ship in individual cartons (total of three cartons per table)

Hyperwork

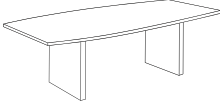
	Model	Overall	Cu. Ft.	Shp. Wt.	Fr. Cls.	Zone 1	Zone 2	Zone 3
Boat-Shaped Table 	HW_BT7236	72" W x 36" D x 29" H	13.8	144	100	1531	1585	1638
	HW_BT9648	96" W x 48" D x 29" H	21.6	225	100	1802	1865	1928
			Box Bases B			954	954	954
	• One-piece top	• Ships in two cartons	• Straight legs ship in one carton			• Optional Box Bases ship in individual cartons (total of three cartons per table)		

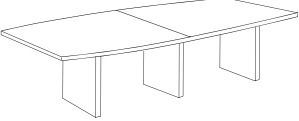
	Model	Overall	Cu. Ft.	Shp. Wt.	Fr. Cls.	Zone 1	Zone 2	Zone 3
Boat-Shaped Table 	HW_BT12048	120" W x 48" D x 29" H	27.0	310	100	2260	2339	2418
	HW_BT14448	144" W x 48" D x 29" H	32.0	356	100	2420	2505	2589
			Box Bases B			1431	1431	1431
	• Two-piece top, wood grain will not match at seam	• Ships in two cartons	• Straight legs ship in one carton			• Optional Box Bases ship in individual cartons (total of four cartons per table)		

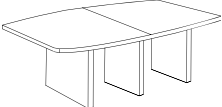
	Model	Overall	Cu. Ft.	Shp. Wt.	Fr. Cls.	Zone 1	Zone 2	Zone 3
Expandable Boat-Shaped Table 	E_BT4896	96" W x 48" D x 29" H	20.0	278	100	2828	2927	3026
			Box Bases B			1431	1431	1431
		• Two-piece top, vertical grain will not match adjoining top	• Ships in two cartons	• Straight legs ship in one carton			• Optional Box Bases ship in individual cartons (total of four cartons per table)	

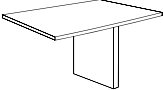
	Model	Overall	Cu. Ft.	Shp. Wt.	Fr. Cls.	Zone 1	Zone 2	Zone 3
Center extension for Expandable Boat-Shaped Table 	E_T4848A	48" W x 48" D x 29" H	12.4	138	100	1554	1608	1663
			Box Bases B			477	477	477
		• One-piece top, vertical grain will not match adjoining top	• Ships in two cartons	• Straight leg standard				

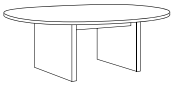
	Model	Overall	Cu. Ft.	Shp. Wt.	Fr. Cls.	Zone 1	Zone 2	Zone 3
Racetrack Table 	HW_RT7236	72" W x 36" D x 29" H	13.8	144	100	1531	1585	1638
	HW_RT9648	96" W x 48" D x 29" H	21.6	225	100	1802	1865	1928
			Box Bases B			954	954	954
	• One-piece top	• Ships in two cartons	• Straight legs ship in one carton		• Optional Box Bases ship in individual cartons (total of three cartons per table)			

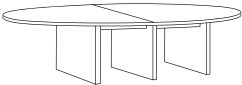
	Model	Overall	Cu. Ft.	Shp. Wt.	Fr. Cls.	Zone 1	Zone 2	Zone 3
Racetrack Table 	HW_RT12048	120" W x 48" D x 29" H	27.0	310	100	2260	2339	2418
	HW_RT14448	144" W x 48" D x 29" H	32.0	356	100	2420	2505	2589
			Box Bases B			1431	1431	1431
	• Two-piece top, wood grain will not match at seam	• Ships in two cartons	• Straight legs ship in one carton		• Optional Box Bases ship in individual cartons (total of four cartons per table)			



Hyperwork Education

MOBILE STORAGE TABLES - SIN 33721

Collaboration Meets Mobile Storage

Hyperwork Education Mobile Storage Tables feature storage area bases with a choice of square, round or clover-shaped tops and three heights - Desk (29"), Counter (36") and Stand-Up (41"). The tables are perfect for a small team gathering of up to four people. Storage cubbies underneath enable you to safely and securely tuck away handbags, backpacks and other portable personal belongings. Each table features 4 heavy-duty, twin-wheel lockable casters to easily move and rearrange to meet your varying needs.

Product Details

- Shipped with fully assembled cases
- Shelf placement is the only assembly
- Each shelf comes with 4 screws to affix at the desired location
- Unit is comprised of thermally fused laminate (TFL)
- 1" thick core tops, .75" core storage area and doors (where included).

Packing

- All units are packed in heavy duty cartons with heavy duty corner pads
- All packaging conforms to or exceeds specifications as outlined in the Uniform Freight Classification.

Edge Profile



How to Specify:

- 1 Series
- 2 Laminate finish
- 3 Model number

Finished Example

H/DW/C/410S

Finishes	Code
Black	E
Boardwalk (Textured)	BW
Driftwood (Textured)	DW
Espresso	X
Graphite	GP
Mahogany	M
Monticello Maple	MM
Natural Maple	FM
Shoreline (Textured)	SL
Windsor Cherry	WC

Pulls	Code
Brushed Chrome	W
Ebony	E
Oval Nickel	D
Ribbon	R
Swoosh	S
T-Bar Nickel	V

Options	Code	Price
Door Lock (per pair)	Y	95

Hyperwork Education Mobile Storage Tables

	Model	Overall	Cu. Ft.	Shp. Wt.	Fr. Cls.	Zone 1	Zone 2	Zone 3
Clover Table, Open Storage	H_C300S	60" W x 60" D x 30" H				2737	2833	2929
	H_C360S	60" W x 60" D x 36" H				2783	2880	2977
	H_C410S	60" W x 60" D x 41" H				2829	2928	3027



- 4 - 13.88" W x 13.75" D open cubby compartments per side
- 11.16" H compartments in 30" (overall height) models
- 14.18" H compartments in 36" (overall height) models
- 16.66" H compartments in 41" (overall height) models

	Model	Overall	Cu. Ft.	Shp. Wt.	Fr. Cls.	Zone 1	Zone 2	Zone 3
Clover Table, Enclosed Storage, 2 Doors per Side	H_C304D	60" W x 60" D x 30" H				2900	3001	3103
	H_C364D	60" W x 60" D x 36" H				2981	3086	3190
	H_C414D	60" W x 60" D x 41" H				3276	3391	3506



- 4 - 13.88" W x 13.75" D cubby compartments per side
- 11.16" H compartments in 30" (overall height) models
- XX" H cubby compartments in 36" (overall height) models
- 16.66" H compartments in 41" (overall height) models

	Model	Overall	Cu. Ft.	Shp. Wt.	Fr. Cls.	Zone 1	Zone 2	Zone 3
Clover Table, Enclosed Storage, 4 Doors per Side	H_C308D	60" W x 60" D x 30" H				3113	3222	3331
	H_C368D	60" W x 60" D x 36" H				3342	3459	3576
	H_C418D	60" W x 60" D x 41" H				3469	3590	3712



- 4 - 13.88" W x 13.75" D cubby compartments per side
- 11.16" H compartments in 30" (overall height) models
- XX" H cubby compartments in 36" (overall height) models
- 16.66" H compartments in 41" (overall height) models

Hyperwork Education Mobile Storage Tables

	Model	Overall	Cu. Ft.	Shp. Wt.	Fr. Cls.	Zone 1	Zone 2	Zone 3
Round Table, Open Storage	H_R300S	60" W x 60" D x 30" H				2737	2833	2929
	H_R360S	60" W x 60" D x 36" H				2783	2880	2977
	H_R410S	60" W x 60" D x 41" H				2829	2928	3027



• 4 - 13.88" W x 13.75" D open cubby compartments per side

• 11.16" H compartments in 30" (overall height) models

• 14.18" H compartments in 36" (overall height) models

• 16.66" H compartments in 41" (overall height) models

	Model	Overall	Cu. Ft.	Shp. Wt.	Fr. Cls.	Zone 1	Zone 2	Zone 3
Round Table, Enclosed Storage, 2 Doors per Side	H_ _R304D	60" W x 60" D x 30" H				2900	3001	3103
	H_ _R364D	60" W x 60" D x 36" H				2981	3086	3190
	H_ _R414D	60" W x 60" D x 41" H				3276	3391	3506



• 4 - 13.88" W x 13.75" D cubby compartments per side

• 11.16" H compartments in 30" (overall height) models

• 14.18" H compartments in 36" (overall height) models

• 16.66" H compartments in 41" (overall height) models

	Model	Overall	Cu. Ft.	Shp. Wt.	Fr. Cls.	Zone 1	Zone 2	Zone 3
Round Table, Enclosed Storage, 4 Doors per Side	H_ _R308D	60" W x 60" D x 30" H				3113	3222	3331
	H_ _R368D	60" W x 60" D x 36" H				3342	3459	3576
	H_ _R418D	60" W x 60" D x 41" H				3469	3590	3712



• 4 - 13.88" W x 13.75" D cubby compartments per side

• 11.16" H compartments in 30" (overall height) models

• 14.18" H compartments in 36" (overall height) models

• 16.66" H compartments in 41" (overall height) models

Hyperwork Education Mobile Storage Tables

	Model	Overall	Cu. Ft.	Shp. Wt.	Fr. Cls.	Zone 1	Zone 2	Zone 3
Square Table, Open Storage 	H_S300S	60" W x 60" D x 30" H				2737	2833	2929
	H_S360S	60" W x 60" D x 36" H				2783	2880	2977
	H_S410S	60" W x 60" D x 41" H				2829	2928	3027

•4 - 13.88" W x 13.75" D open cubby compartments per side
 •11.16" H compartments in 30" (overall height) models
 •14.18" H compartments in 36" (overall height) models
 •16.66" H compartments in 41" (overall height) models

	Model	Overall	Cu. Ft.	Shp. Wt.	Fr. Cls.	Zone 1	Zone 2	Zone 3
Square Table, Enclosed Storage, 2 Doors per Side 	H_ _S304D	60" W x 60" D x 30" H				2900	3001	3103
	H_ _S364D	60" W x 60" D x 36" H				2981	3086	3190
	H_ _S414D	60" W x 60" D x 41" H				3276	3391	3506

•4 - 13.88" W x 13.75" D cubby compartments per side
 •11.16" H compartments in 30" (overall height) models
 •14.18" H compartments in 36" (overall height) models
 •16.66" H compartments in 41" (overall height) models

	Model	Overall	Cu. Ft.	Shp. Wt.	Fr. Cls.	Zone 1	Zone 2	Zone 3
Square Table, Enclosed Storage, 4 Doors per Side 	H_ _S308D	60" W x 60" D x 30" H				3113	3222	3331
	H_ _S368D	60" W x 60" D x 36" H				3342	3459	3576
	H_ _S418D	60" W x 60" D x 41" H				3469	3590	3712

•4 - 13.88" W x 13.75" D cubby compartments per side
 •11.16" H compartments in 30" (overall height) models
 •14.18" H compartments in 36" (overall height) models
 •16.66" H compartments in 41" (overall height) models



Matrix

MEETING TABLES - SIN 33721

The Answer for "Touchdown Spaces"

Matrix tables are HPFi's answer to the need for "touchdown spaces." They offer a place to read and respond to emails, texts, social media and voice mail. They also provide meeting space for teams to gather and collaborate on projects. When we are on the move taking our work or school projects along - Matrix will be there when you land!

Assembly

- Tables ship with top and base(s) in separate cartons
- Assembly is quick and easy by attaching bases to tops with bolts or screws provided

Finishes

- Select a color combination with contrasting top and base, or choose monocolor for same top and base
- Monocolor models use a single finish designator

Wire Management

- Add 2.5" diameter grommets for extended wire management capability

Edge Profile



How to Specify:

- 1** Series
- 2** Laminate finish top
- 3** Laminate finish base (if different)
- 4** Model number
- 5** Options

Finished Example

M/SS/DW/RB624P

Top and Base Finishes	Code
Black	E
Boardwalk (Textured)	BW
Driftwood (Textured)	DW
Espresso	X
Graphite	GP
Mahogany	M
Monticello Maple	MM
Natural Maple	FM
Shoreline (Textured)	SL
Windsor Cherry	WC

Options	Code	Price
Grommet	G	138

Smooth Top Finishes	Code
Smooth Boardwalk	SB
Smooth Driftwood	SD
Smooth Shoreline	SS

Power

PowerFlex power modules can be installed in many locations. See page 36 for options.

Tops

- 1" thick tops with 3mm PVC AdvantEdge
- Rectangular tops are 24" or 30" deep
- Tapered tops are 24" on short end, 36" on wide end or 30" on short and 42" on wide end

- Smooth top option for textured laminates
- Thermally fused laminate (TFL)
- High Pressure Laminate (HPL) surface optional

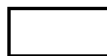

Rectangular
72", 96"
Freight Class 100



Tapered
72", 96" Length
Freight Class 100

Bases

- 1" thick tapered thermally fused laminate (TFL) side panels
- .75" thick TFL or perforated steel insert between side panels

- 36" counter height or 42" standing height
- Open base design allows channeling power to the floor
- Adjustable glides compensate for uneven floors



All Laminate
Freight Class 100



Perforated Insert
Freight Class 100

Rectangular Top, All-Laminate Bases

Counter Height Table



Model	Overall	Cu. Ft.	Shp. Wt.	Fr. Cls.	Zone 1	Zone 2	Zone 3
M_RC624	72" W x 24" D x 36" H	18.0	234	100	2151	2226	2302
M_RC630	72" W x 30" D x 36" H	22.5	252	100	2332	2414	2495
M_RC824	96" W x 24" D x 36" H	20.0	246	100	2502	2590	2677
M_RC830	96" W x 30" D x 36" H	25.0	264	100	2679	2773	2867

- 36" counter height

- Ships in three cartons

Standing Height Table



Model	Overall	Cu. Ft.	Shp. Wt.	Fr. Cls.	Zone 1	Zone 2	Zone 3
M_RB624	72" W x 24" D x 42" H	20.0	246	100	2283	2363	2443
M_RB630	72" W x 30" D x 42" H	24.5	272	100	2763	2860	2956
M_RB824	96" W x 24" D x 42" H	22.0	278	100	2633	2725	2817
M_RB830	96" W x 30" D x 42" H	27.0	284	100	2811	2909	3008

- 42" standing height

- Ships in three cartons

Matrix

Tapered Top, All-Laminate Bases

	Model	Overall	Cu. Ft.	Shp. Wt.	Fr. Cls.	Zone 1	Zone 2	Zone 3
Counter Height Table 	M_TC636	72" W x 36/24" D x 36" H	21.0	252	100	2419	2504	2588
	M_TC642	72" W x 42/30" D x 36" H	24.0	258	100	2600	2691	2782
	M_TC836	96" W x 36/24" D x 36" H	24.0	264	100	2699	2793	2888
	M_TC842	96" W x 42/30" D x 36" H	29.0	270	100	2909	3011	3113

•36" counter height

•Ships in three cartons

	Model	Overall	Cu. Ft.	Shp. Wt.	Fr. Cls.	Zone 1	Zone 2	Zone 3
Standing Height Table 	M_TB636	72" W x 36/24" D x 42" H	23.0	270	100	2550	2639	2729
	M_TB642	72" W x 42/30" D x 42" H	27.5	278	100	2732	2828	2923
	M_TB836	96" W x 36/24" D x 42" H	26.0	282	100	2828	2927	3026
	M_TB842	96" W x 42/30" D x 42" H	31.0	290	100	3040	3146	3253

•42" standing height

•Ships in three cartons

Rectangular Top, Perforated Steel Insert Bases

	Model	Overall	Cu. Ft.	Shp. Wt.	Fr. Cls.	Zone 1	Zone 2	Zone 3
Counter Height Table 	M_RC624P	72" W x 24" D x 36" H	18.0	234	100	3092	3200	3308
	M_RC630P	72" W x 30" D x 36" H	22.5	252	100	3364	3482	3599
	M_RC824P	96" W x 24" D x 36" H	20.0	246	100	3442	3562	3683
	M_RC830P	96" W x 30" D x 36" H	25.0	264	100	3714	3844	3974

•36" counter height

•Ships in three cartons

	Model	Overall	Cu. Ft.	Shp. Wt.	Fr. Cls.	Zone 1	Zone 2	Zone 3
Standing Height Table 	M_RB624P	72" W x 24" D x 42" H	20.0	246	100	3315	3431	3547
	M_RB630P	72" W x 30" D x 42" H	24.5	272	100	3589	3715	3840
	M_RB824P	96" W x 24" D x 42" H	22.0	278	100	3667	3795	3924
	M_RB830P	96" W x 30" D x 42" H	27.0	284	100	3939	4077	4215

•42" standing height

•Ships in three cartons

Tapered Top, Perforated Steel Insert Bases

	Model	Overall	Cu. Ft.	Shp. Wt.	Fr. Cls.	Zone 1	Zone 2	Zone 3
Counter Height Table 	M_TC636P	72" W x 36/24" D x 36" H	22.5	252	100	3356	3473	3591
	M_TC642P	72" W x 42/30" D x 36" H	25.5	258	100	3635	3762	3889
	M_TC836P	96" W x 36/24" D x 36" H	24.0	264	100	3638	3765	3893
	M_TC842P	96" W x 42/30" D x 36" H	29.0	270	100	3944	4082	4220

•36" counter height

•Ships in three cartons

	Model	Overall	Cu. Ft.	Shp. Wt.	Fr. Cls.	Zone 1	Zone 2	Zone 3
Standing Height Table 	M_TB636P	72" W x 36/24" D x 42" H	23.0	270	100	3584	3709	3835
	M_TB642P	72" W x 42/30" D x 42" H	27.5	278	100	3859	3994	4129
	M_TB836P	96" W x 36/24" D x 42" H	26.0	282	100	3862	3997	4132
	M_TB842P	96" W x 42/30" D x 42" H	31.0	290	100	4168	4314	4460

•42" standing height

•Ships in three cartons



Vitality

MEETING TABLES - SIN 33721

Transitional Style, Contemporary Function

Transitional style tables perfect for adding small meeting space to private offices where Vitality casegoods are installed.

Assembly

- Tables ship with top and base(s) in separate cartons
- Assembly is quick and easy by attaching bases to tops with bolts provided

Finishes

- High gloss, High pressure laminate (HPL) top
- Thermally fused laminate (TFL) on panel bases
- Finished wood veneer on cylinder base

Wire Management

- Add 3.25" x 1.875" rectangular diameter grommets for extended wire management capability

Edge Profile



Laminate Tops

- Transitional Design
- 1.188" thick tops with Hardwood Edge

- High-Gloss, High Pressure Laminate (HPL) surface



Round
42", 48"
Freight Class 85

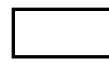

Rectangular
72"
Freight Class 100



Rectangular
96"
Freight Class 92.5



Rectangular
(Two Piece Top)
120", 144"
Freight Class 92.5

Laminate & Veneer Bases

- Straight Leg, Square and X Bases are 1" thick thermally fused laminate (TFL)

- Cylinder base is veneer surface
- Freight Class is same for 2 or 3 piece base set



X Base
Freight Class 175



Straight Leg
Freight Class 85



Cylinder Base
Freight Class 92.5

How to Specify:

- 1 Series
- 2 Laminate finish
- 3 Model number
- 4 Option

Finished Example

V/M/T96

Top & Base Finishes	Code
Mahogany	M
Windsor Cherry	WC

Options	Code	Price
Grommet	G	138

Power

PowerFlex power modules can be installed in many locations. See page 36 for options.

	Model	Overall	Cu. Ft.	Shp. Wt.	Fr. Cls.	Zone 1	Zone 2	Zone 3
 Round Table with Cylinder Base	V_TR36C	36" W x 29" H	10.7	126	92.5	2281	2361	2441
	V_TR42C	42" W x 29" H	11.6	150	92.5	2704	2799	2893
	V_TR48C	48" W x 29" H	12.8	162	92.5	2945	3048	3151
	<ul style="list-style-type: none"> •18" Diameter cylinder base •Ships in two cartons 							

	Model	Overall	Cu. Ft.	Shp. Wt.	Fr. Cls.	Zone 1	Zone 2	Zone 3
 Round Table with X-Base	V_TR42X	42" W x 29" H	14.8	100	150	1645	1703	1760
	V_TR48X	48" W x 29" H	16.0	112	150	1913	1980	2047
	<ul style="list-style-type: none"> •X-Base •Ships in two cartons 							

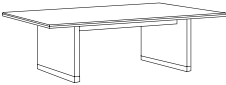
	Model	Overall	Cu. Ft.	Shp. Wt.	Fr. Cls.	Zone 1	Zone 2	Zone 3
 Rectangular Table with Straight Legs	V_T72	72" W x 36" D x 29" H	13.8	165	92.5	2153	2228	2304
	V_T96	96" W x 42" D x 29" H	17.4	230	92.5	2944	3047	3150
	<ul style="list-style-type: none"> •One-piece top •Ships in two cartons 							

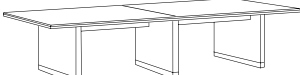
	Model	Overall	Cu. Ft.	Shp. Wt.	Fr. Cls.	Zone 1	Zone 2	Zone 3
 Rectangular Table with Straight Legs	V_T120	120" W x 42" D x 29" H	27.0	307	92.5	3744	3875	4006
	V_T144	144" W x 42" D x 29" H	32.0	344	92.5	4077	4220	4362
	<ul style="list-style-type: none"> •Two-piece top, wood grain will not match at seam •Ships in two cartons 							

	Model	Overall	Cu. Ft.	Shp. Wt.	Fr. Cls.	Zone 1	Zone 2	Zone 3
 Rectangular Table with Cylinder Base	V_T72CYL	72" W x 36" D x 29" H	31.7	310	92.5	4844	5014	5183
	V_T96CYL	96" W x 42" D x 29" H	35.3	357	92.5	5251	5435	5619
	<ul style="list-style-type: none"> •Two 18" diameter cylinder bases on 72" table 	<ul style="list-style-type: none"> •Two 22" diameter cylinder bases on 96" table 	<ul style="list-style-type: none"> •One-piece top 	<ul style="list-style-type: none"> •Ships in three cartons 				

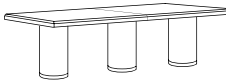
	Model	Overall	Cu. Ft.	Shp. Wt.	Fr. Cls.	Zone 1	Zone 2	Zone 3
 Rectangular Table with Cylinder Base	V_T120CYL	120" W x 42" D x 29" H	52.4	492	92.5	7048	7295	7541
	V_T144CYL	144" W x 42" D x 29" H	56.5	536	92.5	7887	8163	8439
	<ul style="list-style-type: none"> •Three 22" diameter cylinder bases 	<ul style="list-style-type: none"> •Two-piece top, wood grain will not match at seam 	<ul style="list-style-type: none"> •Two-piece top, wood grain will not match at seam 	<ul style="list-style-type: none"> •Ships in four cartons 				

Meeting Accessories

Pulls	Code	Finishes	Code
Brushed Chrome	W	Black	E
Ebony	E	Boardwalk	BW
Ribbon	R	Driftwood	DW
Swoosh	S	Espresso	X
Oval Nickel	D	Graphite	GP
T-Bar Nickel	V	Mahogany	M
		Monticello Maple	MM
		Natural Maple	FM
		Shoreline	SL
		Windsor Cherry	WC

MEETING TABLES - SIN 33721

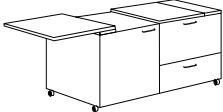
	Zone 1	Zone 2	Zone 3
H_2248	2183	2259	2336
Mobile Server Credenza			
			
	Cu. Ft.	Shp. Wt.	Fr. Cls.
	25.3	228	125
	Overall		
	48" W x 24.5" D x 30.75" H		
	<ul style="list-style-type: none"> • Flip-open top with concealed hinges extend surface to 72"W and 31.75"H • Inside Drawer Dimensions: 20" x 18" x 13" top right (stores 2 liter bottles upright) 20" x 18" x 8" bottom right • Inside compartment dimensions: 22" x 21" x 24" left side • Door compartment includes nine holes for ventilation of small refrigerator • Casters for mobility 		

	Zone 1	Zone 2	Zone 3
H_2224	1925	1992	2060
Mobile Server Cart			
			
	Cu. Ft.	Shp. Wt.	Fr. Cls.
	16.7	150	100
	Overall		
	24.25" W x 24.5" D x 30.75" H		
	<ul style="list-style-type: none"> • Flip-open top extends top surface to 36.25"W and 31.75"H • Top drawer 20" x 18" x 13"H stores 2-liter soda bottles upright • Bottom drawer 20" x 18" x 8"H • Casters for mobility • 3/8" thick drawer bottoms 		

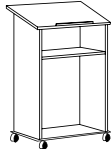
	Zone 1	Zone 2	Zone 3
HW_LS46C	1020	1056	1091
Standing Lectern			
			
	Cu. Ft.	Shp. Wt.	Fr. Cls.
	13.8	83	125
	Overall		
	24" W x 16.75" D x 46" H		
	<ul style="list-style-type: none"> • Pencil/document catch on angled surface • 2 storage shelves for presentation materials • 4 casters (2 locking) included and to be field installed 		

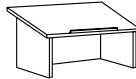
	Zone 1	Zone 2	Zone 3
HW_LS18	536	555	574
Table Top Lectern			
			
	Cu. Ft.	Shp. Wt.	Fr. Cls.
	5.0	20	125
	Overall		
	24" W x 14" D x 18" H		
	<ul style="list-style-type: none"> • Fits on any table top • Hardwood pencil/document ledge • Mar-resistant laminate finish • Non-skid gasket on bottom edges 		

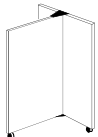
	Zone 1	Zone 2	Zone 3
HW_MTB	1524	1577	1631
Mobile Teaming Board			
			
	Cu. Ft.	Shp. Wt.	Fr. Cls.
	13.2	178	100
	Overall		
	49" W x 24" D x 72" H		
	<ul style="list-style-type: none"> • Dry-Erase whiteboard both sides • Includes markers, eraser and mountable holder • Assembly required • Casters for mobility • Tack board available 		

	Zone 1	Zone 2	Zone 3
HW_MBTB	666	689	713
Tack Board for Mobile Teaming Board			
			
	Cu. Ft.	Shp. Wt.	Fr. Cls.
	3.1	20	100
	Overall		
	47.5" W x .5" D x 36.5" H		
	<ul style="list-style-type: none"> • Fully tackable surface • Grade 1 fabric (Dorset Black) • Mounts to Mobile Teaming Board 		

Meeting Accessories

	Zone 1	Zone 2	Zone 3
H_754	3072	3180	3287
Buffet Credenza with Bookcase Storage			
	Cu. Ft.	Shp. Wt.	Fr. Cls.
	39.0	375	125
Overall			
72" W x 24" D x 29" H			

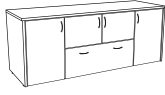

- Storage compartment behind two doors top/center (36"W x 21"D x 12"H)
- Lateral file drawer with filing hardware bottom/center
- Bookcase storage compartments with one adjustable shelf behind door on right and left sides

	Zone 1	Zone 2	Zone 3
H_4D4SBC	3221	3334	3446
Buffet Credenza, 4 Drawer, 4 Storage			
	Cu. Ft.	Shp. Wt.	Fr. Cls.
	41.0	365	125
Overall			
63.5" W x 24" D x 36" H			



- Four drawers in top
- Two storage compartments with one adjustable shelf each behind four doors
- 36" buffet height

	Zone 1	Zone 2	Zone 3
H_6518SL	1804	1867	1930
Left Storage Tower			
	Cu. Ft.	Shp. Wt.	Fr. Cls.
	22.3	189	125
Overall			
18" W x 24" D x 65.5" H			



- Full-height door hinged on left
- Four adjustable shelves

	Zone 1	Zone 2	Zone 3
H_6518SR	1804	1867	1930
Right Storage Tower			
	Cu. Ft.	Shp. Wt.	Fr. Cls.
	22.3	189	125
Overall			
18" W x 24" D x 65.5" H			



- Full-height door hinged on right
- Four adjustable shelves

	Zone 1	Zone 2	Zone 3
H_717-O	1141	1181	1221
Video Overhead Cabinet			
	Cu. Ft.	Shp. Wt.	Fr. Cls.
	31.4	168	125
Overall			
72" W x 16" D x 36.5" H			

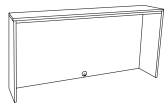

- Open cabinet for video monitor
- One grommet in center/bottom of back panel
- Inside dimensions are 70"W x 15"D x 33"H



Boost

TRAINING TABLES - SIN 33721

Sit or Stand

Sitting for long stretches every day may have health consequences. You don't have to move very much - just standing can help. Standing can increase blood flow to the brain to facilitate thinking. Maybe it is time stand up and Boost your creativity and thinking. Boost tables feature adjustable height work surfaces for easy transition from sitting to standing position. Boost is available in single or dual stage with "T" or a cantilevered "C" style leg.

Product Details

- Single stage leg adjusts from 28" to 47" overall table height (HA Series)
- Dual stage leg adjusts from 25" to 49" overall table height (DA Series)
- 1" thick thermally fused laminate (TFL) tops with matching 3mm edge banding
- Steel legs include adjustable floor glides
- Basic up/down switch included as standard
- Maximum load rating 100 lbs.
- Travel speed of 1.375" per second
- Basic up/down switch is standard
- Noise level less than 50 db
- Power consumption less than .3 watts
- Simple assembly required

Wire Management

- Add 2.5" diameter grommets for extended wire management capability

Edge Profile



How to Specify:

- 1 Series
- 2 Laminate finish top
- 3 Model number
- 4 Base finish
- 5 Options

Finished Example

HA/SB/6030C/B/P

Top Finishes	Code
Black	E
Boardwalk	SB
Boardwalk (Textured)	BW
Driftwood	SD
Driftwood (Textured)	DW
Espresso	X
Graphite	GP
Mahogany	M
Monticello Maple	MM
Natural Maple	FM
Shoreline	SS
Shoreline (Textured)	SL
Windsor Cherry	WC

Base Finishes	Code
Black	B
Silver	S
White	W

Options	Code	Price
High Pressure Laminate	4	15%
2.5" Diameter Grommet	G	138
Programmable Switch	P	148

Power

PowerFlex power modules can be installed in many locations. See page 36 for options.

Single Stage 'T' Legs

	Model	Overall	Cu. Ft.	Shp. Wt.	Fr. Cls.	Zone 1	Zone 2	Zone 3
24" Deep Adjustable Height	HA_3624T_	36" W x 24" D x 28"-47" H	4.7	82	100	1931	1999	2066
	HA_4224T_	42" W x 24" D x 28"-47" H	5.3	88	100	1942	2010	2078
	HA_4824T_	48" W x 24" D x 28"-47" H	5.8	95	100	1979	2048	2118
	HA_5424T_	54" W x 24" D x 28"-47" H	6.4	101	100	2018	2089	2159
	HA_6024T_	60" W x 24" D x 28"-47" H	7.0	105	100	2091	2164	2237
	HA_6624T_	66" W x 24" D x 28"-47" H	7.4	111	100	2131	2206	2280
	HA_7224T_	72" W x 24" D x 28"-47" H	8.2	119	100	2167	2243	2319



• Centered "T" leg bases

	Model	Overall	Cu. Ft.	Shp. Wt.	Fr. Cls.	Zone 1	Zone 2	Zone 3
30" Deep Adjustable Height	HA_3630T_	36" W x 30" D x 28"-47" H	5.5	91	100	1997	2067	2137
	HA_4230T_	42" W x 30" D x 28"-47" H	6.3	99	100	2027	2098	2169
	HA_4830T_	48" W x 30" D x 28"-47" H	7.0	108	100	2049	2121	2192
	HA_5430T_	54" W x 30" D x 28"-47" H	7.6	118	100	2091	2164	2237
	HA_6030T_	60" W x 30" D x 28"-47" H	8.4	122	100	2141	2216	2291
	HA_6630T_	66" W x 30" D x 28"-47" H	9.1	130	100	2186	2263	2339
	HA_7230T_	72" W x 30" D x 28"-47" H	9.8	136	100	2227	2305	2383



• Centered "T" leg bases

Single Stage 'C' Legs

	Model	Overall	Cu. Ft.	Shp. Wt.	Fr. Cls.	Zone 1	Zone 2	Zone 3
24" Deep Adjustable Height	HA_3624C_	36" W x 24" D x 28"-47" H	4.7	82	100	1931	1999	2066
	HA_4224C_	42" W x 24" D x 28"-47" H	5.3	88	100	1942	2010	2078
	HA_4824C_	48" W x 24" D x 28"-47" H	5.8	95	100	1979	2048	2118
	HA_5424C_	54" W x 24" D x 28"-47" H	6.4	101	100	2018	2089	2159
	HA_6024C_	60" W x 24" D x 28"-47" H	7.0	105	100	2091	2164	2237
	HA_6624C_	66" W x 24" D x 28"-47" H	7.4	111	100	2131	2206	2280
	HA_7224C_	72" W x 24" D x 28"-47" H	8.2	119	100	2167	2243	2319



• Cantilevered "C" leg bases

	Model	Overall	Cu. Ft.	Shp. Wt.	Fr. Cls.	Zone 1	Zone 2	Zone 3
30" Deep Adjustable Height	HA_3630C_	36" W x 30" D x 28"-47" H	5.5	91	100	1997	2067	2137
	HA_4230C_	42" W x 30" D x 28"-47" H	6.3	99	100	2027	2098	2169
	HA_4830C_	48" W x 30" D x 28"-47" H	7.0	108	100	2049	2121	2192
	HA_5430C_	54" W x 30" D x 28"-47" H	7.6	118	100	2091	2164	2237
	HA_6030C_	60" W x 30" D x 28"-47" H	8.4	122	100	2141	2216	2291
	HA_6630C_	66" W x 30" D x 28"-47" H	9.1	130	100	2186	2263	2339
	HA_7230C_	72" W x 30" D x 28"-47" H	9.8	136	100	2227	2305	2383



• Cantilevered "C" leg bases

Boost

Dual Stage 'T' Legs

24" Deep Adjustable Height



Model	Overall	Cu. Ft.	Shp. Wt.	Fr. Cls.	Zone 1	Zone 2	Zone 3
DA_3624T_	36" W x 24" D x 25"-49" H	4.7	84	100	2115	2189	2263
DA_4224T_	42" W x 24" D x 25"-49" H	5.3	90	100	2124	2198	2273
DA_4824T_	48" W x 24" D x 25"-49" H	5.8	97	100	2160	2236	2311
DA_5424T_	54" W x 24" D x 25"-49" H	6.4	103	100	2201	2278	2355
DA_6024T_	60" W x 24" D x 25"-49" H	7.0	107	100	2275	2355	2434
DA_6624T_	66" W x 24" D x 25"-49" H	7.4	113	100	2314	2395	2476
DA_7224T_	72" W x 24" D x 25"-49" H	8.2	121	100	2349	2431	2513

• Centered "T" leg bases

30" Deep Adjustable Height



Model	Overall	Cu. Ft.	Shp. Wt.	Fr. Cls.	Zone 1	Zone 2	Zone 3
DA_3630T_	36" W x 30" D x 25"-49" H	5.5	93	100	2179	2255	2332
DA_4230T_	42" W x 30" D x 25"-49" H	6.3	101	100	2208	2285	2363
DA_4830T_	48" W x 30" D x 25"-49" H	7.0	110	100	2232	2310	2388
DA_5430T_	54" W x 30" D x 25"-49" H	7.6	120	100	2275	2355	2434
DA_6030T_	60" W x 30" D x 25"-49" H	8.4	124	100	2322	2403	2485
DA_6630T_	66" W x 30" D x 25"-49" H	9.1	132	100	2369	2452	2535
DA_7230T_	72" W x 30" D x 25"-49" H	9.8	138	100	2409	2493	2578

• Centered "T" leg bases

Dual Stage 'C' Legs

	Model	Overall	Cu. Ft.	Shp. Wt.	Fr. Cls.	Zone 1	Zone 2	Zone 3
24" Deep Adjustable Height	DA_3624C_	36" W x 24" D x 25"-49" H	4.7	84	100	2115	2189	2263
	DA_4224C_	42" W x 24" D x 25"-49" H	5.3	90	100	2124	2198	2273
	DA_4824C_	48" W x 24" D x 25"-49" H	5.8	97	100	2160	2236	2311
	DA_5424C_	54" W x 24" D x 25"-49" H	6.4	103	100	2201	2278	2355
	DA_6024C_	60" W x 24" D x 25"-49" H	7.0	107	100	2275	2355	2434
	DA_6624C_	66" W x 24" D x 25"-49" H	7.4	113	100	2314	2395	2476
	DA_7224C_	72" W x 24" D x 25"-49" H	8.2	121	100	2349	2431	2513



* Cantilevered "C" leg bases

	Model	Overall	Cu. Ft.	Shp. Wt.	Fr. Cls.	Zone 1	Zone 2	Zone 3
30" Deep Adjustable Height	DA_3630C_	36" W x 30" D x 25"-49" H	5.5	93	100	2179	2255	2332
	DA_4230C_	42" W x 30" D x 25"-49" H	6.3	101	100	2208	2285	2363
	DA_4830C_	48" W x 30" D x 25"-49" H	7.0	110	100	2232	2310	2388
	DA_5430C_	54" W x 30" D x 25"-49" H	7.6	120	100	2275	2355	2434
	DA_6030C_	60" W x 30" D x 25"-49" H	8.4	124	100	2322	2403	2485
	DA_6630C_	66" W x 30" D x 25"-49" H	9.1	132	100	2369	2452	2535
	DA_7230C_	72" W x 30" D x 25"-49" H	9.8	138	100	2409	2493	2578



* Cantilevered "C" leg bases



Clique

MEETING TABLES - SIN 33721

Create and Re-Crete

Clique training tables provide maximum flexibility, versatility and a modern aesthetic with multiple top shapes and sizes to allow for almost unlimited configurations. Choose top shapes and legs (with or without locking casters) to fit the desired configuration or layout. Assembly is simple and quick. Add modesty panels or privacy screens to complete your customized configuration.

Product Details

- Column legs create 29" desk / table height
- Column legs available in single or set of 4
- Column legs available with adjustable glides or 60mm casters
- 1" thick tops are smooth (suede) finish thermally fused laminate (TFL)
- 8" raised satin acrylic modesty panel available
- Simple assembly required

Wire Management

- Add 2.5" diameter grommets for extended wire management capability

Edge Profile



How to Specify:

- 1 Series
- 2 Top finish
- 3 Top size/shape
- 4 Base / Legs
- 5 Options

Finished Example

CT/MM/6030T/XDAMP60

Top Finishes	Code
Black	E
Boardwalk	SB
Driftwood	SD
Espresso	X
Graphite	GP
Mahogany	M
Monticello Maple	MM
Natural Maple	FM
Shoreline	SS
Windsor Cherry	WC

Leg Finishes	Code
Black	B
Silver-Gray	G

Options	Code	Price
2.5" Diameter Grommet	G	138

Power

PowerFlex power modules can be installed in many locations. See page 36 for options.

Tops

	Model	Overall	Cu. Ft.	Shp. Wt.	Fr. Cls.	Zone 1	Zone 2	Zone 3
20" Rectangular 	CT_3620T	36" W x 20" D x 1" H	2	30	100	435	450	465
	CT_4820T	48" W x 20" D x 1" H	3.2	40	100	488	505	522
	CT_6020T	60" W x 20" D x 1" H	4	50	100	615	637	658
	CT_6620T	66" W x 20" D x 1" H	4.7	60	100	638	660	683
	CT_7220T	72" W x 20" D x 1" H	4.7	64	100	660	683	706

	Model	Overall	Cu. Ft.	Shp. Wt.	Fr. Cls.	Zone 1	Zone 2	Zone 3
24" Rectangular 	CT_3624T	36" W x 24" D x 1" H	2.8	35	100	474	491	507
	CT_4824T	48" W x 24" D x 1" H	2.8	45	100	506	524	541
	CT_6024T	60" W x 24" D x 1" H	3.5	56	100	615	637	658
	CT_6624T	66" W x 24" D x 1" H	4.1	65	100	646	669	691
	CT_7224T	72" W x 24" D x 1" H	4.1	69	100	678	702	725

	Model	Overall	Cu. Ft.	Shp. Wt.	Fr. Cls.	Zone 1	Zone 2	Zone 3
30" Rectangular 	CT_3630T	36" W x 30" D x 1" H	3.3	40	100	532	551	569
	CT_4830T	48" W x 30" D x 1" H	3.3	56	100	570	590	610
	CT_6030T	60" W x 30" D x 1" H	4.1	69	100	652	675	698
	CT_6630T	66" W x 30" D x 1" H	4.9	80	100	692	716	740
	CT_7230T	72" W x 30" D x 1" H	4.9	83	100	731	757	782

	Model	Overall	Cu. Ft.	Shp. Wt.	Fr. Cls.	Zone 1	Zone 2	Zone 3
Round 	CT_R30T	30" D x 1" H	3	35	100	571	591	611
	CT_R36T	36" D x 1" H	3.1	44	100	661	684	707
	CT_R42T	42" D x 1" H	4	56	100	784	811	839
	CT_R48T	48" D x 1" H	4.5	67	100	933	966	998

	Model	Overall	Cu. Ft.	Shp. Wt.	Fr. Cls.	Zone 1	Zone 2	Zone 3
Square 	CT_S30T	30" W x 30" D x 1" H	3	40	100	519	537	555
	CT_S36T	36" W x 36" D x 1" H	3.1	48	100	566	586	606
	CT_S42T	42" W x 42" D x 1" H	4	65	100	615	637	658

Clique

	Model	Overall	Cu. Ft.	Shp. Wt.	Fr. Cls.	Zone 1	Zone 2	Zone 3
Half Round 	CT_4020H	40" W x 20" D x 1" H	2.8	40	100	608	629	651
	CT_4824H	48" W x 24" D x 1" H	2.8	45	100	763	790	816
	CT_6030H	60" W x 30" D x 1" H	4.1	65	100	863	893	923

	Model	Overall	Cu. Ft.	Shp. Wt.	Fr. Cls.	Zone 1	Zone 2	Zone 3
Crescent 	CT_3620C	36" W x 20" D x 1" H	3.1	44	100	589	610	630
	CT_4220C	42" W x 20" D x 1" H	3.5	56	100	800	828	856
	CT_4824C	48" W x 24" D x 1" H	5.3	70	100	948	981	1014
	CT_4830C	48" W x 30" D x 1" H	5.3	80	100	948	981	1014

	Model	Overall	Cu. Ft.	Shp. Wt.	Fr. Cls.	Zone 1	Zone 2	Zone 3
Trapezoid 	CT_3620Z	36" W x 18.3" D x 1" H	2	28	100	558	578	597
	CT_4824Z	48" W x 20.8" D x 1" H	2.8	40	100	603	624	645
	CT_6030Z	60" W x 26" D x 1" H	4.1	66	100	755	781	808

	Model	Overall	Cu. Ft.	Shp. Wt.	Fr. Cls.	Zone 1	Zone 2	Zone 3
Slice Top, 60 Degree 	CT_20S60T	20" W x 20" D x 1" H	3	14	100	608	629	651
	CT_24S60T	24" W x 24" D x 1" H	3	19	100	640	662	685

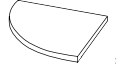
	Model	Overall	Cu. Ft.	Shp. Wt.	Fr. Cls.	Zone 1	Zone 2	Zone 3
Slice Top, 90 Degree 	CT_20S90T	20" W x 20" D x 1" H	3	16	100	629	651	673
	CT_24S90T	24" W x 24" D x 1" H	3	24	100	652	675	698

Modesty Panel

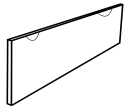
	Model	Overall	Cu. Ft.	Shp. Wt.	Fr. Cls.	Zone 1	Zone 2	Zone 3
Modesty Panel 	XDAMP36	36" W x .75" D x 8" H	2.1	10	85	307	318	328
	XDAMP42	42" W x .75" D x 8" H	2.1	11	85	313	324	335
	XDAMP48	48" W x .75" D x 8" H	2.1	12	85	320	331	342

• Satin acrylic

• Attaches to top of equal width

Legs

	Model	Overall	Cu. Ft.	Shp. Wt.	Fr. Cls.	Zone 1	Zone 2	Zone 3
Column legs, casters	ML_4C	2.4" D x 28" H (ea)	2.1	20	150	389	403	416

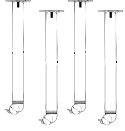

- Four 60mm diameter steel post legs
- Black or Silver-Gray powder coat finish
- Locking twin-wheel casters on each leg

	Model	Overall	Cu. Ft.	Shp. Wt.	Fr. Cls.	Zone 1	Zone 2	Zone 3
Column legs, levelers	ML_4L	2.4" D x 28" H (ea)	2.1	20	150	389	403	416

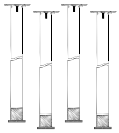

- Four 60mm diameter steel post legs
- Black or Silver-Gray powder coat finish
- Leveling glides on each leg

	Model	Overall	Cu. Ft.	Shp. Wt.	Fr. Cls.	Zone 1	Zone 2	Zone 3
Column legs, casters/levelers	ML_2C2L	2.4" D x 28" H (ea)	2.1	20	150	389	403	416



- Four 60mm diameter steel post legs
- Black or Silver-Gray powder coat finish
- Locking twin-wheel casters on two legs, leveling glides on two legs

	Model	Overall	Cu. Ft.	Shp. Wt.	Fr. Cls.	Zone 1	Zone 2	Zone 3
Column leg, leveler	ML_1L	2.4" D x 28" H	1	5	150	135	140	144



- One 60mm diameter steel post leg
- Black or Silver-Gray powder coat finish
- Leveling glide

	Model	Overall	Cu. Ft.	Shp. Wt.	Fr. Cls.	Zone 1	Zone 2	Zone 3
Column leg, caster	ML_1C	2.4" D x 28" H	1	5	150	135	140	144



- One 60mm diameter steel post leg
- Black or Silver-Gray powder coat finish
- Locking twin-wheel caster

	Overall	St. Ydg.	Cu. Ft.	Shp. Wt.	Fr. Cls.
UG	2.5" W x 6" D x .25" H	N/A	N/A	N/A	N/A

Universal Ganging Bracket

NOW



Zone 1	60
Zone 2	60
Zone 3	60



Duality

TRAINING TABLES - SIN 33721

Meet, Flip, Nest, Store

Duality tables feature a tilting top that allows tables to be nested for ease of movement and compact storage. Pull them out and set up when needed, tuck them away when the meeting is over.

Product Details

- Flip-top for easy storage
- Die cast flip mechanism engaged with single release point
- 1" thermal fused laminate tops with matching 3mm edge banding
- Steel in-line nesting, double tube legs available in Silver as standard
- Includes 4 casters - 2 locking
- Table height of 29"
- Steel support beam standard on 60" and 72" width tops
- Laminate modesty panel available
- Some assembly required

Wire Management

- Add 2.5" diameter grommets for extended wire management capability

Edge Profile



How to Specify:

- 1** Series
- 2** Laminate finish top
- 3** Model number
- 4** Options

Finished Example

TD/DW/6024FS/UG

Top Finishes	Code
Black	E
Boardwalk	SB
Boardwalk (Textured)	BW
Driftwood	SD
Driftwood (Textured)	DW
Espresso	X
Graphite	GP
Mahogany	M
Monticello Maple	MM
Natural Maple	FM
Shoreline	SS
Shoreline (Textured)	SL
Windsor Cherry	WC

Options	Code	Price
Additional Grommet	G	138

Power

PowerFlex power modules can be installed in many locations. See page 36 for options.

	Model	Overall	Cu. Ft.	Shp. Wt.	Fr. Cls.	Zone 1	Zone 2	Zone 3
24" Deep Flip-Top	TD_4824FS	48" W x 24" D x 29" H	11.2	64	125	1184	1225	1267
	TD_6024FS	60" W x 24" D x 29" H	11.2	79	125	1405	1454	1503
	TD_7224FS	72" W x 24" D x 29" H	17.6	93	125	1495	1547	1600
						60	60	60



- Top ships with attached flip mechanism, easily assembles to bases

	Model	Overall	Cu. Ft.	Shp. Wt.	Fr. Cls.	Zone 1	Zone 2	Zone 3
30" Deep Flip-Top	TD_4830FS	48" W x 30" D x 29" H	17.6	87	125	1248	1292	1335
	TD_6030FS	60" W x 30" D x 29" H	17.6	97	125	1448	1499	1549
	TD_7230FS	72" W x 30" D x 29" H	17.6	109	125	1549	1603	1657
						60	60	60



- Top ships with attached flip mechanism, easily assembles to bases

Accessories & Options

	Model	Overall	Cu. Ft.	Shp. Wt.	Fr. Cls.	Zone 1	Zone 2	Zone 3
Modesty Panel	MP_48	36" W x .75" D x 10" H	2.1	10	85	250	259	268
	MP_60	48" W x .75" D x 10" H	2.1	11	85	268	277	287
	MP_72	60" W x .75" D x 10" H	2.1	12	85	286	296	306



- .75" thick thermally fused laminate (TFL) surface
- Magnetic latches keep panel vertical in use, releases and remains vertical when storing

	Overall	St. Ydg.	Cu. Ft.	Shp. Wt.	Fr. Cls.
UG	2.5" W x 6" D x .25" H	N/A	N/A	N/A	N/A

Universal Ganging Bracket

NOW



Zone 1	60
Zone 2	60
Zone 3	60



Spencer

TABLES - SIN 33721

Contemporary design

Spencer tables are a new twist on an old favorite with a sawhorse base style. As on other HPFi tables, these tables feature high durability AdvantEdge 3mm PVC edge banding on the 1" thick core, thermally fused laminate tops. Spencer occasional height tables are a perfect companion to Eve and Accompany lounge furnishings, particularly the Eve Harbor privacy seating models.

Assembly

- Tables ship with top and base(s) in separate cartons
- Assembly is quick and easy by attaching bases to tops with bolts or screws provided

Finishes

- Select your choice of thermally fused laminate, 1" thick top
- Base are offered in three contemporary powder-coated paint finishes

Wire Management

- Add 2.5" diameter grommets for extended wire management capability

Edge Profile



How to Specify:

- 1** Series
- 2** Laminate finish top
- 3** Model number
- 4** Base Finish
- 5** Option

Finished Example

ST/SB/4824D/S

Top (1")	Code
Black	E
Boardwalk (Textured)	BW
Driftwood (Textured)	DW
Espresso	X
Graphite	GP
Mahogany	M
Monticello Maple	MM
Natural Maple	FM
Shoreline (Textured)	SL
Windsor Cherry	WC

Options	Code	Price
Grommet	G	138

Smooth Top (1" Thick) Finishes	Code
Smooth Boardwalk	SB
Smooth Driftwood	SD
Smooth Shoreline	SS

Base Finishes	Code
Black	B
Silver	S
White	W

Power

PowerFlex power modules can be installed in many locations. See page 36 for options.

Occasional Tables

	Model	Overall	Cu. Ft.	Shp. Wt.	Fr. Cls.	Zone 1	Zone 2	Zone 3
End Table	ST_2424F_	24" W x 24" D x 18" H	3.4	42	100	817	846	874



	Model	Overall	Cu. Ft.	Shp. Wt.	Fr. Cls.	Zone 1	Zone 2	Zone 3
Coffee Table	ST_4824F_	48" W x 24" D x 18" H	3.8	63	100	934	967	999



Training / Dining Table

	Model	Overall	Cu. Ft.	Shp. Wt.	Fr. Cls.	Zone 1	Zone 2	Zone 3
Rectangular Table	ST_4824D_	48" W x 24" D x 29" H	13	74	175	1015	1051	1086
	ST_6024D_	60" W x 24" D x 29" H	13	87	100	1097	1135	1174
	ST_7224D_	72" W x 24" D x 29" H	7.1	100	100	1203	1245	1287



•ST_7224D_ table has support stretchers underneath top

Mobile Desk / Table

	Model	Overall	Cu. Ft.	Shp. Wt.	Fr. Cls.	Zone 1	Zone 2	Zone 3
Rectangular Table on Casters	ST_4824C_	48" W x 24" D x 29" H	5.8	75	100	1015	1051	1086
	ST_6024C_	60" W x 24" D x 29" H	6.5	86	100	1097	1135	1174
	ST_7224C_	72" W x 24" D x 29" H	7.1	99	100	1203	1245	1287



•ST_7224C_ table has support stretchers underneath top

Standing Height Table

	Model	Overall	Cu. Ft.	Shp. Wt.	Fr. Cls.	Zone 1	Zone 2	Zone 3
Rectangular Table	ST_6030S_	60" W x 30" D x 42" H	9.8	120	125	1225	1268	1311
	ST_6630S_	66" W x 30" D x 42" H	10.6	131	125	1343	1390	1437
	ST_7230S_	72" W x 30" D x 42" H	10.6	134	125	1401	1450	1499
	ST_9630S_	96" W x 30" D x 42" H	18.8	187	125	2102	2176	2249



•All table models have support stretchers underneath top •ST_9630S_ table has 12" over-hang on ends



Occasional Tables

OCCASIONAL TABLES - SIN 33721

Tables for Any Decor

Whether your style is contemporary, transitional or traditional, HPFi has a table collection to complement or match. Table frames are available in round or square tubular steel with a clear coat over powder-coat paired with tempered glass or thermally fused laminate tops, wood frame with wood veneer tops or thermally fused laminate tops or high pressure laminate (HPL) tops with lumber-banded profile edges and in all thermally fused laminate frame and top.

Product Details

- Traditional tables
 - Bedford
- Transitional tables
 - 6700 Series
 - 9100 Series
 - Malibu (laminated)
 - Trados Metal (laminated)
- Contemporary tables
 - Eve
 - Flex
 - Hyperwork
 - Malibu (glass)
 - Parsec
 - Trados Metal (glass)

How to Specify:

- 1 Model Number
- 2 Finish

Finished Example

6720/BW

Bedford



Bedford brings old world excellence to the contemporary office with a complete collection of meeting solutions. High pressure laminate tops feature solid hardwood edges that withstand everyday abuse from chair "bumps." Enhance any traditional environment with these beautifully crafted tables.

Smooth Laminate	Code
Mahogany	M
Windsor Cherry	WC

NOW	Code
Mahogany	M



Edge Profile

TR_-4020

Traditional Cocktail Table

NOW



Overall	Cu. Ft.	Shp. Wt.	Fr. Cls.	Zone 1	Zone 2	Zone 3
54" W x 24" D x 16" H	5.5	70	92.5	1057	1094	1131

- High gloss, high pressure laminate top
- Lumber-banded (wood) profiled edges
- Available in Mahogany or Windsor Cherry
- Easy assembly of legs to frame

TR_-4023

Traditional End Table

NOW



Overall	Cu. Ft.	Shp. Wt.	Fr. Cls.	Zone 1	Zone 2	Zone 3
22" W x 27" D x 18" H	2.5	38	85	876	907	937

- High gloss, high pressure laminate top
- Lumber-banded (wood) profiled edges
- Available in Mahogany or Windsor Cherry
- Easy assembly of legs to frame

Occasional Tables

Eve



The Eve Occasional Table provides a durable, yet minimalistic surface for laptop computers, tablets and reading materials. Adjustable glides ensure that the top surface doesn't suffer the "wobbles" during use.

Smooth Laminate	Code
Black	BLK
Espresso	ESP
Graphite	GP
Mahogany	MAH
Monticello Maple	MM
Natural Maple	FM
Windsor Cherry	WC

NOW	Code
Driftwood	DW
Natural Maple	FM
Windsor Cherry	WC

Textured Laminate	Code
Boardwalk	BW
Driftwood	DW
Shoreline	SL



Edge Profile

5828

Round End Table,
Trumpet Base

NOW



Overall	Cu. Ft.	Shp. Wt.	Fr. Cls.	Zone 1	Zone 2	Zone 3
28" W x 28" D x 20.25" H	16	73	175	1142	1182	1222

- .75" thick thermally fused laminate (TFL) top
- 3 mm AdvantEdge PVC edge banding
- Brushed aluminum trumpet style base
- Ships fully assembled

Flex



Ideal for use with Flex Lounge seating, the Flex Occasional Table provides a durable option for casual gatherings. Adjustable glides ensure that the top surface is level offering a perfect landing spot for beverages.

Smooth Laminate	Code
Black	BLK
Espresso	ESP
Graphite	GP
Mahogany	MAH
Monticello Maple	MM
Natural Maple	FM
Windsor Cherry	WC

NOW	Code
Driftwood	DW
Natural Maple	FM
Windsor Cherry	WC

Textured Laminate	Code
Boardwalk	BW
Driftwood	DW
Shoreline	SL



Edge Profile

1528

Round End Table,
Laminate Top and Disc Base

NOW



Overall	Cu. Ft.	Shp. Wt.	Fr. Cls.	Zone 1	Zone 2	Zone 3
28" W x 28" D x 15.75" H	16.0	74	175	1142	1182	1222

- .75" thick thermally fused laminate (TFL) top
- 3 mm AdvantEdge PVC edge banding
- 22" diameter silver disc-style base
- Ships fully assembled

Hyperwork



Hyperwork features high-quality, high value contemporary tables for fast-paced business environments. Tables with angled satin finish chrome legs work perfectly with Claudia lounge seating. Panel end construction models coordinate with almost any seating style.

Smooth Laminate	Code
Black	E
Boardwalk (top only)	SB
Driftwood (top only)	SD
Espresso	X
Graphite	GP
Mahogany	M
Monticello Maple	MM
Natural Maple	FM
Shoreline (top only)	SS
Windsor Cherry	WC

Textured Laminate	Code
Boardwalk	BW
Driftwood	DW
Shoreline	SL

NOW	Code
Windsor Cherry	WC



Edge Profile

Overall	Cu. Ft.	Shp. Wt.	Fr. Cls.	Zone 1	Zone 2	Zone 3
48" W x 24" D x 18" H	11.9	96	150	992	1027	1061

HW_CT48

Coffee Table

NOW



- Thermally fused laminate (TFL)
- Angled, satin finish chrome legs (matches Claudia lounge seating)
- Ships fully assembled

Overall	Cu. Ft.	Shp. Wt.	Fr. Cls.	Zone 1	Zone 2	Zone 3
18" W x 22" D x 24" H	6.9	50	150	772	799	826

HW_ET18

End Table

NOW



- Thermally fused laminate (TFL)
- Angled, satin finish chrome legs (matches Claudia lounge seating)
- Ships fully assembled

Overall	Cu. Ft.	Shp. Wt.	Fr. Cls.	Zone 1	Zone 2	Zone 3
22" W x 24" D x 18" H	2.1	30	85	432	447	462

HW_ET23

End Table

NOW



- Thermally fused laminate (TFL)
- Assembly required

Overall	Cu. Ft.	Shp. Wt.	Fr. Cls.	Zone 1	Zone 2	Zone 3
48" W x 24" D x 15" H	3.6	50	85	518	536	554

HW_CT20

Coffee Table

NOW



- Thermally fused laminate (TFL)
- Assembly required

Occasional Tables

Malibu



The Malibu family of tables coordinate perfectly with Eve and Accompany (metal leg) lounge seating. The oval coffee, round end and demi-lune sofa tables are available with a contemporary .375" thick tempered glass or .75" thick thermally fused laminate (TFL) top. Frames are 16 gauge steel, urethane clear coat over brushed aluminum powder coat finish with non-skid floor glides.

Smooth Laminate (top only)	Code
Black	BLK
Espresso	ESP
Graphite	GP
Mahogany	MAH
Monticello Maple	MM
Natural Maple	FM
Windsor Cherry	WC

Textured Laminate (top only)	Code
Boardwalk	BW
Driftwood	DW
Shoreline	SL

NOW	Code
Driftwood	DW
Natural Maple	FM
Windsor Cherry	WC



Laminate Top Edge Profile



Glass Top Edge Profile

Overall	Cu. Ft.	Shp. Wt.	Fr. Cls.	Zone 1	Zone 2	Zone 3
28" W x 28" D x 24" H	16	43	250	1036	1072	1109

5923MET

End Table

NOW



- 28" diameter round glass top

Overall	Cu. Ft.	Shp. Wt.	Fr. Cls.	Zone 1	Zone 2	Zone 3
52" W x 33" D x 18.25" H	26	79	250	1350	1397	1445

5920MET

Coffee Table

NOW



- 52" x 33" oval shape glass top

Overall	Cu. Ft.	Shp. Wt.	Fr. Cls.	Zone 1	Zone 2	Zone 3
54" W x 20.5" D x 29" H	27	64	250	1532	1586	1639

5927MET

Sofa Table

NOW



- 54" x 20.5 demi-lune (half-round) glass top

Overall	Cu. Ft.	Shp. Wt.	Fr. Cls.	Zone 1	Zone 2	Zone 3
28" W x 28" D x 24" H	16	45	250	1280	1325	1370

5923_

Round Table, Laminate Top

NOW



- 28" diameter round laminate top

	Overall	Cu. Ft.	Shp. Wt.	Fr. Cls.	Zone 1	Zone 2	Zone 3
5920_ Coffee Table, Laminate Top NOW	52" W x 33" D x 18.25" H •52" x 33" oval laminate top	26	61	250	1969	2038	2107



	Overall	Cu. Ft.	Shp. Wt.	Fr. Cls.	Zone 1	Zone 2	Zone 3
5927_ Sofa Table, Laminate Top NOW	54" W x 20.5" D x 29" H •54" x 20.5 demi-lune (half-round) laminate top	27	47	300	1779	1841	1904



Parsec



Parsec tables are a perfect complement to support collaborative work and school tasks. Pull close for a temporary writing surface or support of mobile electronic devices. Its low profile base allows Parsec to be used with all HPFi lounge seating series.



Edge Profile

	Overall	Cu. Ft.	Shp. Wt.	Fr. Cls.	Zone 1	Zone 2	Zone 3
5600 Pull-Up Table NOW	18" W x 12" D x 25.2" H •1" thick vinyl clad top with soft waterfall radius edge • Textured silver-gray (Flat Iron) finish standard on tops • Brushed aluminum powder-coat finish on .188" thick flat base and 1.5" diameter arc offset upright column • Includes soft, non-marring skid pads for use on hard floors	6	25	175	911	943	975



Occasional Tables

Spencer



Spencer tables are a new twist on an old favorite with a sawhorse base style. Spencer occasional height tables are a perfect companion to Eve and Accompany lounge furnishings, particularly the Eve Harbor privacy seating models.

Smooth Laminate	Code
Black	BLK
Boardwalk	SB
Driftwood	SD
Espresso	ESP
Graphite	GP
Mahogany	MAH
Monticello Maple	MM
Natural Maple	FM
Shoreline	SS
Windsor Cherry	WC

Textured Laminate	Code
Boardwalk	BW
Driftwood	DW
Shoreline	SL
Base Finishes	Code
Black	B
Silver	S
White	W



Edge Profile

	Model	Overall	Cu. Ft.	Shp. Wt.	Fr. Cls.	Zone 1	Zone 2	Zone 3
End Table	ST_2424F_	24" W x 24" D x 18" H	3.4	42	100	817	846	874



• Ships in two (2) cartons

	Model	Overall	Cu. Ft.	Shp. Wt.	Fr. Cls.	Zone 1	Zone 2	Zone 3
Coffee Table	ST_4824F_	48" W x 24" D x 18" H	3.8	63	100	934	967	999



• Ships in two (2) cartons

Trados Metal



Trados Metal occasional tables are the perfect complement to Trados Metal seating. 1.5" square tubular steel legs and 1.5" x .5" thick top frames are finished with a brushed aluminum powder coat under a clear urethane top coat. Available with .375" thick glass or .75" thick laminate tops in all HPFi standard laminate finishes.

Smooth Laminate (top only)	Code
Black	BLK
Espresso	ESP
Graphite	GP
Mahogany	MAH
Monticello Maple	MM
Natural Maple	FM
Windsor Cherry	WC

NOW	Code
Driftwood	DW
Natural Maple	FM
Windsor Cherry	WC

Textured Laminate (top only)	Code
Boardwalk	BW
Driftwood	DW
Shoreline	SL



TFL Edge Profile



Glass Edge Profile

	Overall	Cu. Ft.	Shp. Wt.	Fr. Cls.	Zone 1	Zone 2	Zone 3
5723MET	25.5" W x 25.5" D x 25" H	16	50	250	1060	1097	1134

End Table, Glass Top

NOW



Occasional Tables

	Overall	Cu. Ft.	Shp. Wt.	Fr. Cls.	Zone 1	Zone 2	Zone 3
5720MET	49.5" W x 25.5" D x 19" H	25	76	250	1383	1431	1480

Coffee Table, Glass Top

NOW



	Overall	Cu. Ft.	Shp. Wt.	Fr. Cls.	Zone 1	Zone 2	Zone 3
5727MET	55.5" W x 19.5" D x 31" H	26	77	250	1569	1624	1679

Sofa Table, Glass Top

NOW



	Overall	Cu. Ft.	Shp. Wt.	Fr. Cls.	Zone 1	Zone 2	Zone 3
5723_	25.5" W x 25.5" D x 25" H	16	46	250	1060	1097	1134

End Table, Laminate Top

NOW



	Overall	Cu. Ft.	Shp. Wt.	Fr. Cls.	Zone 1	Zone 2	Zone 3
5720_	49.5" W x 25.5" D x 19" H	26	68	250	1383	1431	1480

Coffee Table, Laminate Top

NOW



	Overall	Cu. Ft.	Shp. Wt.	Fr. Cls.	Zone 1	Zone 2	Zone 3
5727_	55.5" W x 19.5" D x 31" H	26	71	250	1569	1624	1679

Sofa Table, Laminate Top

NOW



Occasional Tables

6700 Series



The 6700 Series tables feature a tapered hardwood leg that blends harmoniously with transitional or contemporary interiors. 6700 tables are available with wood veneer or laminate tops. Thermally fused laminate (TFL) tops include 3mm AdvantEdge PVC edge banding for improved protection of top edges.

Smooth (TFL Top only)	Code	Veneer (Top Only)	Code
Black	BLK	Black	BLK
Espresso	ESP	Boardwalk	SB
Graphite	GP	Driftwood	SD
Mahogany	MAH	Espresso	ESP
Monticello Maple	MM	Mahogany	MAH
Natural Maple	FM	Moab	MOB
Windsor Cherry	WC	Monticello Maple	MM
		Natural Maple	FM
		Shoreline	SS
		Windsor Cherry	WC
Textured (TFL Top Only)	Code		
Boardwalk (Textured)	BW		
Driftwood (Textured)	DW		
Shoreline (Textured)	SL		



Edge Profile

Model	Overall	Cu. Ft.	Shp. Wt.	Fr. Cls.	Zone 1	Zone 2	Zone 3
Cocktail Table, Wood Top	54" W x 24" D x 16" H	5	65	85	1507	1560	1612

NEW



- Wood veneer top
- Assembly required

Model	Overall	Cu. Ft.	Shp. Wt.	Fr. Cls.	Zone 1	Zone 2	Zone 3
Cocktail Table, Laminate Top	54" W x 24" D x 16" H	5	63	85	1492	1544	1596

NEW



- Laminate top
- Assembly required

Model	Overall	Cu. Ft.	Shp. Wt.	Fr. Cls.	Zone 1	Zone 2	Zone 3
End Table, Wood Top	24" W x 28" D x 20" H	3	40	85	1121	1160	1199

NEW



- Wood veneer top
- Assembly required

Model	Overall	Cu. Ft.	Shp. Wt.	Fr. Cls.	Zone 1	Zone 2	Zone 3
End Table, Laminate Top	24" W x 28" D x 20" H	3	41	85	1106	1145	1183

NEW



- Laminate top
- Assembly required

9100 Series



The 9100 Series tables work perfectly with the HPFi Vitality casegoods and 9100 Series Lounge. The transitional style radius, lumber-banded hardwood edges ensure years of protection. The semi-gloss finish veneer top surface offers the beauty of natural wood and helps to hide smudges and fingerprints.

Wood Finish	Code
Black	BLK
Boardwalk	BW
Driftwood	DW
Espresso	ESP
Mahogany	MAH
Moab	MOB
Monticello Maple	MM
Natural Maple	FM
Shoreline	SL
Windsor Cherry	WC



Edge Profile

To Be Discontinued 12/31/22

(or until dedicated materials are depleted)

9120

Cocktail Table

NOW



Overall	Cu. Ft.	Shp. Wt.	Fr. Cls.	Zone 1	Zone 2	Zone 3
54" W x 24" D x 16.5" H	16	61	250	1460	1511	1562

- Ships fully assembled

9123

End Table

NOW



Overall	Cu. Ft.	Shp. Wt.	Fr. Cls.	Zone 1	Zone 2	Zone 3
24" W x 28" D x 20.25" H	10	40	175	1049	1086	1122

- Ships fully assembled

Occasional Tables Finishes

MEETING TABLES - SIN 33721



Bedford

Smooth Laminate	Code
Mahogany	MAH
Windsor Cherry	WC

NOW	Code
Mahogany	MAH



Eve

Smooth Laminate	Code
Black	BLK
Espresso	ESP
Graphite	GP
Mahogany	MAH
Monticello Maple	MM
Natural Maple	FM
Windsor Cherry	WC

Textured Laminate	Code
Boardwalk	BW
Driftwood	DW
Shoreline	SL

NOW	Code
Driftwood	DW
Natural Maple	FM
Windsor Cherry	WC



Flex

Smooth Laminate	Code
Black	BLK
Espresso	ESP
Graphite	GP
Mahogany	MAH
Monticello Maple	MM
Natural Maple	FM
Windsor Cherry	WC

Textured Laminate	Code
Boardwalk	BW
Driftwood	DW
Shoreline	SL

NOW	Code
Driftwood	DW
Natural Maple	FM
Windsor Cherry	WC



Hyperwork

Smooth Laminate	Code
Black	E
Boardwalk (top only)	SB
Driftwood (top only)	SD
Espresso	X
Graphite	GP
Mahogany	M
Monticello Maple	MM
Natural Maple	FM
Shoreline (top only)	SS
Windsor Cherry	WC

Textured Laminate	Code
Boardwalk	BW
Driftwood	DW
Shoreline	SL

NOW	Code
Windsor Cherry	WC

Occasional Tables



Malibu

Smooth Laminate	Code
Black	BLK
Espresso	ESP
Graphite	GP
Mahogany	MAH
Monticello Maple	MM
Natural Maple	FM
Windsor Cherry	WC
Textured Laminate	Code
Boardwalk	BW
Driftwood	DW
Shoreline	SL
NOW	Code
Driftwood	DW
Natural Maple	FM
Windsor Cherry	WC



Spencer

Smooth Laminate	Code
Black	BLK
Boardwalk	SB
Driftwood	SD
Espresso	ESP
Graphite	GP
Mahogany	MAH
Monticello Maple	MM
Natural Maple	FM
Shoreline	SS
Windsor Cherry	WC
Textured Laminate	Code
Boardwalk	BW
Driftwood	DW
Shoreline	SL



Trados Metal

Smooth Laminate	Code
Black	BLK
Boardwalk	SB
Driftwood	SD
Espresso	ESP
Graphite	GP
Mahogany	MAH
Monticello Maple	MM
Natural Maple	FM
Shoreline	SS
Windsor Cherry	WC
Textured Laminate	Code
Boardwalk	BW
Driftwood	DW
Shoreline	SL
NOW	Code
Driftwood	DW
Natural Maple	FM
Windsor Cherry	WC



6700

Wood Finish	Code
Black	BLK
Boardwalk	BW
Driftwood	DW
Espresso	ESP
Mahogany	MAH
Moab	MOB
Monticello Maple	MM
Natural Maple	FM
Shoreline	SL
Windsor Cherry	WC
Smooth Laminate (top only)	Code
Black	BLK
Espresso	ESP
Graphite	GP
Mahogany	MAH
Monticello Maple	MM
Natural Maple	FM
Windsor Cherry	WC
Textured Laminate (top only)	Code
Boardwalk	BW
Driftwood	DW
Shoreline	SL
NOW	Code
Natural Maple	FM
Windsor Cherry	WC



9100

Wood Finish	Code
Black	BLK
Boardwalk	BW
Driftwood	DW
Espresso	ESP
Mahogany	MAH
Moab	MOB
Monticello Maple	MM
Natural Maple	FM
Shoreline	SL
Windsor Cherry	WC
NOW	Code
Black	BLK
Boardwalk	BW
Driftwood	DW
Espresso	ESP
Mahogany	MAH
Moab	MOB
Monticello Maple	MM
Natural Maple	FM
Shoreline	SL
Windsor Cherry	WC



Milan Breakroom

BREAKROOM TABLES - SIN 33721

Buffet or Café, Uniquely Designed

The Milan Bistro Table collection is the perfect solution for break rooms, cafeterias, dining areas and anywhere that you need a place to meet and eat. A large variety of top options designed to coordinate with other HPFi furnishings. Combine table tops with a 28" (dining height) or 40.75" (bistro/standing) high heavy-duty steel base. Choose from a wide range of Milan Bistro seating for an instant lunch area or sidewalk café.

Product Details

- Heavy duty cast base available in black
- 29" or 42" heights (top & base) available
- 3" diameter durable steel columns
- 40.75" high base (for 42" high table) includes 30" heavy duty foot ring
- 1" thick thermally fused laminate (TFL) tops (Hyperwork)
- 36" or 42" diameter, 24" and 30" D x 36" and 48" W rectangular tops available
- Adjustable floor glides included in bases
- Simple assembly required

Edge Profile (Hyperwork) Top



How to Specify:

- 1 Top series
- 2 Top laminate finish
- 3 Top model number
- 4 Base

Finished Example

H/FM/R36T/BTR534TB

Top (Hyperwork) Finishes	Code
Black	E
Boardwalk	SB
Boardwalk (Textured)	BW
Driftwood	SD
Driftwood (Textured)	DW
Espresso	X
Graphite	GP
Mahogany	M
Monticello Maple	MM
Natural Maple	FM
Shoreline	SS
Shoreline (Textured)	SL
Windsor Cherry	WC

Milan Breakroom

	Model	Overall	Cu. Ft.	Shp. Wt.	Fr. Cls.	Zone 1	Zone 2	Zone 3
Round Table Top	H_R36T	36 D x 1" H	3	44	85	661	684	707
	H_R42T	42" D x 1" H	4	56	85	784	811	839



- 1" thick thermally fused laminate (TFL)
- 3mm flat PVC edge banding
- Easily assembles to bases below

	Model	Overall	Cu. Ft.	Shp. Wt.	Fr. Cls.	Zone 1	Zone 2	Zone 3
24" Rectangular	CT_3624T	36" W x 24" D x 1" H	2.8	35	100	474	491	507
	CT_4824T	48" W x 24" D x 1" H	2.8	45	100	506	524	541



	Model	Overall	Cu. Ft.	Shp. Wt.	Fr. Cls.	Zone 1	Zone 2	Zone 3
30" Rectangular	CT_3630T	36" W x 30" D x 1" H	3.3	40	100	532	551	569
	CT_4830T	48" W x 30" D x 1" H	3.3	56	100	570	590	610



	Model	Overall	Cu. Ft.	Shp. Wt.	Fr. Cls.	Zone 1	Zone 2	Zone 3
Base for 29" High Table	BTR534TB	30" D x 28" H	21	70	250	706	731	755



- Dining height
- 3" diameter powder-coated steel column on 30" D cast base
- Easy assembly

	Model	Overall	Cu. Ft.	Shp. Wt.	Fr. Cls.	Zone 1	Zone 2	Zone 3
Base for 42" High Table	BTR536TB	30" D x 40.75" H	30	90	250	959	993	1026



- Bistro/standing height
- 3" diameter powder-coated steel column on 30" D cast base
- Foot ring included
- Easy assembly



Seating





Accompany

LOUNGE SEATING - SIN 33721

Side-By-Side Comfort

Accompany invites users to sit side-by-side in comfort. Especially suited for public areas and waiting rooms, the gentle curves and visual scale of Accompany creates an impression of comfort and encourages users to relax. Enjoy strong, upright support for conversation-friendly sitting. Separate components allow configuration beyond just three seats. Modular units can be added or removed from a seating configuration providing a sensible approach to the constantly changing demands of business.

Product Details

- Commercial-grade engineered hardwood frame with reinforcing corner blocks are glued and stapled
- Fully upholstered with double-needle trim on seat, back and arms to reinforce sewing
- Taut seat, no-sag springs
- High density foam adds comfort
- Metal-to-metal connection of arms, seat and back ensures long-term durability

- Wood finish legs with non-marring floor glides or brushed aluminum cylinder legs with adjustable glides
- Two-color combinations available
- Hybrid soy-based, CFC-free foam
- All listed product options must be factory installed

How to Specify:

- 1 Model number
- 2 Wood finish
- 3 Fabric grade & name for seat & back
- 4 Fabric grade & name for arms (if different)
- 5 Options

Options	Code	Price
Genesis Tablet	GT	663
Single Pivot Tablet	LT	663
Double Pivot Tablet	DT	885
Softer Seat Foam - Chair	SF	22
Softer Seat Foam - Loveseat	SF	44
Softer Seat Foam - Sofa	SF	66

Wood Finishes	Code
Black	BLK
Boardwalk	BW
Driftwood	DW
Espresso	ESP
Mahogany	MAH
Moab	MOB
Monticello Maple	MM
Natural Maple	FM
Shoreline	SL
Windsor Cherry	WC

Finished Example

5901/FM/5 Mayer Align Cyberspace/1 Culp Dillon Iron/GT

Wood

5901 Club chair

NOW



Overall	Seat	St. Ydg.	Cu. Ft.	Shp. Wt.	Fr. Cls.
32.5" W x 29" D x 31" H	21" W x 19" D x 19" H	5	29	80	250

	1	2/COM	3/COL	4	5	6	7	8	9	10	11	12/L	13	14	15/LL
Zone 1	1829	2089	2319	2448	2644	2721	2899	3040	3239	3487	3695	3971	4170	4480	4874
Zone 2	1893	2162	2400	2534	2737	2816	3000	3146	3352	3609	3824	4110	4316	4637	5045
Zone 3	1957	2235	2481	2619	2829	2911	3102	3253	3466	3731	3954	4249	4462	4794	5215

• Wood legs

Option	Code	Price
Casters	C	111

5902 Two seat lounge

NOW

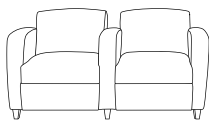

Overall	Seat	St. Ydg.	Cu. Ft.	Shp. Wt.	Fr. Cls.
59.75" W x 29" D x 31" H	21 ea." W x 19" D x 19" H	9	42	146	250

	1	2/COM	3/COL	4	5	6	7	8	9	10	11	12/L	13	14	15/LL
Zone 1	3092	3532	3911	4045	4155	4394	4627	4804	5176	5518	5869	6165	6449	7023	7423
Zone 2	3200	3656	4048	4187	4300	4548	4789	4972	5357	5711	6074	6381	6675	7269	7683
Zone 3	3308	3779	4185	4328	4446	4702	4951	5140	5538	5904	6280	6597	6900	7515	7943

• Wood legs

5903 Three seat lounge

NOW

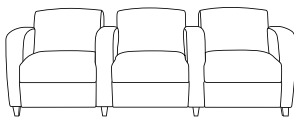

Overall	Seat	St. Ydg.	Cu. Ft.	Shp. Wt.	Fr. Cls.
86.5" W x 29" D x 31" H	21 ea." W x 19" D x 19" H	12.5	75	200	250

	1	2/COM	3/COL	4	5	6	7	8	9	10	11	12/L	13	14	15/LL
Zone 1	4321	4961	5536	5807	6034	6283	6465	7230	7707	8301	8588	9381	9779	10174	11777
Zone 2	4472	5135	5730	6010	6245	6503	6691	7483	7977	8592	8889	9709	10121	10530	12189
Zone 3	4623	5308	5924	6213	6456	6723	6918	7736	8246	8882	9189	10038	10464	10886	12601

• Wood legs

5904 Armless lounge chair

NOW

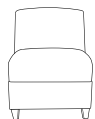

Overall	Seat	St. Ydg.	Cu. Ft.	Shp. Wt.	Fr. Cls.
22" W x 29" D x 31" H	22" W x 19" D x 19" H	3.5	19	43	250

	1	2/COM	3/COL	4	5	6	7	8	9	10	11	12/L	13	14	15/LL
Zone 1	1276	1377	1483	1578	1673	1799	1848	2054	2180	2337	2471	2693	2805	2916	3082
Zone 2	1321	1425	1535	1633	1732	1862	1913	2126	2256	2419	2557	2787	2903	3018	3190
Zone 3	1365	1473	1587	1688	1790	1925	1977	2198	2333	2501	2644	2882	3001	3120	3298

• Wood legs

5904-CL Armless lounge chair

NOW

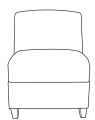

Overall	Seat	St. Ydg.	Cu. Ft.	Shp. Wt.	Fr. Cls.
22" W x 29" D x 31" H	22" W x 19" D x 19" H	3.5	19	43	250

	1	2/COM	3/COL	4	5	6	7	8	9	10	11	12/L	13	14	15/LL
Zone 1	1405	1515	1631	1736	1841	1980	2033	2259	2399	2571	2710	2822	2933	3043	3390
Zone 2	1454	1568	1688	1797	1905	2049	2104	2338	2483	2661	2805	2921	3036	3150	3509
Zone 3	1503	1621	1745	1858	1970	2119	2175	2417	2567	2751	2900	3020	3138	3256	3627

• Wood legs

• Not freestanding

• Connects on left-side facing to 5913 left arm module

5904-CR Armless lounge chair

NOW



Overall	Seat	St. Ydg.	Cu. Ft.	Shp. Wt.	Fr. Cls.
22" W x 29" D x 31" H	22" W x 19" D x 19" H	3.5	19	43	250

	1	2/COM	3/COL	4	5	6	7	8	9	10	11	12/L	13	14	15/LL
Zone 1	1405	1515	1631	1736	1841	1980	2033	2259	2399	2571	2710	2822	2933	3043	3390
Zone 2	1454	1568	1688	1797	1905	2049	2104	2338	2483	2661	2805	2921	3036	3150	3509
Zone 3	1503	1621	1745	1858	1970	2119	2175	2417	2567	2751	2900	3020	3138	3256	3627

• Wood legs

• Not freestanding

• Connects on right-side facing to 5914 right arm module

5904-CLR

Armless lounge chair

NOW

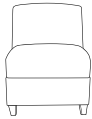

Overall	Seat											St. Ydg.	Cu. Ft.	Shp. Wt.	Fr. Cls.
22" W x 29" D x 31" H	22" W x 19" D x 19" H											3.5	19	43	250

	1	2/COM	3/COL	4	5	6	7	8	9	10	11	12/L	13	14	15/LL
Zone 1	1405	1515	1631	1736	1841	1980	2033	2259	2399	2571	2710	2822	2933	3043	3390
Zone 2	1454	1568	1688	1797	1905	2049	2104	2338	2483	2661	2805	2921	3036	3150	3509
Zone 3	1503	1621	1745	1858	1970	2119	2175	2417	2567	2751	2900	3020	3138	3256	3627

- Wood legs
- Not freestanding
- Connects on both sides

5905

Loveseat

NOW

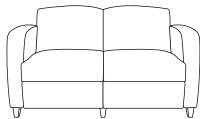

Overall	Seat											St. Ydg.	Cu. Ft.	Shp. Wt.	Fr. Cls.
54.5" W x 29" D x 31" H	43.5" W x 19" D x 19" H											8.5	41	118	250

	1	2/COM	3/COL	4	5	6	7	8	9	10	11	12/L	13	14	15/LL
Zone 1	2603	2859	3113	3354	3591	3911	4032	4544	4858	5257	5506	5776	6044	6314	6638
Zone 2	2694	2959	3222	3471	3717	4048	4173	4703	5028	5441	5699	5978	6256	6535	6870
Zone 3	2785	3059	3331	3589	3842	4185	4314	4862	5198	5625	5891	6180	6467	6756	7103

- Wood legs

5906

Sofa

NOW

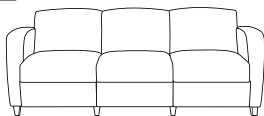

Overall	Seat											St. Ydg.	Cu. Ft.	Shp. Wt.	Fr. Cls.
76" W x 29" D x 31" H	65" W x 19" D x 19" H											10.5	77	170	250

	1	2/COM	3/COL	4	5	6	7	8	9	10	11	12/L	13	14	15/LL
Zone 1	3658	4005	4353	4675	4996	5425	5589	6282	6708	7242	7576	7909	8243	8575	9133
Zone 2	3786	4145	4505	4839	5171	5615	5785	6502	6943	7495	7841	8186	8532	8875	9453
Zone 3	3914	4285	4658	5002	5346	5805	5980	6722	7178	7749	8106	8463	8820	9175	9772

- Wood legs

5908

Armless Loveseat

NOW

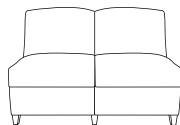

Overall	Seat											St. Ydg.	Cu. Ft.	Shp. Wt.	Fr. Cls.
43.5" W x 29" D x 31" H	43.5" W x 19" D x 19" H											7	42	86	250

	1	2/COM	3/COL	4	5	6	7	8	9	10	11	12/L	13	14	15/LL
Zone 1	2399	2520	2702	2823	2945	3127	3308	3491	3653	3874	4076	4320	4560	4764	5006
Zone 2	2483	2608	2797	2922	3048	3236	3424	3613	3781	4010	4219	4471	4720	4931	5181
Zone 3	2567	2696	2891	3021	3151	3346	3540	3735	3909	4145	4361	4622	4879	5097	5356

- Wood legs

5909

Armless Sofa

NOW

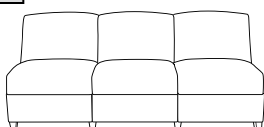

Overall	Seat											St. Ydg.	Cu. Ft.	Shp. Wt.	Fr. Cls.
65" W x 29" D x 31" H	65" W x 19" D x 19" H											9.25	77	142	250

	1	2/COM	3/COL	4	5	6	7	8	9	10	11	12/L	13	14	15/LL
Zone 1	3446	3606	3848	4007	4167	4407	4648	4888	5102	5395	5663	5983	6304	6570	6891
Zone 2	3567	3732	3983	4147	4313	4561	4811	5059	5281	5584	5861	6192	6525	6800	7132
Zone 3	3687	3858	4117	4287	4459	4715	4973	5230	5459	5773	6059	6402	6745	7030	7373

	Overall	Seat											St. Ydg.	Cu. Ft.	Shp. Wt.	Fr. Cls.
5911	22" W x 29" D x 28" H	21" W x 19" D x 19" H											3	20	37	250
		1	2/COM	3/COL	4	5	6	7	8	9	10	11	12/L	13	14	15/LL
Zone 1		853	986	1119	1202	1310	1353	1532	1642	1781	2044	2162	2328	2353	2421	2566
Zone 2		883	1021	1158	1244	1356	1400	1586	1699	1843	2116	2238	2409	2435	2506	2656
Zone 3		913	1055	1197	1286	1402	1448	1639	1757	1906	2187	2313	2491	2518	2590	2746

Center seat module

NOW

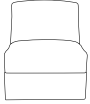

- Not freestanding
- Connects with 5912 arm to create custom configurations

	Overall	Seat											St. Ydg.	Cu. Ft.	Shp. Wt.	Fr. Cls.
5912	6" W x 29" D x 25.5" H	N/A" W x N/A" D x N/A" H											1.75	4.3	20	85
		1	2/COM	3/COL	4	5	6	7	8	9	10	11	12/L	13	14	15/LL
Zone 1		463	536	599	637	693	713	802	858	930	1059	1115	1172	1227	1284	1375
Zone 2		479	555	620	659	717	738	830	888	963	1096	1154	1213	1270	1329	1423
Zone 3		495	574	641	682	742	763	858	918	995	1133	1193	1254	1313	1374	1471

Center tapered arm module

NOW

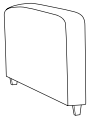

- Wood legs
- Creates custom configurations

	Overall	Seat											St. Ydg.	Cu. Ft.	Shp. Wt.	Fr. Cls.
5913	26.5" W x 29" D x 31" H	21" W x 19" D x 19" H											4.75	28	55	250
		1	2/COM	3/COL	4	5	6	7	8	9	10	11	12/L	13	14	15/LL
Zone 1		1343	1554	1745	1862	2028	2091	2362	2525	2733	3127	3267	3416	3567	3718	3786
Zone 2		1390	1608	1806	1927	2099	2164	2445	2613	2829	3236	3381	3536	3692	3848	3919
Zone 3		1437	1663	1867	1992	2170	2237	2527	2702	2924	3346	3496	3655	3817	3978	4051

Left arm/seat module

NOW



- Wood legs
- Not freestanding; creates custom configurations

	Overall	Seat											St. Ydg.	Cu. Ft.	Shp. Wt.	Fr. Cls.
5914	26.5" W x 29" D x 31" H	21" W x 19" D x 19" H											4.75	28	55	250
		1	2/COM	3/COL	4	5	6	7	8	9	10	11	12/L	13	14	15/LL
Zone 1		1343	1554	1745	1862	2028	2091	2362	2525	2733	3127	3267	3416	3567	3718	3786
Zone 2		1390	1608	1806	1927	2099	2164	2445	2613	2829	3236	3381	3536	3692	3848	3919
Zone 3		1437	1663	1867	1992	2170	2237	2527	2702	2924	3346	3496	3655	3817	3978	4051

Right arm/seat module

NOW



- Wood legs
- Not freestanding; creates custom configurations

	Overall	Seat											St. Ydg.	Cu. Ft.	Shp. Wt.	Fr. Cls.
5924	23" W x 27" D x 11.5" H												1.5	10	49	175
		1	2/COM	3/COL	4	5	6	7	8	9	10	11	12/L	13	14	15/LL
Zone 1		1420	1449	1485	1520	1554	1598	1641	1685	1728	1781	1794	1851	1884	1931	2045
Zone 2		1470	1500	1537	1573	1608	1654	1698	1744	1788	1843	1857	1916	1950	1999	2117
Zone 3		1519	1550	1589	1626	1663	1710	1756	1803	1849	1906	1920	1981	2016	2066	2188

Freestanding Rectangle table;
Laminate top; Upholstered sides

NOW



- Wood legs available in MOB, but not laminate top
- Specify CR suffix (right-side facing) to attach to 5914 right arm module
- Specify CL suffix (left-side facing) to attach to 5913 left arm module
- Specify CLR suffix to attach to 5913 left arm and 5914 right arm modules

Accompany

5925	Overall	36" W x 28" D x 11.5" H	St. Ydg.	Cu. Ft.	Shp. Wt.	Fr. Cls.
			1.5	17.5	62	175

Freestanding 30° wedge table;
Laminate top; Upholstered sides

NOW



	1	2/COM	3/COL	4	5	6	7	8	9	10	11	12/L	13	14	15/LL
Zone 1	1463	1492	1525	1564	1600	1641	1685	1729	1770	1826	1861	1894	1955	2031	2072
Zone 2	1514	1544	1578	1619	1656	1698	1744	1790	1832	1890	1926	1960	2023	2102	2145
Zone 3	1565	1596	1632	1673	1712	1756	1803	1850	1894	1954	1991	2027	2092	2173	2217

- Wood legs available in MOB, but not laminate top
- Specify CR suffix (right-side facing) to attach to 5914 right arm module
- Specify CL suffix (left-side facing) to attach to 5913 left arm module
- Specify CLR suffix to attach to 5913 left arm and 5914 right arm modules

5935-OF	Overall	38" W x 31" D x 31" H	Seat	27-34.5" W x 19" D x 19" H	St. Ydg.	Cu. Ft.	Shp. Wt.	Fr. Cls.
					4	31	65	250

30° outside facing chair

NOW



	1	2/COM	3/COL	4	5	6	7	8	9	10	11	12/L	13	14	15/LL
Zone 1	1966	2044	2138	2266	2364	2488	2612	2743	2868	3027	3070	3113	3311	3437	3587
Zone 2	2035	2116	2213	2345	2447	2575	2703	2839	2968	3133	3177	3222	3427	3557	3713
Zone 3	2104	2187	2288	2425	2529	2662	2795	2935	3069	3239	3285	3331	3543	3678	3838

- Wood legs

5935-IF	Overall	38" W x 31" D x 31" H	Seat	21.25-30.75" W x 19" D x 19" H	St. Ydg.	Cu. Ft.	Shp. Wt.	Fr. Cls.
					4.75	31	60	250

30° inside facing chair

NOW



	1	2/COM	3/COL	4	5	6	7	8	9	10	11	12/L	13	14	15/LL
Zone 1	1966	2044	2138	2266	2364	2488	2612	2743	2868	3027	3070	3113	3311	3437	3587
Zone 2	2035	2116	2213	2345	2447	2575	2703	2839	2968	3133	3177	3222	3427	3557	3713
Zone 3	2104	2187	2288	2425	2529	2662	2795	2935	3069	3239	3285	3331	3543	3678	3838

- Wood legs

5948	Overall	48" W x 48" D x 14.5" H	St. Ydg.	Cu. Ft.	Shp. Wt.	Fr. Cls.
			3	41.5	135	250

Round table/ottoman

NOW

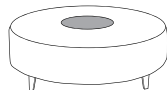

	1	2/COM	3/COL	4	5	6	7	8	9	10	11	12/L	13	14	15/LL
Zone 1	2668	2722	2795	2851	2907	2991	3064	3148	3221	3313	3422	3535	3657	3786	3882
Zone 2	2761	2817	2893	2951	3009	3096	3171	3258	3334	3429	3542	3659	3785	3919	4018
Zone 3	2855	2913	2991	3051	3110	3200	3278	3368	3446	3545	3662	3782	3913	4051	4154

- Wood legs
 - 18" diameter laminate top in center not available in MOB
- | Option | Code | Price |
|------------------|------|-------|
| All Laminate Top | QT | 827 |

5965-OF	Overall	70" W x 32.5" D x 31" H	Seat	52.5-70" W x 19" D x 19" H	St. Ydg.	Cu. Ft.	Shp. Wt.	Fr. Cls.
					5	74	125	250

60° outside facing loveseat

NOW

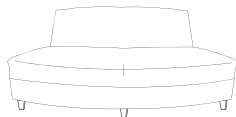

	1	2/COM	3/COL	4	5	6	7	8	9	10	11	12/L	13	14	15/LL
Zone 1	2998	3150	3331	3580	3761	4009	4174	4399	4745	5052	5143	5221	5396	5643	5781
Zone 2	3103	3260	3448	3705	3893	4149	4320	4553	4911	5229	5323	5404	5585	5841	5983
Zone 3	3208	3371	3564	3831	4024	4290	4466	4707	5077	5406	5503	5586	5774	6038	6186

- Wood legs

5965-IF	Overall	70" W x 32.5" D x 31" H	Seat	45-63" W x 19" D x 19" H	St. Ydg.	Cu. Ft.	Shp. Wt.	Fr. Cls.
					7.75	77	126	250

60° inside facing loveseat

NOW

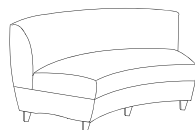

	1	2/COM	3/COL	4	5	6	7	8	9	10	11	12/L	13	14	15/LL
Zone 1	2998	3150	3331	3580	3761	4009	4174	4399	4745	5052	5143	5221	5396	5643	5781
Zone 2	3103	3260	3448	3705	3893	4149	4320	4553	4911	5229	5323	5404	5585	5841	5983
Zone 3	3208	3371	3564	3831	4024	4290	4466	4707	5077	5406	5503	5586	5774	6038	6186

- Wood legs

Metal

	Overall	Seat											St. Ydg.	Cu. Ft.	Shp. Wt.	Fr. Cls.	
5901MET	32.5" W x 29" D x 32.5" H	21" W x 19" D x 19" H											5	31	83	250	
Club chair																	
Now		1	2/COM	3/COL	4	5	6	7	8	9	10	11	12/L	13	14	15/LL	
Zone 1		1920	2168	2391	2539	2734	2813	2992	3132	3332	3579	3784	4102	4261	4419	4963	
Zone 2		1987	2244	2475	2628	2830	2911	3097	3242	3449	3704	3916	4246	4410	4574	5137	
Zone 3		2054	2320	2558	2717	2925	3010	3201	3351	3565	3830	4049	4389	4559	4728	5310	



•Metal legs

	Overall	Seat											St. Ydg.	Cu. Ft.	Shp. Wt.	Fr. Cls.	
5902MET	59.75" W x 29" D x 32.5" H	21 ea" W x 19" D x 19" H											9	51	148	250	
Two seat lounge																	
Now		1	2/COM	3/COL	4	5	6	7	8	9	10	11	12/L	13	14	15/LL	
Zone 1		3216	3638	3997	4279	4621	4749	5019	5299	5641	6069	6288	6574	6859	7145	7949	
Zone 2		3329	3765	4137	4429	4783	4915	5195	5484	5838	6281	6508	6804	7099	7395	8227	
Zone 3		3441	3893	4277	4579	4944	5081	5370	5670	6036	6494	6728	7034	7339	7645	8505	

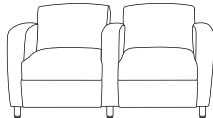

•Metal legs

	Overall	Seat											St. Ydg.	Cu. Ft.	Shp. Wt.	Fr. Cls.	
5903MET	86.5" W x 29" D x 32.5" H	21" W x 19" D x 19" H											12.5	77	206	250	
Three seat lounge																	
Now		1	2/COM	3/COL	4	5	6	7	8	9	10	11	12/L	13	14	15/LL	
Zone 1		4491	5100	5648	5976	6450	6780	7399	7876	8469	8937	9154	9552	9948	10345	10743	
Zone 2		4648	5279	5846	6185	6676	7017	7658	8152	8765	9250	9474	9886	10296	10707	11119	
Zone 3		4805	5457	6043	6394	6902	7255	7917	8427	9062	9563	9795	10221	10644	11069	11495	

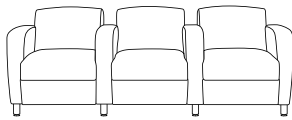

•Metal legs

	Overall	Seat											St. Ydg.	Cu. Ft.	Shp. Wt.	Fr. Cls.	
5904MET	22" W x 29" D x 32.5" H	21" W x 19" D x 19" H											3.5	22	50	250	
Armless lounge chair																	
Now		1	2/COM	3/COL	4	5	6	7	8	9	10	11	12/L	13	14	15/LL	
Zone 1		1396	1494	1591	1698	1794	1920	1968	2174	2298	2456	2590	2740	2812	3035	3336	
Zone 2		1445	1546	1647	1757	1857	1987	2037	2250	2378	2542	2681	2836	2910	3141	3453	
Zone 3		1494	1599	1702	1817	1920	2054	2106	2326	2459	2628	2771	2932	3009	3247	3570	

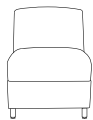

•Metal legs

	Overall	Seat											St. Ydg.	Cu. Ft.	Shp. Wt.	Fr. Cls.	
5904MET-CL	22" W x 29" D x 32.5" H	21" W x 19" D x 19" H											3.5	22	50	250	
Armless lounge chair																	
Now		1	2/COM	3/COL	4	5	6	7	8	9	10	11	12/L	13	14	15/LL	
Zone 1		1536	1643	1751	1868	1973	2110	2166	2391	2529	2702	2841	3014	3062	3174	3669	
Zone 2		1590	1701	1812	1933	2042	2184	2242	2475	2618	2797	2940	3119	3169	3285	3797	
Zone 3		1644	1758	1874	1999	2111	2258	2318	2558	2706	2891	3040	3225	3276	3396	3926	

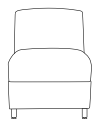

•Metal legs

•Not freestanding

•Connects on left-side facing to 5913MET left arm module

Accompany

	Overall	Seat													St. Ydg.	Cu. Ft.	Shp. Wt.	Fr. Cls.		
5904MET-CR Armless lounge chair	22" W x 29" D x 32.5" H	21" W x 19" D x 19" H													3.5	22	50	250		
NOW		1	2/COM	3/COL	4	5	6	7	8	9	10	11	12/L	13	14	15/LL				
	Zone 1	1536	1643	1751	1868	1973	2110	2166	2391	2529	2702	2841	3014	3062	3174	3669				
	Zone 2	1590	1701	1812	1933	2042	2184	2242	2475	2618	2797	2940	3119	3169	3285	3797				
	Zone 3	1644	1758	1874	1999	2111	2258	2318	2558	2706	2891	3040	3225	3276	3396	3926				
		• Metal legs			• Not freestanding				• Connects on right-side facing to 5914MET right arm module											

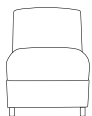
	Overall	Seat													St. Ydg.	Cu. Ft.	Shp. Wt.	Fr. Cls.		
5904MET-CLR Armless lounge chair	22" W x 29" D x 32.5" H	21" W x 19" D x 19" H													3.5	22	50	250		
NOW		1	2/COM	3/COL	4	5	6	7	8	9	10	11	12/L	13	14	15/LL				
	Zone 1	1536	1643	1751	1868	1973	2110	2166	2391	2529	2702	2841	3014	3062	3174	3669				
	Zone 2	1590	1701	1812	1933	2042	2184	2242	2475	2618	2797	2940	3119	3169	3285	3797				
	Zone 3	1644	1758	1874	1999	2111	2258	2318	2558	2706	2891	3040	3225	3276	3396	3926				
		• Metal legs			• Not freestanding				• Connects on both sides											

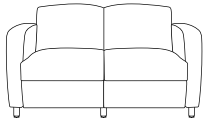
	Overall	Seat													St. Ydg.	Cu. Ft.	Shp. Wt.	Fr. Cls.	
5905MET Loveseat	54.5" W x 29" D x 32.5" H	43.5" W x 19" D x 19" H													8.5	41	123	250	
NOW		1	2/COM	3/COL	4	5	6	7	8	9	10	11	12/L	13	14	15/LL			
	Zone 1	2749	2995	3237	3500	3739	4055	4176	4691	5006	5402	5650	5920	6190	6460	7211			
	Zone 2	2845	3100	3350	3623	3870	4197	4322	4855	5181	5591	5848	6127	6407	6686	7463			
	Zone 3	2941	3205	3464	3745	4001	4339	4468	5019	5356	5780	6046	6334	6623	6912	7716			
		• Metal legs																	

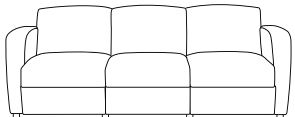
	Overall	Seat													St. Ydg.	Cu. Ft.	Shp. Wt.	Fr. Cls.	
5906MET Sofa	76" W x 29" D x 32.5" H	65" W x 19" D x 19" H													10.5	77	176	250	
NOW		1	2/COM	3/COL	4	5	6	7	8	9	10	11	12/L	13	14	15/LL			
	Zone 1	3846	4172	4505	4860	5183	5612	5777	6466	6893	7426	7763	8096	8430	8763	9381			
	Zone 2	3981	4318	4663	5030	5364	5808	5979	6692	7134	7686	8035	8379	8725	9070	9709			
	Zone 3	4115	4464	4820	5200	5546	6005	6181	6919	7376	7946	8306	8663	9020	9376	10038			
		• Metal legs																	

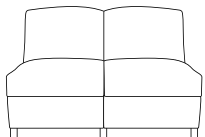
	Overall	Seat													St. Ydg.	Cu. Ft.	Shp. Wt.	Fr. Cls.	
5908MET Armless Loveseat	43.5" W x 29" D x 32.5" H	43.5" W x 19" D x 19" H													7	42	86	250	
NOW		1	2/COM	3/COL	4	5	6	7	8	9	10	11	12/L	13	14	15/LL			
	Zone 1	2546	2668	2848	2972	3092	3274	3455	3638	3799	4021	4223	4466	4709	4910	5154			
	Zone 2	2635	2761	2948	3076	3200	3389	3576	3765	3932	4162	4371	4622	4874	5082	5334			
	Zone 3	2724	2855	3047	3180	3308	3503	3697	3893	4065	4302	4519	4779	5039	5254	5515			
		• Metal legs																	

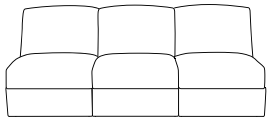
	Overall	Seat													St. Ydg.	Cu. Ft.	Shp. Wt.	Fr. Cls.	
5909MET Armless Sofa	65" W x 29" D x 32.5" H	65" W x 19" D x 19" H													9.25	77	142	250	
NOW		1	2/COM	3/COL	4	5	6	7	8	9	10	11	12/L	13	14	15/LL			
	Zone 1	3641	3801	4043	4202	4362	4603	4843	5083	5297	5590	5859	6178	6499	6765	7086			
	Zone 2	3768	3934	4185	4349	4515	4764	5013	5261	5482	5786	6064	6394	6726	7002	7334			
	Zone 3	3896	4067	4326	4496	4667	4925	5182	5439	5668	5981	6269	6610	6954	7239	7582			
		• Metal legs																	

5911	Overall	Seat	St. Ydg.	Cu. Ft.	Shp. Wt.	Fr. Cls.
Center seat module	22" W x 29" D x 28" H	21" W x 19" D x 19" H	3	20	37	250

NOW

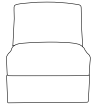

	1	2/COM	3/COL	4	5	6	7	8	9	10	11	12/L	13	14	15/LL
Zone 1	853	986	1119	1202	1310	1353	1532	1642	1781	2044	2162	2328	2353	2421	2566
Zone 2	883	1021	1158	1244	1356	1400	1586	1699	1843	2116	2238	2409	2435	2506	2656
Zone 3	913	1055	1197	1286	1402	1448	1639	1757	1906	2187	2313	2491	2518	2590	2746

- Not freestanding
- Connects with 5912MET arm to create custom configurations

5912MET	Overall	St. Ydg.	Cu. Ft.	Shp. Wt.	Fr. Cls.
Center tapered arm module	6" W x 29" D x 27" H	1.75	6	20	70

NOW

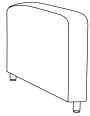

	1	2/COM	3/COL	4	5	6	7	8	9	10	11	12/L	13	14	15/LL
Zone 1	532	601	661	706	762	782	816	872	929	997	1028	1084	1130	1185	1302
Zone 2	551	622	684	731	789	809	845	903	962	1032	1064	1122	1170	1226	1348
Zone 3	569	643	707	755	815	837	873	933	994	1067	1100	1160	1209	1268	1393

- Metal legs
- Not freestanding; used to create custom configurations

5913MET	Overall	Seat	St. Ydg.	Cu. Ft.	Shp. Wt.	Fr. Cls.
Left arm/seat module	26.5" W x 29" D x 32.5" H	21" W x 19" D x 19" H	4.75	28	56	250

NOW

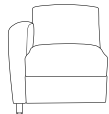

	1	2/COM	3/COL	4	5	6	7	8	9	10	11	12/L	13	14	15/LL
Zone 1	1367	1571	1754	1889	2056	2120	2254	2388	2554	2762	2838	3035	3140	3290	3694
Zone 2	1415	1626	1815	1955	2128	2194	2333	2472	2643	2859	2937	3141	3250	3405	3823
Zone 3	1463	1681	1877	2021	2200	2268	2412	2555	2733	2955	3037	3247	3360	3520	3953

- Metal legs
- Not freestanding; used to create custom configurations

5914MET	Overall	Seat	St. Ydg.	Cu. Ft.	Shp. Wt.	Fr. Cls.
Right arm/seat module	26.5" W x 29" D x 32.5" H	21" W x 19" D x 19" H	4.75	28	56	250

NOW

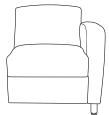

	1	2/COM	3/COL	4	5	6	7	8	9	10	11	12/L	13	14	15/LL
Zone 1	1367	1571	1754	1889	2056	2120	2254	2388	2554	2762	2838	3035	3140	3290	3694
Zone 2	1415	1626	1815	1955	2128	2194	2333	2472	2643	2859	2937	3141	3250	3405	3823
Zone 3	1463	1681	1877	2021	2200	2268	2412	2555	2733	2955	3037	3247	3360	3520	3953

- Metal legs
- Not freestanding; used to create custom configurations

5921MET	Overall	St. Ydg.	Cu. Ft.	Shp. Wt.	Fr. Cls.
Oval table; Upholstered sides; Floating laminate top	42.5" W x 21.5" D x 19.25" H	4.5	17	64	250

NOW



	1	2/COM	3/COL	4	5	6	7	8	9	10	11	12/L	13	14	15/LL
Zone 1	1766	1799	1839	1873	1908	1953	1999	2043	2089	2147	2168	2206	2261	2309	2414
Zone 2	1828	1862	1903	1939	1975	2021	2069	2115	2162	2222	2244	2283	2340	2390	2498
Zone 3	1890	1925	1968	2004	2042	2090	2139	2186	2235	2297	2320	2360	2419	2471	2583

- Metal legs
- Laminate top not available in MOB

5922MET	Overall	St. Ydg.	Cu. Ft.	Shp. Wt.	Fr. Cls.
Oval table; Upholstered sides; Laminate top	42.5" W x 21.5" D x 17.25" H	4.5	17	63	250

NOW



	1	2/COM	3/COL	4	5	6	7	8	9	10	11	12/L	13	14	15/LL
Zone 1	1726	1759	1798	1832	1867	1912	1956	2003	2048	2105	2127	2165	2221	2265	2373
Zone 2	1786	1821	1861	1896	1932	1979	2024	2073	2120	2179	2201	2241	2299	2344	2456
Zone 3	1847	1882	1924	1960	1998	2046	2093	2143	2191	2252	2276	2317	2376	2424	2539

- Metal legs
- Laminate top not available in MOB

Accompany

Overall		St. Ydg.	Cu. Ft.	Shp. Wt.	Fr. Cls.										
5924MET 23" W x 27" D x 13" H		1.5	9	49	175										
Connecting/freestanding table; Laminate top; Upholstered sides															
	1	2/COM	3/COL	4	5	6	7	8	9	10	11	12/L	13	14	15/LL
Zone 1	1420	1449	1485	1520	1554	1598	1641	1685	1728	1781	1794	1851	1884	1931	2045
Zone 2	1470	1500	1537	1573	1608	1654	1698	1744	1788	1843	1857	1916	1950	1999	2117
Zone 3	1519	1550	1589	1626	1663	1710	1756	1803	1849	1906	1920	1981	2016	2066	2188
<ul style="list-style-type: none"> • Metal legs • Laminate top not available in MOB 															



Overall		St. Ydg.	Cu. Ft.	Shp. Wt.	Fr. Cls.										
5925MET 36" W x 28" D x 13" H		1.5	16	62	250										
30° wedge connecting/ freestanding table; Laminate top; Upholstered sides															
	1	2/COM	3/COL	4	5	6	7	8	9	10	11	12/L	13	14	15/LL
Zone 1	1463	1492	1525	1564	1600	1641	1685	1729	1770	1826	1869	1894	1955	2043	2072
Zone 2	1514	1544	1578	1619	1656	1698	1744	1790	1832	1890	1934	1960	2023	2115	2145
Zone 3	1565	1596	1632	1673	1712	1756	1803	1850	1894	1954	2000	2027	2092	2186	2217
<ul style="list-style-type: none"> • Metal legs • Laminate top not available in MOB 															



Overall		St. Ydg.	Cu. Ft.	Shp. Wt.	Fr. Cls.										
5926MET 42.5" W x 21.5" D x 16.25" H		4.5	17	44	250										
Oval table; Fully Upholstered															
	1	2/COM	3/COL	4	5	6	7	8	9	10	11	12/L	13	14	15/LL
Zone 1	1471	1506	1545	1579	1614	1660	1703	1752	1796	1853	1885	1911	1966	2013	2131
Zone 2	1522	1559	1599	1634	1670	1718	1763	1813	1859	1918	1951	1978	2035	2083	2206
Zone 3	1574	1611	1653	1690	1727	1776	1822	1875	1922	1983	2017	2045	2104	2154	2280
<ul style="list-style-type: none"> • Metal legs 															

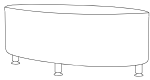

Overall		Seat		St. Ydg.	Cu. Ft.	Shp. Wt.	Fr. Cls.								
5935MET-OF 38" W x 32" D x 32.5" H		27.5-34.5" W x 19" D x 19" H		4	31	58	250								
30° outside facing chair															
	1	2/COM	3/COL	4	5	6	7	8	9	10	11	12/L	13	14	15/LL
Zone 1	1966	2044	2138	2266	2364	2488	2612	2743	2868	3027	3070	3113	3311	3437	3587
Zone 2	2035	2116	2213	2345	2447	2575	2703	2839	2968	3133	3177	3222	3427	3557	3713
Zone 3	2104	2187	2288	2425	2529	2662	2795	2935	3069	3239	3285	3331	3543	3678	3838
<ul style="list-style-type: none"> • Metal legs 															



Overall		Seat		St. Ydg.	Cu. Ft.	Shp. Wt.	Fr. Cls.								
5935MET-IF 38" W x 32" D x 32.5" H		21.25-30.75" W x 19" D x 19" H		4.75	31	66	250								
30° inside facing chair															
	1	2/COM	3/COL	4	5	6	7	8	9	10	11	12/L	13	14	15/LL
Zone 1	1966	2044	2138	2266	2364	2488	2612	2743	2868	3027	3070	3113	3311	3437	3587
Zone 2	2035	2116	2213	2345	2447	2575	2703	2839	2968	3133	3177	3222	3427	3557	3713
Zone 3	2104	2187	2288	2425	2529	2662	2795	2935	3069	3239	3285	3331	3543	3678	3838
<ul style="list-style-type: none"> • Metal legs 															



5936MET

36" round table; Upholstered sides; Laminate top

Now



Overall	St. Ydg.	Cu. Ft.	Shp. Wt.	Fr. Cls.
36" W x 36" D x 22.5" H	4.5	41.5	135	250

	1	2/COM	3/COL	4	5	6	7	8	9	10	11	12/L	13	14	15/LL
Zone 1	2118	2181	2258	2321	2389	2474	2559	2646	2732	2840	2882	2937	2993	3043	3393
Zone 2	2192	2257	2337	2402	2473	2561	2649	2739	2828	2939	2983	3040	3098	3150	3512
Zone 3	2266	2334	2416	2483	2556	2647	2738	2831	2923	3039	3084	3143	3203	3256	3631

- Metal legs
- Laminate top not available in MOB

5948MET

Round table/ottoman

Now

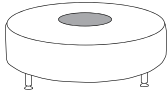

Overall	St. Ydg.	Cu. Ft.	Shp. Wt.	Fr. Cls.
48" W x 48" D x 14.5" H	3	51	147	250

	1	2/COM	3/COL	4	5	6	7	8	9	10	11	12/L	13	14	15/LL
Zone 1	2668	2722	2795	2851	2907	2991	3064	3148	3221	3313	3399	3518	3598	3692	3799
Zone 2	2761	2817	2893	2951	3009	3096	3171	3258	3334	3429	3518	3641	3724	3821	3932
Zone 3	2855	2913	2991	3051	3110	3200	3278	3368	3446	3545	3637	3764	3850	3950	4065

- Metal legs
- 18" diameter laminate top in center not available in MOB

Option	Code	Price
All Laminate Top	QT	827

5965MET-OF

60° outside facing loveseat

Now

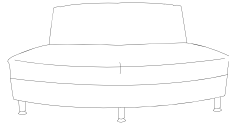

Overall	Seat	St. Ydg.	Cu. Ft.	Shp. Wt.	Fr. Cls.
70" W x 32.5" D x 32.5" H	52.5-70" W x 19" D x 19" H	7	74	124	250

	1	2/COM	3/COL	4	5	6	7	8	9	10	11	12/L	13	14	15/LL
Zone 1	2998	3150	3331	3580	3761	4009	4174	4399	4745	5052	5144	5221	5396	5559	5781
Zone 2	3103	3260	3448	3705	3893	4149	4320	4553	4911	5229	5324	5404	5585	5754	5983
Zone 3	3208	3371	3564	3831	4024	4290	4466	4707	5077	5406	5504	5586	5774	5948	6186

- Metal legs

5965MET-IF

60° inside facing loveseat

Now



Overall	Seat	St. Ydg.	Cu. Ft.	Shp. Wt.	Fr. Cls.
70" W x 32.5" D x 32.5" H	43-63" W x 19" D x 19" H	7.5	77	135	250

	1	2/COM	3/COL	4	5	6	7	8	9	10	11	12/L	13	14	15/LL
Zone 1	2998	3150	3331	3580	3761	4009	4174	4399	4745	5052	5144	5221	5396	5559	5781
Zone 2	3103	3260	3448	3705	3893	4149	4320	4553	4911	5229	5324	5404	5585	5754	5983
Zone 3	3208	3371	3564	3831	4024	4290	4466	4707	5077	5406	5504	5586	5774	5948	6186

- Metal legs



Chesterfield

LOUNGE SEATING - SIN 33721

Traditional Comfort

Chesterfield is a fully upholstered traditional lounge grouping. It is inspired by original designs features oversize scroll arms and extra-deep seat comfort. Accents include tufting, individually-placed brass nail trim and bun-style feet.

Product Details

- Frames of commercial grade engineered hardwood
- Frame components are glued and stapled
- Reinforcing corner blocks are glued and screwed
- Arms are custom fabricated and wrapped with foam and fiber
- Metal-to-metal connection to frame for long-term secure fastening

- High-density foam over heavy gauge, no-sag sinuous spring
- Traditional tufting upholstery stitching is standard
- Brass nail trim
- Bun feet
- Hybrid soy-based, CFC-free foam
- All listed product options must be factory installed

How to Specify:

- 1 Model number
- 2 Wood finish
- 3 Fabric grade & name
- 4 Options

Finished Example

4301/FM/7 Mayer Fabrics Plaza Celery/SN

Options	Code	Price
No Brass Nail Trim	NB	N/C
Silver Nail Trim	SN	N/C
Non-Tufted	NT	N/C

Leg Finishes	Code
Black	BLK
Boardwalk	BW
Driftwood	DW
Espresso	ESP
Mahogany	MAH
Moab	MOB
Monticello Maple	MM
Natural Maple	FM
Shoreline	SL
Windsor Cherry	WC

4301

Traditional tufted chair



	Overall		Seat									St. Ydg.	Cu. Ft.	Shp. Wt.	Fr. Cls.
	40" W x 36" D x 28" H		24.5" W x 23.5" D x 18" H									6.5	31	95	250
	1	2/COM	3/COL	4	5	6	7	8	9	10	11	12/L	13	14	15/LL
Zone 1	2909	3192	3447	3604	3823	4055	4268	4487	4767	5146	5334	5540	5745	5953	6159
Zone 2	3011	3304	3568	3730	3957	4197	4417	4644	4934	5326	5521	5734	5946	6161	6375
Zone 3	3113	3415	3688	3856	4091	4339	4567	4801	5101	5506	5707	5928	6147	6370	6590

4302

Traditional tufted loveseat



	Overall		Seat									St. Ydg.	Cu. Ft.	Shp. Wt.	Fr. Cls.
	61" W x 36" D x 28" H		44.5" W x 23.5" D x 18" H									9	58	144	250
	1	2/COM	3/COL	4	5	6	7	8	9	10	11	12/L	13	14	15/LL
Zone 1	3891	4280	4627	4830	5134	5249	5589	6036	6412	6780	6964	7249	7534	7822	8106
Zone 2	4027	4430	4789	4999	5314	5433	5785	6247	6636	7017	7208	7503	7798	8096	8390
Zone 3	4163	4580	4951	5168	5493	5616	5980	6459	6861	7255	7451	7756	8061	8370	8673

4303

Traditional tufted sofa

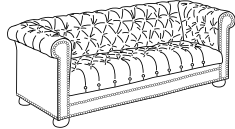

	Overall		Seat									St. Ydg.	Cu. Ft.	Shp. Wt.	Fr. Cls.
	78" W x 36" D x 28" H		64" W x 23.5" D x 18" H									11	71	180	250
	1	2/COM	3/COL	4	5	6	7	8	9	10	11	12/L	13	14	15/LL
Zone 1	4856	5342	5778	6019	6394	6537	7139	7803	8858	9642	9776	9868	10009	10358	10532
Zone 2	5026	5529	5980	6230	6618	6766	7389	8076	9168	9979	10118	10213	10359	10721	10901
Zone 3	5196	5716	6182	6440	6842	6995	7639	8349	9478	10317	10460	10559	10710	11083	11269



Claudia

LOUNGE SEATING - SIN 33721

Dramatic Curves

We believe that a seat can, and should, combine both form and function. For Claudia, we put special emphasis on the form. Take a seat and your arms will naturally fall into the gently undulating contour of the fully upholstered arms. Brightly polished aluminum legs add just the right amount of sparkle and visual interest. The cushions are plush and supportive so that waiting goes from a "chore" to a "pleasure." Round and oval table selections make for a complete collection.

Product Details

- Arms are custom fabricated and wrapped with foam and fiber for comfort
- High density foam adds comfort
- Stitching between seat/back cushions when required by fabric application
- Fully upholstered with double-needle trim on seat, back and arms to reinforce sewing
- Commercial-grade engineered hardwood frame
- Frame components with reinforcing corner blocks are glued and stapled

- Metal-to-metal connection of arms, seat and back ensures long-term durability
- Angled satin finish chrome legs with stationary feet
- Two-color combinations available
- Adjustable glides
- Hybrid soy-based, CFC-free foam

How to Specify:

- 1 Model number
- 2 Wood finish
- 3 Fabric grade & name for seat & back
- 4 Fabric grade & name for arms (if different)

Wood Finishes	Code
Black	BLK
Boardwalk	BW
Driftwood	DW
Espresso	ESP
Mahogany	MAH
Moab	MOB
Monticello Maple	MM
Natural Maple	FM
Shoreline	SL
Windsor Cherry	WC

Finished Example

5321/SL/5 Stinson Retrograde Electric/3 Stinson Staple Smith

HPFi

180 Claudia - Lounge Seating

	Overall		Seat										St. Ydg.	Cu. Ft.	Shp. Wt.	Fr. Cls.
	33.5" W x 31" D x 32.5" H		21" W x 21" D x 19" H										5.75	31	114	250
	1	2/COM	3/COL	4	5	6	7	8	9	10	11	12/L	13	14	15/LL	
5301 Club chair	Zone 1	1867	2000	2134	2337	2486	2682	2761	3078	3276	3527	3642	3809	4008	4141	4324
	Zone 2	1932	2070	2209	2419	2573	2776	2858	3186	3391	3650	3769	3942	4148	4286	4475
	Zone 3	1998	2140	2283	2501	2660	2870	2954	3293	3505	3774	3897	4076	4289	4431	4627

	Overall		Seat										St. Ydg.	Cu. Ft.	Shp. Wt.	Fr. Cls.
	56.5" W x 31" D x 32.5" H		43.5" W x 21" D x 19" H										8	57	150	250
	1	2/COM	3/COL	4	5	6	7	8	9	10	11	12/L	13	14	15/LL	
5302 Loveseat	Zone 1	2669	2834	3003	3221	3477	3732	4073	4278	4477	4752	4862	4951	5139	5371	5648
	Zone 2	2762	2933	3108	3334	3599	3863	4216	4428	4634	4918	5032	5124	5319	5559	5846
	Zone 3	2856	3032	3213	3446	3720	3993	4358	4577	4790	5085	5202	5298	5499	5747	6043

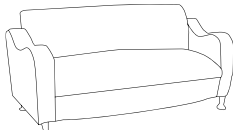
	Overall		Seat										St. Ydg.	Cu. Ft.	Shp. Wt.	Fr. Cls.
	78.5" W x 31" D x 32.5" H		65.5" W x 21" D x 19" H										10	75	184	250
	1	2/COM	3/COL	4	5	6	7	8	9	10	11	12/L	13	14	15/LL	
5303 Sofa	Zone 1	3739	3939	4140	4511	4866	5224	5407	5958	6173	6357	6426	6481	6827	7115	7425
	Zone 2	3870	4077	4285	4669	5036	5407	5596	6167	6389	6579	6651	6708	7066	7364	7685
	Zone 3	4001	4215	4430	4827	5207	5590	5785	6375	6605	6802	6876	6935	7305	7613	7945

	Overall		Seat										St. Ydg.	Cu. Ft.	Shp. Wt.	Fr. Cls.
	42.5" W x 21.5" D x 19.25" H												4.5	26	64	250
	1	2/COM	3/COL	4	5	6	7	8	9	10	11	12/L	13	14	15/LL	
5321 Oval table; Upholstered sides; Floating laminate top	Zone 1	1766	1862	1973	2064	2160	2285	2409	2538	2663	2821	3000	3117	3286	3442	3599
	Zone 2	1828	1927	2042	2136	2236	2365	2493	2627	2756	2920	3105	3226	3401	3562	3725
NOW	Zone 3	1890	1992	2111	2208	2311	2445	2578	2716	2849	3018	3210	3335	3516	3683	3851

	Overall		Seat										St. Ydg.	Cu. Ft.	Shp. Wt.	Fr. Cls.
	42.5" W x 21.5" D x 17.25" H												4.5	26	63	250
	1	2/COM	3/COL	4	5	6	7	8	9	10	11	12/L	13	14	15/LL	
5322 Oval table; Upholstered sides; Laminate top	Zone 1	1726	1817	1928	2024	2118	2242	2369	2493	2620	2777	2958	3077	3245	3400	3556
	Zone 2	1786	1881	1995	2095	2192	2320	2452	2580	2712	2874	3062	3185	3359	3519	3680
NOW	Zone 3	1847	1944	2063	2166	2266	2399	2535	2668	2803	2971	3165	3292	3472	3638	3805

	Overall		Seat										St. Ydg.	Cu. Ft.	Shp. Wt.	Fr. Cls.
	42.5" W x 21.5" D x 16.25" H												4.5	26	63	250
	1	2/COM	3/COL	4	5	6	7	8	9	10	11	12/L	13	14	15/LL	
5326 Oval table; Fully upholstered	Zone 1	1471	1566	1675	1770	1866	1991	2117	2242	2369	2525	2706	2824	2992	3147	3395
	Zone 2	1522	1621	1734	1832	1931	2061	2191	2320	2452	2613	2801	2923	3097	3257	3514
NOW	Zone 3	1574	1676	1792	1894	1997	2130	2265	2399	2535	2702	2895	3022	3201	3367	3633

	Overall		Seat										St. Ydg.	Cu. Ft.	Shp. Wt.	Fr. Cls.
	36" W x 36" D x 22" H												4.5	41.5	135	250
	1	2/COM	3/COL	4	5	6	7	8	9	10	11	12/L	13	14	15/LL	
5336 36" round table; Upholstered sides; Laminate top	Zone 1	2118	2205	2304	2391	2478	2592	2706	2822	2937	3078	3205	3352	3506	3637	3843
	Zone 2	2192	2282	2385	2475	2565	2683	2801	2921	3040	3186	3317	3469	3629	3764	3978
NOW	Zone 3	2266	2359	2465	2558	2651	2773	2895	3020	3143	3293	3429	3587	3751	3892	4112



Eve

LOUNGE SEATING - SIN 33721

Creative Public Spaces

The sleek lines of the Eve Collection take shape from the desire to provide a contemporary solution to reception areas, waiting rooms, open plan team areas, lobbies and training rooms. Combining metal, wood and upholstered elements, Eve delivers form and aesthetic relevance. Linear chairs, loveseats and sofas and one-, two- and three-person benches are also included. Large, open public spaces offer the opportunity for various work styles to coexist. Eve curved banquettes promote private conversations or necessary solitude within any gathering space.

Product Details

- Seat and back suspension features heavy-duty Sytex stretch-webbing
- Hardwood frames with reinforcing corner blocks are glued and stapled
- Arms are custom fabricated and wrapped with foam and fiber for comfort
- Metal-to-metal connection of arms, seat and back ensures long-term durability
- Fully upholstered with double-needle trim on seat, back and arms to reinforce sewing
- Brushed aluminum cylinder legs with adjustable glides

- Silver powder-coated steel rail/runner legs available on select models
- Two-color combinations available
- Adjustable glides
- Hybrid soy-based, CFC-free foam
- Finished wood legs available in place of metal legs
- All listed product options must be factory installed

How to Specify:

- 1 Model number
- 2 Fabric grade & name for seat & back
- 3 Fabric grade & name for arms (if different)
- 4 Options
- 5 Option finish(s)

Finished Example

5801/9 Stinson Revolution Cobalt/3 Stinson Staple Camel/MM

Options	Code	Price
Wood leg	Finish	N/C
Rail/runner leg (replaces 4 legs)	RL	334
Rail/runner leg (replaces 6 legs)	RL	498
Tablet Arm Left/Tablet	TAL	721
Tablet Arm Right/Tablet	TAR	721

Finishes	Code
Black	BLK
Boardwalk	BW
Driftwood	DW
Espresso	ESP
Mahogany	MAH
Moab	MOB
Monticello Maple	MM
Natural Maple	FM
Shoreline	SL
Windsor Cherry	WC

	Overall		Seat										St. Ydg.	Cu. Ft.	Shp. Wt.	Fr. Cls.
5800	37.5" W x 31" D x 34" H		30" W x 20" D x 19.5" H										5.5	19.1	82	175
	1	2/COM	3/COL	4	5	6	7	8	9	10	11	12/L	13	14	15/LL	
Zone 1	2622	2709	2839	2925	3011	3141	3271	3400	3516	3674	3818	3991	4164	4308	4481	
Zone 2	2714	2804	2938	3027	3116	3251	3385	3519	3639	3803	3952	4131	4310	4459	4638	
Zone 3	2806	2899	3038	3130	3222	3361	3500	3638	3762	3931	4085	4270	4455	4610	4795	

Oversized Chair with Arms

NOW



	Overall		Seat										St. Ydg.	Cu. Ft.	Shp. Wt.	Fr. Cls.
5801	30" W x 31" D x 34" H		22.5" W x 20" D x 19.5" H										4.5	19.1	82	175
	1	2/COM	3/COL	4	5	6	7	8	9	10	11	12/L	13	14	15/LL	
Zone 1	2303	2368	2393	2490	2579	2668	2785	2899	3015	3130	3167	3201	3227	3251	3275	
Zone 2	2384	2451	2477	2577	2669	2761	2882	3000	3121	3240	3278	3313	3340	3365	3390	
Zone 3	2464	2534	2561	2664	2760	2855	2980	3102	3226	3349	3389	3425	3453	3479	3504	

Club Chair with Arms

NOW



	Overall		Seat										St. Ydg.	Cu. Ft.	Shp. Wt.	Fr. Cls.
5802	53" W x 31" D x 34" H		45" W x 20" D x 19.5" H										6.25	56	125	250
	1	2/COM	3/COL	4	5	6	7	8	9	10	11	12/L	13	14	15/LL	
Zone 1	2943	3070	3116	3219	3347	3475	3645	3818	3988	4161	4199	4215	4279	4328	4371	
Zone 2	3046	3177	3225	3332	3464	3597	3773	3952	4128	4307	4346	4363	4429	4479	4524	
Zone 3	3149	3285	3334	3444	3581	3718	3900	4085	4267	4452	4493	4510	4579	4631	4677	

Loveseat with Arms

NOW

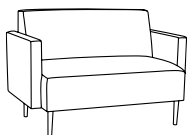

	Overall		Seat										St. Ydg.	Cu. Ft.	Shp. Wt.	Fr. Cls.
5803	73.5" W x 31" D x 34" H		66" W x 20" D x 19.5" H										8	76	149	250
	1	2/COM	3/COL	4	5	6	7	8	9	10	11	12/L	13	14	15/LL	
Zone 1	3552	3743	3816	3908	4071	4237	4456	4890	5107	5382	5419	5463	5597	5756	5902	
Zone 2	3676	3874	3950	4045	4213	4385	4612	5061	5286	5570	5609	5654	5793	5957	6109	
Zone 3	3801	4005	4083	4182	4356	4534	4768	5232	5464	5759	5798	5845	5989	6159	6315	

Sofa with Arms

NOW

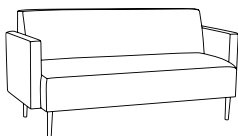

	Overall		Seat										St. Ydg.	Cu. Ft.	Shp. Wt.	Fr. Cls.
5804	22.5" W x 31" D x 34" H		22.5" W x 20" D x 19.5" H										3	31	57	250
	1	2/COM	3/COL	4	5	6	7	8	9	10	11	12/L	13	14	15/LL	
Zone 1	2034	2097	2123	2168	2228	2291	2372	2454	2536	2618	2724	2829	3001	3080	3278	
Zone 2	2105	2170	2197	2244	2306	2371	2455	2540	2625	2710	2819	2928	3106	3188	3393	
Zone 3	2176	2244	2272	2320	2384	2451	2538	2626	2714	2801	2915	3027	3211	3296	3507	

Armless Club Chair

NOW



Eve

5805

Armless Loveseat

NOW



	Overall			Seat								St. Ydg.	Cu. Ft.	Shp. Wt.	Fr. Cls.
	45.5" W x 31" D x 34" H			45" W x 20" D x 19.5" H								4.75	57	105	250
	1	2/COM	3/COL	4	5	6	7	8	9	10	11	12/L	13	14	15/LL
Zone 1	2674	2802	2849	2885	2981	3078	3210	3338	3467	3600	3623	3654	3690	3727	3760
Zone 2	2768	2900	2949	2986	3085	3186	3322	3455	3588	3726	3750	3782	3819	3857	3892
Zone 3	2861	2998	3048	3087	3190	3293	3435	3572	3710	3852	3877	3910	3948	3988	4023

5806

Armless sofa

NOW



	Overall			Seat								St. Ydg.	Cu. Ft.	Shp. Wt.	Fr. Cls.
	67" W x 31" D x 34" H			66" W x 20" D x 19.5" H								7.25	75	128	250
	1	2/COM	3/COL	4	5	6	7	8	9	10	11	12/L	13	14	15/LL
Zone 1	3286	3470	3546	3607	3756	3902	4099	4301	4498	4696	5419	5463	5597	5756	5902
Zone 2	3401	3591	3670	3733	3887	4039	4242	4452	4655	4860	5609	5654	5793	5957	6109
Zone 3	3516	3713	3794	3859	4019	4175	4386	4602	4813	5025	5798	5845	5989	6159	6315

5807

Armless club chair;
Return swivel base

NOW

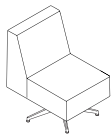

	Overall			Seat								St. Ydg.	Cu. Ft.	Shp. Wt.	Fr. Cls.
	22.5" W x 31" D x 34" H			22.5" W x 20" D x 19.5" H								3	30.5	89	250
	1	2/COM	3/COL	4	5	6	7	8	9	10	11	12/L	13	14	15/LL
Zone 1	1904	1959	2027	2084	2139	2214	2290	2365	2438	2534	2573	2656	2753	2831	3016
Zone 2	1971	2028	2098	2157	2214	2291	2370	2448	2523	2623	2663	2749	2849	2930	3122
Zone 3	2037	2096	2169	2230	2289	2369	2450	2531	2609	2711	2753	2842	2946	3029	3227

Option	Code	Price
Casters	C	66

5809

Club chair with arms;
Return swivel base

NOW

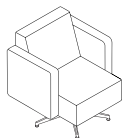

	Overall			Seat								St. Ydg.	Cu. Ft.	Shp. Wt.	Fr. Cls.
	30" W x 31" D x 34" H			22.5" W x 20" D x 19.5" H								4.25	30.5	98	250
	1	2/COM	3/COL	4	5	6	7	8	9	10	11	12/L	13	14	15/LL
Zone 1	2410	2491	2585	2665	2744	2850	2957	3064	3170	3305	3422	3558	3615	3726	3997
Zone 2	2494	2578	2675	2758	2840	2950	3060	3171	3281	3421	3542	3683	3742	3856	4137
Zone 3	2579	2665	2766	2852	2936	3050	3164	3278	3392	3536	3662	3807	3868	3987	4277

Option	Code	Price
Casters	C	66

5820

Technology arm with flared
laminated top

NOW

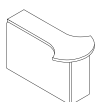

	Overall			Seat								St. Ydg.	Cu. Ft.	Shp. Wt.	Fr. Cls.
	18" W x 34.5" D x 28.5" H											2.5	14.7	51	250
	1	2/COM	3/COL	4	5	6	7	8	9	10	11	12/L	13	14	15/LL
Zone 1	1485	1538	1601	1647	1694	1766	1827	1897	1961	2039	2142	2194	2259	2338	2480
Zone 2	1537	1592	1657	1705	1753	1828	1891	1963	2030	2110	2217	2271	2338	2420	2567
Zone 3	1589	1646	1713	1762	1813	1890	1955	2030	2098	2182	2292	2348	2417	2502	2654

5821

Oval table; Upholstered sides;
Floating laminate top

NOW

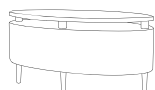

Overall	St. Ydg.	Cu. Ft.	Shp. Wt.	Fr. Cls.
42.5" W x 21.5" D x 20.5" H	1.75	17	71	175

	1	2/COM	3/COL	4	5	6	7	8	9	10	11	12/L	13	14	15/LL
Zone 1	1979	2012	2052	2087	2120	2167	2211	2257	2302	2361	2419	2468	2520	2575	2722
Zone 2	2048	2082	2124	2160	2194	2243	2288	2336	2383	2444	2504	2554	2608	2665	2817
Zone 3	2118	2153	2196	2233	2268	2319	2366	2415	2463	2526	2588	2641	2696	2755	2913

5822

Oval table; Upholstered sides;
Laminate top

NOW

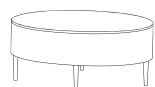

Overall	St. Ydg.	Cu. Ft.	Shp. Wt.	Fr. Cls.
42.5" W x 21.5" D x 20.5" H	1.75	17	63	250

	1	2/COM	3/COL	4	5	6	7	8	9	10	11	12/L	13	14	15/LL
Zone 1	1931	1966	2006	2039	2072	2120	2166	2211	2256	2314	2371	2421	2473	2529	2584
Zone 2	1999	2035	2076	2110	2145	2194	2242	2288	2335	2395	2454	2506	2560	2618	2674
Zone 3	2066	2104	2146	2182	2217	2268	2318	2366	2414	2476	2537	2590	2646	2706	2765

5823

Connecting/freestanding table;
Laminate top

NOW



Overall	St. Ydg.	Cu. Ft.	Shp. Wt.	Fr. Cls.
23" W x 27" D x 16" H	1	9	34	175

	1	2/COM	3/COL	4	5	6	7	8	9	10	11	12/L	13	14	15/LL
Zone 1	1532	1593	1619	1632	1658	1700	1741	1783	1825	1874	1897	1936	1967	2000	2118
Zone 2	1586	1649	1676	1689	1716	1760	1802	1845	1889	1940	1963	2004	2036	2070	2192
Zone 3	1639	1705	1732	1746	1774	1819	1863	1908	1953	2005	2030	2072	2105	2140	2266

Option	Code	Price
Dry Erase Top	DE	334

5825

Mobile armless teaming chair

NOW

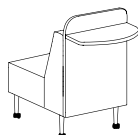

Overall	Seat	St. Ydg.	Cu. Ft.	Shp. Wt.	Fr. Cls.
22.5" W x 33-44" D x 38.5" H	22.5" W x 20.5" D x 19.5" H	3	49.7	96	250

	1	2/COM	3/COL	4	5	6	7	8	9	10	11	12/L	13	14	15/LL
Zone 1	3169	3233	3308	3366	3422	3505	3582	3667	3742	3835	3923	4018	4098	4193	4312
Zone 2	3280	3346	3424	3484	3542	3628	3707	3795	3873	3969	4060	4159	4241	4340	4463
Zone 3	3391	3459	3540	3602	3662	3750	3833	3924	4004	4103	4198	4299	4385	4487	4614

• Laminate back panel and fold down shelf

5826

Oval table; Fully upholstered

NOW



Overall	St. Ydg.	Cu. Ft.	Shp. Wt.	Fr. Cls.
42.5" W x 21.5" D x 19.5" H	1.75	17	47	250

	1	2/COM	3/COL	4	5	6	7	8	9	10	11	12/L	13	14	15/LL
Zone 1	1741	1774	1815	1850	1884	1928	1975	2021	2065	2123	2144	2181	2237	2283	2390
Zone 2	1802	1836	1879	1915	1950	1995	2044	2092	2137	2197	2219	2257	2315	2363	2474
Zone 3	1863	1898	1942	1980	2016	2063	2113	2162	2210	2272	2294	2334	2394	2443	2557

Eve

5827

Mobile Teaming chair

NOW



Overall	Seat		St. Ydg.	Cu. Ft.	Shp. Wt.	Fr. Cls.
24.5" W x 31" D x 34" H	22.5" W x 20" D x 19.5" H		3.25	19.1	58	250

	1	2/COM	3/COL	4	5	6	7	8	9	10	11	12/L	13	14	15/LL
Zone 1	2761	2823	2849	2885	2926	3003	3079	3185	3286	3356	3358	3579	3681	3767	3859
Zone 2	2858	2922	2949	2986	3028	3108	3187	3296	3401	3473	3476	3704	3810	3899	3994
Zone 3	2954	3021	3048	3087	3131	3213	3295	3408	3516	3591	3593	3830	3939	4031	4129

- Metal arm and wood tablet
- Tablet is standard on left side (facing the chair), but available on the right side
- Integrated aluminum pull is standard on back for ease of transport

5827UA

Mobile Teaming chair

NOW



Overall	Seat		St. Ydg.	Cu. Ft.	Shp. Wt.	Fr. Cls.
30" W x 31" D x 34" H	22.5" W x 20" D x 19.5" H		5	28	70	250

	1	2/COM	3/COL	4	5	6	7	8	9	10	11	12/L	13	14	15/LL
Zone 1	2761	2823	2849	2885	2926	3003	3079	3185	3286	3356	3358	3579	3681	3767	3859
Zone 2	2858	2922	2949	2986	3028	3108	3187	3296	3401	3473	3476	3704	3810	3899	3994
Zone 3	2954	3021	3048	3087	3131	3213	3295	3408	3516	3591	3593	3830	3939	4031	4129

- Upholstered arms and wood tablet
- Tablet is standard on left side (facing the chair), but available on the right side
- Integrated aluminum pull is standard on back for ease of transport

5829

Armless 30" Seat

NOW



Overall	Seat		St. Ydg.	Cu. Ft.	Shp. Wt.	Fr. Cls.
30.5" W x 31" D x 34" H	30" W x 20" D x 19.5" H		4	45	65	250

	1	2/COM	3/COL	4	5	6	7	8	9	10	11	12/L	13	14	15/LL
Zone 1	2354	2417	2511	2575	2637	2732	2826	2920	3004	3119	3223	3350	3475	3580	3706
Zone 2	2436	2502	2599	2665	2729	2828	2925	3022	3109	3228	3336	3467	3597	3705	3836
Zone 3	2519	2586	2687	2755	2822	2923	3024	3124	3214	3337	3449	3585	3718	3831	3965

5830

30 degree bench

NOW

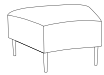

Overall	Seat		St. Ydg.	Cu. Ft.	Shp. Wt.	Fr. Cls.
37.5" W x 29.5" D x 19.5" H	22.5-36.5" W x 27.5" D x 19.5" H		2.75	31	57	175

	1	2/COM	3/COL	4	5	6	7	8	9	10	11	12/L	13	14	15/LL
Zone 1	1995	2124	2170	2204	2229	2306	2379	2456	2531	2626	2600	2685	2774	2846	2934
Zone 2	2065	2198	2246	2281	2307	2387	2462	2542	2620	2718	2691	2779	2871	2946	3037
Zone 3	2135	2273	2322	2358	2385	2467	2546	2628	2708	2810	2782	2873	2968	3045	3139

5830OS-IF

30 degree bench (nests on back of 5865-IF)

NOW



Overall	Seat		St. Ydg.	Cu. Ft.	Shp. Wt.	Fr. Cls.
53.5" W x 31.5" D x 19.5" H	37.5-53.5" W x 27.5" D x 19.5" H		5	68	210	175

	1	2/COM	3/COL	4	5	6	7	8	9	10	11	12/L	13	14	15/LL
Zone 1	2064	2142	2260	2338	2417	2536	2653	2771	2876	3020	3150	3307	3465	3596	3752
Zone 2	2136	2217	2339	2420	2502	2625	2746	2868	2977	3126	3260	3423	3586	3722	3883
Zone 3	2208	2292	2418	2502	2586	2714	2839	2965	3077	3231	3371	3538	3708	3848	4015

5831

One-seat bench

NOW

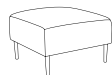

	Overall			Seat								St. Ydg.	Cu. Ft.	Shp. Wt.	Fr. Cls.
	22.5" W x 28.5" D x 19.5" H			22.5" W x 28" D x 19.5" H								1.75	16	30	250
	1	2/COM	3/COL	4	5	6	7	8	9	10	11	12/L	13	14	15/LL
Zone 1	1843	1907	1931	1955	1992	2041	2089	2137	2184	2244	2282	2332	2350	2383	2432
Zone 2	1908	1974	1999	2023	2062	2112	2162	2212	2260	2323	2362	2414	2432	2466	2517
Zone 3	1972	2040	2066	2092	2131	2184	2235	2287	2337	2401	2442	2495	2515	2550	2602

5832

Two-seat bench

NOW

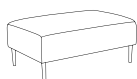

	Overall			Seat								St. Ydg.	Cu. Ft.	Shp. Wt.	Fr. Cls.
	45.5" W x 28.5" D x 19.5" H			45" W x 28" D x 19.5" H								2.75	58	70	250
	1	2/COM	3/COL	4	5	6	7	8	9	10	11	12/L	13	14	15/LL
Zone 1	2434	2560	2609	2669	2744	2820	2895	2968	3064	3241	3284	3372	3414	3461	3664
Zone 2	2519	2650	2700	2762	2840	2919	2996	3072	3171	3354	3399	3490	3533	3582	3792
Zone 3	2604	2739	2792	2856	2936	3017	3098	3176	3278	3468	3514	3608	3653	3703	3920

5833

Three-seat bench

NOW



	Overall			Seat								St. Ydg.	Cu. Ft.	Shp. Wt.	Fr. Cls.
	67" W x 28.5" D x 19.5" H			66" W x 28" D x 19.5" H								4	75	102	250
	1	2/COM	3/COL	4	5	6	7	8	9	10	11	12/L	13	14	15/LL
Zone 1	2998	3186	3260	3289	3361	3451	3538	3629	3741	3951	4003	4033	4130	4235	4362
Zone 2	3103	3298	3374	3404	3479	3572	3662	3756	3872	4089	4143	4174	4275	4383	4515
Zone 3	3208	3409	3488	3519	3596	3693	3786	3883	4003	4228	4283	4315	4419	4531	4667

5835-IF

30 degree chair; Inside facing

NOW



	Overall			Seat								St. Ydg.	Cu. Ft.	Shp. Wt.	Fr. Cls.
	39" W x 33" D x 34" H			23-32.5" W x 20" D x 19.5" H								4.25	19.1	79	175
	1	2/COM	3/COL	4	5	6	7	8	9	10	11	12/L	13	14	15/LL
Zone 1	2202	2264	2290	2328	2402	2478	2565	2622	2681	2796	2913	3029	3082	3135	3176
Zone 2	2279	2343	2370	2409	2486	2565	2655	2714	2775	2894	3015	3135	3190	3245	3287
Zone 3	2356	2422	2450	2491	2570	2651	2745	2806	2869	2992	3117	3241	3298	3354	3398

5835-OF

30 degree chair; Outside facing

NOW



	Overall			Seat								St. Ydg.	Cu. Ft.	Shp. Wt.	Fr. Cls.
	37.5" W x 33" D x 34" H			32.5-37.5" W x 20" D x 19.5" H								4	31	67	250
	1	2/COM	3/COL	4	5	6	7	8	9	10	11	12/L	13	14	15/LL
Zone 1	2202	2264	2290	2328	2402	2478	2565	2622	2681	2796	2913	3029	3082	3135	3176
Zone 2	2279	2343	2370	2409	2486	2565	2655	2714	2775	2894	3015	3135	3190	3245	3287
Zone 3	2356	2422	2450	2491	2570	2651	2745	2806	2869	2992	3117	3241	3298	3354	3398

Eve

5836

30 degree curved, wedge table;
Laminate top

NOW



Overall	St. Ydg.	Cu. Ft.	Shp. Wt.	Fr. Cls.
37.5" W x 29.5" D x 16" H	1.5	18	72	175

	1	2/COM	3/COL	4	5	6	7	8	9	10	11	12/L	13	14	15/LL
Zone 1	1576	1638	1662	1681	1700	1744	1786	1827	1867	1916	1954	2001	2041	2088	2159
Zone 2	1631	1695	1720	1740	1760	1805	1849	1891	1932	1983	2022	2071	2112	2161	2235
Zone 3	1686	1753	1778	1799	1819	1866	1911	1955	1998	2050	2091	2141	2184	2234	2310

Option	Code	Price
Dry Erase Top	DE	445

5837

36" round table; Upholstered
sides; Laminate top

NOW



Overall	St. Ydg.	Cu. Ft.	Shp. Wt.	Fr. Cls.
36" W x 36" D x 25.5" H	3.5	42	130	250

	1	2/COM	3/COL	4	5	6	7	8	9	10	11	12/L	13	14	15/LL
Zone 1	2371	2435	2512	2576	2642	2728	2813	2899	2984	3093	3204	3299	3362	3453	3638
Zone 2	2454	2520	2600	2666	2734	2823	2911	3000	3088	3201	3316	3414	3480	3574	3765
Zone 3	2537	2605	2688	2756	2827	2919	3010	3102	3193	3310	3428	3530	3597	3695	3893

Option	Code	Price
Dry Erase Top	DE	583

5839

One and One-Half Seat Bench

NOW



Overall	Seat	St. Ydg.	Cu. Ft.	Shp. Wt.	Fr. Cls.
30.5" W x 28" D x 19.5" H	30" W x 28" D x 19.5" H	2.5	40	40	250

	1	2/COM	3/COL	4	5	6	7	8	9	10	11	12/L	13	14	15/LL
Zone 1	2139	2178	2237	2276	2315	2374	2434	2492	2545	2616	2682	2760	2839	2904	2983
Zone 2	2214	2254	2315	2356	2396	2457	2519	2579	2634	2708	2776	2857	2938	3006	3087
Zone 3	2289	2330	2394	2435	2477	2540	2604	2666	2723	2799	2870	2953	3038	3107	3192

5843

Armless sofa/bench;
2/3 back on right side

NOW

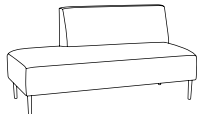

Overall	Seat	St. Ydg.	Cu. Ft.	Shp. Wt.	Fr. Cls.
67" W x 31" D x 34" H	66" W x 20-28" D x 19.5" H	6.5	74	132	250

	1	2/COM	3/COL	4	5	6	7	8	9	10	11	12/L	13	14	15/LL
Zone 1	3222	3369	3538	3678	3821	4012	4204	4395	4585	4824	5064	5235	5342	5548	5648
Zone 2	3335	3487	3662	3807	3955	4152	4351	4549	4745	4993	5241	5418	5529	5742	5846
Zone 3	3448	3605	3786	3935	4088	4293	4498	4703	4906	5162	5418	5601	5716	5936	6043

5844

Armless sofa/bench;
2/3 back on left side

NOW

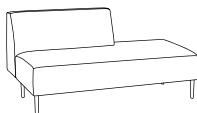

Overall	Seat	St. Ydg.	Cu. Ft.	Shp. Wt.	Fr. Cls.
67" W x 31" D x 34" H	66" W x 20-28" D x 19.5" H	6.5	74	132	250

	1	2/COM	3/COL	4	5	6	7	8	9	10	11	12/L	13	14	15/LL
Zone 1	3222	3369	3538	3678	3821	4012	4204	4395	4585	4824	5064	5235	5342	5548	5648
Zone 2	3335	3487	3662	3807	3955	4152	4351	4549	4745	4993	5241	5418	5529	5742	5846
Zone 3	3448	3605	3786	3935	4088	4293	4498	4703	4906	5162	5418	5601	5716	5936	6043

5848

Round table/ottoman; 18" diameter laminate target in center of top

NOW

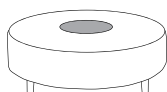

Overall	St. Ydg.	Cu. Ft.	Shp. Wt.	Fr. Cls.
48" W x 48" D x 19" H	3	48.5	153	250

	1	2/COM	3/COL	4	5	6	7	8	9	10	11	12/L	13	14	15/LL
Zone 1	2904	2960	3035	3090	3146	3228	3303	3385	3461	3552	3659	3755	3833	3929	4028
Zone 2	3006	3064	3141	3198	3256	3341	3419	3503	3582	3676	3787	3886	3967	4067	4169
Zone 3	3107	3167	3247	3306	3366	3454	3534	3622	3703	3801	3915	4018	4101	4204	4310

•18" diameter laminate top in center not available in MOB

Option	Code	Price
Dry Erase Top	DE	334
All Laminate Top	QT	827
Tufted Top	TF	387

5853

Armless lounge sofa; Opposing backs

NOW

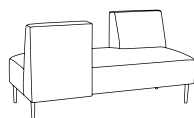

Overall	Seat	St. Ydg.	Cu. Ft.	Shp. Wt.	Fr. Cls.
67" W x 31" D x 34" H	66" W x 20-28" D x 19.5" H	7.25	74	132	250

	1	2/COM	3/COL	4	5	6	7	8	9	10	11	12/L	13	14	15/LL
Zone 1	3380	3533	3717	3864	4017	4223	4428	4631	4836	5094	5202	5433	5624	5854	6084
Zone 2	3498	3657	3847	3999	4158	4371	4583	4793	5005	5272	5384	5623	5821	6059	6297
Zone 3	3617	3780	3977	4134	4298	4519	4738	4955	5175	5451	5566	5813	6018	6264	6510

5860

60 degree bench

NOW

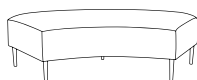

Overall	Seat	St. Ydg.	Cu. Ft.	Shp. Wt.	Fr. Cls.
71" W x 33" D x 19.5" H	44-70" W x 27.5" D x 19.5" H	3.75	76.7	101	250

	1	2/COM	3/COL	4	5	6	7	8	9	10	11	12/L	13	14	15/LL
Zone 1	2761	2946	3021	3052	3124	3216	3304	3392	3502	3715	3797	3823	3921	4041	4212
Zone 2	2858	3049	3127	3159	3233	3329	3420	3511	3625	3845	3930	3957	4058	4182	4359
Zone 3	2954	3152	3232	3266	3343	3441	3535	3629	3747	3975	4063	4091	4195	4324	4507

5865-IF

60 degree loveseat; Inside facing

NOW

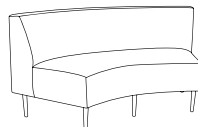

Overall	Seat	St. Ydg.	Cu. Ft.	Shp. Wt.	Fr. Cls.
74.5" W x 36.5" D x 34" H	44-63.5" W x 20" D x 19.5" H	7.75	74	149	250

	1	2/COM	3/COL	4	5	6	7	8	9	10	11	12/L	13	14	15/LL
Zone 1	3355	3483	3531	3607	3700	3858	4017	4229	4439	4654	4678	4865	4952	5058	5129
Zone 2	3472	3605	3655	3733	3830	3993	4158	4377	4594	4817	4842	5035	5125	5235	5309
Zone 3	3590	3727	3778	3859	3959	4128	4298	4525	4750	4980	5005	5206	5299	5412	5488

5865-OF

60 degree loveseat; Outside facing

NOW



Overall	Seat	St. Ydg.	Cu. Ft.	Shp. Wt.	Fr. Cls.
71" W x 36.5" D x 34" H	53-70" W x 20" D x 19.5" H	7	76	132	300

	1	2/COM	3/COL	4	5	6	7	8	9	10	11	12/L	13	14	15/LL
Zone 1	3355	3483	3531	3607	3700	3858	4017	4229	4439	4654	4678	4865	4952	5058	5129
Zone 2	3472	3605	3655	3733	3830	3993	4158	4377	4594	4817	4842	5035	5125	5235	5309
Zone 3	3590	3727	3778	3859	3959	4128	4298	4525	4750	4980	5005	5206	5299	5412	5488

Eve

5875

Armless loveseat banquette

NOW



Overall	Seat		St. Ydg.	Cu. Ft.	Shp. Wt.	Fr. Cls.
45.5" W x 31" D x 52.75" H	45" W x 20" D x 19.5" H		6	61	115	300

	1	2/COM	3/COL	4	5	6	7	8	9	10	11	12/L	13	14	15/LL
Zone 1	2969	3081	3233	3345	3460	3628	3778	3949	4098	4288	4476	4738	4826	5017	5371
Zone 2	3073	3189	3346	3462	3581	3755	3910	4087	4241	4438	4633	4904	4995	5193	5559
Zone 3	3177	3297	3459	3579	3702	3882	4042	4225	4385	4588	4789	5070	5164	5368	5747

5875R

Corner banquette with right-side facing back

NOW

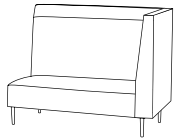

Overall	Seat		St. Ydg.	Cu. Ft.	Shp. Wt.	Fr. Cls.
47" W x 30.5" D x 52.75" H	37" W x 20" D x 19.5" H		9.25	53.6	115	300

	1	2/COM	3/COL	4	5	6	7	8	9	10	11	12/L	13	14	15/LL
Zone 1	3467	3525	3757	3930	4104	4366	4598	4858	5091	5382	5616	5844	6085	6331	7101
Zone 2	3588	3648	3888	4068	4248	4519	4759	5028	5269	5570	5813	6049	6298	6553	7350
Zone 3	3710	3772	4020	4205	4391	4672	4920	5198	5447	5759	6009	6253	6511	6774	7598

5875L

Corner banquette with left-side facing back

NOW

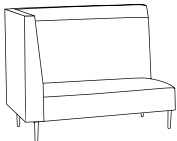

Overall	Seat		St. Ydg.	Cu. Ft.	Shp. Wt.	Fr. Cls.
47" W x 30.5" D x 52.75" H	37" W x 20" D x 19.5" H		9.25	53.6	115	300

	1	2/COM	3/COL	4	5	6	7	8	9	10	11	12/L	13	14	15/LL
Zone 1	3467	3525	3757	3930	4104	4366	4598	4858	5091	5382	5616	5844	6085	6331	7101
Zone 2	3588	3648	3888	4068	4248	4519	4759	5028	5269	5570	5813	6049	6298	6553	7350
Zone 3	3710	3772	4020	4205	4391	4672	4920	5198	5447	5759	6009	6253	6511	6774	7598

5875-IF

Inside facing 60 degree banquette loveseat

NOW

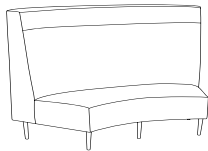

Overall	Seat		St. Ydg.	Cu. Ft.	Shp. Wt.	Fr. Cls.
74.5" W x 36.5" D x 52.75" H	44-63.5" W x 20" D x 19.5" H		9.75	86.1	163	300

	1	2/COM	3/COL	4	5	6	7	8	9	10	11	12/L	13	14	15/LL
Zone 1	4558	4765	5009	5192	5375	5650	5896	6171	6415	6720	7010	7169	7319	7577	8492
Zone 2	4718	4932	5184	5374	5563	5848	6102	6387	6640	6955	7255	7420	7575	7842	8789
Zone 3	4877	5099	5360	5555	5751	6046	6309	6603	6864	7190	7501	7671	7831	8107	9086

5875UAH

Loveseat banquette; Full-height arms

NOW

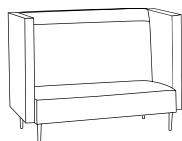

Overall	Seat		St. Ydg.	Cu. Ft.	Shp. Wt.	Fr. Cls.
53" W x 31" D x 52.75" H	45" W x 20" D x 19.5" H		10	60	135	300

	1	2/COM	3/COL	4	5	6	7	8	9	10	11	12/L	13	14	15/LL
Zone 1	3607	3795	4046	4234	4422	4709	4956	5239	5489	5804	6120	6440	6702	7020	7661
Zone 2	3733	3928	4188	4382	4577	4874	5129	5422	5681	6007	6334	6665	6937	7266	7929
Zone 3	3859	4061	4329	4530	4732	5039	5303	5606	5873	6210	6548	6891	7171	7511	8197

	Overall	Seat														St. Ydg.	Cu. Ft.	Shp. Wt.	Fr. Cls.	
5876	67" W x 31" D x 52.75" H	66" W x 20" D x 19.5" H														9.5	88	166	250	
		1	2/COM	3/COL	4	5	6	7	8	9	10	11	12/L	13	14	15/LL				
Zone 1		3566	3746	3986	4164	4343	4610	4850	5117	5355	5653	5955	6124	6256	6507	7414				
Zone 2		3691	3877	4126	4310	4495	4771	5020	5296	5542	5851	6163	6338	6475	6735	7673				
Zone 3		3816	4008	4265	4455	4647	4933	5190	5475	5730	6049	6372	6553	6694	6962	7933				

Armless sofa banquette

NOW

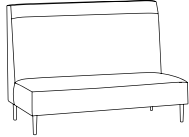

	Overall	Seat														St. Ydg.	Cu. Ft.	Shp. Wt.	Fr. Cls.	
5876UAH	73.5" W x 31" D x 52.75" H	66" W x 20" D x 19.5" H														13.5	94	175	300	
		1	2/COM	3/COL	4	5	6	7	8	9	10	11	12/L	13	14	15/LL				
Zone 1		4205	4459	4798	5051	5306	5687	6026	6407	6746	7169	7599	8143	8385	8814	9704				
Zone 2		4352	4615	4966	5228	5492	5886	6237	6631	6982	7420	7865	8428	8678	9122	10044				
Zone 3		4499	4771	5134	5405	5677	6085	6448	6855	7218	7671	8131	8713	8972	9431	10383				

Sofa banquette; Full-height arms

NOW

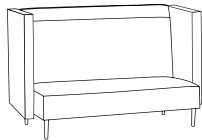

	Overall															St. Ydg.	Cu. Ft.	Shp. Wt.	Fr. Cls.
BS_	45" W x 10" D x 1" H															N/A	N/A	N/A	N/A
Zone 1		1079														• Not available in MOB			
Zone 2		1117																	
Zone 3		1155																	

1" thick laminate shelf;
Fits 5875 banquette

NOW

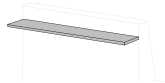

	Overall															St. Ydg.	Cu. Ft.	Shp. Wt.	Fr. Cls.
BS_	66" W x 10" D x 1" H															N/A	N/A	N/A	N/A
Zone 1		1145														• Not available in MOB			
Zone 2		1185																	
Zone 3		1225																	

1" thick laminate shelf;
Fits 5876 banquette

NOW

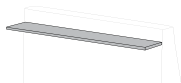

	Overall															St. Ydg.	Cu. Ft.	Shp. Wt.	Fr. Cls.
BS_	81.5" W x 10" D x 1" H															N/A	N/A	N/A	N/A
Zone 1		1239														• Not available in MOB			
Zone 2		1282																	
Zone 3		1326																	

1" thick curved laminate shelf;
Fits 5875-IF banquette

NOW

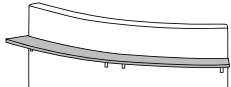

Eve

5890

90° corner bench

NOW

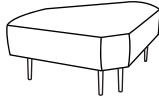

	Overall			Seat										St. Ydg.	Cu. Ft.	Shp. Wt.	Fr. Cls.
	51.5" W x 31.75" D x 34" H			9F-35B" W x 19.5" D x 19.5" H										4	36	61	250
	1	2/COM	3/COL	4	5	6	7	8	9	10	11	12/L	13	14	15/LL		
Zone 1	2547	2605	2672	2730	2788	2863	2942	3017	3094	3191	3245	3373	3552	3680	3785		
Zone 2	2636	2696	2766	2826	2886	2963	3045	3123	3202	3303	3359	3491	3676	3809	3917		
Zone 3	2725	2787	2859	2921	2983	3063	3148	3228	3311	3414	3472	3609	3801	3938	4050		

5895

90° corner seat

NOW

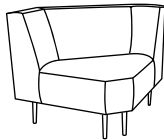

	Overall			Seat										St. Ydg.	Cu. Ft.	Shp. Wt.	Fr. Cls.
	51.5" W x 31.75" D x 34" H			9F-35B" W x 19.5" D x 19.5" H										7	57	109	300
	1	2/COM	3/COL	4	5	6	7	8	9	10	11	12/L	13	14	15/LL		
Zone 1	3638	3746	3876	3986	4095	4242	4388	4536	4681	4866	5013	5214	5398	5620	5808		
Zone 2	3765	3877	4012	4126	4238	4390	4542	4695	4845	5036	5188	5396	5587	5817	6011		
Zone 3	3893	4008	4147	4265	4382	4539	4695	4854	5009	5207	5364	5579	5776	6013	6215		

58B

Eve ganging bracket kit

NOW



	Overall													St. Ydg.	Cu. Ft.	Shp. Wt.	Fr. Cls.
	8" W x 3" D x 0.125" H													N/A	N/A	N/A	N/A
	1	2/COM	3/COL	4	5	6	7	8	9	10	11	12/L	13	14	15/LL		
Zone 1	60																
Zone 2	60																
Zone 3	60																

•Kit includes 2 brackets and hardware per connection

UA

Pair of upholstered arms

NOW

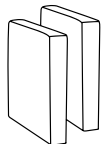

	Overall													St. Ydg.	Cu. Ft.	Shp. Wt.	Fr. Cls.
	3.75" W x 22" D x 19.5" H													3	N/A	10	70
	1	2/COM	3/COL	4	5	6	7	8	9	10	11	12/L	13	14	15/LL		
Zone 1	305	429	480	499	561	642	724	807	889	962	981	993	1058	1131	1180		
Zone 2	316	444	497	516	581	664	749	835	920	996	1015	1028	1095	1171	1221		
Zone 3	326	459	514	534	600	687	775	863	951	1029	1050	1063	1132	1210	1263		

Overall												St. Ydg.	Cu. Ft.	Shp. Wt.	Fr. Cls.
3.75" W x 22" D x 19.5" H												1.5	N/A	5	70
	1	2/COM	3/COL	4	5	6	7	8	9	10	11	12/L	13	14	15/LL
Zone 1	153	216	241	250	280	323	363	403	445	481	491	497	529	566	589
Zone 2	158	224	249	259	290	334	376	417	461	498	508	514	548	586	610
Zone 3	164	231	258	268	300	346	388	431	476	515	525	532	566	606	630

UAL

Upholstered arm;
Left-side facing

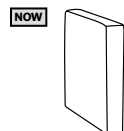

NOW

Overall												St. Ydg.	Cu. Ft.	Shp. Wt.	Fr. Cls.
3.75" W x 22" D x 19.5" H												1.5	N/A	5	70

UAR

Upholstered arm;
Right-side facing

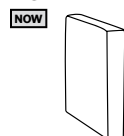

NOW

	1	2/COM	3/COL	4	5	6	7	8	9	10	11	12/L	13	14	15/LL
Zone 1	153	216	241	250	280	323	363	403	445	481	491	497	529	566	589
Zone 2	158	224	249	259	290	334	376	417	461	498	508	514	548	586	610
Zone 3	164	231	258	268	300	346	388	431	476	515	525	532	566	606	630

Overall				St. Ydg.	Cu. Ft.	Shp. Wt.	Fr. Cls.
2.25" W x 17" D x 1" H				N/A	N/A	8	70

TAL

Wood tablet arm;
Left-side facing

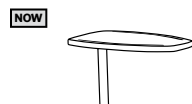

NOW

Zone 1	721
Zone 2	721
Zone 3	721

• Not available in MOB

• Must be factory installed

Overall				St. Ydg.	Cu. Ft.	Shp. Wt.	Fr. Cls.
2.25" W x 17" D x 1" H				N/A	N/A	8	70

TAR

Wood tablet arm;
Right-side facing



NOW

Zone 1	721
Zone 2	721
Zone 3	721

• Not available in MOB

• Must be factory installed



Eve Harbor

LOUNGE SEATING - SIN 33721

Creating Intimate Settings

The sleek lines of Eve Harbor provide a contemporary solution to collaborative work space, waiting areas and lobbies when more privacy is needed. The work environment begs for more enclosed areas that fall somewhere in between "open" or "closed" space and Eve Harbor is the response. Eve Harbor is available in two distinct privacy panel styles, K-shape and D-shape and three width options.

Product Details

- 2" thick upholstered back and end panels for privacy
- Seat and back suspension features heavy-duty Sytex stretch-webbing
- Hardwood frames with reinforcing corner blocks are glued and stapled
- Metal-to-metal connection of panels, seat and back ensures long-term durability
- Fully upholstered with double-needle trim on seat, back and arms to reinforce sewing
- Brushed aluminum cylinder legs with adjustable glides

- Finished wood legs available in place of metal legs
- Silver powder coated steel rail/runner leg option
- Two-color combinations available
- Adjustable glides
- Hybrid soy-based, CFC-free foam
- All listed product options must be factory installed

How to Specify:

- 1 Model number
- 2 Wood finish
- 3 Fabric grade & name for seat & back
- 4 Fabric grade & name for back and end panels (if different)
- 5 Options

Options	Code	Price
Wood leg	Finish	N/C
Rail / runner leg	RL	334

Leg Finishes	Code
Black	BLK
Boardwalk	BW
Driftwood	DW
Espresso	ESP
Mahogany	MAH
Moab	MOB
Monticello Maple	MM
Natural Maple	FM
Shoreline	SL
Windsor Cherry	WC

Finished Example

5817/FM/10 Stinson Power Grind Greystone/2 Culp Linette Steel/RL

5810

One and one-half seat chair, "K" privacy panels

NOW



	Overall		Seat										St. Ydg.	Cu. Ft.	Shp. Wt.	Fr. Cls.
	33" W x 33" D x 48" H		30" W x 20" D x 19.5" H										8.5	94	159	250
	1	2/COM	3/COL	4	5	6	7	8	9	10	11	12/L	13	14	15/LL	
Zone 1	3864	3997	4198	4331	4465	4665	4865	5066	5244	5489	5711	5978	6246	6468	6735	
Zone 2	3999	4137	4345	4483	4621	4828	5035	5243	5428	5681	5911	6187	6465	6694	6971	
Zone 3	4134	4277	4492	4634	4778	4992	5206	5421	5611	5873	6111	6396	6683	6921	7206	

5817

Club chair, "K" privacy panels

NOW



	Overall		Seat										St. Ydg.	Cu. Ft.	Shp. Wt.	Fr. Cls.
	25.5" W x 33" D x 48" H		22.5" W x 20" D x 19.5" H										7.25	93	138	250
	1	2/COM	3/COL	4	5	6	7	8	9	10	11	12/L	13	14	15/LL	
Zone 1	3225	3351	3538	3664	3791	3977	4166	4356	4522	4752	4962	5213	5464	5673	5924	
Zone 2	3338	3468	3662	3792	3924	4116	4312	4508	4680	4918	5136	5395	5655	5872	6131	
Zone 3	3451	3586	3786	3920	4056	4255	4458	4661	4839	5085	5309	5578	5846	6070	6339	

5818

Loveseat, "K" privacy panels

NOW



	Overall		Seat										St. Ydg.	Cu. Ft.	Shp. Wt.	Fr. Cls.
	48.5" W x 33" D x 48" H		45" W x 20" D x 19.5" H										9.5	94	179	250
	1	2/COM	3/COL	4	5	6	7	8	9	10	11	12/L	13	14	15/LL	
Zone 1	4135	4299	4546	4711	4875	5122	5370	5616	5836	6137	6411	6741	7070	7343	7672	
Zone 2	4280	4449	4705	4876	5046	5301	5558	5813	6040	6352	6635	6977	7317	7600	7941	
Zone 3	4424	4600	4864	5041	5216	5481	5746	6009	6245	6567	6860	7213	7565	7857	8209	

5819

Sofa, "K" privacy panels

NOW



	Overall		Seat										St. Ydg.	Cu. Ft.	Shp. Wt.	Fr. Cls.
	70" W x 33" D x 48" H		66" W x 20" D x 19.5" H										12.25	104	228	250
	1	2/COM	3/COL	4	5	6	7	8	9	10	11	12/L	13	14	15/LL	
Zone 1	4833	5046	5364	5575	5788	6107	6425	6743	7026	7415	7769	8193	8617	8972	9395	
Zone 2	5002	5223	5552	5770	5991	6321	6650	6979	7272	7675	8041	8480	8919	9286	9724	
Zone 3	5171	5399	5739	5965	6193	6534	6875	7215	7518	7934	8313	8767	9220	9600	10053	

Eve Harbor

5870

One and one-half seat chair,
"D" privacy panels

NOW



	Overall			Seat								St. Ydg.	Cu. Ft.	Shp. Wt.	Fr. Cls.
	33" W x 33" D x 48" H			30" W x 20" D x 19.5" H								8.5	94	159	250
	1	2/COM	3/COL	4	5	6	7	8	9	10	11	12/L	13	14	15/LL
Zone 1	3864	3997	4198	4331	4465	4665	4865	5066	5244	5489	5711	5978	6246	6468	6735
Zone 2	3999	4137	4345	4483	4621	4828	5035	5243	5428	5681	5911	6187	6465	6694	6971
Zone 3	4134	4277	4492	4634	4778	4992	5206	5421	5611	5873	6111	6396	6683	6921	7206

5877

Club chair, "D" privacy panels

NOW



	Overall			Seat								St. Ydg.	Cu. Ft.	Shp. Wt.	Fr. Cls.
	25.5" W x 33" D x 48" H			22.5" W x 20" D x 19.5" H								7.25	93	138	250
	1	2/COM	3/COL	4	5	6	7	8	9	10	11	12/L	13	14	15/LL
Zone 1	3225	3351	3538	3664	3791	3977	4166	4356	4522	4752	4962	5213	5464	5673	5924
Zone 2	3338	3468	3662	3792	3924	4116	4312	4508	4680	4918	5136	5395	5655	5872	6131
Zone 3	3451	3586	3786	3920	4056	4255	4458	4661	4839	5085	5309	5578	5846	6070	6339

5878

Loveseat, "D" privacy panels

NOW



	Overall		Seat										St. Ydg.	Cu. Ft.	Shp. Wt.	Fr. Cls.
	48.5" W x 33" D x 48" H		45" W x 20" D x 19.5" H										9.5	94	179	250
	1	2/COM	3/COL	4	5	6	7	8	9	10	11	12/L	13	14	15/LL	
Zone 1	4135	4299	4546	4711	4875	5122	5370	5616	5836	6137	6411	6741	7070	7343	7672	
Zone 2	4280	4449	4705	4876	5046	5301	5558	5813	6040	6352	6635	6977	7317	7600	7941	
Zone 3	4424	4600	4864	5041	5216	5481	5746	6009	6245	6567	6860	7213	7565	7857	8209	

5879

Sofa, "D" privacy panels

NOW



	Overall		Seat										St. Ydg.	Cu. Ft.	Shp. Wt.	Fr. Cls.
	70" W x 33" D x 48" H		66" W x 20" D x 19.5" H										12.25	106	228	250
	1	2/COM	3/COL	4	5	6	7	8	9	10	11	12/L	13	14	15/LL	
Zone 1	4833	5046	5364	5575	5788	6107	6425	6743	7026	7415	7769	8193	8617	8972	9395	
Zone 2	5002	5223	5552	5770	5991	6321	6650	6979	7272	7675	8041	8480	8919	9286	9724	
Zone 3	5171	5399	5739	5965	6193	6534	6875	7215	7518	7934	8313	8767	9220	9600	10053	



Eve Oasis

LOUNGE SEATING - SIN 33721

Creating Intimate Settings

Eve Oasis provides a fresh approach to collaborative settings. This contemporary solution transforms reception areas, waiting rooms, open plan team areas, lobbies and training rooms into a flexible array of intimate conversation areas. Or hideaway and take advantage of some much needed solitude.

Product Details

- 2" thick upholstered back panel for privacy
- Seat and back suspension features heavy-duty Sytex stretch-webbing
- Hardwood frames with reinforcing corner blocks are glued and stapled
- Metal-to-metal connection of arms, seat and back ensures long-term durability
- Fully upholstered with double-needle trim on seat, back and arms to reinforce sewing
- Brushed aluminum cylinder legs with adjustable glides

- Finished wood legs available in place of metal legs
- Silver powder coated steel rail/runner leg option
- Two-color combinations available
- Adjustable glides
- Hybrid soy-based, CFC-free foam
- All listed product options must be factory installed

How to Specify:

- 1 Model number
- 2 Wood finish (where applicable)
- 3 Fabric grade & name for seat, back & arms
- 4 Fabric grade & name for back panel (if different)
- 5 Options

Options	Code	Price
Wood leg	Finish	N/C
Rail / runner leg	RL	334
Tablet Arm Left	TAL	721
Tablet Arm Right	TAR	721

Leg Finishes	Code
Black	BLK
Boardwalk	BW
Driftwood	DW
Espresso	ESP
Mahogany	MAH
Moab	MOB
Monticello Maple	MM
Natural Maple	FM
Shoreline	SL
Windsor Cherry	WC

Finished Example

5811/FM/5 Stinson Jillian Fireball/3 Stinson Staple Taupe/RL

5811 Club chair

NOW



	Overall		Seat										St. Ydg.	Cu. Ft.	Shp. Wt.	Fr. Cls.
	30" W x 33" D x 48" H		22.5" W x 20" D x 19.5" H										7.25	55	115	250
	1	2/COM	3/COL	4	5	6	7	8	9	10	11	12/L	13	14	15/LL	
Zone 1	3194	3346	3526	3676	3829	4031	4234	4436	4639	4891	5017	5246	5438	5669	6264	
Zone 2	3306	3463	3649	3805	3963	4172	4382	4591	4801	5062	5193	5430	5628	5867	6483	
Zone 3	3418	3580	3773	3933	4097	4313	4530	4747	4964	5233	5368	5613	5819	6066	6702	

- Metal legs
- Fully upholstered seat, back, arms and back panel

5812 Loveseat

NOW



	Overall		Seat										St. Ydg.	Cu. Ft.	Shp. Wt.	Fr. Cls.
	53" W x 33" D x 48" H		45" W x 20" D x 19.5" H										9.5	106	198	250
	1	2/COM	3/COL	4	5	6	7	8	9	10	11	12/L	13	14	15/LL	
Zone 1	4096	4293	4526	4730	4927	5192	5456	5723	5987	6321	6484	6785	7036	7338	8121	
Zone 2	4239	4443	4684	4896	5099	5374	5647	5923	6197	6542	6711	7022	7282	7595	8405	
Zone 3	4383	4594	4843	5061	5272	5555	5838	6124	6406	6763	6938	7260	7529	7852	8689	

- Metal legs
- Fully upholstered seat, back, arms and back panel

5813 Sofa

NOW



	Overall		Seat										St. Ydg.	Cu. Ft.	Shp. Wt.	Fr. Cls.
	74" W x 33" D x 48" H		66" W x 20" D x 19.5" H										12.25	106	270	250
	1	2/COM	3/COL	4	5	6	7	8	9	10	11	12/L	13	14	15/LL	
Zone 1	4788	5046	5342	5600	5861	6201	6542	6887	7227	7656	7866	8256	8580	8969	9996	
Zone 2	4956	5223	5529	5796	6066	6418	6771	7128	7480	7924	8141	8545	8880	9283	10346	
Zone 3	5123	5399	5716	5992	6271	6635	7000	7369	7733	8192	8417	8834	9181	9597	10696	

- Metal legs
- Fully upholstered seat, back, arms and back panel

5814 Armless Club Chair

NOW



	Overall		Seat										St. Ydg.	Cu. Ft.	Shp. Wt.	Fr. Cls.
	22.5" W x 33" D x 48" H		22.5" W x 20" D x 19.5" H										5.5	55	93	300
	1	2/COM	3/COL	4	5	6	7	8	9	10	11	12/L	13	14	15/LL	
Zone 1	2475	2591	2726	2840	2956	3109	3263	3416	3568	3761	3969	4128	4353	4528	4800	
Zone 2	2562	2682	2821	2939	3059	3218	3377	3536	3693	3893	4108	4272	4505	4686	4968	
Zone 3	2648	2772	2917	3039	3163	3327	3491	3655	3818	4024	4247	4417	4658	4845	5136	

- Metal legs
- Fully upholstered seat, back, and back panel

Eve Oasis

5815

Armless Loveseat

NOW



	Overall			Seat									St. Ydg.	Cu. Ft.	Shp. Wt.	Fr. Cls.
	45.5" W x 33" D x 48" H			45" W x 20" D x 19.5" H									7.25	88	169	250
	1	2/COM	3/COL	4	5	6	7	8	9	10	11	12/L	13	14	15/LL	
Zone 1	3292	3444	3620	3774	3926	4129	4328	4536	4737	4989	5117	5347	5537	5767	6357	
Zone 2	3407	3565	3747	3906	4063	4274	4479	4695	4903	5164	5296	5534	5731	5969	6579	
Zone 3	3522	3685	3873	4038	4201	4418	4631	4854	5069	5338	5475	5721	5925	6171	6802	

• Metal legs

• Fully upholstered seat, back, and back panel

5816

Armless Sofa

NOW



	Overall			Seat									St. Ydg.	Cu. Ft.	Shp. Wt.	Fr. Cls.
	67" W x 33" D x 48" H			66" W x 20" D x 19.5" H									11	94	106	250
	1	2/COM	3/COL	4	5	6	7	8	9	10	11	12/L	13	14	15/LL	
Zone 1	4006	4237	4504	4736	4965	5275	5584	5893	6197	6582	6771	7120	7412	7760	8694	
Zone 2	4146	4385	4662	4902	5139	5460	5779	6099	6414	6812	7008	7369	7671	8032	8998	
Zone 3	4286	4534	4819	5068	5313	5644	5975	6306	6631	7043	7245	7618	7931	8303	9303	

• Metal legs

• Fully upholstered seat, back, and back panel

5850

One and one-half seat

NOW



	Overall			Seat										St. Ydg.	Cu. Ft.	Shp. Wt.	Fr. Cls.		
	38" W x 33" D x 48" H			30" W x 20" D x 19.5" H										8.5	106	157	250		
	1	2/COM	3/COL	4	5	6	7	8	9	10	11	12/L	13	14	15/LL				
Zone 1	3827	3960	4161	4294	4428	4628	4828	5029	5207	5452	5674	5941	6208	6431	6698				
Zone 2	3961	4099	4307	4444	4583	4790	4997	5205	5389	5643	5873	6149	6425	6656	6932				
Zone 3	4095	4237	4452	4595	4738	4952	5166	5381	5571	5834	6071	6357	6643	6881	7167				

• Metal legs

• Fully upholstered seat, back, and back panel

5880

Armless one and one-half seat

NOW



	Overall			Seat										St. Ydg.	Cu. Ft.	Shp. Wt.	Fr. Cls.		
	30.5" W x 33" D x 48" H			30" W x 20" D x 19.5" H										6.5	88	96	250		
	1	2/COM	3/COL	4	5	6	7	8	9	10	11	12/L	13	14	15/LL				
Zone 1	3028	3130	3283	3386	3487	3641	3794	3947	4083	4271	4440	4645	4850	5019	5224				
Zone 2	3134	3240	3398	3505	3609	3768	3927	4085	4226	4420	4595	4808	5020	5195	5407				
Zone 3	3240	3349	3513	3623	3731	3896	4060	4223	4369	4570	4751	4970	5190	5370	5590				

• Metal legs

• Fully upholstered seat, back, and back panel



Evette

LOUNGE SEATING - SIN 33712

Kid-friendly. Kid-tough

Evette features the same construction as the HPFi full-size Eve family. It includes many of the same elements such as straight and curved seating, benches and matching tables. Along with the full-size Eve pieces, the youth-sized Evette integrates seamlessly for ganged or independent, freestanding seating.

Product Details

- Seat and back suspension features heavy-duty Sytex stretch-webbing
- Hardwood frames with reinforcing corner blocks are glued and stapled
- Arms are custom fabricated and wrapped with foam and fiber for comfort
- Metal-to-metal connection of arms, seat and back ensures long-term durability
- Fully upholstered with double-needle trim on seat, back and arms to reinforce sewing

- Brushed aluminum cylinder legs with adjustable glides
- Finished wood legs available in place of metal legs
- Two-color combinations available
- Adjustable glides
- Hybrid soy-based, CFC-free foam

How to Specify:

- 1 Model number
- 2 Wood finish (where applicable)
- 3 Fabric grade & name for back
- 4 Fabric grade & name for seat (if different)
- 5 Options

Options	Code	Price
Wood leg	Finish	N/C

Leg / Top Finishes	Code
Black	BLK
Boardwalk	BW
Driftwood	DW
Espresso	ESP
Mahogany	MAH
Moab	MOB
Monticello Maple	MM
Natural Maple	FM
Shoreline	SL
Windsor Cherry	WC

Finished Example

5874/ESP/6 Momentum Focal Citron/3 Culp Hathaway Apple

5834

Youth-size 30° curved bench

NOW



	Overall			Seat									St. Ydg.	Cu. Ft.	Shp. Wt.	Fr. Cls.
	18-30" W x 24" D x 16.5" H			18-30" W x 24" D x 16.5" H									1.5	21	38	300
	1	2/COM	3/COL	4	5	6	7	8	9	10	11	12/L	13	14	15/LL	
Zone 1	1405	1436	1472	1505	1537	1578	1620	1662	1702	1756	1785	1810	1842	1873	2011	
Zone 2	1454	1486	1524	1558	1591	1633	1677	1720	1762	1817	1847	1873	1906	1939	2081	
Zone 3	1503	1537	1575	1610	1645	1688	1733	1778	1821	1879	1910	1937	1971	2004	2152	

5838-IF

Youth size 30° inside facing chair

NOW



	Overall			Seat									St. Ydg.	Cu. Ft.	Shp. Wt.	Fr. Cls.
	18-30" W x 24" D x 28.5" H			18-30" W x 16" D x 16.5" H									3.75	31	55	300
	1	2/COM	3/COL	4	5	6	7	8	9	10	11	12/L	13	14	15/LL	
Zone 1	1918	1988	2084	2153	2224	2331	2423	2530	2624	2740	2861	2980	3079	3198	3416	
Zone 2	1985	2058	2157	2228	2302	2413	2508	2619	2716	2836	2961	3084	3187	3310	3536	
Zone 3	2052	2127	2230	2304	2380	2494	2593	2707	2808	2932	3061	3189	3295	3422	3655	

5868-IF

Youth size 60° inside facing loveseat

NOW



	Overall			Seat									St. Ydg.	Cu. Ft.	Shp. Wt.	Fr. Cls.
	36-60" W x 26.5" D x 28.5" H			36-60" W x 16" D x 16.5" H									7	36	77	250
	1	2/COM	3/COL	4	5	6	7	8	9	10	11	12/L	13	14	15/LL	
Zone 1	2973	3105	3280	3412	3546	3742	3918	4114	4291	4510	4733	4954	5139	5363	5795	
Zone 2	3077	3214	3395	3531	3670	3873	4055	4258	4441	4668	4899	5127	5319	5551	5998	
Zone 3	3181	3322	3510	3651	3794	4004	4192	4402	4591	4826	5064	5301	5499	5738	6201	

5874

Youth-size armless chair

NOW



	Overall			Seat									St. Ydg.	Cu. Ft.	Shp. Wt.	Fr. Cls.
	18.5" W x 24" D x 28.5" H			18.5" W x 16" D x 16.5" H									2	14	38	250
	1	2/COM	3/COL	4	5	6	7	8	9	10	11	12/L	13	14	15/LL	
Zone 1	1668	1711	1759	1800	1843	1901	1954	2011	2066	2137	2170	2233	2286	2350	2485	
Zone 2	1726	1771	1821	1863	1908	1968	2022	2081	2138	2212	2246	2311	2366	2432	2572	
Zone 3	1785	1831	1882	1926	1972	2034	2091	2152	2211	2287	2322	2389	2446	2515	2659	

Evette

Overall													St. Ydg.	Cu. Ft.	Shp. Wt.	Fr. Cls.
42.5" W x 21.5" D x 15.75" H													4.5	17	62	250
	1	2/COM	3/COL	4	5	6	7	8	9	10	11	12/L	13	14	15/LL	
Zone 1	1620	1710	1812	1897	1985	2103	2221	2337	2454	2600	2767	2878	2991	3162	3397	
Zone 2	1677	1770	1875	1963	2054	2177	2299	2419	2540	2691	2864	2979	3096	3273	3516	
Zone 3	1733	1830	1939	2030	2124	2250	2376	2501	2626	2782	2961	3079	3200	3383	3635	

5881

Oval table; Upholstered sides; Floating laminate top

NOW



•Not available in MOB

Overall													St. Ydg.	Cu. Ft.	Shp. Wt.	Fr. Cls.
42.5" W x 21.5" D x 13.75" H													4.5	17	61	250
	1	2/COM	3/COL	4	5	6	7	8	9	10	11	12/L	13	14	15/LL	
Zone 1	1582	1671	1772	1861	1948	2065	2181	2298	2417	2562	2731	2840	2948	3057	3362	
Zone 2	1637	1729	1834	1926	2016	2137	2257	2378	2502	2652	2827	2939	3051	3164	3480	
Zone 3	1693	1788	1896	1991	2084	2210	2334	2459	2586	2741	2922	3039	3154	3271	3597	

5882

Oval table; Upholstered sides; Laminate top

NOW



•Not available in MOB

Overall													St. Ydg.	Cu. Ft.	Shp. Wt.	Fr. Cls.
18.5" W x 24" D x 15.5" H													0.75	9.1	41	175
	1	2/COM	3/COL	4	5	6	7	8	9	10	11	12/L	13	14	15/LL	
Zone 1	1271	1286	1305	1320	1336	1357	1378	1400	1421	1446	1460	1484	1504	1526	1553	
Zone 2	1315	1331	1351	1366	1383	1404	1426	1449	1471	1497	1511	1536	1557	1579	1607	
Zone 3	1360	1376	1396	1412	1430	1452	1474	1498	1520	1547	1562	1588	1609	1633	1662	

5883

Connecting/freestanding table; Upholstered sides; Laminate top

NOW



•Not available in MOB

Option	Code	Price
Dry Erase Top	DE	334

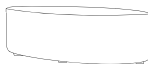
		Overall											St. Ydg.	Cu. Ft.	Shp. Wt.	Fr. Cls.	
		42.5" W x 21.5" D x 12.75" H											4.5	17	65	250	
		1	2/COM	3/COL	4	5	6	7	8	9	10	11	12/L	13	14	15/LL	
5886	Oval table; Fully Upholstered	Zone 1	1360	1449	1551	1638	1727	1843	1959	2077	2194	2339	2516	2617	2730	2842	3148
NOW		Zone 2	1408	1500	1605	1695	1787	1908	2028	2150	2271	2421	2604	2709	2826	2941	3258
		Zone 3	1455	1550	1660	1753	1848	1972	2096	2222	2348	2503	2692	2800	2921	3041	3368

•Not available in MOB

Oasis

		Overall				Seat							St. Ydg.	Cu. Ft.	Shp. Wt.	Fr. Cls.	
		18.5" W x 26" D x 43" H				18.5" W x 16" D x 16.5" H							4.25	25	59	250	
		1	2/COM	3/COM	4	5	6	7	8	9	10	11	12/L	13	14	15/LL	
5884	Youth-size armless chair, back panel	Zone 1	2153	2242	2344	2435	2524	2644	2762	2881	3000	3149	3220	3299	3468	3603	3940
NOW		Zone 2	2228	2320	2426	2520	2612	2737	2859	2982	3105	3259	3333	3414	3589	3729	4078
		Zone 3	2304	2399	2508	2605	2701	2829	2955	3083	3210	3369	3445	3530	3711	3855	4216

Fully upholstered seat, back and back panel



Flex Lounge

LOUNGE SEATING - SIN 33721

Modular Lounge Solutions

Flex is designed for casual gatherings allowing perimeter spaces to become useful for collaboration. Flex Lounge seating bridges the gap between casual Flex Ottoman seating and Flex Tier seating with a modular lounge approach. Comfortable seats and benches are easily re-configured for meetings or casual gatherings. Flex Lounge's design is based on 20" deep seats and 10" deep backs to create an endless variety of seating arrangements. 30" high padded backs make even a brief touchdown painless. Flex Lounge also includes two-sided seating suitable for dining halls.

Product Details

- Hardwood frames with reinforcing corner blocks, glued and stapled
- Fully upholstered with double-needle trim on seat, back and arms to reinforce sewing
- Available in textile or coated fabric upholsteries in a single or two-color combination

- Metal-to-metal connection of seat and back ensures long-term durability
- Non-marring tapered floor glides
- Hybrid soy-based, CFC-free foam
- All listed product options must be factory installed

How to Specify:

- 1 Model number
- 2 Fabric grade & name for back
- 3 Fabric grade & name for seat (if different)
- 4 Options

Options	Code	Price
Dry Erase Top (select models)	DE	223
Tablet Arm (select models)	TA	721

Finished Example

1501/FM/5 Mayer Orbit Midnight/2 Culp Linette Glacier/C

HPFi

206 Flex Lounge - Lounge Seating

Flex Lounge

	Overall	Seat										St. Ydg.	Cu. Ft.	Shp. Wt.	Fr. Cls.	
1501	20" W x 30" D x 30" H	20" W x 20" D x 18" H										3.75	19	69	250	
One-Seat Chair																
NOW		1	2/COM	3/COL	4	5	6	7	8	9	10	11	12/L	13	14	15/LL
Zone 1		1491	1561	1657	1727	1797	1903	1997	2103	2197	2314	2456	2596	2738	2879	3020
Zone 2		1543	1616	1715	1787	1860	1970	2067	2177	2274	2395	2542	2687	2834	2980	3126
Zone 3		1595	1670	1773	1848	1923	2036	2137	2250	2351	2476	2628	2778	2930	3081	3231



	Overall	Seat										St. Ydg.	Cu. Ft.	Shp. Wt.	Fr. Cls.	
1502	40" W x 30" D x 30" H	40" W x 20" D x 18" H										5.5	30	92	250	
Two-Seat Chair/Loveseat																
NOW		1	2/COM	3/COL	4	5	6	7	8	9	10	11	12/L	13	14	15/LL
Zone 1		2295	2399	2536	2642	2743	2899	3037	3193	3331	3502	3709	3917	4124	4330	4538
Zone 2		2375	2483	2625	2734	2839	3000	3143	3305	3448	3625	3839	4054	4268	4482	4697
Zone 3		2456	2567	2714	2827	2935	3102	3250	3417	3564	3747	3969	4191	4413	4633	4856



	Overall	Seat										St. Ydg.	Cu. Ft.	Shp. Wt.	Fr. Cls.	
1503	60" W x 30" D x 30" H	60" W x 20" D x 18" H										7	84	181	250	
Three-Seat Chair/Sofa																
NOW		1	2/COM	3/COL	4	5	6	7	8	9	10	11	12/L	13	14	15/LL
Zone 1		3058	3191	3366	3498	3629	3828	4004	4200	4377	4595	4858	5122	5386	5650	5915
Zone 2		3165	3303	3484	3620	3756	3962	4144	4347	4530	4756	5028	5301	5575	5848	6122
Zone 3		3272	3414	3602	3743	3883	4096	4284	4494	4683	4917	5198	5481	5763	6046	6329



	Overall	Seat										St. Ydg.	Cu. Ft.	Shp. Wt.	Fr. Cls.	
1504	30" W x 20" D x 18" H	30" W x 20" D x 18" H										2.5	14	36	250	
One and One Half-Seat Bench/Ottoman																
NOW		1	2/COM	3/COL	4	5	6	7	8	9	10	11	12/L	13	14	15/LL
Zone 1		1105	1152	1214	1264	1308	1379	1442	1514	1576	1654	1748	1843	1937	2031	2124
Zone 2		1144	1192	1256	1308	1354	1427	1492	1567	1631	1712	1809	1908	2005	2102	2198
Zone 3		1182	1233	1299	1352	1400	1476	1543	1620	1686	1770	1870	1972	2073	2173	2273



	Overall	Seat										St. Ydg.	Cu. Ft.	Shp. Wt.	Fr. Cls.	
1505	40" W x 20" D x 18" H	40" W x 20" D x 18" H										2.5	12	59	150	
Two-Seat Bench/Ottoman																
NOW		1	2/COM	3/COL	4	5	6	7	8	9	10	11	12/L	13	14	15/LL
Zone 1		1274	1323	1384	1433	1480	1550	1613	1682	1746	1824	1918	2012	2106	2201	2295
Zone 2		1319	1369	1432	1483	1532	1604	1669	1741	1807	1888	1985	2082	2180	2278	2375
Zone 3		1363	1416	1481	1533	1584	1659	1726	1800	1868	1952	2052	2153	2253	2355	2456



	Overall	Seat										St. Ydg.	Cu. Ft.	Shp. Wt.	Fr. Cls.	
1506	60" W x 20" D x 18" H	60" W x 20" D x 18" H										3.5	25	66	150	
Three-Seat Bench/Ottoman																
NOW		1	2/COM	3/COL	4	5	6	7	8	9	10	11	12/L	13	14	15/LL
Zone 1		1699	1766	1853	1920	1984	2085	2171	2271	2360	2468	2600	2732	2863	2996	3127
Zone 2		1758	1828	1918	1987	2053	2158	2247	2350	2443	2554	2691	2828	2963	3101	3236
Zone 3		1818	1890	1983	2054	2123	2231	2323	2430	2525	2641	2782	2923	3063	3206	3346



Flex Lounge

1507

One and One Half-Seat Chair

NOW



	Overall		Seat										St. Ydg.	Cu. Ft.	Shp. Wt.	Fr. Cls.
	30" W x 30" D x 30" H		30" W x 20" D x 18" H										5	24	73	250
	1	2/COM	3/COL	4	5	6	7	8	9	10	11	12/L	13	14	15/LL	
Zone 1	1884	1978	2103	2197	2291	2432	2558	2700	2824	2982	3169	3358	3547	3735	3922	
Zone 2	1950	2047	2177	2274	2371	2517	2648	2795	2923	3086	3280	3476	3671	3866	4059	
Zone 3	2016	2116	2250	2351	2451	2602	2737	2889	3022	3191	3391	3593	3795	3996	4197	

1508

Corner Chair

NOW



	Overall		Seat										St. Ydg.	Cu. Ft.	Shp. Wt.	Fr. Cls.
	30" W x 30" D x 30" H		20" W x 20" D x 18" H										5.75	24	93	250
	1	2/COM	3/COL	4	5	6	7	8	9	10	11	12/L	13	14	15/LL	
Zone 1	2307	2415	2559	2668	2774	2938	3081	3246	3389	3567	3785	4003	4219	4435	4652	
Zone 2	2388	2500	2649	2761	2871	3041	3189	3360	3508	3692	3917	4143	4367	4590	4815	
Zone 3	2468	2584	2738	2855	2968	3144	3297	3473	3626	3817	4050	4283	4514	4745	4978	

1509

Quartile Chair

NOW



	Overall		Seat										St. Ydg.	Cu. Ft.	Shp. Wt.	Fr. Cls.
	30" W x 30" D x 30" H		20" W x 20" D x 18" H										5.75	24	77	250
	1	2/COM	3/COL	4	5	6	7	8	9	10	11	12/L	13	14	15/LL	
Zone 1	2374	2484	2627	2735	2844	3006	3151	3313	3456	3638	3855	4070	4288	4503	4719	
Zone 2	2457	2571	2719	2831	2944	3111	3261	3429	3577	3765	3990	4212	4438	4661	4884	
Zone 3	2540	2658	2811	2926	3043	3216	3372	3545	3698	3893	4125	4355	4588	4818	5049	

1539

Quartile Ottoman

NOW



	Overall		Seat										St. Ydg.	Cu. Ft.	Shp. Wt.	Fr. Cls.
	20" W x 20" D x 18" H		20" W x 20" D x 18" H										1.5	10	32	250
	1	2/COM	3/COL	4	5	6	7	8	9	10	11	12/L	13	14	15/LL	
Zone 1	884	913	952	979	1008	1050	1088	1130	1166	1214	1271	1327	1384	1439	1497	
Zone 2	915	945	985	1013	1043	1087	1126	1170	1207	1256	1315	1373	1432	1489	1549	
Zone 3	946	977	1019	1048	1079	1124	1164	1209	1248	1299	1360	1420	1481	1540	1602	

1554

One-Seat Ottoman

NOW



	Overall		Seat										St. Ydg.	Cu. Ft.	Shp. Wt.	Fr. Cls.
	20" W x 20" D x 18" H		20" W x 20" D x 18" H										1.75	10	41	250
	1	2/COM	3/COL	4	5	6	7	8	9	10	11	12/L	13	14	15/LL	
Zone 1	850	885	930	966	1002	1052	1098	1150	1196	1260	1300	1365	1432	1497	1562	
Zone 2	880	916	963	1000	1037	1089	1136	1190	1238	1304	1346	1413	1482	1549	1617	
Zone 3	910	947	995	1034	1072	1126	1175	1231	1280	1348	1391	1461	1532	1602	1671	

Option	Code	Price
Tablet Arm	TA	721
Dry Erase Top	DE	223

1559

Crescent-shape Ottoman

NOW





	Overall		Seat										St. Ydg.	Cu. Ft.	Shp. Wt.	Fr. Cls.
	50" W x 20" D x 18" H		50" W x 20" D x 18" H										2.75	13	42	250
	1	2/COM	3/COL	4	5	6	7	8	9	10	11	12/L	13	14	15/LL	
Zone 1	1792	1841	1903	1949	1995	2066	2128	2200	2262	2340	2434	2529	2622	2716	2809	
Zone 2	1855	1905	1970	2017	2065	2138	2202	2277	2341	2422	2519	2618	2714	2811	2907	
Zone 3	1917	1970	2036	2085	2135	2211	2277	2354	2420	2504	2604	2706	2806	2906	3006	

Flex Lounge

	Overall	Seat											St. Ydg.	Cu. Ft.	Shp. Wt.	Fr. Cls.	
1590	71" W x 29" D x 18" H	60" W x 20" D x 18" H											4	30	81	250	
Arc Bench/Ottoman		1	2/COM	3/COL	4	5	6	7	8	9	10	11	12/L	13	14	15/LL	
Now		Zone 1	1774	1851	1950	2028	2101	2214	2315	2428	2529	2653	2804	2955	3105	3255	3408
		Zone 2	1836	1916	2018	2099	2175	2291	2396	2513	2618	2746	2902	3058	3214	3369	3527
		Zone 3	1898	1981	2087	2170	2248	2369	2477	2598	2706	2839	3000	3162	3322	3483	3647

	Overall	Seat											St. Ydg.	Cu. Ft.	Shp. Wt.	Fr. Cls.	
1595-IF	71" W x 36" D x 30" H	60" W x 20" D x 18" H											6.5	79	178	250	
Inside Facing Arc/Settee		1	2/COM	3/COL	4	5	6	7	8	9	10	11	12/L	13	14	15/LL	
Now		Zone 1	3698	3820	3985	4105	4227	4412	4575	4759	4922	5126	5371	5615	5861	6103	6348
		Zone 2	3827	3954	4124	4249	4375	4566	4735	4926	5094	5305	5559	5812	6066	6317	6570
		Zone 3	3957	4087	4264	4392	4523	4721	4895	5092	5267	5485	5747	6008	6271	6530	6792

	Overall	Seat											St. Ydg.	Cu. Ft.	Shp. Wt.	Fr. Cls.	
1595-OF	68" W x 36" D x 30" H	60" W x 20" D x 18" H											6.5	55	148	250	
Outside Facing Arc/Settee		1	2/COM	3/COL	4	5	6	7	8	9	10	11	12/L	13	14	15/LL	
Now		Zone 1	3698	3820	3985	4105	4227	4412	4575	4759	4922	5126	5371	5615	5861	6103	6348
		Zone 2	3827	3954	4124	4249	4375	4566	4735	4926	5094	5305	5559	5812	6066	6317	6570
		Zone 3	3957	4087	4264	4392	4523	4721	4895	5092	5267	5485	5747	6008	6271	6530	6792

	Overall	Seats											St. Ydg.	Cu. Ft.	Shp. Wt.	Fr. Cls.	
15012	20" W x 50" D x 30" H	20" W x 20" D x 18" H											5.5	51	106	250	
Two-Sided, One-Seat Chair		1	2/COM	3/COL	4	5	6	7	8	9	10	11	12/L	13	14	15/LL	
Now		Zone 1	2457	2562	2700	2803	2905	3061	3198	3355	3493	3665	3871	4079	4287	4493	4701
		Zone 2	2543	2652	2795	2901	3007	3168	3310	3472	3615	3793	4006	4222	4437	4650	4866
		Zone 3	2629	2741	2889	2999	3108	3275	3422	3590	3738	3922	4142	4365	4587	4808	5030

	Overall	Seats											St. Ydg.	Cu. Ft.	Shp. Wt.	Fr. Cls.	
15022	40" W x 50" D x 30" H	40" W x 20" D x 18" H											9	56	154	250	
Two-Sided, Two-Seat Chair/Loveseat		1	2/COM	3/COL	4	5	6	7	8	9	10	11	12/L	13	14	15/LL	
Now		Zone 1	3748	3898	4099	4251	4401	4627	4827	5052	5254	5506	5807	6108	6409	6712	7011
		Zone 2	3879	4034	4242	4400	4555	4789	4996	5229	5438	5699	6010	6322	6633	6947	7256
		Zone 3	4010	4171	4386	4549	4709	4951	5165	5406	5622	5891	6213	6536	6858	7182	7502

	Overall	Seats											St. Ydg.	Cu. Ft.	Shp. Wt.	Fr. Cls.	
15072	30" W x 50" D x 30" H	30" W x 20" D x 18" H											7.5	55	134	250	
Two-Sided, One and One Half-Seat Chair		1	2/COM	3/COL	4	5	6	7	8	9	10	11	12/L	13	14	15/LL	
Now		Zone 1	3155	3298	3484	3625	3766	3978	4167	4379	4566	4802	5084	5368	5649	5932	6214
		Zone 2	3265	3413	3606	3752	3898	4117	4313	4532	4726	4970	5262	5556	5847	6140	6431
		Zone 3	3376	3529	3728	3879	4030	4256	4459	4686	4886	5138	5440	5744	6044	6347	6649

	Overall	St. Ydg.	Cu. Ft.	Shp. Wt.	Fr. Cls.
UG	2.5" W x 6" D x .25" H	N/A	N/A	N/A	N/A
Universal Ganging Bracket					
Now					
	Zone 1	60			
	Zone 2	60			
	Zone 3	60			



Flex Mobile

LOUNGE SEATING - SIN 33721

Modular Lounge Solutions

Flex is designed for casual gatherings allowing perimeter spaces to become useful for collaboration. Flex Mobile seating bridges the gap between casual Flex Ottoman seating and Flex Tier seating with a mobile and modular lounge approach. Comfortable seats and benches are easily re-configured for meetings or casual gatherings. 30" high padded backs make even a brief touchdown painless.

Product Details

- Hardwood frames with reinforcing corner blocks, glued and stapled
- Fully upholstered with double-needle trim on seat, back and arms to reinforce sewing
- Available in textile or coated fabric upholsteries in a single or two-color combination

- Dual-wheel locking casters provide easy mobility
- Metal-to-metal connection of seat and back ensures long-term durability
- Sustainable soy-based, CFC-free foam interior for maximum comfort
- All listed product options must be factory installed

How to Specify:

- 1 Model number
- 2 Fabric grade & name for back
- 3 Fabric grade & name for seat (if different)
- 4 Options

Options	Code	Price
Dry Erase Top (select models)	DE	223
Tablet Arm (select models)	TA	721

Finished Example

1501C/5 Stinson Pivot Fennel/12 Stinson Bommerang Sunrise/TA

	Overall	Seat	St. Ydg.	Cu. Ft.	Shp. Wt.	Fr. Cls.
1501C	20" W x 30" D x 30" H	20" W x 20" D x 18" H	3.75	19	69	250

One-Seat Chair

NOW



	1	2/COM	3/COL	4	5	6	7	8	9	10	11	12/L	13	14	15/LL
Zone 1	1527	1598	1694	1764	1835	1940	2034	2141	2234	2351	2493	2634	2776	2917	3057
Zone 2	1580	1654	1753	1826	1899	2008	2105	2216	2312	2433	2580	2726	2873	3019	3164
Zone 3	1634	1710	1813	1887	1963	2076	2176	2291	2390	2516	2668	2818	2970	3121	3271

	Overall	Seat	St. Ydg.	Cu. Ft.	Shp. Wt.	Fr. Cls.
1502C	40" W x 30" D x 30" H	40" W x 20" D x 18" H	5.5	30	94	250

Two-Seat Chair/Loveseat

NOW



	1	2/COM	3/COL	4	5	6	7	8	9	10	11	12/L	13	14	15/LL
Zone 1	2333	2436	2573	2679	2780	2937	3075	3230	3368	3539	3743	3954	4162	4367	4575
Zone 2	2415	2521	2663	2773	2877	3040	3183	3343	3486	3663	3874	4092	4308	4520	4735
Zone 3	2496	2607	2753	2867	2975	3143	3290	3456	3604	3787	4005	4231	4453	4673	4895

	Overall	Seat	St. Ydg.	Cu. Ft.	Shp. Wt.	Fr. Cls.
1503C	60" W x 30" D x 30" H	60" W x 20" D x 18" H	7	84	140	250

Three-Seat Chair/Sofa

NOW



	1	2/COM	3/COL	4	5	6	7	8	9	10	11	12/L	13	14	15/LL
Zone 1	3114	3247	3422	3553	3686	3883	4059	4256	4433	4651	4914	5178	5441	5706	5971
Zone 2	3223	3361	3542	3677	3815	4019	4201	4405	4588	4814	5086	5359	5631	5906	6180
Zone 3	3332	3474	3662	3802	3944	4155	4343	4554	4743	4977	5258	5540	5822	6105	6389

	Overall	Seat	St. Ydg.	Cu. Ft.	Shp. Wt.	Fr. Cls.
1504C	30" W x 20" D x 18" H	30" W x 20" D x 18" H	2.5	14	36	250

One and One Half-Seat Bench/
Ottoman

NOW



	1	2/COM	3/COL	4	5	6	7	8	9	10	11	12/L	13	14	15/LL
Zone 1	1142	1189	1251	1301	1346	1416	1480	1551	1614	1691	1786	1880	1975	2068	2161
Zone 2	1182	1231	1295	1347	1393	1466	1532	1605	1670	1750	1849	1946	2044	2140	2237
Zone 3	1222	1272	1339	1392	1440	1515	1584	1660	1727	1809	1911	2012	2113	2213	2312

	Overall	Seat	St. Ydg.	Cu. Ft.	Shp. Wt.	Fr. Cls.
1505C	40" W x 20" D x 18" H	40" W x 20" D x 18" H	2.5	12	59	150

Two-Seat Bench/Ottoman

NOW



	1	2/COM	3/COL	4	5	6	7	8	9	10	11	12/L	13	14	15/LL
Zone 1	1312	1360	1423	1469	1517	1587	1650	1719	1784	1862	1955	2049	2144	2238	2333
Zone 2	1358	1408	1473	1520	1570	1643	1708	1779	1846	1927	2023	2121	2219	2316	2415
Zone 3	1404	1455	1523	1572	1623	1698	1766	1839	1909	1992	2092	2192	2294	2395	2496

Flex Mobile

	Overall		Seat										St. Ydg.	Cu. Ft.	Shp. Wt.	Fr. Cls.	
1506C	60" W x 20" D x 18" H		60" W x 20" D x 18" H										3.5	25	66	150	
Three-Seat Bench/Ottoman			1	2/COM	3/COL	4	5	6	7	8	9	10	11	12/L	13	14	15/LL
NOW																	
Zone 1	1755	1822	1909	1975	2041	2141	2227	2326	2416	2524	2655	2788	2919	3052	3182		
Zone 2	1816	1886	1976	2044	2112	2216	2305	2407	2501	2612	2748	2886	3021	3159	3293		
Zone 3	1878	1950	2043	2113	2184	2291	2383	2489	2585	2701	2841	2983	3123	3266	3405		



	Overall		Seat										St. Ydg.	Cu. Ft.	Shp. Wt.	Fr. Cls.	
1507C	30" W x 30" D x 30" H		30" W x 20" D x 18" H										5	24	73	250	
One and One Half-Seat Chair			1	2/COM	3/COL	4	5	6	7	8	9	10	11	12/L	13	14	15/LL
NOW																	
Zone 1	1922	2014	2141	2234	2328	2470	2595	2737	2862	3020	3207	3395	3584	3773	3960		
Zone 2	1989	2084	2216	2312	2409	2556	2686	2833	2962	3126	3319	3514	3709	3905	4099		
Zone 3	2057	2155	2291	2390	2491	2643	2777	2929	3062	3231	3431	3633	3835	4037	4237		



	Overall		Seat										St. Ydg.	Cu. Ft.	Shp. Wt.	Fr. Cls.	
1508C	30" W x 30" D x 30" H		20" W x 20" D x 18" H										5.75	24	93	250	
Corner Chair			1	2/COM	3/COL	4	5	6	7	8	9	10	11	12/L	13	14	15/LL
NOW																	
Zone 1	2344	2452	2596	2705	2811	2975	3119	3283	3426	3605	3823	4040	4256	4472	4689		
Zone 2	2426	2538	2687	2800	2909	3079	3228	3398	3546	3731	3957	4181	4405	4629	4853		
Zone 3	2508	2624	2778	2894	3008	3183	3337	3513	3666	3857	4091	4323	4554	4785	5017		



	Overall		Seat										St. Ydg.	Cu. Ft.	Shp. Wt.	Fr. Cls.	
1509C	30" W x 30" D x 30" H		20" W x 20" D x 18" H										5.75	24	77	250	
Quartile Chair			1	2/COM	3/COL	4	5	6	7	8	9	10	11	12/L	13	14	15/LL
NOW																	
Zone 1	2413	2520	2668	2773	2882	3043	3190	3351	3494	3675	3892	4108	4325	4541	4757		
Zone 2	2497	2608	2761	2870	2983	3150	3302	3468	3616	3804	4028	4252	4476	4700	4923		
Zone 3	2582	2696	2855	2967	3084	3256	3413	3586	3739	3932	4164	4396	4628	4859	5090		



	Overall		Seat										St. Ydg.	Cu. Ft.	Shp. Wt.	Fr. Cls.	
1539C	20" W x 20" D x 18" H		20" W x 20" D x 18" H										1.5	10	32	250	
Quartile Ottoman			1	2/COM	3/COL	4	5	6	7	8	9	10	11	12/L	13	14	15/LL
NOW																	
Zone 1	921	950	989	1017	1045	1088	1126	1167	1204	1251	1308	1365	1423	1478	1535		
Zone 2	953	983	1024	1053	1082	1126	1165	1208	1246	1295	1354	1413	1473	1530	1589		
Zone 3	985	1017	1058	1088	1118	1164	1205	1249	1288	1339	1400	1461	1523	1581	1642		



1554C

One-Seat Ottoman

NOW



Overall	Seat											St. Ydg.	Cu. Ft.	Shp. Wt.	Fr. Cls.
20" W x 20" D x 18" H	20" W x 20" D x 18" H											1.75	10	41	250

	1	2/COM	3/COL	4	5	6	7	8	9	10	11	12/L	13	14	15/LL
Zone 1	887	922	967	1002	1040	1090	1135	1187	1234	1297	1338	1402	1468	1535	1600
Zone 2	918	954	1001	1037	1076	1128	1175	1229	1277	1342	1385	1451	1519	1589	1656
Zone 3	949	987	1035	1072	1113	1166	1214	1270	1320	1388	1432	1500	1571	1642	1712

Option	Code	Price
Tablet Arm	TA	721
Dry Erase Top	DE	223

1559C

Crescent-shape Ottoman

NOW



Overall	Seat											St. Ydg.	Cu. Ft.	Shp. Wt.	Fr. Cls.
50" W x 20" D x 18" H	50" W x 20" D x 18" H											2.75	13	42	250

	1	2/COM	3/COL	4	5	6	7	8	9	10	11	12/L	13	14	15/LL
Zone 1	1839	1887	1949	1995	2043	2113	2176	2245	2310	2388	2480	2575	2669	2762	2857
Zone 2	1903	1953	2017	2065	2115	2187	2252	2324	2391	2472	2567	2665	2762	2859	2957
Zone 3	1968	2019	2085	2135	2186	2261	2328	2402	2472	2555	2654	2755	2856	2955	3057

1590C

Arc Bench/Ottoman

NOW



Overall	Seat											St. Ydg.	Cu. Ft.	Shp. Wt.	Fr. Cls.
68" W x 29" D x 18" H	60" W x 20" D x 18" H											4	77	106	250

	1	2/COM	3/COL	4	5	6	7	8	9	10	11	12/L	13	14	15/LL
Zone 1	1831	1907	2007	2084	2157	2271	2371	2485	2585	2709	2860	3011	3161	3311	3464
Zone 2	1895	1974	2077	2157	2232	2350	2454	2572	2675	2804	2960	3116	3272	3427	3585
Zone 3	1959	2040	2147	2230	2308	2430	2537	2659	2766	2899	3060	3222	3382	3543	3706

1595C-IF

Inside Facing Arc/Settee

NOW



Overall	Seat											St. Ydg.	Cu. Ft.	Shp. Wt.	Fr. Cls.
71" W x 36" D x 30" H	60" W x 20" D x 18" H											6.5	75	179	250

	1	2/COM	3/COL	4	5	6	7	8	9	10	11	12/L	13	14	15/LL
Zone 1	3755	3876	4040	4162	4283	4467	4631	4816	4978	5182	5427	5671	5917	6161	6405
Zone 2	3886	4012	4181	4308	4433	4623	4793	4985	5152	5363	5617	5869	6124	6377	6629
Zone 3	4018	4147	4323	4453	4583	4780	4955	5153	5326	5545	5807	6068	6331	6592	6853

1595C-OF

Outside Facing Arc/Settee

NOW



Overall	Seat											St. Ydg.	Cu. Ft.	Shp. Wt.	Fr. Cls.
68" W x 36" D x 30" H	60" W x 20" D x 18" H											6.5	55	148	250

	1	2/COM	3/COL	4	5	6	7	8	9	10	11	12/L	13	14	15/LL
Zone 1	3755	3876	4040	4162	4283	4467	4631	4816	4978	5182	5427	5671	5917	6161	6405
Zone 2	3886	4012	4181	4308	4433	4623	4793	4985	5152	5363	5617	5869	6124	6377	6629
Zone 3	4018	4147	4323	4453	4583	4780	4955	5153	5326	5545	5807	6068	6331	6592	6853



Flex Ottomans

LOUNGE SEATING - SIN 33721

Turning Spaces Into Collaborative Work Areas

Fully-upholstered Flex Ottomans are available in a wide variety of shapes - cubes, circles, triangles, octagons, benches, trapezoids or tapers. A variation of the taper includes adding angled brushed aluminum legs to create bistro-height seating. A great way to add extra seating to any space. Mix and match upholsteries to create colorful seating in children's areas.

Product Details

- EPS(expanded polystyrene) core on engineered hardwood base
- Hardwood frames with reinforcing corner blocks, glued and stapled on tablet models
- Fully upholstered with double-needle trim on all surfaces to reinforce sewing

- Available in textile or coated fabric upholsteries in a single or two-color combination
- Non-marring tapered floor glides
- Hybrid soy-based, CFC-free foam
- All listed product options must be factory installed

How to Specify:

- 1 Model number
- 2 Fabric grade & name for seat
- 3 Fabric grade & name for sides (if different)
- 4 Options

Options	Code	Price
Casters	C	35
Dry Erase Top (select models)	DE	varies
Tablet Arm (select models)	TA	721
Tufted Top (select models)	TF	387

Finished Example

1520/7 Mayer Elevation Cranberry/3 Stinson Staple Fire/C

Flex Ottomans

1504 One and One Half-Seat Bench/ Ottoman

NOW



	Overall	Seat											St. Ydg.	Cu. Ft.	Shp. Wt.	Fr. Cls.
	30" W x 20" D x 18" H	30" W x 20" D x 18" H											2.5	12	50	150
	1	2/COM	3/COL	4	5	6	7	8	9	10	11	12/L	13	14	15/LL	
Zone 1	1105	1152	1214	1264	1308	1379	1442	1514	1576	1654	1748	1843	1937	2031	2124	
Zone 2	1144	1192	1256	1308	1354	1427	1492	1567	1631	1712	1809	1908	2005	2102	2198	
Zone 3	1182	1233	1299	1352	1400	1476	1543	1620	1686	1770	1870	1972	2073	2173	2273	

1505 Two-Seat Bench/Ottoman

NOW



	Overall	Seat											St. Ydg.	Cu. Ft.	Shp. Wt.	Fr. Cls.
	40" W x 20" D x 18" H	40" W x 20" D x 18" H											2.5	12	59	150
	1	2/COM	3/COL	4	5	6	7	8	9	10	11	12/L	13	14	15/LL	
Zone 1	1274	1323	1384	1433	1480	1550	1613	1682	1746	1824	1918	2012	2106	2201	2295	
Zone 2	1319	1369	1432	1483	1532	1604	1669	1741	1807	1888	1985	2082	2180	2278	2375	
Zone 3	1363	1416	1481	1533	1584	1659	1726	1800	1868	1952	2052	2153	2253	2355	2456	

1506 Three-Seat Bench/Ottoman

NOW



	Overall	Seat											St. Ydg.	Cu. Ft.	Shp. Wt.	Fr. Cls.
	60" W x 20" D x 18" H	60" W x 20" D x 18" H											3.5	25	66	150
	1	2/COM	3/COL	4	5	6	7	8	9	10	11	12/L	13	14	15/LL	
Zone 1	1699	1766	1853	1920	1984	2085	2171	2271	2360	2468	2600	2732	2863	2996	3127	
Zone 2	1758	1828	1918	1987	2053	2158	2247	2350	2443	2554	2691	2828	2963	3101	3236	
Zone 3	1818	1890	1983	2054	2123	2231	2323	2430	2525	2641	2782	2923	3063	3206	3346	

1510 120° angle Ottoman

NOW



	Overall	Seat											St. Ydg.	Cu. Ft.	Shp. Wt.	Fr. Cls.
	69" W x 37.5" D x 18" H	20"/40" W x 20" D x 18" H											4	33	96	150
	1	2/COM	3/COL	4	5	6	7	8	9	10	11	12/L	13	14	15/LL	
Zone 1	2105	2175	2265	2334	2402	2505	2595	2699	2789	2903	3039	3177	3313	3450	3586	
Zone 2	2179	2251	2344	2416	2486	2593	2686	2793	2887	3005	3145	3288	3429	3571	3712	
Zone 3	2252	2327	2424	2497	2570	2680	2777	2888	2984	3106	3252	3399	3545	3692	3837	

1517 Student-size Cube/Ottoman

NOW



	Overall	Seat											St. Ydg.	Cu. Ft.	Shp. Wt.	Fr. Cls.
	15" W x 15" D x 15" H	15" W x 15" D x 15" H											1.5	5	9	300
	1	2/COM	3/COL	4	5	6	7	8	9	10	11	12/L	13	14	15/LL	
Zone 1	657	688	726	755	782	824	862	904	941	990	1011	1063	1113	1155	1207	
Zone 2	680	712	751	781	809	853	892	936	974	1025	1046	1100	1152	1195	1249	
Zone 3	703	736	777	808	837	882	922	967	1007	1059	1082	1137	1191	1236	1291	

1518 18" Diameter Petal Ottoman

NOW



	Overall	Seat											St. Ydg.	Cu. Ft.	Shp. Wt.	Fr. Cls.
	18" W x 18" D x 18" H	18" W x 18" D x 18" H											1.75	11	17	300
	1	2/COM	3/COL	4	5	6	7	8	9	10	11	12/L	13	14	15/LL	
Zone 1	723	754	799	830	860	906	952	995	1037	1093	1143	1204	1265	1315	1376	
Zone 2	748	780	827	859	890	938	985	1030	1073	1131	1183	1246	1309	1361	1424	
Zone 3	774	807	855	888	920	969	1019	1065	1110	1170	1223	1288	1354	1407	1472	

Flex Ottomans

1520
20" Round Ottoman

NOW 

Overall		Seat										St. Ydg.	Cu. Ft.	Shp. Wt.	Fr. Cls.
20" W x 20" D x 18" H		20" W x 20" D x 18" H										1.75	11	20	250
	1	2/COM	3/COL	4	5	6	7	8	9	10	11	12/L	13	14	15/LL
Zone 1	817	851	889	922	955	1000	1045	1091	1133	1190	1315	1386	1460	1519	1591
Zone 2	846	881	920	954	988	1035	1082	1129	1173	1232	1361	1435	1511	1572	1647
Zone 3	874	911	951	987	1022	1070	1118	1167	1212	1273	1407	1483	1562	1625	1702
												Option	Code	Price	
												Casters	C	35	
												Dry Erase Top	DE	334	

1523
Small Triangle Ottoman; 18" H

NOW 

Overall		Seat										St. Ydg.	Cu. Ft.	Shp. Wt.	Fr. Cls.
22.5" W x 22.5" D x 18" H		20" W x 20" D x 18" H										2	10	23	250
	1	2/COM	3/COL	4	5	6	7	8	9	10	11	12/L	13	14	15/LL
Zone 1	934	969	1020	1055	1090	1142	1193	1246	1291	1356	1413	1482	1552	1609	1678
Zone 2	967	1003	1056	1092	1128	1182	1235	1290	1336	1403	1462	1534	1606	1665	1737
Zone 3	999	1037	1091	1129	1166	1222	1277	1333	1381	1451	1512	1586	1661	1722	1795

1524
24" Round Ottoman

NOW 

Overall		Seat										St. Ydg.	Cu. Ft.	Shp. Wt.	Fr. Cls.
24" W x 24" D x 18" H		24" W x 24" D x 18" H										1.75	11	26	250
	1	2/COM	3/COL	4	5	6	7	8	9	10	11	12/L	13	14	15/LL
Zone 1	878	911	949	983	1015	1060	1105	1152	1195	1250	1290	1349	1410	1461	1520
Zone 2	909	943	982	1017	1051	1097	1144	1192	1237	1294	1335	1396	1459	1512	1573
Zone 3	939	975	1015	1052	1086	1134	1182	1233	1279	1338	1380	1443	1509	1563	1626
												Option	Code	Price	
												Casters	C	35	
												Dry Erase Top	DE	334	

1525
Pentagon Ottoman

NOW 

Overall		Seat										St. Ydg.	Cu. Ft.	Shp. Wt.	Fr. Cls.
26" W x 24" D x 18" H		26" W x 24" D x 18" H										2.5	11	26	250
	1	2/COM	3/COL	4	5	6	7	8	9	10	11	12/L	13	14	15/LL
Zone 1	1145	1187	1252	1296	1340	1403	1468	1534	1592	1672	1744	1830	1916	1989	2075
Zone 2	1185	1229	1296	1341	1387	1452	1519	1588	1648	1731	1805	1894	1983	2059	2148
Zone 3	1225	1270	1340	1387	1434	1501	1571	1641	1703	1789	1866	1958	2050	2128	2220

1532
Octagonal Ottoman

NOW 

Overall		Seat										St. Ydg.	Cu. Ft.	Shp. Wt.	Fr. Cls.
32" W x 32" D x 18" H		32" W x 32" D x 18" H										2	40.8	80	200
	1	2/COM	3/COL	4	5	6	7	8	9	10	11	12/L	13	14	15/LL
Zone 1	1710	1784	1871	1937	2003	2101	2189	2287	2375	2486	2513	2582	2649	2718	2786
Zone 2	1770	1846	1936	2005	2073	2175	2266	2367	2458	2573	2601	2672	2742	2813	2884
Zone 3	1830	1909	2002	2073	2143	2248	2342	2447	2541	2660	2689	2763	2834	2908	2981

1533
Large Triangle Ottoman; 18" H

NOW 

Overall		Seat										St. Ydg.	Cu. Ft.	Shp. Wt.	Fr. Cls.
31.5" W x 35" D x 18" H		30" W x 30" D x 18" H										3	30	42	300
	1	2/COM	3/COL	4	5	6	7	8	9	10	11	12/L	13	14	15/LL
Zone 1	1167	1229	1320	1380	1439	1532	1622	1713	1794	1905	2007	2126	2248	2350	2471
Zone 2	1208	1272	1366	1428	1489	1586	1679	1773	1857	1972	2077	2200	2327	2432	2557
Zone 3	1249	1315	1412	1477	1540	1639	1736	1833	1920	2038	2147	2275	2405	2515	2644

Flex Ottomans

1534 Large Cube/Ottoman; 18" H

NOW



	Overall		Seat										St. Ydg.	Cu. Ft.	Shp. Wt.	Fr. Cls.
	30" W x 30" D x 18" H		30" W x 30" D x 18" H										1.75	40	67	300
	1	2/COM	3/COL	4	5	6	7	8	9	10	11	12/L	13	14	15/LL	
Zone 1	1140	1195	1279	1338	1394	1478	1561	1647	1720	1824	1918	2031	2143	2237	2350	
Zone 2	1180	1237	1324	1385	1443	1530	1616	1705	1780	1888	1985	2102	2218	2315	2432	
Zone 3	1220	1279	1369	1432	1492	1581	1670	1762	1840	1952	2052	2173	2293	2394	2515	

1535 Large Cube/Ottoman; 30" H

NOW



	Overall		Seat										St. Ydg.	Cu. Ft.	Shp. Wt.	Fr. Cls.
	30" W x 30" D x 30" H		30" W x 30" D x 30" H										3	23	51	300
	1	2/COM	3/COL	4	5	6	7	8	9	10	11	12/L	13	14	15/LL	
Zone 1	1389	1441	1519	1572	1623	1701	1779	1856	1926	2021	2107	2212	2316	2402	2507	
Zone 2	1438	1491	1572	1627	1680	1761	1841	1921	1993	2092	2181	2289	2397	2486	2595	
Zone 3	1486	1542	1625	1682	1737	1820	1904	1986	2061	2162	2254	2367	2478	2570	2682	

1536 36" Round Table/Ottoman

NOW



	Overall		Seat										St. Ydg.	Cu. Ft.	Shp. Wt.	Fr. Cls.
	36" W x 36" D x 18.5" H		36" W x 36" D x 18.5" H										3.5	25	47	300
	1	2/COM	3/COL	4	5	6	7	8	9	10	11	12/L	13	14	15/LL	
Zone 1	1520	1593	1681	1748	1814	1912	2001	2099	2186	2296	2342	2402	2461	2506	2565	
Zone 2	1573	1649	1740	1809	1877	1979	2071	2172	2263	2376	2424	2486	2547	2594	2655	
Zone 3	1626	1705	1799	1870	1941	2046	2141	2246	2339	2457	2506	2570	2633	2681	2745	

Option	Code	Price
Dry Erase Top	DE	223
Tufted Top	TF	387

1537 Small Triangle Ottoman; 30" H

NOW



	Overall		Seat										St. Ydg.	Cu. Ft.	Shp. Wt.	Fr. Cls.
	25.5" W x 22.5" D x 30" H		20" W x 20" D x 30" H										3	30	26	400
	1	2/COM	3/COL	4	5	6	7	8	9	10	11	12/L	13	14	15/LL	
Zone 1	1097	1149	1227	1279	1330	1409	1486	1565	1633	1730	1816	1921	2024	2110	2214	
Zone 2	1135	1189	1270	1324	1377	1458	1538	1620	1690	1791	1880	1988	2095	2184	2291	
Zone 3	1174	1229	1313	1369	1423	1508	1590	1675	1747	1851	1943	2055	2166	2258	2369	

1538 Large Triangle Ottoman; 30" H

NOW



	Overall		Seat										St. Ydg.	Cu. Ft.	Shp. Wt.	Fr. Cls.
	31.5" W x 35" D x 30" H		30" W x 30" D x 30" H										4.25	29.2	45	300
	1	2/COM	3/COL	4	5	6	7	8	9	10	11	12/L	13	14	15/LL	
Zone 1	1355	1428	1537	1611	1685	1796	1906	2017	2116	2250	2372	2519	2667	2789	2937	
Zone 2	1402	1478	1591	1667	1744	1859	1973	2088	2190	2329	2455	2607	2760	2887	3040	
Zone 3	1450	1528	1645	1724	1803	1922	2039	2158	2264	2408	2538	2695	2854	2984	3143	

1540 90 Degree Arc Ottoman

NOW



	Overall		Seat										St. Ydg.	Cu. Ft.	Shp. Wt.	Fr. Cls.
	30.5" W x 30.5" D x 18" H		30.5" W x 20" D x 18" H										2.75	31	43	150
	1	2/COM	3/COL	4	5	6	7	8	9	10	11	12/L	13	14	15/LL	
Zone 1	1153	1202	1272	1321	1368	1439	1512	1582	1647	1733	1813	1908	2003	2083	2178	
Zone 2	1193	1244	1317	1367	1416	1489	1565	1637	1705	1794	1876	1975	2073	2156	2254	
Zone 3	1234	1286	1361	1413	1464	1540	1618	1693	1762	1854	1940	2042	2143	2229	2330	

Flex Ottomans

	Overall	Seat										St. Ydg.	Cu. Ft.	Shp. Wt.	Fr. Cls.	
1545	38" W x 22" D x 18" H	38" W x 20" D x 18" H										2.5	39	56	300	
45 Degree Arc Ottoman		1	2/COM	3/COL	4	5	6	7	8	9	10	11	12/L	13	14	15/LL
NOW																
Zone 1	1153	1196	1262	1305	1348	1413	1479	1542	1601	1680	1753	1839	1926	1999	2085	
Zone 2	1193	1238	1306	1351	1395	1462	1531	1596	1657	1739	1814	1903	1993	2069	2158	
Zone 3	1234	1280	1350	1396	1442	1512	1583	1650	1713	1798	1876	1968	2061	2139	2231	



	Overall	Seat										St. Ydg.	Cu. Ft.	Shp. Wt.	Fr. Cls.	
1554	20" W x 20" D x 18" H	20" W x 20" D x 18" H										1.75	10	41	250	
One-Seat Ottoman		1	2/COM	3/COL	4	5	6	7	8	9	10	11	12/L	13	14	15/LL
NOW																
Zone 1	850	885	930	966	1002	1052	1098	1150	1196	1260	1300	1365	1432	1497	1562	
Zone 2	880	916	963	1000	1037	1089	1136	1190	1238	1304	1346	1413	1482	1549	1617	
Zone 3	910	947	995	1034	1072	1126	1175	1231	1280	1348	1391	1461	1532	1602	1671	



Option	Code	Price
Casters	C	35
Dry Erase Top	DE	223
Tablet Arm	TA	721

	Overall	Seat										St. Ydg.	Cu. Ft.	Shp. Wt.	Fr. Cls.	
1555	20" W x 20" D x 30" H	20" W x 20" D x 30" H										2.5	19	23	300	
One-Seat Ottoman; 30" H		1	2/COM	3/COL	4	5	6	7	8	9	10	11	12/L	13	14	15/LL
NOW																
Zone 1	1027	1071	1135	1180	1222	1287	1352	1416	1476	1554	1627	1713	1799	1872	1959	
Zone 2	1063	1108	1175	1221	1265	1332	1399	1466	1528	1608	1684	1773	1862	1938	2028	
Zone 3	1099	1146	1214	1263	1308	1377	1447	1515	1579	1663	1741	1833	1925	2003	2096	



	Overall	Seat										St. Ydg.	Cu. Ft.	Shp. Wt.	Fr. Cls.	
1560	43" W x 23" D x 18" H	43" W x 20" D x 18" H										2.75	16	26	300	
60 Degree Arc Ottoman		1	2/COM	3/COL	4	5	6	7	8	9	10	11	12/L	13	14	15/LL
NOW																
Zone 1	1153	1202	1272	1321	1367	1439	1512	1582	1645	1733	1813	1907	2003	2083	2177	
Zone 2	1193	1244	1317	1367	1415	1489	1565	1637	1703	1794	1876	1974	2073	2156	2253	
Zone 3	1234	1286	1361	1413	1463	1540	1618	1693	1760	1854	1940	2040	2143	2229	2329	



	Overall	Seat										St. Ydg.	Cu. Ft.	Shp. Wt.	Fr. Cls.	
1572	40" W x 17.3" D x 18" H	40" W x 17.3" D x 18" H										2.5	13	26	300	
Small Trapezoid Ottoman; 18" H		1	2/COM	3/COL	4	5	6	7	8	9	10	11	12/L	13	14	15/LL
NOW																
Zone 1	1285	1327	1394	1436	1480	1543	1609	1674	1732	1812	1884	1969	2057	2128	2215	
Zone 2	1330	1373	1443	1486	1532	1597	1665	1733	1793	1875	1950	2038	2129	2202	2293	
Zone 3	1375	1420	1492	1537	1584	1651	1722	1791	1853	1939	2016	2107	2201	2277	2370	



	Overall	Seat										St. Ydg.	Cu. Ft.	Shp. Wt.	Fr. Cls.	
1573	60" W x 26" D x 18" H	60" W x 26" D x 18" H										3.5	25	69	250	
Large Trapezoid Ottoman; 18" H		1	2/COM	3/COL	4	5	6	7	8	9	10	11	12/L	13	14	15/LL
NOW																
Zone 1	1541	1602	1693	1754	1814	1905	1995	2087	2168	2279	2380	2501	2622	2724	2844	
Zone 2	1595	1658	1752	1815	1877	1972	2065	2160	2244	2359	2463	2589	2714	2819	2944	
Zone 3	1649	1714	1812	1877	1941	2038	2135	2233	2320	2439	2547	2676	2806	2915	3043	



Flex Ottomans

	Overall	Seat										St. Ydg.	Cu. Ft.	Shp. Wt.	Fr. Cls.
1577	40" W x 17.3" D x 30" H	40" W x 17.3" D x 30" H										4	22	60	250

Small Trapezoid Ottoman; 30" H

NOW



	1	2/COM	3/COL	4	5	6	7	8	9	10	11	12/L	13	14	15/LL
Zone 1	1565	1633	1737	1808	1876	1981	2085	2188	2281	2407	2524	2663	2801	2916	3055
Zone 2	1620	1690	1798	1871	1942	2050	2158	2265	2361	2491	2612	2756	2899	3018	3162
Zone 3	1675	1747	1859	1935	2007	2120	2231	2341	2441	2575	2701	2849	2997	3120	3269

	Overall	Seat										St. Ydg.	Cu. Ft.	Shp. Wt.	Fr. Cls.
1578	60" W x 26" D x 30" H	60" W x 26" D x 30" H										5.75	43	108	250

Large Trapezoid Ottoman; 30" H

NOW



	1	2/COM	3/COL	4	5	6	7	8	9	10	11	12/L	13	14	15/LL
Zone 1	1927	2027	2176	2276	2375	2525	2673	2823	2956	3139	3305	3503	3703	3869	4068
Zone 2	1994	2098	2252	2356	2458	2613	2767	2922	3059	3249	3421	3626	3833	4004	4210
Zone 3	2062	2169	2328	2435	2541	2702	2860	3021	3163	3359	3536	3748	3962	4140	4353

	Overall	Seat										St. Ydg.	Cu. Ft.	Shp. Wt.	Fr. Cls.
1580	61" W x 30.5" D x 18" H	61" W x 20" D x 18" H										4.75	28	65	250

180 Degree Half Round Ottoman

NOW



	1	2/COM	3/COL	4	5	6	7	8	9	10	11	12/L	13	14	15/LL
Zone 1	1985	2067	2192	2273	2355	2478	2602	2726	2837	2986	3123	3288	3452	3589	3755
Zone 2	2054	2139	2269	2353	2437	2565	2693	2821	2936	3091	3232	3403	3573	3715	3886
Zone 3	2124	2212	2345	2432	2520	2651	2784	2917	3036	3195	3342	3518	3694	3840	4018

	Overall	Seat										St. Ydg.	Cu. Ft.	Shp. Wt.	Fr. Cls.
1583	16-20.5" W x 16-20.5" D x 24" H	16" W x 16" D x 24" H										2	12	24	250

Tapered Ottoman

NOW



	1	2/COM	3/COL	4	5	6	7	8	9	10	11	12/L	13	14	15/LL
Zone 1	891	930	977	1014	1052	1106	1155	1212	1262	1323	1365	1433	1500	1558	1627
Zone 2	922	963	1011	1049	1089	1145	1195	1254	1306	1369	1413	1483	1553	1613	1684
Zone 3	953	995	1045	1085	1126	1183	1236	1297	1350	1416	1461	1533	1605	1667	1741

	Overall	Seat										St. Ydg.	Cu. Ft.	Shp. Wt.	Fr. Cls.
1584	16-20.5" W x 16-20.5" D x 30" H	15" W x 15" D x 30" H										2	13.1	28	250

Tapered Ottoman

NOW



	1	2/COM	3/COL	4	5	6	7	8	9	10	11	12/L	13	14	15/LL
Zone 1	1035	1077	1136	1183	1225	1294	1355	1421	1480	1554	1589	1739	1769	1797	1824
Zone 2	1071	1115	1176	1224	1268	1339	1402	1471	1532	1608	1645	1800	1831	1860	1888
Zone 3	1107	1152	1216	1266	1311	1385	1450	1520	1584	1663	1700	1861	1893	1923	1952

• Tapered aluminum legs

	Overall	St. Ydg.	Cu. Ft.	Shp. Wt.	Fr. Cls.
UG	2.5" W x 6" D x .25" H	N/A	N/A	N/A	N/A

Universal Ganging Bracket

NOW



Zone 1	60
Zone 2	60
Zone 3	60



Flex Tiered

LOUNGE SEATING - SIN 33721

Comfortable Multi-Level Seating

Flex Tiered Seating makes perimeter space useful. Multiple 2-Tier and 3-Tier options with 2-Tier corner modules may be grouped and re-configured for a variety of seating spaces. Flex is the foundation for spontaneous gatherings. As movable interior architectural elements, the wood Flex Tiered can become a temporary bleacher venue. Wood Flex Tiered can be specified in most standard HPFi wood finishes. Flex Walls add functionality and privacy integrated with Flex Tiered seating. Adding shelves to Flex Walls provide a standing-height work level.

Product Details

- Hardwood frames with reinforcing corner blocks, glued and stapled
- Fully upholstered with double-needle trim on seat, back and arms to reinforce sewing
- Available in textile or coated fabric upholsteries in a single or two-color combination

- Seam slippage/strength minimum 40 lb. rating warp and weft/fill on horizontal surfaces
- Adjustable glides
- Hybrid soy-based, CFC-free foam
- All listed product options must be factory installed

How to Specify:

- 1 Model number
- 2 Wood finish
- 3 Fabric grade & name for seat / tier front
- 4 Fabric grade & name for back & sides (if different)
- 5 Options

Options	Code	Price
Flex Wall Mount-Ready	WM	N/C

Wood Finishes	Code
Black	BLK
Espresso	ESP
Mahogany	MAH
Moab	MOB
Monticello Maple	MM
Natural Maple	FM
Windsor Cherry	WC

Finished Example

2072/FM/9 Stinson Hashtag Lily Pad/2 Culp Linette Platinum

HPFi

220 Flex Tiered - Lounge Seating

1818

Seat Cushion for Wood Tier

NOW



	Overall			Seat										St. Ydg.	Cu. Ft.	Shp. Wt.	Fr. Cls.	
	18" W x 18" D x 0.5" H			18" W x 18" D x 0.5" H										1	1.3	2	300	
	1	2/COM	3/COL	4	5	6	7	8	9	10	11	12/L	13	14	15/LL			
Zone 1	350	367	392	410	428	453	479	505	528	560	588	624	658	687	722			
Zone 2	362	380	406	424	443	469	496	523	546	580	609	646	681	711	747			
Zone 3	375	393	419	439	458	485	513	540	565	599	629	668	704	735	773			

2002

Flex 2 tier seating

NOW



	Overall			Seat										St. Ydg.	Cu. Ft.	Shp. Wt.	Fr. Cls.	
	37" W x 40.5" D x 34.75" H			37" W x 19.75/20.75" D x 17.75/34.75" H										5.5	40	114	250	
	1	2/COM	3/COL	4	5	6	7	8	9	10	11	12/L	13	14	15/LL			
Zone 1	2179	2278	2407	2508	2605	2753	2883	3031	3161	3325	3344	3717	3855	4011	4455			
Zone 2	2255	2358	2491	2596	2696	2849	2984	3137	3272	3441	3461	3847	3990	4151	4611			
Zone 3	2332	2437	2575	2684	2787	2946	3085	3243	3382	3558	3578	3977	4125	4292	4767			

•Fully upholstered

2002-IF

Flex 2 tier seating;
Inside facing corner

NOW



	Overall			Seat										St. Ydg.	Cu. Ft.	Shp. Wt.	Fr. Cls.	
	40.5" W x 40.5" D x 34.75" H			40.5/19.75" W x 19.75/20.75" D x 17.75/34.75" H										7.5	40	127	250	
	1	2/COM	3/COL	4	5	6	7	8	9	10	11	12/L	13	14	15/LL			
Zone 1	2974	3108	3286	3421	3555	3756	3933	4135	4312	4537	4783	5072	5295	5509	6075			
Zone 2	3078	3217	3401	3541	3679	3887	4071	4280	4463	4696	4950	5250	5480	5702	6288			
Zone 3	3182	3326	3516	3660	3804	4019	4208	4424	4614	4855	5118	5427	5666	5895	6500			

•Fully upholstered

2002-OF

Flex 2 tier seating;
Outside facing corner

NOW



	Overall			Seat										St. Ydg.	Cu. Ft.	Shp. Wt.	Fr. Cls.	
	40.5" W x 40.5" D x 34.75" H			40.5/19.75" W x 19.75/20.75" D x 17.75/34.75" H										7.5	40	113	250	
	1	2/COM	3/COL	4	5	6	7	8	9	10	11	12/L	13	14	15/LL			
Zone 1	2974	3108	3286	3421	3555	3756	3933	4135	4312	4537	4783	5072	5295	5509	6075			
Zone 2	3078	3217	3401	3541	3679	3887	4071	4280	4463	4696	4950	5250	5480	5702	6288			
Zone 3	3182	3326	3516	3660	3804	4019	4208	4424	4614	4855	5118	5427	5666	5895	6500			

•Fully upholstered

2003

Flex 3 tier seating

NOW



	Overall			Seat										St. Ydg.	Cu. Ft.	Shp. Wt.	Fr. Cls.	
	37" W x 40.5" D x 34.75" H			37" W x 11.75/18/10.75" D x 10.25/26.25/34.75" H										5.5	40	108	250	
	1	2/COM	3/COL	4	5	6	7	8	9	10	11	12/L	13	14	15/LL			
Zone 1	2365	2461	2593	2692	2790	2938	3069	3216	3346	3510	3664	3902	4041	4195	4639			
Zone 2	2448	2547	2684	2786	2888	3041	3176	3329	3463	3633	3792	4039	4182	4342	4801			
Zone 3	2531	2633	2775	2880	2985	3144	3284	3441	3580	3756	3920	4175	4324	4489	4964			

•Fully upholstered

Flex Tiered

2032-IF

Flex 2 tier; Inside facing;
30 degree wedge

NOW



	Overall				Seat								St. Ydg.	Cu. Ft.	Shp. Wt.	Fr. Cls.
	25.5-46.5" W x 38.5" D x 34.75" H				25.5-46.5" W x 18.5/20" D x 17.75/34.5" H								6	45	125	250
	1	2/COM	3/COL	4	5	6	7	8	9	10	11	12/L	13	14	15/LL	
Zone 1	2878	2991	3141	3253	3367	3536	3687	3857	4007	4195	4365	4648	4710	4897	5494	
Zone 2	2979	3096	3251	3367	3485	3660	3816	3992	4147	4342	4518	4811	4875	5068	5686	
Zone 3	3079	3200	3361	3481	3603	3784	3945	4127	4287	4489	4671	4973	5040	5240	5879	

• Fully upholstered

2032-OF

Flex 2 tier; Outside facing;
30 degree wedge

NOW



	Overall				Seat								St. Ydg.	Cu. Ft.	Shp. Wt.	Fr. Cls.
	25.5-46.5" W x 38.5" D x 34.75" H				25.5-46.5" W x 18.5/20" D x 17.75/34.5" H								6	45	121	250
	1	2/COM	3/COL	4	5	6	7	8	9	10	11	12/L	13	14	15/LL	
Zone 1	2878	2991	3141	3253	3367	3536	3687	3857	4007	4195	4365	4648	4710	4897	5494	
Zone 2	2979	3096	3251	3367	3485	3660	3816	3992	4147	4342	4518	4811	4875	5068	5686	
Zone 3	3079	3200	3361	3481	3603	3784	3945	4127	4287	4489	4671	4973	5040	5240	5879	

• Fully upholstered

2033-IF

Flex 3 tier; Inside facing;
30 degree wedge

NOW



	Overall				Seat								St. Ydg.	Cu. Ft.	Shp. Wt.	Fr. Cls.
	25.5-46.5" W x 38.5" D x 34.75" H				25.5-46.5" W x 11/17.5/10" D x 10.25/26.25" H								6	45	126	250
	1	2/COM	3/COL	4	5	6	7	8	9	10	11	12/L	13	14	15/LL	
Zone 1	3060	3173	3325	3437	3550	3720	3869	4040	4189	4379	4477	4682	4888	5058	5263	
Zone 2	3167	3284	3441	3557	3674	3850	4004	4181	4336	4532	4634	4846	5059	5235	5447	
Zone 3	3274	3395	3558	3678	3799	3980	4140	4323	4482	4686	4790	5010	5230	5412	5631	

• Fully upholstered

2033-OF

Flex 3 tier; Outside facing;
30 degree wedge

NOW



	Overall				Seat								St. Ydg.	Cu. Ft.	Shp. Wt.	Fr. Cls.
	25.5-46.5" W x 38.5" D x 34.75" H				25.5-47" W x 2.5/18/10.5" D x 11/27/35" H								6	45	123	250
	1	2/COM	3/COL	4	5	6	7	8	9	10	11	12/L	13	14	15/LL	
Zone 1	3060	3173	3325	3437	3550	3720	3869	4040	4189	4379	4477	4682	4888	5058	5263	
Zone 2	3167	3284	3441	3557	3674	3850	4004	4181	4336	4532	4634	4846	5059	5235	5447	
Zone 3	3274	3395	3558	3678	3799	3980	4140	4323	4482	4686	4790	5010	5230	5412	5631	

• Fully upholstered

2072

Flex 2 tier



	Overall				Seat								St. Ydg.	Cu. Ft.	Shp. Wt.	Fr. Cls.
	37" W x 40.5" D x 34.75" H				37" W x 19.75/20.75" D x 17.75/34.75" H								5.5	40	123	250
	1	2/COM	3/COL	4	5	6	7	8	9	10	11	12/L	13	14	15/LL	
Zone 1	2201	2291	2427	2518	2610	2746	2882	3019	3140	3306	3458	3640	3821	3973	4155	
Zone 2	2278	2371	2512	2606	2701	2842	2983	3125	3250	3422	3579	3767	3955	4112	4300	
Zone 3	2355	2451	2597	2694	2793	2938	3084	3230	3360	3537	3700	3895	4088	4251	4446	

• Upholstered sides/back • Wood steps

Flex Tiered

2073 Flex 3 tiered seating



Overall	Seat															St. Ydg.	Cu. Ft.	Shp. Wt.	Fr. Cls.
37" W x 40.5" D x 34.75" H	37" W x 11.75/18/10.75" D x 10.25/26.25/34.75" H															5.25	40	108	250
	1	2/COM	3/COL	4	5	6	7	8	9	10	11	12/L	13	14	15/LL				
Zone 1	2388	2478	2615	2706	2796	2933	3070	3207	3327	3494	3645	3828	4009	4162	4343				
Zone 2	2472	2565	2707	2801	2894	3036	3177	3319	3443	3616	3773	3962	4149	4308	4495				
Zone 3	2555	2651	2798	2895	2992	3138	3285	3431	3560	3739	3900	4096	4290	4453	4647				

- Upholstered sides/back
- Wood steps

2082 Flex 2 tiered seating

Now



Overall	Seat															St. Ydg.	Cu. Ft.	Shp. Wt.	Fr. Cls.
37" W x 40.5" D x 34.75" H	37" W x 19.75/20.75" D x 17.75/34.75" H															N/A	40	114	250
Zone 1	2300																		
Zone 2	2381																		
Zone 3	2461																		

- All wood

2083 Flex 3 tiered seating



Overall	Seat															St. Ydg.	Cu. Ft.	Shp. Wt.	Fr. Cls.
37" W x 40.5" D x 34.75" H	37" W x 11.75/18/10.75" D x 10.25/26.25/34.75" H															N/A	40	108	250
Zone 1	2499																		
Zone 2	2586																		
Zone 3	2674																		

- All wood

2091 Flex Wall

Now



Overall	Seat															St. Ydg.	Cu. Ft.	Shp. Wt.	Fr. Cls.
40.5" W x 10" D x 48" H																4	27	86	250
	1	2/COM	3/COL	4	5	6	7	8	9	10	11	12/L	13	14	15/LL				
Zone 1	1460	1544	1674	1760	1845	1974	2102	2231	2345	2504	2646	2817	2987	3132	3303				
Zone 2	1511	1598	1733	1822	1910	2043	2176	2309	2427	2592	2739	2916	3092	3242	3419				
Zone 3	1562	1652	1791	1883	1974	2112	2249	2387	2509	2679	2831	3014	3196	3351	3534				

- Fully upholstered
- Attaches to 2002-IF
- Must add "WM" suffix to the adjoining 2002-IF Tier unit

BS91 Laminate shelf

Now



Overall	Seat															St. Ydg.	Cu. Ft.	Shp. Wt.	Fr. Cls.
40.5" W x 10" D x 1" H																N/A	N/A	N/A	N/A
Zone 1	759																		
Zone 2	786																		
Zone 3	812																		

- Not available in MOB
- Installed 42" H from floor standard; attaches to 2091 Flex Wall

Flex Tiered

Overall		St. Ydg.	Cu. Ft.	Shp. Wt.	Fr. Cls.										
2092 Flex Wall		37" W x 10" D x 48" H	4	27	83	250									
	1	2/COM	3/COL	4	5	6	7	8	9	10	11	12/L	13	14	15/LL
Zone 1	1460	1544	1674	1760	1845	1974	2102	2231	2345	2504	2646	2817	2987	3132	3303
Zone 2	1511	1598	1733	1822	1910	2043	2176	2309	2427	2592	2739	2916	3092	3242	3419
Zone 3	1562	1652	1791	1883	1974	2112	2249	2387	2509	2679	2831	3014	3196	3351	3534

• Fully upholstered
 • Attaches to straight 2 or 3 tier
 • Must add "WM" suffix to the adjoining tier unit



Overall		St. Ydg.	Cu. Ft.	Shp. Wt.	Fr. Cls.	
BS92 Laminate shelf		37" W x 10" D x 1" H	N/A	N/A	N/A	N/A
Zone 1	759	• Not available in MOB		• Installed 42" H from floor standard; attaches to 2092 Flex Wall		
Zone 2	786					
Zone 3	812					



Overall		St. Ydg.	Cu. Ft.	Shp. Wt.	Fr. Cls.										
2093-IF Flex Wall		46.5" - 51.5" W x 10" D x 48" H	4	27	83	250									
	1	2/COM	3/COL	4	5	6	7	8	9	10	11	12/L	13	14	15/LL
Zone 1	1460	1544	1674	1760	1845	1974	2102	2231	2345	2504	2646	2817	2987	3132	3303
Zone 2	1511	1598	1733	1822	1910	2043	2176	2309	2427	2592	2739	2916	3092	3242	3419
Zone 3	1562	1652	1791	1883	1974	2112	2249	2387	2509	2679	2831	3014	3196	3351	3534

• Fully upholstered
 • Attaches to 2 or 3 tier inside facing wedge
 • Must add "WM" suffix to the adjoining tier unit



Overall		St. Ydg.	Cu. Ft.	Shp. Wt.	Fr. Cls.	
BS93-IF Laminate shelf		55" W x 9.7" D x 1" H	N/A	N/A	N/A	N/A
Zone 1	759	• Not available in MOB		• Installed 42" H from floor standard; attaches to 2093-IF Flex Wall only		
Zone 2	786					
Zone 3	812					



Overall		Seat		St. Ydg.	Cu. Ft.	Shp. Wt.	Fr. Cls.								
2102 Flex 2 tier		37" W x 40.5" D x 34.75" H	37" W x 19.75/20.75" D x 17.75/34.75" H	5.5	41	135	200								
	1	2/COM	3/COL	4	5	6	7	8	9	10	11	12/L	13	14	15/LL
Zone 1	2745	2845	2976	3076	3174	3324	3455	3605	3737	3901	4099	4297	4495	4693	4891
Zone 2	2841	2945	3080	3184	3285	3440	3576	3731	3868	4038	4242	4447	4652	4857	5062
Zone 3	2937	3044	3184	3291	3396	3557	3697	3857	3999	4174	4386	4598	4810	5022	5233

• Tier 1 Cubby 29.75" W x 14" D x 10.5" H
 • Specify wood finish for cubby
 • Fully Upholstered



Overall		Seat		St. Ydg.	Cu. Ft.	Shp. Wt.	Fr. Cls.								
2172 Flex 2 tier		37" W x 40.5" D x 34.75" H	37" W x 19.75/20.75" D x 17.75/34.75" H	5.25	41	135	200								
	1	2/COM	3/COL	4	5	6	7	8	9	10	11	12/L	13	14	15/LL
Zone 1	2804	2882	2999	3076	3154	3271	3388	3504	3608	3752	3882	4036	4192	4324	4480
Zone 2	2902	2983	3104	3184	3264	3385	3507	3627	3734	3883	4018	4177	4339	4475	4637
Zone 3	3000	3084	3209	3291	3375	3500	3625	3749	3861	4015	4154	4319	4485	4627	4794

• Tier 1 Cubby 29.75" W x 14" D x 10.5" H
 • Specify wood finish for cubby and steps
 • Upholstered back/sides with wood steps



	Overall	Seat	St. Ydg.	Cu. Ft.	Shp. Wt.	Fr. Cls.
2182	37" W x 40.5" D x 34.75" H	37" W x 19.75/20.75" D x 17.75/34.75" H	N/A	40	135	250

Flex 2 tier



Zone 1	2915
Zone 2	3017
Zone 3	3119

- Tier 1 Cubby 29.75" W x 14" D x 10.5" H
- All wood

	Overall	Seat	St. Ydg.	Cu. Ft.	Shp. Wt.	Fr. Cls.
2372-IF	25.5-46.5" W x 38.5" D x 34.75" H	25.5-46.5" W x 18.5/20" D x 17.75/34.75" H	5.5	45	125	250

Flex 2 tier; Inside facing;
30 degree wedge



	1	2/COM	3/COL	4	5	6	7	8	9	10	11	12/L	13	14	15/LL
Zone 1	2904	3001	3143	3239	3334	3478	3620	3763	3890	4064	4223	4414	4604	4764	4953
Zone 2	3006	3106	3253	3352	3451	3600	3747	3895	4026	4206	4371	4568	4765	4931	5126
Zone 3	3107	3211	3363	3466	3567	3721	3873	4026	4162	4348	4519	4723	4926	5097	5300

- Upholstered back/sides
- Wood steps

	Overall	Seat	St. Ydg.	Cu. Ft.	Shp. Wt.	Fr. Cls.
2372-OF	25.5-46.5" W x 38.5" D x 34.75" H	25.5-46.5" W x 18.5/20" D x 17.75/34.75" H	5.25	45	121	250

Flex 2 tier; Outside facing;
30 degree wedge



	1	2/COM	3/COL	4	5	6	7	8	9	10	11	12/L	13	14	15/LL
Zone 1	2904	3001	3143	3239	3334	3478	3620	3763	3890	4064	4223	4414	4604	4764	4953
Zone 2	3006	3106	3253	3352	3451	3600	3747	3895	4026	4206	4371	4568	4765	4931	5126
Zone 3	3107	3211	3363	3466	3567	3721	3873	4026	4162	4348	4519	4723	4926	5097	5300

- Upholstered back/sides
- Wood steps

	Overall	Seat	St. Ydg.	Cu. Ft.	Shp. Wt.	Fr. Cls.
2373-IF	25.5-46.5" W x 38.5" D x 34.75" H	25.5-46.5" W x 11/17.5/10" D x 10.25/26.25/34.75" H	5.5	45	126	250

Flex 3 tier; Inside facing;
30 degree wedge



	1	2/COM	3/COL	4	5	6	7	8	9	10	11	12/L	13	14	15/LL
Zone 1	3090	3185	3328	3423	3519	3661	3803	3947	4074	4248	4407	4598	4789	4948	5138
Zone 2	3198	3296	3444	3543	3642	3789	3936	4085	4217	4397	4561	4759	4957	5121	5318
Zone 3	3306	3408	3561	3663	3765	3917	4069	4223	4359	4545	4715	4920	5124	5294	5498

- Upholstered back/sides
- Wood steps

	Overall	Seat	St. Ydg.	Cu. Ft.	Shp. Wt.	Fr. Cls.
2373-OF	25.5-46.5" W x 38.5" D x 34.75" H	25.5-47" W x 12.5/18/10.5" D x 11/27/34.75" H	6	45	123	250

Flex 3 tier; Outside facing;
30 degree wedge



	1	2/COM	3/COL	4	5	6	7	8	9	10	11	12/L	13	14	15/LL
Zone 1	3090	3185	3328	3423	3519	3661	3803	3947	4074	4248	4407	4598	4789	4948	5138
Zone 2	3198	3296	3444	3543	3642	3789	3936	4085	4217	4397	4561	4759	4957	5121	5318
Zone 3	3306	3408	3561	3663	3765	3917	4069	4223	4359	4545	4715	4920	5124	5294	5498

- Upholstered back/sides
- Wood steps



Genesis

LOUNGE SEATING - SIN 33721

Mobile. Versatile. Comfortable.

Combining the comfort of lounge seating with the high functionality of team seating, Genesis Team Seating is a new alternative for innovative environments. Open and smooth-gliding drawer for storage options. Available in two widths to accommodate "oversized" occupants. The standard peanut-shaped tablet is non-handed and may be placed on either arm (without tools!) to accommodate left- or right-handed occupants.

Product Details

- Dual-wheel, easy-rolling casters for mobility
- Unique 360-degree revolving peanut-shaped tablet for note-taking or laptop support
- Tablet easily relocates on left or right arm
- Storage compartment under seat
- Standard black finish arms and tablet
- Fabric combinations available with seat and back differing from arm panels
- Hardwood frames are glued, screwed and stapled

- Reinforcing corner blocks are glued and stapled
- Frame components are double-doweled, glued, stapled and screwed
- Metal-to-metal connection of arms, seat and back ensures long-term durability
- Hybrid soy-based, CFC-free foam
- All listed product options must be factory installed

How to Specify:

- 1 Model number
- 2 Wood finish
- 3 Fabric grade & name for seat & back
- 4 Fabric grade & name for arms (if different)
- 5 Options

Options	Code	Price
Self Locking Casters	S	111
Braking Casters	B	38
Cup Holder	CH	270
Document Holder	DH	254
Tablet/Laptop Holder	NH	122

Leg Finishes	Code
Black	BLK
Boardwalk	BW
Driftwood	DW
Espresso	ESP
Mahogany	MAH
Moab	MOB
Monticello Maple	MM
Natural Maple	FM
Shoreline	SL
Windsor Cherry	WC

Finished Example

1727/FM/4 Momentum Lens Navy/5 Momentum Cover Cloth Delft/S

1727 Mobile Teaming Chair

Now



	Overall		Seat										St. Ydg.	Cu. Ft.	Shp. Wt.	Fr. Cls.
	27" W x 26" D x 31.25" H		21" W x 20" D x 18.5" H										4.75	19	84	175
	1	2/COM	3/COL	4	5	6	7	8	9	10	11	12/L	13	14	15/LL	
Zone 1	2414	2536	2677	2801	2922	3082	3148	3410	3573	3776	3884	4034	4186	4336	4663	
Zone 2	2498	2625	2771	2899	3024	3190	3258	3529	3698	3908	4020	4175	4333	4488	4826	
Zone 3	2583	2714	2864	2997	3127	3298	3368	3649	3823	4040	4156	4316	4479	4640	4989	

- Black arms, tablet and shelf

1727D Mobile Teaming Chair; Storage Drawer

Now



	Overall		Seat										St. Ydg.	Cu. Ft.	Shp. Wt.	Fr. Cls.
	27" W x 26" D x 31.25" H		21" W x 20" D x 18.5" H										4.75	19.1	92	175
	1	2/COM	3/COL	4	5	6	7	8	9	10	11	12/L	13	14	15/LL	
Zone 1	2662	2785	2925	3046	3169	3333	3393	3657	3820	4023	4131	4281	4433	4582	4903	
Zone 2	2755	2882	3027	3153	3280	3450	3512	3785	3954	4164	4276	4431	4588	4742	5075	
Zone 3	2848	2980	3130	3259	3391	3566	3631	3913	4087	4305	4420	4581	4743	4903	5246	

- Black arms and tablet

1737 Mobile Teaming Chair

Now



	Overall		Seat										St. Ydg.	Cu. Ft.	Shp. Wt.	Fr. Cls.
	27" W x 26" D x 31.25" H		21" W x 20" D x 18.5" H										4.75	19	81	175
	1	2/COM	3/COL	4	5	6	7	8	9	10	11	12/L	13	14	15/LL	
Zone 1	2665	2787	2927	3050	3172	3335	3395	3659	3822	4027	4134	4285	4436	4587	4905	
Zone 2	2758	2885	3029	3157	3283	3452	3514	3787	3956	4168	4279	4435	4591	4748	5077	
Zone 3	2852	2982	3132	3264	3394	3568	3633	3915	4090	4309	4423	4585	4747	4908	5248	

- Wood finish arms, tablet and shelf

1737D Mobile Teaming Chair; Storage Drawer

Now



	Overall		Seat										St. Ydg.	Cu. Ft.	Shp. Wt.	Fr. Cls.
	27" W x 26" D x 31.25" H		21" W x 20" D x 18.5" H										9.5	19.1	92	175
	1	2/COM	3/COL	4	5	6	7	8	9	10	11	12/L	13	14	15/LL	
Zone 1	2921	3042	3186	3307	3429	3590	3654	3917	4081	4282	4393	4543	4694	4845	5153	
Zone 2	3023	3148	3298	3423	3549	3716	3782	4054	4224	4432	4547	4702	4858	5015	5333	
Zone 3	3125	3255	3409	3538	3669	3841	3910	4191	4367	4582	4701	4861	5023	5184	5514	

- Wood finish arms and tablet

Genesis

1747

Mobile Bariatric Width Teaming Chair

NOW



	Overall			Seat											St. Ydg.	Cu. Ft.	Shp. Wt.	Fr. Cls.
	30" W x 26" D x 35.75" H			24" W x 20" D x 18.5" H											5.25	19	88	175
	1	2/COM	3/COL	4	5	6	7	8	9	10	11	12/L	13	14	15/LL			
Zone 1	2670	2774	2899	3003	3110	3252	3392	3532	3675	3852	3990	4156	4296	4463	4789			
Zone 2	2763	2871	3000	3108	3219	3366	3511	3656	3804	3987	4130	4301	4446	4619	4957			
Zone 3	2857	2968	3102	3213	3328	3480	3629	3779	3932	4122	4269	4447	4597	4775	5124			

- Black arms, tablet and shelf

1757

Mobile Bariatric Width Teaming Chair

NOW



	Overall			Seat											St. Ydg.	Cu. Ft.	Shp. Wt.	Fr. Cls.
	30" W x 26" D x 35.75" H			24" W x 20" D x 18.5" H											5.25	20	85	175
	1	2/COM	3/COL	4	5	6	7	8	9	10	11	12/L	13	14	15/LL			
Zone 1	2945	3052	3177	3279	3386	3528	3669	3809	3951	4128	4264	4432	4571	4737	5054			
Zone 2	3048	3159	3288	3394	3505	3651	3797	3942	4089	4272	4413	4587	4731	4903	5231			
Zone 3	3151	3266	3399	3509	3623	3775	3926	4076	4228	4417	4562	4742	4891	5069	5408			

- Wood arms, tablet and shelf

Accessories & Options

CH

Cup Holder

now

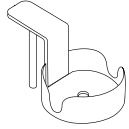

Cu. Ft. Shp. Wt. Fr. Cls.

0.3 1 70

Overall

4" W x 7" D x 3" H

Zone 1	270
Zone 2	270
Zone 3	270

Cu. Ft. Shp. Wt. Fr. Cls.

0.4 3 70

DH

Document Holder

now

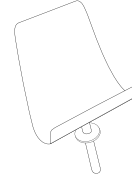

Overall

9.75" W x 3" D x 10.5" H

Zone 1	254
Zone 2	254
Zone 3	254

NH

Tablet/Laptop Holder

now

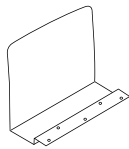

Cu. Ft. Shp. Wt. Fr. Cls.

0.9 5 70

Overall

14" W x 7" D x 11.5" H

Zone 1	122
Zone 2	122
Zone 3	122



Himalaya

LOUNGE SEATING - SIN 33721

Metropolitan Style

Himalaya reception, executive and guest seating presents unique, contemporary solutions for every area of a commercial environment. From lobbies and lounges to conference rooms and private offices, Himalaya offers a consistent, metropolitan style in a design based on modern classics. Craftsmen carefully hand-pull and hand-tie reliefs in leather, vinyl or fabric upholstery to create the multiple mini-cushioned design of Himalaya. Square forms and square stitch pattern accent this offering. Available without arms or with curved, tapered arms.

Product Details

- Taut seat, no-sag springs
- High density foam adds comfort
- Commercial-grade engineered hardwood frame
- Frame components with reinforcing corner blocks are glued and stapled
- Arms are custom fabricated and wrapped with foam and fiber for comfort
- Metal-to-metal connection of arms, seat and back ensures long-term durability

- Double needle seam stitches
- Full square pattern relief (seat and back) stitching standard
- Two-color combinations available
- Wood finish with non-marring floor glides or brushed aluminum legs
- Hybrid soy-based, CFC-free foam
- All listed product options must be factory installed

How to Specify:

- 1 Model number
- 2 Wood finish (where applicable)
- 3 Fabric grade & name for back
- 4 Fabric grade & name for seat (if different)
- 5 Options

Options	Code	Price
Back relief stitching only	SB	N/C
No relief stitching	SN	N/C
Softer Seat Foam - Chair	SF	22
Softer Seat Foam - Loveseat	SF	44
Softer Seat Foam - Sofa	SF	66

Leg Finishes	Code
Black	BLK
Boardwalk	BW
Driftwood	DW
Espresso	ESP
Mahogany	MAH
Moab	MOB
Monticello Maple	MM
Natural Maple	FM
Shoreline	SL
Windsor Cherry	WC

Finished Example

151/FM/5 Momentum Toggle Ink/3 Stinson Staple Camel

Wood

143

Wood Arm Side Chair

NOW



	Overall			Seat								St. Ydg.	Cu. Ft.	Shp. Wt.	Fr. Cls.
	22.75" W x 26" D x 33.5" H			19" W x 18" D x 19" H								1.75	15	27	300
	1	2/COM	3/COL	4	5	6	7	8	9	10	11	12/L	13	14	15/LL
Zone 1	1386	1498	1596	1635	1712	1742	1872	1949	2049	2238	2298	2360	2420	2480	2542
Zone 2	1435	1550	1652	1692	1772	1803	1938	2017	2121	2316	2378	2443	2505	2567	2631
Zone 3	1483	1603	1708	1749	1832	1864	2003	2085	2192	2395	2459	2525	2589	2654	2720

•Wood legs

144

Armless Wood Side Chair

NOW



	Overall			Seat								St. Ydg.	Cu. Ft.	Shp. Wt.	Fr. Cls.
	19.5" W x 26" D x 33.5" H			19" W x 18" D x 19" H								1.75	15	27	300
	1	2/COM	3/COL	4	5	6	7	8	9	10	11	12/L	13	14	15/LL
Zone 1	1331	1391	1538	1582	1660	1692	1817	1897	1995	2184	2226	2286	2348	2408	2470
Zone 2	1378	1440	1592	1637	1718	1751	1881	1963	2065	2260	2304	2366	2430	2492	2556
Zone 3	1424	1488	1646	1693	1776	1810	1944	2030	2135	2337	2382	2446	2512	2577	2643

•Wood legs

151

Club Chair

NOW



	Overall			Seat								St. Ydg.	Cu. Ft.	Shp. Wt.	Fr. Cls.
	32" W x 31" D x 30" H			24" W x 21.5" D x 18.5" H								6.25	29	85	250
	1	2/COM	3/COL	4	5	6	7	8	9	10	11	12/L	13	14	15/LL
Zone 1	2547	2823	3075	3241	3463	3548	3903	4128	4404	4931	5091	5308	5524	5741	5957
Zone 2	2636	2922	3183	3354	3584	3672	4040	4272	4558	5104	5269	5494	5717	5942	6165
Zone 3	2725	3021	3290	3468	3705	3796	4176	4417	4712	5276	5447	5680	5911	6143	6374

•Wood legs

152

Loveseat

NOW



	Overall			Seat								St. Ydg.	Cu. Ft.	Shp. Wt.	Fr. Cls.
	56.5" W x 31" D x 30" H			49" W x 21.5" D x 18.5" H								9.5	41.1	117	250
	1	2/COM	3/COL	4	5	6	7	8	9	10	11	12/L	13	14	15/LL
Zone 1	3690	4242	4741	5027	5455	5622	6311	6739	7275	8290	8545	8874	9204	9533	9862
Zone 2	3819	4390	4907	5203	5646	5819	6532	6975	7530	8580	8844	9185	9526	9867	10207
Zone 3	3948	4539	5073	5379	5837	6016	6753	7211	7784	8870	9143	9495	9848	10200	10552

•Wood legs

153

Sofa

NOW

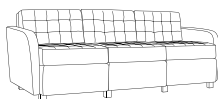

	Overall			Seat								St. Ydg.	Cu. Ft.	Shp. Wt.	Fr. Cls.
	81" W x 31" D x 30" H			73" W x 21.5" D x 18.5" H								13	56	167	250
	1	2/COM	3/COL	4	5	6	7	8	9	10	11	12/L	13	14	15/LL
Zone 1	4700	5455	6149	6504	7084	7308	8239	8818	9540	10915	11342	11791	12242	12694	13026
Zone 2	4865	5646	6364	6732	7332	7564	8527	9127	9874	11297	11739	12204	12670	13138	13482
Zone 3	5029	5837	6579	6959	7580	7820	8816	9435	10208	11679	12136	12616	13099	13583	13938

•Wood legs

Himalaya

154

Armless Chair

NOW



	Overall			Seat								St. Ydg.	Cu. Ft.	Shp. Wt.	Fr. Cls.
	25" W x 31" D x 30" H			24.5" W x 21.5" D x 18.5" H								4	29	55	300
	1	2/COM	3/COL	4	5	6	7	8	9	10	11	12/L	13	14	15/LL
Zone 1	2232	2408	2566	2654	2789	2843	3058	3193	3361	3681	3861	3998	4137	4276	4415
Zone 2	2310	2492	2656	2747	2887	2943	3165	3305	3479	3810	3996	4138	4282	4426	4570
Zone 3	2388	2577	2746	2840	2984	3042	3272	3417	3596	3939	4131	4278	4427	4575	4724

•Wood legs

155

Armless Loveseat

NOW

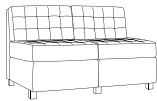

	Overall			Seat								St. Ydg.	Cu. Ft.	Shp. Wt.	Fr. Cls.
	50" W x 31" D x 30" H			49" W x 21.5" D x 18.5" H								7	41.1	90	250
	1	2/COM	3/COL	4	5	6	7	8	9	10	11	12/L	13	14	15/LL
Zone 1	3270	3645	3971	4111	4381	4485	4921	5191	5527	6165	6361	6604	6844	7088	7330
Zone 2	3384	3773	4110	4255	4534	4642	5093	5373	5720	6381	6584	6835	7084	7336	7587
Zone 3	3499	3900	4249	4399	4688	4799	5265	5554	5914	6597	6806	7066	7323	7584	7843

•Wood legs

156

Armless Sofa

NOW

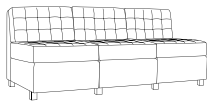

	Overall			Seat								St. Ydg.	Cu. Ft.	Shp. Wt.	Fr. Cls.
	74" W x 31" D x 30" H			73" W x 21.5" D x 18.5" H								10.5	55	130	250
	1	2/COM	3/COL	4	5	6	7	8	9	10	11	12/L	13	14	15/LL
Zone 1	4162	4725	5214	5422	5826	5982	6637	7037	7542	8503	8799	9162	9526	9890	10019
Zone 2	4308	4890	5396	5612	6030	6191	6869	7283	7806	8801	9107	9483	9859	10236	10370
Zone 3	4453	5056	5579	5802	6234	6401	7102	7530	8070	9098	9415	9803	10193	10582	10720

•Wood legs

157

Two-seat, 4' Bench

NOW

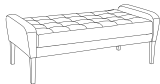

	Overall			Seat								St. Ydg.	Cu. Ft.	Shp. Wt.	Fr. Cls.
	48" W x 18" D x 19.25" H			43" W x 17.5" D x 18" H								3	13	43	250
	1	2/COM	3/COL	4	5	6	7	8	9	10	11	12/L	13	14	15/LL
Zone 1	1946	2007	2098	2208	2292	2390	2445	2625	2734	2875	2958	3062	3167	3271	3374
Zone 2	2014	2077	2171	2285	2372	2474	2531	2717	2830	2976	3062	3169	3278	3385	3492
Zone 3	2082	2147	2245	2363	2452	2557	2616	2809	2925	3076	3165	3276	3389	3500	3610

•Wood legs

158

Three-seat, 6' Bench

NOW

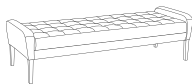

	Overall			Seat								St. Ydg.	Cu. Ft.	Shp. Wt.	Fr. Cls.
	72" W x 24" D x 19.25" H			64" W x 23.5" D x 18" H								4	27.1	75	150
	1	2/COM	3/COL	4	5	6	7	8	9	10	11	12/L	13	14	15/LL
Zone 1	2480	2560	2682	2823	2952	3086	3159	3403	3552	3742	3970	4109	4246	4385	4524
Zone 2	2567	2650	2776	2922	3055	3194	3270	3522	3676	3873	4109	4253	4395	4538	4682
Zone 3	2654	2739	2870	3021	3159	3302	3380	3641	3801	4004	4248	4397	4543	4692	4841

•Wood legs

Metal

	Overall			Seat								St. Ydg.	Cu. Ft.	Shp. Wt.	Fr. Cls.
151MET Club Chair	32" W x 31" D x 31.5" H			24" W x 21.5" D x 19.5" H								6.25	30	107	250
NOW	1	2/COM	3/COL	4	5	6	7	8	9	10	11	12/L	13	14	15/LL
Zone 1	2674	2965	3228	3405	3637	3725	4099	4334	4625	5179	5346	5572	5799	6028	6255
Zone 2	2768	3069	3341	3524	3764	3855	4242	4486	4787	5360	5533	5767	6002	6239	6474
Zone 3	2861	3173	3454	3643	3892	3986	4386	4637	4949	5542	5720	5962	6205	6450	6693



•Metal legs

	Overall			Seat								St. Ydg.	Cu. Ft.	Shp. Wt.	Fr. Cls.
152MET Loveseat	56.5" W x 31" D x 31.5" H			49" W x 21.5" D x 19.5" H								9.5	57	128	250
NOW	1	2/COM	3/COL	4	5	6	7	8	9	10	11	12/L	13	14	15/LL
Zone 1	3875	4455	4980	5280	5729	5902	6625	7076	7637	8703	8972	9317	9664	10010	10356
Zone 2	4011	4611	5154	5465	5930	6109	6857	7324	7904	9008	9286	9643	10002	10360	10718
Zone 3	4146	4767	5329	5650	6130	6315	7089	7571	8172	9312	9600	9969	10340	10711	11081



•Metal legs

	Overall			Seat								St. Ydg.	Cu. Ft.	Shp. Wt.	Fr. Cls.
153MET Sofa	81" W x 31" D x 31.5" H			73" W x 21.5" D x 19.5" H								13	75	185	250
NOW	1	2/COM	3/COL	4	5	6	7	8	9	10	11	12/L	13	14	15/LL
Zone 1	4933	5729	6458	6831	7438	7672	8652	9259	10017	11460	11909	12381	12854	13327	13677
Zone 2	5106	5930	6684	7070	7698	7941	8955	9583	10368	11861	12326	12814	13304	13793	14156
Zone 3	5278	6130	6910	7309	7959	8209	9258	9907	10718	12262	12743	13248	13754	14260	14634

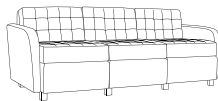

•Metal legs

	Overall			Seat								St. Ydg.	Cu. Ft.	Shp. Wt.	Fr. Cls.
154MET Armless Chair	25" W x 31" D x 31.5" H			24.5" W x 21.5" D x 19.5" H								4	25	64	250
NOW	1	2/COM	3/COL	4	5	6	7	8	9	10	11	12/L	13	14	15/LL
Zone 1	2344	2530	2697	2788	2928	2983	3213	3352	3529	3865	4053	4199	4345	4489	4635
Zone 2	2426	2619	2791	2886	3030	3087	3325	3469	3653	4000	4195	4346	4497	4646	4797
Zone 3	2508	2707	2886	2983	3133	3192	3438	3587	3776	4136	4337	4493	4649	4803	4959



•Metal legs

	Overall			Seat								St. Ydg.	Cu. Ft.	Shp. Wt.	Fr. Cls.
155MET Armless Loveseat	50" W x 31" D x 31.5" H			49" W x 21.5" D x 19.5" H								7	41	97	250
NOW	1	2/COM	3/COL	4	5	6	7	8	9	10	11	12/L	13	14	15/LL
Zone 1	3432	3830	4168	4317	4600	4710	5165	5449	5802	6472	6678	6935	7188	7442	7697
Zone 2	3552	3964	4314	4468	4761	4875	5346	5640	6005	6699	6912	7178	7440	7702	7966
Zone 3	3672	4098	4460	4619	4922	5040	5527	5830	6208	6925	7145	7420	7691	7963	8236

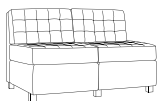

•Metal legs

	Overall			Seat								St. Ydg.	Cu. Ft.	Shp. Wt.	Fr. Cls.
156MET Armless Sofa	74" W x 31" D x 31.5" H			73" W x 21.5" D x 19.5" H								10.5	55	130	250
NOW	1	2/COM	3/COL	4	5	6	7	8	9	10	11	12/L	13	14	15/LL
Zone 1	4369	4962	5474	5694	6118	6283	6968	7391	7920	8927	9239	9621	10002	10384	10521
Zone 2	4522	5136	5666	5893	6332	6503	7212	7650	8197	9239	9562	9958	10352	10747	10889
Zone 3	4675	5309	5857	6093	6546	6723	7456	7908	8474	9552	9886	10294	10702	11111	11257

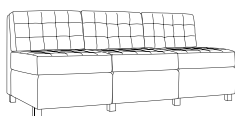

•Metal legs



Kimberly

LOUNGE SEATING - SIN 33721

Sophisticated Form

Kimberly blends sophisticated form with careful attention to detail. Soft arm pleats and welted design lines present an elegant, fully upholstered reception seating solution that also includes occasional tables. Elegant double-needle tailoring, taut seat, no-sag springs and high-density foam ensure long-term comfort and durability.

Product Details

- Taut seat, no-sag springs
- High density foam adds comfort
- Stitching between seat/back cushions when required by fabric application
- Commercial-grade engineered hardwood frame
- Frame components with reinforcing corner blocks are glued and stapled
- Arms are custom fabricated and wrapped with foam and fiber for comfort

- Metal-to-metal connection of arms, seat and back ensures long-term durability
- Wood finish legs with non-marring floor glides
- Two-color combinations available
- Hybrid soy-based, CFC-free foam
- All listed product options must be factory installed

How to Specify:

- 1 Model number
- 2 Wood finish
- 3 Fabric grade & name for back & seat
- 4 Fabric grade & name for arms (if different)
- 5 Options

Finished Example

6401/FM/5 Stinson Charlotte Lapix/SF

Options	Code	Price
BAM Foot	BAM	67
Softer Seat Foam - Chair	SF	22
Softer Seat Foam - Loveseat	SF	44
Softer Seat Foam - Sofa	SF	66

Leg Finishes	Code
Black	BLK
Boardwalk	BW
Driftwood	DW
Espresso	ESP
Mahogany	MAH
Moab	MOB
Monticello Maple	MM
Natural Maple	FM
Shoreline	SL
Windsor Cherry	WC

6401

Camel back lounge chair

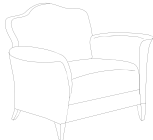

	Overall		Seat										St. Ydg.	Cu. Ft.	Shp. Wt.	Fr. Cls.
	37.5" W x 32.5" D x 35" H		22.5" W x 22" D x 19" H										6.25	31	75	250
	1	2/COM	3/COL	4	5	6	7	8	9	10	11	12/L	13	14	15/LL	
Zone 1	2762	3064	3334	3503	3743	3834	4218	4600	4895	5370	5523	5740	5956	6172	6232	
Zone 2	2859	3171	3451	3626	3874	3968	4366	4761	5066	5558	5716	5941	6164	6388	6450	
Zone 3	2955	3278	3567	3748	4005	4102	4513	4922	5238	5746	5910	6142	6373	6604	6668	

• Weltd, flared arms with soft pleats

6402

Camel back loveseat



	Overall		Seat										St. Ydg.	Cu. Ft.	Shp. Wt.	Fr. Cls.
	58" W x 32.5" D x 35" H		43.5" W x 22" D x 19" H										8	60	116	250
	1	2/COM	3/COL	4	5	6	7	8	9	10	11	12/L	13	14	15/LL	
Zone 1	3641	4016	4336	4505	4783	4890	5338	5616	5961	6329	6620	6896	7174	7452	7728	
Zone 2	3768	4157	4488	4663	4950	5061	5525	5813	6170	6551	6852	7137	7425	7713	7998	
Zone 3	3896	4297	4640	4820	5118	5232	5712	6009	6378	6772	7083	7379	7676	7974	8269	

• Weltd, flared arms with soft pleats

6403

Camel back sofa

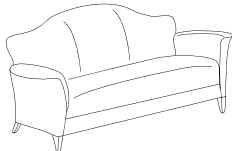

	Overall		Seat										St. Ydg.	Cu. Ft.	Shp. Wt.	Fr. Cls.
	81" W x 32.5" D x 35" H		67" W x 22" D x 19" H										10	76	153	250
	1	2/COM	3/COL	4	5	6	7	8	9	10	11	12/L	13	14	15/LL	
Zone 1	4555	5018	5428	5670	6024	6163	6383	6739	7096	7540	7932	8162	8625	8973	9317	
Zone 2	4714	5194	5618	5868	6235	6379	6606	6975	7344	7804	8210	8448	8927	9287	9643	
Zone 3	4874	5369	5808	6067	6446	6594	6830	7211	7593	8068	8487	8733	9229	9601	9969	

• Weltd, flared arms with soft pleats



Lauren

LOUNGE SEATING - SIN 33721

Art Deco Influence

Lauren blends Art Deco influences with versatile design applicable in offices and public spaces. Coordinating cocktail and end tables allow complete solutions for waiting room, hospitality and healthcare environments.

Product Details

- Taut seat, no-sag springs
- High density foam adds comfort
- Stitching between seat/back cushions when required by fabric application
- Commercial-grade engineered hardwood frame
- Frame components with reinforcing corner blocks are glued and stapled
- Curvilinear arms are custom fabricated and wrapped with foam and fiber for comfort

- Metal-to-metal connection of arms, seat and back ensures long-term durability
- Wood finish legs with non-marring floor glides
- Two-color combinations available
- Hybrid soy-based, CFC-free foam
- All listed product options must be factory installed

How to Specify:

- 1 Model number
- 2 Wood finish
- 3 Fabric grade & name for back & seat
- 4 Fabric grade & name for arms (if different)
- 5 Options

Finished Example

6101/FM/4 Mayer Bali Jet/BAM

Options	Code	Price
BAM Foot	BAM	67
Softer Seat Foam - Chair	SF	22
Softer Seat Foam - Loveseat	SF	44
Softer Seat Foam - Sofa	SF	66

Leg Finishes	Code
Black	BLK
Boardwalk	BW
Driftwood	DW
Espresso	ESP
Mahogany	MAH
Moab	MOB
Monticello Maple	MM
Natural Maple	FM
Shoreline	SL
Windsor Cherry	WC

6101 Club chair



	Overall			Seat								St. Ydg.	Cu. Ft.	Shp. Wt.	Fr. Cls.
	36" W x 32.5" D x 34" H			22" W x 21.5" D x 19" H								6.25	31	81	250
	1	2/COM	3/COL	4	5	6	7	8	9	10	11	12/L	13	14	15/LL
Zone 1	2504	2796	3050	3195	3416	3502	3859	4082	4358	4887	5047	5264	5480	5698	5915
Zone 2	2592	2894	3157	3307	3536	3625	3994	4225	4511	5058	5224	5448	5672	5897	6122
Zone 3	2679	2992	3264	3419	3655	3747	4129	4368	4663	5229	5400	5632	5864	6097	6329

6102 Loveseat



	Overall			Seat								St. Ydg.	Cu. Ft.	Shp. Wt.	Fr. Cls.
	58" W x 32.5" D x 34" H			45" W x 21.5" D x 19" H								7.5	60	113	250
	1	2/COM	3/COL	4	5	6	7	8	9	10	11	12/L	13	14	15/LL
Zone 1	3315	3678	3986	4159	4428	4533	4965	5236	5571	6211	6368	6627	6888	7148	7430
Zone 2	3431	3807	4126	4305	4583	4692	5139	5419	5766	6428	6591	6859	7129	7398	7690
Zone 3	3547	3935	4265	4450	4738	4850	5313	5603	5961	6646	6814	7091	7370	7648	7950

6103 Sofa

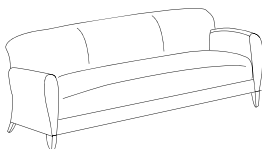

	Overall			Seat								St. Ydg.	Cu. Ft.	Shp. Wt.	Fr. Cls.
	80" W x 32.5" D x 34" H			67" W x 21.5" D x 19" H								10	77	138	250
	1	2/COM	3/COL	4	5	6	7	8	9	10	11	12/L	13	14	15/LL
Zone 1	4146	4605	5011	5260	5620	5754	5963	6330	6688	7134	7353	7524	7871	8217	8564
Zone 2	4291	4766	5186	5444	5817	5955	6172	6552	6922	7384	7610	7787	8146	8505	8864
Zone 3	4436	4927	5362	5628	6013	6157	6380	6773	7156	7633	7868	8051	8422	8792	9163



Rebecca

LOUNGE SEATING - SIN 33721

Seating With a Flair

The Rebecca lounge seating group blends sophisticated form with careful attention to detail. Soft arm pleats and welted design lines present an elegant, fully upholstered reception seating solution that also includes occasional tables. Elegant double-needle tailoring, taut seat, no-sag springs and high-density foam ensure long-term comfort and durability.

Product Details

- Taut seat, no-sag springs
- High density foam adds comfort
- Stitching between seat/back cushions when required by fabric application
- Commercial-grade engineered hardwood frame
- Frame components with reinforcing corner blocks are glued and stapled
- Flared arms are custom fabricated and wrapped with foam and fiber for comfort

- Metal-to-metal connection of arms, seat and back ensures long-term durability
- Wood finish legs with non-marring floor glides
- Two-color combinations available
- Hybrid soy-based, CFC-free foam
- All listed product options must be factory installed

How to Specify:

- 1 Model number
- 2 Wood finish
- 3 Fabric grade & name for back & seat
- 4 Fabric grade & name for arms (if different)
- 5 Options

Finished Example

6201/FM/9 Stinson Network Ghost/SF

Options	Code	Price
BAM Foot	BAM	67
Softer Seat Foam - Chair	SF	22
Softer Seat Foam - Loveseat	SF	44
Softer Seat Foam - Sofa	SF	66

Leg Finishes	Code
Black	BLK
Boardwalk	BW
Driftwood	DW
Espresso	ESP
Mahogany	MAH
Moab	MOB
Monticello Maple	MM
Natural Maple	FM
Shoreline	SL
Windsor Cherry	WC

6201 Club chair



	Overall			Seat								St. Ydg.	Cu. Ft.	Shp. Wt.	Fr. Cls.
	38" W x 32.5" D x 34.5" H			23" W x 22" D x 19" H								5.75	31	76	250
	1	2/COM	3/COL	4	5	6	7	8	9	10	11	12/L	13	14	15/LL
Zone 1	2504	2796	3050	3195	3416	3502	3859	4082	4358	4887	5047	5264	5480	5698	5915
Zone 2	2592	2894	3157	3307	3536	3625	3994	4225	4511	5058	5224	5448	5672	5897	6122
Zone 3	2679	2992	3264	3419	3655	3747	4129	4368	4663	5229	5400	5632	5864	6097	6329

6202 Loveseat

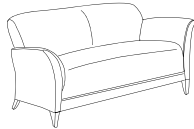

	Overall			Seat								St. Ydg.	Cu. Ft.	Shp. Wt.	Fr. Cls.
	59" W x 32.5" D x 34.5" H			44" W x 22" D x 19" H								8	58	116	250
	1	2/COM	3/COL	4	5	6	7	8	9	10	11	12/L	13	14	15/LL
Zone 1	3315	3678	3986	4159	4428	4533	4965	5236	5571	6211	6368	6627	6888	7148	7430
Zone 2	3431	3807	4126	4305	4583	4692	5139	5419	5766	6428	6591	6859	7129	7398	7690
Zone 3	3547	3935	4265	4450	4738	4850	5313	5603	5961	6646	6814	7091	7370	7648	7950

6203 Sofa

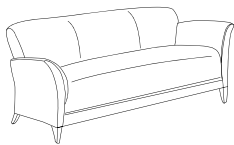

	Overall			Seat								St. Ydg.	Cu. Ft.	Shp. Wt.	Fr. Cls.
	81" W x 32.5" D x 34.5" H			66.5" W x 22" D x 19" H								10.5	76	148	250
	1	2/COM	3/COL	4	5	6	7	8	9	10	11	12/L	13	14	15/LL
Zone 1	4146	4605	5011	5260	5620	5754	5963	6330	6688	7134	7353	7524	7871	8217	8564
Zone 2	4291	4766	5186	5444	5817	5955	6172	6552	6922	7384	7610	7787	8146	8505	8864
Zone 3	4436	4927	5362	5628	6013	6157	6380	6773	7156	7633	7868	8051	8422	8792	9163



Scarlet

LOUNGE SEATING - SIN 33721

Impressive Seating

From hospitality to healthcare to educational and corporate environments, Scarlet's distinctive scroll-arm design creates impressive lounges, lobbies and other sitting areas.

Product Details

- Taut seat, no-sag springs
- High density foam adds comfort
- Stitching between seat/back cushions when required by fabric application
- Commercial-grade engineered hardwood frame
- Frame components with reinforcing corner blocks are glued and stapled
- Scrolled arm with welt trim

- Arms are custom fabricated and wrapped with foam and fiber for comfort
- Metal-to-metal connection of arms, seat and back ensures long-term durability
- Wood finish legs with non-marring floor glides
- Two-color combinations available
- Hybrid soy-based, CFC-free foam
- All listed product options must be factory installed

How to Specify:

- 1 Model number
- 2 Wood finish
- 3 Fabric grade & name for back & seat
- 4 Fabric grade & name for arms (if different)
- 5 Options

Finished Example

6301/FM/2 Culp Corinthian Blue Lake/SF

Options	Code	Price
BAM Foot	BAM	67
Softer Seat Foam - Chair	SF	22
Softer Seat Foam - Loveseat	SF	44
Softer Seat Foam - Sofa	SF	66

Leg Finishes	Code
Black	BLK
Boardwalk	BW
Driftwood	DW
Espresso	ESP
Mahogany	MAH
Moab	MOB
Monticello Maple	MM
Natural Maple	FM
Shoreline	SL
Windsor Cherry	WC

6301 Club chair



	Overall			Seat								St. Ydg.	Cu. Ft.	Shp. Wt.	Fr. Cls.
	38" W x 32.5" D x 34.5" H			21" W x 22" D x 19" H								6.5	31	74	250
	1	2/COM	3/COL	4	5	6	7	8	9	10	11	12/L	13	14	15/LL
Zone 1	2762	3064	3334	3503	3743	3834	4218	4600	4895	5370	5523	5740	5956	6172	6232
Zone 2	2859	3171	3451	3626	3874	3968	4366	4761	5066	5558	5716	5941	6164	6388	6450
Zone 3	2955	3278	3567	3748	4005	4102	4513	4922	5238	5746	5910	6142	6373	6604	6668

6302 Loveseat



	Overall			Seat								St. Ydg.	Cu. Ft.	Shp. Wt.	Fr. Cls.
	59" W x 32.5" D x 34.5" H			44" W x 22" D x 19" H								8	60	113	250
	1	2/COM	3/COL	4	5	6	7	8	9	10	11	12/L	13	14	15/LL
Zone 1	3641	4016	4336	4505	4783	4890	5338	5616	5961	6329	6620	6896	7174	7452	7728
Zone 2	3768	4157	4488	4663	4950	5061	5525	5813	6170	6551	6852	7137	7425	7713	7998
Zone 3	3896	4297	4640	4820	5118	5232	5712	6009	6378	6772	7083	7379	7676	7974	8269

6303 Sofa



	Overall			Seat								St. Ydg.	Cu. Ft.	Shp. Wt.	Fr. Cls.
	81" W x 32.5" D x 34.5" H			66.5" W x 22" D x 19" H								10.5	77	138	250
	1	2/COM	3/COL	4	5	6	7	8	9	10	11	12/L	13	14	15/LL
Zone 1	4555	5018	5428	5670	6024	6163	6383	6739	7096	7540	7932	8162	8625	8973	9317
Zone 2	4714	5194	5618	5868	6235	6379	6606	6975	7344	7804	8210	8448	8927	9287	9643
Zone 3	4874	5369	5808	6067	6446	6594	6830	7211	7593	8068	8487	8733	9229	9601	9969



Steps

LOUNGE SEATING - SIN 33721

Versatile and Modular

Steps Modular lounge seating components can be configured, expanded and re-configured as your business grows and changes. Every component is a seating module, ensuring maximum seating capacity and optimum space-efficiency in your facilities. Seat/back modules are field replaceable, offering renewability down the road.

Product Details

- Fully upholstered base
- Replaceable seat/back cushions
- Commercial-grade engineered hardwood frame
- Frame components with reinforcing corner blocks are glued and stapled
- Seat suspension features heavy-duty Sytex stretch-webbing

- Taut upholstered seat and back
- Two-color combinations (base and seat/back) available
- .625" H glide feet protect carpet and floor surface
- Hybrid soy-based, CFC-free foam
- All listed product options must be factory installed

How to Specify:

- 1 Model number
- 2 Wood finish
- 3 Fabric grade & name for seat & back
- 4 Fabric grade & name for base (if different)
- 5 Options

Options	Code	Price
Softer Seat Foam - Chair	SF	22
Softer Seat Foam - Loveseat	SF	44
Softer Seat Foam - Sofa	SF	66

Finished Example

7431/5 Stinson Retrograde Electric/4 Spradling Silvertex Celery/SF

7331

One-Seat Bench with upholstered base

NOW

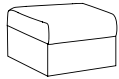

	Overall	Seat										St. Ydg.	Cu. Ft.	Shp. Wt.	Fr. Cls.
	24.75" W x 28.5" D x 19.5" H	24.75" W x 28" D x 19.5" H										1.5	15	48	250
	1	2/COM	3/COL	4	5	6	7	8	9	10	11	12/L	13	14	15/LL
Zone 1	1035	1163	1292	1319	1372	1421	1453	1486	1523	1562	1593	1645	1697	1748	1800
Zone 2	1071	1204	1337	1365	1420	1471	1504	1538	1576	1617	1649	1703	1756	1809	1863
Zone 3	1107	1244	1382	1411	1468	1520	1555	1590	1630	1671	1705	1760	1816	1870	1926

•19.5" H Flat Surface Seat

7332

Two-Seat Bench with upholstered base

NOW

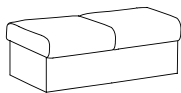

	Overall	Seat										St. Ydg.	Cu. Ft.	Shp. Wt.	Fr. Cls.
	49.25" W x 28.5" D x 19.5" H	49.25" W x 28" D x 19.5" H										3	37	90	250
	1	2/COM	3/COL	4	5	6	7	8	9	10	11	12/L	13	14	15/LL
Zone 1	1765	1880	2014	2128	2245	2399	2552	2707	2860	3052	3155	3258	3363	3467	3571
Zone 2	1827	1946	2084	2202	2324	2483	2641	2802	2960	3159	3265	3372	3481	3588	3696
Zone 3	1889	2012	2155	2277	2402	2567	2731	2896	3060	3266	3376	3486	3598	3710	3821

•19.5" H Flat Surface Seat

7333

Three-Seat Bench with upholstered base

NOW

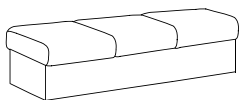

	Overall	Seat										St. Ydg.	Cu. Ft.	Shp. Wt.	Fr. Cls.
	73.75" W x 28.5" D x 19.5" H	73.75" W x 28" D x 19.5" H										4.5	40	122	250
	1	2/COM	3/COL	4	5	6	7	8	9	10	11	12/L	13	14	15/LL
Zone 1	2685	2859	3061	3232	3408	3639	3868	4098	4327	4618	4773	4929	5084	5240	5395
Zone 2	2779	2959	3168	3345	3527	3766	4003	4241	4478	4780	4940	5102	5262	5423	5584
Zone 3	2873	3059	3275	3458	3647	3894	4139	4385	4630	4941	5107	5274	5440	5607	5773

•19.5" H Flat Surface Seat

7335

Wedge Bench Module

NOW



	Overall	Seat										St. Ydg.	Cu. Ft.	Shp. Wt.	Fr. Cls.
	27.5" W x 25.75" D x 19.5" H	8-27.5" W x 25.5" D x 19.5" H										3	15	48	250
	1	2/COM	3/COL	4	5	6	7	8	9	10	11	12/L	13	14	15/LL
Zone 1	1035	1163	1292	1319	1372	1421	1453	1486	1523	1562	1666	1753	1856	1961	2047
Zone 2	1071	1204	1337	1365	1420	1471	1504	1538	1576	1617	1724	1814	1921	2030	2119
Zone 3	1107	1244	1382	1411	1468	1520	1555	1590	1630	1671	1783	1876	1986	2098	2190

•19.5" H Flat Surface Seat

7339L

Left Arm for Steps Module

NOW



	Overall	Seat										St. Ydg.	Cu. Ft.	Shp. Wt.	Fr. Cls.
	4.5" W x 23.5" D x 27" H											2	6	17	175
	1	2/COM	3/COL	4	5	6	7	8	9	10	11	12/L	13	14	15/LL
Zone 1	300	366	426	474	529	552	639	696	765	895	953	1021	1092	1161	1208
Zone 2	311	379	441	491	548	571	661	720	792	926	986	1057	1130	1202	1250
Zone 3	321	392	456	507	566	591	684	745	819	958	1020	1092	1168	1242	1293

Steps

	Overall											St. Ydg.	Cu. Ft.	Shp. Wt.	Fr. Cls.		
7339R	4.5" W x 23.5" D x 27" H											2	6	17	175		
Arm for Steps Module																	
NOW																	
	1	2/COM	3/COL	4	5	6	7	8	9	10	11	12/L	13	14	15/LL		
Zone 1	300	366	426	474	529	552	639	696	765	895	953	1021	1092	1161	1208		
Zone 2	311	379	441	491	548	571	661	720	792	926	986	1057	1130	1202	1250		
Zone 3	321	392	456	507	566	591	684	745	819	958	1020	1092	1168	1242	1293		

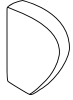

	Overall											Seat			St. Ydg.	Cu. Ft.	Shp. Wt.	Fr. Cls.
7431	24.75" W x 28.5" D x 30" H											24" W x 21" D x 19.5" H			3.5	15	55	250
One-Seat Module																		
NOW																		
	1	2/COM	3/COL	4	5	6	7	8	9	10	11	12/L	13	14	15/LL			
Zone 1	1181	1308	1429	1491	1589	1718	1767	1979	2106	2267	2362	2484	2605	2726	2846			
Zone 2	1222	1354	1479	1543	1645	1778	1829	2048	2180	2346	2445	2571	2696	2821	2946			
Zone 3	1264	1400	1529	1595	1700	1838	1891	2118	2253	2426	2527	2658	2787	2917	3045			

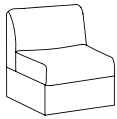

•Sloped Seat, 19.5" H at Front

	Overall											Seat			St. Ydg.	Cu. Ft.	Shp. Wt.	Fr. Cls.
7432	49.25" W x 28.5" D x 30" H											50" W x 21" D x 19.5" H			6	37	102	250
Two-Seat Module																		
NOW																		
	1	2/COM	3/COL	4	5	6	7	8	9	10	11	12/L	13	14	15/LL			
Zone 1	1985	2170	2364	2456	2607	2803	2879	3197	3395	3644	3838	4013	4220	4428	4635			
Zone 2	2054	2246	2447	2542	2698	2901	2980	3309	3514	3772	3972	4153	4368	4583	4797			
Zone 3	2124	2322	2529	2628	2789	2999	3081	3421	3633	3899	4107	4294	4515	4738	4959			

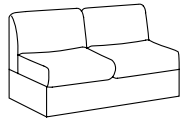

•Sloped Seat, 19.5" H at Front

	Overall											Seat			St. Ydg.	Cu. Ft.	Shp. Wt.	Fr. Cls.
7433	74" W x 28.5" D x 30" H											74" W x 21" D x 19.5" H			8	40	140	250
Three-Seat Module																		
NOW																		
	1	2/COM	3/COL	4	5	6	7	8	9	10	11	12/L	13	14	15/LL			
Zone 1	2925	3213	3490	3634	3856	4154	4270	4748	5047	5418	5628	5904	6181	6459	6735			
Zone 2	3027	3325	3612	3761	3991	4299	4419	4914	5224	5608	5825	6111	6397	6685	6971			
Zone 3	3130	3438	3734	3888	4126	4445	4569	5080	5400	5797	6022	6317	6614	6911	7206			

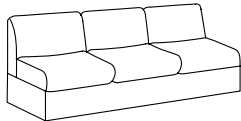

•Sloped Seat, 19.5" H at Front

	Overall											Seat			St. Ydg.	Cu. Ft.	Shp. Wt.	Fr. Cls.
7434	29.25" W x 27" D x 30" H											15-29.5" W x 20" D x 19.5" H			3.25	16.5	52	250
Inverted Wedge Module																		
NOW																		
	1	2/COM	3/COL	4	5	6	7	8	9	10	11	12/L	13	14	15/LL			
Zone 1	1181	1308	1429	1491	1589	1718	1767	1979	2106	2267	2391	2504	2615	2728	2841			
Zone 2	1222	1354	1479	1543	1645	1778	1829	2048	2180	2346	2475	2592	2707	2823	2940			
Zone 3	1264	1400	1529	1595	1700	1838	1891	2118	2253	2426	2558	2679	2798	2919	3040			



•Sloped Seat, 19.5" H at Front

	Overall	Seat										St. Ydg.	Cu. Ft.	Shp. Wt.	Fr. Cls.	
7435	27.5" W x 25.75" D x 30" H	8-23" W x 21" D x 19.5" H										3.75	15	54	250	
		1	2/COM	3/COL	4	5	6	7	8	9	10	11	12/L	13	14	15/LL
Zone 1		1181	1308	1429	1491	1589	1718	1767	1979	2106	2267	2391	2504	2615	2728	2841
Zone 2		1222	1354	1479	1543	1645	1778	1829	2048	2180	2346	2475	2592	2707	2823	2940
Zone 3		1264	1400	1529	1595	1700	1838	1891	2118	2253	2426	2558	2679	2798	2919	3040

Wedge Module

NOW

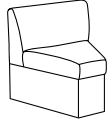

• Sloped Seat, 19.5" H at Front

	Overall	Seat										St. Ydg.	Cu. Ft.	Shp. Wt.	Fr. Cls.	
7436	38" W x 38" D x 30" H	34" W x 34" D x 19.5" H										5.5	35	91	250	
		1	2/COM	3/COL	4	5	6	7	8	9	10	11	12/L	13	14	15/LL
Zone 1		2458	2652	2849	2944	3077	3274	3352	3672	3869	4117	4317	4507	4697	4888	5078
Zone 2		2544	2745	2949	3047	3185	3389	3469	3801	4004	4261	4468	4665	4861	5059	5256
Zone 3		2630	2838	3048	3150	3292	3503	3587	3929	4140	4405	4619	4822	5026	5230	5433

Corner Seat Module

NOW

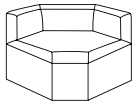

• Sloped Seat, 19.5" H at Front

	Overall	Seat										St. Ydg.	Cu. Ft.	Shp. Wt.	Fr. Cls.	
7441	33.75" W x 28.5" D x 30" H	25" W x 21" D x 19.5" H										6.5	29	84	250	
		1	2/COM	3/COL	4	5	6	7	8	9	10	11	12/L	13	14	15/LL
Zone 1		1590	1774	1956	2042	2184	2373	2448	2755	2944	3181	3372	3598	3784	4011	4235
Zone 2		1646	1836	2024	2113	2260	2456	2534	2851	3047	3292	3490	3724	3916	4151	4383
Zone 3		1701	1898	2093	2185	2337	2539	2619	2948	3150	3404	3608	3850	4049	4292	4531

Lounge Chair with Arms

NOW

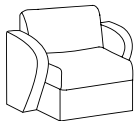

• Sloped Seat, 19.5" H at Front

	Overall	Seat										St. Ydg.	Cu. Ft.	Shp. Wt.	Fr. Cls.	
7442	58.25" W x 28.5" D x 30" H	50" W x 21" D x 19.5" H										8.5	40	127	250	
		1	2/COM	3/COL	4	5	6	7	8	9	10	11	12/L	13	14	15/LL
Zone 1		2414	2666	2919	3035	3228	3493	3591	4015	4277	4601	5039	5284	5578	5873	6112
Zone 2		2498	2759	3021	3141	3341	3615	3717	4156	4427	4762	5215	5469	5773	6079	6326
Zone 3		2583	2853	3123	3247	3454	3738	3842	4296	4576	4923	5392	5654	5968	6284	6540

Loveseat with Arms

NOW

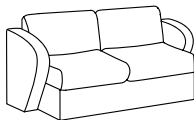

• Sloped Seat, 19.5" H at Front

	Overall	Seat										St. Ydg.	Cu. Ft.	Shp. Wt.	Fr. Cls.	
7443	82.75" W x 28.5" D x 30" H	74" W x 21" D x 19.5" H										11	53	160	250	
		1	2/COM	3/COL	4	5	6	7	8	9	10	11	12/L	13	14	15/LL
Zone 1		3369	3711	4059	4215	4483	4842	4978	5552	5907	6354	6765	7084	7465	7728	8041
Zone 2		3487	3841	4201	4363	4640	5011	5152	5746	6114	6576	7002	7332	7726	7998	8322
Zone 3		3605	3971	4343	4510	4797	5181	5326	5941	6320	6799	7239	7580	7988	8269	8604

Sofa with Arms

NOW

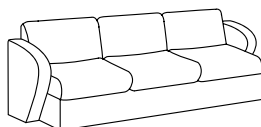

• Sloped Seat, 19.5" H at Front



Traditional

LOUNGE SEATING - SIN 33721

Period Influence, Classic Style

Traditional Reception features period influences to create Wing Back, Gooseneck and other classic styles. Traditional tufting, individually-placed brass nail trim and shaped wood base caps enhance the design.

Product Details

- Tufted seat and back
- Brass nail head trim
- Commercial-grade engineered hardwood frame
- Frame components with reinforcing corner blocks are glued and stapled

- Metal-to-metal connection of arms, seat and back ensures long-term durability
- Wood finish arms and legs with non-marring floor glides
- Hybrid soy-based, CFC-free foam
- All listed product options must be factory installed

How to Specify:

- 1 Model number
- 2 Wood finish
- 3 Fabric grade & name
- 4 Options

Finished Example

4072/FM/9 Ultrafabrics Promessa Tudor/SN

Options	Code	Price
No Brass Nail Trim	NB	N/C
Silver Nail Trim	SN	N/C
Non-Tufted	NT	N/C

Leg Finishes	Code
Black	BLK
Boardwalk	BW
Driftwood	DW
Espresso	ESP
Mahogany	MAH
Moab	MOB
Monticello Maple	MM
Natural Maple	FM
Shoreline	SL
Windsor Cherry	WC

Traditional

	Overall			Seat								St. Ydg.	Cu. Ft.	Shp. Wt.	Fr. Cls.	
4053	25" W x 29" D x 43" H			18" W x 17.75" D x 19.5" H								3.5	24	42	250	
Goose neck arm chair	1	2/COM	3/COL	4	5	6	7	8	9	10	11	12/L	13	14	15/LL	
	Zone 1	2315	2455	2587	2662	2771	2815	2996	3105	3244	3504	3619	3740	3861	3981	4104
	Zone 2	2396	2541	2678	2755	2868	2914	3101	3214	3358	3627	3746	3871	3996	4120	4248
	Zone 3	2477	2627	2768	2848	2965	3012	3206	3322	3471	3749	3872	4002	4131	4260	4391
		Option										Code	Price			
		Upholstered Arm Cap										UA	143			

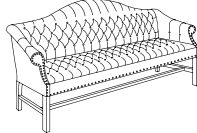
	Overall			Seat								St. Ydg.	Cu. Ft.	Shp. Wt.	Fr. Cls.	
4072	57" W x 27.5" D x 34" H			47.5" W x 17.5" D x 19.5" H								6	36	78	250	
Loveseat	1	2/COM	3/COL	4	5	6	7	8	9	10	11	12/L	13	14	15/LL	
	Zone 1	2559	2848	3093	3227	3442	3526	3869	4083	4350	4856	5001	5209	5418	5625	5834
	Zone 2	2649	2948	3201	3340	3562	3649	4004	4226	4502	5026	5176	5391	5608	5822	6038
	Zone 3	2738	3047	3310	3453	3683	3773	4140	4369	4655	5196	5351	5574	5797	6019	6242

	Overall			Seat								St. Ydg.	Cu. Ft.	Shp. Wt.	Fr. Cls.	
4073	27" W x 29" D x 39" H			16-19.5" W x 18.25" D x 18.5" H								4	20	48	250	
Wing back arm chair	1	2/COM	3/COL	4	5	6	7	8	9	10	11	12/L	13	14	15/LL	
	Zone 1	1810	1995	2166	2242	2378	2562	2631	2926	3109	3336	3439	3576	3715	3854	3992
	Zone 2	1873	2065	2242	2320	2461	2652	2723	3028	3218	3453	3559	3701	3845	3989	4132
	Zone 3	1937	2135	2318	2399	2544	2741	2815	3131	3327	3570	3680	3826	3975	4124	4271

	Overall			Seat								St. Ydg.	Cu. Ft.	Shp. Wt.	Fr. Cls.	
4074	29" W x 31" D x 40.5" H			18-22.5" W x 19" D x 18.5" H								4.5	26	54	250	
Wing back arm chair	1	2/COM	3/COL	4	5	6	7	8	9	10	11	12/L	13	14	15/LL	
	Zone 1	1916	2059	2204	2427	2587	2786	2882	3227	3443	3708	3748	3876	4059	4216	4371
	Zone 2	1983	2131	2281	2512	2678	2884	2983	3340	3564	3838	3879	4012	4201	4364	4524
	Zone 3	2050	2203	2358	2597	2768	2981	3084	3453	3684	3968	4010	4147	4343	4511	4677

	Overall			Seat								St. Ydg.	Cu. Ft.	Shp. Wt.	Fr. Cls.	
4075	28" W x 26" D x 32" H			17" W x 18" D x 19.5" H								3.5	14	45	250	
Guest arm chair	1	2/COM	3/COL	4	5	6	7	8	9	10	11	12/L	13	14	15/LL	
	Zone 1	1744	1903	2025	2091	2147	2202	2244	2425	2533	2673	2826	2926	3048	3169	3289
	Zone 2	1805	1970	2096	2164	2222	2279	2323	2510	2622	2767	2925	3028	3155	3280	3404
	Zone 3	1866	2036	2167	2237	2297	2356	2401	2595	2710	2860	3024	3131	3261	3391	3519

	Overall			Seat								St. Ydg.	Cu. Ft.	Shp. Wt.	Fr. Cls.	
4076	28" W x 26" D x 32" H			17" W x 18" D x 19.5" H								3.5	14.7	45	250	
Conference chair on casters	1	2/COM	3/COL	4	5	6	7	8	9	10	11	12/L	13	14	15/LL	
	Zone 1	1791	1937	2069	2138	2250	2291	2472	2580	2719	2982	3094	3216	3337	3460	3580
	Zone 2	1854	2005	2141	2213	2329	2371	2559	2670	2814	3086	3202	3329	3454	3581	3705
	Zone 3	1916	2073	2214	2288	2408	2451	2645	2761	2909	3191	3311	3441	3571	3702	3831

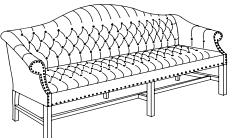
	Overall			Seat								St. Ydg.	Cu. Ft.	Shp. Wt.	Fr. Cls.	
4083	78" W x 28" D x 35" H			66" W x 18" D x 19" H								8	56	113	250	
Sofa	1	2/COM	3/COL	4	5	6	7	8	9	10	11	12/L	13	14	15/LL	
	Zone 1	3166	3528	3835	4008	4278	4382	4817	5086	5422	6060	6146	6423	6699	6976	7253
	Zone 2	3277	3651	3969	4148	4428	4535	4986	5264	5612	6272	6361	6648	6933	7220	7507
	Zone 3	3388	3775	4103	4289	4577	4689	5154	5442	5802	6484	6576	6873	7168	7464	7761



7300/7400 Series

LOUNGE SEATING - SIN 33721

Create Your Own Space

With the 7300/7400 Modular Collection, create unique configurations, adapt to building layouts and maximize seating capacity. Choose from 12 seating/table components. Approach benches (7300 models) from either side in open areas. Units with backs (7400 models) provide full-comfort sloped seating. Freestanding and ganging tables are available in a variety of shapes and sizes.

Product Details

- High pressure laminate bases and tables
- Black recessed plinth base includes reinforcing corner blocks
- Replaceable seat/back cushions
- Commercial-grade engineered hardwood seat/back frame
- Seat suspension features heavy-duty Sytex stretch-webbing

- Taut upholstered seat and back
- .625" H glide feet protect carpet and floor surface
- Hybrid soy-based, CFC-free foam
- All listed product options must be factory installed

How to Specify:

- 1 Model number
- 2 Wood finish
- 3 Fabric grade & name
- 4 Options

Options	Code	Price
Softer Seat Foam - Chair	SF	22
Softer Seat Foam - Loveseat	SF	44
Softer Seat Foam - Sofa	SF	66
Custom (Non-Premium) Laminate - 1-seat	S	154
Custom (Non-Premium) Laminate - 2-seat	S	180
Custom (Non-Premium) Laminate - 3-seat	S	201
Custom (Non-Premium) Laminate - Table	S	180

Wood Finishes	Code
Driftwood	DW
Natural Maple	FM
Windsor Cherry	WC

Finished Example

7301/FM/8 Mayer Fabrics Tattersall Mallard/SF

7301
Modular One Seat Bench

NOW



	Overall		Seat										St. Ydg.	Cu. Ft.	Shp. Wt.	Fr. Cls.
	24.75" W x 28.5" D x 19.5" H		24.75" W x 28.5" D x 19.5" H										1.5	17	51	250
	1	2/COM	3/COL	4	5	6	7	8	9	10	11	12/L	13	14	15/LL	
Zone 1	993	1081	1155	1193	1252	1278	1335	1381	1446	1523	1603	1656	1708	1760	1812	
Zone 2	1028	1119	1195	1235	1296	1323	1382	1429	1497	1576	1659	1714	1768	1822	1875	
Zone 3	1063	1157	1236	1277	1340	1367	1428	1478	1547	1630	1715	1772	1828	1883	1939	

•19.5" H Flat Surface Seat

7302
Modular Two Seat Bench

NOW

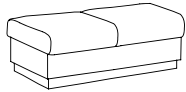

	Overall		Seat										St. Ydg.	Cu. Ft.	Shp. Wt.	Fr. Cls.
	49.25" W x 28.5" D x 19.5" H		49.25" W x 28.5" D x 19.5" H										3	37	92	250
	1	2/COM	3/COL	4	5	6	7	8	9	10	11	12/L	13	14	15/LL	
Zone 1	1662	1816	1951	1988	2034	2151	2200	2391	2511	2656	2780	2884	2987	3092	3195	
Zone 2	1720	1880	2019	2058	2105	2226	2277	2475	2599	2749	2877	2985	3092	3200	3307	
Zone 3	1778	1943	2088	2127	2176	2302	2354	2558	2687	2842	2975	3086	3196	3308	3419	

•19.5" H Flat Surface Seat

7303
Modular Three Seat Bench

NOW

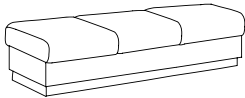

	Overall		Seat										St. Ydg.	Cu. Ft.	Shp. Wt.	Fr. Cls.
	73.75" W x 28.5" D x 19.5" H		73.75" W x 28.5" D x 19.5" H										4.5	40	122	250
	1	2/COM	3/COL	4	5	6	7	8	9	10	11	12/L	13	14	15/LL	
Zone 1	2499	2731	2940	3070	3252	3319	3615	3798	4027	4257	4331	4487	4643	4799	4954	
Zone 2	2586	2827	3043	3177	3366	3435	3742	3931	4168	4406	4483	4644	4806	4967	5127	
Zone 3	2674	2922	3146	3285	3480	3551	3868	4064	4309	4555	4634	4801	4968	5135	5301	

•19.5" H Flat Surface Seat

7401
Modular Chair

NOW



	Overall		Seat										St. Ydg.	Cu. Ft.	Shp. Wt.	Fr. Cls.
	24.75" W x 28.5" D x 30" H		24.75" W x 21" D x 19.5" H										2	17	59	250
	1	2/COM	3/COL	4	5	6	7	8	9	10	11	12/L	13	14	15/LL	
Zone 1	1181	1286	1376	1429	1508	1541	1607	1666	1745	1844	1925	1993	2064	2133	2202	
Zone 2	1222	1331	1424	1479	1561	1595	1663	1724	1806	1909	1992	2063	2136	2208	2279	
Zone 3	1264	1376	1472	1529	1614	1649	1719	1783	1867	1973	2060	2133	2208	2282	2356	

•Sloped Seat, 19.5" H at Front

7402
Modular Loveseat

NOW



	Overall		Seat										St. Ydg.	Cu. Ft.	Shp. Wt.	Fr. Cls.
	49.25" W x 28.5" D x 30" H		49.25" W x 21" D x 19.5" H										4	37	103	250
	1	2/COM	3/COL	4	5	6	7	8	9	10	11	12/L	13	14	15/LL	
Zone 1	1985	2186	2375	2481	2640	2701	2771	2957	3113	3311	3475	3615	3752	3891	4029	
Zone 2	2054	2263	2458	2568	2732	2796	2868	3060	3222	3427	3597	3742	3883	4027	4170	
Zone 3	2124	2339	2541	2655	2825	2890	2965	3164	3331	3543	3718	3868	4015	4163	4311	

•Sloped Seat, 19.5" H at Front

7300/7400

7403

Modular Sofa

NOW

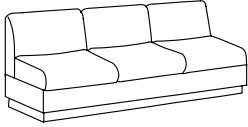

Overall	Seat											St. Ydg.	Cu. Ft.	Shp. Wt.	Fr. Cls.
73.75" W x 28.5" D x 30" H	73.75" W x 21" D x 19.5" H											6	40	133	250

	1	2/COM	3/COL	4	5	6	7	8	9	10	11	12/L	13	14	15/LL
Zone 1	2925	3245	3517	3669	3903	3997	4094	4381	4619	4913	5159	5368	5575	5783	5991
Zone 2	3027	3359	3640	3797	4040	4137	4237	4534	4781	5085	5340	5556	5770	5985	6201
Zone 3	3130	3472	3763	3926	4176	4277	4381	4688	4942	5257	5520	5744	5965	6188	6410

• Sloped Seat, 19.5" H at Front

7420

Modular Coffee Table

NOW



Overall	St. Ydg.	Cu. Ft.	Shp. Wt.	Fr. Cls.
52" W x 20" D x 14" H	N/A	16	72	175

Zone 1	1204
Zone 2	1246
Zone 3	1288

7421

Modular Cylinder Table

NOW



Overall	St. Ydg.	Cu. Ft.	Shp. Wt.	Fr. Cls.
19" W x 19" D x 14" H	N/A	6	25	175

Zone 1	967
Zone 2	1001
Zone 3	1035

7423

Modular End Table

NOW

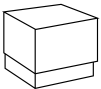

Overall	St. Ydg.	Cu. Ft.	Shp. Wt.	Fr. Cls.
25" W x 25" D x 14" H	N/A	10	49	175

Zone 1	1043
Zone 2	1080
Zone 3	1116

7424

Modular Connector Table

NOW



Overall	St. Ydg.	Cu. Ft.	Shp. Wt.	Fr. Cls.
18" W x 25" D x 11.5" H	N/A	6	39	125

Zone 1	938
Zone 2	971
Zone 3	1004

	Overall	St. Ydg.	Cu. Ft.	Shp. Wt.	Fr. Cls.
7425 Modular Wedge Table	8-27" W x 25" D x 11.5" H	N/A	8	36	175
NOW 	Zone 1 1165				
	Zone 2 1206				
	Zone 3 1247				

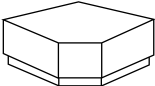
	Overall	St. Ydg.	Cu. Ft.	Shp. Wt.	Fr. Cls.
7426 Modular Corner Table	38" W x 38" D x 11.5" H	N/A	18	77	175
NOW 	Zone 1 1320				
	Zone 2 1366				
	Zone 3 1412				

	Overall	St. Ydg.	Cu. Ft.	Shp. Wt.	Fr. Cls.
74A Ganging Kit to attach 7424 Connector Table	10" W x 3" D x .125" H	N/A	0.2	3	70
NOW 	Zone 1 45				
	Zone 2 45				
	Zone 3 45				

	Overall	St. Ydg.	Cu. Ft.	Shp. Wt.	Fr. Cls.
74B Ganging Kit to attach 7425 Wedge Table	3.5" W x 3" D x 0.38" H	N/A	0.2	2	70
NOW 	Zone 1 45				
	Zone 2 45				
	Zone 3 45				

	Overall	St. Ydg.	Cu. Ft.	Shp. Wt.	Fr. Cls.
74C Ganging Kit to attach 7426 Corner Table	3.5" W x 3" D x .75" H	N/A	0.2	2	70
NOW 	Zone 1 45				
	Zone 2 45				
	Zone 3 45				



9100 Series

LOUNGE SEATING - SIN 33721

To Be Discontinued 12/31/22

(or until dedicated materials are depleted)

Luxurious Comfort

9100 Lounge Seating provides luxurious comfort with a unique, compound curved wood accent. Flare arm design, contoured lumbar support and generous scale create comfortable proportion and relaxed seating. Seat cushions feature extra thick, multi-density foam for support and are removable for easy cleaning.

Product Details

- Exposed handcrafted carved hardwood flared arms with upholstered inserts wrap to front legs
- Weltd design lines on arms with soft pleats on sides of back
- Removable seat/back cushions provides comfort, support and easy cleaning
- Flexolater wire seat suspension
- 11-gauge sinuous wire back suspension
- Wood finish arms and legs with non-marring floor glides

- Commercial-grade engineered hardwood frame with reinforcing corner blocks are glued and stapled
- Arms are custom fabricated and wrapped with foam and fiber for comfort
- Metal-to-metal connection of arms, seat and back ensures long-term durability
- Hybrid soy-based, CFC-free foam
- All listed product options must be factory installed

How to Specify:

- 1 Model number
- 2 Wood finish
- 3 Fabric grade & name
- 4 Options

Options	Code	Price
Softer Seat Foam - Chair	SF	22
Softer Seat Foam - Loveseat	SF	44
Softer Seat Foam - Sofa	SF	66

Wood Finishes	Code
Black	BLK
Boardwalk	BW
Driftwood	DW
Espresso	ESP
Mahogany	MAH
Moab	MOB
Monticello Maple	MM
Natural Maple	FM
Shoreline	SL
Windsor Cherry	WC

Finished Example

9131/MAH/2 Culp High Cotton Cordovan/SF

To Be Discontinued 12/31/22

(or until dedicated materials are depleted)

9131

Lounge chair

Now



Overall	Seat											St. Ydg.	Cu. Ft.	Shp. Wt.	Fr. Cls.
35" W x 35" D x 29" H	24" W x 20.5" D x 19" H											5.75	24	79	250
	1	2/COM	3/COL	4	5	6	7	8	9	10	11	12/L	13	14	15/LL
Zone 1	2505	2754	2972	3099	3289	3360	3669	3711	4095	4548	4647	4845	5045	5243	5442
Zone 2	2593	2850	3076	3207	3404	3478	3797	3841	4238	4707	4810	5015	5222	5427	5632
Zone 3	2680	2947	3180	3316	3519	3595	3926	3971	4382	4866	4972	5184	5398	5610	5823

9132

Love seat

Now

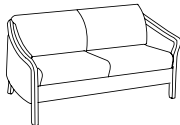

Overall	Seat											St. Ydg.	Cu. Ft.	Shp. Wt.	Fr. Cls.
58" W x 35" D x 29" H	48" W x 20.5" D x 19" H											7.5	42	105	250
	1	2/COM	3/COL	4	5	6	7	8	9	10	11	12/L	13	14	15/LL
Zone 1	3526	3892	4184	4364	4632	4739	5174	5442	5780	6416	6578	6838	7098	7357	7617
Zone 2	3649	4028	4330	4517	4794	4905	5355	5632	5982	6641	6808	7077	7346	7614	7884
Zone 3	3773	4164	4477	4669	4956	5071	5536	5823	6185	6865	7038	7317	7595	7872	8150

9133

Sofa

Now

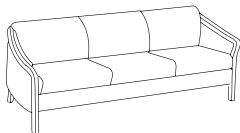

Overall	Seat											St. Ydg.	Cu. Ft.	Shp. Wt.	Fr. Cls.
83" W x 35" D x 29" H	72" W x 20.5" D x 19" H											9.5	56	138	250
	1	2/COM	3/COL	4	5	6	7	8	9	10	11	12/L	13	14	15/LL
Zone 1	4417	4848	5233	5453	5789	6062	6452	6785	7202	7992	8284	8614	8942	9271	9585
Zone 2	4572	5018	5416	5644	5992	6274	6678	7022	7454	8272	8574	8915	9255	9595	9920
Zone 3	4726	5187	5599	5835	6194	6486	6904	7260	7706	8551	8864	9217	9568	9920	10256

9138

Guest chair

Now



Overall	Seat											St. Ydg.	Cu. Ft.	Shp. Wt.	Fr. Cls.
25" W x 27" D x 32.5" H	20" W x 18.5" D x 20.25" H											3	15	38	250
	1	2/COM	3/COL	4	5	6	7	8	9	10	11	12/L	13	14	15/LL
Zone 1	1483	1619	1734	1803	1907	1947	2115	2216	2343	2590	2704	2808	2913	3016	3089
Zone 2	1535	1676	1795	1866	1974	2015	2189	2294	2425	2681	2799	2906	3015	3122	3197
Zone 3	1587	1732	1855	1929	2040	2083	2263	2371	2507	2771	2893	3005	3117	3227	3305



Classic Collection

EXECUTIVE OFFICE SEATING - SIN 33721

Classic Design and Functionality

With timeless styles and options, the HPFi Classic Collection is a winner in many office environments. The HPFi Classic Collection is comprised of several "former" series of seating previously identified as Scoop, Quick Silver and Traditional. Many offer a choice between wood and urethane arms and base. Options on many of these models include knee tilt controls, trim, nail heads, jury bases, glides and a variety of casters for various floor surfaces.

Product Details

- Thick, padded contour molded foam in seat and back
- Five-prong base with dual wheel carpet casters
- 360° Swivel seat with waterfall front edge
- One touch pneumatic seat height adjustment

- Standard swivel tilt mechanism
- Swivel chairs feature wood cap over steel or nylon reinforced polyurethane bases
- Hybrid soy-based, CFC-free foam

How to Specify:

- 1 Model number
- 2 Wood finish
- 3 Fabric grade & name
- 4 Options

Options	Code	Price
Braking Casters	B	38
Edge Guard	E	22
Glides	GL	N/C
Hard Floor Casters	H	28
Jury Base	JB	403
Knee Tilt Control	K	133
No brass trim	NB	N/C
No tufting	NT	N/C
Self-Locking Casters	S	111

Wood Finishes	Code
Black	BLK
Boardwalk	BW
Driftwood	DW
Espresso	ESP
Mahogany	MAH
Moab	MOB
Monticello Maple	MM
Natural Maple	FM
Shoreline	SL
Windsor Cherry	WC

Finished Example

4013/FM/2 Momentum Origin Sapphire/H

Quick Silver Contemporary

1271

High back chair



	Overall			Seat								St. Ydg.	Cu. Ft.	Shp. Wt.	Fr. Cls.
	24" W x 28" D x 42-46" H			19.5" W x 18.75" D x 17-20.5" H								3	23	59	250
	1	2/COM	3/COL	4	5	6	7	8	9	10	11	12/L	13	14	15/LL
Zone 1	1437	1576	1685	1759	1862	1903	1984	2067	2170	2260	2364	2451	2555	2658	2762
Zone 2	1487	1631	1744	1821	1927	1970	2053	2139	2246	2339	2447	2537	2644	2751	2859
Zone 3	1538	1686	1803	1882	1992	2036	2123	2212	2322	2418	2529	2623	2734	2844	2955

- Wood arms with upholstered arm caps

1277

Mid-back chair



	Overall			Seat								St. Ydg.	Cu. Ft.	Shp. Wt.	Fr. Cls.
	24" W x 26" D x 34-38" H			19.5" W x 18.75" D x 17-20.5" H								2.5	23	51	250
	1	2/COM	3/COL	4	5	6	7	8	9	10	11	12/L	13	14	15/LL
Zone 1	1377	1480	1576	1624	1702	1734	1803	1863	1904	1976	2063	2149	2222	2309	2395
Zone 2	1425	1532	1631	1681	1762	1795	1866	1928	1971	2045	2135	2224	2300	2390	2479
Zone 3	1473	1584	1686	1738	1821	1855	1929	1993	2037	2114	2207	2299	2378	2471	2563

- Wood arms with upholstered arm caps

Quick Silver Traditional

4831

High back chair



	Overall			Seat								St. Ydg.	Cu. Ft.	Shp. Wt.	Fr. Cls.
	25" W x 28" D x 40-44" H			19.25" W x 18" D x 17.5-21.5" H								3	22.9	55	250
	1	2/COM	3/COL	4	5	6	7	8	9	10	11	12/L	13	14	15/LL
Zone 1	1559	1697	1816	1882	1983	2025	2189	2292	2381	2486	2572	2675	2780	2884	2987
Zone 2	1614	1756	1880	1948	2052	2096	2266	2372	2464	2573	2662	2769	2877	2985	3092
Zone 3	1668	1816	1943	2014	2122	2167	2342	2452	2548	2660	2752	2862	2975	3086	3196

- Tufted back
- Brass nail head trim on arms

4833

Side/guest chair



	Overall			Seat								St. Ydg.	Cu. Ft.	Shp. Wt.	Fr. Cls.
	24" W x 26" D x 33" H			19.25" W x 18" D x 18.5" H								2.5	13.2	29	250
	1	2/COM	3/COL	4	5	6	7	8	9	10	11	12/L	13	14	15/LL
Zone 1	1366	1478	1569	1630	1694	1725	1755	1814	1893	1965	2051	2139	2211	2297	2383
Zone 2	1414	1530	1624	1687	1753	1785	1816	1877	1959	2034	2123	2214	2288	2377	2466
Zone 3	1462	1581	1679	1744	1813	1846	1878	1941	2026	2103	2195	2289	2366	2458	2550

- Tufted back

4837

Mid-back chair



	Overall			Seat								St. Ydg.	Cu. Ft.	Shp. Wt.	Fr. Cls.
	25" W x 26" D x 32-36" H			19.25" W x 18" D x 17.5-21.5" H								2.5	19	51	250
	1	2/COM	3/COL	4	5	6	7	8	9	10	11	12/L	13	14	15/LL
Zone 1	1494	1603	1694	1741	1818	1884	1941	2020	2092	2179	2265	2338	2425	2511	2597
Zone 2	1546	1659	1753	1802	1882	1950	2009	2091	2165	2255	2344	2420	2510	2599	2688
Zone 3	1599	1715	1813	1863	1945	2016	2077	2161	2238	2332	2424	2502	2595	2687	2779

- Tufted back
- Brass nail head trim on arms

Classic Collection

Scoop Contemporary

	Overall	Seat											St. Ydg.	Cu. Ft.	Shp. Wt.	Fr. Cls.	
1001	25" W x 28.5" D x 37-40" H	20" W x 19" D x 17-20.5" H											3	21	53	250	
High back chair		1	2/COM	3/COL	4	5	6	7	8	9	10	11	12/L	13	14	15/LL	
Zone 1		1452	1577	1685	1749	1843	1880	1930	1988	2084	2170	2275	2378	2465	2568	2672	
Zone 2		1503	1632	1744	1810	1908	1946	1998	2058	2157	2246	2355	2461	2551	2658	2766	
Zone 3		1554	1687	1803	1871	1972	2012	2065	2127	2230	2322	2434	2544	2638	2748	2859	
		• Wood arms					• Edge Guard not available										



	Overall	Seat											St. Ydg.	Cu. Ft.	Shp. Wt.	Fr. Cls.	
1003	24" W x 27" D x 33" H	20" W x 19" D x 18.5" H											2	15	31	250	
Side/guest chair		1	2/COM	3/COL	4	5	6	7	8	9	10	11	12/L	13	14	15/LL	
Zone 1		818	904	977	1015	1077	1102	1142	1176	1240	1297	1366	1436	1494	1562	1632	
Zone 2		847	936	1011	1051	1115	1141	1182	1217	1283	1342	1414	1486	1546	1617	1689	
Zone 3		875	967	1045	1086	1152	1179	1222	1258	1327	1388	1462	1537	1599	1671	1746	
		• Wood arms and legs															



	Overall	Seat											St. Ydg.	Cu. Ft.	Shp. Wt.	Fr. Cls.	
1007	25" W x 27" D x 32-35" H	20" W x 19" D x 17-20.5" H											2	19	48	250	
Mid-back chair		1	2/COM	3/COL	4	5	6	7	8	9	10	11	12/L	13	14	15/LL	
Zone 1		1244	1327	1348	1395	1442	1506	1531	1556	1602	1666	1725	1792	1863	1921	1989	
Zone 2		1288	1373	1395	1444	1492	1559	1585	1610	1658	1724	1785	1855	1928	1988	2059	
Zone 3		1331	1420	1442	1493	1543	1611	1638	1665	1714	1783	1846	1917	1993	2055	2128	
		• Wood arms					• Edge Guard not available										



	Overall	Seat											St. Ydg.	Cu. Ft.	Shp. Wt.	Fr. Cls.	
1071	24.5" W x 28" D x 37-40" H	20" W x 19" D x 17-20.5" H											3	21	45	250	
High back chair		1	2/COM	3/COL	4	5	6	7	8	9	10	11	12/L	13	14	15/LL	
Zone 1		1288	1359	1442	1515	1586	1623	1678	1756	1825	1921	2008	2110	2214	2300	2404	
Zone 2		1333	1407	1492	1568	1642	1680	1737	1817	1889	1988	2078	2184	2291	2381	2488	
Zone 3		1378	1454	1543	1621	1697	1737	1795	1879	1953	2055	2149	2258	2369	2461	2572	
		• Black urethane arms					• Edge Guard not available										



	Overall	Seat											St. Ydg.	Cu. Ft.	Shp. Wt.	Fr. Cls.	
1077	24.5" W x 27" D x 32-35" H	20" W x 19" D x 17-20.5" H											2	19	43	250	
Mid-back chair		1	2/COM	3/COL	4	5	6	7	8	9	10	11	12/L	13	14	15/LL	
Zone 1		1198	1279	1356	1424	1459	1511	1556	1620	1678	1747	1816	1874	1944	2012	2082	
Zone 2		1240	1324	1403	1474	1510	1564	1610	1677	1737	1808	1880	1940	2012	2082	2155	
Zone 3		1282	1369	1451	1524	1561	1617	1665	1733	1795	1869	1943	2005	2080	2153	2228	
		• Black urethane arms					• Edge Guard not available										



Scoop Traditional

4141

High back chair



	Overall			Seat								St. Ydg.	Cu. Ft.	Shp. Wt.	Fr. Cls.
	27" W x 31" D x 38.5-42" H			19.5" W x 19" D x 18-21.5" H								4.25	21	62	150
	1	2/COM	3/COL	4	5	6	7	8	9	10	11	12/L	13	14	15/LL
Zone 1	1762	1983	2169	2259	2417	2478	2558	2656	2780	2927	3075	3197	3344	3492	3639
Zone 2	1824	2052	2245	2338	2502	2565	2648	2749	2877	3029	3183	3309	3461	3614	3766
Zone 3	1885	2122	2321	2417	2586	2651	2737	2842	2975	3132	3290	3421	3578	3736	3894

- Tufted seat and back
- Fully upholstered, flared arms

4147

Mid-back chair



	Overall			Seat								St. Ydg.	Cu. Ft.	Shp. Wt.	Fr. Cls.
	26" W x 27.5" D x 32-35" H			19.5" W x 19" D x 18-21.5" H								4	19	50	150
	1	2/COM	3/COL	4	5	6	7	8	9	10	11	12/L	13	14	15/LL
Zone 1	1598	1814	2006	2092	2251	2312	2441	2557	2695	2834	2949	3088	3227	3364	3503
Zone 2	1654	1877	2076	2165	2330	2393	2526	2646	2789	2933	3052	3196	3340	3482	3626
Zone 3	1710	1941	2146	2238	2409	2474	2612	2736	2884	3032	3155	3304	3453	3599	3748

- Tufted seat and back
- Fully upholstered, flared arms

4161

High back chair



	Overall			Seat								St. Ydg.	Cu. Ft.	Shp. Wt.	Fr. Cls.
	25.5" W x 31" D x 38-42" H			19.5" W x 19" D x 18-21.5" H								3.5	14.7	58	250
	1	2/COM	3/COL	4	5	6	7	8	9	10	11	12/L	13	14	15/LL
Zone 1	1587	1748	1877	1956	2077	2124	2213	2324	2426	2547	2668	2769	2891	3011	3133
Zone 2	1643	1809	1943	2024	2150	2198	2290	2405	2511	2636	2761	2866	2992	3116	3243
Zone 3	1698	1870	2008	2093	2222	2273	2368	2487	2596	2725	2855	2963	3093	3222	3352

- Tufted seat and back
- Padded platform arms
- Brass nail trim on arms

4167

Mid-back chair



	Overall			Seat								St. Ydg.	Cu. Ft.	Shp. Wt.	Fr. Cls.
	25.5" W x 27.5" D x 32-35" H			19.5" W x 19" D x 18-21.5" H								3.25	17.1	55	250
	1	2/COM	3/COL	4	5	6	7	8	9	10	11	12/L	13	14	15/LL
Zone 1	1507	1661	1797	1878	1995	2043	2193	2285	2398	2511	2605	2718	2830	2943	3055
Zone 2	1560	1719	1860	1944	2065	2115	2270	2365	2482	2599	2696	2813	2929	3046	3162
Zone 3	1612	1777	1923	2009	2135	2186	2347	2445	2566	2687	2787	2908	3028	3149	3269

- Tufted seat and back
- Padded platform arms
- Brass nail trim on arms

Traditional

2013

Captain's chair



	Overall			Seat								St. Ydg.	Cu. Ft.	Shp. Wt.	Fr. Cls.
	25" W x 23" D x 30.5" H			20" W x 19" D x 19" H								2	11	31	250
	1	2/COM	3/COL	4	5	6	7	8	9	10	11	12/L	13	14	15/LL
Zone 1	877	956	1026	1074	1134	1162	1188	1234	1299	1356	1425	1494	1552	1621	1690
Zone 2	908	989	1062	1112	1174	1203	1230	1277	1344	1403	1475	1546	1606	1678	1749
Zone 3	938	1023	1098	1149	1213	1243	1271	1320	1390	1451	1525	1599	1661	1734	1808

- Brass nail head trim

Classic Collection

2016

Captain's chair on casters



Overall	Seat	St. Ydg.	Cu. Ft.	Shp. Wt.	Fr. Cls.
25" W x 23" D x 30.5" H	20" W x 19" D x 18.5" H	2	13	27	250

	1	2/COM	3/COL	4	5	6	7	8	9	10	11	12/L	13	14	15/LL
Zone 1	961	1047	1121	1160	1221	1272	1320	1382	1441	1511	1578	1637	1707	1774	1845
Zone 2	995	1084	1160	1201	1264	1317	1366	1430	1491	1564	1633	1694	1767	1836	1910
Zone 3	1028	1120	1199	1241	1306	1361	1412	1479	1542	1617	1688	1752	1826	1898	1974

- Brass nail head trim

2177

High back chair



Overall	Seat	St. Ydg.	Cu. Ft.	Shp. Wt.	Fr. Cls.
27" W x 28.5" D x 40-43" H	18.25" W x 19" D x 20-23" H	3.5	21	70	250

	1	2/COM	3/COL	4	5	6	7	8	9	10	11	12/L	13	14	15/LL
Zone 1	1570	1714	1845	1914	2028	2069	2116	2196	2307	2407	2529	2650	2751	2872	2995
Zone 2	1625	1774	1910	1981	2099	2141	2190	2273	2388	2491	2618	2743	2847	2973	3100
Zone 3	1680	1834	1974	2048	2170	2214	2264	2350	2468	2575	2706	2836	2944	3073	3205

- Brass nail head trim on seat
- Fully upholstered flared arms

2277

High back chair



Overall	Seat	St. Ydg.	Cu. Ft.	Shp. Wt.	Fr. Cls.
27" W x 28.5" D x 40-43" H	18.25" W x 19" D x 20-23" H	3.5	23	64	250

	1	2/COM	3/COL	4	5	6	7	8	9	10	11	12/L	13	14	15/LL
Zone 1	1703	1850	1983	2052	2165	2205	2250	2331	2441	2543	2664	2785	2886	3006	3129
Zone 2	1763	1915	2052	2124	2241	2282	2329	2413	2526	2632	2757	2882	2987	3111	3239
Zone 3	1822	1980	2122	2196	2317	2359	2408	2494	2612	2721	2850	2980	3088	3216	3348

- Tufted back
- Brass nail head trim on seat
- Fully upholstered flared arms

3473

Martha Washington guest chair



Overall	Seat	St. Ydg.	Cu. Ft.	Shp. Wt.	Fr. Cls.
24" W x 27" D x 40" H	18.75" W x 18.75" D x 20" H	3	21	35	300

	1	2/COM	3/COL	4	5	6	7	8	9	10	11	12/L	13	14	15/LL
Zone 1	1385	1517	1635	1706	1809	1850	1923	2018	2104	2208	2313	2399	2504	2608	2709
Zone 2	1433	1570	1692	1766	1872	1915	1990	2089	2178	2285	2394	2483	2592	2699	2804
Zone 3	1482	1623	1749	1825	1936	1980	2058	2159	2251	2363	2475	2567	2679	2791	2899

- Upholstered arm caps

Option	Code	Price
Tufted Back	TB	66
Tufted Seat	TS	66
Tufted Seat and Back	TSB	132

3477

Martha Washington mid-back chair



Overall	Seat	St. Ydg.	Cu. Ft.	Shp. Wt.	Fr. Cls.
24" W x 27" D x 40-44" H	18.75" W x 18.75" D x 19.75-23" H	3	21	59	250

	1	2/COM	3/COL	4	5	6	7	8	9	10	11	12/L	13	14	15/LL
Zone 1	1591	1729	1844	1912	2014	2057	2127	2223	2310	2414	2516	2603	2707	2811	2916
Zone 2	1647	1790	1909	1979	2084	2129	2201	2301	2391	2498	2604	2694	2802	2909	3018
Zone 3	1702	1850	1973	2046	2155	2201	2276	2379	2472	2583	2692	2785	2896	3008	3120

- Upholstered arm caps

Option	Code	Price
Tufted Back	TB	66
Tufted Seat	TS	66
Tufted Seat and Back	TSB	132

4013

Captain's chair



Overall	Seat	St. Ydg.	Cu. Ft.	Shp. Wt.	Fr. Cls.
27" W x 25" D x 30" H	22" W x 20.5" D x 19" H	2	13	30	250

	1	2/COM	3/COL	4	5	6	7	8	9	10	11	12/L	13	14	15/LL
Zone 1	1184	1266	1339	1383	1446	1496	1541	1605	1662	1732	1802	1858	1928	1999	2067
Zone 2	1225	1310	1386	1431	1497	1548	1595	1661	1720	1793	1865	1923	1995	2069	2139
Zone 3	1267	1355	1433	1480	1547	1601	1649	1717	1778	1853	1928	1988	2063	2139	2212

- Brass nail heads on back, arms and seat

4016

Captain's chair on casters



Overall	Seat	St. Ydg.	Cu. Ft.	Shp. Wt.	Fr. Cls.
27" W x 25" D x 29.5" H	22" W x 20.5" D x 19" H	2	13	30	250

	1	2/COM	3/COL	4	5	6	7	8	9	10	11	12/L	13	14	15/LL
Zone 1	1297	1376	1450	1494	1555	1582	1608	1655	1717	1776	1845	1913	1973	2042	2110
Zone 2	1342	1424	1501	1546	1609	1637	1664	1713	1777	1838	1910	1980	2042	2113	2184
Zone 3	1388	1472	1552	1599	1664	1693	1721	1771	1837	1900	1974	2047	2111	2185	2258

- Brass nail heads on back, arms and seat

4077

Wing back chair



Overall	Seat	St. Ydg.	Cu. Ft.	Shp. Wt.	Fr. Cls.
25" W x 29" D x 42-46" H	19.5F/16B" W x 18.25" D x 18-21" H	4	21	75	250

	1	2/COM	3/COL	4	5	6	7	8	9	10	11	12/L	13	14	15/LL
Zone 1	1908	2095	2256	2353	2495	2551	2624	2751	2866	3005	3143	3258	3397	3536	3675
Zone 2	1975	2168	2335	2435	2582	2640	2716	2847	2966	3110	3253	3372	3516	3660	3804
Zone 3	2042	2242	2414	2518	2670	2730	2808	2944	3067	3215	3363	3486	3635	3784	3932

- Tufted seat and back
- Brass nail head trim

4078

Wing back executive chair



Overall	Seat	St. Ydg.	Cu. Ft.	Shp. Wt.	Fr. Cls.
29" W x 30" D x 41-45" H	22.5F/18B" W x 19" D x 19-22.5" H	4.5	26	77	250

	1	2/COM	3/COL	4	5	6	7	8	9	10	11	12/L	13	14	15/LL
Zone 1	2304	2540	2753	2876	3057	3126	3252	3384	3538	3694	3823	3979	4135	4292	4447
Zone 2	2385	2629	2849	2977	3164	3235	3366	3502	3662	3823	3957	4118	4280	4442	4603
Zone 3	2465	2718	2946	3077	3271	3345	3480	3621	3786	3953	4091	4258	4424	4592	4758

- Tufted seat and back
- Brass nail head trim

4178

Judge's high back chair



Overall	Seat	St. Ydg.	Cu. Ft.	Shp. Wt.	Fr. Cls.
29" W x 32" D x 42-46" H	23F/18.5B" W x 19.75" D x 19-23" H	4.75	27	80	250

	1	2/COM	3/COL	4	5	6	7	8	9	10	11	12/L	13	14	15/LL
Zone 1	2445	2692	2915	3015	3196	3268	3296	3446	3583	3747	3912	4049	4214	4379	4543
Zone 2	2531	2786	3017	3121	3308	3382	3411	3567	3708	3878	4049	4191	4361	4532	4702
Zone 3	2616	2880	3119	3226	3420	3497	3527	3687	3834	4009	4186	4332	4509	4686	4861

- Brass nail head trim

4277

High back chair



Overall	Seat	St. Ydg.	Cu. Ft.	Shp. Wt.	Fr. Cls.
28" W x 31" D x 48-52" H	18" W x 18" D x 19.5-23.5" H	4.5	27	82	250

	1	2/COM	3/COL	4	5	6	7	8	9	10	11	12/L	13	14	15/LL
Zone 1	2350	2568	2761	2848	2936	3053	3157	3299	3428	3584	3741	3870	4026	4183	4338
Zone 2	2432	2658	2858	2948	3039	3160	3267	3414	3548	3709	3872	4005	4167	4329	4490
Zone 3	2515	2748	2954	3047	3142	3267	3378	3530	3668	3835	4003	4141	4308	4476	4642

- Tufted seat and back
- Brass nail head trim



ETC

OFFICE SEATING - SIN 33721

Thin Profile Office Seating

The ETC chair features a thin profile, compound curved mesh back with a height adjustable lumbar support. The full size seat has an adjustable seat slider to fit a greater range of body sizes up to 300 lbs. Two-way adjustable arms also enable the user to find their maximum armrest comfort. Basic model with a black knit fabric seat or in any HPFi graded-in fabric unassembled in a carton. Options include fully assembled in a carton or "blanket-wrapped" for local pick up.

Product Details

- Adjustable tension, synchro-tilt, locking seat mechanism
- Seat slider seat depth adjustment
- Independent height adjustable lumbar
- Contoured, molded foam seat
- Height and width adjustable, arc surface armrests
- 4" height adjustable pneumatic lift

How to Specify:

- 1** Model number
- 2** Fabric grade & name for seat
- 3** Options

Options	Code	Price
Assembled (cartoned)	A	106
Assembled (blanket-wrapped, local pickup only)	B	53

Finished Example

461 / 5 Mayer Gatsby Dapper / A

HPFi

260 ETC - Office Seating

	Overall	Seat	St. Ydg.	Cu. Ft.	Shp. Wt.	Fr. Cls.
461	24.5" W x 21" D x 40.5 - 43.5" H	20" W x 19.5-21.5" D x 17-22" H	N/A	6	40	125

Mesh mid-back chair;
Black knit fabric seat



Zone 1	806
Zone 2	834
Zone 3	862

• Assembly required

	Overall	Seat	St. Ydg.	Cu. Ft.	Shp. Wt.	Fr. Cls.
461_	24.5" W x 21" D x 40.5 - 43.5" H	20" W x 19.5-21.5" D x 17-21" H	1.0	6	40	125

Mesh mid-back chair;
Grade-In fabric seat

NOW



	1	2/COM	3/COL	4	5	6	7	8	9	10	11	12/L	13	14	15/LL
Zone 1	949	965	988	1004	1020	1043	1066	1090	1111	1140	1166	1198	1229	1255	1287
Zone 2	982	999	1023	1039	1056	1080	1103	1128	1150	1180	1207	1240	1272	1299	1332
Zone 3	1015	1033	1057	1074	1091	1116	1141	1166	1189	1220	1248	1282	1315	1343	1377

• Assembly required



Nexstep

OFFICE/TRAINING SEATING - SIN 33721

Take Your Next Step

The Nexstep collection of seating features the latest in seating materials and contemporary office styles. Featuring a polypropylene mesh back material and breathable fabrics to help you keep your cool, Nexstep seating includes swivel, guest and nesting chairs. 700 Series guest chairs on page 294 are perfect companions to Nexstep chairs.

Product Details

- Engineered wood seat pan and dense foam
- Enhanced quality mesh back with lumbar design
- Dual-bar tubular metal seat/back frame connection
- Black powder coat finish on steel frames

- Waterfall seat front edge
- Polyurethane arm pads on all models
- "G" Models ship fully assembled
- Hybrid soy-based, CFC-free foam

How to Specify:

- 1** Model number
- 2** Fabric grade & name
- 3** Options

Options	Code	Price
Assembly	A	64
Braking Casters	B	38
Glides	GL	N/C
Hard Floor Casters	H	28
Self-Locking Casters	S	111

Finished Example

752G/3 Momentum Tradition Malbec/N/A

Overall	Seat	St. Ydg.	Cu. Ft.	Shp. Wt.	Fr. Cls.
26.5" W x 26.5" D x 38-42" H	20" W x 20" D x 18.5-22.5" H	N/A	6	40	125
		Assembled	22	49	250

752
Mesh mid-back chair;
Black knit fabric seat

NOW



Zone 1	907
Zone 2	939
Zone 3	970

- 360° Swivel seat
- Height adjustable arms

- Black nylon, five-prong base with dual wheel carpet casters

- One touch pneumatic seat height adjustment with 4" range

Overall	Seat	St. Ydg.	Cu. Ft.	Shp. Wt.	Fr. Cls.
26.5" W x 26.5" D x 38-42" H	20" W x 20" D x 18.5-22.5" H	1	22	49	250

752G
Mesh mid-back chair;
Upholstered seat

NOW



	1	2/COM	3/COL	4	5	6	7	8	9	10	11	12/L	13	14	15/LL
Zone 1	1020	1041	1067	1096	1121	1153	1163	1213	1246	1284	1293	1328	1358	1391	1427
Zone 2	1056	1077	1104	1134	1160	1193	1204	1255	1290	1329	1338	1374	1406	1440	1477
Zone 3	1091	1114	1142	1173	1199	1234	1244	1298	1333	1374	1384	1421	1453	1488	1527

- 360° Swivel seat

- Black nylon, five-prong base with dual wheel carpet casters

- One touch pneumatic seat height adjustment with 4" range

- Height adjustable arms

Overall	Seat	St. Ydg.	Cu. Ft.	Shp. Wt.	Fr. Cls.
24" W x 24.5" D x 36.5" H	18" W x 19" D x 19.25" H	N/A	12	33	250

757B
Mesh back training chair;
Black knit fabric seat

NOW



Zone 1	597
Zone 2	618
Zone 3	639

- Fixed height arms

- Nesting

Overall	Seat	St. Ydg.	Cu. Ft.	Shp. Wt.	Fr. Cls.
24" W x 24.5" D x 36.5" H	18" W x 19" D x 19.25" H	1	12	33	250

757
Mesh back training chair;
Upholstered seat

NOW



	1	2/COM	3/COL	4	5	6	7	8	9	10	11	12/L	13	14	15/LL
Zone 1	670	693	713	739	762	790	818	848	877	912	954	981	1012	1044	1076
Zone 2	693	717	738	765	789	818	847	878	908	944	987	1015	1047	1081	1114
Zone 3	717	742	763	791	815	845	875	907	938	976	1021	1050	1083	1117	1151

- Fixed height arms

- Nesting

Overall	Seat	St. Ydg.	Cu. Ft.	Shp. Wt.	Fr. Cls.
26.5" W x 26.5" D x 37.25" H	20" W x 20" D x 19.5" H	N/A	6	38	100
		Assembled	15	40	125

759
Mesh back guest chair;
Black fabric seat

NOW



Zone 1	690
Zone 2	714
Zone 3	738

- Fixed height arms

Overall	Seat	St. Ydg.	Cu. Ft.	Shp. Wt.	Fr. Cls.
26.5" W x 26.5" D x 37.25" H	20" W x 20" D x 19.5" H	1	15	40	250

759G
Mesh back guest chair;
Upholstered seat

NOW



	1	2/COM	3/COL	4	5	6	7	8	9	10	11	12/L	13	14	15/LL
Zone 1	741	767	788	818	842	873	884	935	968	1008	1050	1078	1113	1149	1183
Zone 2	767	794	816	847	871	904	915	968	1002	1043	1087	1116	1152	1189	1224
Zone 3	793	821	843	875	901	934	946	1000	1036	1079	1124	1153	1191	1229	1266

- Fixed height arms



Orbit

MEETING/COLLABORATIVE SEATING - SIN 33721

Out of This World Comfort

The classic design of Orbit fits the modern day demands of the collaborative work or learning environments. Its one-piece, molded plywood construction offers a fixed back angle selected for optimum comfort. The non-tilting seat mechanism offers a full 360 degree swivel. Adjustable floor glides ensure smooth, level operation on any floor surface.

Product Details

- Fully upholstered
- Pneumatic seat height adjustment
- Molded plywood frame construction
- 360° Swivel seat with waterfall front edge

- Five-star chrome-plated base
- Adjustable floor glides
- Hybrid soy-based, CFC-free foam

How to Specify:

- 1 Model number
- 2 Fabric grade & name

Finished Example

5607/2 Mayer Fabrics Fedora Tangelo/N/A

The upholstery selection is crucial due to the curvaceous design of the Orbit chair. The following fabric patterns have been successfully tested for use on Orbit:

Tested Fabrics

Culp Dorset (Grade 1)

Mayer Fedora (Grade 2)

Stinson Blip (Grade 4)

Momentum Faux Felt (Grade 6)

Stinson Haven (Grade 9)

Contact your HPFi representative for specific upholstery options.

5607

Armless swivel chair on glides

Now



	Overall		Seat										St. Ydg.	Cu. Ft.	Shp. Wt.	Fr. Cls.
	22.5" W x 26" D x 33.5-38.5" H		22.5" W x 17.5" D x 16.5-21.5" H										2	20	41	250
	1	2/COM	3/COL	4	5	6	7	8	9	10	11	12/L	13	14	15/LL	
Zone 1	1285	1320	1365	1400	1434	1486	1533	1584	1630	1689	1757	1826	1896	1965	2034	
Zone 2	1330	1366	1413	1449	1484	1538	1587	1639	1687	1748	1818	1890	1962	2034	2105	
Zone 3	1375	1412	1461	1498	1534	1590	1640	1695	1744	1807	1880	1954	2029	2103	2176	



Axxess

GUEST SEATING - SIN 33721 & 337127CSB

Solid Comfort

The Axxess collection features a clean and stylish wood arm design. A steel cross brace construction provides 350 lb. capacity in standard chairs. Available in 3 chair widths - 20", 30" and 40". Ganged versions of Axxess chairs are available in 2-, 3- and 4-seat options with choice of armless, arms between each seat or arms only on the ends.

Product Details

- Solid wood frame
- Steel reinforced seat frame
- Separate seats & backs for easy clean out
- Seats and backs are field replaceable
- Wall-saver leg design

- Chair weight capacity 350 lb.
- Two-color combinations available
- Adjustable glides
- Hybrid soy-based, CFC-free foam

How to Specify:

- 1 Model number
- 2 Wood finish
- 3 Fabric grade & name for back
- 4 Fabric grade & name for seat (if different)
- 5 Option

Options	Code	Price
2 polyurethane arm caps	PC	223
3 polyurethane arm caps	PC3	334
4 polyurethane arm caps	PC4	445
5 polyurethane arm caps	PC5	557

Wood Finishes	Code
Black	BLK
Boardwalk	BW
Driftwood	DW
Espresso	ESP
Mahogany	MAH
Moab	MOB
Monticello Maple	MM
Natural Maple	FM
Shoreline	SL
Windsor Cherry	WC

Finished Example

984/FM/4 Momentum Lens Navy/4 Stinson Laredo Flint/SA

	Overall	Seat											St. Ydg.	Cu. Ft.	Shp. Wt.	Fr. Cls.
980	23" W x 24.75" D x 34.5" H	20" W x 19" D x 18.5" H											2	15	34	250
		1	2/COM	3/COL	4	5	6	7	8	9	10	11	12/L	13	14	15/LL
Zone 1		1094	1128	1174	1208	1242	1293	1339	1390	1435	1492	1560	1629	1698	1766	1834
Zone 2		1132	1167	1215	1250	1285	1338	1386	1439	1485	1544	1615	1686	1757	1828	1898
Zone 3		1171	1207	1256	1293	1329	1384	1433	1487	1535	1596	1669	1743	1817	1890	1962

Wood armless guest chair

NOW



	Overall	Seat											St. Ydg.	Cu. Ft.	Shp. Wt.	Fr. Cls.
980-2	43.75" W x 24.75" D x 34.5" H	20" W x 19" D x 18.5" H											4	36	80	300
		1	2/COM	3/COL	4	5	6	7	8	9	10	11	12/L	13	14	15/LL
Zone 1		2061	2127	2220	2286	2357	2458	2550	2651	2743	2858	2995	3131	3268	3405	3540
Zone 2		2133	2201	2298	2366	2439	2544	2639	2744	2839	2958	3100	3241	3382	3524	3664
Zone 3		2205	2276	2375	2446	2522	2630	2729	2837	2935	3058	3205	3350	3497	3643	3788

Two ganged wood armless guest chairs

NOW



	Overall	Seat											St. Ydg.	Cu. Ft.	Shp. Wt.	Fr. Cls.
980-3	65" W x 24.75" D x 34.5" H	20" W x 19" D x 18.5" H											6	58	102	300
		1	2/COM	3/COL	4	5	6	7	8	9	10	11	12/L	13	14	15/LL
Zone 1		3098	3200	3338	3441	3544	3697	3833	3988	4124	4295	4500	4705	4910	5116	5319
Zone 2		3206	3312	3455	3561	3668	3826	3967	4128	4268	4445	4658	4870	5082	5295	5505
Zone 3		3315	3424	3572	3682	3792	3956	4101	4267	4413	4596	4815	5034	5254	5474	5691

Three ganged wood armless guest chairs

NOW



	Overall	Seat											St. Ydg.	Cu. Ft.	Shp. Wt.	Fr. Cls.
980-4	86.25" W x 24.75" D x 34.5" H	20" W x 19" D x 18.5" H											8	75	135	400
		1	2/COM	3/COL	4	5	6	7	8	9	10	11	12/L	13	14	15/LL
Zone 1		4137	4274	4457	4594	4731	4934	5118	5322	5505	5732	6006	6279	6553	6825	7100
Zone 2		4282	4424	4613	4755	4897	5107	5297	5508	5698	5933	6216	6499	6782	7064	7349
Zone 3		4427	4573	4769	4916	5062	5279	5476	5695	5890	6133	6426	6719	7012	7303	7597

Four ganged wood armless guest chairs

NOW



	Overall	Seat											St. Ydg.	Cu. Ft.	Shp. Wt.	Fr. Cls.
982	33.25" W x 24.75" D x 34.5" H	30" W x 19" D x 18.5" H											2.5	36	70	300
		1	2/COM	3/COL	4	5	6	7	8	9	10	11	12/L	13	14	15/LL
Zone 1		1672	1713	1770	1814	1855	1921	1978	2042	2098	2169	2255	2340	2426	2511	2595
Zone 2		1731	1773	1832	1877	1920	1988	2047	2113	2171	2245	2334	2422	2511	2599	2686
Zone 3		1789	1833	1894	1941	1985	2055	2116	2185	2245	2321	2413	2504	2596	2687	2777

Bariatric wood arm chair, 30" wide seat

NOW



•SIN 337127CSB

Option	Code	Price
750 lb. Bariatric Rating	HB	170
1,000 lb. Bariatric Rating	XB	318

Axxess

983

Bariatric wood arm chair,
40" wide seat

NOW



	Overall			Seat											St. Ydg.	Cu. Ft.	Shp. Wt.	Fr. Cls.
	43.25" W x 24.75" D x 34.5" H			40" W x 19" D x 18.5" H											2.5	36	81	250
	1	2/COM	3/COL	4	5	6	7	8	9	10	11	12/L	13	14	15/LL			
Zone 1	1822	1865	1922	1964	2007	2070	2127	2193	2248	2319	2404	2491	2576	2663	2746			
Zone 2	1886	1930	1989	2033	2077	2142	2201	2270	2327	2400	2488	2578	2666	2756	2842			
Zone 3	1950	1996	2057	2101	2147	2215	2276	2347	2405	2481	2572	2665	2756	2849	2938			

•SIN 337127CSB

Option	Code	Price
750 lb. Bariatric Rating	HB	170
1,000 lb. Bariatric Rating	XB	318

984

Wood arm guest chair

NOW



	Overall			Seat											St. Ydg.	Cu. Ft.	Shp. Wt.	Fr. Cls.
	23" W x 24.75" D x 34.5" H			20" W x 19" D x 18.5" H											2	15	36	250
	1	2/COM	3/COL	4	5	6	7	8	9	10	11	12/L	13	14	15/LL			
Zone 1	1135	1170	1216	1250	1285	1336	1380	1433	1479	1536	1603	1672	1739	1809	1876			
Zone 2	1175	1211	1259	1294	1330	1383	1428	1483	1531	1590	1659	1731	1800	1872	1942			
Zone 3	1214	1252	1301	1338	1375	1430	1477	1533	1583	1644	1715	1789	1861	1936	2007			

984-2

Two ganged wood arm
guest chairs

NOW



	Overall			Seat											St. Ydg.	Cu. Ft.	Shp. Wt.	Fr. Cls.
	43.75" W x 24.75" D x 34.5" H			20" W x 19" D x 18.5" H											4	36	84	300
	1	2/COM	3/COL	4	5	6	7	8	9	10	11	12/L	13	14	15/LL			
Zone 1	2123	2192	2282	2350	2420	2521	2613	2714	2806	2920	3057	3194	3331	3467	3604			
Zone 2	2197	2269	2362	2432	2505	2609	2704	2809	2904	3022	3164	3306	3448	3588	3730			
Zone 3	2272	2345	2442	2515	2589	2697	2796	2904	3002	3124	3271	3418	3564	3710	3856			

984-20

Two ganged wood guest chairs;
Arms on each end

NOW



	Overall			Seat											St. Ydg.	Cu. Ft.	Shp. Wt.	Fr. Cls.
	43.75" W x 24.75" D x 34.5" H			20" W x 19" D x 18.5" H											4	36	82	300
	1	2/COM	3/COL	4	5	6	7	8	9	10	11	12/L	13	14	15/LL			
Zone 1	2102	2170	2261	2331	2399	2501	2592	2695	2786	2899	3036	3173	3309	3446	3583			
Zone 2	2176	2246	2340	2413	2483	2589	2683	2789	2884	3000	3142	3284	3425	3567	3708			
Zone 3	2249	2322	2419	2494	2567	2676	2773	2884	2981	3102	3249	3395	3541	3687	3834			

984-3

Three ganged wood arm
guest chairs

NOW



	Overall			Seat											St. Ydg.	Cu. Ft.	Shp. Wt.	Fr. Cls.
	65" W x 24.75" D x 34.5" H			20" W x 19" D x 18.5" H											6	56	106	300
	1	2/COM	3/COL	4	5	6	7	8	9	10	11	12/L	13	14	15/LL			
Zone 1	3185	3286	3424	3526	3627	3781	3918	4073	4209	4380	4585	4790	4994	5200	5405			
Zone 2	3296	3401	3544	3649	3754	3913	4055	4216	4356	4533	4745	4958	5169	5382	5594			
Zone 3	3408	3516	3664	3773	3881	4046	4192	4358	4504	4687	4906	5125	5344	5564	5783			

984-30

Three ganged wood guest chairs; Arms on each end

NOW



	Overall		Seat										St. Ydg.	Cu. Ft.	Shp. Wt.	Fr. Cls.
	65" W x 24.75" D x 34.5" H		20" W x 19" D x 18.5" H										6	56	108	300
	1	2/COM	3/COL	4	5	6	7	8	9	10	11	12/L	13	14	15/LL	
Zone 1	3141	3245	3381	3483	3585	3740	3876	4030	4166	4338	4543	4747	4952	5158	5361	
Zone 2	3251	3359	3499	3605	3710	3871	4012	4171	4312	4490	4702	4913	5125	5339	5549	
Zone 3	3361	3472	3618	3727	3836	4002	4147	4312	4458	4642	4861	5079	5299	5519	5736	

984-4

Four ganged wood arm guest chairs

NOW



	Overall		Seat										St. Ydg.	Cu. Ft.	Shp. Wt.	Fr. Cls.
	86.25" W x 24.75" D x 34.5" H		20" W x 19" D x 18.5" H										8	75	142	400
	1	2/COM	3/COL	4	5	6	7	8	9	10	11	12/L	13	14	15/LL	
Zone 1	4244	4380	4562	4700	4835	5041	5224	5429	5611	5838	6112	6385	6659	6930	7204	
Zone 2	4393	4533	4722	4865	5004	5217	5407	5619	5807	6042	6326	6608	6892	7173	7456	
Zone 3	4541	4687	4881	5029	5173	5394	5590	5809	6004	6247	6540	6832	7125	7415	7708	

984-40

Four ganged wood guest chairs; Arms on each end

NOW



	Overall		Seat										St. Ydg.	Cu. Ft.	Shp. Wt.	Fr. Cls.
	86.25" W x 24.75" D x 34.5" H		20" W x 19" D x 18.5" H										8	77	123	300
	1	2/COM	3/COL	4	5	6	7	8	9	10	11	12/L	13	14	15/LL	
Zone 1	4183	4318	4500	4638	4773	4980	5161	5368	5548	5777	6050	6323	6596	6869	7142	
Zone 2	4329	4469	4658	4800	4940	5154	5342	5556	5742	5979	6262	6544	6827	7109	7392	
Zone 3	4476	4620	4815	4963	5107	5329	5522	5744	5936	6181	6474	6766	7058	7350	7642	



Contempo

GUEST SEATING - SIN 33721

Elegant Design

Contempo presents elegant wood guest seating with extensive design flexibility. Solid hardwood frames offer the unique characteristics of wood. Select from six precision cut, multiple-layer hardwood plywood back designs: Partially Upholstered, Fully Upholstered, Hourglass, Fan, Ladder and Puzzle back. Available in armless or two arm designs - curvilinear and scalloped.

Product Details

- Commercial-grade engineered hardwood frame
- Frame components are double-doweled, glued, stapled and screwed
- Reinforcing corner blocks are glued and stapled
- Non-marring floor glides

- Seat and back Sytex web suspension
- Hybrid soy-based, CFC-free foam

How to Specify:

- 1 Model number
- 2 Wood finish
- 3 Fabric grade & name for back
- 4 Fabric grade & name for seat (if different)
- 5 Option

Finished Example

9500/FM/4 Momentum Lineup Baltic/C

Options	Code	Price
Casters	C	67

Wood Finishes	Code
Black	BLK
Boardwalk	BW
Driftwood	DW
Espresso	ESP
Mahogany	MAH
Moab	MOB
Monticello Maple	MM
Natural Maple	FM
Shoreline	SL
Windsor Cherry	WC

	Overall		Seat										St. Ydg.	Cu. Ft.	Shp. Wt.	Fr. Cls.
	20" W x 22" D x 34" H		20" W x 18.5" D x 19" H										1	15	31	250
	1	2/COM	3/COL	4	5	6	7	8	9	10	11	12/L	13	14	15/LL	
9400																
Armless wood guest chair; hourglass back																
NOW																
																
Zone 1	1095	1149	1193	1221	1262	1277	1308	1343	1384	1434	1468	1500	1533	1595	1659	
Zone 2	1133	1189	1235	1264	1306	1322	1354	1390	1432	1484	1519	1553	1587	1651	1717	
Zone 3	1172	1229	1277	1306	1350	1366	1400	1437	1481	1534	1571	1605	1640	1707	1775	

	Overall		Seat										St. Ydg.	Cu. Ft.	Shp. Wt.	Fr. Cls.
	22.5" W x 22" D x 34" H		20" W x 18.5" D x 19" H										1	15	32	250
	1	2/COM	3/COL	4	5	6	7	8	9	10	11	12/L	13	14	15/LL	
9403																
Wood guest chair; Curvilinear arms; hourglass back																
NOW																
																
Zone 1	1174	1225	1273	1327	1376	1438	1464	1570	1635	1714	1738	1809	1877	1951	2010	
Zone 2	1215	1268	1318	1373	1424	1488	1515	1625	1692	1774	1799	1872	1943	2019	2080	
Zone 3	1256	1311	1362	1420	1472	1539	1566	1680	1749	1834	1860	1936	2008	2088	2151	

	Overall		Seat										St. Ydg.	Cu. Ft.	Shp. Wt.	Fr. Cls.
	22.5" W x 22" D x 34" H		20" W x 18.5" D x 19" H										1	15	32	250
	1	2/COM	3/COL	4	5	6	7	8	9	10	11	12/L	13	14	15/LL	
9405																
Wood guest chair; Scalloped arms; hourglass back																
NOW																
																
Zone 1	1174	1225	1273	1327	1376	1438	1464	1570	1635	1714	1738	1809	1877	1951	2010	
Zone 2	1215	1268	1318	1373	1424	1488	1515	1625	1692	1774	1799	1872	1943	2019	2080	
Zone 3	1256	1311	1362	1420	1472	1539	1566	1680	1749	1834	1860	1936	2008	2088	2151	

	Overall		Seat										St. Ydg.	Cu. Ft.	Shp. Wt.	Fr. Cls.
	20" W x 22" D x 34" H		20" W x 18.5" D x 19" H										1	15	32	250
	1	2/COM	3/COL	4	5	6	7	8	9	10	11	12/L	13	14	15/LL	
9410																
Armless wood guest chair; Fan back																
NOW																
																
Zone 1	1095	1149	1193	1221	1262	1277	1308	1343	1384	1434	1468	1500	1533	1595	1659	
Zone 2	1133	1189	1235	1264	1306	1322	1354	1390	1432	1484	1519	1553	1587	1651	1717	
Zone 3	1172	1229	1277	1306	1350	1366	1400	1437	1481	1534	1571	1605	1640	1707	1775	

Contempo

	Overall	Seat											St. Ydg.	Cu. Ft.	Shp. Wt.	Fr. Cls.	
9413	22.5" W x 22" D x 34" H	20" W x 18.5" D x 19" H											1	15	32	250	
		1	2/COM	3/COL	4	5	6	7	8	9	10	11	12/L	13	14	15/LL	
Zone 1	1174	1225	1273	1327	1376	1438	1464	1570	1635	1714	1738	1809	1877	1951	2010		
Zone 2	1215	1268	1318	1373	1424	1488	1515	1625	1692	1774	1799	1872	1943	2019	2080		
Zone 3	1256	1311	1362	1420	1472	1539	1566	1680	1749	1834	1860	1936	2008	2088	2151		

Wood guest chair;
Curvilinear arms; Fan back

NOW



	Overall	Seat											St. Ydg.	Cu. Ft.	Shp. Wt.	Fr. Cls.	
9415	22.5" W x 22" D x 34" H	20" W x 18.5" D x 19" H											1	15	32	250	
		1	2/COM	3/COL	4	5	6	7	8	9	10	11	12/L	13	14	15/LL	
Zone 1	1174	1225	1273	1327	1376	1438	1464	1570	1635	1714	1738	1809	1877	1951	2010		
Zone 2	1215	1268	1318	1373	1424	1488	1515	1625	1692	1774	1799	1872	1943	2019	2080		
Zone 3	1256	1311	1362	1420	1472	1539	1566	1680	1749	1834	1860	1936	2008	2088	2151		

Wood guest chair;
Scalloped arms; Fan back

NOW



	Overall	Seat											St. Ydg.	Cu. Ft.	Shp. Wt.	Fr. Cls.	
9420	20" W x 22" D x 34" H	20" W x 18.5" D x 19" H											1	15	31	250	
		1	2/COM	3/COL	4	5	6	7	8	9	10	11	12/L	13	14	15/LL	
Zone 1	1095	1149	1193	1221	1262	1277	1308	1343	1384	1434	1468	1500	1533	1595	1659		
Zone 2	1133	1189	1235	1264	1306	1322	1354	1390	1432	1484	1519	1553	1587	1651	1717		
Zone 3	1172	1229	1277	1306	1350	1366	1400	1437	1481	1534	1571	1605	1640	1707	1775		

Armless wood guest chair;
Wood ladder back

NOW



	Overall	Seat											St. Ydg.	Cu. Ft.	Shp. Wt.	Fr. Cls.	
9423	22.5" W x 22" D x 34" H	20" W x 18.5" D x 19" H											1	15	32	250	
		1	2/COM	3/COL	4	5	6	7	8	9	10	11	12/L	13	14	15/LL	
Zone 1	1174	1225	1273	1327	1376	1438	1464	1570	1635	1714	1738	1809	1877	1951	2010		
Zone 2	1215	1268	1318	1373	1424	1488	1515	1625	1692	1774	1799	1872	1943	2019	2080		
Zone 3	1256	1311	1362	1420	1472	1539	1566	1680	1749	1834	1860	1936	2008	2088	2151		

Wood guest chair; Curvilinear
arms; Ladder back design

NOW



9425

Wood guest chair;
Scalloped arms; Ladder back

NOW



	Overall		Seat										St. Ydg.	Cu. Ft.	Shp. Wt.	Fr. Cls.
	22.5" W x 22.5" D x 34" H		20" W x 18.5" D x 19" H										13.5	15	32	250
	1	2/COM	3/COL	4	5	6	7	8	9	10	11	12/L	13	14	15/LL	
Zone 1	1174	1225	1273	1327	1376	1438	1464	1570	1635	1714	1738	1809	1877	1951	2010	
Zone 2	1215	1268	1318	1373	1424	1488	1515	1625	1692	1774	1799	1872	1943	2019	2080	
Zone 3	1256	1311	1362	1420	1472	1539	1566	1680	1749	1834	1860	1936	2008	2088	2151	

9430

Armless wood guest chair;
Wood puzzle back

NOW



	Overall		Seat										St. Ydg.	Cu. Ft.	Shp. Wt.	Fr. Cls.
	20" W x 22" D x 34" H		20" W x 18.5" D x 19" H										1	15	32	250
	1	2/COM	3/COL	4	5	6	7	8	9	10	11	12/L	13	14	15/LL	
Zone 1	1095	1149	1193	1221	1262	1277	1308	1343	1384	1434	1468	1500	1533	1595	1659	
Zone 2	1133	1189	1235	1264	1306	1322	1354	1390	1432	1484	1519	1553	1587	1651	1717	
Zone 3	1172	1229	1277	1306	1350	1366	1400	1437	1481	1534	1571	1605	1640	1707	1775	

9433

Wood guest chair;
Curvilinear arms; Puzzle back

NOW



	Overall		Seat										St. Ydg.	Cu. Ft.	Shp. Wt.	Fr. Cls.
	22.5" W x 22" D x 34" H		20" W x 18.5" D x 19" H										1	15	32	250
	1	2/COM	3/COL	4	5	6	7	8	9	10	11	12/L	13	14	15/LL	
Zone 1	1174	1225	1273	1327	1376	1438	1464	1570	1635	1714	1738	1809	1877	1951	2010	
Zone 2	1215	1268	1318	1373	1424	1488	1515	1625	1692	1774	1799	1872	1943	2019	2080	
Zone 3	1256	1311	1362	1420	1472	1539	1566	1680	1749	1834	1860	1936	2008	2088	2151	

9435

Wood guest chair;
Scalloped arms; Puzzle back

NOW



	Overall		Seat										St. Ydg.	Cu. Ft.	Shp. Wt.	Fr. Cls.
	22.5" W x 22" D x 34" H		20" W x 18.5" D x 19" H										1	15	32	250
	1	2/COM	3/COL	4	5	6	7	8	9	10	11	12/L	13	14	15/LL	
Zone 1	1174	1225	1273	1327	1376	1438	1464	1570	1635	1714	1738	1809	1877	1951	2010	
Zone 2	1215	1268	1318	1373	1424	1488	1515	1625	1692	1774	1799	1872	1943	2019	2080	
Zone 3	1256	1311	1362	1420	1472	1539	1566	1680	1749	1834	1860	1936	2008	2088	2151	

Contempo

	Overall	St. Ydg.	Cu. Ft.	Shp. Wt.	Fr. Cls.
94CTC	10" W x 3.5" D x 1.225" H	N/A	0.2	0.5	70

Chair-to-Chair Ganging Bracket

NOW

Zone 1	45
Zone 2	45
Zone 3	45

	Overall	Seat															St. Ydg.	Cu. Ft.	Shp. Wt.	Fr. Cls.
9500	20" W x 22" D x 34" H	20" W x 18.5" D x 19" H															1.5	15	35	250

Armless wood guest chair;
Fully upholstered back

NOW



	1	2/COM	3/COL	4	5	6	7	8	9	10	11	12/L	13	14	15/LL
Zone 1	1174	1225	1273	1327	1376	1438	1464	1570	1635	1714	1734	1781	1829	1876	2010
Zone 2	1215	1268	1318	1373	1424	1488	1515	1625	1692	1774	1795	1843	1893	1942	2080
Zone 3	1256	1311	1362	1420	1472	1539	1566	1680	1749	1834	1855	1906	1957	2007	2151

	Overall	Seat															St. Ydg.	Cu. Ft.	Shp. Wt.	Fr. Cls.
9503	22.5" W x 22" D x 34" H	20" W x 18.5" D x 19" H															1.5	15	32	250

Wood guest chair; Curvilinear
arms; Fully upholstered back

NOW



	1	2/COM	3/COL	4	5	6	7	8	9	10	11	12/L	13	14	15/LL
Zone 1	1273	1358	1432	1477	1541	1564	1617	1668	1733	1814	1882	1928	1976	2024	2198
Zone 2	1318	1406	1482	1529	1595	1619	1674	1726	1794	1877	1948	1995	2045	2095	2275
Zone 3	1362	1453	1532	1580	1649	1673	1730	1785	1854	1941	2014	2063	2114	2166	2352

	Overall	Seat															St. Ydg.	Cu. Ft.	Shp. Wt.	Fr. Cls.
9505	22.5" W x 22" D x 34" H	20" W x 18.5" D x 19" H															1.5	15	35	250

Wood guest chair; Scalloped
arms; Fully upholstered back

NOW



	1	2/COM	3/COL	4	5	6	7	8	9	10	11	12/L	13	14	15/LL
Zone 1	1273	1358	1432	1477	1541	1564	1617	1668	1733	1814	1882	1928	1976	2024	2198
Zone 2	1318	1406	1482	1529	1595	1619	1674	1726	1794	1877	1948	1995	2045	2095	2275
Zone 3	1362	1453	1532	1580	1649	1673	1730	1785	1854	1941	2014	2063	2114	2166	2352

9510

Armless wood guest chair;
Partially upholstered back

NOW



	Overall		Seat										St. Ydg.	Cu. Ft.	Shp. Wt.	Fr. Cls.
	20" W x 22" D x 34" H		20" W x 18.5" D x 19" H										1.5	15	33	250
	1	2/COM	3/COL	4	5	6	7	8	9	10	11	12/L	13	14	15/LL	
Zone 1	1174	1225	1273	1327	1376	1438	1464	1570	1635	1714	1734	1781	1829	1876	2010	
Zone 2	1215	1268	1318	1373	1424	1488	1515	1625	1692	1774	1795	1843	1893	1942	2080	
Zone 3	1256	1311	1362	1420	1472	1539	1566	1680	1749	1834	1855	1906	1957	2007	2151	

9513

Wood guest chair; Curvilinear
arms; Partially upholstered back

NOW



	Overall		Seat										St. Ydg.	Cu. Ft.	Shp. Wt.	Fr. Cls.
	22.5" W x 22" D x 34" H		20" W x 18.5" D x 19" H										1.5	15	37	250
	1	2/COM	3/COL	4	5	6	7	8	9	10	11	12/L	13	14	15/LL	
Zone 1	1273	1358	1432	1477	1541	1564	1617	1668	1733	1814	1882	1928	1976	2024	2198	
Zone 2	1318	1406	1482	1529	1595	1619	1674	1726	1794	1877	1948	1995	2045	2095	2275	
Zone 3	1362	1453	1532	1580	1649	1673	1730	1785	1854	1941	2014	2063	2114	2166	2352	

9515

Wood guest chair; Scalloped
arms; Partially upholstered back

NOW



	Overall		Seat										St. Ydg.	Cu. Ft.	Shp. Wt.	Fr. Cls.
	22.5" W x 22" D x 34" H		20" W x 18.5" D x 19" H										1.5	15	32	250
	1	2/COM	3/COL	4	5	6	7	8	9	10	11	12/L	13	14	15/LL	
Zone 1	1273	1358	1432	1477	1541	1564	1617	1668	1733	1814	1882	1928	1976	2024	2198	
Zone 2	1318	1406	1482	1529	1595	1619	1674	1726	1794	1877	1948	1995	2045	2095	2275	
Zone 3	1362	1453	1532	1580	1649	1673	1730	1785	1854	1941	2014	2063	2114	2166	2352	



Trados

GUEST SEATING - SIN 33721 & SIN 337127CSB

Solid Comfort, Unique Design

The Trados wood collection features a striking triarc arm design and solid frame. Steel cross brace construction provides 350 lb. capacity. Bariatric seating also includes steel cross braces in the back and offers a standard weight capacity of 500 lb. with 750 lb. and 1,000 lb. options. All seating units, corner and connecting tables can be ganged in a virtually unlimited number of combinations.

Product Details

- Tri-arc arm design
- Solid wood frame with steel reinforced seat
- Separate seats & backs for easy clean out
- Seats and backs are field replaceable

- Chair weight capacity 350 lb., bariatric chair rated to 500 lbs.
- Two-color combinations available, priced at higher grade
- Adjustable glides
- Hybrid soy-based, CFC-free foam

How to Specify:

- 1 Model number
- 2 Wood finish
- 3 Fabric grade & name for back
- 4 Fabric grade & name for seat (if different)
- 5 Options

Options	Price	Code
2 polyurethane arm caps	PC	223
3 polyurethane arm caps	PC3	334
4 polyurethane arm caps	PC4	445
5 polyurethane arm caps	PC5	557

Wood Finishes	Code
Black	BLK
Boardwalk	BW
Driftwood	DW
Espresso	ESP
Mahogany	MAH
Moab	MOB
Monticello Maple	MM
Natural Maple	FM
Shoreline	SL
Windsor Cherry	WC

Finished Example

914/FM/6 Momentum Faux Felt Stone/8 Momentum Waver Bisque/PC

912

Bariatric wood triarc arm chair,
30" wide seat

NOW



Overall	Seat											St. Ydg.	Cu. Ft.	Shp. Wt.	Fr. Cls.
33" W x 25" D x 35" H	30" W x 19" D x 18" H											2.5	36	65	175
	1	2/COM	3/COL	4	5	6	7	8	9	10	11	12/L	13	14	15/LL
Zone 1	1358	1402	1462	1506	1551	1618	1677	1745	1803	1878	1907	1985	2065	2131	2299
Zone 2	1406	1451	1513	1559	1605	1675	1736	1806	1866	1944	1974	2054	2137	2206	2379
Zone 3	1453	1500	1564	1611	1660	1731	1794	1867	1929	2009	2040	2124	2210	2280	2460

•SIN 337127CSB

Option	Code	Price
750 lb. Bariatric Rating	HB	170
1,000 lb. Bariatric Rating	XB	318

913

Bariatric wood triarc arm chair,
40" wide seat

NOW



Overall	Seat											St. Ydg.	Cu. Ft.	Shp. Wt.	Fr. Cls.
43" W x 25" D x 35" H	40" W x 19" D x 18" H											3	36	81	175
	1	2/COM	3/COL	4	5	6	7	8	9	10	11	12/L	13	14	15/LL
Zone 1	1526	1580	1653	1707	1760	1841	1911	1992	2064	2153	2186	2282	2377	2456	2663
Zone 2	1579	1635	1711	1767	1822	1905	1978	2062	2136	2228	2263	2362	2460	2542	2756
Zone 3	1633	1691	1769	1826	1883	1970	2045	2131	2208	2304	2339	2442	2543	2628	2849

•SIN 337127CSB

Option	Code	Price
750 lb. Bariatric Rating	HB	170
1,000 lb. Bariatric Rating	XB	318

914

Triarc wood armchair

NOW



Overall	Seat											St. Ydg.	Cu. Ft.	Shp. Wt.	Fr. Cls.
22.5" W x 25" D x 35" H	20" W x 19" D x 18" H											2	15	37	250
	1	2/COM	3/COL	4	5	6	7	8	9	10	11	12/L	13	14	15/LL
Zone 1	1060	1155	1246	1268	1329	1417	1505	1590	1676	1786	1871	1933	1999	2062	2381
Zone 2	1097	1195	1290	1312	1376	1467	1558	1646	1735	1849	1936	2001	2069	2134	2464
Zone 3	1134	1236	1333	1357	1422	1516	1610	1701	1793	1911	2002	2068	2139	2206	2548

Option	Code	Price
Casters	C	67

914-2

Two ganged wood triarc
armchairs

NOW



Overall	Seat											St. Ydg.	Cu. Ft.	Shp. Wt.	Fr. Cls.
44.5" W x 25" D x 35" H	20" W x 19" D x 18" H											5	36	78	250
	1	2/COM	3/COL	4	5	6	7	8	9	10	11	12/L	13	14	15/LL
Zone 1	2036	2084	2127	2221	2302	2426	2547	2711	2876	3040	3134	3292	3451	3584	3743
Zone 2	2107	2157	2201	2299	2383	2511	2636	2806	2977	3146	3244	3407	3572	3709	3874
Zone 3	2179	2230	2276	2376	2463	2596	2725	2901	3077	3253	3353	3522	3693	3835	4005

Trados

914-3

Three ganged wood triarc armchairs

NOW



	Overall	Seat											St. Ydg.	Cu. Ft.	Shp. Wt.	Fr. Cls.
	66.5" W x 25" D x 35" H	20" W x 19" D x 18" H											7	55	108	300
	1	2/COM	3/COL	4	5	6	7	8	9	10	11	12/L	13	14	15/LL	
Zone 1	3055	3102	3146	3239	3453	3640	3822	4069	4315	4559	4592	4705	4813	5037	5115	
Zone 2	3162	3211	3256	3352	3574	3767	3956	4211	4466	4719	4753	4870	4981	5213	5294	
Zone 3	3269	3319	3366	3466	3695	3895	4090	4354	4617	4878	4913	5034	5150	5390	5473	

914-4

Four ganged wood triarc armchairs

NOW



	Overall	Seat											St. Ydg.	Cu. Ft.	Shp. Wt.	Fr. Cls.
	88" W x 25" D x 35" H	20" W x 19" D x 18" H											9	75	142	400
	1	2/COM	3/COL	4	5	6	7	8	9	10	11	12/L	13	14	15/LL	
Zone 1	4071	4117	4165	4318	4604	4851	5098	5425	5752	6078	6231	6334	6407	6620	6858	
Zone 2	4213	4261	4311	4469	4765	5021	5276	5615	5953	6291	6449	6556	6631	6852	7098	
Zone 3	4356	4405	4457	4620	4926	5191	5455	5805	6155	6503	6667	6777	6855	7083	7338	

915

High back patient/guest wood triarc arm chair

NOW



	Overall	Seat											St. Ydg.	Cu. Ft.	Shp. Wt.	Fr. Cls.
	22.75" W x 25" D x 46" H	20" W x 19" D x 18" H											3	24	43	300
	1	2/COM	3/COL	4	5	6	7	8	9	10	11	12/L	13	14	15/LL	
Zone 1	1188	1248	1317	1430	1508	1610	1712	1814	1916	2045	2118	2143	2212	2309	2461	
Zone 2	1230	1292	1363	1480	1561	1666	1772	1877	1983	2117	2192	2218	2289	2390	2547	
Zone 3	1271	1335	1409	1530	1614	1723	1832	1941	2050	2188	2266	2293	2367	2471	2633	

Option	Code	Price
Casters	C	67

916

Wood triarc arm two-seat settee

NOW



	Overall	Seat											St. Ydg.	Cu. Ft.	Shp. Wt.	Fr. Cls.
	48" W x 25" D x 35" H	45" W x 19" D x 18" H											3.24	37	64	175
	1	2/COM	3/COL	4	5	6	7	8	9	10	11	12/L	13	14	15/LL	
Zone 1	1700	1759	1836	1893	1951	2038	2117	2204	2281	2377	2450	2516	2620	2706	2927	
Zone 2	1760	1821	1900	1959	2019	2109	2191	2281	2361	2460	2536	2604	2712	2801	3029	
Zone 3	1819	1882	1965	2026	2088	2181	2265	2358	2441	2543	2622	2692	2803	2895	3132	

	Overall	St. Ydg.	Cu. Ft.	Shp. Wt.	Fr. Cls.
917 Trados Connecting Table	20" W x 21.5" D x 15.5" H	N/A	3	22	125

Zone 1	642	• Includes attachment hardware
Zone 2	664	
Zone 3	687	



	Overall	Seat	St. Ydg.	Cu. Ft.	Shp. Wt.	Fr. Cls.
918 Wood triarc arm bench	48" W x 25" D x 25.5" H	45" W x 19" D x 18" H	2	36	75	175

	1	2/COM	3/COL	4	5	6	7	8	9	10	11	12/L	13	14	15/LL
Zone 1	1317	1343	1365	1407	1501	1655	1736	1816	1902	1926	1950	2000	2063	2110	2195
Zone 2	1363	1390	1413	1456	1554	1713	1797	1880	1969	1993	2018	2070	2135	2184	2272
Zone 3	1409	1437	1461	1505	1606	1771	1858	1943	2035	2061	2087	2140	2207	2258	2349



	Overall	St. Ydg.	Cu. Ft.	Shp. Wt.	Fr. Cls.
919 Trados Corner Table	28.5" W x 28.5" D x 15.5" H	N/A	4	35	100

Zone 1	1130	• Includes leg for rear corner and attachment hardware
Zone 2	1170	
Zone 3	1209	





Trados Metal

GUEST SEATING - SIN 33721 & SIN 337127CSB

Solid Comfort, Modern Appeal

The Trados Metal guest seating collection features a triarc arm design enhanced by a smooth, silver finish, rugged steel frame. This elegant yet sturdy chair can be further enhanced by the addition of optional wood arm caps in a variety of finishes or in an anti-microbial urethane arm cap. The steel cross brace and heavy gauge steel frame construction provide a 350 lb. capacity in the guest and patient chairs, the settee and bench. Bariatric seating offers a standard weight capacity of 500 lb. with 750 lb. and 1,000 lb. options.

Product Details

- Tri-arc arm design
- Rugged all steel frame construction
- Separate seats & backs for easy clean out
- Seats and backs are field replaceable

- Chair weight capacity 350 lb., bariatric chair rated to 500 lbs.
- Two-color combinations available, priced at higher grade
- Adjustable glides
- Hybrid soy-based, CFC-free foam

How to Specify:

- 1 Model number
- 2 Fabric grade & name for back
- 3 Fabric grade & name for seat (if different)
- 4 Options

Options	Code	Price
2 polyurethane arm caps	PC	223
3 polyurethane arm caps	PC3	334
4 polyurethane arm caps	PC4	445
5 polyurethane arm caps	PC5	557
2 finished wood arm caps	WA	110
3 finished wood arm caps	WA3	165
4 finished wood arm caps	WA4	220
5 finished wood arm caps	WA5	275

Wood Finishes	Code
Black	BLK
Boardwalk	BW
Driftwood	DW
Espresso	ESP
Mahogany	MAH
Moab	MOB
Monticello Maple	MM
Natural Maple	FM
Shoreline	SL
Windsor Cherry	WC

Finished Example

914MET/FM/5 Momentum Riddle Chalkboard/5 Douglass Symphony Classic Black/WA

HPFi

280 Trados Metal - Guest Seating

912MET

Bariatric steel triarc arm chair,
30" wide seat

NOW



	Overall		Seat								St. Ydg.	Cu. Ft.	Shp. Wt.	Fr. Cls.	
	33" W x 25" D x 35" H		30" W x 19" D x 18" H								2.5	36	72	175	
	1	2/COM	3/COL	4	5	6	7	8	9	10	11	12/L	13	14	15/LL
Zone 1	1555	1601	1660	1703	1749	1816	1875	1944	2002	2077	2104	2184	2263	2331	2490
Zone 2	1609	1657	1718	1763	1810	1880	1941	2012	2072	2150	2178	2260	2342	2413	2577
Zone 3	1664	1713	1776	1822	1871	1943	2006	2080	2142	2222	2251	2337	2421	2494	2664

•SIN 337127CSB

Option	Code	Price
750 lb. Bariatric Rating	HB	170
1,000 lb. Bariatric Rating	XB	318

913MET

Bariatric steel triarc arm chair,
40" wide seat

NOW

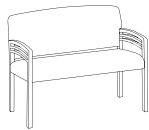

	Overall		Seat								St. Ydg.	Cu. Ft.	Shp. Wt.	Fr. Cls.	
	43" W x 25" D x 35" H		40" W x 19" D x 18" H								3	36	89	175	
	1	2/COM	3/COL	4	5	6	7	8	9	10	11	12/L	13	14	15/LL
Zone 1	1751	1803	1874	1928	1982	2063	2134	2213	2285	2374	2408	2505	2600	2774	2876
Zone 2	1812	1866	1940	1995	2051	2135	2209	2290	2365	2457	2492	2593	2691	2871	2977
Zone 3	1874	1929	2005	2063	2121	2207	2283	2368	2445	2540	2577	2680	2782	2968	3077

•SIN 337127CSB

Option	Code	Price
750 lb. Bariatric Rating	HB	170
1,000 lb. Bariatric Rating	XB	318

914MET

Steel triarc armchair

NOW



	Overall		Seat								St. Ydg.	Cu. Ft.	Shp. Wt.	Fr. Cls.	
	22.5" W x 25" D x 35" H		20" W x 19" D x 18" H								2	15	46	250	
	1	2/COM	3/COL	4	5	6	7	8	9	10	11	12/L	13	14	15/LL
Zone 1	1213	1278	1358	1409	1469	1552	1635	1714	1798	1902	1930	1960	2095	2213	2458
Zone 2	1255	1323	1406	1458	1520	1606	1692	1774	1861	1969	1998	2029	2168	2290	2544
Zone 3	1298	1367	1453	1508	1572	1661	1749	1834	1924	2035	2065	2097	2242	2368	2630

914MET-2

Two ganged steel triarc
armchairs

NOW

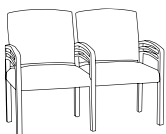

	Overall		Seat								St. Ydg.	Cu. Ft.	Shp. Wt.	Fr. Cls.	
	44.5" W x 25" D x 35" H		30" W x 19" D x 18" H								5	38	95	250	
	1	2/COM	3/COL	4	5	6	7	8	9	10	11	12/L	13	14	15/LL
Zone 1	2333	2465	2620	2721	2844	3007	3170	3336	3499	3704	3880	4039	4198	4516	4823
Zone 2	2415	2551	2712	2816	2944	3112	3281	3453	3621	3834	4016	4180	4345	4674	4992
Zone 3	2496	2638	2803	2911	3043	3217	3392	3570	3744	3963	4152	4322	4492	4832	5161

Trados Metal

914MET-3

Three ganged triarc steel armchairs

NOW

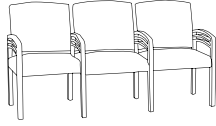

	Overall			Seat										St. Ydg.	Cu. Ft.	Shp. Wt.	Fr. Cls.		
	66.5" W x 25" D x 35" H			30" W x 19" D x 18" H										7	57	129	250		
	1	2/COM	3/COL	4	5	6	7	8	9	10	11	12/L	13	14	15/LL				
Zone 1	3499	3698	3930	4083	4268	4515	4759	5004	5251	5558	5888	6143	6332	6778	7237				
Zone 2	3621	3827	4068	4226	4417	4673	4926	5179	5435	5753	6094	6358	6554	7015	7490				
Zone 3	3744	3957	4205	4369	4567	4831	5092	5354	5619	5947	6300	6573	6775	7252	7744				

914MET-4

Four ganged steel triarc armchair

NOW

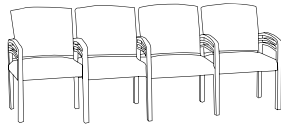

	Overall			Seat										St. Ydg.	Cu. Ft.	Shp. Wt.	Fr. Cls.		
	88" W x 25" D x 35" H			30" W x 19" D x 18" H										9	75	158	250		
	1	2/COM	3/COL	4	5	6	7	8	9	10	11	12/L	13	14	15/LL				
Zone 1	4665	4931	5243	5442	5688	6017	6345	6673	6998	7409	7737	8022	8308	8593	9166				
Zone 2	4828	5104	5427	5632	5887	6228	6567	6907	7243	7668	8008	8303	8599	8894	9487				
Zone 3	4992	5276	5610	5823	6086	6438	6789	7140	7488	7928	8279	8584	8890	9195	9808				

915MET

High back patient/guest steel triarc arm chair

NOW



	Overall			Seat										St. Ydg.	Cu. Ft.	Shp. Wt.	Fr. Cls.		
	22.75" W x 25" D x 46" H			20" W x 19" D x 18" H										3	24	52	250		
	1	2/COM	3/COL	4	5	6	7	8	9	10	11	12/L	13	14	15/LL				
Zone 1	1360	1444	1542	1604	1682	1784	1886	1986	2091	2221	2290	2383	2479	2670	2922				
Zone 2	1408	1495	1596	1660	1741	1846	1952	2056	2164	2299	2370	2466	2566	2763	3024				
Zone 3	1455	1545	1650	1716	1800	1909	2018	2125	2237	2376	2450	2550	2653	2857	3127				

916MET

Steel triarc arm two-seat settee

NOW

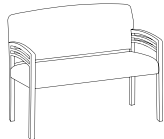

	Overall			Seat										St. Ydg.	Cu. Ft.	Shp. Wt.	Fr. Cls.		
	48" W x 25" D x 35" H			45" W x 19" D x 18" H										3.5	37	82	175		
	1	2/COM	3/COL	4	5	6	7	8	9	10	11	12/L	13	14	15/LL				
Zone 1	1949	2008	2086	2143	2201	2286	2365	2453	2530	2626	2664	2766	2869	2955	3167				
Zone 2	2017	2078	2159	2218	2278	2366	2448	2539	2619	2718	2757	2863	2969	3058	3278				
Zone 3	2085	2149	2232	2293	2355	2446	2531	2625	2707	2810	2850	2960	3070	3162	3389				

917

Trados Connecting Table

NOW



	Overall			St. Ydg.	Cu. Ft.	Shp. Wt.	Fr. Cls.
	20" W x 21.5" D x 15.5" H			N/A	3	22	125

Zone 1	642
Zone 2	664
Zone 3	687

• Includes attachment hardware

918MET

Steel triarc arm bench

Now

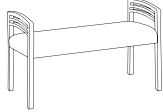

	Overall		Seat										St. Ydg.	Cu. Ft.	Shp. Wt.	Fr. Cls.
	48" W x 22" D x 25.5" H		45" W x 19" D x 18" H										2	37	74	175
	1	2/COM	3/COL	4	5	6	7	8	9	10	11	12/L	13	14	15/LL	
Zone 1	1507	1572	1651	1701	1762	1844	1926	2008	2091	2193	2254	2377	2443	2508	2740	
Zone 2	1560	1627	1709	1761	1824	1909	1993	2078	2164	2270	2333	2460	2529	2596	2836	
Zone 3	1612	1682	1767	1820	1885	1973	2061	2149	2237	2347	2412	2543	2614	2684	2932	

919

Trados Corner Table

Now



	Overall	St. Ydg.	Cu. Ft.	Shp. Wt.	Fr. Cls.
	28.25" W x 28.25" D x 15.5" H	N/A	4	35	100

Zone 1	1130
Zone 2	1170
Zone 3	1209

- Includes leg for rear corner and attachment hardware



Unos

GUEST SEATING - SIN 33721 & 337127CSB

Solid Comfort, Transitional Style

The Unos collection is constructed with extra-sturdy frames. Transitional style scalloped arms/legs are 1.75" thick solid hardwood. Steel cross braces provide solid construction with a weight capacity of 350 lb. per unit. Bariatric width chairs also include steel cross braces in the back and offer a standard weight capacity of 500 lbs. with 750 lb and 1,000 lb options. The 904 armchair can be (ordered) ganged up to four seats with one arm between seats. Wood veneer top corner and inline connecting tables expand configuration options.

Product Details

- Extra wide arms with scalloped design
- Solid wood frame with steel reinforced seat
- Separate seats & backs for easy clean out (except 905 Patient Chair)
- Seats and backs are field replaceable
- Wall-saver leg design (except 905 Patient Chair)

- Standard armchair weight capacity 350 lb.
- Two-color combinations available, priced at higher grade
- Adjustable glides
- Hybrid soy-based, CFC-free foam

How to Specify:

- 1 Model number
- 2 Wood finish
- 3 Fabric grade & name for back
- 4 Fabric grade & name for seat (if different)
- 5 Options

Finished Example

904/BW/1 Culp Dillon Buff/5 Mayer Orbit Obsidian/PC

Options	Code	Price
2 polyurethane arm caps	PC	223
3 polyurethane arm caps	PC3	334
4 polyurethane arm caps	PC4	445
5 polyurethane arm caps	PC5	557

Wood Finishes	Code
Black	BLK
Boardwalk	BW
Driftwood	DW
Espresso	ESP
Mahogany	MAH
Moab	MOB
Monticello Maple	MM
Natural Maple	FM
Shoreline	SL
Windsor Cherry	WC

902

Bariatric wood arm chair,
30" wide seat

NOW



	Overall		Seat										St. Ydg.	Cu. Ft.	Shp. Wt.	Fr. Cls.
	35" W x 25.5" D x 35" H		30" W x 19" D x 18" H										2.5	36	70	175
	1	2/COM	3/COL	4	5	6	7	8	9	10	11	12/L	13	14	15/LL	
Zone 1	1774	1819	1880	1924	1968	2036	2096	2162	2222	2296	2324	2403	2484	2550	2702	
Zone 2	1836	1883	1946	1991	2037	2107	2169	2238	2300	2376	2405	2487	2571	2639	2797	
Zone 3	1898	1946	2012	2059	2106	2179	2243	2313	2378	2457	2487	2571	2658	2729	2891	

•SIN 337127CSB

Option	Code	Price
750 lb. Bariatric Rating	HB	170
1,000 lb. Bariatric Rating	XB	318

903

Bariatric wood triarc arm chair,
40" wide seat

NOW



	Overall		Seat										St. Ydg.	Cu. Ft.	Shp. Wt.	Fr. Cls.
	45" W x 25.5" D x 35" H		40" W x 19" D x 18" H										3	36	81	250
	1	2/COM	3/COL	4	5	6	7	8	9	10	11	12/L	13	14	15/LL	
Zone 1	1959	2012	2085	2139	2193	2273	2343	2423	2495	2585	2690	2798	2887	2983	3077	
Zone 2	2028	2082	2158	2214	2270	2353	2425	2508	2582	2675	2784	2896	2988	3087	3185	
Zone 3	2096	2153	2231	2289	2347	2432	2507	2593	2670	2766	2878	2994	3089	3192	3292	

•SIN 337127CSB

Option	Code	Price
750 lb. Bariatric Rating	HB	170
1,000 lb. Bariatric Rating	XB	318

904

Wood scalloped armchair

NOW



	Overall		Seat										St. Ydg.	Cu. Ft.	Shp. Wt.	Fr. Cls.
	24.75" W x 25.5" D x 35" H		20" W x 19" D x 18" H										2	15	37	250
	1	2/COM	3/COL	4	5	6	7	8	9	10	11	12/L	13	14	15/LL	
Zone 1	1230	1288	1357	1424	1486	1566	1648	1731	1813	1913	2010	2090	2167	2229	2472	
Zone 2	1273	1333	1404	1474	1538	1621	1706	1792	1876	1980	2080	2163	2243	2307	2559	
Zone 3	1316	1378	1452	1524	1590	1676	1763	1852	1940	2047	2151	2236	2319	2385	2645	

904-2

Two ganged wood scalloped
armchairs

NOW



	Overall		Seat										St. Ydg.	Cu. Ft.	Shp. Wt.	Fr. Cls.
	47.5" W x 25.5" D x 35" H		20" W x 19" D x 18" H										5	37	84	250
	1	2/COM	3/COL	4	5	6	7	8	9	10	11	12/L	13	14	15/LL	
Zone 1	2220	2337	2477	2608	2730	2895	3057	3221	3386	3590	3788	3940	4195	4482	4768	
Zone 2	2298	2419	2564	2699	2826	2996	3164	3334	3505	3716	3921	4078	4342	4639	4935	
Zone 3	2375	2501	2650	2791	2921	3098	3271	3446	3623	3841	4053	4216	4489	4796	5102	

Unos

	Overall	Seat											St. Ydg.	Cu. Ft.	Shp. Wt.	Fr. Cls.
904-3	70.5" W x 25.5" D x 35" H	20" W x 19" D x 18" H											7	55	115	250
		1	2/COM	3/COL	4	5	6	7	8	9	10	11	12/L	13	14	15/LL
Zone 1		3328	3503	3714	3914	4095	4343	4585	4831	5080	5386	5671	5910	6162	6384	7070
Zone 2		3444	3626	3844	4051	4238	4495	4745	5000	5258	5575	5869	6117	6378	6607	7317
Zone 3		3561	3748	3974	4188	4382	4647	4906	5169	5436	5763	6068	6324	6593	6831	7565

NOW



	Overall	Seat											St. Ydg.	Cu. Ft.	Shp. Wt.	Fr. Cls.
904-4	70.5" W x 25.5" D x 35" H	20" W x 19" D x 18" H											9	75	158	300
		1	2/COM	3/COL	4	5	6	7	8	9	10	11	12/L	13	14	15/LL
Zone 1		4435	4674	4950	5214	5458	5789	6116	6444	6770	7180	7578	7881	8247	8615	9426
Zone 2		4590	4838	5123	5396	5649	5992	6330	6670	7007	7431	7843	8157	8536	8917	9756
Zone 3		4745	5001	5297	5579	5840	6194	6544	6895	7244	7683	8108	8433	8824	9218	10086

NOW



	Overall	Seat											St. Ydg.	Cu. Ft.	Shp. Wt.	Fr. Cls.
905	24" W x 25.5" D x 46" H	20" W x 19" D x 18" H											3	23	46	250
		1	2/COM	3/COL	4	5	6	7	8	9	10	11	12/L	13	14	15/LL
Zone 1		1327	1402	1488	1571	1648	1751	1852	1953	2059	2185	2257	2351	2542	2637	2889
Zone 2		1373	1451	1540	1626	1706	1812	1917	2021	2131	2261	2336	2433	2631	2729	2990
Zone 3		1420	1500	1592	1681	1763	1874	1982	2090	2203	2338	2415	2516	2720	2822	3091

NOW



	Overall	Seat											St. Ydg.	Cu. Ft.	Shp. Wt.	Fr. Cls.
906	50" W x 25.5" D x 35" H	45" W x 19" D x 18" H											3.25	36	88	250
		1	2/COM	3/COL	4	5	6	7	8	9	10	11	12/L	13	14	15/LL
Zone 1		1902	1959	2037	2095	2153	2239	2316	2403	2481	2578	2703	2811	2907	3010	3120
Zone 2		1969	2028	2108	2168	2228	2317	2397	2487	2568	2668	2798	2909	3009	3115	3229
Zone 3		2035	2096	2180	2242	2304	2396	2478	2571	2655	2758	2892	3008	3110	3221	3338

NOW



	Overall	Seat											St. Ydg.	Cu. Ft.	Shp. Wt.	Fr. Cls.
907	20" W x 21.5" D x 14.25" H												N/A	3	22	125

NOW



Zone 1	642
Zone 2	664
Zone 3	687

* Includes attachment hardware

Overall	Seat										St. Ydg.	Cu. Ft.	Shp. Wt.	Fr. Cls.		
	1	2/COM	3/COL	4	5	6	7	8	9	10					11	12/L
908 Wood scalloped arm bench	50" W x 25.5" D x 25.5" H										2.	36	68	250		
	Zone 1	1389	1449	1517	1584	1645	1728	1809	1890	1975	2075	2135	2200	2262	2325	2626
	Zone 2	1438	1500	1570	1639	1703	1788	1872	1956	2044	2148	2210	2277	2341	2406	2718
	Zone 3	1486	1550	1623	1695	1760	1849	1936	2022	2113	2220	2284	2354	2420	2488	2810

Overall	Seat										St. Ydg.	Cu. Ft.	Shp. Wt.	Fr. Cls.	
909 Unos Corner Table	28.25" W x 28.25" D x 14.25" H										N/A	4	35	100	
	Zone 1	1130	• Includes leg for rear corner and attachment hardware												
	Zone 2	1170													
	Zone 3	1209													

Overall	Seat										St. Ydg.	Cu. Ft.	Shp. Wt.	Fr. Cls.		
910 Sloped, upholstered ottoman	18.5" W x 19" D x 11.5" H										2.5	36	70	175		
	Zone 1	935	956	977	1002	1021	1049	1075	1102	1130	1164	1186	1222	1244	1276	1329
	Zone 2	968	989	1011	1037	1057	1086	1113	1141	1170	1205	1228	1265	1288	1321	1376
	Zone 3	1000	1023	1045	1072	1092	1122	1150	1179	1209	1245	1269	1308	1331	1365	1422



700 Series

GUEST SEATING - SIN 33721

Upholstered Stack Chairs

700 Series seating is available in any upholstery, providing style, comfort and value. Coordinates perfectly with your Nexstep swivel chair on page 269 in any office environment. Frames and outside of seat backs only available in black.

Product Details

- Black metal frame
- Black urethane arms
- 733 stacks to 8 high and ships two chairs to carton
- 734 features easy-slide sled base with four plastic glides

- Waterfall edge at front of seat
- Two-color combinations available, priced at higher grade
- Hybrid soy-based, CFC-free foam

How to Specify:

- 1 Model number
- 2 Fabric grade & name for back
- 3 Fabric grade & name for seat (if different)
- 4 Options

Options	Code	Price
Casters (733 only)	C	29

Finished Example

733/2 Mayer Fabrics Fedora Tangelo / Culp Punch Card Halo/C

733

4-leg metal guest stack chair

NOW



Overall	Seat											Qty	St. Ydg.	Cu. Ft.	Shp. Wt.	Fr. Cls.
24.5" W x 24" D x 32" H	18" W x 19" D x 19" H											2 pack	1	15	45	250
	1	2/COM	3/COL	4	5	6	7	8	9	10	11	12/L	13	14	15/LL	
Zone 1	558	585	610	625	643	670	699	726	754	787	842	898	932	962	994	
Zone 2	578	605	631	647	666	693	723	751	780	815	871	929	965	996	1029	
Zone 3	597	626	653	669	688	717	748	777	807	842	901	961	997	1029	1064	

734

Sled base metal guest chair

NOW



Overall	Seat											St. Ydg.	Cu. Ft.	Shp. Wt.	Fr. Cls.
24.5" W x 24" D x 32" H	18" W x 19" D x 19" H											1	15	29	300
	1	2/COM	3/COL	4	5	6	7	8	9	10	11	12/L	13	14	15/LL
Zone 1	558	585	610	625	643	670	699	726	754	787	842	898	932	962	994
Zone 2	578	605	631	647	666	693	723	751	780	815	871	929	965	996	1029
Zone 3	597	626	653	669	688	717	748	777	807	842	901	961	997	1029	1064

715-CART

Cart for 733 stacking chairs

NOW



Overall	St. Ydg.	Cu. Ft.	Shp. Wt.	Fr. Cls.	
24" W x 24" D x 6" H	N/A	4	19	85	
Zone 1	439	<ul style="list-style-type: none"> • Holds up to eight 733 chairs 			
Zone 2	454				
Zone 3	470				



9100 Series

GUEST SEATING - SIN 33721

Classic Style, Great Value

Versatile and popular, the 9100 Series chairs offer extensive capability for a wide range of environments and applications. Hardwood frames and proven-quality construction are backed by the HPFi Limited Lifetime Warranty. Select open arm (9118) or upholstered arm panel (9128) designs. Complement your offices with extensive finish and upholstery options.

Product Details

- Chair-to-chair ganging maximizes seating capacity
- Ideal for lobbies, lounges & waiting areas, office guest & conference areas
- Two-color combinations available, priced at higher grade
- Ganging bracket connects multiple chairs in a row to meet local fire codes
- Frame of 1" thick solid hardwood

- Non-marring floor glides
- Frame components are double-doweled, glued and screwed
- Reinforcing corner blocks are glued and stapled
- Seat and back Sytex web suspension
- Hybrid soy-based, CFC-free foam

How to Specify:

- 1 Model number
- 2 Wood finish
- 3 Fabric grade & name for back
- 4 Fabric grade & name for seat (if different)

Finished Example

9118/FM/2 Momentum Fuse Pristine

Finishes	Code
Black	BLK
Boardwalk	BW
Driftwood	DW
Espresso	ESP
Mahogany	MAH
Moab	MOB
Monticello Maple	MM
Natural Maple	FM
Shoreline	SL
Windsor Cherry	WC

9100 Series

9118

Wood arm chair; Upholstered seat and back

NOW



Overall	Seat											St. Ydg.	Cu. Ft.	Shp. Wt.	Fr. Cls.
23" W x 25.5" D x 33" H	20.5" W x 17.25" D x 19" H											2	15	26	250
	1	2/COM	3/COL	4	5	6	7	8	9	10	11	12/L	13	14	15/LL
Zone 1	903	989	1066	1095	1156	1238	1269	1399	1479	1579	1586	1713	1838	1904	2140
Zone 2	935	1024	1103	1133	1196	1281	1313	1448	1531	1634	1642	1773	1902	1971	2215
Zone 3	966	1058	1141	1172	1237	1325	1358	1497	1583	1690	1697	1833	1967	2037	2290

9128

Wood arm chair; Upholstered seat, back and arm panel

NOW



Overall	Seat											St. Ydg.	Cu. Ft.	Shp. Wt.	Fr. Cls.
23" W x 25.5" D x 33" H	20.5" W x 17.25" D x 19" H											2.5	15	29	250
	1	2/COM	3/COL	4	5	6	7	8	9	10	11	12/L	13	14	15/LL
Zone 1	1053	1160	1251	1306	1386	1417	1549	1629	1729	1847	1906	1985	2065	2144	2426
Zone 2	1090	1201	1295	1352	1435	1467	1603	1686	1790	1912	1973	2054	2137	2219	2511
Zone 3	1127	1241	1339	1397	1483	1516	1657	1743	1850	1976	2039	2124	2210	2294	2596

9193CTC

9118/9128 Ganging Bracket

NOW



Overall	St. Ydg.	Cu. Ft.	Shp. Wt.	Fr. Cls.
10" W x 3.5" D x .125" H	N/A	0.2	0.5	70
Zone 1	45			
Zone 2	45			
Zone 3	45			



Flex Stools

BAR STOOLS - SIN 33721

Bar Height Comfort

Flex Stools provide optimum comfort at a Matrix touchdown table, behind an Eve banquette with shelf or Flex Wall with shelf. Silver finish base, column and foot ring coordinate with each of these complimentary products. Swivel seat and foot ring make arrival sitting or departure painless.

Product Details

- 16" diameter upholstered seat swivels 360°
- Brushed aluminum powder coat finish with urethane topcoat
- .25" thick, 18" Diameter disc base
- .875" thick, 16" Diameter foot ring, 13.25" height from floor

- 2" diameter column
- Adjustable floor glides
- Hybrid soy-based, CFC-free foam

How to Specify:

- 1 Model number
- 2 Fabric grade & name for seat

Finished Example

290/4 Stinson Citadel Lapis

Flex Stools

290

Counter height stool
with footrest

Now



	Overall			Seat									St. Ydgs.	Cu. Ft.	Shp. Wt.	Fr. Cls.
	18" W x 18" D x 30" H			18" W x 18" D x 30" H									1.5	14.0	51	250
	1	2/COM	3/COL	4	5	6	7	8	9	10	11	12/L	13	14	15/LL	
Zone 1	1738	1767	1804	1832	1861	1904	1941	1983	2021	2067	2124	2180	2238	2293	2350	
Zone 2	1799	1829	1867	1896	1926	1971	2009	2052	2092	2139	2198	2256	2316	2373	2432	
Zone 3	1860	1891	1930	1960	1991	2037	2077	2122	2162	2212	2273	2333	2395	2454	2515	



Milan

BREAKROOM SEATING - SIN 33721

Bistro Style

Milan offers an ideal solution for "third spaces" such as break rooms, cafeterias, dining areas and anywhere that you need a place to meet. Milan seating features a durable black metal frame and solid wood seat in dark Mahogany finish. Three distinct models available - 18" seat height chairs are designed for use with standard dining height tables, 30" seat height stools are perfect for bar height tables and are available with a fixed or swivel seat and back. Each version is available with ladder, porthole or solid back styles.

Product Details

- Mahogany finish on .625" commercial grade hardwood seat and back
- Welded metal frame
- 1.125" square tubing with .75" support rails
- Non-marring floor glides

- Available with 1" upholstered seat for increased comfort
- Hybrid soy-based, CFC-free foam in upholstered seats
- Solid backs can be special ordered with custom logo etching (set-up charge is required, which varies depending on the size and complexity of the logo)

How to Specify:

- 1 Model number
- 2 Fabric grade & name for seat
- 3 Options

Options	Code	Price
Custom Logo Etching	QT	58

Finished Example

217/5 Douglass Symphony Classic Doe/QT

	Overall	Seat	St. Ydg.	Cu. Ft.	Shp. Wt.	Fr. Cls.
213 Milan Chair with wood ladder back	16.75" W x 21" D x 32" H	16" W x 16.5" D x 17.25" H	N/A	11	38	250
	Zone 1	386				
	Zone 2	400				
	Zone 3	413				

	Overall	Seat	St. Ydg.	Cu. Ft.	Shp. Wt.	Fr. Cls.										
213U Milan Chair with wood ladder back; upholstered seat	16.75" W x 21" D x 32" H	16.5" W x 17" D x 18.5" H	0.75	11	38	250										
	1	2/COM	3/COL	4	5	6	7	8	9	10	11	12/L	13	14	15/LL	
	Zone 1	505	528	552	571	590	617	644	673	701	736	761	788	831	875	917
	Zone 2	523	546	571	591	611	639	667	697	726	762	788	816	860	906	949
	Zone 3	540	565	591	611	631	660	689	720	750	788	814	843	889	936	981

	Overall	Seat	St. Ydg.	Cu. Ft.	Shp. Wt.	Fr. Cls.
216 Milan Bistro Stool with wood ladder back	17" W x 20" D x 42" H	16" W x 16.5" D x 30" H	N/A	11	26	250
	Zone 1	527				
	Zone 2	545				
	Zone 3	564				

	Overall	Seat	St. Ydg.	Cu. Ft.	Shp. Wt.	Fr. Cls.										
216U Milan Bistro Stool with wood ladder back and upholstered seat	17" W x 20" D x 42" H	16.25" W x 17" D x 31" H	0.75	11	26	250										
	1	2/COM	3/COL	4	5	6	7	8	9	10	11	12/L	13	14	15/LL	
	Zone 1	646	669	694	712	735	760	787	816	843	877	901	924	971	1018	1053
	Zone 2	669	692	718	737	761	787	815	845	873	908	933	956	1005	1054	1090
	Zone 3	691	716	743	762	786	813	842	873	902	938	964	989	1039	1089	1127

	Overall	Seat	St. Ydg.	Cu. Ft.	Shp. Wt.	Fr. Cls.
217 Milan Bistro Swivel Stool with wood ladder back	18" W x 20" D x 44.5" H	16" W x 16.5" D x 30.25" H	N.A	11	32	250
	Zone 1	527				
	Zone 2	545				
	Zone 3	564				

	Overall	Seat	St. Ydg.	Cu. Ft.	Shp. Wt.	Fr. Cls.										
217U Milan Bistro Swivel Stool with wood ladder back and upholstered seat	18" W x 20" D x 44.5" H	16.25" W x 17" D x 31.25" H	0.75	11	32	250										
	1	2/COM	3/COL	4	5	6	7	8	9	10	11	12/L	13	14	15/LL	
	Zone 1	646	669	694	712	735	760	787	816	843	877	901	924	971	1018	1053
	Zone 2	669	692	718	737	761	787	815	845	873	908	933	956	1005	1054	1090
	Zone 3	691	716	743	762	786	813	842	873	902	938	964	989	1039	1089	1127

Milan

	Overall	Seat	St. Ydg.	Cu. Ft.	Shp. Wt.	Fr. Cls.
222 Milan Bistro Stool with wood porthole back	16.75" W x 20" D x 42.75" H	16" W x 16.5" D x 30" H	N/A	11	26	250
	Zone 1	527				
	Zone 2	545				
	Zone 3	564				



	Overall	Seat	St. Ydg.	Cu. Ft.	Shp. Wt.	Fr. Cls.										
222U Milan Bistro Stool with wood porthole back and upholstered seat	16.75" W x 20" D x 42.75" H	16.5" W x 17" D x 31.25" H	0.75	11	26	250										
		1	2/COM	3/COL	4	5	6	7	8	9	10	11	12/L	13	14	15/LL
	Zone 1	646	669	694	712	735	760	787	816	843	877	901	924	971	1018	1053
	Zone 2	669	692	718	737	761	787	815	845	873	908	933	956	1005	1054	1090
	Zone 3	691	716	743	762	786	813	842	873	902	938	964	989	1039	1089	1127



	Overall	Seat	St. Ydg.	Cu. Ft.	Shp. Wt.	Fr. Cls.
223 Milan Chair with wood porthole back	16.5" W x 21" D x 32.5" H	16.25" W x 16.5" D x 17.25" H	N/A	11	38	250
	Zone 1	386				
	Zone 2	400				
	Zone 3	413				



	Overall	Seat	St. Ydg.	Cu. Ft.	Shp. Wt.	Fr. Cls.										
223U Milan Chair with wood porthole back and upholstered seat	16.5" W x 21" D x 32.5" H	16.5" W x 17" D x 18.5" H	0.75	11	38	250										
		1	2/COM	3/COL	4	5	6	7	8	9	10	11	12/L	13	14	15/LL
	Zone 1	505	528	552	571	590	617	644	673	701	736	761	788	831	875	917
	Zone 2	523	546	571	591	611	639	667	697	726	762	788	816	860	906	949
	Zone 3	540	565	591	611	631	660	689	720	750	788	814	843	889	936	981



	Overall	Seat	St. Ydg.	Cu. Ft.	Shp. Wt.	Fr. Cls.
226 Milan Bistro Swivel Stool with porthole back	17.75" W x 18.75" D x 45.75" H	16" W x 16.5" D x 30.5" H	N/A	11	130	250
	Zone 1	527				
	Zone 2	545				
	Zone 3	564				



	Overall	Seat	St. Ydg.	Cu. Ft.	Shp. Wt.	Fr. Cls.										
226U Milan Bistro Swivel Stool with porthole back and upholstered seat	17.75" W x 18.75" D x 45.75" H	16.5" W x 17" D x 31.75" H	0.75	11	130	250										
		1	2/COM	3/COL	4	5	6	7	8	9	10	11	12/L	13	14	15/LL
	Zone 1	646	669	694	712	735	760	787	816	843	877	901	924	971	1018	1053
	Zone 2	669	692	718	737	761	787	815	845	873	908	933	956	1005	1054	1090
	Zone 3	691	716	743	762	786	813	842	873	902	938	964	989	1039	1089	1127



	Overall	Seat	St. Ydg.	Cu. Ft.	Shp. Wt.	Fr. Cls.
230 Milan Chair with solid wood back	16.5" W x 21" D x 32.5" H	16.25" W x 16.5" D x 17.25" H	N/A	11	38	250
	Zone 1	386				
	Zone 2	400				
	Zone 3	413				



	Overall	Seat	St. Ydg.	Cu. Ft.	Shp. Wt.	Fr. Cls.									
230U Milan Chair with solid wood back and upholstered seat	16.5" W x 21" D x 32.5" H	16.5" W x 17" D x 18.5" H	0.75	11	38	250									
	1	2/COM	3/COL	4	5	6	7	8	9	10	11	12/L	13	14	15/LL
Zone 1	505	528	552	571	590	617	644	673	701	736	761	788	831	875	917
Zone 2	523	546	571	591	611	639	667	697	726	762	788	816	860	906	949
Zone 3	540	565	591	611	631	660	689	720	750	788	814	843	889	936	981



	Overall	Seat	St. Ydg.	Cu. Ft.	Shp. Wt.	Fr. Cls.
231 Milan Bistro Stool with solid back	16.75" W x 20" D x 42.75" H	16" W x 16.5" D x 30" H	N/A	11	26	250
	Zone 1	527				
	Zone 2	545				
	Zone 3	564				



	Overall	Seat	St. Ydg.	Cu. Ft.	Shp. Wt.	Fr. Cls.									
231U Milan Bistro Stool with solid wood back and upholstered seat	16.75" W x 20" D x 42.75" H	16.5" W x 17" D x 31.25" H	0.75	11	26	250									
	1	2/COM	3/COL	4	5	6	7	8	9	10	11	12/L	13	14	15/LL
Zone 1	646	669	694	712	735	760	787	816	843	877	901	924	971	1018	1053
Zone 2	669	692	718	737	761	787	815	845	873	908	933	956	1005	1054	1090
Zone 3	691	716	743	762	786	813	842	873	902	938	964	989	1039	1089	1127



	Overall	Seat	St. Ydg.	Cu. Ft.	Shp. Wt.	Fr. Cls.
232 Milan Bistro Swivel Stool with solid wood back	17.75" W x 18.75" D x 45.75" H	16" W x 16.5" D x 30.5" H	N/A	11	32	250
	Zone 1	527				
	Zone 2	545				
	Zone 3	564				



	Overall	Seat	St. Ydg.	Cu. Ft.	Shp. Wt.	Fr. Cls.									
232U Milan Bistro Swivel Stool with solid wood back and upholstered seat	17.75" W x 18.75" D x 45.75" H	16.5" W x 17" D x 30.5" H	0.75	11	32	250									
	1	2/COM	3/COL	4	5	6	7	8	9	10	11	12/L	13	14	15/LL
Zone 1	646	669	694	712	735	760	787	816	843	877	901	924	971	1018	1053
Zone 2	669	692	718	737	761	787	815	845	873	908	933	956	1005	1054	1090
Zone 3	691	716	743	762	786	813	842	873	902	938	964	989	1039	1089	1127





Stax

STACK CHAIRS - SIN 33721

A Study in Simplicity

Stax guest chairs are a study in simplicity – in waiting areas, cafeterias or any other high-traffic area. Durable polypropylene seat and back integrated with rigid steel legs and support structure. Available with either chrome or black finish frames. Seat and back can be upholstered in a wide variety of fabrics to match any décor. Connectors makes for easy ganging to meet local fire codes. The rolling stack cart can hold up to 24 non-upholstered Stax chairs for transport and storage.

Product Details

- Black powder-coat painted or chrome plated frame, .400 solid wire
- Black polypropylene seat and back
- Oval hand-hold cut-out for easy transport
- Non-marring floor glides
- Ganging clips available to connect in rows

- Optional upholstered seat, back or both - choose any HPFI upholstery
- Stacks up to 24 high on Model 720Cart
- Ships 4 chairs per carton
- Hybrid soy-based, CFC-free foam

How to Specify:

- 1 Model number
- 2 Fabric grade & name for back
- 3 Fabric grade & name for seat (if different)
- 4 Options

Options	Code	Price
Broken Carton Charge (2-pack)	BCC	101

Finished Example

723/4 Stinson Blip Red Hot/BCC

	Overall	Seat	Qty.	St. Ydg.	Cu. Ft.	Shp. Wt.	Fr. Cls.
723 Wire stack chair, Black finish frame NOW	20.5" W x 21.5" D x 31.5" H	18" W x 16.5" D x 18.5" H	4 pack	N/A	11	55	175
			2 pack	N/A	14.6	33	250
			1 pack	N/A	10	19	400
	Zone 1	201					
	Zone 2	208					
	Zone 3	215					



	Overall	Seat	St. Ydg.	Cu. Ft.	Shp. Wt.	Fr. Cls.										
723SBC Wire stack chair, Black frame; upholstered pads NOW	20.5" W x 21.5" D x 31.5" H	18" W x 16.5" D x 18.5" H	0.75	11	55	175										
		1	2/COM	3/COL	4	5	6	7	8	9	10	11	12/L	13	14	15/LL
	Zone 1	355	367	378	402	442	467	495	524	551	585	598	608	622	637	647
	Zone 2	367	380	391	416	457	483	512	542	570	605	619	629	644	659	670
	Zone 3	380	393	404	430	473	500	530	561	590	626	640	651	666	682	692



	Overall	Seat	Qty.	St. Ydg.	Cu. Ft.	Shp. Wt.	Fr. Cls.
724 Wire frame stack chair; Chrome finish frame NOW	20.5" W x 21.5" D x 31.5" H	18" W x 16.5" D x 18.5" H	4 pack	N/A	11	55	175
			2 pack	N/A	14.6	33	250
			1 pack	N/A	10	19	400
	Zone 1	201					
	Zone 2	208					
	Zone 3	215					



	Overall	Seat	St. Ydg.	Cu. Ft.	Shp. Wt.	Fr. Cls.										
724SBC Wire stack chair; Chrome finish frame; upholstered pads NOW	20.5" W x 21.5" D x 31.5" H	18" W x 16.5" D x 18.5" H	0.75	11	55	175										
		1	2/COM	3/COL	4	5	6	7	8	9	10	11	12/L	13	14	15/LL
	Zone 1	355	367	378	402	442	467	495	524	551	585	598	608	622	637	647
	Zone 2	367	380	391	416	457	483	512	542	570	605	619	629	644	659	670
	Zone 3	380	393	404	430	473	500	530	561	590	626	640	651	666	682	692



	Overall	St. Ydg.	Cu. Ft.	Shp. Wt.	Fr. Cls.
720-GC Bag of 50 connectors to gang stack chairs NOW	24" W x 22" D x 20.5" H	N/A	6.0	16	150
	Zone 1	117			
	Zone 2	121			
	Zone 3	125			

	Overall	St. Ydg.	Cu. Ft.	Shp. Wt.	Fr. Cls.
720-CART Stacking Cart on casters, Holds 24 NOW	24" W x 22" D x 20.5" H	N/A	6.0	16	85
	Zone 1	356			
	Zone 2	368			
	Zone 3	381			





Timbre

BREAKROOM SEATING - SIN 33721

Clean, Contemporary Casual Seating

Timbre seating features polypropylene seats and backs engineered for comfort. The open design of the back not only is aesthetically pleasing, but offers a cool, breathable back surface. The two-piece clam shell construction of the seat also ensures a comfortable respite for longer-than-expected conversations. Timbre stools are a perfect complement to a Matrix touchdown table. Timbre leg chairs make a perfect break room chair with Clique tables. The caster version of the chair is also ideal for use in training rooms with Duality or Clique training tables.

Product Details

- Polypropylene seat and back with light texture
- Clamshell seat construction for comfort
- .75" diameter, chrome-plated tubular steel frame
- .50" diameter chrome-plated tubular steel foot rest

- Non-marring floor glides
- Available with upholstered seat pad
- Ships 4 chairs per carton
- Hybrid soy-based, CFC-free foam in upholstered seat pads
- Stacks up to 8 chairs on 715-CART shown on page 299

How to Specify:

- 1 Model number
- 2 Finish
- 3 Fabric grade & name for seat
- 4 Options

Finished Example

283/B/5 Momentum Cover Cloth Zest/BCC

Options	Code	Price
Broken Carton Charge (2-pack)	BCC	101

Back/Seat Color	Code
Black	B
Gray	G
Claret	R

Bar Height Stools

280 Bar Height Stool

NOW



	Overall	Seat	Qty.	St. Ydg.	Cu. Ft.	Shp. Wt.	Fr. Cls.
	21" W x 25.5" D x 45" H	17" W x 17.75" D x 29.75" H	4 pack	N/A	20.0	78	175
			2 pack	N/A	20.0	43	250
Zone 1	567						
Zone 2	587						
Zone 3	607						

280_ Bar Height Stool with upholstered seat pad

NOW



	Overall	Seat	Qty.	St. Ydg.	Cu. Ft.	Shp. Wt.	Fr. Cls.								
	21" W x 25.5" D x 45" H	17" W x 17.75" D x 29.75" H	4 pack	0.5	20.0	85	175								
			2 pack	0.5	20.0	47	250								
	1	2/COM	3/COL	4	5	6	7	8	9	10	11	12/L	13	14	15/LL
Zone 1	684	696	713	724	738	755	773	791	806	827	852	877	901	926	950
Zone 2	708	720	738	749	764	781	800	819	834	856	882	908	933	958	983
Zone 3	732	745	763	775	790	808	827	846	862	885	912	938	964	991	1017

Leg Chair

283 4-Leg Chair

NOW



	Overall	Seat	Qty.	St. Ydg.	Cu. Ft.	Shp. Wt.	Fr. Cls.
	19.75" W x 21" D x 33.25" H	17" W x 17.75" D x 18.25" H	4 pack	N/A	16.0	58	250
			2 pack	N/A	16.0	35	250
Zone 1	292						
Zone 2	302						
Zone 3	312						

283_ 4-Leg Chair with upholstered seat pad

NOW



	Overall	Seat	Qty.	St. Ydg.	Cu. Ft.	Shp. Wt.	Fr. Cls.								
	19.75" W x 21" D x 33.25" H	17" W x 17.75" D x 18.25" H	4 pack	0.5	16.0	61	250								
			2 pack	0.5	16.0	39	250								
	1	2/COM	3/COL	4	5	6	7	8	9	10	11	12/L	13	14	15/LL
Zone 1	408	416	429	437	445	457	470	481	493	508	522	538	553	568	584
Zone 2	422	431	444	452	461	473	486	498	510	526	540	557	572	588	604
Zone 3	437	445	459	468	476	489	503	515	528	544	559	576	592	608	625

286 4-Leg Chair on casters

NOW



	Overall	Seat	Qty.	St. Ydg.	Cu. Ft.	Shp. Wt.	Fr. Cls.
	19.75" W x 21" D x 33.25" H	17" W x 17.75" D x 18.25" H	4 pack	N/A	16.0	58	250
			2 pack	N/A	16.0	35	250
Zone 1	337						
Zone 2	349						
Zone 3	361						

286_ 4-Leg chair on casters with upholstered seat pad

NOW



	Overall	Seat	Qty.	St. Ydg.	Cu. Ft.	Shp. Wt.	Fr. Cls.								
	19.75" W x 21" D x 33.25" H	17" W x 17.75" D x 18.25" H	4 pack	0.5	16.0	61	250								
			2 pack	0.5	16.0	39	250								
	1	2/COM	3/COL	4	5	6	7	8	9	10	11	12/L	13	14	15/LL
Zone 1	454	463	475	484	492	504	517	528	541	555	568	584	601	615	631
Zone 2	470	479	492	501	509	522	535	546	560	574	588	604	622	637	653
Zone 3	486	495	508	518	526	539	553	565	579	594	608	625	643	658	675



Healthcare





Haley

PATIENT ROOM RECLINER - SIN 337127CSB

Comfort and Versatility

Comfort and versatility have been designed into the Haley recliner from the ground up. Comfort is provided through a body activated recliner mechanism housed in a streamlined frame. A multitude of options provide the versatility to make Haley at home in a wide variety of settings from lobbies and lounges to patient rooms.

Product Details

- Sinuous wire spring suspension and high density foam for durability and patient comfort
- Full width foot rest provides support to patient's entire leg
- Fully upholstered with double-needle trim on seat, back and arms to reinforce sewing
- Two-color combinations available

- Standard width models rated to 350 lbs.
- Bariatric width models rated to 500 lbs.
- Pillow back models include a repositionable pillow
- Hybrid soy-based, CFC-free foam
- Warranty: Limited lifetime on seating components, and three years on wearable parts (recliner mechanism and casters)

How to Specify:

- 1** Model number
- 2** Fabric grade & name for seat & back
- 3** Fabric grade & name for arms (if different)
- 4** Options
- 5** Option finish(s)

Finished Example

845/9 Stinson Tangram/4 Spradling Silvertex/WC

Options	Code	Price
Moisture Barrier	MB	93
Softer Seat Foam-Chair	SF	22
Aluminum Push Bar	PB	387
Black Push Bar	BB	212
Double Pivot Tablet	DPS	827
Pivoting Tablet	LPT	604
Folding Tablet	FT	376
Wood Arm Cap	WA	297
Black Arm Cap	PA	228
IV Pole /Holder	PL	440
Foley/Accessory Hook	FH	133

Tablet & Arm Cap Finishes	Code
Black	BLK
Boardwalk	BW
Driftwood	DW
Espresso	ESP
Mahogany	MAH
Moab	MOB
Monticello Maple	MM
Natural Maple	FM
Shoreline	SL
Windsor Cherry	WC

810 Recliner



(Line art shows remote control for **optional** motor assist)

Overall	Seat	Wt. Capacity	St. Ydg.	Cu. Ft.	Shp. Wt.	Fr. Cls.
29.75" W x 37.5" D x 46.75" H	20.75" W x 20" D x 20" H	350	6.75	42	165	150

	1	2/COM	3/COL	4	5	6	7	8	9	10	11	12/L	13	14	15/LL
Zone 1	4011	4144	4303	4471	4619	4812	5007	5200	5396	5639	5727	5948	5922	6099	6356
Zone 2	4151	4289	4454	4627	4781	4980	5182	5382	5585	5836	5927	6156	6129	6312	6578
Zone 3	4292	4434	4604	4784	4942	5149	5357	5564	5774	6034	6128	6364	6337	6526	6801

• Central braking casters standard

• Minimal assembly required

Option	Code	Price
A/C Motor Assist Mechanism	MT	525
Battery Powered Motor Asst.	MTB	917
Heat & Massage	HM	1765

813 Bariatric Recliner



Overall	Seat	Wt. Capacity	St. Ydg.	Cu. Ft.	Shp. Wt.	Fr. Cls.
33" W x 37.5" D x 46.75" H	28.5" W x 20" D x 20" H	350	7	45	189	150

	1	2/COM	3/COL	4	5	6	7	8	9	10	11	12/L	13	14	15/LL
Zone 1	4317	4455	4612	4747	4884	5067	5247	5431	5612	5838	5972	6152	6299	6484	7013
Zone 2	4468	4611	4773	4913	5055	5244	5431	5621	5808	6042	6181	6367	6519	6711	7258
Zone 3	4619	4767	4935	5079	5226	5422	5614	5811	6005	6247	6390	6583	6740	6938	7504

• Central braking casters standard

• Minimal assembly required

Option	Code	Price
Heat & Massage	HM	1765

815 Recliner, Pillow Back



(Line art shows remote control for **optional** motor assist)

Overall	Seat	Wt. Capacity	St. Ydg.	Cu. Ft.	Shp. Wt.	Fr. Cls.
29.25" W x 37.5" D x 46.75" H	20.75" W x 20" D x 20" H	350	8.5	39	150	150

	1	2/COM	3/COL	4	5	6	7	8	9	10	11	12/L	13	14	15/LL
Zone 1	4328	4475	4643	4825	4985	5193	5401	5612	5820	6079	6243	6466	6735	6973	7168
Zone 2	4479	4632	4806	4994	5159	5375	5590	5808	6024	6292	6462	6692	6971	7217	7419
Zone 3	4631	4788	4968	5163	5334	5557	5779	6005	6227	6505	6680	6919	7206	7461	7670

• Central braking casters standard

• Minimal assembly required

• Includes repositionable pillow

Option	Code	Price
A/C Motor Assist Mechanism	MT	525
Battery Powered Motor Asst.	MTB	917

Haley

817

Bariatric Recliner,
Pillow Back



Overall	Seat	Wt. Capacity	St. Ydg.	Cu. Ft.	Shp. Wt.	Fr. Cls.
33" W x 37.5" D x 46.75" H	28.5" W x 20" D x 20" H	350	8.5	45	180	150

	1	2/COM	3/COL	4	5	6	7	8	9	10	11	12/L	13	14	15/LL
Zone 1	4823	5018	5244	5438	5631	5893	6149	6409	6663	6991	7156	7310	7462	7688	8709
Zone 2	4992	5194	5428	5628	5828	6099	6364	6633	6896	7236	7406	7566	7723	7957	9014
Zone 3	5161	5369	5611	5819	6025	6306	6579	6858	7129	7480	7657	7822	7984	8226	9319

- Central braking casters standard
- Includes repositionable pillow
- Minimal assembly required

840

Recliner



Overall	Seat	Wt. Capacity	St. Ydg.	Cu. Ft.	Shp. Wt.	Fr. Cls.
29" W x 37.5" D x 46.75" H	20.75" W x 20" D x 20" H	350	6.5	42	150	150

	1	2/COM	3/COL	4	5	6	7	8	9	10	11	12/L	13	14	15/LL
Zone 1	2914	3040	3168	3303	3425	3588	3753	3918	4081	4285	4342	4546	4753	4926	5380
Zone 2	3016	3146	3279	3419	3545	3714	3884	4055	4224	4435	4494	4705	4919	5098	5568
Zone 3	3118	3253	3390	3534	3665	3839	4016	4192	4367	4585	4646	4864	5086	5271	5757

- Hardwood legs standard
- Minimal assembly required
- Push bar option should only be ordered if ordering optional 3" casters

Option	Code	Price
3" Casters	C	334
A/C Motor Assist Mechanism	MT	525
Battery Powered Motor Asst.	MTB	917
Heat & Massage	HM	1765

841

Recliner, Trendelenburg



Overall	Seat	Wt. Capacity	St. Ydg.	Cu. Ft.	Shp. Wt.	Fr. Cls.
29.25" W x 37.5" D x 46.75" H	20.75" W x 20" D x 20" H	350	6.5	39	150	150

	1	2/COM	3/COL	4	5	6	7	8	9	10	11	12/L	13	14	15/LL
Zone 1	3276	3395	3535	3688	3819	3990	4165	4336	4508	4725	4822	4910	5118	5289	5495
Zone 2	3391	3514	3659	3817	3953	4130	4311	4488	4666	4890	4991	5082	5297	5474	5687
Zone 3	3505	3633	3782	3946	4086	4269	4457	4640	4824	5056	5160	5254	5476	5659	5880

- Includes Trendelenburg which permits 3° negative pitch
- Minimal assembly required
- Hardwood legs standard
- Push bar option should only be ordered if ordering optional 3" casters

Option	Code	Price
3" Casters	C	334
Heat & Massage	HM	1765

843

Bariatric Recliner



Overall	Seat	Wt. Capacity	St. Ydg.	Cu. Ft.	Shp. Wt.	Fr. Cls.
33" W x 37.5" D x 46.75" H	24.5" W x 20" D x 20" H	500	7	48	162	150

	1	2/COM	3/COL	4	5	6	7	8	9	10	11	12/L	13	14	15/LL
Zone 1	3110	3244	3395	3564	3706	3897	4089	4281	4471	4711	4790	4870	5091	5277	6000
Zone 2	3219	3358	3514	3689	3836	4033	4232	4431	4627	4876	4958	5040	5269	5462	6210
Zone 3	3328	3471	3633	3813	3965	4170	4375	4581	4784	5041	5125	5211	5447	5646	6420

- Hardwood legs standard
- Minimal assembly required
- Push bar option should only be ordered if ordering optional 3" casters

Option	Code	Price
3" Casters	C	334
Heat & Massage	HM	1765

844 Recliner, Trendelenburg, Pillow Back



Overall	Seat	Wt. Capacity	St. Ydg.	Cu. Ft.	Shp. Wt.	Fr. Cls.
29.25" W x 37.5" D x 46.75" H	20.75" W x 20" D x 20" H	350	7.25	39	150	150

	1	2/COM	3/COL	4	5	6	7	8	9	10	11	12/L	13	14	15/LL
Zone 1	3538	3669	3819	3986	4126	4312	4499	4686	4873	5106	5247	5361	5592	5783	6013
Zone 2	3662	3797	3953	4126	4270	4463	4656	4850	5044	5285	5431	5549	5788	5985	6223
Zone 3	3786	3926	4086	4265	4415	4614	4814	5014	5214	5463	5614	5736	5983	6188	6434

- Includes Trendelenburg which permits 3° negative pitch
- Includes repositionable pillow

- Minimal assembly required
- Hardwood legs standard
- Push bar option should only be ordered if ordering optional 3" casters

Option	Code	Price
3" Casters	C	334

845 Recliner, Pillow Back



Overall	Seat	Wt. Capacity	St. Ydg.	Cu. Ft.	Shp. Wt.	Fr. Cls.
29" W x 37.5" D x 46.75" H	20.75" W x 20" D x 20" H	350	8.5	39	142	150

	1	2/COM	3/COL	4	5	6	7	8	9	10	11	12/L	13	14	15/LL
Zone 1	3142	3264	3407	3563	3697	3875	4051	4229	4406	4628	4834	4908	5549	5773	6050
Zone 2	3252	3378	3526	3688	3826	4011	4193	4377	4560	4790	5003	5080	5743	5975	6262
Zone 3	3362	3492	3645	3812	3956	4146	4335	4525	4714	4952	5172	5252	5937	6177	6474

- Includes repositionable pillow
- Minimal assembly required

- Hardwood legs standard
- Push bar option should only be ordered if ordering optional 3" casters

Option	Code	Price
3" Casters	C	334
A/C Motor Assist Mech	MT	525
Battery Powered Motor Asst.	MTB	917

847 Bariatric Recliner, Pillow Back

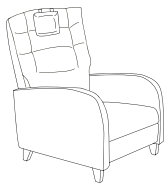

Overall	Seat	Wt. Capacity	St. Ydg.	Cu. Ft.	Shp. Wt.	Fr. Cls.
33" W x 37.5" D x 46.75" H	20.75" W x 20" D x 20" H	500	9.25	45	175	150

	1	2/COM	3/COL	4	5	6	7	8	9	10	11	12/L	13	14	15/LL
Zone 1	3423	3556	3708	3911	4064	4270	4471	4678	4883	5138	5232	5337	6041	6286	6580
Zone 2	3543	3680	3838	4048	4206	4419	4627	4842	5054	5318	5415	5524	6252	6506	6810
Zone 3	3663	3805	3968	4185	4348	4569	4784	5005	5225	5498	5598	5711	6464	6726	7041

- Includes repositionable pillow
- Minimal assembly required

- Hardwood legs standard
- Push bar option should only be ordered if ordering optional 3" casters

Option	Code	Price
3" Casters	C	334

Accessories & Options

	Shp. Wt.	Price
PB	3	387

Aluminum Push Bar



Overall
20/24" W x 4.5" D x 1" H

- Brushed aluminum with black textured grip for easy patient relocation
- Must be factory installed

	Shp. Wt.	Price
BB	3	212

Black Push Bar



Overall
20/24" W x 4.5" D x 1" H

- Black powder coated steel for easy patient relocation
- Must be factory installed

	Shp. Wt.	Price
DPS	7	827

Double Pivoting Tablet Arm



Overall
24" W x 7" D x 7.25" H

- Cobra mounted tablet arm
- Black, unless finish specified
- Brushed aluminum double articulating mechanism
- Located on outside of arm, left facing standard
- Tension adjustment for pivot
- Must be factory installed

	Shp. Wt.	Price
LPT	6	604

Large Pivoting Tablet Arm with Cobra Mount



Overall
27" W x 9.5" D x 7.25" H

- Cobra mounted tablet arm
- Black, unless finish specified
- Brushed aluminum single pivot mechanism
- Located on outside of arm, left facing standard
- Tension adjustment for pivot
- Must be factory installed

	Shp. Wt.	Price
FT	6	376

Folding Side Table for Recliner/ Treatment Chair



Overall
11.75" W x 21.5" D x 8.5" H

- Black, unless finish specified
- Easily locks in place
- Folds down flat
- Located on outside of arm, right side facing standard
- Must be factory installed

	Shp. Wt.	Price
WA	2	297

Wood Arm Caps for Recliners



Overall
23.25" W x 2.75" D x 1" H

- Set of two arm caps for treatment chairs or recliners
- Must be factory installed

	Shp. Wt.	Price
PA	4	228

Black Polyurethane Arm Caps



Overall
23.25" W x 2.75" D x 1" H

- Set of two arm caps for treatment chairs or recliners
- Must be factory installed

	Shp. Wt.	Price
MT	11	525

AC Powered Motor Assist



- Motorized mechanism for a smooth recline and return
- Operated through wired remote control
- Specify MT at end of model number
- Must be factory installed

	Shp. Wt.	Price
MTB	18	917

Powered Motor Assist



- Motorized mechanism for a smooth recline and return
- Operated through battery powered remote control
- Specify MTB at end of model number
- Must be factory installed

	Shp. Wt.	Price
HM	N/A	1765

Heat & Massage



- AC powered heat and massage
- Control located on inside of right arm facing, standard
- Will not overheat
- Waterproof
- Not available on pillow back models
- Must be factory installed

	Shp. Wt.	Price
C	11	334

3" Casters



Overall

3" W x 3" D x 3" H

- 3" non-marking twin wheel casters
- Front casters lock
- Mounted with metal plate
- Add C at the end of any Haley recliner model number
- Must be factory installed

	Shp. Wt.	Price
PL	5	440

IV Pole with Pole Holder



Overall

11" W x 2.75" D x 55.5 - 90.5" H

- Two prong IV pole
- Chrome plated steel
- Adjustable height 55.5" x 90.5"
- Locking collar prevents accidental collapse
- Brushed aluminum cobra-mount pole holder located on outside bottom rear of chair arm, right side facing standard
- Must be factory installed

	Shp. Wt.	Price
FH	1	133

Foley/Accessory Hook



Overall

2.25" W x .25" D x 2.5" H

- Accessory hook located outside right arm facing standard
- Provides convenient placement for drainage bags
- Useful in securing restraints
- Must be factory installed

	Shp. Wt.	Price
MB	N/A	93

Moisture Barrier

- Moisture barrier between seat-foam and fabric
- 70 Denier/210 thread count nylon with polyurethane coating
- Anti bacterial, antifungal inhibition 99+%
- Must be factory installed



Hannah

PATIENT TREATMENT CHAIR - SIN 337127CSB

Make Recovery More Comfortable

Comfort, form and function are the essential building blocks for any HPFi product. Nowhere is this more critical than in a healthcare setting where patient comfort is essential to maximize relaxation and recovery while simultaneously providing caregivers with equipment that looks great and performs flawlessly.

Product Details

- Lay-flat mechanism allows for administering a wide variety of treatments without use of a bed or gurney
- Independently operated back and foot rest
- Pneumatically controlled, infinite adjustment back rest
- Sinuous wire spring suspension and high density foam for durability and patient comfort
- Full width foot rest provides support to patient's entire leg
- Pull-out foot tray for easy patient transfer on Trendelenburg models
- Pneumatically controlled back release located outside right arm facing offers infinite adjustments and can be located inside or outside of either arm

- Swivel casters (front) and locking swivel casters (rear) offer zero-turning radius for maximum maneuverability
- Standard width models rated to 500 lbs.
- Bariatric width models rated to 750 lbs.
- Pillow back models include repositionable pillow
- Warranty: limited lifetime on seating components, three years on wearable parts (recliner mechanism and casters)
- 73" Depth when reclined to lay flat position
- Footrest operated by black lever on left arm facing

How to Specify:

- 1 Model number
- 2 Fabric grade & name for back & seat
- 3 Fabric grade & name for arms (if different)
- 4 Options
- 5 Option finish(es)

Options	Code	Price
Moisture Barrier	MB	93
Softer Seat Foam-Chair	SF	22
Aluminum Lever	RA	281
Double Pivot Tablet	DPS	827
Pivoting Tablet	LPT	604
Folding Tablet	FT	376
Wood Arm Cap	WA	297
Black Arm Cap	PA	228
IV Pole /Holder	PL	440
Foley/Accessory Hook	FH	133

Tablet & Arm Cap Finishes	Code
Black	BLK
Boardwalk	BW
Driftwood	DW
Espresso	ESP
Mahogany	MAH
Moab	MOB
Monticello Maple	MM
Natural Maple	FM
Shoreline	SL
Windsor Cherry	WC

Finished Example

830/9 Stinson Tangram/4 Spradling Silvertex/WC

HPFi

310 Hannah - Patient Treatment Chair

	Overall	Seat										Wt. Capacity	St. Ydg.	Cu. Ft.	Shp. Wt.	Fr. Cls.
801	32" W x 39" D x 44" H	23.5" W x 20" D x 20" H										500	6.5	39	190	150
		1	2/COM	3/COL	4	5	6	7	8	9	10	11	12/L	13	14	15/LL
Zone 1		5084	5214	5367	5493	5624	5795	5969	6142	6312	6529	6629	6719	6925	7098	7303
Zone 2		5262	5396	5555	5685	5821	5998	6178	6357	6533	6758	6861	6954	7167	7346	7559
Zone 3		5440	5579	5743	5878	6018	6201	6387	6572	6754	6986	7093	7189	7410	7595	7814
		<ul style="list-style-type: none"> • Back release operated by finger pull • Central braking casters 										<ul style="list-style-type: none"> • Minimal assembly required 		Option	Code	Price
												Aluminum Push Bar		PB	387	
												Black Push Bar		BB	212	
												Heat & Massage		HM	1765	



	Overall	Seat										Wt. Capacity	St. Ydg.	Cu. Ft.	Shp. Wt.	Fr. Cls.
803	37" W x 39" D x 44" H	28.5" W x 20" D x 20" H										750	8.25	45	205	150
		1	2/COM	3/COL	4	5	6	7	8	9	10	11	12/L	13	14	15/LL
Zone 1		5357	5515	5701	5859	6013	6224	6433	6643	6853	7113	7170	7433	7693	7912	8455
Zone 2		5544	5708	5901	6064	6223	6442	6658	6876	7093	7362	7421	7693	7962	8189	8751
Zone 3		5732	5901	6100	6269	6434	6660	6883	7108	7333	7611	7672	7953	8232	8466	9047
		<ul style="list-style-type: none"> • Back release operated by finger pull • Central braking casters 										<ul style="list-style-type: none"> • Minimal assembly required 		Option	Code	Price
												Aluminum Push Bar		PB	387	
												Black Push Bar		BB	212	
												Heat & Massage		HM	1765	



	Overall	Seat										Wt. Capacity	St. Ydg.	Cu. Ft.	Shp. Wt.	Fr. Cls.
805	32" W x 39" D x 46" H	23.5" W x 20" D x 20" H										500	8.25	39	178	150
		1	2/COM	3/COL	4	5	6	7	8	9	10	11	12/L	13	14	15/LL
Zone 1		5339	5506	5695	5861	6021	6240	6461	6680	6897	7172	7267	7414	7674	7893	8230
Zone 2		5526	5699	5894	6066	6232	6458	6687	6914	7138	7423	7521	7673	7943	8169	8518
Zone 3		5713	5891	6094	6271	6442	6677	6913	7148	7380	7674	7776	7933	8211	8446	8806
		<ul style="list-style-type: none"> • Back release operated by finger pull • Includes repositionable pillow 										<ul style="list-style-type: none"> • Central braking casters • Minimal assembly required 		Option	Code	Price
												Aluminum Push Bar		PB	387	
												Black Push Bar		BB	212	



	Overall	Seat										Wt. Capacity	St. Ydg.	Cu. Ft.	Shp. Wt.	Fr. Cls.
807	37" W x 39" D x 46" H	28.5" W x 20" D x 20" H										750	8.25	45	200	150
		1	2/COM	3/COL	4	5	6	7	8	9	10	11	12/L	13	14	15/LL
Zone 1		5585	5782	6014	6214	6413	6679	6945	7211	7475	7808	7863	8114	8271	8373	8634
Zone 2		5780	5984	6224	6431	6637	6913	7188	7463	7737	8081	8138	8398	8560	8666	8936
Zone 3		5976	6187	6435	6649	6862	7147	7431	7716	7998	8355	8413	8682	8850	8959	9238
		<ul style="list-style-type: none"> • Back release operated by finger pull • Includes repositionable pillow 										<ul style="list-style-type: none"> • Central braking casters • Minimal assembly required 		Option	Code	Price
												Aluminum Push Bar		PB	387	
												Black Push Bar		BB	212	



	Overall	Seat										Wt. Capacity	St. Ydg.	Cu. Ft.	Shp. Wt.	Fr. Cls.
830	33" W x 39" D x 44" H	23.5" W x 20" D x 20" H										500	6.5	42	221	150
		1	2/COM	3/COL	4	5	6	7	8	9	10	11	12/L	13	14	15/LL
Zone 1		4507	4646	4774	4928	5063	5240	5417	5594	5773	5992	6082	6208	6347	6521	7131
Zone 2		4665	4809	4941	5100	5240	5423	5607	5790	5975	6202	6295	6425	6569	6749	7381
Zone 3		4822	4971	5108	5273	5417	5607	5796	5986	6177	6411	6508	6643	6791	6977	7630
		<ul style="list-style-type: none"> • Back release operated by finger pull • Includes Trendelenburg which permits 3° negative pitch • Pull-out foot tray 										<ul style="list-style-type: none"> • Four 3" twin wheel non-marking swivel casters, rear locking • Minimal assembly required 		Option	Code	Price
												Aluminum Push Bar		PB	387	
												Black Push Bar		BB	212	
												Heat & Massage		HM	1765	



Hannah

831

Patient Treatment Chair



	Overall				Seat					Wt. Capacity	St. Ydg.	Cu. Ft.	Shp. Wt.	Fr. Cls.	
	33" W x 39" D x 44" H				23.5" W x 20" D x 20" H					500	6.5	39	180	150	
	1	2/COM	3/COL	4	5	6	7	8	9	10	11	12/L	13	14	15/LL
Zone 1	3804	3939	4070	4226	4359	4537	4714	4891	5069	5293	5408	5624	5762	5934	6454
Zone 2	3937	4077	4212	4374	4512	4696	4879	5062	5246	5478	5597	5821	5964	6142	6680
Zone 3	4070	4215	4355	4522	4664	4855	5044	5233	5424	5664	5787	6018	6165	6349	6906

- Back release operated by finger pull
- Four 3" twin wheel non-marking swivel casters, rear locking

- Minimal assembly required

Option	Code	Price
Aluminum Push Bar	PB	387
Black Push Bar	BB	212
Heat & Massage	HM	1765

832

Bariatric Treatment Chair



	Overall				Seat					Wt. Capacity	St. Ydg.	Cu. Ft.	Shp. Wt.	Fr. Cls.	
	37" W x 39" D x 44" H				28.5" W x 20" D x 20" H					500	7.5	45	238	150	
	1	2/COM	3/COL	4	5	6	7	8	9	10	11	12/L	13	14	15/LL
Zone 1	5410	5563	5740	5898	6052	6257	6461	6663	6869	7126	7174	7326	7533	7733	8429
Zone 2	5599	5758	5941	6104	6264	6476	6687	6896	7109	7375	7425	7582	7797	8004	8724
Zone 3	5789	5952	6142	6311	6476	6695	6913	7129	7350	7625	7676	7839	8060	8274	9019

- Back release operated by finger pull
- Includes Trendelenburg which permits 3° negative pitch
- Pull-out foot tray

- Includes repositionable pillow
- Four 3" twin wheel non-marking swivel casters, rear locking
- Minimal assembly required

Option	Code	Price
Aluminum Push Bar	PB	387
Black Push Bar	BB	212
Heat & Massage	HM	1765

833

Bariatric Treatment Chair



	Overall				Seat					Wt. Capacity	St. Ydg.	Cu. Ft.	Shp. Wt.	Fr. Cls.	
	37" W x 39" D x 44" H				28.5" W x 20" D x 20" H					750	7.5	45	203	150	
	1	2/COM	3/COL	4	5	6	7	8	9	10	11	12/L	13	14	15/LL
Zone 1	4559	4716	4903	5071	5234	5449	5669	5882	6098	6370	6487	6570	6682	6882	7787
Zone 2	4719	4881	5075	5248	5417	5640	5867	6088	6311	6593	6714	6800	6916	7123	8060
Zone 3	4878	5046	5246	5426	5600	5830	6066	6294	6525	6816	6941	7030	7150	7364	8332

- Back release operated by finger pull
- Four 3" twin wheel non-marking swivel casters, rear locking

- Minimal assembly required

Option	Code	Price
Aluminum Push Bar	PB	387
Black Push Bar	BB	212
Heat & Massage	HM	1765

834

Patient Treatment Chair, Pillow Back



	Overall				Seat					Wt. Capacity	St. Ydg.	Cu. Ft.	Shp. Wt.	Fr. Cls.	
	33" W x 39" D x 46" H				23.5" W x 20" D x 20" H					750	8.25	39	206	150	
	1	2/COM	3/COL	4	5	6	7	8	9	10	11	12/L	13	14	15/LL
Zone 1	4692	4822	4974	5144	5289	5479	5671	5864	6055	6293	6340	6578	6816	7015	7520
Zone 2	4856	4991	5148	5324	5474	5671	5869	6069	6267	6513	6562	6808	7055	7261	7783
Zone 3	5020	5160	5322	5504	5659	5863	6068	6274	6479	6734	6784	7038	7293	7506	8046

- Back release operated by finger pull
- Includes Trendelenburg which permits 3° negative pitch
- Pull-out foot tray

- Includes repositionable pillow
- Four 3" twin wheel non-marking swivel casters, rear locking
- Minimal assembly required

Option	Code	Price
Aluminum Push Bar	PB	387
Black Push Bar	BB	212

835 Patient Treatment Chair, Pillow Back



Overall	Seat										Wt. Capacity	St. Ydg.	Cu. Ft.	Shp. Wt.	Fr. Cls.
33" W x 39" D x 46" H	23.5" W x 20" D x 20" H										500	8.25	39	165	150
	1	2/COM	3/COL	4	5	6	7	8	9	10	11	12/L	13	14	15/LL
Zone 1	4008	4137	4291	4463	4605	4797	4987	5179	5371	5610	5727	5921	6344	6562	6864
Zone 2	4148	4282	4441	4619	4766	4965	5162	5360	5559	5806	5927	6128	6566	6792	7104
Zone 3	4289	4427	4591	4775	4927	5133	5336	5542	5747	6003	6128	6335	6788	7021	7344

Option	Code	Price
• Pillow back with extra repositionable pillow		
• Four 3" twin wheel non-marking swivel casters, rear locking		
Aluminum Push Bar	PB	387
Black Push Bar	BB	212

836 Bariatric Pillow Back Patient Treatment Chair



Overall	Seat										Wt. Capacity	St. Ydg.	Cu. Ft.	Shp. Wt.	Fr. Cls.
37" W x 39" D x 46" H	28.5" W x 20" D x 20" H										750	9.5	45	233	175
	1	2/COM	3/COL	4	5	6	7	8	9	10	11	12/L	13	14	15/LL
Zone 1	5004	5157	5335	5524	5687	5904	6124	6343	6560	6835	7054	7212	7774	8025	8327
Zone 2	5179	5337	5522	5717	5886	6111	6338	6565	6790	7074	7301	7464	8046	8306	8618
Zone 3	5354	5518	5708	5911	6085	6317	6553	6787	7019	7313	7548	7717	8318	8587	8910

Option	Code	Price
• Back release operated by finger pull		
• Includes Trendelenburg which permits 3° negative pitch		
• Pull-out foot tray		
• Includes repositionable pillow		
• Four 3" twin wheel non-marking swivel casters, rear locking		
Aluminum Push Bar	PB	387
Black Push Bar	BB	212

837 Bariatric Treatment Chair, Pillow Back



Overall	Seat										Wt. Capacity	St. Ydg.	Cu. Ft.	Shp. Wt.	Fr. Cls.
37" W x 39" D x 46" H	28.5" W x 20" D x 20" H										750	9.5	45	186	150
	1	2/COM	3/COL	4	5	6	7	8	9	10	11	12/L	13	14	15/LL
Zone 1	4321	4472	4653	4842	5004	5221	5440	5659	5876	6151	6407	6672	7010	7261	7595
Zone 2	4472	4629	4816	5011	5179	5404	5630	5857	6082	6366	6631	6906	7255	7515	7861
Zone 3	4623	4785	4979	5181	5354	5586	5821	6055	6287	6582	6855	7139	7501	7769	8127

Option	Code	Price
• Back release operated by finger pull		
• Includes repositionable pillow		
• Includes two fixed casters on front, two locking swivel casters on back		
Aluminum Push Bar	PB	387
Black Push Bar	BB	212

838 Rocker/Glider Recliner



Overall	Seat										Wt. Capacity	St. Ydg.	Cu. Ft.	Shp. Wt.	Fr. Cls.
32" W x 39" D x 44" H	22.5" W x 20" D x 20" H										500	6.5	39	190	150
	1	2/COM	3/COL	4	5	6	7	8	9	10	11	12/L	13	14	15/LL
Zone 1	4738	4874	5034	5170	5306	5488	5670	5851	6035	6260	6400	6488	6579	6751	7417
Zone 2	4904	5045	5210	5351	5492	5680	5868	6056	6246	6479	6624	6715	6809	6987	7677
Zone 3	5070	5215	5386	5532	5677	5872	6067	6261	6457	6698	6848	6942	7040	7224	7936

Option	Code	Price
• Back release operated by finger pull		
• Body activated rocking glider motion operated on curved rail		
• Reclining mechanism locks out rocking glider		
• Tubular metal legs with glides on front, 2" casters on back		
Heat & Massage	HM	1765

839 Rocker/Glider Recliner, Pillow Back



Overall	Seat										Wt. Capacity	St. Ydg.	Cu. Ft.	Shp. Wt.	Fr. Cls.
32" W x 39" D x 46" H	22.5" W x 20" D x 20" H										500	8.25	39	187	150
	1	2/COM	3/COL	4	5	6	7	8	9	10	11	12/L	13	14	15/LL
Zone 1	4974	5147	5350	5524	5699	5926	6156	6388	6618	6908	7019	7169	7310	7529	7791
Zone 2	5148	5327	5537	5717	5898	6133	6371	6612	6850	7150	7265	7420	7566	7793	8064
Zone 3	5322	5507	5725	5911	6098	6341	6587	6835	7081	7392	7510	7671	7822	8056	8336

Option	Code	Price
• Back release operated by finger pull		
• Body activated rocking glider motion operated on curved rail		
• Reclining mechanism locks out rocking glider		
• Includes repositionable pillow		
• Tubular metal legs with glides on front, 2" casters on back		

Accessories & Options

	Shp. Wt.	Price
PB	3	387

Aluminum Push Bar



Overall
20/24" W x 4.5" D x 1" H

- Brushed aluminum with black textured grip for easy patient relocation
- Must be factory installed

	Shp. Wt.	Price
BB	3	212

Black Push Bar



Overall
20/24" W x 4.5" D x 1" H

- Black powder coated steel for easy patient relocation
- Must be factory installed

	Shp. Wt.	Price
DPS	7	827

Double Pivoting Tablet Arm



Overall
24" W x 7" D x 7.25" H

- Cobra mounted tablet arm
- Black, unless finish specified
- Brushed aluminum double articulating mechanism
- Located on outside of arm, left facing standard
- Tension adjustment for pivot
- Must be factory installed

	Shp. Wt.	Price
LPT	6	604

Large Pivoting Tablet Arm with Cobra Mount



Overall
27" W x 9.5" D x 7.25" H

- Cobra mounted tablet arm
- Black, unless finish indicated
- Brushed aluminum single pivot mechanism
- Located on outside of arm, left facing standard
- Tension adjustment for pivot
- Must be factory installed

	Shp. Wt.	Price
FT	6	376

Folding Side Table for Recliner/Treatment Chair



Overall
11.75" W x 21.5" D x 8.5" H

- Black, unless finish specified
- Easily locks in place
- Folds down flat
- Located on outside of arm, right side facing standard
- Must be factory installed

	Shp. Wt.	Price
RA	6	281

Brushed Aluminum Footrest Lever



Overall
13" W x 1.5" D x 1" H

- Optional brushed aluminum footrest lever with black textured grip
- Replaces standard black lever on Hannah recliners

	Shp. Wt.	Price
WA	2	297

Wood Arm Caps for Recliners



Overall
23.25" W x 2.75" D x 1" H

- Set of two arm caps for treatment chairs or recliners
- Finish must be specified
- Must be factory installed

	Shp. Wt.	Price
PA	4	228

Black Polyurethane Arm Caps



Overall
23.25" W x 2.75" D x 1" H

- Set of two arm caps for treatment chairs or recliners
- Must be factory installed

	Shp. Wt.	Price
HM	N/A	1765

Heat & Massage for Recliner



- AC powered heat and massage
- Control located on inside of right arm facing, standard
- Will not overheat
- Waterproof
- Not available on pillow back models
- Must be factory installed

	Shp. Wt.	Price
FH	1	133

Foley/Accessory Hook



Overall

2.25" W x .25" D x 2.5" H

- Accessory hook located outside right arm facing standard
- Provides convenient placement for collection bag
- Useful in securing restraints
- Must be factory installed

	Shp. Wt.	Price
PL	5	440

IV Pole with Pole Holder



Overall

11" W x 2.75" D x 55.5 - 90.5" H

- Two prong IV pole
- Chrome plated steel
- Adjustable height 55.5" x 90.5"
- Locking collar prevents accidental collapse
- Brushed aluminum cobra-mount pole holder located on outside bottom rear of chair arm, right side facing standard
- Must be factory installed

	Shp. Wt.	Price
MB	N/A	93

Moisture Barrier

- Moisture barrier between seat-foam and fabric
- 70 Denier/210 thread count nylon with polyurethane coating
- Anti bacterial, anti-fungal inhibition 99+%
- Must be factory installed



Harmony

HEALTHCARE DAYBEDS/SLEEPERS - SIN 337127CSB

Overnight Comfort

Harmony is the ideal answer for an overnight, comfortable stay in a patient room. Day Beds are available in three widths to accommodate most rooms. The full size version of Harmony provides an adequate sleeping space with room for two adults. The Sleeper Chair seat extends with a pop-up “ottoman” from underneath the seat. The back cushion flips down to provide a pillow/extended sleep surface. Also a great solution for teacher’s and employee lounges where a temporary sleep surface is required.

Day Bed Product Details

- Wall-saver design
- Seat lifts to unlock pull-out base to convert to a 78” bed
- Lift chair back and roll forward to return unit back to a chair
- Platform rail on glides for stability
- Ample storage under seat for linens and blankets
- Double-needle trim on seat, back and arms to reinforce seams
- Two-color combinations available

Sleeper Chair Product Details

- Wall-saver design - grasp handle and pull for stored “pop-up ottoman”
- Swivel casters (rear) and locking casters (front) for ease of mobility
- Club chair converts to chaise with pull-out pop-up ottoman
- 86” total sleep surface when fully extended and back folded down
- Double-needle trim on seat, back and arms to reinforce seams
- Two-color combinations available
- Mechanism rated to 500 lbs.

How to Specify:

- 1 Model number
- 2 Fabric grade & name for seat & back
- 3 Fabric grade & name for arms (if different)
- 4 Options
- 5 Option finish(s)

Finished Example

823/9 Stinson Tangram/4 Spradling Silvertex/WAWC

Options	Code	Price
Moisture Barrier	MB	93
Black Polyurethane Arm Caps	PA	228
Wood Arm Caps	WA	297
Soft Foam Seat (821, 826)	SF	22
Soft Foam Seat (822)	SF	44
Soft Foam Seat (823)	SF	66

Arm Cap Finishes	Code
Black	BLK
Boardwalk	BW
Driftwood	DW
Espresso	ESP
Mahogany	MAH
Moab	MOB
Monticello Maple	MM
Natural Maple	FM
Shoreline	SL
Windsor Cherry	WC

Day Bed

821

Single Convertible Seat/
Day Bed

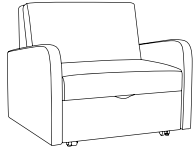

	Overall			Seat							Wt. Capacity		St. Ydg.	Cu. Ft.	Shp. Wt.	Fr. Cls.
	38.5" W x 39-78" D x 35" H			30.75" W x 22.5" D x 18" H							500		7.5	52	215	250
	1	2/COM	3/COL	4	5	6	7	8	9	10	11	12/L	13	14	15/LL	
Zone 1	3792	3949	4131	4306	4465	4680	4897	5115	5330	5597	5675	5831	5915	6113	6579	
Zone 2	3925	4087	4276	4457	4621	4844	5068	5294	5517	5793	5874	6035	6122	6327	6809	
Zone 3	4057	4225	4420	4607	4778	5008	5240	5473	5703	5989	6072	6239	6329	6541	7040	

• Club chair easily converts to single size bed

Option	Code	Price
Softer Seat Foam	SF	22
Black Arm Cap	PA	228
Wood Arm Cap	WA	297

822

Twin Size Convertible Seat/
Day Bed

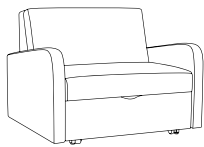

	Overall			Seat							Wt. Capacity		St. Ydg.	Cu. Ft.	Shp. Wt.	Fr. Cls.
	46.5" W x 39-78" D x 35" H			38.5" W x 22.5" D x 18" H							750		8.5	66	219	250
	1	2/COM	3/COL	4	5	6	7	8	9	10	11	12/L	13	14	15/LL	
Zone 1	4349	4517	4711	4929	5115	5357	5601	5846	6093	6400	6509	6771	6861	6980	7335	
Zone 2	4501	4675	4876	5102	5294	5544	5797	6051	6306	6624	6737	7008	7101	7224	7592	
Zone 3	4653	4833	5041	5274	5473	5732	5993	6255	6520	6848	6965	7245	7341	7469	7848	

• Loveseat easily converts to twin size bed

Option	Code	Price
Softer Seat Foam	SF	44
Black Arm Cap	PA	228
Wood Arm Cap	WA	297

823

Full Convertible Seat/
Day Bed

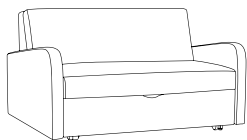

	Overall			Seat							Wt. Capacity		St. Ydg.	Cu. Ft.	Shp. Wt.	Fr. Cls.
	55" W x 39-78" D x 35" H			47.25" W x 22.5" D x 18" H							1000		9.5	76	251	250
	1	2/COM	3/COL	4	5	6	7	8	9	10	11	12/L	13	14	15/LL	
Zone 1	5078	5264	5486	5726	5933	6205	6480	6753	7028	7368	7467	7506	7769	8008	8727	
Zone 2	5256	5448	5678	5926	6141	6422	6707	6989	7274	7626	7728	7769	8041	8288	9032	
Zone 3	5433	5632	5870	6127	6348	6639	6934	7226	7520	7884	7990	8031	8313	8569	9338	

• Sofa easily converts to full size bed

Option	Code	Price
Softer Seat Foam	SF	66
Black Arm Cap	PA	228
Wood Arm Cap	WA	297

Harmony

Sleeper Chair

826

Harmony Sleeper Chair

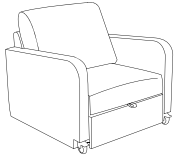

Overall	Seat	Wt. Capacity	St. Ydg.	Cu. Ft.	Shp. Wt.	Fr. Cls.
35.75" W x 37-86" D x 35" H	27" W x 20" D x 17" H	500	9.25	50	179	250

	1	2/COM	3/COL	4	5	6	7	8	9	10	11	12/L	13	14	15/LL
Zone 1	3903	4089	4305	4538	4738	5004	5272	5536	5802	6135	6286	6425	6523	6767	7108
Zone 2	4040	4232	4456	4697	4904	5179	5457	5730	6005	6350	6506	6650	6751	7004	7357
Zone 3	4176	4375	4606	4856	5070	5354	5641	5924	6208	6564	6726	6875	6980	7241	7606

• Chair by day and sleeper by night

• 4 heavy-duty casters for easy mobility (front 2 lock)

Option	Code	Price
Softer Seat Foam	SF	22
Black Arm Cap	PA	228
Wood Arm Cap	WA	297

826-2

Tandem Sleeper Chair

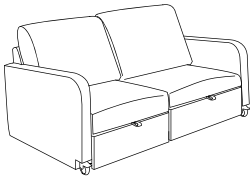

Overall	Seat (each)	Wt. Capacity	St. Ydg.	Cu. Ft.	Shp. Wt.	Fr. Cls.
64.75" W x 37-86" D x 35" H	27" W x 20" D x 17" H	500	18.5	82	282	250

	1	2/COM	3/COL	4	5	6	7	8	9	10	11	12/L	13	14	15/LL
Zone 1	7811	8177	8604	8976	9476	10007	10543	11076	11606	11802	11875	12618	13051	13539	15897
Zone 2	8084	8463	8905	9290	9808	10357	10912	11464	12012	12215	12291	13060	13508	14013	16453
Zone 3	8358	8749	9206	9604	10139	10707	11281	11851	12418	12628	12706	13501	13965	14487	17010

• Dual sleeper chairs
• Each seat operates independently

• Heavy-duty casters for mobility
• Front casters lock

Option	Code	Price
Softer Seat Foam	SF	44
Black Arm Cap	PA	228
Wood Arm Cap	WA	297

Accessories & Options

	Shp. Wt.	Price
WA	2	297

Wood Arm Caps for Recliners



Overall
23.25" W x 2.75" D x 1" H

- Set of two arm caps for treatment chairs or recliners
- Specify WA at end of model number and indicate finish
- Must be factory installed

	Shp. Wt.	Price
PA	4	228

Black Polyurethane Arm Caps



Overall
23.25" W x 2.75" D x 1" H

- Set of two arm caps for treatment chairs or recliners
- Specify PA at end of model number
- Must be factory installed



Helix

DOCTOR STOOLS - SIN 337127CSB

Comfort for Physicians

Helix stools provide a full range of adjustable height seating for physician's offices, examination rooms and other areas of care. Models with a foot activated ring in the base provide a hands-free height adjustment. Braking casters ensure that the stool does not roll away when vacant. Both of these features allow the user to keep hands clean and sterile.

580 / 581 Product Details

- 11" diameter foot ring for hands-free height adjustment
- Dual-wheel compression braking casters inhibit movement when stool is vacant
- Cast steel base
- 23" Base - Black powder coat or chrome plated steel
- Matching finish pneumatic cylinder travels 7.5" H
- 3" thick, 16" diameter upholstered seats
- Hybrid soy-based, CFC-free foam

582 Product Details

- Conventional hand-operated one-touch pneumatic seat height adjustment
- Black dual-wheel carpet casters
- Black nylon base is 22" diameter
- 2" thick, 14" diameter molded urethane seat

How to Specify:

- 1 Model number
- 2 Fabric grade & name for lumbar support / back
- 3 Fabric grade & name for seat (if different)
- 4 Options

Finished Example

580/9 Stinson Tangram/H

580/581 Options	Code	Price
Hard Floor Casters	H	28
Self-Locking Casters	S	111

582 Options	Code	Price
Braking Casters	B	38
Self-Locking Casters	S	111

580

Helix Dr. Stool, Black Base



Overall	Seat	Wt. Capacity	St. Ydg.	Cu. Ft.	Shp. Wt.	Fr. Cls.
23" W X 23" D X 22.5-29.75" H	16" Diameter, 22.5 - 29.75" H	350	1.5	11	27	250

	1	2/COM	3/COL	4	5	6	7	8	9	10	11	12/L	13	14	15/LL
Zone 1	760	788	824	861	894	936	981	1024	1066	1123	1155	1203	1223	1271	1409
Zone 2	787	816	853	891	925	969	1015	1060	1103	1162	1195	1245	1266	1315	1458
Zone 3	813	843	882	921	957	1002	1050	1096	1141	1202	1236	1287	1309	1360	1508

	Option	Code	Price
• Black base			
• Upholstered seat			
• Ships fully assembled			
	Hard-Floor Casters	H	28
	Self-Locking Casters	S	111

580CB

Helix Dr. Stool, Chrome Base



Overall	Seat	Wt. Capacity	St. Ydg.	Cu. Ft.	Shp. Wt.	Fr. Cls.
23" W X 23" D X 22.5-29.75" H	16" Diameter, 22.5 - 29.75" H	350	1.5	11	27	250

	1	2/COM	3/COL	4	5	6	7	8	9	10	11	12/L	13	14	15/LL
Zone 1	806	834	872	907	939	982	1025	1070	1112	1165	1183	1247	1270	1319	1454
Zone 2	834	863	903	939	972	1016	1061	1107	1151	1206	1224	1291	1314	1365	1505
Zone 3	862	892	933	970	1005	1051	1097	1145	1190	1247	1266	1334	1359	1411	1556

	Option	Code	Price
• Chrome base			
• Upholstered seat			
• Ships fully assembled			
	Hard-Floor Casters	H	28
	Self-Locking Casters	S	111

581

Helix Dr. Stool, Black

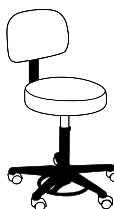

Overall	Seat	Wt. Capacity	St. Ydg.	Cu. Ft.	Shp. Wt.	Fr. Cls.
23" W x 23" D x 37-44" H	16" Diameter, 22.5 - 29.75" H	350	1.5	11	33	250

	1	2/COM	3/COL	4	5	6	7	8	9	10	11	12/L	13	14	15/LL
Zone 1	933	962	999	1036	1067	1111	1155	1198	1241	1294	1322	1375	1426	1514	1576
Zone 2	966	996	1034	1072	1104	1150	1195	1240	1284	1339	1368	1423	1476	1567	1631
Zone 3	998	1029	1069	1109	1142	1189	1236	1282	1328	1385	1415	1471	1526	1620	1686

	Option	Code	Price
• Black base			
• Upholstered seat and lumbar support			
• Simple assembly by attaching back			
	Hard-Floor Casters	H	28
	Self-Locking Casters	S	111

581CB

Helix Dr. Stool, Chrome

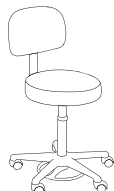

Overall	Seat	Wt. Capacity	St. Ydg.	Cu. Ft.	Shp. Wt.	Fr. Cls.
23" W x 23" D x 37-44" H	16" Diameter, 22.5 - 29.75" H	350	1.5	11	33	250

	1	2/COM	3/COL	4	5	6	7	8	9	10	11	12/L	13	14	15/LL
Zone 1	983	1014	1052	1085	1121	1162	1206	1248	1292	1346	1417	1488	1524	1553	1692
Zone 2	1017	1049	1089	1123	1160	1203	1248	1292	1337	1393	1467	1540	1577	1607	1751
Zone 3	1052	1085	1126	1161	1199	1243	1290	1335	1382	1440	1516	1592	1631	1662	1810

	Option	Code	Price
• Chrome base			
• Upholstered seat and lumbar support			
• Simple assembly by attaching back			
	Hard-Floor Casters	H	28
	Self-Locking Casters	S	111

582

Helix Dr. Stool, Urethane Seat



Overall	Seat	Wt. Capacity	St. Ydg.	Cu. Ft.	Shp. Wt.	Fr. Cls.
22" W x 22" D x 14.5-20" H	14" Diameter, 14.5 - 20" H	250	N/A	11	20	300

	Option	Code	Price
• Ships fully assembled			
	Breaking Casters	B	38
	Self-Locking Casters	S	111

Model Number Index

Casegoods

Model	Page	Model	Page	Model	Page	Model	Page
H__02101L	88	H__04113	89	H__09105	91	H__15205	92
H__02101R	88	H__04114	89	H__09106	91	H__15206	92
H__02102L	88	H__04115	89	H__09107	91	H__15207	92
H__02102R	88	H__04116	89	H__09108	91	H__15208	92
H__02103L	88	H__05101L	90	H__09109	91	H__16201	93
H__02103R	88	H__05101R	90	H__09110	91	H__16202	93
H__02104L	88	H__05102L	90	H__09111	91	H__16203	93
H__02104R	88	H__05102R	90	H__09112	91	H__16204	93
H__02105	88	H__05103L	90	H__09113	91	H__16205	93
H__02106	88	H__05103R	90	H__09114	91	H__16206	93
H__02107	88	H__05104L	90	H__09115	91	H__16207	93
H__02108	88	H__05104R	90	H__09116	91	H__16208	93
H__02109	88	H__05105	90	H__09117	91	H__18201	93
H__02110	88	H__05106	90	H__09118	91	H__18202	93
H__02111	88	H__05107	90	H__09119	91	H__18203	93
H__02112	88	H__05108	90	H__09120	91	H__18204	93
H__02113	88	H__05109	90	H__10105	92	H__18205	93
H__02114	88	H__05110	90	H__10106	92	H__18206	93
H__02115	88	H__05111	90	H__10107	92	H__18207	93
H__02116	88	H__05112	90	H__10108	92	H__18208	93
H__02117	88	H__05113	90	H__10109	92	H__19201	93
H__02118	88	H__05114	90	H__10110	92	H__19202	93
H__02119	88	H__05115	90	H__10111	92	H__19203	93
H__02120	88	H__05116	90	H__10112	92	H__19204	93
H__03101	89	H__06105	90	H__10113	92	H__19205	93
H__03102	89	H__06106	90	H__10114	92	H__19206	93
H__03103	89	H__06107	90	H__10115	92	H__19207	93
H__03104	89	H__06108	90	H__10116	92	H__19208	93
H__03105	89	H__07105	90	H__10117	92	H__1D	86
H__03106	89	H__07106	90	H__10118	92	H__20	73
H__03107	89	H__07107	90	H__10119	92	H__20S	76
H__03108	89	H__07108	90	H__10120	92	H__212BF	75
H__03109	89	H__07109	90	H__11105	92	H__21F	75
H__03110	89	H__07110	90	H__11106	92	H__2442L	67
H__03111	89	H__07111	90	H__11107	92	H__2442LF	67
H__03112	89	H__07112	90	H__11108	92	H__2442R	67
H__03113	89	H__08105	91	H__11109	92	H__2442RF	67
H__03114	89	H__08106	91	H__11110	92	H__2D	86
H__03115	89	H__08107	91	H__11111	92	H__2DLF	76
H__03116	89	H__08108	91	H__11112	92	H__3036	75
H__04101	89	H__08109	91	H__11113	92	H__30WMS	81
H__04102	89	H__08110	91	H__11114	92	H__326	75
H__04103	89	H__08111	91	H__11115	92	H__335	70
H__04104	89	H__08112	91	H__11116	92	H__336	69
H__04105	89	H__08113	91	H__11117	92	H__337	70
H__04106	89	H__08114	91	H__11118	92	H__338	69
H__04107	89	H__08115	91	H__11119	92	H__346	75
H__04108	89	H__08116	91	H__11120	92	H__36B-PD	76
H__04109	89	H__08117	91	H__15201	92	H__36B-PDD	76
H__04110	89	H__08118	91	H__15202	92	H__36B-PDFD	76
H__04111	89	H__08119	91	H__15203	92	H__36WMS	81
H__04112	89	H__08120	91	H__15204	92	H__3D	86

Casegoods (cont.)

Model	Page	Model	Page	Model	Page	Model	Page
H__426	75	H__644F	58	H__721RB2BF	52	H_01106	88
H__42WMS	81	H__651L	53	H__722L	60	H_01107	88
H__431L	53	H__651L2BF	53	H__722LF	61	H_01108	88
H__431L2BF	53	H__651R	53	H__722R	60	H_01109	88
H__431R	53	H__651R2BF	54	H__722RF	61	H_01110	88
H__431R2BF	54	H__652D	77	H__7230L	66	H_01111	88
H__451L	54	H__65AV	78	H__7230L2BF	67	H_01112	88
H__451L2BF	55	H__65DS	79	H__7230R	66	H_01113	88
H__451R	54	H__65DWD	79	H__7230R2BF	67	H_01114	88
H__451R2BF	55	H__65PTL	78	H__725L	58	H_01115	88
H__452L	60	H__65PTL2BF	78	H__725LF	58	H_01116	88
H__452LF	61	H__65PTL2BFS	79	H__725R	58	H_01117	88
H__452R	60	H__65PTLS	79	H__725RF	59	H_01118	88
H__452RF	61	H__65PTR	78	H__72WMS	81	H_01119	88
H__455	70	H__65PTR2BF	79	H__732	79	H_01120	88
H__456	69	H__65PTR2BFS	79	H__733	57	H_1-1	83
H__462L	55	H__65PTRS	79	H__733L	59	H_1-2	83
H__462L2BF	55	H__65STOR	78	H__733LRT	60	H_1-3	83
H__462R	55	H__65TL	78	H__733R	59	H_17201	93
H__462R2BF	55	H__65TR	78	H__733RRT	60	H_17202	93
H__477	70	H__65WDL	78	H__734	58	H_17203	93
H__478	69	H__65WDR	78	H__734L	59	H_17204	93
H__48WMSL	81	H__660	52	H__734R	59	H_17205	93
H__48WMSR	81	H__660F2BF	53	H__735	73	H_17206	93
H__537	69	H__66WMS	81	H__735L	59	H_17207	93
H__538	69	H__675	69	H__735LRT	60	H_17208	93
H__54WMSL	81	H__676	69	H__735R	59	H_1L	86
H__54WMSR	81	H__677	69	H__735RRT	60	H_2-1	83
H__600	52	H__678	69	H__737	69	H_2-2	83
H__600F2BF	53	H__700	52	H__738	69	H_2-3	83
H__60WMS	81	H__700F2BF	53	H__744	58	H_2L	86
H__615L	58	H__700L	53	H__744F	58	H_2S	86
H__615LF	58	H__700L2BF	53	H__762L	60	H_30WM	80
H__615R	58	H__700R	53	H__762LF	61	H_30WMS	80
H__615RF	59	H__700R2BF	54	H__762R	60	H_3-1	84
H__622L	60	H__701BF2BF	51	H__762RF	61	H_3-2	84
H__622LF	61	H__701F2BF	53	H__BK733L	57	H_3-3	84
H__622R	60	H__701L2BF	54	H__BK733R	57	H_36WM	80
H__622RF	61	H__701LB2BF	52	H__CH6636L	72	H_36WMS	80
H__625L	58	H__701R2BF	54	H__CH6636R	72	H_3L	86
H__625LF	58	H__701RB2BF	52	H__CH7236L	72	H_4-1	86
H__625R	58	H__720	52	H__CH7236R	72	H_4-2	86
H__625RF	59	H__720B	51	H__CH7272	71	H_42WM	80
H__633L	59	H__720BF2BF	51	H__ULF	65	H_42WMS	80
H__633R	59	H__720F2BF	53	H__UP	65	H_48WM	80
H__634L	59	H__721L	53	H__UP2BF	65	H_48WMSL	80
H__634R	59	H__721L2BF	53	H__UPF	65	H_48WMSR	80
H__641L	53	H__721LB	51	H_01101	88	H_54WM	80
H__641L2BF	53	H__721LB2BF	52	H_01102	88	H_54WMSL	80
H__641R	53	H__721R	53	H_01103	88	H_54WMSR	80
H__641R2BF	54	H__721R2BF	54	H_01104	88	H_60WM	80
H__644	58	H__721RB	52	H_01105	88	H_60WMS	81

Model Number Index

Casegoods (cont.)

Model	Page	Model	Page	Model	Page	Model	Page
H_66WMM	80	HW_84	77	HW_RS3030	62	TR_3045ARH	42
H_66WMS	81	HW_897L	57	HW_RS3036	62	TR_3048ALH	42
H_72WMM	80	HW_897R	57	HW_RS3042	62	TR_3048ARH	42
H_72WMS	81	HW_898L	56	HW_RS3048	62	TR_3048BLH	45
H36	76	HW_898R	57	HW_RS3060	62	TR_3048BRH	45
HW_315	71	HW_899L	56	HW_RS3066	62	TR_3064	42
HW_316	70	HW_899R	56	HW_RS3072	62	TR_3064L	43
HW_317	71	HW_CB29	77	HW_SSBK6048	87	TR_3064R	43
HW_318	70	HW_CB2930	77	HW_ST48	61	TR_3066	46
HW_319	71	HW_CB65	77	HW_ST60	61	TR_3068	46
HW_36	77	HW_CD19	68	HWTB1430	74	TR_3071	46
HW_36B-O	76		109	HWTB1436	74	TR_3072	42
HW_384	63	HW_CD25	68	HWTB1442	74	TR_30721LB	41
HW_415	71	HW_CD32	68	HWTB1448	74	TR_30721RB	41
HW_416	70	HW_CD38	68	HWTB1454	73	TR_3074	42
HW_417	71	HW_CHO3636	72	HWTB1460	73	TR_3075L	43
HW_418	70	HW_CHO4242	72	HWTB1466	73	TR_3075R	43
HW_448	62	HW_CHO6636L	72	HWTB1472	73	TR_3076L	43
HW_449	62	HW_CHO6636R	72	HWTB1478	73	TR_3076R	43
HW_44930L	62	HW_CHO7236L	72	MDWMM	49	TR_3077	46
HW_44930R	62	HW_CHO7236R	72		68	TR_3096	49
HW_4495	62	HW_CHO7272	72		109	TR_32	49
HW_48	77	HW_DSBK6048	87		117	TR_3452L	45
HW_4818	70	HW_K21	68	PKMP36_	117	TR_3452R	45
HW_484	61		109	PKP25_	117	TR_362D	47
HW_485	61	HW_K25	68	PKP35_	117	TR_4026DF	46
HW_495L	61	HW_K29	68	TBBF70	47	TR_733	44
HW_495R	61	HW_MMS	78	TBBP62	47	TR_734	44
HW_496L	61	HW_RS2430	63	TL2P	47	TR_734BC	44
HW_496R	61	HW_RS2430L	63		68	TR_762D	48
HW_517	71	HW_RS2430R	63	TR_29	49	TR_76DS	48
HW_518	70	HW_RS2436	63	TR_30	49	TR_76DWD	48
HW_60	77	HW_RS2436L	63	TR_3009	49	TR_B36	47
HW_610	67	HW_RS2436R	63	TR_3010	49	TR_B52	47
HW_611L	67	HW_RS2442	63	TR_3011L	49	TR_B76	47
HW_611R	67	HW_RS2442L	63	TR_3011R	49	TR_W72	48
HW_615	71	HW_RS2442R	63	TR_3020	41	TR_W722D	48
HW_616	70	HW_RS2448	63	TR_3025	41	TR_W722DNH	48
HW_617	71	HW_RS2448L	63	TR_3026DF	45	TR_W72NH	48
HW_618	70	HW_RS2448R	63	TR_302DF	45	UWSC_3630	87
HW_65	77	HW_RS2454	63	TR_3030	41	UWSC_3630A	87
HW_710	67	HW_RS2454L	63	TR_3030B	41	V__21	114
HW_717	71	HW_RS2454R	63	TR_3032DF	46	V__22	117
HW_718	70	HW_RS2460	63	TR_3033L	44	V__28	117
HW_72	77	HW_RS2460L	63	TR_3033R	44	V__326	114
HW_737AD	69	HW_RS2460R	63	TR_3036DF	46	V__336	115
HW_738AD	69	HW_RS2466	63	TR_3040	45	V__34	117
HW_7817	71	HW_RS2466L	63	TR_3040BLH	45	V__346	114
HW_7818	70	HW_RS2466R	63	TR_3040BRH	45	V__426	115
HW_797	56	HW_RS2472	63	TR_3041	45	V__604F	112
HW_798	56	HW_RS2472L	63	TR_3042	43	V__610	116
HW_799	56	HW_RS2472R	63	TR_3045ALH	42	V__611L	116

Model Number Index

Casegoods (cont.)

Model	Page	Model	Page	Model	Page	Model	Page
V__611R	116	VC_3220PO	107	VC_6624TL	99	VC_72LL48	95
V__614F	112	VC_3220PP	107	VC_6624TR	99	VC_72LL48H	96
V__625LF	113	VC_3620LF	107	VC_6630DL3	98	VC_72LR42	95
V__625RF	113	VC_3620S	107	VC_6630DR3	98	VC_72LR42H	96
V__633L	113	VC_4820OPP	107	VC_6630T	99	VC_72LR48	95
V__633R	113	VC_4820POP	107	VC_6630TL	99	VC_72LR48H	96
V__651L2BF	112	VC_4820PPO	107	VC_6630TL3	98	VC_72UL42	96
V__651R2BF	112	VC_4820PPP	107	VC_6630TR	99	VC_72UL42H	97
V__652D	115	VC_6020-4	101	VC_6630TR3	99	VC_72UL48	96
V__6602BF	111	VC_6020-4S	102	VC_66LL42	95	VC_72UL48H	97
V__677	116	VC_6020L2	101	VC_66LL42H	96	VC_72UR42	97
V__704F	112	VC_6020L3	101	VC_66LL48	95	VC_72UR42H	97
V__714F	112	VC_6020LF	103	VC_66LL48H	96	VC_72UR48	97
V__7202BF	111	VC_6020LS	103	VC_66LR42	95	VC_72UR48H	97
V__720B2BF	111	VC_6020R2	101	VC_66LR42H	96	VC_798	108
V__721L2BF	112	VC_6020R3	102	VC_66LR48	95	VC_BK3672	108
V__721LB2BF	111	VC_6020RF	103	VC_66LR48H	96	VC_MDS3648	108
V__721R2BF	112	VC_6020RS	103	VC_66UL42	96	VC_MTB	108
V__721RB2BF	111	VC_6024TL	99	VC_66UL42H	97	VC_OH6020	104
V__722LF	114	VC_6024TR	99	VC_66UL48	96	VC_OH6020L	105
V__722RF	114	VC_6030T	99	VC_66UL48H	97	VC_OH6020R	105
V__725LF	113	VC_6030TL	99	VC_66UR42	97	VC_OH6620	104
V__725RF	113	VC_6030TL3	98	VC_66UR42H	97	VC_OH6620L	105
V__733	113	VC_6030TR	99	VC_66UR48	97	VC_OH6620R	105
V__733L	113	VC_6030TR3	99	VC_66UR48H	97	VC_OH7220	104
V__733R	113	VC_60LL42	95	VC_7220-4	101	VC_OH7220L	105
V__737	116	VC_60LL42H	96	VC_7220-4S	102	VC_OH7220R	105
V_129	115	VC_60LL48	95	VC_7220DLF	102	XD1618SC	106
V_36	115	VC_60LL48H	96	VC_7220DS	102	XD1620SC	106
V_3610SDW	108	VC_60LR42	95	VC_7220L2	101		107
V_48	115	VC_60LR42H	96	VC_7220L3	101	XD2019	85
V_485	114	VC_60LR48	95	VC_7220LF	103	XD2020SC	106
V_65	115	VC_60LR48H	96	VC_7220LFS	102	XD2037	85
V_72	115	VC_60UL42	96	VC_7220LS	103	XD2055	85
V_799	112	VC_60UL42H	97	VC_7220R2	101	XDAS36	68
V_84	115	VC_60UL48	96	VC_7220R3	102		109
VC_1620P	106	VC_60UL48H	97	VC_7220RF	103	XDAS42	68
VC_20	106	VC_60UR42	97	VC_7220RS	103		108
VC_2020	106	VC_60UR42H	97	VC_7224TL	99	XDAS48	68
VC_2042	100	VC_60UR48	97	VC_7224TR	99		109
VC_2042L2	100	VC_60UR48H	97	VC_7230DL3	98	XDECCA	109
VC_2042L3	100	VC_6620-4	101	VC_7230DR3	98	XDECD20	109
VC_2042R2	100	VC_6620-4S	102	VC_7230L3	98	XDEK20	109
VC_2042R3	100	VC_6620L2	101	VC_7230R3	98	XDTB2023	104
VC_2048	100	VC_6620L3	101	VC_7230T	99	XDTB2029	104
VC_2048L2	100	VC_6620LF	103	VC_7230TL	99	XDTB2035	104
VC_2048L3	100	VC_6620LS	103	VC_7230TL3	98	XDTB2036	105
VC_2048R2	100	VC_6620R2	101	VC_7230TR	99	XDTB2042	105
VC_2048R3	100	VC_6620R3	102	VC_7230TR3	99	XDTB2048	105
VC_3220-4	107	VC_6620RF	103	VC_72LL42	95		
VC_3220OP	107	VC_6620RS	103	VC_72LL42H	96		

Model Number Index

Tables

Model	Page	Model	Page	Model	Page	Model	Page
1528	154	CT_6620T	145	H__C308D	129	HA_6624T_	141
5600	157	CT_6624T	145	H__C364D	129	HA_6630C_	141
5828	154	CT_6630T	145	H__C368D	129	HA_6630T_	141
5720_	159	CT_7220T	145	H__C414D	129	HA_7224C_	141
5720MET	159	CT_7224T	145	H__C418D	129	HA_7224T_	141
5723_	159	CT_7230T	145	H__R304D	130	HA_7230C_	141
5723MET	158	CT_R30T	145	H__R308D	130	HA_7230T_	141
5727_	159	CT_R36T	145	H__R364D	130	HW_BT12048	126
5727MET	159	CT_R42T	145	H__R368D	130	HW_BT14448	126
5920_	157	CT_R48T	145	H__R414D	130	HW_BT7236	126
5920MET	156	CT_S30T	145	H__R418D	130	HW_BT9648	126
5923_	156	CT_S36T	145	H__S304D	131	HW_CT20	155
5923MET	156	CT_S42T	145	H__S308D	131	HW_CT48	155
5927_	157	DA_3624C_	143	H__S364D	131	HW_ET18	155
5927MET	156	DA_3624T_	142	H__S368D	131	HW_ET23	155
6720	160	DA_3630C_	143	H__S414D	131	HW_LS18	138
6723	160	DA_3630T_	142	H__S418D	131	HW_LS46C	138
6730	160	DA_4224C_	143	H__717-O	141	HW_MTB	138
6733	160	DA_4224T_	142	H_C300S	129	HW_MTBTB	138
9120	161	DA_4230C_	143	H_C360S	129	HW_RT12048	127
9123	161	DA_4230T_	142	H_C410S	129	HW_RT14448	127
BTR534TB	165	DA_4824C_	143	H_R300S	130	HW_RT7236	127
BTR536TB	165	DA_4824T_	142	H_R360S	130	HW_RT9648	127
CT_20S60T	146	DA_4830C_	143	H_R36T	165	HW_T7236	125
CT_20S90T	146	DA_4830T_	142	H_R410S	130	HW_T9648	125
CT_24S60T	146	DA_5424C_	143	H_R42T	165	HW_TR36	125
CT_24S90T	146	DA_5424T_	142	H_S300S	131	HW_TR42	125
CT_3620C	146	DA_5430C_	143	H_S360S	131	HW_TR48	125
CT_3620T	145	DA_5430T_	142	H_S410S	131	M_RB624	133
CT_3620Z	146	DA_6024C_	143	HA_3624C_	141	M_RB624P	134
CT_3624T	145	DA_6024T_	142	HA_3624T_	141	M_RB630	133
	165	DA_6030C_	143	HA_3630C_	141	M_RB630P	134
CT_3630T	145	DA_6030T_	142	HA_3630T_	141	M_RB824	133
	165	DA_6624C_	143	HA_4224C_	141	M_RB824P	134
CT_4020H	146	DA_6624T_	142	HA_4224T_	141	M_RB830	133
CT_4220C	146	DA_6630C_	143	HA_4230C_	141	M_RB830P	134
CT_4820T	145	DA_6630T_	142	HA_4230T_	141	M_RC624	133
CT_4824C	146	DA_7224C_	143	HA_4824C_	141	M_RC624P	134
CT_4824H	146	DA_7224T_	142	HA_4824T_	141	M_RC630	133
CT_4824T	145	DA_7230C_	143	HA_4830C_	141	M_RC630P	134
	165	DA_7230T_	142	HA_4830T_	141	M_RC824	133
CT_4824Z	146	E_BT4896	126	HA_5424C_	141	M_RC824P	134
CT_4830C	146	E_T4848A	126	HA_5424T_	141	M_RC830	133
CT_4830T	145	H__2224	138	HA_5430C_	141	M_RC830P	134
	165	H__2248	138	HA_5430T_	141	M_TB636	134
CT_6020T	145	H__4D4SBC	139	HA_6024C_	141	M_TB636P	135
CT_6024T	145	H__6518SL	139	HA_6024T_	141	M_TB642	134
CT_6030H	146	H__6518SR	139	HA_6030C_	141	M_TB642P	135
CT_6030T	145	H__754	139	HA_6030T_	141	M_TB836	134
CT_6030Z	146	H__C304D	129	HA_6624C_	141	M_TB836P	135

Model Number Index

Tables (cont.)

Model	Page
M_TB842	134
M_TB842P	135
M_TC636	134
M_TC636P	135
M_TC642	134
M_TC642P	135
M_TC836	134
M_TC836P	135
M_TC842	134
M_TC842P	135
ML_1C	147
ML_1L	147
ML_2C2L	147
ML_4C	147
ML_4L	147
MP_48	149
MP_60	149
MP_72	149
ST_2424F	151
	158
ST_4824F	151
	158
ST_4824C	151
ST_4824D	151
ST_6024C	151
ST_6024D	151
ST_6030S	151
ST_6630S	151
ST_7224C	151
ST_7224D	151
ST_7230S	151
ST_9630S	151
TD_4824FS	149
TD_4830FS	149
TD_6024FS	149
TD_6030FS	149
TD_7224FS	149
TD_7230FS	149
TE_T4848A	123
TE_T4896	123
TR_4020	153
TR_4023	153
TR_T120	123
TR_T120P4	122
TR_T120SQ	122
TR_T144	123
TR_T144P4	122
TR_T144SQ	122
TR_T72	123
TR_T72P4	122

Model	Page
TR_T72SQ	122
TR_T96	123
TR_T96P4	122
TR_T96SQ	122
TR_TR36	121
TR_TR42	121
TR_TR48	121
V_T120	137
V_T120CYL	137
V_T144	137
V_T144CYL	137
V_T72	137
V_T72CYL	137
V_T96	137
V_T96CYL	137
V_TR36C	137
V_TR42C	137
V_TR42X	137
V_TR48C	137
V_TR48X	137
XDAMP36	146
XDAMP42	146
XDAMP48	146

Seating

Model	Page
58B	192
74A	251
74B	251
74C	251
94CTC	274
143	231
144	231
151	231
151MET	233
152	231
152MET	233
153	231
153MET	233
154	232
154MET	233
155	232
155MET	233
156	232
156MET	233
157	232
158	232
213	295
213U	295
216	295
216U	295
217	295
217U	295
222	296
222U	296
223	296
223U	296
226	296
226U	296
230	297
230U	297
231	297
231U	297
232	297
232U	297
280	301
280_	301
283	301
283_	301
286	301
286_	301
290	293
461	261
461_	261
715-CART	289
720-CART	299

Model Number Index

Seating (cont.)

Model	Page	Model	Page	Model	Page	Model	Page
720-GC	299	980-4	267	1534	217	2091	223
723	299	982	267	1535	217	2092	224
723SBC	299	983	268	1536	217	2093-IF	224
724	299	984	268	1537	217	2102	224
724SBC	299	984-2	268	1538	217	2172	224
733	289	984-20	268	1539	208	2177	258
734	289	984-3	268	1539C	212	2182	225
752	263	984-30	269	1540	217	2277	258
752G	263	984-4	269	1545	218	2372-IF	225
757	263	984-40	269	1554	208	2372-OF	225
757B	263	1001	256		218	2373-IF	225
759	263	1003	256	1554C	213	2373-OF	225
759G	263	1007	256	1555	218	3473	258
902	285	1071	256	1559	208	3477	258
903	285	1077	256	1559C	213	4013	259
904	285	1271	255	1560	218	4016	259
904-2	285	1277	255	1572	218	4053	247
904-3	286	1501	207	1573	218	4072	247
904-4	286	1501C	211	1577	219	4073	247
905	286	15012	209	1578	219	4074	247
906	286	1502	207	1580	219	4075	247
907	286	1502C	211	1583	219	4076	247
908	287	15022	209	1584	219	4077	259
909	287	1503	207	1590	209	4078	259
910	287	1503C	211	1590C	213	4083	247
912	277	1504	207	1595-IF	209	4141	257
912MET	281		215	1595C-IF	213	4147	257
913	277	1504C	211	1595-OF	209	4161	257
913MET	281	1505	207	1595C-OF	213	4167	257
914	277		215	1727	227	4178	259
914MET	281	1505C	211	1727D	227	4277	259
914-2	277	1506	207	1737	227	4301	179
914-3	278		215	1737D	227	4302	179
914-4	278	1506C	212	1747	228	4303	179
914MET-2	281	1507	208	1757	228	4831	255
914MET-3	282	1507C	212	1818	221	4833	255
914MET-4	282	15072	209	2002	221	4837	255
915	278	1508	208	2002-IF	221	5301	181
915MET	282	1508C	212	2002-OF	221	5302	181
916	278	1509	208	2003	221	5303	181
916MET	282	1509C	212	2013	257	5321	181
917	279	1510	215	2016	258	5322	181
	282	1517	215	2032-IF	222	5326	181
918	279	1518	215	2032-OF	222	5336	265
918MET	283	1520	216	2033-IF	222	5607	265
919	279	1523	216	2033-OF	222	5607A	183
	283	1524	216	2072	222	5800	183
980	267	1525	216	2073	223	5801	183
980-2	267	1532	216	2082	223	5802	183
980-3	267	1533	216	2083	223	5803	

Seating (cont.)

Model	Page	Model	Page	Model	Page	Model	Page
5804	183	5875R	190	5925MET	176	7442	245
5805	184	5875UAH	190	5926MET	176	7443	245
5806	184	5876	191	5935-IF	172	9118	291
5807	184	5876UAH	191	5935MET-IF	176	9128	291
5809	184	5877	196	5935MET-OF	176	9131	253
5810	195	5878	197	5935-OF	172	9132	253
5811	199	5879	197	5936MET	177	9133	253
5812	199	5880	201	5948	172	9138	253
5813	199	5881	204	5948MET	175	9193CTC	291
5814	199	5882	204	5965-IF	172	9400	271
5815	200	5883	204	5965MET-IF	177	9403	271
5816	200	5884	205	5965MET-OF	177	9405	271
5817	195	5886	205	5965-OF	172	9410	271
5818	195	5890	192	6101	237	9413	270
5819	195	5895	192	6102	237	9415	272
5820	184	5901	169	6103	237	9420	272
5821	185	5901MET	173	6201	239	9423	272
5822	185	5902	169	6202	239	9425	273
5823	185	5902MET	173	6203	239	9430	273
5825	185	5903	169	6301	241	9433	273
5826	185	5903MET	173	6302	241	9435	273
5827	186	5904	169	6303	241	9500	274
5827UA	186	5904CL	169	6401	235	9503	274
5829	186	5904CLR	170	6402	235	9505	274
5830	186	5904CR	170	6403	235	9510	275
5830OS-IF	186	5904MET	173	7301	249	9513	275
5831	187	5904MET-CL	173	7302	249	9515	275
5832	187	5904MET-CLR	174	7303	249	BS	191
5833	187	5904MET-CR	174	7331	243	BS91	223
5834	203	5905	170	7332	243	BS92	224
5835-IF	187	5905MET	174	7333	243	BS93-IF	224
5835-OF	187	5906	170	7335	243	CH	229
5836	188	5906MET	174	7339L	243	DH	229
5837	188	5908	170	7339R	244	NH	229
5838-IF	203	5908MET	174	7401	249	TAL	193
5839	188	5909	170	7402	249	TAR	193
5843	188	5909MET	174	7403	250	UA	192
5844	188	5911	171	7420	250	UAL	193
5848	189		175	7421	250	UAR	193
5850	201	5912	171	7423	250	UG	147
5853	189	5912MET	175	7424	250		149
5860	189	5913	171	7425	251		209
5865-IF	189	5913MET	175	7426	251		219
5865-OF	189	5914	171	7431	244		
5868-IF	203	5914MET	175	7432	244		
5870	196	5921MET	175	7433	244		
5874	203	5922MET	175	7434	244		
5875	190	5924	171	7435	245		
5875-IF	190	5924MET	176	7436	245		
5875L	190	5925	171	7441	245		

Model Number Index

Healthcare

Model	Page	Model	Page
580	319	PA	306
580CB	319		312
581	319		317
581CB	319	PB	306
582	319		312
801	309	PL	307
803	309		313
805	309	RA	312
807	309	WA	306
810	303		312
813	303		317
815	303		
817	304		
821	315		
822	315		
823	315		
826	316		
826-2	316		
830	309		
831	310		
832	310		
833	310		
834	310		
835	311		
836	311		
837	311		
838	311		
839	311		
840	304		
841	304		
843	304		
844	305		
845	305		
847	305		
BB	306		
	312		
C	307		
DPS	306		
	312		
FH	307		
	313		
FT	306		
	312		
HM	307		
	313		
LPT	306		
	312		
MB	307		
	313		
MT	307		
MTB	307		

