

August 2022 Price List

integro

GENERAL INFORMATION

FINISHES	i
ORDERING & SPECIFICATIONS	ii - iv

ALPINE LOUNGE COLLECTION

ALTA	ALC 2 - 3
APRÈS	ALC 4 - 5
BRIGHTON	ALC 6 - 7
BRIGHTON SLOPE	ALC 8
ALPINE FOOTSTOOL	ALC 9
SOLITUDE	ALC 10 - 11
SOLITUDE SLOPE	ALC 12
SUMMIT	ALC 13 - 15
ALPINE BENCHES	ALC 16
ALPINE OTTOMANS	ALC 17 - 18
ALPINE TABLES	ALC 19 - 29

BENCH COLLECTIONS

A-BENCHES	IBC 2 - 3
KIXSY PERCH	IBC 4

CH KIDS COLLECTION

CH KIDS SEATING	CHK 2 - 4
CH KIDS SYSTEMS	CHK 5 - 6
CH KIDS OTTOMANS	CHK 7 - 8

COASTAL COLLECTION | METAL

BAY METAL	CCM 2 - 4
MARINA METAL	CCM 5 - 6
MARINA UPHOLSTERED ARM WITH METAL LEGS	CCM 7 - 9
MARINA / BAY OTTOMAN WITH METAL LEGS	CCM 10
REEF UPHOLSTERED ARM WITH METAL LEGS	CCM 11 - 12
TIDE METAL	CCM 13 - 15
TIDE METAL SYSTEM SEATING & TABLES	CCM 16 - 17
TIDE METAL SYSTEM SPECIFICATIONS	CCM 18
TIDE FOOTSTOOLS	CCM 19
TIDE REPLACEMENT COMPONENTS/COVERS	CCM 20
COASTAL METAL BENCHES	CCM 21
COASTAL METAL TABLES	CCM 22

COASTAL COLLECTION | WOOD

BAY WOOD	CCW 2 - 4
MARINA WOOD	CCW 5 - 6
MARINA UPHOLSTERED ARM WITH WOOD LEGS	CCW 7 - 9
MARINA / BAY OTTOMAN WITH WOOD LEGS	CCW 10
REEF ROCKER	CCW 11 - 12
REEF WOOD	CCW 13 - 14
REEF II WOOD WITH CLEAN-OUT	CCW 15 - 16
REEF UPHOLSTERED ARM WITH WOOD LEGS	CCW 17 - 18
TIDE WOOD	CCW 19 - 22
TIDE WOOD SYSTEM SEATING & TABLES	CCW 23 - 24
TIDE WOOD SYSTEM SPECIFICATIONS	CCW 25
TIDE FOOTSTOOLS	CCW 26
TIDE REPLACEMENT COMPONENTS/COVERS	CCW 27
COASTAL WOOD BENCHES	CCW 28

COFFEE HOUSE COLLECTION

STANDARD BACK SEATING	CHC 2 - 3
HIGH BACK SEATING	CHC 4 - 5
COFFEE HOUSE OPTIONS	CHC 6 - 9
COUNTERS	CHC 10 - 13
HIGH BACK OPTIONS	CHC 14 - 15
SYSTEM SEATING	CHC 16 - 25
OTTOMANS	CHC 26 - 29
SYSTEM SPECIFICATIONS	CHC 30 - 31

KALLISE LOUNGE COLLECTION

KL3 - 3" WIDE UPHOLSTERED ARM	KLC 2 - 4
KL5 - 5" WIDE UPHOLSTERED ARM	KLC 5 - 7
KALLISE BENCHES & OTTOMANS	KLC 8 - 9
KALLISE TABLES	KLC 10 - 12

PAX LOUNGE COLLECTION

PAX SEATING	PLC 2 - 3
PAX POUFS	PLC 4 - 5
PAX TABLES	PLC 6 - 9

PYXIS COLLECTION

PYXIS SEATING	PC 2
PYXIS BENCHES	PC 3
PYXIS SYSTEMS	PC 4
PYXIS SYSTEM SPECIFICATIONS	PC 4

TABLE COLLECTIONS

A-TABLES	ITC 2 - 7
CUBE TABLES WITH SELF EDGE	ITC 8 - 10
DRUM TABLES WITH SELF EDGE	ITC 11 - 13
CUBE TABLES WITH SOLID WOOD EDGE	ITC 14 - 16
DRUM TABLES WITH SOLID WOOD EDGE	ITC 17 - 19
KIXSY PULL-UP TABLE	ITC 20

THE LOUNGE COLLECTION

ELITE	TLC 2 - 5
FLAIR	TLC 6 - 9
RENDEZVOUS	TLC 10 - 13
RENDEZVOUS OTTOMANS	TLC 14
RENDEZVOUS TABLES	TLC 15 - 16
RENDEZVOUS SQUARED	TLC 17 - 20
RENDEZVOUS SQUARED OTTOMANS	TLC 21
SOIRÉE	TLC 22 - 24
SOIRÉE OTTOMANS	TLC 25

TRIA COLLECTION

TRIA UPHOLSTERED ARM WITH STRAIGHT BACK	TC 2 - 4
TRIA SQUARE ARM WITH STRAIGHT BACK	TC 5 - 7
TRIA OTTOMANS	TC 8
TRIA SYSTEMS	TC 9 - 11
TRIA TABLES	TC 12 - 14

VALAYO COLLECTION

VALAYO CHAIRS	VC 2
VALAYO UPHOLSTERED TOP BENCHES	VC 3
VALAYO HARD TOP BENCHES AND TABLES	VC 4

WELLNESS DIVIDER

WELLNESS DIVIDER	WD 2
------------------	------

GRADE

A	LG HI-MACS	Arctic White, Cream, Almond Pearl
B	LG HI-MACS	Allspice Quartz, Venetian Sand, Desert Sand
C	LG HI-MACS	Frostine, Gray, Haze
D	CORIAN	Deep Titanium, Deep Sable, Weathered Concrete

METAL FINISH | STANDARD OPTIONS

POWDER COAT	Glacier	CX	Bronze	ZX	BRUSHED CHROME	BC
	Chalk	HX	Bark	KX	BRUSHED ALUMINUM	BA
	Cement	MX	Slate	SX		
	Silver	VX	Onyx	BX		
	Fossil	FX				

NOTE: See each series for available standards.

WOOD FINISH | STANDARD OPTIONS

HARD MAPLE

INSPIRED COLORS	Sugar	Pewter Mist	ORIGINAL COLORS	Vanilla	Saffron
	Sea Salt	Poppy Seed		Ginger	Chili
	Almond	Hazelnut		Cinnamon	Clove
	Jasmine	Mocha		Nutmeg	Pepper

NOTE: Custom Wood Finishes are available at a one-time upcharge of \$300 NET per color. Contact your customer service representative for more details.

STOCKED LAMINATE OPTIONS FOR WOOD FINISHES

INSPIRED WOOD FINISH	HPL MANUFACTURER	NAME/PATTERN	ID#	ORIGINAL WOOD FINISH	HPL MANUFACTURER	NAME/PATTERN	ID#
Sugar	Wilsonart	Phantom Pearl	8211K-28	Vanilla	Pionite	Hardrock Maple	WM791-S
Sea Salt (opt. 1)	Wilsonart	Asian Sand	7952K-18	Ginger	Pionite	Millwork Cherry	WC431-H
Sea Salt (opt. 2)	Wilsonart	Wallaby	D439-60	Cinnamon	Nevamar	Blossom Cherry	WC5581N
Almond	Wilsonart	Raw Chestnut	7975K-12	Nutmeg	Wilsonart	Cherrywood	11062K-07
Jasmine	Nevamar	Beige Renaissance	WM8258-T	Saffron	Wilsonart	Judicial Walnut	11065K-07
Pewter Mist	Nevamar	Luminary Teak	WT0005T	Chili	Wilsonart	Empire Mahogany	7122K-07
Poppy Seed (opt. 1)	Formica	Silver Riftwood	6413-NG	Clove	Wilsonart	Cafelle	7933K-07
Poppy Seed (opt. 2)	Pionite	Absolute Acajou	WY160-SD	Clove (alt)	Wilsonart	Cocobala	7942K-07
Poppy Seed (opt. 3)	Wilsonart	Phantom Cocoa	8213K-28	Pepper	Wilsonart	Black	1595K-07
Poppy Seed (opt. 4)	Wilsonart	Skyline Walnut	7964K-12				
Hazelnut (opt. 1)	Wilsonart	Studio Teak	7960K-18				
Hazelnut (opt. 2)	Pionite	Pralines & Cream	WW160-SD				
Mocha (opt. 1)	Wilsonart	Hampton Walnut	7959K-78				
Mocha (opt. 2)	Formica	Cocoa Maple	7739-58				
Mocha (opt. 3)	Pionite	Gunstock Savoy Walnut	WW971-SD				

NOTE: Non-Stocked Laminate selections incur a \$50 NET charge per color, per order.

ORDERING & SPECIFICATIONS

HOW TO USE THIS PRICE LIST

Each series or collection has the available options within that series. Available options may include: legs/bases, arm caps, seats, tablets, power, and other product options. Please see each series for the available options, details, and pricing.

Integra's PDF price list has links from the Table of Contents to each section for easier movement through the document. Also, at the top of each page is an icon that will take you back to the Table of Contents page.

And of course, our exceptional Customer Service Team is happy to help you with quotes, product questions and anything else you need to work with Integra products!

GENERAL ORDERING INFORMATION

Direct all orders to: **INTEGRA, INC.**
PO BOX M
807 Wisconsin Street
Walworth, WI 53184
(800) 235-0234 (262) 275-2161 (262) 275-3614 FAX
customerservice@integraseating.com

When placing an order, please be sure to include ALL of the following:

- Your Company Name, Address, Telephone, Fax and Email Address
- Contact Person for Order and Email Address
- Purchase Order Number, Bill To Address, Ship to Address, Order Date
- Integra Quote Number, if Integra provided a Quote
- Quantity
- Product Code/Number
- Product Description
- Selected Options
- Fabric: Pattern and Color
- Wood Species
- Wood Finish
- Line Drawings for System Orders
- Requested Ship Date
- Any Special Instructions

ORDERS & ORDER CONFIRMATION:

Orders may be received via fax, mail or emailed to customerservice@integraseating.com. Acknowledgments will be emailed. Changes in the ship to address after order entry will incur additional charges.

CHANGE ORDERS AND CANCELLATIONS:

Written changes on orders or cancellations of orders will only be accepted within 48 hours after receipt of order.

PRICES:

Published prices are List F.O.B. destination on shipments over \$7,500 List and within the Contiguous U.S. Shipments under \$7,500 List will incur a \$300 NET freight charge. Integra prefers to ship furniture set-up at the factory and blanket-wrapped. In certain instances, furniture will be packaged in cartons and shipped; cartoning charges may apply.

Prices do not include:

- storage or insurance charges
- sales or other taxes
- multiple deliveries, uncartoning, assembly, or installation

TERMS OF PAYMENT:

Orders require prepayment upon placement of original order, balance required prior to shipment. Terms for accredited customers are NET 30. Integra may request advance payment at any time. A service charge for any special handling may be assessed. A service charge of 1.5% per month will be assessed on unpaid balance of all past due accounts.

RETURNS:

No returns of furniture will be accepted without our written consent and shipping instructions. Special order items are not subject to return.

DESIGN AND SPECIFICATIONS

Integra reserves the right to alter product design for purposes at our discretion including: construction and material improvements, pricing or dimension corrections, and other purposes without notification. All dimensions shown are approximate. If critical specifications are required, please consult the factory.

GENERAL PRODUCT SPECIFICATIONS:

Integra's products listed in this contract price list include these features:

- High Resilience Foam in All Seat Units
- No-spring Dymetrol Suspension System in all seating that uses a suspension system
- 16 Gauge Steel Tubular Inner Structure and Assembly Patented to Integra
- All Integra chairs and seating units have a 1000 lbs dynamic load capacity and a 2000 lbs static load capacity.
- Product specifications for all product lines are available upon request

CUSTOM PRODUCT DESIGN & ENGINEERING:

Integra tries to accommodate custom request to best meet the needs of our customers. Please bring custom requests to our Project Management Team. They will work with our Engineering Team for review and approval. **If approved, most custom requests will incur a \$300 NET Custom Engineering Fee.** If the custom request involves a significant amount of custom design and engineering that charge may be increased. Our team will notify the requestor of any increase in charges.

LIFETIME WARRANTY:

Products manufactured by Integra after October, 1 2007 are warranted to be free of defects in material and workmanship under normal use for the lifetime of the product. Product must be properly assembled, maintained and in use by its original owner. Under the warranty, the obligation of Integra is limited to the repair or replacement of such furniture. Damage in transit or by negligence, abuse, abnormal usage, misuse, accidents or alterations nullifies the warranty.

As Buyer's sole remedy under this warranty, Integra, at its option, will repair or replace damaged parts at no charge to the original owner of record provided the replacement or return has previously been authorized by Integra under terms of this warranty. Normal aging and wear of fabrics, filling materials, and finishes are excepted from this warranty. Any labor charges incurred will be at the Buyer's expense. It is expressly agreed that this remedy of repair, replacement or credit, at Integra's option, is Buyer's exclusive remedy under this warranty. In no event shall Seller be liable for consequential damages.

All other express or implied warranties made by any sales representative, or agent, or other representative, including any warranty of merchantability or fitness for a particular use, are hereby excluded. A-Chairs carry a 10 year warranty. Electric Power Ports carry a one year warranty.

FABRICS:

In order to fit the wide range of our customer's needs, Integra currently has partnerships and graded-in programs with these textile companies:

Anzea	www.anzea.com	877.862.6932
Arc-Com	www.arc-com.com	800.223.5466
Architex	www.architex-ljh.com	800.621.0827
Camira	www.camirafabrics.com	616.288.0655
CF Stinson	www.cfstinson.com	800.841.6279
Carnegie	www.carnegiefabrics.com	800.727.6770
DesignTex	www.designtex.com	800.221.1540
LDI	www.lidiinteriors.com	866.332.0700
Maharam	www.maharam.com	800.645.3943
Mayer	www.mayerfabrics.com	800.428.4415
Momentum	www.memosamples.com	800.366.6839
UltraFabrics	www.ultrafabricsinc.com	877.309.6648
Unika Vaev	www.unikavaev.com	800.237.1625

For a listing of the current graded-in fabrics and grades, visit our website at integraseating.com/fabrics.

DESIGN AND SPECIFICATIONS (CONTINUED)

Integra offers a wide range of fabrics to our customers in our graded-in program. Integra does not stock fabric; all textiles are ordered from the distributor at the time we receive an order. Integra is not responsible for differences in color between material supplied and samples from which choices have been made, nor is Integra responsible for matching upholstery on existing product to any future orders. **Please note that Integra does not warranty fabrics and is not responsible for any replacement fabric, covers, or re-upholstery labor costs for failed fabrics whether graded-in or sent to us as a COM/COL. We can provide a quote for new covers at the time needed. Please contact the fabric companies for any warranty information on their own products.**

COMBINATION FABRICS (Simple and Complex):

More than one fabric may be specified and applied to the same product. Integra does not upcharge for simple fabric combinations which consist of one fabric each on a component (i.e. seat, back, arm, or front panel). For simple combinations, the price is typically based upon the highest fabric grade of the chosen fabrics on the product. Complex fabric combinations consist of multiple fabrics on a single component, such as the front of the back in Fabric A and the back of the back is in Fabric B. Complex combinations will incur a 5% upcharge. Fabric combination forms are required at the time of order. Contact Customer Service for fabric combination forms or assistance.

FABRIC APPLICATION:

Standard procedure is for Integra to match all fabrics that require matching such as plaids, prints, or stripes. If matching is not desired, this must be clearly noted on the purchase order. Integra will apply textiles to upholstered items in the manner which we deem to be the most appealing.

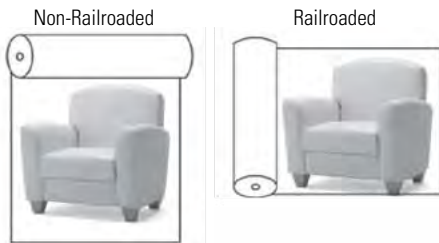

Standard procedure is for Integra to cut all fabrics non-railroaded unless otherwise clearly specified on the purchase order. See the diagrams above for a visual description of non-railroaded vs railroaded applications. To ensure correct cutting and application of the fabric, it is suggested that a clearly marked sample is sent with the purchase order when requesting a non-standard application of the fabric. Please note that when railroading fabric, it is possible that additional yardage may be required. Integra assumes no responsibility for the direction in which the textiles are applied unless it is clearly specified on the purchase order.

FABRIC REPEATS:

Fabric with larger repeats or smaller roll widths may require additional fabric than what is noted in the price list. Standard upholstery textile rolls are 54-inch wide. The yardage amounts noted are based upon 54-inch wide textiles without a pattern repeat. For calculating additional yardage due to pattern repeat or a roll less than 54" wide, see chart below to match roll width with repeat amount. For the specific textile, add both the vertical and horizontal repeat measurements together and use chart below to figure the required amount of additional yardage. Add the required additional % to the COM yardage amount noted in the current Integra Price List for total yardage needed per furniture item.

UPH. TEXTILE ROLL WIDTH	SOLID NO REPEAT	REPEAT OF 2"-14"	REPEAT OF 15"-19"	REPEAT OF 20"-27"	REPEAT OF 28"-36"
54"	0%	10%	15%	20%	25%
50" - 53"	16%	20%	25%	30%	35%
48"	16%	25%	30%	35%	40%
45"	40%	50%	55%	60%	65%
36"	50%	60%	65%	70%	75%

Contact Integra Customer Service at 800-235-0234 x4 with any questions.

For graded-in fabrics, this additional fabric yardage will be noted and charged as a separate line on the quotation, sales order, and invoice.

DESIGN AND SPECIFICATIONS (CONTINUED)

CUSTOMER'S OWN MATERIAL (C.O.M.) POLICY:

Integra will work with customer's own material with approval. A memo sample of the fabric must be sent to the factory before the fabric can be approved for upholstery purposes only; this approval is NOT an indicator of how it will perform in the field. Following approval, you will be advised of any additional yardage which may be required for your order and any upcharges for special handling and/or hand cutting. COM combo yardage will increase yardage. Contact Customer Service for combo yardage summary. COM yardage estimates are based upon 54-inch wide textiles without pattern repeat. **COM must be on one continuous roll or the same dye lot and consistent repeat.** A memo sample of your fabric should accompany the purchase order to properly identify your fabric when it arrives at the factory.

Please note that all C.O.M. fabrics must ship freight prepaid (collect shipments will not be accepted) and should be properly labeled for your order. Ship to:

Integra, Inc.

Tag for: (Your PO# of the order it is to be applied to)

810 Wisconsin Street

Walworth, WI 53184

The prices shown for COM include the product and only the labor for the fabric's application. The cost of fabric and freight costs to ship the fabric is the customer's responsibility. The performance of any fabric is the responsibility of the fabric supplier. Integra does not offer any warranty to fabrics. While we inspect fabrics for mill imperfections, some are difficult to recognize. We cannot be responsible for defects, color inaccuracies, dye lot variations, and other flaws. Under no circumstances will Integra assume responsibility for COM/COL shortages, flaws, or other such problems. While we make a concerted effort to control COM/COL materials, it is not our responsibility to monitor the receipt of these materials in order to meet delivery deadlines and we assume that customers are aware of any undue delay in delivery of their COM/COL materials.

Integra does not warranty fabrics and is not responsible for any replacement fabric, covers, or re-upholstery labor costs for failed fabrics whether graded-in or sent to us as a COM/COL. We can provide a quote for new covers at the time needed. Please contact the fabric companies for any warranty information on their own products.

WOOD FINISHES AND WOOD SPECIES:

Integra cannot be responsible for differences in color or tone between the finish sample and final finished product. This difference is due to the variations in natural material and finish surface size.

Standard Wood Species: Hard Maple

Original Wood Finishes

- Vanilla
- Ginger
- Cinnamon
- Nutmeg
- Saffron
- Chili
- Clove
- Pepper

Inspired Colors Wood Finishes

- Sugar
- Sea Salt
- Almond
- Jasmine
- Pewter Mist
- Poppy Seed
- Hazelnut
- Mocha

CUSTOM WOOD FINISH (CWF):

Integra will accept custom finish orders. This could extend lead time. There is a \$300 NET flat fee upcharge for custom finish orders. An additional upcharge is possible depending on stain. Paint finish will not be accepted. Send a wood sample which will be matched and returned to you for sign off approval. When the approval is received by Integra, the order will be entered into production. Custom wood finishes are valid for a minimum of 2 years.

METAL POWDER COAT FINISHES:

- Glacier
- Chalk
- Cement
- Silver
- Fossil
- Bronze
- Bark
- Slate
- Onyx

DESIGN AND SPECIFICATIONS (CONTINUED)

LAMINATE:

On many Integra Tables, Tablet Arms, and Arm Caps, laminate is a top option. Please see each series for availability. Pricing for laminates falls into the following categories:

Stocked Laminates

Integra has chosen specific laminates to match our standard wood finishes where possible. Contact Customer Service for a list of standard laminates. See LAM Price in Price List.

Other Laminates

Any laminate not in our stocked program, including custom or premium, will incur a \$50 NET flat fee upcharge per laminate selection on each order. Orders with custom laminate or special finishes may have extended lead times.

SOLID SURFACE:

Stocked Solid Surfaces: See current listing of Stocked Solid Surfaces

Non-Stocked Solid Surfaces: Upcharges will apply

GLASS:

Glass tops available for tables. Contact Customer Service for details and pricing.

MOISTURE BARRIER:

A moisture barrier option is available for all styles of Integra seat units. A polyurethane layer is placed between the fabric and the foam to protect the foam from any moisture. There is an upcharge for this option; please see Product Options in each series for availability, current pricing and yardage requirements per item.

CALIFORNIA TB 117 AND 133 COMPLIANCE:

All Integra products with standard fabrics pass CA TB 117 fire code requirements, and are able to pass CA TB 133 using approved fabric and **fire wall**. Contact factory for information regarding approved fabrics which meet the requirements of this technical bulletin. Application of **fire wall** for TB 133 compliance requires an upcharge; see Product Options in each series for availability, current pricing and yardage requirements per item. We cannot be responsible for flame retardancy of C.O.M. fabrics; please consult published technical data of fabric suppliers. NOTE: CA TB 133 option not available with leather.

PACKAGING & SHIPPING

FREIGHT:

All shipments over \$7,500 List include freight charges within the Contiguous United States. Please note that cartoned shipments can incur additional expenses from our freight carriers. Please contact Integra Customer Service for upcharges.

Shipments made outside the Contiguous United States will be cartoned and shipped to the Port of Exit. Cartoning charges will apply; customer is responsible for freight charges from the Port of Exit to the final destination.

Integra's standard method is to set-up and blanket wrap furniture for shipping. This requires coordination with the freight company in order to meet and unload the truck at the destination. Furniture is assembled and will need to be inspected and set in place.

Integra will require receiving information at the time of the order and will advise estimated unloading time allotted for delivery. A loading dock to accommodate a 53' trailer is required for all shipments from Integra. Please note, improper loading dock at receiving point, lack of appropriate personnel to unload product and/or excessive unloading time will incur additional charges.

At time of delivery, blankets are removed and returned with driver. Inspection & damage must be noted within time allotted for unloading.

Should the freight company discover improper loading dock or inadequate personnel for unloading at time of delivery, the freight carrier reserves the right to have freight returned; this will incur reconsignment and reshipping charges which will be billed to the customer's account and will be due before the 2nd delivery attempt.

SPECIFIC DATE DELIVERY:

If a shipment requires a specific day of delivery or time-specific delivery, additional charges will be applied by the freight company which will be added to your invoice. Shipments to New York City and Washington DC metro areas will also incur additional expenses from our freight carriers. Please contact Customer Service for upcharges.

CARTON CHARGES:

In certain cases, and as an option, we can carton our furniture for shipping. The following cartoning charges will apply:
Carton Charges: \$35 NET per chair; \$50 NET per settee; \$65 NET per sofa. Tables: \$35 NET up to 24x24x24 in size; \$50 NET up to 36x36x36 in size and all oval, half oval and rectangular tables. 42x42 and 48x48 tables will be blanket-wrapped only; they cannot be cartoned. Please note that cartoned shipments can incur additional expenses from our freight carriers. Please contact Integra Customer Service for upcharges.

MINIMUM ORDER FREIGHT CHARGE:

Shipments over \$7,500 List include freight charges within the Contiguous US. Shipments under \$7,500 List will incur a \$300 NET Freight Charge.

FREIGHT DAMAGE CLAIMS:

All Integra products are carefully inspected prior to shipment from the factory. Title to products is passed to the purchaser and Integra's responsibility ceases when the shipment is accepted for transportation by a carrier. Freight claims are the responsibility of the customer. All shipments should be carefully inspected before acceptance and the customer MUST record any damage on both copies of the freight bill, signed by the customer and the driver. Concealed damage reports must be made to the carrier within 10 days after delivery or the carrier will not be responsible. All packing materials involved in a damage claim must be saved in their original condition until they have been inspected by the proper agent.

STORAGE:

If a customer is unable to accept delivery of merchandise when Integra is ready to make a shipment, Integra reserves the right to transfer merchandise to storage. Transfer to storage and storage charges will be at customer's expense. Transfer to storage shall constitute delivery for all intents and purposes, including invoicing and payment.



ALPINE LOUNGE COLLECTION

ALTA	ALC 2 - 3
APRÈS	ALC 4 - 5
BRIGHTON	ALC 6 - 7
BRIGHTON SLOPE	ALC 8
ALPINE FOOTSTOOL	ALC 9
SOLITUDE	ALC 10 - 11
SOLITUDE SLOPE	ALC 12
SUMMIT	ALC 13 - 15
ALPINE BENCHES	ALC 16
ALPINE OTTOMANS	ALC 17 - 18
ALPINE TABLES	ALC 19 - 29



ALPINE LOUNGE COLLECTION | ALTA



CERTIFIED
CLEAN AIR GOLD



COMPONENT-BASED
CONSTRUCTION

2K STATIC
CAPACITY

1K DROP
CAPACITY

ALTA CHAIRS

STEEL LEGS/BASE WITH POWDER COAT (PC) OR BRUSHED CHROME (BC)

	MODEL	YARDS	COM	M	COL			S	T	U	W/WL
					O	P	R				
CHAIR WITH BAR LEGS W: 31.5 D: 34 H: 37 SW: 23 SD: 21 SH: 18.5 BH: 23.5 AH: 22-25	AL-1 PC	5.5	3057	3261	3508	3734	3976	4212	4454	4691	5048
	AL-1 BC	5.5	3057	3261	3508	3734	3976	4212	4454	4691	5048



CHAIR WITH SLED BASE W: 31.5 D: 34 H: 37 SW: 23 SD: 21 SH: 18.5 BH: 23.5 AH: 22-25	ALS-1 PC	5.5	2711	2915	3162	3388	3630	3866	4108	4345	4702
	ALS-1 BC	5.5	2711	2915	3162	3388	3630	3866	4108	4345	4702



ALTA | SEAT OPTIONS

	MODEL	DESCRIPTION	PRICE
CLEAN-OUT SEAT 	ALSC	Allows for easier cleaning.	No Upcharge

	MODEL	DESCRIPTION	PRICE
ISLAND SEAT / ALL-SIDE CLEAN-OUT 	ALSI	All sides clean out. Includes Stainless Steel Covers.	91 LIST



ALTA | ARM CAP OPTIONS

	MODEL	GRADE	A	B	C	D
SOLID SURFACE ARM CAPS	ACALS	Stocked Solid Surface	368 LIST/PR	400 LIST/PR	448 LIST/PR	520 LIST/PR
		Non-stocked (per color, per order)	ADD 410 NET	450 NET	490 NET	520 NET



NOTE: Arm Caps are contoured; they are not flat.

	MODEL	DESCRIPTION	PRICE
WOOD ARM CAPS	ACALM	Solid Wood. Specify finish.	346 LIST/PR



NOTE: Arm Caps are contoured; they are not flat.

Custom Wood Finish (CWF) is a one-time upcharge of 300 NET per color.

PRODUCT OPTIONS

MOISTURE BARRIER \$22 List / Yard
FIRE WALL / CA T.B. 133 \$82 List / Yard
TAMPER-RESISTANT FASTENERS \$51 List / Chair

ALTA OTTOMAN WITH SLED BASE

	MODEL	YARDS	COM	M	COL						
					O	P	R	S	T	U	W/WL
OTTOMAN WITH SLED BASE	ALOTTO	1.5	1001	1057	1124	1186	1252	1316	1382	1447	1544

W: 24 D: 24.5 H: 11.5



PRODUCT OPTIONS

MOISTURE BARRIER \$22 List / Yard
FIRE WALL / CA T.B. 133 \$82 List / Yard
TAMPER-RESISTANT FASTENERS \$51 List / Chair
WEIGHTED / THEFT DETERRENT \$305 List / 25 lb Weight



ALPINE LOUNGE COLLECTION | APRÈS



CERTIFIED
CLEAN AIR GOLD



APRÈS 8" HIGH BAR LEGS

STEEL WITH POWDER COAT (PC) OR BRUSHED CHROME (BC)

	MODEL	YARDS	COM	M	COL		P	R	S	T	U	W/WL
					O							
CHAIR W: 34 D: 30.5 H: 33 SW: 24 SD: 21 SH: 19 BH: 16 AH: 25	APB-1 PC	5.25	2946	3140	3377	3592	3823	4049	4280	4505	4847	
	APB-1 BC	5.25	2946	3140	3377	3592	3823	4049	4280	4505	4847	
SETTEE W: 58 SW: 48	APB-2 PC	8	4082	4378	4738	5066	5418	5762	6114	6458	6978	
	APB-2 BC	8	4082	4378	4738	5066	5418	5762	6114	6458	6978	
SOFA W: 82 SW: 72	APB-3 PC	10.75	5206	5604	6088	6528	7001	7464	7937	8399	9098	
	APB-3 BC	10.75	5206	5604	6088	6528	7001	7464	7937	8399	9098	

APRÈS 8" HIGH CYLINDER LEGS

	MODEL	YARDS	COM	M	COL		P	R	S	T	U	W/WL
					O							
CHAIR W: 34 D: 30.5 H: 33 SW: 24 SD: 21 SH: 19 BH: 16 AH: 25	APC-1 PC	5.25	2450	2644	2881	3096	3327	3553	3784	4009	4351	
	APC-1 BC	5.25	2450	2644	2881	3096	3327	3553	3784	4009	4351	
SETTEE W: 58 SW: 48	APC-2 PC	8	3586	3882	4242	4570	4922	5266	5618	5962	6482	
	APC-2 BC	8	3586	3882	4242	4570	4922	5266	5618	5962	6482	
SOFA W: 82 SW: 72	APC-3 PC	10.75	4710	5108	5592	6032	6505	6968	7441	7903	8602	
	APC-3 BC	10.75	4710	5108	5592	6032	6505	6968	7441	7903	8602	

APRÈS CHAISE OTTOMAN

	MODEL	YARDS	COM	M	COL		P	R	S	T	U	W/WL
					O							
BAR LEGS W: 30 D: 40 H: 18	APOTB1	4	2193	2341	2521	2685	2861	3033	3209	3381	3641	
CYLINDER LEGS	APOTC1	4	1817	1965	2145	2309	2485	2657	2833	3005	3265	



APRÈS | ARM CAP OPTIONS

SOLID SURFACE ARM CAPS

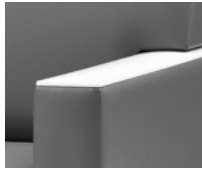

MODEL	GRADE	A	B	C	D
ACAPS	Stocked Solid Surface	404 LIST/PR	438 LIST/PR	490LIST/PR	572 LIST/PR
	Non-stocked (per color, per order)	ADD 410 NET	450 NET	490 NET	520 NET

NOTE: Arm Caps are contoured; they are not flat.

WOOD ARM CAPS



MODEL	DESCRIPTION	PRICE
ACAPM	Solid Wood. Specify finish.	346 LIST/PR

NOTE: Arm Caps are contoured; they are not flat.

Custom Wood Finish (CWF) is a one-time upcharge of 300 NET per color.

APRÈS | TABLET OPTIONS

ALL INTEGRA TABLETS HAVE A 300LB CAPACITY



Tablets available in Upholstered Arms with and without Arm Caps.

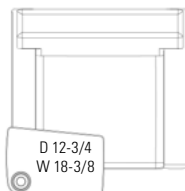
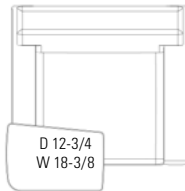

With Cup Holder Option

CHOOSE POSITION

(4)

(5)

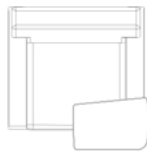
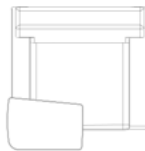

(4) - Tablet on right as seated

(5) - Tablet on left as seated

SOLID SURFACE TABLET OPTION

MODEL	GRADE	A	B	C	D
ST-(4/5)	Stocked	723 LIST	759 LIST	811 LIST	894 LIST
	Non-stocked (per color, per order)	ADD 410 NET	450 NET	490 NET	520 NET

LAMINATE OVER PLYWOOD CORE/EDGE TABLET OPTION

MODEL	GRADE	PRICE
LT-(4/5)	Stocked (Laminate tablets have a plywood edge. Specify finish.)	548 LIST
	Non-stocked (per color, per order)	ADD 50 NET

VENEER OVER PLYWOOD CORE/EDGE TABLET OPTION

MODEL	GRADE	PRICE
VT-(4/5)	Standard Wood Finish	548 LIST
	Custom Finish (one time charge per color)	ADD 300 NET

CUP HOLDER

MODEL	FINISH	PRICE
CUPIN	Brushed Aluminum	216 LIST

PRODUCT OPTIONS

MOISTURE BARRIER \$22 List / Yard
FIRE WALL / CA T.B. 133 \$82 List / Yard
TAMPER-RESISTANT FASTENERS \$51 List / Chair
WEIGHTED / THEFT DETERRENT \$305 List / 25 lb Weight
 \$610 List / 50 lb Weight



ALPINE LOUNGE COLLECTION | BRIGHTON



CERTIFIED
CLEAN AIR GOLD





COMPONENT-BASED
CONSTRUCTION

2K STATIC
CAPACITY



1K DROP
CAPACITY

BRIGHTON - CLEAN-OUT SEAT

SOLID STEEL BAR LEGS WITH POWDER COAT (PC) OR BRUSHED CHROME (BC)

	MODEL	YARDS	COM	M	COL							W/WL
					O	P	R	S	T	U		
CHAIR W: 28 D: 28 H: 34 SW: 22 SD: 19.5 SH: 18.5 BH: 17 AH: 26 	BR-1 PC	5	2951	3136	3361	3566	3786	4001	4221	4436	4761	
	BR-1 BC	5	2951	3136	3361	3566	3786	4001	4221	4436	4761	
BRIGHTON WIDE W: 32 SW: 26 	BRW-1 PC	5.5	3122	3326	3573	3799	4041	4277	4519	4756	5113	
	BRW-1 BC	5.5	3122	3326	3573	3799	4041	4277	4519	4756	5113	
SETTEE W: 50 SW: 44 	BR-2 PC	7.5	3966	4244	4581	4889	5219	5541	5871	6194	6681	
	BR-2 BC	7.5	3966	4244	4581	4889	5219	5541	5871	6194	6681	

BRIGHTON - ALL SIDES CLEAN-OUT

	MODEL	YARDS	COM	M	COL							W/WL
					O	P	R	S	T	U		
CHAIR W: 28 D: 28 H: 34 SW: 22 SD: 19.5 SH: 18.5 BH: 17 AH: 26 	BRSI-1 PC	4.75	2951	3127	3341	3535	3744	3949	4158	4362	4671	
	BRSI-1 BC	4.75	2951	3127	3341	3535	3744	3949	4158	4362	4671	
BRIGHTON WIDE W: 32 SW: 26 	BRWSI-1 PC	5.25	3122	3316	3553	3768	3999	4225	4456	4681	5023	
	BRWSI-1 BC	5.25	3122	3316	3553	3768	3999	4225	4456	4681	5023	
SETTEE W: 50 SW: 44 	BRSI-2 PC	7	3965	4224	4539	4826	5134	5435	5743	6044	6499	
	BRSI-2 BC	7	3965	4224	4539	4826	5134	5435	5743	6044	6499	

BRIGHTON | ARM CAP OPTIONS

	MODEL	GRADE	A	B	C	D
SOLID SURFACE ARM CAPS 	ACBRS	Stocked Solid Surface	250 LIST/PR	274 LIST/PR	308 LIST/PR	362 LIST/PR
		Non-stocked (per color, per order)	ADD 410 NET	450 NET	490 NET	520 NET

NOTE: Arm Caps are contoured; they are not flat.

	MODEL	DESCRIPTION	PRICE
WOOD ARM CAPS 	ACBRM	Solid Wood. Specify finish.	292 LIST/PR

NOTE: Arm Caps are contoured; they are not flat.

Custom Wood Finish (CWF) is a one-time upcharge of 300 NET per color.



Not available on Brighton Slope.



Tablets available in Upholstered Arms with and without Arm Caps.

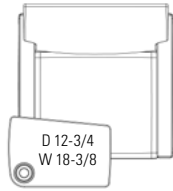
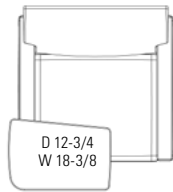

With Cup Holder Option

CHOOSE POSITION

(4)

(5)

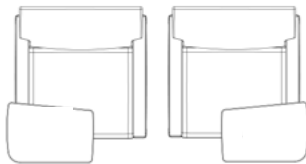

(4) - Tablet on right as seated

(5) - Tablet on left as seated

SOLID SURFACE TABLET OPTION

MODEL	GRADE		A	B	C	D
ST-(4/5)	Stocked		723 LIST	759 LIST	811 LIST	894 LIST
	Non-stocked (per color, per order)	ADD	410 NET	450 NET	490 NET	520 NET

LAMINATE OVER PLYWOOD CORE/EDGE TABLET OPTION

MODEL	GRADE		PRICE
LT-(4/5)	Stocked (Laminate tablets have a plywood edge. Specify finish.)		548 LIST
	Non-stocked (per color, per order)	ADD	50 NET

VENEER OVER PLYWOOD CORE/EDGE TABLET OPTION

MODEL	GRADE		PRICE
VT-(4/5)	Standard Wood Finish		548 LIST
	Custom Finish (one time charge per color)	ADD	300 NET

CUP HOLDER

MODEL	FINISH	PRICE
CUPIN	Brushed Aluminum	216 LIST

PRODUCT OPTIONS

- MOISTURE BARRIER \$22 List / Yard
- FIRE WALL / CA T.B. 133 \$82 List / Yard
- TAMPER-RESISTANT FASTENERS \$51 List / Chair



BRIGHTON SLOPE - CLEAN-OUT SEAT

	MODEL	YARDS	COM	M	COL							W/WL
					O	P	R	S	T	U		
CHAIR	BS-1 PC	5	2951	3136	3361	3566	3786	4001	4221	4436	4761	
W: 28 D: 28 H: 34 SW: 22 SD: 19.5 SH: 18.5 BH: 17 AH: 21-26	BS-1 BC	5	2951	3136	3361	3566	3786	4001	4221	4436	4761	
BRIGHTON SLOPE WIDE	BSW-1 PC	5.5	3122	3326	3573	3799	4041	4277	4519	4756	5113	
W: 32 SW: 26	BSW-1 BC	5.5	3122	3326	3573	3799	4041	4277	4519	4756	5113	
SETTEE	BS-2 PC	7.5	3966	4244	4581	4889	5219	5541	5871	6194	6681	
W: 50 SW: 44	BS-2 BC	7.5	3966	4244	4581	4889	5219	5541	5871	6194	6681	

BRIGHTON SLOPE - ALL SIDES CLEAN-OUT

	MODEL	YARDS	COM	M	COL							W/WL
					O	P	R	S	T	U		
CHAIR	BSSI-1 PC	4.75	2951	3127	3341	3535	3744	3949	4158	4362	4671	
W: 28 D: 28 H: 34 SW: 22 SD: 19.5 SH: 18.5 BH: 17 AH: 21-26	BSSI-1 BC	4.75	2951	3127	3341	3535	3744	3949	4158	4362	4671	
BRIGHTON SLOPE WIDE	BSWSI-1 PC	5.25	3122	3316	3553	3768	3999	4225	4456	4681	5023	
W: 32 SW: 26	BSWSI-1 BC	5.25	3122	3316	3553	3768	3999	4225	4456	4681	5023	
SETTEE	BSSI-2 PC	7	3965	4224	4539	4826	5134	5435	5743	6044	6499	
W: 50 SW: 44	BSSI-2 BC	7	3965	4224	4539	4826	5134	5435	5743	6044	6499	

BRIGHTON SLOPE | ARM CAP OPTIONS

	MODEL	GRADE	A	B	C	D
SOLID SURFACE ARM CAPS	ACBSS	Stocked Solid Surface	250 LIST/PR	274 LIST/PR	308 LIST/PR	362 LIST/PR
		Non-stocked (per color, per order)	ADD 410 NET	450 NET	490 NET	520 NET

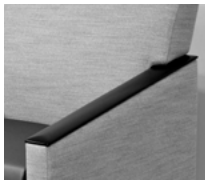

NOTE: Arm Caps are contoured; they are not flat.

	MODEL	DESCRIPTION	PRICE
WOOD ARM CAPS	ACBSM	Solid Wood. Specify finish.	292 LIST/PR

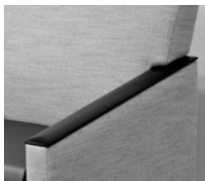

NOTE: Arm Caps are contoured; they are not flat.

Custom Wood Finish (CWF) is a one-time upcharge of 300 NET per color.

PRODUCT OPTIONS

- MOISTURE BARRIER** \$22 List / Yard
- FIRE WALL / CA T.B. 133** \$82 List / Yard
- TAMPER-RESISTANT FASTENERS** \$51 List / Chair



ALPINE FOOTSTOOL

FOOTSTOOL	MODEL	H	YARDS	COM	M	COL							W / WL
						O	P	R	S	T	U		
W: 19.5 D: 19.5	ALPFS1	11.5	1.5	470	526	593	655	721	785	851	916	1013	
	ALPFS2	18	1.5	515	571	638	700	766	830	896	961	1058	



NOTE: 11.5"H Alpine Footstool will ONLY fit under seats of Brighton Slope, Solitude Slope, and models without front panel.

RECESSED PULL HANDLE	MODEL	DESCRIPTION	PRICE
	RPH(B/G)	Specify Black (B) or Gray (G).	86 LIST



PRODUCT OPTIONS

- MOISTURE BARRIER** \$22 List / Yard
- FIRE WALL / CA T.B. 133** \$82 List / Yard
- TAMPER-RESISTANT FASTENERS** \$51 List / Chair
- WEIGHTED / THEFT DETERRENT** \$305 List / 25 lb Weight



ALPINE LOUNGE COLLECTION | SOLITUDE



CERTIFIED CLEAN AIR GOLD





COMPONENT-BASED CONSTRUCTION

2K STATIC CAPACITY



1K DROP CAPACITY

SOLITUDE - CLEAN-OUT SEAT

STEEL CYLINDER LEGS WITH POWDER COAT (PC) OR BRUSHED CHROME (BC)

			MODEL	YARDS	COM	M	COL					W/WL	
							O	P	R	S	T	U	
CHAIR		W: 28 D: 28 H: 34 SW: 22 SD: 19.5 SH: 18.5 BH: 17 AH: 26	SD-1 PC	4.5	2511	2678	2880	3065	3263	3456	3654	3848	4140
			SD-1 BC	4.5	2511	2678	2880	3065	3263	3456	3654	3848	4140
SOLITUDE WIDE		W: 32 SW: 26	SDW-1 PC	5.5	2682	2867	3092	3297	3517	3732	3952	4167	4492
			SDW-1 BC	5.5	2682	2867	3092	3297	3517	3732	3952	4167	4492
SETTEE		W: 50 SW: 44	SD-2 PC	7.5	3526	3785	4100	4387	4695	4996	5304	5605	6060
			SD-2 BC	7.5	3526	3785	4100	4387	4695	4996	5304	5605	6060

SOLITUDE - ALL SIDES CLEAN-OUT

			MODEL	YARDS	COM	M	COL					W/WL	
							O	P	R	S	T	U	
CHAIR		W: 28 D: 28 H: 34 SW: 22 SD: 19.5 SH: 18.5 BH: 17 AH: 26	SDSI-1 PC	4.25	2511	2668	2860	3034	3221	3404	3591	3773	4050
			SDSI-1 BC	4.25	2511	2668	2860	3034	3221	3404	3591	3773	4050
SOLITUDE WIDE		W: 32 SW: 26	SDWSI-1-PC	4.75	2682	2858	3072	3266	3475	3680	3889	4093	4402
			SDWSI-1 BC	4.75	2682	2858	3072	3266	3475	3680	3889	4093	4402
SETTEE		W: 50 SW: 44	SDSI-2 PC	6.5	3525	3766	4058	4325	4611	4890	5176	5456	5878
			SDSI-2 BC	6.5	3525	3766	4058	4325	4611	4890	5176	5456	5878

SOLITUDE | ARM CAP OPTIONS

		MODEL	GRADE	A	B	C	D
SOLID SURFACE ARM CAPS		ACSDS	Stocked Solid Surface	250 LIST/PR	274 LIST/PR	308 LIST/PR	362 LIST/PR
			Non-stocked (per color, per order)	ADD 410 NET	450 NET	490 NET	520 NET

NOTE: Arm Caps are contoured; they are not flat.

		MODEL	DESCRIPTION	PRICE
WOOD ARM CAPS		ACSDM	Solid Wood. Specify finish.	292 LIST/PR

NOTE: Arm Caps are contoured; they are not flat.

Custom Wood Finish (CWF) is a one-time upcharge of 300 NET per color.



Not available on Solitude Slope.

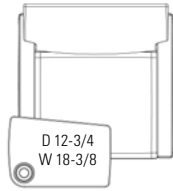
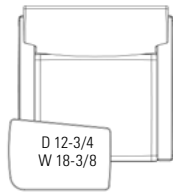

With Cup Holder Option

CHOOSE POSITION

(4)

(5)

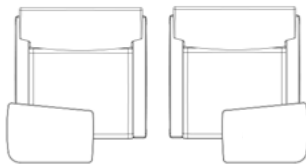

(4) - Tablet on right as seated

(5) - Tablet on left as seated

SOLID SURFACE TABLET OPTION

MODEL	GRADE		A	B	C	D
ST-(4/5)	Stocked		723 LIST	759 LIST	811 LIST	894 LIST
	Non-stocked (per color, per order)	ADD	410 NET	450 NET	490 NET	520 NET

LAMINATE OVER PLYWOOD CORE/EDGE TABLET OPTION

MODEL	GRADE		PRICE
LT-(4/5)	Stocked (Laminate tablets have a plywood edge. Specify finish.)		548 LIST
	Non-stocked (per color, per order)	ADD	50 NET

VENEER OVER PLYWOOD CORE/EDGE TABLET OPTION

MODEL	GRADE		PRICE
VT-(4/5)	Standard Wood Finish		548 LIST
	Custom Finish (one time charge per color)	ADD	300 NET

CUP HOLDER

MODEL	FINISH	PRICE
CUPIN	Brushed Aluminum	216 LIST

PRODUCT OPTIONS

MOISTURE BARRIER	\$22 List / Yard
FIRE WALL / CA T.B. 133	\$82 List / Yard
TAMPER-RESISTANT FASTENERS	\$51 List / Chair



SOLITUDE SLOPE - CLEAN-OUT SEAT

	MODEL	YARDS	COM	M	COL							W/WL
					O	P	R	S	T	U		
CHAIR	SL-1 PC	4.5	2511	2678	2880	3065	3263	3456	3654	3848	4140	
W: 28 D: 28 H: 34 SW: 22 SD: 19.5 SH: 18.5 BH: 17 AH: 21-26	SL-1 BC	4.5	2511	2678	2880	3065	3263	3456	3654	3848	4140	
SOLITUDE SLOPE WIDE	SLW-1 PC	5	2682	2867	3092	3297	3517	3732	3952	4167	4492	
W: 32 SW: 26	SLW-1 BC	5	2682	2867	3092	3297	3517	3732	3952	4167	4492	
SETTEE	SL-2 PC	7	3526	3785	4100	4387	4695	4996	5304	5605	6060	
W: 50 SW: 44	SL-2 BC	7	3526	3785	4100	4387	4695	4996	5304	5605	6060	

SOLITUDE SLOPE - ALL SIDES CLEAN-OUT

	MODEL	YARDS	COM	M	COL							W/WL
					O	P	R	S	T	U		
CHAIR	SLSI-1 PC	4.25	2511	2668	2860	3034	3221	3404	3591	3773	4050	
W: 28 D: 28 H: 34 SW: 22 SD: 19.5 SH: 18.5 BH: 17 AH: 21-26	SLSI-1 BC	4.25	2511	2668	2860	3034	3221	3404	3591	3773	4050	
SOLITUDE SLOPE WIDE	SDWSI-1 PC	4.75	2682	2858	3072	3266	3475	3680	3889	4093	4402	
W: 32 SW: 26	SDWSI-1 BC	4.75	2682	2858	3072	3266	3475	3680	3889	4093	4402	
SETTEE	SDSI-2 PC	6.5	3525	3766	4058	4325	4611	4890	5176	5456	5878	
W: 50 SW: 44	SDSI-2 BC	6.5	3525	3766	4058	4325	4611	4890	5176	5456	5878	

SOLITUDE SLOPE | ARM CAP OPTIONS

	MODEL	GRADE	A	B	C	D
SOLID SURFACE ARM CAPS	ACSLS	Stocked Solid Surface	250 LIST/PR	274 LIST/PR	308 LIST/PR	362 LIST/PR
		Non-stocked (per color, per order)	ADD 410 NET	450 NET	490 NET	520 NET

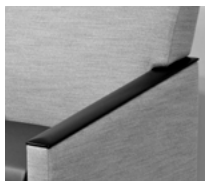

NOTE: Arm Caps are contoured; they are not flat.

	MODEL	DESCRIPTION	PRICE
WOOD ARM CAPS	ACSLM	Solid Wood. Specify finish.	292 LIST/PR

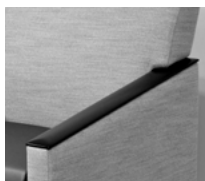

NOTE: Arm Caps are contoured; they are not flat.

Custom Wood Finish (CWF) is a one-time upcharge of 300 NET per color.

PRODUCT OPTIONS

MOISTURE BARRIER \$22 List / Yard
FIRE WALL / CA T.B. 133 \$82 List / Yard
TAMPER-RESISTANT FASTENERS \$51 List / Chair



ALPINE LOUNGE COLLECTION | SUMMIT





CERTIFIED
CLEAN AIR GOLD



SUMMIT SWIVEL CHAIRS

CLEAN-OUT SEAT DESIGN

	MODEL	YARDS	COM	M	COL O	P	R	S	T	U	W/WL
360° SWIVEL WITH SELF-RETURN BASE STATIC BASE W: 28 D: 28 H: 30.5 SW: 21 SD: 20.5 SH: 17.5 BH: 16 AH: 22	 SMB3	5	2877	3062	3287	3492	3712	3927	4147	4362	4687
	SMBST	5	2749	2934	3159	3364	3584	3799	4019	4234	4559
360° SWIVEL WITH SELF-RETURN BASE (XL) STATIC BASE (XL) W: 32 D: 28 H: 30.5 SW: 25 SD: 20.5 SH: 17.5 BH: 16 AH: 22	 SMXLB3	5.5	3288	3492	3739	3965	4207	4443	4685	4922	5279
	SMXLBST	5.5	3162	3366	3613	3839	4081	4317	4559	4796	5153

SUMMIT WITH CYLINDER LEGS

	MODEL	YARDS	COM	M	COL O	P	R	S	T	U	W/WL
CYLINDER LEGS W: 28 D: 28 H: 30.5 SW: 21 SD: 20.5 SH: 17.5 BH: 16 AH: 22	 SML	5	2294	2479	2704	2909	3129	3344	3564	3779	4104
	SMXLL	5.5	2513	2717	2964	3190	3432	3668	3910	4147	4504

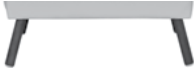

NOTE: Cylinder Legs are available in Steel with Powder Coat or Brushed Chrome finish and in Solid Wood.

SUMMIT WITH CYLINDER LEGS | LEG OPTIONS

	MODEL	DESCRIPTION	PRICE
STEEL CYLINDER LEGS WITH POWDER COAT FINISH 	4SMC(_)	Powder coat color must be specified	No Upcharge
	4SMC		No Upcharge
STEEL CYLINDER LEGS WITH BRUSHED CHROME FINISH 	4SMC		No Upcharge
	4SMCW	Standard Wood Finish	No Upcharge



SUMMIT WITH CASTERS

			MODEL	YARDS	COM	M	COL					W/WL	
							O	P	R	S	T	U	
2" CASTERS			SMC	5	2379	2564	2789	2994	3214	3429	3649	3864	4189
W: 28	D: 28	H: 30.5	NOTE: Set of 4 Non-Locking Casters.										
SW: 21	SD: 20.5	SH: 17.5											
BH: 16	AH: 22												
2" CASTERS (XL)			SMXLC	5.5	2642	2846	3093	3319	3561	3797	4039	4276	4633
W: 32	D: 28	H: 30.5	NOTE: Set of 4 Non-Locking Casters.										
SH: 25	SD: 20.5	SH: 17.5											
BH: 16	AH: 22												

SUMMIT | FEATURE



Clean-Out Seat Design

SUMMIT | ARM CAP OPTIONS

MODEL	GRADE	A	B	C	D	
SOLID SURFACE ARM CAPS	ACSMS	Stocked Solid Surface	342 LIST/PR	354 LIST/PR	368 LIST/PR	394 LIST/PR
		Non-stocked (per color, per order)	ADD 410 NET	450 NET	490 NET	520 NET



NOTE: Arm Caps are contoured; they are not flat and are not field replaceable.



MODEL	DESCRIPTION	PRICE
WOOD ARM CAPS	ACSMM	Solid Wood. Specify finish.
		246 LIST/PR



NOTE: Arm Caps are contoured; they are not flat and are not field replaceable.
Custom Wood Finish (CWF) is a one-time upcharge of 300 NET per color.



SUMMIT OTTOMANS

		MODEL	YARDS	COM	M	COL						W/WL
						O	P	R	S	T	U	
360° SWIVEL BASE		SMOT19B	1.25	1406	1452	1509	1560	1615	1669	1724	1777	1859
STATIC BASE		SMOT19S	1.25	1313	1359	1416	1467	1522	1576	1631	1684	1766
H: 18 DIA: 19												
CYLINDER LEGS		SMOT19L	1.25	898	944	1001	1052	1107	1161	1216	1269	1351
H: 18 DIA: 19												
CASTERS		SMOT19C	1.25	890	936	993	1044	1099	1153	1208	1261	1343
H: 18 DIA: 25												

NOTE: Cylinder Legs are available in Steel with Powder Coat or Brushed Chrome finish and in Solid Wood.

PRODUCT OPTIONS

- MOISTURE BARRIER** \$22 List / Yard
- FIRE WALL / CA T.B. 133** \$82 List / Yard
- TAMPER-RESISTANT FASTENERS** \$51 List / Chair
- PERMA-COAT WOOD LEG PROTECTOR** \$35 List / Leg







ALPINE LOUNGE COLLECTION | BENCHES



ALPINE - SOLID STEEL BAR LEGS

SOLID STEEL WITH POWDER COAT (PC) OR BRUSHED CHROME (BC)

		MODEL	PANELS	YARDS	COM	M	COL						U/UL	W/WL
							O	P	R	S	T			
36 BENCH		ALPN-7-30-UU	ALL UPH	2.25	1813	1896	1998	2090	2189	2286	2385	2481	2628	
		ALPN-7-30-UW	UPH SIDES	1.75	1945	2010	2089	2160	2237	2313	2390	2465	2579	
		ALPN-7-30-WU	UPH FR/BK	1.75	1813	1878	1957	2028	2105	2181	2258	2333	2447	
		ALPN-7-30-WW	ALL WOOD	1.25	1945	1991	2048	2099	2154	2208	2263	2316	2398	
48 BENCH		ALPN-7-42-UU	ALL UPH	2.75	1925	2027	2151	2263	2384	2503	2624	2742	2921	
		ALPN-7-42-UW	UPH SIDES	2.25	2065	2148	2250	2342	2441	2538	2637	2733	2880	
		ALPN-7-42-WU	UPH FR/BK	2.25	1925	2008	2110	2202	2301	2398	2497	2593	2740	
		ALPN-7-42-WW	ALL WOOD	1.75	2065	2130	2209	2280	2357	2433	2510	2585	2699	
60 BENCH		ALPN-7-54-UU	ALL UPH	3	2056	2167	2302	2425	2557	2686	2818	2947	3142	
		ALPN-7-54-UW	UPH SIDES	2.5	2215	2308	2420	2523	2633	2740	2850	2958	3120	
		ALPN-7-54-WU	UPH FR/BK	2.5	2056	2149	2261	2364	2474	2581	2691	2799	2961	
		ALPN-7-54-WW	ALL WOOD	2	2215	2289	2379	2461	2549	2635	2723	2809	2939	
72 BENCH		ALPN-7-66-UU	ALL UPH	4	2160	2308	2488	2652	2828	3000	3176	3348	3608	
		ALPN-7-66-UW	UPH SIDES	3.25	2338	2458	2605	2738	2881	3021	3164	3303	3515	
		ALPN-7-66-WU	UPH FR/BK	3.5	2160	2290	2447	2591	2745	2895	3049	3200	3427	
		ALPN-7-66-WW	ALL WOOD	2.75	2338	2440	2564	2676	2797	2916	3037	3155	3334	



ALPN-7-___-UU
ALL UPHOLSTERED



ALPN-7-___-UW
UPHOLSTERED SIDES



ALPN-7-___-WU
UPHOLSTERED FRONT/BACK



ALPN-7-___-WW
ALL WOOD

PRODUCT OPTIONS

- MOISTURE BARRIER** \$22 List / Yard
- FIRE WALL / CA T.B. 133** \$82 List / Yard
- TAMPER-RESISTANT FASTENERS** \$51 List / Chair
- WEIGHTED / THEFT DETERRENT** \$305 List / 25 lb Weight
\$610 List / 50 lb Weight



ALPINE LOUNGE COLLECTION | OTTOMANS



CERTIFIED
CLEAN AIR GOLD

Healthier
Hospitals

COMPONENT-BASED
CONSTRUCTION

2K STATIC
CAPACITY

1K DROP
CAPACITY

ALPINE OTTOMANS - ROUND

STEEL CYLINDER LEGS OR BAR LEGS WITH POWDER COAT (PC) OR BRUSHED CHROME (BC)

		MODEL	LEG STYLE	YARDS	COM	M	COL O	P	R	S	T	U/UL	W/WL
22 ROUND DIA: 22 H: 18	(1) 5"H legs (2) 8"H legs	AOC2C(1/2)	Cylinder Legs	1.5	1061	1117	1184	1246	1312	1376	1442	1507	1604
		AOC2B(1/2)	Bar Legs	1.5	1437	1493	1560	1622	1688	1752	1818	1883	1980
30 ROUND DIA: 30 H: 18		AOC3C(1/2)	Cylinder Legs	2.5	1314	1407	1519	1622	1732	1839	1949	2057	2219
		AOC3B(1/2)	Bar Legs	2.5	1690	1783	1895	1998	2108	2215	2325	2433	2595
36 ROUND DIA: 36 H: 18		AOC4C(1/2)	Cylinder Legs	3	1521	1632	1767	1890	2022	2151	2283	2412	2607
		AOC4B(1/2)	Bar Legs	3	1897	2008	2143	2266	2398	2527	2659	2788	2983
42 ROUND DIA: 42 H: 18 NOTE: 5 legs for stability		AOC5C(1/2)	Cylinder Legs	3.5	1995	2125	2282	2426	2580	2730	2884	3035	3262
		AOC5B(1/2)	Bar Legs	3.5	2465	2595	2752	2896	3050	3200	3354	3505	3732
48 ROUND DIA: 48 H: 18 NOTE: 6 legs for stability		AOC6C(1/2)	Cylinder Legs	4	2306	2454	2634	2798	2974	3146	3322	3494	3754
		AOC6B(1/2)	Bar Legs	4	2870	3018	3198	3362	3538	3710	3886	4058	4318

NOTE: Must choose 5"H Legs (1) or 8"H Legs (2)

ALPINE OTTOMANS - SQUARE AND RECTANGLE

		MODEL	LEG STYLE	YARDS	COM	M	COL O	P	R	S	T	U/UL	W/WL
22 SQUARE W: 22 D: 22 H: 18	(1) 5"H legs (2) 8"H legs	AOR2C(1/2)	Cylinder Legs	1.5	993	1049	1116	1178	1244	1308	1374	1439	1536
		AOR2B(1/2)	Bar Legs	1.5	1369	1425	1492	1554	1620	1684	1750	1815	1912
30 x 22 RECTANGLE W: 30 D: 22 H: 18		AOR3C(1/2)	Cylinder Legs	1.75	1169	1234	1313	1384	1461	1537	1614	1689	1803
		AOR3B(1/2)	Bar Legs	1.75	1545	1610	1689	1760	1837	1913	1990	2065	2179
48 x 22 RECTANGLE W: 48 D: 22 H: 18		AOR4C(1/2)	Cylinder Legs	2	1337	1411	1501	1583	1671	1757	1845	1931	2061
		AOR4B(1/2)	Bar Legs	2	1713	1787	1877	1959	2047	2133	2221	2307	2437
60 x 22 RECTANGLE W: 60 D: 22 H: 18		AOR5C(1/2)	Cylinder Legs	3	1583	1694	1829	1952	2084	2213	2345	2474	2669
		AOR5B(1/2)	Bar Legs	3	1959	2070	2205	2328	2460	2589	2721	2850	3045
72 x 22 RECTANGLE W: 72 D: 22 H: 18		AOR6C(1/2)	Cylinder Legs	3.25	1759	1879	2026	2159	2302	2442	2585	2724	2936
		AOR6B(1/2)	Bar Legs	3.25	2135	2255	2402	2535	2678	2818	2961	3100	3312

NOTE: Must choose 5"H Legs (1) or 8"H Legs (2)



ALPINE OTTOMANS - OVAL

						COL							
		MODEL	LEG STYLE	YARDS	COM	M	O	P	R	S	T	U/UL	W/WL
30 x 24 OVAL		AOV2C(1/2)	Cylinder Legs	1.75	1181	1246	1325	1396	1473	1549	1626	1701	1815
		AOV2B(1/2)	Bar Legs	1.75	1557	1622	1701	1772	1849	1925	2002	2077	2191
36 x 24 OVAL		AOV3C(1/2)	Cylinder Legs	2	1272	1346	1436	1518	1606	1692	1780	1866	1996
		AOV3B(1/2)	Bar Legs	2	1648	1722	1812	1894	1982	2068	2156	2242	2372
42x 24 OVAL		AOV4C(1/2)	Cylinder Legs	2.5	1470	1563	1675	1778	1888	1995	2105	2213	2375
		AOV4B(1/2)	Bar Legs	2.5	1846	1939	2051	2154	2264	2371	2481	2589	2751
48 x 24 OVAL		AOV5C(1/2)	Cylinder Legs	3	1592	1703	1838	1961	2093	2222	2354	2483	2678
		AOV5B(1/2)	Bar Legs	3	1968	2079	2214	2337	2469	2598	2730	2859	3054

NOTE: Must choose 5"H Legs (1) or 8"H Legs (2)

PRODUCT OPTIONS

- MOISTURE BARRIER** \$22 List / Yard
- FIRE WALL / CA T.B. 133** \$82 List / Yard
- TAMPER-RESISTANT FASTENERS** \$51 List / Chair



ALPINE LOUNGE COLLECTION | TABLES

LAMINATE AND SOLID SURFACE TOPS COMPLIANT WITH



CERTIFIED CLEAN AIR GOLD



ALPINE TABLES - ROUND

STEEL CYLINDER LEGS OR BAR LEGS WITH POWDER COAT (PC) OR BRUSHED CHROME (BC)

18 ROUND x 18H

DIA: 18 H: 18



MODEL	TOP (1.75"-THICK)		CYLINDER LEGS (CL)	BAR LEGS (BL)
ALPTB-18D18(_)	Veneer*		1217	1565
ALPTB-L-18D18(_)	Stocked Laminate		1272	1620
	Non-stocked Laminate (per color, per order)	ADD	50 NET	50 NET

NOTE: Custom Wood Finish (CWF) is a one-time upcharge of 300 NET per color.

MODEL	SOLID SURFACE TOP (1.5"-THICK)	CYLINDER LEGS			
		A	B	C	D
ALPTB-S-18D18CL	Stocked	1638 LIST	1638 LIST	2001 LIST	2334 LIST
	Non-stocked (per color, per order)	ADD 410 NET	450 NET	490 NET	520 NET

MODEL	SOLID SURFACE TOP (1.5"-THICK)	BAR LEGS			
		A	B	C	D
ALPTB-S-18D18BL	Stocked	1986 LIST	1986 LIST	2349 LIST	2682 LIST
	Non-stocked (per color, per order)	ADD 410 NET	450 NET	490 NET	520 NET

*Veneer Tops are not compliant with Clean Air Gold Certification or Healthier Hospitals Initiative.

18 ROUND x 21H

DIA: 18 H: 21



MODEL	TOP (1.75"-THICK)		CYLINDER LEGS (CL)	BAR LEGS (BL)
ALPTB-18D21(_)	Veneer*		1221	1593
ALPTB-L-18D21(_)	Stocked Laminate		1276	1648
	Non-stocked Laminate (per color, per order)	ADD	50 NET	50 NET

NOTE: Custom Wood Finish (CWF) is a one-time upcharge of 300 NET per color.

MODEL	SOLID SURFACE TOP (1.5"-THICK)	CYLINDER LEGS			
		A	B	C	D
ALPTB-S-18D21CL	Stocked	1642 LIST	1642 LIST	2005 LIST	2338 LIST
	Non-stocked (per color, per order)	ADD 410 NET	450 NET	490 NET	520 NET

MODEL	SOLID SURFACE TOP (1.5"-THICK)	BAR LEGS			
		A	B	C	D
ALPTB-S-18D21BL	Stocked	2014 LIST	2014 LIST	2377 LIST	2710 LIST
	Non-stocked (per color, per order)	ADD 410 NET	450 NET	490 NET	520 NET

*Veneer Tops are not compliant with Clean Air Gold Certification or Healthier Hospitals Initiative.

18 ROUND x 24H

DIA: 18 H: 24



MODEL	TOP (1.75"-THICK)		CYLINDER LEGS (CL)	BAR LEGS (BL)
ALPTB-18D24(_)	Veneer*		1233	1617
ALPTB-L-18D24(_)	Stocked Laminate		1288	1672
	Non-stocked Laminate (per color, per order)	ADD	50 NET	50 NET

NOTE: Custom Wood Finish (CWF) is a one-time upcharge of 300 NET per color.

MODEL	SOLID SURFACE TOP (1.5"-THICK)	CYLINDER LEGS			
		A	B	C	D
ALPTB-S-18D24CL	Stocked	1654 LIST	1654 LIST	2017 LIST	2350 LIST
	Non-stocked (per color, per order)	ADD 410 NET	450 NET	490 NET	520 NET

MODEL	SOLID SURFACE TOP (1.5"-THICK)	BAR LEGS			
		A	B	C	D
ALPTB-S-18D24BL	Stocked	2038 LIST	2038 LIST	2401 LIST	2734 LIST
	Non-stocked (per color, per order)	ADD 410 NET	450 NET	490 NET	520 NET

*Veneer Tops are not compliant with Clean Air Gold Certification or Healthier Hospitals Initiative.



ALPINE TABLES - ROUND

24 ROUND x 18H

DIA: 24 H: 18



MODEL	TOP (1.75"-THICK)		CYLINDER LEGS (CL)	BAR LEGS (BL)
ALPTB-24D18(_)	Veneer*		1396	1744
ALPTB-L-24D18(_)	Stocked Laminate		1465	1813
	Non-stocked Laminate (per color, per order)	ADD	50 NET	50 NET

NOTE: Custom Wood Finish (CWF) is a one-time upcharge of 300 NET per color.

MODEL	SOLID SURFACE TOP(1.5"-THICK)		CYLINDER LEGS			
			A	B	C	D
ALPTB-S-24D18CL	Stocked		2195 LIST	2195 LIST	2738 LIST	3240 LIST
	Non-stocked (per color, per order)	ADD	410 NET	450 NET	490 NET	520 NET

MODEL	SOLID SURFACE TOP(1.5"-THICK)		BAR LEGS			
			A	B	C	D
ALPTB-S-24D18BL	Stocked		2543 LIST	2543 LIST	3086 LIST	3588 LIST
	Non-stocked (per color, per order)	ADD	410 NET	450 NET	490 NET	520 NET

*Veneer Tops are not compliant with Clean Air Gold Certification or Healthier Hospitals Initiative.

24 ROUND x 21H

DIA: 24 H: 21



MODEL	TOP (1.75"-THICK)		CYLINDER LEGS (CL)	BAR LEGS (BL)
ALPTB-24D21(_)	Veneer*		1400	1772
ALPTB-L-24D21(_)	Stocked Laminate		1469	1841
	Non-stocked Laminate (per color, per order)	ADD	50 NET	50 NET

NOTE: Custom Wood Finish (CWF) is a one-time upcharge of 300 NET per color.

MODEL	SOLID SURFACE TOP (1.5"-THICK)		CYLINDER LEGS			
			A	B	C	D
ALPTB-S-24D21CL	Stocked		2199 LIST	2199 LIST	2742 LIST	3244 LIST
	Non-stocked (per color, per order)	ADD	410 NET	450 NET	490 NET	520 NET

MODEL	SOLID SURFACE TOP (1.5"-THICK)		BAR LEGS			
			A	B	C	D
ALPTB-S-24D21BL	Stocked		2571 LIST	2571 LIST	3114 LIST	3616 LIST
	Non-stocked (per color, per order)	ADD	410 NET	450 NET	490 NET	520 NET

*Veneer Tops are not compliant with Clean Air Gold Certification or Healthier Hospitals Initiative.

24 ROUND x 24H

DIA: 24 H: 24



MODEL	TOP (1.75"-THICK)		CYLINDER LEGS (CL)	BAR LEGS (BL)
ALPTB-24D24(_)	Veneer*		1412	1796
ALPTB-L-24D24(_)	Stocked Laminate		1481	1865
	Non-stocked Laminate (per color, per order)	ADD	50 NET	50 NET

NOTE: Custom Wood Finish (CWF) is a one-time upcharge of 300 NET per color.

MODEL	SOLID SURFACE TOP (1.5"-THICK)		CYLINDER LEGS			
			A	B	C	D
ALPTB-S-24D24CL	Stocked		2211 LIST	2211 LIST	2754 LIST	3256 LIST
	Non-stocked (per color, per order)	ADD	410 NET	450 NET	490 NET	520 NET

MODEL	SOLID SURFACE TOP (1.5"-THICK)		BAR LEGS			
			A	B	C	D
ALPTB-S-24D24BL	Stocked		2595 LIST	2595 LIST	3138 LIST	3640 LIST
	Non-stocked (per color, per order)	ADD	410 NET	450 NET	490 NET	520 NET

*Veneer Tops are not compliant with Clean Air Gold Certification or Healthier Hospitals Initiative.



ALPINE TABLES - ROUND

30 ROUND x 18H

DIA: 30 H: 18



MODEL	TOP (1.75"-THICK)		CYLINDER LEGS (CL)	BAR LEGS (BL)
ALPTB-30D18(_)	Veneer*		1622	1970
ALPTB-L-30D18(_)	Stocked Laminate		1709	2057
	Non-stocked Laminate (per color, per order)	ADD	50 NET	50 NET

NOTE: Custom Wood Finish (CWF) is a one-time upcharge of 300 NET per color.

MODEL	SOLID SURFACE TOP (1.5"-THICK)	CYLINDER LEGS			
		A	B	C	D
ALPTB-S-30D18CL	Stocked	2753 LIST	2753 LIST	3478 LIST	4147 LIST
	Non-stocked (per color, per order)	ADD 410 NET	450 NET	490 NET	520 NET

MODEL	SOLID SURFACE TOP (1.5"-THICK)	BAR LEGS			
		A	B	C	D
ALPTB-S-30D18BL	Stocked	3101 LIST	3101 LIST	3826 LIST	4495 LIST
	Non-stocked (per color, per order)	ADD 410 NET	150 NET	490 NET	520 NET

*Veneer Tops are not compliant with Clean Air Gold Certification or Healthier Hospitals Initiative.

30 ROUND x 21H

DIA: 30 H: 21



MODEL	TOP (1.75"-THICK)		CYLINDER LEGS (CL)	BAR LEGS (BL)
ALPTB-30D21(_)	Veneer*		1626	1998
ALPTB-L-30D21(_)	Stocked Laminate		1713	2085
	Non-stocked Laminate (per color, per order)	ADD	50 NET	50 NET

NOTE: Custom Wood Finish (CWF) is a one-time upcharge of 300 NET per color.

MODEL	SOLID SURFACE TOP (1.5"-THICK)	CYLINDER LEGS			
		A	B	C	D
ALPTB-S-30D21CL	Stocked	2757 LIST	2757 LIST	3482 LIST	4151 LIST
	Non-stocked (per color, per order)	ADD 410 NET	150 NET	490 NET	520 NET

MODEL	SOLID SURFACE TOP (1.5"-THICK)	BAR LEGS			
		A	B	C	D
ALPTB-S-30D21BL	Stocked	3129 LIST	3129 LIST	3854 LIST	4523 LIST
	Non-stocked (per color, per order)	ADD 410 NET	150 NET	490 NET	520 NET

*Veneer Tops are not compliant with Clean Air Gold Certification or Healthier Hospitals Initiative.

30 ROUND x 24H

DIA: 30 H: 24



MODEL	TOP (1.75"-THICK)		CYLINDER LEGS (CL)	BAR LEGS (BL)
ALPTB-30D24(_)	Veneer*		1638	2022
ALPTB-L-30D24(_)	Stocked Laminate		1725	2109
	Non-stocked Laminate (per color, per order)	ADD	50 NET	50 NET

NOTE: Custom Wood Finish (CWF) is a one-time upcharge of 300 NET per color.

MODEL	SOLID SURFACE TOP (1.5"-THICK)	CYLINDER LEGS			
		A	B	C	D
ALPTB-S-30D24CL	Stocked	2769 LIST	2769 LIST	3494 LIST	4163 LIST
	Non-stocked (per color, per order)	ADD 410 NET	150 NET	490 NET	520 NET

MODEL	SOLID SURFACE TOP (1.5"-THICK)	BAR LEGS			
		A	B	C	D
ALPTB-S-30D24BL	Stocked	3153 LIST	3153 LIST	3878 LIST	4547 LIST
	Non-stocked (per color, per order)	ADD 410 NET	450 NET	490 NET	520 NET

*Veneer Tops are not compliant with Clean Air Gold Certification or Healthier Hospitals Initiative.



ALPINE TABLES - ROUND

36 ROUND x 18H

DIA: 36 H: 18



MODEL	TOP (1.75"-THICK)		CYLINDER LEGS (CL)	BAR LEGS (BL)
ALPTB-36D18()	Veneer*		1906	2254
ALPTB-L-36D18()	Stocked Laminate		2016	2364
	Non-stocked Laminate (per color, per order)	ADD	50 NET	50 NET

NOTE: Custom Wood Finish (CWF) is a one-time upcharge of 300 NET per color.

MODEL	SOLID SURFACE TOP (1.5"-THICK)	CYLINDER LEGS			
		A	B	C	D
ALPTB-S-36D18CL	Stocked	3867 LIST	3867 LIST	4953 LIST	5957 LIST
	Non-stocked (per color, per order)	ADD 410 NET	450 NET	490 NET	520 NET

MODEL	SOLID SURFACE TOP (1.5"-THICK)	BAR LEGS			
		A	B	C	D
ALPTB-S-36D18BL	Stocked	4215 LIST	4215 LIST	5301 LIST	6305 LIST
	Non-stocked (per color, per order)	ADD 410 NET	450 NET	490 NET	520 NET

*Veneer Tops are not compliant with Clean Air Gold Certification or Healthier Hospitals Initiative.

36 ROUND x 29H

DIA: 36 H: 29



MODEL	TOP (1.75"-THICK)		CYLINDER LEGS (CL)	BAR LEGS (BL)
ALPTB-36D29()	Veneer*		2034	2486
ALPTB-L-36D29()	Stocked Laminate		2144	2596
	Non-stocked Laminate (per color, per order)	ADD	50 NET	50 NET

NOTE: Custom Wood Finish (CWF) is a one-time upcharge of 300 NET per color.

MODEL	SOLID SURFACE TOP (1.5"-THICK)	CYLINDER LEGS			
		A	B	C	D
ALPTB-S-36D29CL	Stocked	3995 LIST	3995 LIST	5081 LIST	6085 LIST
	Non-stocked (per color, per order)	ADD 410 NET	450 NET	490 NET	520 NET

MODEL	SOLID SURFACE TOP (1.5"-THICK)	BAR LEGS			
		A	B	C	D
ALPTB-S-36D29BL	Stocked	4447 LIST	4447 LIST	5533 LIST	6537 LIST
	Non-stocked (per color, per order)	ADD 410 NET	450 NET	490 NET	520 NET

*Veneer Tops are not compliant with Clean Air Gold Certification or Healthier Hospitals Initiative.



ALPINE TABLES - OVAL

48 x 22 OVAL

W: 48 D: 22
H: 18



MODEL	TOP (1.75"-THICK)		CYLINDER LEGS (CL)	BAR LEGS (BL)
ALPTB-4822OV18(_)	Veneer*		1749	2097
ALPTB-L-4822OV18(_)	Stocked Laminate		1846	2194
	Non-stocked Laminate (per color, per order)	ADD	50 NET	50 NET

NOTE: Custom Wood Finish (CWF) is a one-time upcharge of 300 NET per color.

MODEL	SOLID SURFACE TOP (1.5"-THICK)	CYLINDER LEGS			
		A	B	C	D
ALPTB-S-4822OV18CL	Stocked	3309 LIST	3309 LIST	4216 LIST	5052 LIST
	Non-stocked (per color, per order)	ADD 410 NET	450 NET	490 NET	520 NET

MODEL	SOLID SURFACE TOP (1.5"-THICK)	BAR LEGS			
		A	B	C	D
ALPTB-S-4822OV18BL	Stocked	3657 LIST	3452 LIST	4564LIST	5400 LIST
	Non-stocked (per color, per order)	ADD 410 NET	450 NET	490 NET	520 NET

*Veneer Tops are not compliant with Clean Air Gold Certification or Healthier Hospitals Initiative.

54 x 16 HALF OVAL

W: 54 D: 16
H: 29



MODEL	TOP (1.75"-THICK)		CYLINDER LEGS (CL)	BAR LEGS (BL)
ALPTB-5416H029(_)	Veneer*		1631	1967
ALPTB-L-5416H029(_)	Stocked Laminate		1722	2060
	Non-stocked Laminate (per color, per order)	ADD	50 NET	50 NET

NOTE: Custom Wood Finish (CWF) is a one-time upcharge of 300 NET per color.

MODEL	SOLID SURFACE TOP (1.5"-THICK)	CYLINDER LEGS			
		A	B	C	D
ALPTB-S-5416H029CL	Stocked	2716 LIST	2716 LIST	3441 LIST	4110 LIST
	Non-stocked (per color, per order)	ADD 410 NET	450 NET	490 NET	520 NET

MODEL	SOLID SURFACE TOP (1.5"-THICK)	BAR LEGS			
		A	B	C	D
ALPTB-S-5416H029BL	Stocked	3052 LIST	3052 LIST	3777 LIST	4446 LIST
	Non-stocked (per color, per order)	ADD 410 NET	450 NET	490 NET	520 NET

*Veneer Tops are not compliant with Clean Air Gold Certification or Healthier Hospitals Initiative.



ALPINE TABLES - SQUARE

18 SQUARE x 18H

W: 18 D: 18 H: 18



MODEL	TOP (1.75"-THICK)		CYLINDER LEGS (CL)	BAR LEGS (BL)
ALPTB-181818(_)	Veneer*		1132	1480
ALPTB-L-181818(_)	Stocked Laminate		1180	1528
	Non-stocked Laminate (per color, per order)	ADD	50 NET	50 NET

NOTE: Custom Wood Finish (CWF) is a one-time upcharge of 300 NET per color.

MODEL	SOLID SURFACE TOP (1.5"-THICK)	CYLINDER LEGS			
		A	B	C	D
ALPTB-S-181818CL	Stocked	1360 LIST	1360 LIST	1704 LIST	1955LIST
	Non-stocked (per color, per order)	ADD 410 NET	450 NET	490 NET	520 NET

MODEL	SOLID SURFACE TOP (1.5"-THICK)	BAR LEGS			
		A	B	C	D
ALPTB-S-181818BL	Stocked	1708 LIST	1708 LIST	2052 LIST	2303 LIST
	Non-stocked (per color, per order)	ADD 410 NET	450 NET	490 NET	520 NET

*Veneer Tops are not compliant with Clean Air Gold Certification or Healthier Hospitals Initiative.

18 SQUARE x 21H

W: 18 D: 18 D: 21



MODEL	TOP (1.75"-THICK)		CYLINDER LEGS (CL)	BAR LEGS (BL)
ALPTB-181821(_)	Veneer*		1136	1508
ALPTB-L-181821(_)	Stocked Laminate		1184	1556
	Non-stocked Laminate (per color, per order)	ADD	50 NET	50 NET

NOTE: Custom Wood Finish (CWF) is a one-time upcharge of 300 NET per color.

MODEL	SOLID SURFACE TOP (1.5"-THICK)	CYLINDER LEGS			
		A	B	C	D
ALPTB-S-181821CL	Stocked	1364 LIST	1364 LIST	1708 LIST	1959 LIST
	Non-stocked (per color, per order)	ADD 410 NET	450 NET	490 NET	520 NET

MODEL	SOLID SURFACE TOP (1.5"-THICK)	BAR LEGS			
		A	B	C	D
ALPTB-S-181821BL	Stocked	1736 LIST	1736 LIST	2080 LIST	2331 LIST
	Non-stocked (per color, per order)	ADD 410 NET	450 NET	490 NET	520 NET

*Veneer Tops are not compliant with Clean Air Gold Certification or Healthier Hospitals Initiative.

18 SQUARE x 24H

W: 18 D: 18 H: 24



MODEL	TOP (1.75"-THICK)		CYLINDER LEGS (CL)	BAR LEGS (BL)
ALPTB-181824(_)	Veneer*		1148	1532
ALPTB-L-181824(_)	Stocked Laminate		1196	1580
	Non-stocked Laminate (per color, per order)	ADD	50 NET	50 NET

NOTE: Custom Wood Finish (CWF) is a one-time upcharge of 300 NET per color.

MODEL	SOLID SURFACE TOP (1.5"-THICK)	CYLINDER LEGS			
		A	B	C	D
ALPTB-S-181824CL	Stocked	1376 LIST	1376 LIST	1720 LIST	1971 LIST
	Non-stocked (per color, per order)	ADD 410 NET	450 NET	490 NET	520 NET

MODEL	SOLID SURFACE TOP (1.5"-THICK)	BAR LEGS			
		A	B	C	D
ALPTB-S-181824BL	Stocked	1760 LIST	1760 LIST	2104 LIST	2355 LIST
	Non-stocked (per color, per order)	ADD 410 NET	450 NET	490 NET	520 NET

*Veneer Tops are not compliant with Clean Air Gold Certification or Healthier Hospitals Initiative.



ALPINE TABLES - SQUARE

21 SQUARE x 18H

W: 21 D: 21 H: 18



MODEL	TOP (1.75"-THICK)		CYLINDER LEGS (CL)	BAR LEGS (BL)
ALPTB-212118(_)	Veneer*		1201	1549
ALPTB-L-212118(_)	Stocked Laminate		1255	1603
	Non-stocked Laminate (per color, per order)	ADD	50 NET	50 NET

NOTE: Custom Wood Finish (CWF) is a one-time upcharge of 300 NET per color.

MODEL	SOLID SURFACE TOP (1.5"-THICK)		CYLINDER LEGS			
			A	B	C	D
ALPTB-S-212118CL	Stocked		1638 LIST	1638 LIST	2001 LIST	2334 LIST
	Non-stocked (per color, per order)	ADD	410 NET	450 NET	490 NET	520 NET

MODEL	SOLID SURFACE TOP (1.5"-THICK)		BAR LEGS			
			A	B	C	D
ALPTB-S-212118BL	Stocked		1986 LIST	1986 LIST	2349 LIST	2682 LIST
	Non-stocked (per color, per order)	ADD	410 NET	450 NET	490 NET	520 NET

*Veneer Tops are not compliant with Clean Air Gold Certification or Healthier Hospitals Initiative.

21 SQUARE x 21H

W: 21 D: 21 H: 21



MODEL	TOP (1.75"-THICK)		CYLINDER LEGS (CL)	BAR LEGS (BL)
ALPTB-212121(_)	Veneer*		1205	1577
ALPTB-L-212121(_)	Stocked Laminate		1259	1631
	Non-stocked Laminate (per color, per order)	ADD	50 NET	50 NET

NOTE: Custom Wood Finish (CWF) is a one-time upcharge of 300 NET per color.

MODEL	SOLID SURFACE TOP (1.5"-THICK)		CYLINDER LEGS			
			A	B	C	D
ALPTB-S-212121CL	Stocked		1642 LIST	1642 LIST	2005 LIST	2338 LIST
	Non-stocked (per color, per order)	ADD	410 NET	450 NET	490 NET	520 NET

MODEL	SOLID SURFACE TOP (1.5"-THICK)		BAR LEGS			
			A	B	C	D
ALPTB-S-212121BL	Stocked		2014 LIST	2014 LIST	2377 LIST	2710 LIST
	Non-stocked (per color, per order)	ADD	410 NET	450 NET	490 NET	520 NET

*Veneer Tops are not compliant with Clean Air Gold Certification or Healthier Hospitals Initiative.

21 SQUARE x 24H

W: 21 D: 21 H: 24



MODEL	TOP (1.75"-THICK)		CYLINDER LEGS (CL)	BAR LEGS (BL)
ALPTB-212124(_)	Veneer*		1217	1601
ALPTB-L-212124(_)	Stocked Laminate		1271	1655
	Non-stocked Laminate (per color, per order)	ADD	50 NET	50 NET

NOTE: Custom Wood Finish (CWF) is a one-time upcharge of 300 NET per color.

MODEL	SOLID SURFACE TOP (1.5"-THICK)		CYLINDER LEGS			
			A	B	C	D
ALPTB-S-212124CL	Stocked		1654 LIST	1654 LIST	2017 LIST	2350 LIST
	Non-stocked (per color, per order)	ADD	410 NET	450 NET	490 NET	520 NET

MODEL	SOLID SURFACE TOP (1.5"-THICK)		BAR LEGS			
			A	B	C	D
ALPTB-S-212124BL	Stocked		2038 LIST	2038 LIST	2401 LIST	2734 LIST
	Non-stocked (per color, per order)	ADD	410 NET	450 NET	490 NET	520 NET

*Veneer Tops are not compliant with Clean Air Gold Certification or Healthier Hospitals Initiative.



ALPINE TABLES - SQUARE

24 SQUARE x 18H

W: 24 D: 24 H: 18



MODEL	TOP (1.75"-THICK)		CYLINDER LEGS (CL)	BAR LEGS (BL)
ALPTB-242418(_)	Veneer*		1351	1699
ALPTB-L-242418(_)	Stocked Laminate		1417	1765
	Non-stocked Laminate (per color, per order)	ADD	50 NET	50 NET

NOTE: Custom Wood Finish (CWF) is a one-time upcharge of 300 NET per color.

MODEL	SOLID SURFACE TOP (1.5"-THICK)	CYLINDER LEGS			
		A	B	C	D
ALPTB-S-242418CL	Stocked	1917 LIST	1917 LIST	2369 LIST	2789 LIST
	Non-stocked (per color, per order)	ADD 410 NET	450 NET	490 NET	520 NET

MODEL	SOLID SURFACE TOP (1.5"-THICK)	BAR LEGS			
		A	B	C	D
ALPTB-S-242418BL	Stocked	2265 LIST	2265 LIST	2717 LIST	3137 LIST
	Non-stocked (per color, per order)	ADD 410 NET	450 NET	490 NET	520 NET

*Veneer Tops are not compliant with Clean Air Gold Certification or Healthier Hospitals Initiative.

24 SQUARE x 21H

W: 24 D: 24 H: 21



MODEL	TOP (1.75"-THICK)		CYLINDER LEGS (CL)	BAR LEGS (BL)
ALPTB-242421(_)	Veneer*		1355	1727
ALPTB-L-242421(_)	Stocked Laminate		1421	1793
	Non-stocked Laminate (per color, per order)	ADD	50 NET	50 NET

NOTE: Custom Wood Finish (CWF) is a one-time upcharge of 300 NET per color.

MODEL	SOLID SURFACE TOP (1.5"-THICK)	CYLINDER LEGS			
		A	B	C	D
ALPTB-S-242421CL	Stocked	1921 LIST	1921LIST	2373 LIST	2793 LIST
	Non-stocked (per color, per order)	ADD 410 NET	450 NET	490 NET	520 NET

MODEL	SOLID SURFACE TOP (1.5"-THICK)	BAR LEGS			
		A	B	C	D
ALPTB-S-242421BL	Stocked	2293 LIST	2293 LIST	2745LIST	3165 LIST
	Non-stocked (per color, per order)	ADD 410 NET	450 NET	490 NET	520 NET

*Veneer Tops are not compliant with Clean Air Gold Certification or Healthier Hospitals Initiative.

24 SQUARE x 24H

W: 24 D: 24 H: 24



MODEL	TOP (1.75"-THICK)		CYLINDER LEGS (CL)	BAR LEGS (BL)
ALPTB-242424(_)	Veneer*		1367	1751
ALPTB-L-242424(_)	Stocked Laminate		1433	1817
	Non-stocked Laminate (per color, per order)	ADD	50 NET	50 NET

NOTE: Custom Wood Finish (CWF) is a one-time upcharge of 300 NET per color.

MODEL	SOLID SURFACE TOP (1.5"-THICK)	CYLINDER LEGS			
		A	B	C	D
ALPTB-S-242424CL	Stocked	1933 LIST	1933 LIST	2385 LIST	2805 LIST
	Non-stocked (per color, per order)	ADD 410 NET	450 NET	490 NET	520 NET

MODEL	SOLID SURFACE TOP (1.5"-THICK)	BAR LEGS			
		A	B	C	D
ALPTB-S-242424BL	Stocked	2317 LIST	2317 LIST	2769 LIST	3189 LIST
	Non-stocked (per color, per order)	ADD 410 NET	450 NET	490 NET	520 NET

*Veneer Tops are not compliant with Clean Air Gold Certification or Healthier Hospitals Initiative.



ALPINE TABLES - SQUARE

30 SQUARE x 18H

W: 30 D: 30 H: 18



MODEL	TOP (1.75"-THICK)		CYLINDER LEGS (CL)	BAR LEGS (BL)
ALPTB-303018(_)	Veneer*		1563	1911
ALPTB-L-303018(_)	Stocked Laminate		1645	1993
	Non-stocked Laminate (per color, per order)	ADD	50 NET	50 NET

NOTE: Custom Wood Finish (CWF) is a one-time upcharge of 300 NET per color.

MODEL	SOLID SURFACE TOP (1.5"-THICK)	CYLINDER LEGS			
		A	B	C	D
ALPTB-S-303018CL	Stocked	2753 LIST	2753 LIST	3478 LIST	4147 LIST
	Non-stocked (per color, per order)	ADD 410 NET	450 NET	490 NET	520 NET

MODEL	SOLID SURFACE TOP (1.5"-THICK)	BAR LEGS			
		A	B	C	D
ALPTB-S-303018BL	Stocked	3101 LIST	3101 LIST	3826 LIST	4495 LIST
	Non-stocked (per color, per order)	ADD 410 NET	450 NET	490 NET	520 NET

*Veneer Tops are not compliant with Clean Air Gold Certification or Healthier Hospitals Initiative.

30 SQUARE x 21H

W: 30 D: 30 H: 21



MODEL	TOP (1.75"-THICK)		CYLINDER LEGS (CL)	BAR LEGS (BL)
ALPTB-303021(_)	Veneer*		1567	1939
ALPTB-L-303021(_)	Stocked Laminate		1649	2021
	Non-stocked Laminate (per color, per order)	ADD	50 NET	50 NET

NOTE: Custom Wood Finish (CWF) is a one-time upcharge of 300 NET per color.

MODEL	SOLID SURFACE TOP (1.5"-THICK)	CYLINDER LEGS			
		A	B	C	D
ALPTB-S-303021CL	Stocked	2757 LIST	2757 LIST	3482 LIST	4151 LIST
	Non-stocked (per color, per order)	ADD 410 NET	450 NET	490 NET	520 NET

MODEL	SOLID SURFACE TOP (1.5"-THICK)	BAR LEGS			
		A	B	C	D
ALPTB-S-303021BL	Stocked	3129 LIST	3129 LIST	3854 LIST	4523 LIST
	Non-stocked (per color, per order)	ADD 410 NET	450 NET	490 NET	520 NET

*Veneer Tops are not compliant with Clean Air Gold Certification or Healthier Hospitals Initiative.

30 SQUARE x 24H

W: 30 D: 30 H: 24



MODEL	TOP (1.75"-THICK)		CYLINDER LEGS (CL)	BAR LEGS (BL)
ALPTB-303024(_)	Veneer*		1579	1963
ALPTB-L-303024(_)	Stocked Laminate		1661	2045
	Non-stocked Laminate (per color, per order)	ADD	50 NET	50 NET

NOTE: Custom Wood Finish (CWF) is a one-time upcharge of 300 NET per color.

MODEL	SOLID SURFACE TOP (1.5"-THICK)	CYLINDER LEGS			
		A	B	C	D
ALPTB-S-303024CL	Stocked	2769 LIST	2769 LIST	3494 LIST	4163 LIST
	Non-stocked (per color, per order)	ADD 410 NET	450 NET	490 NET	520 NET

MODEL	SOLID SURFACE TOP (1.5"-THICK)	BAR LEGS			
		A	B	C	D
ALPTB-S-303024BL	Stocked	3153 LIST	3153 LIST	3878 LIST	4547 LIST
	Non-stocked (per color, per order)	ADD 410 NET	450 NET	490 NET	520 NET

*Veneer Tops are not compliant with Clean Air Gold Certification or Healthier Hospitals Initiative.



ALPINE TABLES - SQUARE

36 SQUARE x 18H

W: 36 D: 36 H: 18



MODEL	TOP (1.75"-THICK)		CYLINDER LEGS (CL)	BAR LEGS (BL)
ALPTB-363618(_)	Veneer*		1811	2159
ALPTB-L-363618(_)	Stocked Laminate		1913	2261
	Non-stocked Laminate (per color, per order)	ADD	50 NET	50 NET

NOTE: Custom Wood Finish (CWF) is a one-time upcharge of 300 NET per color.

MODEL	SOLID SURFACE TOP (1.5"-THICK)	CYLINDER LEGS			
		A	B	C	D
ALPTB-S-363618CL	Stocked	3309 LIST	3309 LIST	4216 LIST	5052 LIST
	Non-stocked (per color, per order)	ADD 410 NET	450 NET	490 NET	520 NET

MODEL	SOLID SURFACE TOP (1.5"-THICK)	BAR LEGS			
		A	B	C	D
ALPTB-S-363618BL	Stocked	3657 LIST	3657 LIST	4564 LIST	5400 LIST
	Non-stocked (per color, per order)	ADD 410 NET	450 NET	490 NET	520 NET

*Veneer Tops are not compliant with Clean Air Gold Certification or Healthier Hospitals Initiative.

36 SQUARE x 29H

W: 36 D: 36 H: 29



MODEL	TOP (1.75"-THICK)		CYLINDER LEGS (CL)	BAR LEGS (BL)
ALPTB-363629(_)	Veneer*		1939	2391
ALPTB-L-363629(_)	Stocked Laminate		2041	2493
	Non-stocked Laminate (per color, per order)	ADD	50 NET	50 NET

NOTE: Custom Wood Finish (CWF) is a one-time upcharge of 300 NET per color.

MODEL	SOLID SURFACE TOP (1.5"-THICK)	CYLINDER LEGS			
		A	B	C	D
ALPTB-S-363629CL	Stocked	3437 LIST	3437 LIST	4344 LIST	5180 LIST
	Non-stocked (per color, per order)	ADD 410 NET	450 NET	490 NET	520 NET

MODEL	SOLID SURFACE TOP (1.5"-THICK)	BAR LEGS			
		A	B	C	D
ALPTB-S-363629BL	Stocked	3889 LIST	3889 LIST	4796 LIST	5632 LIST
	Non-stocked (per color, per order)	ADD 410 NET	450 NET	490 NET	520 NET

*Veneer Tops are not compliant with Clean Air Gold Certification or Healthier Hospitals Initiative.



ALPINE TABLES - RECTANGLE

48 x 24 RECTANGLE

W: 48 D: 24 H: 18



MODEL	TOP (1.75"-THICK)		CYLINDER LEGS (CL)	BAR LEGS (BL)
ALPTB-482418(_)	Veneer*		1720	2068
ALPTB-L-482418(_)	Stocked Laminate		1815	2163
	Non-stocked Laminate (per color, per order)	ADD	50 NET	50 NET

NOTE: Custom Wood Finish (CWF) is a one-time upcharge of 300 NET per color.

MODEL	SOLID SURFACE TOP (1.5"-THICK)		CYLINDER LEGS			
			A	B	C	D
ALPTB-S-482418CL	Stocked		3031 LIST	3031 LIST	3847 LIST	4599 LIST
	Non-stocked (per color, per order)	ADD	410 NET	450 NET	490 NET	520 NET

MODEL	SOLID SURFACE TOP (1.5"-THICK)		BAR LEGS			
			A	B	C	D
ALPTB-S-482418BL	Stocked		3379 LIST	3379 LIST	4195 LIST	4947 LIST
	Non-stocked (per color, per order)	ADD	410 NET	450 NET	490 NET	520 NET

*Veneer Tops are not compliant with Clean Air Gold Certification or Healthier Hospitals Initiative.

54 x 18 RECTANGLE

W: 54 D: 18 H: 29



MODEL	TOP (1.75"-THICK)		CYLINDER LEGS (CL)	BAR LEGS (BL)
ALPTB-541829(_)	Veneer*		1761	2213
ALPTB-L-541829(_)	Stocked Laminate		1849	2301
	Non-stocked Laminate (per color, per order)	ADD	50 NET	50 NET

NOTE: Custom Wood Finish (CWF) is a one-time upcharge of 300 NET per color.

MODEL	SOLID SURFACE TOP (1.5"-THICK)		CYLINDER LEGS			
			A	B	C	D
ALPTB-S-541829CL	Stocked		2881 LIST	2881 LIST	3606 LIST	4275 LIST
	Non-stocked (per color, per order)	ADD	410 NET	450 NET	490 NET	520 NET

MODEL	SOLID SURFACE TOP (1.5"-THICK)		BAR LEGS			
			A	B	C	D
ALPTB-S-541829BL	Stocked		3333 LIST	3333 LIST	4058 LIST	4727 LIST
	Non-stocked (per color, per order)	ADD	410 NET	450 NET	490 NET	520 NET

*Veneer Tops are not compliant with Clean Air Gold Certification or Healthier Hospitals Initiative.

ALPINE TABLES | OPTIONS

3/4" GLASS TOP



MODEL	DESCRIPTION	PRICE
GLASS	3/4" Glass (set on top)	Contact Customer Service for Options and Pricing

BENCH COLLECTIONS

A-BENCHES	IBC 2 - 3
KIXSY PERCH	IBC 4

OTHER BENCHES IN THEIR RESPECTIVE COLLECTION

ALPINE BENCHES	ALC 16
ALPINE OTTOMANS	ALC 17 - 18
COASTAL METAL BENCHES	CCM 21
COASTAL WOOD BENCHES	CCW 28
COFFEE HOUSE OTTOMANS	CHC 26 - 29
ELITE OTTOMANS	TLC 5
FLAIR/SOIRÉE OTTOMANS	TLC 9
KALLISE BENCHES & OTTOMANS	KLC 8 - 9
PAX POUFS	PLC 4 - 5
PYXIS BENCHES	KPC 3
RENDEZVOUS BENCH & OTTOMANS	TLC 14
TRIA OTTOMANS	TC 8
SUMMIT OTTOMANS	ALC 15
VALAYO HARD TOP BENCHES	VC 4
VALAYO UPHOLSTERED TOP BENCHES	VC 3



BENCH COLLECTIONS | A-BENCHES

SPECIFICATION INFORMATION

PLEASE USE THE FOLLOWING SEQUENCE WHEN SPECIFYING A-BENCHES:

1. ITEM NUMBER: ABN24-(EE)-(LL)

The item number for each bench is the combination of its width (24), edge detail (EE) and leg style (LL).

EXAMPLE:

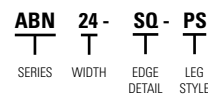

2. EDGE DETAIL OPTION: (EE)

Specify edge detail. The edge option code is two letters corresponding to the following edge details.

BEADED COVE (BC)

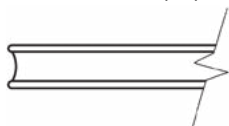

BEADED (BD)



CHAMFER (CF)

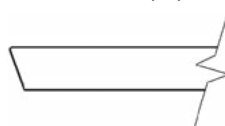

COASTAL (CT)

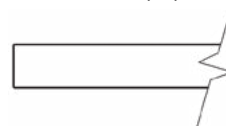

SQUARE (SQ)

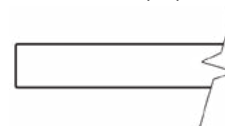

3. LEG STYLE: (LL)

Specify leg style. The leg style code is two letters corresponding to the following leg styles.

FLARED LEG (FL)



PIROUETTE LEG (PL)



TAPERED LEG (TL)



ROUND LEG (RL)



CABRIOLE LEG (CL)



COASTAL LEG (CT)



PARSONS LEG (PS)



AVAILABLE LEG & EDGE COMBINATIONS

	BEADED COVE (BC)	BEADED (BD)	CHAMFER (CF)	SQUARE (SQ)	COASTAL (CT)
FLARED (FL)	✓	✓	✓	✓	✓
PIROUETTE (PL)	✓	✓	✓	✓	✓
TAPERED (TL)	✓	✓	✓	✓	✓
ROUND (RL)	✓	✓	✓	✓	✓
CABRIOLE (CL)	✓	✓	✓	✓	NA
COASTAL (CT)	✓	✓	✓	✓	✓
PARSONS (PS)	✓	✓	✓	✓	✓



Our A-Benches are built just as solidly as the rest of our products featuring our innovatively engineered and ultra-strong steel CAM & PIN connection. The CAM & PIN is epoxied to the top and leg creating a beautiful and clean design guaranteed to hold up.



BENCH COLLECTIONS | A-BENCHES



CERTIFIED
CLEAN AIR GOLD





2K STATIC
CAPACITY

1K DROP
CAPACITY



FLARED, TAPERED, PIROUETTE OR PARSONS LEG

HARD MAPLE

		MODEL	YARDS	COM	M	COL O	P	R	S	T	U	W/WL
24 BENCH		ABN24-(EE)-(LL)	1.5	1436	1492	1559	1621	1687	1751	1817	1882	1979
W: 24 D: 18 H: 18												
36 BENCH		ABN36-(EE)-(LL)	1.5	1542	1598	1665	1727	1793	1857	1923	1988	2085
W: 36 D: 18 H: 18												
48 BENCH		ABN48-(EE)-(LL)	1.5	1623	1679	1746	1808	1874	1938	2004	2069	2166
W: 48 D: 18 H: 18												



NOTE: All A-Benches have Solid Wood Legs. Please specify finish.
Custom Wood Finish (CWF) is a one-time upcharge of 300 NET per color.

ROUND OR COASTAL LEG

		MODEL	YARDS	COM	M	COL O	P	R	S	T	U	W/WL
24 BENCH		ABN24-(EE)-(LL)	1.5	1436	1492	1559	1621	1687	1751	1817	1882	1979
W: 24 D: 18 H: 18												
36 BENCH		ABN36-(EE)-(LL)	1.5	1542	1598	1665	1727	1793	1857	1923	1988	2085
W: 36 D: 18 H: 18												
48 BENCH		ABN48-(EE)-(LL)	1.5	1623	1679	1746	1808	1874	1938	2004	2069	2166
W: 48 D: 18 H: 18												

NOTE: All A-Benches have Solid Wood Legs. Please specify finish.
Custom Wood Finish (CWF) is a one-time upcharge of 300 NET per color.

CARBRIOLE LEG

		MODEL	YARDS	COM	M	COL O	P	R	S	T	U	W/WL
24 BENCH		ABN24-(EE)-(CL)	1.5	1684	1740	1807	1869	1935	1999	2065	2130	2227
W: 24 D: 18 H: 18												
36 BENCH		ABN36-(EE)-(CL)	1.5	1790	1846	1913	1975	2041	2105	2171	2236	2333
W: 36 D: 18 H: 18												
48 BENCH		ABN48-(EE)-(CL)	1.5	1871	1927	1994	2056	2122	2186	2252	2317	2414
W: 48 D: 18 H: 18												

NOTE: All A-Benches have Solid Wood Legs. Please specify finish.
Custom Wood Finish (CWF) is a one-time upcharge of 300 NET per color.

PRODUCT OPTIONS

- MOISTURE BARRIER** \$22 List / Yard
- FIRE WALL / CA T.B. 133** \$82 List / Yard
- PERMA-COAT WOOD LEG PROTECTOR** \$35 List / Leg



KIXSY PERCH

MODEL	YARDS	COM	M	COL	P	R	S	T	U	W/WL
KIXSY-P	.5	858	877	899	920	942	963	985	1007	1039

PERCH

W: 15 D: 17 H: 28



NOTE: Must specify powder coat finish for base.



PRODUCT OPTIONS

- MOISTURE BARRIER** \$22 List / Yard
- FIRE WALL / CA T.B. 133** \$82 List / Yard

CH KIDS COLLECTION

CH KIDS SEATING CHK 2 - 4

CH KIDS SYSTEMS CHK 5 - 6

CH KIDS OTTOMANS CHK 7 - 8







CH KIDS COLLECTION | CH KIDS SEATING







CERTIFIED
CLEAN AIR GOLD

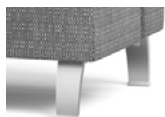

CHK - CLEAN-OUT SEAT

	MODEL	YARDS	COM	M	COL O	P	R	S	T	U	W/WL
20" STRAIGHT W: 20 D: 25 H: 28 SW: 20 SD: 17 SH: 16 BH: 12	 CHKOST-1-20	3	1166	1277	1412	1535	1667	1796	1928	2057	2252
40" STRAIGHT W: 40 D: 25 H: 28 SW: 20 SD: 17 SH: 16 BH: 12	 CHKOST-1-40	3.25	1866	1986	2133	2266	2409	2549	2692	2831	3043
45° INSIDE CURVE W: 37.75 D: 26.5 H: 28 SW: 20 SD: 17 SH: 16 BH: 12	 CHKOIC-1-45	3.25	1814	1934	2081	2214	2357	2497	2640	2779	2991
45° OUTSIDE CURVE W: 37.75 D: 26.5 H: 28 SW: 37.75 SD: 17 SH: 16 BH: 12	 CHKOOC-1-45	3.25	1814	1934	2081	2214	2357	2497	2640	2779	2991

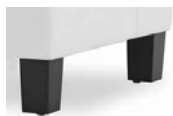
CH KIDS | LEG OPTIONS

	MODEL	DESCRIPTION	PRICE
BRUSHED ALUMINUM LEGS 	4BA		No Upcharge
WOOD LEGS 	GGCH4	Specify Wood Finish	No Upcharge
HIDE & GO MOBILITY 	HGCH4	Wood Legs with special casters in front two. Specify Wood Finish.	30 LIST
5" HEAVY DUTY CASTERS 	5C1	Set of 4 Locking Black Casters Note: Casters cannot be used on seating with a tablet arm	136 LIST/SET OF 4



CH KIDS | ARM OPTION

MODEL	W	YARDS	COM	M	COL								
					O	P	R	S	T	U	W/WL		
4" UPHOLSTERED ARMS													
CHK(PR)													
PAIR LEFT and RIGHT ARMS (PR)	8	2.5	532	625	737	840	950	1057	1167	1275	1437		

D: 24
H: 22

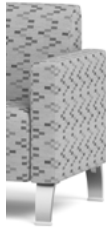

CH KIDS | ARM CAP OPTIONS

MODEL	GRADE	A	B	C	D
SOLID SURFACE ARM CAPS	ACCHKS(1-12) Stocked Solid Surface	250 LIST/PR	276 LIST/PR	308 LIST/PR	362 LIST/PR
	Non-stocked (per color, per order)	ADD 410 Net	450 Net	490 Net	520 Net



MODEL	DESCRIPTION	PRICE
LAMINATE/PLYWOOD EDGE ARM CAPS	ACCHKL Stocked (Laminate arm caps have a plywood edge. Specify finish.)	210 LIST/EA
	Non-stocked (per color, per order)	ADD 50 NET





Powder Coat selection required for tablet post.

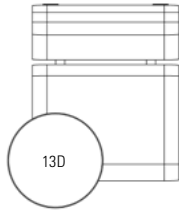

CHOOSE POSITION

(4)

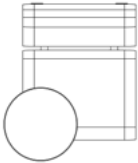

(4) - Tablet on right as seated

(5)

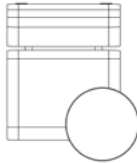

(5) - Tablet on left as seated

13" ROUND SOLID SURFACE TABLET OPTION

MODEL	GRADE		A	B	C	D
STK4-(4/5)	Stocked		649 LIST	672 LIST	704 LIST	758 LIST
	Non-stocked (per color, per order)	ADD	410 NET	450 NET	490 NET	520 NET

13" ROUND LAMINATE/PLYWOOD EDGE TABLET OPTION

MODEL	GRADE		PRICE
LTK4-(4/5)	Stocked (Laminate tablets have a plywood edge. Specify finish.)		560 LIST
	Non-stocked (per color, per order)	ADD	50 NET

Note: 25 lbs of weight at \$305 must be added to a 20" chair with a tablet for stability
Casters cannot be used on seating with a tablet arm

CH KIDS | OTHER OPTIONS

RECESSED PULL HANDLE

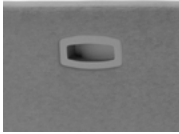

MODEL	DESCRIPTION	PRICE
RPH(B/G)	For use with mobile options. Specify Black (B) or Gray (G).	86 LIST

PRODUCT OPTIONS

- MOISTURE BARRIER \$22 List / Yard
- FIRE WALL / CA T.B. 133 \$82 List / Yard
- TAMPER-RESISTANT FASTENERS \$51 List / Chair
- PERMA-COAT WOOD LEG PROTECTOR \$35 List / Leg
- WEIGHTED / THEFT DETERRENT \$305 List / 25 lb Weight



CH KIDS COLLECTION | CH KIDS SYSTEMS





CERTIFIED
CLEAN AIR GOLD



CHK SYSTEMS - CLEAN-OUT-SEAT

	MODEL	YARDS	COM	M	COL O	P	R	S	T	U	W/WL
20" STRAIGHT	CHKOST-0-20	3	826	937	1072	1195	1327	1456	1588	1717	1912
W: 20 D: 25 H: 28											
SW: 20 SD: 17 SH: 16											
BH: 12											

	MODEL	YARDS	COM	M	COL O	P	R	S	T	U	W/WL
40" STRAIGHT	CHKOST-0-40	3.25	1526	1646	1793	1926	2069	2209	2352	2491	2703
W: 40 D: 25 H: 28											
SW: 20 SD: 17 SH: 16											
BH: 12											

	MODEL	YARDS	COM	M	COL O	P	R	S	T	U	W/WL
45° INSIDE CURVE	CHKOIC-0-45	3.25	1474	1594	1741	1874	2017	2157	2300	2439	2651
W: 37.75 D: 26.5 H: 28											
SW: 20 SD: 17 SH: 16											
BH: 12											

	MODEL	YARDS	COM	M	COL O	P	R	S	T	U	W/WL
45° OUTSIDE CURVE	CHKOOC-0-45	3.25	1474	1594	1741	1874	2017	2157	2300	2439	2651
W: 37.75 D: 26.5 H: 28											
SW: 37.75 SD: 17 SH: 16											
BH: 12											

SYSTEMS | GANGING OPTIONS

	MODEL	PRICE
RIGID PLATE CONNECTOR	RPC	26 LIST
		

SYSTEMS | LEG OPTIONS

	MODEL	PRICE
BRUSHED ALUMINUM LEGS	4BA	340 LIST/SET OF 4
		

	MODEL	DESCRIPTION	PRICE
WOOD LEGS	GGCH4	Specify Wood Finish	340 LIST/SET OF 4
			



SYSTEMS | ARM OPTION

MODEL	W	YARDS	COM	M	COL							W/WL
					O	P	R	S	T	U		
4" UPHOLSTERED ARMS												
CHK(AL/AR)												
EACH LEFT (AL) or RIGHT (AR) ARM	4	1.25	266	312	369	420	475	529	584	637	719	

D: 24
H: 22

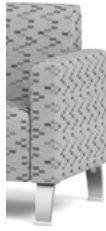

SYSTEMS | ARM CAP OPTIONS

MODEL	GRADE	A	B	C	D
SOLID SURFACE ARM CAPS	ACCHKSS(1-12) Stocked Solid Surface	125 LIST/EA	138 LIST/EA	154 LIST/EA	181 LIST/EA
	Non-stocked (per color, per order)	ADD	410 NET	450 NET	490 NET



MODEL	DESCRIPTION	PRICE
LAMINATE/PLYWOOD EDGE ARM CAPS	ACCHKLS Stocked (Laminate arm caps have a plywood edge. Specify finish.)	105 LIST/EA
	Non-stocked (per color, per order)	ADD 50 NET



PRODUCT OPTIONS

- MOISTURE BARRIER** \$22 List / Yard
- FIRE WALL / CA T.B. 133** \$82 List / Yard
- TAMPER-RESISTANT FASTENERS** \$51 List / Chair
- PERMA-COAT WOOD LEG PROTECTOR** \$35 List / Leg
- WEIGHTED / THEFT DETERRENT** \$305 List / 25 lb Weight



CH KIDS COLLECTION | OTTOMANS



CERTIFIED CLEAN AIR GOLD

Healthier Hospitals

COMPONENT-BASED CONSTRUCTION

2K STATIC CAPACITY

1K DROP CAPACITY

CH KIDS OTTOMANS WITH GLIDES

	MODEL	TOP	YARDS	COM	M	COL O	P	R	S	T	U	W/WL	
18 ROUND DIA: 18 H: 12.375	CHKOT6	Upholstered	1.25	692	738	795	846	901	955	1010	1063	1145	
	CHKOT6-L	Stocked Laminate/Plywood Edge	1.25	1069	1115	1172	1223	1278	1332	1387	1440	1522	
	CHKOT6-S	Stocked Solid Surface	A	1.25	1039	1085	1142	1193	1248	1302	1357	1410	1492
			B	1.25	1115	1161	1218	1269	1324	1378	1433	1486	1568
			C	1.25	1224	1270	1327	1378	1433	1487	1542	1595	1677
	D	1.25	1396	1442	1499	1550	1605	1659	1714	1767	1849		
24 ROUND DIA: 24 H: 12.375	CHKOT4	Upholstered	1.25	692	738	795	846	901	955	1010	1063	1145	
	CHKOT4-L	Stocked Laminate/Plywood Edge	1.25	1069	1115	1172	1223	1278	1332	1387	1440	1522	
	CHKOT4-S	Stocked Solid Surface	A	1.25	1278	1324	1381	1432	1487	1541	1596	1649	1731
			B	1.25	1382	1428	1485	1536	1591	1645	1700	1753	1835
			C	1.25	1536	1582	1639	1690	1745	1799	1854	1907	1989
	D	1.25	1776	1822	1879	1930	1985	2039	2094	2147	2229		
30 ROUND DIA: 30 H: 12.375	CHKOT7	Upholstered	2.5	784	877	989	1092	1202	1309	1419	1527	1689	
	CHKOT7-L	Stocked Laminate/Plywood Edge	1.5	1288	1344	1411	1473	1539	1603	1669	1734	1831	
	CHKOT7-S	Stocked Solid Surface	A	1.5	1527	1583	1650	1712	1778	1842	1908	1973	2070
			B	1.5	1659	1715	1782	1844	1910	1974	2040	2105	2202
			C	1.5	1849	1905	1972	2034	2100	2164	2230	2295	2392
	D	1.5	2151	2207	2274	2336	2402	2466	2532	2597	2694		

NON-STOCKED / CUSTOM FINISH UPCHARGES

Non-Stocked Laminate (per color, per order)	ADD	50 NET			
Custom Wood Finish (CWF) (one-time upcharge)	ADD	300 NET			
		A	B	C	D
Non-Stocked Solid Surface (per color, per order)	ADD	410 NET	450 NET	490 NET	520 NET

CH KIDS OTTOMANS WITH LEGS

	MODEL	TOP	YARDS	COM	M	COL O	P	R	S	T	U	W/WL
24 x 24 SQUARE W: 24 D: 24 H: 16	CHKOT2424	Upholstered	1.5	1008	1064	1131	1193	1259	1323	1389	1454	1551
48 x 24 RECTANGLE W: 48 D: 24 H: 16	CHKOT4824	Upholstered	2.5	1344	1437	1549	1652	1762	1869	1979	2087	2249
48 x 24 HALF ROUND W: 48 D: 24 H: 16	CHKOT4824HO	Upholstered	2	1344	1418	1508	1590	1678	1764	1852	1938	2068
45° WEDGE W: 37.75 D: 26.5 H: 16	CHKOT45W	Upholstered	2	1252	1326	1416	1498	1586	1672	1760	1846	1976

PRODUCT OPTIONS

MOISTURE BARRIER	\$22 List / Yard
FIRE WALL / CA T.B. 133	\$82 List / Yard
TAMPER-RESISTANT FASTENERS	\$51 List / Chair
PERMA-COAT WOOD LEG PROTECTOR	\$35 List / Leg
WEIGHTED / THEFT DETERRENT	\$305 List / 25 lb Weight



CH KIDS OTTOMANS | LEG OPTIONS

	MODEL	PRICE
BRUSHED ALUMINUM LEGS	4BA	No Upcharge

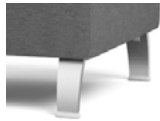

	MODEL	DESCRIPTION	PRICE
WOOD LEGS	GGCH4	Specify Wood Finish	No Upcharge

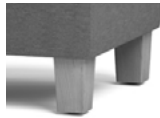

	MODEL	DESCRIPTION	PRICE
5" HEAVY DUTY CASTERS	5C1	Set of 4 Locking Black Casters	136 LIST/SET OF 4



COASTAL COLLECTION | METAL

BAY METAL	CCM 2 - 4
MARINA METAL	CCM 5 - 6
MARINA UPHOLSTERED ARM WITH METAL LEGS	CCM 7 - 9
MARINA / BAY OTTOMAN WITH METAL LEGS	CCM 10
REEF UPHOLSTERED ARM WITH METAL LEGS	CCM 11 - 12
TIDE METAL	CCM 13 - 15
TIDE METAL SYSTEM SEATING & TABLES	CCM 16 - 17
TIDE METAL SYSTEM SPECIFICATIONS	CCM 18
TIDE FOOTSTOOLS	CCM 19
TIDE REPLACEMENT COMPONENTS/COVERS	CCM 20
COASTAL METAL BENCHES	CCM 21
COASTAL METAL TABLES	CCM 22 - 23



COASTAL COLLECTION METAL | BAY METAL









CERTIFIED
CLEAN AIR GOLD



BAY METAL - WALL SAVER DESIGN

POWDER COATED STEEL

		MODEL	BACK STYLE	YARDS	COM	M	COL					U	W/WL
							O	P	R	S	T		
CHAIR - 22" SW W: 22 D: 29.25 H: 36.25 SW: 22 SD: 19 SH: 19 BH: 20		CBAYML-1-22	Tapered	2.75	1402	1504	1628	1740	1861	1980	2101	2219	2398
		CBAYMLS-1-22	Straight	2.75	1402	1504	1628	1740	1861	1980	2101	2219	2398
CHAIR - 27" SW W: 27 SW: 27		CBAYML-1-27	Tapered	3.25	1564	1684	1831	1964	2107	2247	2390	2529	2741
		CBAYMLS-1-27	Straight	3.25	1564	1684	1831	1964	2107	2247	2390	2529	2741
CHAIR - 32" SW W: 32 SW: 32		CBAYML-1-32	Tapered	4	1810	1958	2138	2302	2478	2650	2826	2998	3258
		CBAYMLS-1-32	Straight	4	1810	1958	2138	2302	2478	2650	2826	2998	3258
CHAIR - 42" SW W: 42 SW: 42		CBAYML-1-42	Tapered	4.5	2163	2330	2532	2717	2915	3108	3306	3500	3792
		CBAYMLS-1-42	Straight	4.5	2163	2330	2532	2717	2915	3108	3306	3500	3792
SETTEE W: 44 SW: 44		CBAYMLS-2	Straight	5.5	2454	2658	2905	3131	3373	3609	3851	4088	4445
SOFA W: 66 SW: 66		CBAYMLS-3	Straight	8.25	3506	3811	4183	4521	4884	5239	5602	5956	6493



BAY METAL | LEG OPTIONS

METAL LEGS



MODEL	DESCRIPTION	PRICE
MM4L	Wall Saver. Specify Powder Coat.	No Upcharge

5" HEAVY DUTY CASTERS



MODEL	DESCRIPTION	PRICE
5C1	Not Wall Saver. Set of 4 Locking Casters.	20 LIST

NOTE: Recommended for use with 22", 27", 32"sw only.

When specified with Tablets on 22" and 27"sw, a 25lb weight is required and you must add \$305 to the list price.

PLINTH BASE INCLUDES SECURE BOTTOM COVERS



MODEL	SEAT WIDTH	PRICE
CB22PB	22"	46 LIST
CB27PB	27"	142 LIST
CB32PB	32"	306 LIST
CB42PB	42"	601 LIST

NOTE: Secure Bottom Covers include tamper-resistant fasteners.

PLINTH BASE HDPE COLOR OPTIONS

Black, Charcoal, Gray, White

BAY METAL | TABLET OPTIONS

ALL INTEGRA TABLETS HAVE A 300LB CAPACITY



Powder Coat selection required for metal legs and tablet post.

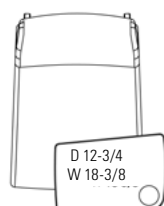
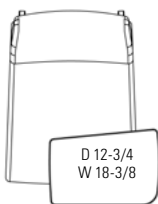

With Cup Holder option

CHOOSE POSITION

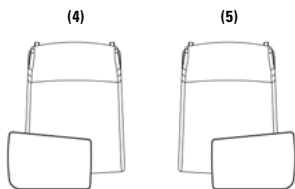

(4) - Tablet on right as seated

(5) - Tablet on left as seated

SOLID SURFACE TABLET OPTION

MODEL	GRADE	A	B	C	D
ST-(4/5)	Stocked	812 LIST	848 LIST	900 LIST	983 LIST
	Non-stocked (per color, per order)	ADD 410 NET	450 NET	490 NET	520 NET

LAMINATE OVER PLYWOOD CORE/EDGE TABLET OPTION

MODEL	GRADE	PRICE
LT-(4/5)	Stocked (Laminate tablets have a plywood edge. Specify finish.)	637 LIST
	Non-stocked (per color, per order)	ADD 50 NET

VENEER OVER PLYWOOD CORE/EDGE TABLET OPTION

MODEL	GRADE	PRICE
VT-(4/5)	Standard Wood Finish	637 LIST
	Custom Finish (one time charge per color)	ADD 300 NET

CUP HOLDER

MODEL	FINISH	PRICE
CUPIN	Brushed Aluminum	216 LIST



BAY METAL | OTHER OPTIONS

	MODEL	DESCRIPTION	PRICE
RECESSED PULL HANDLE	RPH(B/G)	For use with Casters option. Specify Black (B) or Gray (G).	86 LIST



	MODEL	SEAT WIDTH	PRICE
SECURE BOTTOM COVERS	SBC	22"	167 LIST
		27"	177 LIST
		32"	177 LIST
		42"	201 LIST



Shown on Marina Wood Arm

NOTE: Secure Bottom Covers include tamper-resistant fasteners.

PRODUCT OPTIONS

- MOISTURE BARRIER** \$22 List / Yard
- FIRE WALL / CA T.B. 133** \$82 List / Yard
- WEIGHTED / THEFT DETERRENT** \$305 List / 25 lb Weight
- \$610 List / 50 lb Weight



COASTAL COLLECTION METAL | MARINA METAL



CERTIFIED
CLEAN AIR GOLD



MARINA METAL WITH SOLID SURFACE ARM CAPS - WALL SAVER DESIGN

POWDER COATED STEEL

	MODEL	BACK STYLE	YARDS	COM	M	COL O	P	R	S	T	U	W/WL
CHAIR - 22" SW W: 25.75 D: 29.5 H: 36.75 SW: 22 SD: 19 SH: 19 BH: 20 AH: 25.75	CMMAR-1-22	Tapered	2.75	1950	2052	2176	2288	2409	2528	2649	2767	2946
	CMMARS-1-22	Straight	2.75	1950	2052	2176	2288	2409	2528	2649	2767	2946
CHAIR - 27" SW W: 30.75 SW: 27	CMMAR-1-27	Tapered	3.25	2112	2232	2379	2512	2655	2795	2938	3077	3289
	CMMARS-1-27	Straight	3.25	2112	2232	2379	2512	2655	2795	2938	3077	3289
CHAIR - 32" SW W: 35.75 SW: 32	CMMAR-1-32	Tapered	4	2358	2506	2686	2850	3026	3198	3374	3546	3806
	CMMARS-1-32	Straight	4	2358	2506	2686	2850	3026	3198	3374	3546	3806
CHAIR - 42" SW W: 45.75 SW: 42	CMMAR-1-42	Tapered	4.5	2711	2878	3080	3265	3463	3656	3854	4048	4340
	CMMARS-1-42	Straight	4.5	2711	2878	3080	3265	3463	3656	3854	4048	4340
SETTEE W: 47.75 SW: 44	CMMARS-2	Straight	5.5	3002	3206	3453	3679	3921	4157	4399	4636	4993
SOFA W: 69.75 SW: 66	CMMARS-3	Straight	8.25	4054	4359	4731	5069	5432	5787	6150	6504	7041

MARINA METAL | SOLID SURFACE ARM CAPS

	MODEL	GRADE	A	B	C	D
SOLID SURFACE ARM CAPS	ACMMS	Stocked Solid Surface	NC	NC	38 LIST/PR	68 LIST/PR
		Non-stocked (per color, per order)	ADD	410 NET	450 NET	490 NET





CHOOSE POSITION

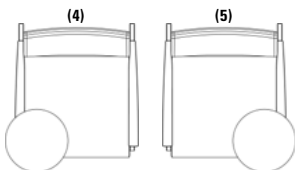

(4) - Tablet on right as seated

(5) - Tablet on left as seated

13" ROUND SOLID SURFACE TABLET OPTION

MODEL	GRADE	A	B	C	D
ST4-(4/5)	Stocked	613 LIST	636 LIST	668 LIST	722 LIST
	Non-stocked (per color, per order)	ADD 410 NET	450 NET	490 NET	520 NET

13" ROUND LAMINATE OVER PLYWOOD CORE/EDGE TABLET OPTION

MODEL	GRADE	PRICE
LT4-(4/5)	Stocked (Laminate tablets have a plywood edge. Specify finish.)	524 LIST
	Non-stocked (per color, per order)	ADD 50 NET

13" ROUND VENEER OVER PLYWOOD CORE/EDGE TABLET OPTION

MODEL	GRADE	PRICE
VT4-(4/5)	Standard Wood Finish	524 LIST
	Custom Finish (one time charge per color)	ADD 300 NET

STAINLESS STEEL STAND-OFFS

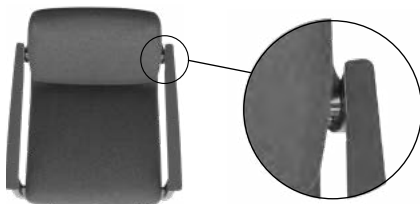

MODEL	DESCRIPTION	PRICE
SPANNERS	Adds 1.5" to seat width and overall width for cleanability	233 LIST/SET

SECURE BOTTOM COVERS



MODEL	SEAT WIDTH	PRICE
SBC	22"	167 LIST
	27"	177 LIST
	32"	177 LIST
	42"	201 LIST

NOTE: Secure Bottom Covers include tamper-resistant fasteners.

PRODUCT OPTIONS

- MOISTURE BARRIER \$22 List / Yard
- FIRE WALL / CA T.B. 133 \$82 List / Yard
- WEIGHTED / THEFT DETERRENT \$305 List / 25 lb Weight
\$610 List / 50 lb Weight



MARINA UPHOLSTERED ARM WITH METAL LEGS - WALL SAVER DESIGN

	MODEL	BACK STYLE	YARDS	COL									
				COM	M	O	P	R	S	T	U	W/WL	
CHAIR - 22" SW W: 29 D: 29.25 H: 36.25 SW: 22 SD: 19 SH: 19 BH: 20 AH: 26	CMMU-1-22	Tapered	5.25	2156	2350	2587	2802	3033	3259	3490	3715	4057	
	CMMUS-1-22	Straight	5.25	2156	2350	2587	2802	3033	3259	3490	3715	4057	
CHAIR - 27" SW W: 34 SW: 27	CMMU-1-27	Tapered	5.75	2318	2531	2790	3025	3278	3526	3779	4026	4400	
	CMMUS-1-27	Straight	5.75	2318	2531	2790	3025	3278	3526	3779	4026	4400	
CHAIR - 32" SW W: 39 SW: 32	CMMU-1-32	Tapered	6.5	2564	2805	3097	3364	3650	3929	4215	4495	4917	
	CMMUS-1-32	Straight	6.5	2564	2805	3097	3364	3650	3929	4215	4495	4917	
CHAIR - 42" SW W: 49 SW: 42	CMMU-1-42	Tapered	7	2917	3176	3491	3778	4086	4387	4695	4996	5451	
	CMMUS-1-42	Straight	7	2917	3176	3491	3778	4086	4387	4695	4996	5451	
SETTEE W: 51.75 SW: 44	CMMUS-2	Straight	8	3208	3504	3864	4192	4544	4888	5240	5584	6104	
	CMMUS-3	Straight	10.75	4260	4658	5142	5582	6055	6518	6991	7453	8152	

MARINA UPHOLSTERED ARM | LEG OPTION

	MODEL	SEAT WIDTH	PRICE
PLINTH BASE INCLUDES SECURE BOTTOM COVERS	CB22PB	22"	46 LIST
	CB27PB	27"	142 LIST
	CB32PB	32"	306 LIST
	CB42PB	42"	601 LIST



NOTE: Secure Bottom Covers include tamper-resistant fasteners.

PLINTH BASE HDPE COLOR OPTIONS

Black, Charcoal, Gray, White



MARINA UPHOLSTERED ARM | ARM CAP OPTIONS

SOLID SURFACE ARM CAPS



MODEL	GRADE		A	B	C	D
ACMUS	Stocked Solid Surface		460LIST/PR	460LIST/PR	580LIST/PR	702LIST/PR
	Non-stocked (per color, per order)	ADD	410 NET	450 NET	490 NET	520 NET

WOOD ARM CAPS



MODEL	DESCRIPTION	PRICE
ACMM	Solid Wood. Specify finish.	298 LIST/PR

MARINA UPHOLSTERED ARM | TABLET OPTIONS

ALL INTEGRA TABLETS HAVE A 300LB CAPACITY



Tablets available in Upholstered Arms with and without Arm Caps.

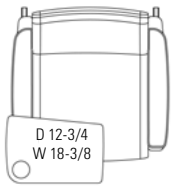

With Cup Holder Option

CHOOSE POSITION

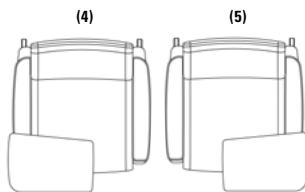

- (4) - Tablet on right as seated
- (5) - Tablet on left as seated

SOLID SURFACE TABLET OPTION

MODEL	GRADE		A	B	C	D
ST-(4/5)	Stocked		723 LIST	759 LIST	811 LIST	894 LIST
	Non-stocked (per color, per order)	ADD	410 NET	450 NET	490 NET	520 NET

LAMINATE OVER PLYWOOD CORE/EDGE TABLET OPTION

MODEL	GRADE	PRICE
LT-(4/5)	Stocked (Laminate tablets have a plywood edge. Specify finish.)	548 LIST
	Non-stocked (per color, per order)	ADD 50 NET

VENEER OVER PLYWOOD CORE/EDGE TABLET OPTION

MODEL	GRADE	PRICE
VT-(4/5)	Standard Wood Finish	548 LIST
	Custom Finish (one time charge per color)	ADD 300 NET

CUP HOLDER

MODEL	FINISH	PRICE
CUPIN	Brushed Aluminum	216 LIST



MARINA UPHOLSTERED ARM | OTHER OPTIONS

STAINLESS STEEL STAND-OFFS

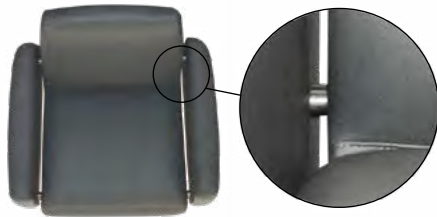

MODEL	DESCRIPTION	PRICE
SPANNERS	Adds 1.5" to seat width and overall width for cleanability	233 LIST/SET

SECURE BOTTOM COVERS

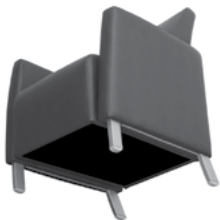

MODEL	SEAT WIDTH	PRICE
SBC	22"	167 LIST
	27"	177 LIST
	32"	177 LIST
	42"	201 LIST

NOTE: Secure Bottom Covers include tamper-resistant fasteners.

PRODUCT OPTIONS

MOISTURE BARRIER	\$22 List / Yard
FIRE WALL / CA T.B. 133	\$82 List / Yard
WEIGHTED / THEFT DETERRENT	\$305 List / 25 lb Weight
	\$610 List / 50 lb Weight



MARINA / BAY OTTOMAN WITH METAL LEGS

	MODEL	YARDS	COM	M	COL							W/WL
					O	P	R	S	T	U		
OTTOMAN WITH METAL LEGS	CMMOT1	1.5	975	1031	1098	1160	1226	1290	1356	1421	1518	

W: 22 D: 24 H: 14-18



MARINA / BAY OTTOMAN WITH METAL LEGS | OTHER OPTIONS

	MODEL	PRICE
SECURE BOTTOM COVERS	SBC Marina / Bay Ottoman	191 LIST

NOTE: Secure Bottom Covers include tamper-resistant fasteners.

PRODUCT OPTIONS

MOISTURE BARRIER \$22 List / Yard
FIRE WALL / CA T.B. 133 \$82 List / Yard
WEIGHTED / THEFT DETERRENT \$305 List / 25 lb Weight



COASTAL COLLECTION METAL | REEF METAL



CERTIFIED CLEAN AIR GOLD



REEF UPHOLSTERED ARM WITH METAL LEGS

POWDER COATED STEEL

CHAIR - 24" SW

W: 34 D: 32.5 H: 37
SW: 24 SD: 21 SH: 17.5
BH: 23 AH: 24.5



MODEL	BACK STYLE	YARDS	COM	M	COL								W/WL
CRFMU-1-24	Tapered	6	2557	2779	3049	3295	3559	3817	4081	4339	4729		
CRFMUC-1-24	Tapered	6	2557	2779	3049	3295	3559	3817	4081	4339	4729		
CRFMUS-1-24	Straight	6	2557	2779	3049	3295	3559	3817	4081	4339	4729		
CRFMUCS-1-24	Straight	6	2557	2779	3049	3295	3559	3817	4081	4339	4729		

CHAIR - 44" SW

W: 54
SW: 44



CRFMU-1-44	Tapered	7	3404	3663	3978	4265	4573	4874	5182	5483	5938	
CRFMUC-1-44	Tapered	7	3404	3663	3978	4265	4573	4874	5182	5483	5938	
CRFMUS-1-44	Straight	7	3404	3663	3978	4265	4573	4874	5182	5483	5938	
CRFMUCS-1-44	Straight	7	3404	3663	3978	4265	4573	4874	5182	5483	5938	

SETTEE

W: 58
SW: 48



CRFMUS-2	Straight	9.5	4046	4398	4825	5215	5633	6041	6459	6868	7485	
CRFMUCS-2	Straight	9.5	4046	4398	4825	5215	5633	6041	6459	6868	7485	

SOFA

W: 82
SW: 72



CRFMUS-3	Straight	13	5535	6016	6601	7134	7706	8265	8837	9396	10241	
CRFMUCS-3	Straight	13	5535	6016	6601	7134	7706	8265	8837	9396	10241	

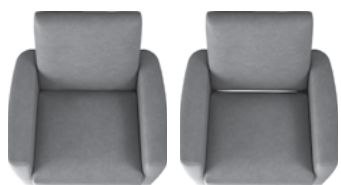

Standard (CRFMU or CRFMUS) Clean Out (CRFMUC or CRFMUCS)

REEF UPHOLSTERED ARM | ARM CAP OPTIONS

SOLID SURFACE ARM CAPS

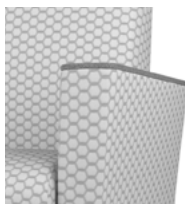

MODEL	GRADE	A	B	C	D
ACRFUS	Stocked Solid Surface	460 LIST/PR	460 LIST/PR	580 LIST/PR	702 LIST/PR
	Non-stocked (per color, per order)	ADD 410 NET	450 NET	490 NET	520 NET

WOOD ARM CAPS



MODEL	DESCRIPTION	PRICE
ACRFM	Solid Wood. Specify finish.	346 LIST/PR



REEF UPHOLSTERED ARM | TABLET OPTIONS



Tablets available in Upholstered Arms with and without Arm Caps.

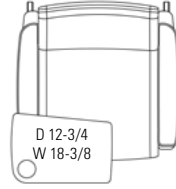

With Cup Holder Option

CHOOSE POSITION

(4)

(5)

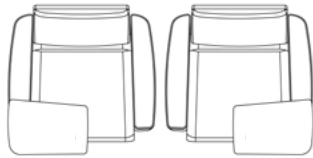

(4) - Tablet on right as seated

(5) - Tablet on left as seated

SOLID SURFACE TABLET OPTION

MODEL	GRADE		A	B	C	D
ST-(4/5)	Stocked		723 LIST	759 LIST	811 LIST	894 LIST
	Non-stocked (per color, per order)	ADD	410 NET	450 NET	490 NET	520 NET

LAMINATE OVER PLYWOOD CORE/EDGE TABLET OPTION

MODEL	GRADE		PRICE
LT-(4/5)	Stocked (Laminate tablets have a plywood edge. Specify finish.)		548 LIST
	Non-stocked (per color, per order)	ADD	50 NET

VENEER OVER PLYWOOD CORE/EDGE TABLET OPTION

MODEL	GRADE		PRICE
VT-(4/5)	Standard Wood Finish		548 LIST
	Custom Finish (one time charge per color)	ADD	300 NET

CUP HOLDER

MODEL	FINISH	PRICE
CUPIN	Brushed Aluminum	216 LIST

REEF UPHOLSTERED ARM | OTHER OPTIONS

SECURE BOTTOM COVERS



Shown on Marina Upholstered Arm Chair

MODEL	SEAT WIDTH	PRICE
SBCRF24	24"	142 LIST
SBCRF44	44"	176 LIST

NOTE: Secure Bottom Covers include tamper-resistant fasteners.

PRODUCT OPTIONS

MOISTURE BARRIER \$22 List / Yard
FIRE WALL / CA T.B. 133 \$82 List / Yard
WEIGHTED / THEFT DETERRENT \$305 List / 25 lb Weight
 \$610 List / 50 lb Weight



COASTAL COLLECTION METAL | TIDE METAL





CERTIFIED
CLEAN AIR GOLD





LOW TIDE METAL WITH SOLID SURFACE ARM CAPS - WALL SAVER DESIGN



POWDER COATED STEEL

		MODEL	W	SW	YARDS	COM	M	COL						W/WL
								O	P	R	S	T	U	
CHAIR H: 34 D: 27.5 SH: 18.5 SD: 19 BH: 16.5 AH: 26 		CTMLO-1-22	25.75	22	2	1660	1734	1824	1906	1994	2080	2168	2254	2384
		CTMLO-1-27	30.75	27	2.5	1801	1894	2006	2109	2219	2326	2436	2544	2706
		CTMLO-1-32	35.75	32	2.75	2046	2148	2272	2384	2505	2624	2745	2863	3042
		CTMLO-1-42	45.75	42	3	2309	2420	2555	2678	2810	2939	3071	3200	3395
SETTEE 		CTMLO-2	47.75	44	4	2311	2459	2639	2803	2979	3151	3327	3499	3759
ORTHO HEIGHT SEATING H: 39.75 D: 28.25 SH: 24.5 AH: 31.5 Step adds to overall depth 		CTMLOOR-1-22	25.75	22	2	2029	2103	2193	2275	2363	2449	2537	2623	2753
		CTMLOOR-1-27	30.75	27	2.5	2231	2324	2436	2539	2649	2756	2866	2974	3136
		CTMLOOR-1-32	35.75	32	2.75	2525	2627	2751	2863	2984	3103	3224	3342	3521

HIGH TIDE METAL WITH SOLID SURFACE ARM CAPS



		MODEL	W	SW	YARDS	COM	M	COL						W/WL
								O	P	R	S	T	U	
CHAIR H: 36.75 D: 28 SH: 18.5 SD: 19 BH: 20 AH: 26 		CTMHI-1-22	25.75	22	2.25	1696	1779	1881	1973	2072	2169	2268	2364	2511
		CTMHI-1-27	30.75	27	2.75	1814	1916	2040	2152	2273	2392	2513	2631	2810
		CTMHI-1-32	35.75	32	3	2082	2193	2328	2451	2583	2712	2844	2973	3168
		CTMHI-1-42	45.75	42	3.5	2340	2470	2627	2771	2925	3075	3229	3380	3607
SETTEE 		CTMHI-2	47.75	44	4.5	2383	2550	2752	2937	3135	3328	3526	3720	4012
ORTHO HEIGHT SEATING H: 42.75 D: 28.75 SH: 24.5 AH: 31.5 Step adds to overall depth 		CTMHIOR-1-22	25.75	22	2.25	2065	2148	2250	2342	2441	2538	2637	2733	2880
		CTMHIOR-1-27	30.75	27	2.75	2244	2346	2470	2582	2703	2822	2943	3061	3240
		CTMHIOR-1-32	35.75	32	3	2561	2672	2807	2930	3062	3191	3323	3452	3647

PATIENT BACK TIDE METAL WITH SOLID SURFACE ARM CAPS



		MODEL	W	SW	YARDS	COM	M	COL						W/WL
								O	P	R	S	T	U	
CHAIR H: 47.75 D: 28.75 SH: 18.5 SD: 20 BH: 30 AH: 26 		CTMPT-1-22	25.75	22	3	1902	2013	2148	2271	2403	2532	2664	2793	2988
		CTMPT-1-27	30.75	27	3.25	2060	2180	2327	2460	2603	2743	2886	3025	3237
ORTHO HEIGHT SEATING H: 53.5 D: 29.75 SH: 24.5 AH: 31.5 Step adds to overall depth 		CTMPTOR-1-22	25.75	22	3	2271	2382	2517	2640	2772	2901	3033	3162	3357
		CTMPTOR-1-27	30.75	27	3.25	2490	2610	2757	2890	3033	3173	3316	3455	3667



LOW TIDE METAL ARMLESS

	MODEL	W	SW	YARDS	COM	M	COL						W/WL
							O	P	R	S	T	U	
CHAIR H: 34 D: 27.5 SH: 18.5 SD: 19 BH: 16.5	 CTAMLO-1-22	24	22	2	1454	1528	1618	1700	1788	1874	1962	2048	2178
	CTAMLO-1-27	29	27	2.5	1595	1688	1800	1903	2013	2120	2230	2338	2500
	CTAMLO-1-32	34	32	2.75	1840	1942	2066	2178	2299	2418	2539	2657	2836
	CTAMLO-1-42	44	42	3	2103	2214	2349	2472	2604	2733	2865	2994	3189
SETTEE 	CTAMLO-2	46	44	4	2105	2253	2433	2597	2773	2945	3121	3293	3553

HIGH TIDE METAL ARMLESS

	MODEL	W	SW	YARDS	COM	M	COL						W/WL
							O	P	R	S	T	U	
CHAIR H: 36.75 D: 28 SH: 18.5 SD: 19 BH: 20	 CTAMHI-1-22	24	22	2.25	1490	1573	1675	1767	1866	1963	2062	2158	2305
	CTAMHI-1-27	29	27	2.75	1608	1710	1834	1946	2067	2186	2307	2425	2604
	CTAMHI-1-32	34	32	3	1876	1987	2122	2245	2377	2506	2638	2767	2962
	CTAMHI-1-42	44	42	3.5	2134	2264	2421	2565	2719	2869	3023	3174	3401
SETTEE 	CTMHI-2	46	44	4.5	2177	2344	2546	2731	2929	3122	3320	3514	3806

PATIENT BACK TIDE METAL ARMLESS

	MODEL	W	SW	YARDS	COM	M	COL						W/WL
							O	P	R	S	T	U	
CHAIR H: 47.75 D: 28.75 SH: 18.5 SD: 20 BH: 30	 CTAMPT-1-22	24	22	3	1696	1807	1942	2065	2197	2326	2458	2587	2782
	CTAMPT-1-27	29	27	3.25	1854	1974	2121	2254	2397	2537	2680	2819	3031

TIDE METAL | SEAT OPTIONS

	DESCRIPTION	PRICE
CLEAN-OUT SEAT 	Standard on Tide seating. Allows for easier cleaning and has Wear Point Seat Rotation.	No Upcharge

	MODEL	DESCRIPTION	PRICE
ISLAND SEAT / ALL-SIDE CLEAN-OUT 	CI	All sides clean out. Includes Stainless Steel Covers.	91 LIST/SEAT

NOTE: Also available on System Seating shown on next page. Allows for easiest cleaning and has Wear Point Seat Rotation.



TIDE METAL | SOLID SURFACE ARM CAPS

SOLID SURFACE ARM CAPS



MODEL	GRADE		A	B	C	D
ACTMS	Stocked Solid Surface		NC	NC	36 LIST/PR	68 LIST/PR
	Non-stocked (per color, per order)	ADD	410 NET	450 NET	490 NET	520 NET

TIDE METAL | TABLET OPTIONS

ALL INTEGRA TABLETS HAVE A 300LB CAPACITY



CHOOSE POSITION

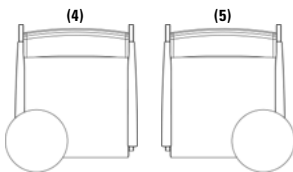

- (4) - Tablet on right as seated
- (5) - Tablet on left as seated

13" ROUND SOLID SURFACE TABLET OPTION

MODEL	GRADE		A	B	C	D
ST4-(4/5)	Stocked		613 LIST	636 LIST	668 LIST	722 LIST
	Non-stocked (per color, per order)	ADD	410 NET	450 NET	490 NET	520 NET

13" ROUND LAMINATE OVER PLYWOOD CORE/EDGE TABLET OPTION

MODEL	GRADE		PRICE
LT4-(4/5)	Stocked (Laminate tablets have a plywood edge. Specify finish.)		524 LIST
	Non-stocked (per color, per order)	ADD	50 NET

13" ROUND VENEER OVER PLYWOOD CORE/EDGE TABLET OPTION

MODEL	GRADE		PRICE
VT4-(4/5)	Standard Wood Finish		524 LIST
	Custom Finish (one time charge per color)	ADD	300 NET

TIDE METAL | OTHER OPTIONS

CONNECTING BRACKET



MODEL	DESCRIPTION	PRICE
CTMGB	Powder coat color must be specified	235 LIST

PRODUCT OPTIONS

MOISTURE BARRIER \$22 List / Yard
FIRE WALL / CA T.B. 133 \$82 List / Yard
TAMPER-RESISTANT FASTENERS \$51 List / Chair



COASTAL COLLECTION METAL | TIDE METAL SYSTEMS



CERTIFIED
CLEAN AIR GOLD



TIDE METAL SYSTEM ARMS

POWDER COATED STEEL

	MODEL	GRADE	A	B	C	D
TIDE METAL ARM (WITH ARM) W: 2 D: 26.5 H: 26	CTM()					
	AL/TS or AR/ST	Stocked Solid Surface	499 LIST	499 LIST	517 LIST	533 LIST
	SS	Stocked Solid Surface	529 LIST	529 LIST	547 LIST	563 LIST
		Non-Stocked (per color, per order)	ADD	410 NET	450 NET	490 NET



	MODEL	PRICE
TIDE METAL ARM (ARMLESS) W: 1 D: 26.5 H: 24.75	CTAM()	
	AL/TS or AR/ST	396
	SS	426



AL/TS: Arm Left/Table-to-Seat Connection, AR/ST: Arm Right/Seat-to-Table Connection, SS: Seat-to-Seat Connection

LOW TIDE SYSTEM SEATS

	MODEL	SW	YARDS	COM	M	COL O	P	R	S	T	U	W/WL
SINGLE SEAT SD: 19 BH: 16.5	CLT1	22	2	662	736	826	908	996	1082	1170	1256	1386
	CLT2	27	2.5	803	896	1008	1111	1221	1328	1438	1546	1708
	CLT3	32	2.75	1048	1150	1274	1386	1507	1626	1747	1865	2044
	CLT4	42	3	1311	1422	1557	1680	1812	1941	2073	2202	2397
DOUBLE SEAT	CLT12	44	4	1315	1463	1643	1807	1983	2155	2331	2503	2763



HIGH TIDE SYSTEM SEATS

	MODEL	SW	YARDS	COM	M	COL O	P	R	S	T	U	W/WL
SINGLE SEATS SD: 19 BH: 20	CHT1	22	2.25	698	781	883	975	1074	1171	1270	1366	1513
	CHT2	27	2.75	816	918	1042	1154	1275	1394	1515	1633	1812
	CHT3	32	3	1084	1195	1330	1453	1585	1714	1846	1975	2170
	CHT4	42	3.5	1342	1472	1629	1773	1927	2077	2231	2382	2609
DOUBLE SEAT	CHT12	44	4.5	1385	1552	1754	1939	2137	2330	2528	2722	3014



TIDE PATIENT SYSTEM SEATS

	MODEL	SW	YARDS	COM	M	COL O	P	R	S	T	U	W/WL
SINGLE SEATS SD: 20 BH: 30	CPT1	22	3	904	1015	1150	1273	1405	1534	1666	1795	1990
	CPT2	27	3.25	1062	1182	1329	1462	1605	1745	1888	2027	2239



PRODUCT OPTIONS

- MOISTURE BARRIER** \$22 List / Yard
- FIRE WALL / CA T.B. 133** \$82 List / Yard
- TAMPER-RESISTANT FASTENERS** \$51 List / Chair
- ARM CAPS, TABLETS, AND ISLAND SEAT OPTIONS** See pages CCM-14 and CCM-15.



TIDE METAL SOLID SURFACE SYSTEM TABLES

	MODEL	GRADE	A	B	C	D
END TABLE W: 21 D: 21 H: 15	CTM80-S	Stocked Solid Surface	1016 LIST	1101 LIST	1223 LIST	1417 LIST
		Non-stocked (per color, per order)	ADD 410 NET	450 NET	490 NET	520 NET



	MODEL	GRADE	A	B	C	D
IN-LINE TABLE W: 21 D: 21 H: 15	CTM81-S	Stocked Solid Surface	1057 LIST	1142 LIST	1264 LIST	1458 LIST
		Non-stocked (per color, per order)	ADD 410 NET	450 NET	490 NET	520 NET



	MODEL	GRADE	A	B	C	D
60° IN-LINE TABLE W: 27 D: 18 H: 15	CTM86-S	Stocked Solid Surface	1041 LIST	1126 LIST	1248 LIST	1442 LIST
		Non-stocked (per color, per order)	ADD 410 NET	450 NET	490 NET	520 NET



	MODEL	GRADE	A	B	C	D
90° TWO-WAY TABLE W: 27 D: 27 H: 15	CTM82-S	Stocked Solid Surface	1232 LIST	1326 LIST	1465 LIST	1684 LIST
		Non-stocked (per color, per order)	ADD 410 NET	450 NET	490 NET	520 NET



Allow 30" for 90° corner



TIDE METAL SEAT-TO-TABLE
CONNECTING BRACKETS ARE
INCLUDED IN TABLE PRICING ABOVE.



TIDE METAL SYSTEM SPECIFICATION

Integra systems are listed separately from the freestanding product of each series throughout this price list. The components are specific to the model and are all shown within the systems sections. Each system arm, system seat, and system table has a specific item number. System arms must have placement specified as shown below, and system tables must specify choice of edge and leg details.

WHEN SPECIFYING SYSTEMS, ALWAYS ITEMIZE COMPONENTS AS YOU STAND FACING THE CONFIGURATION. BEGIN YOUR LAYOUT AT THE LEFT AND END AT THE RIGHT.

The seat unit and table components are shown in each system area of this price list.

All System orders require a layout at the time of order. This is to ensure you are ordering all components necessary for that layout.

System arms use an alpha designation which describes their placement:

- SS** is for Seat-to-Seat Connection
- ST** is for Seat-to-Table Connection
- TS** is for Table-to-Seat Connection
- AR** is for Arm Right
- AL** is for Arm Left

EXAMPLES (in Tide series):

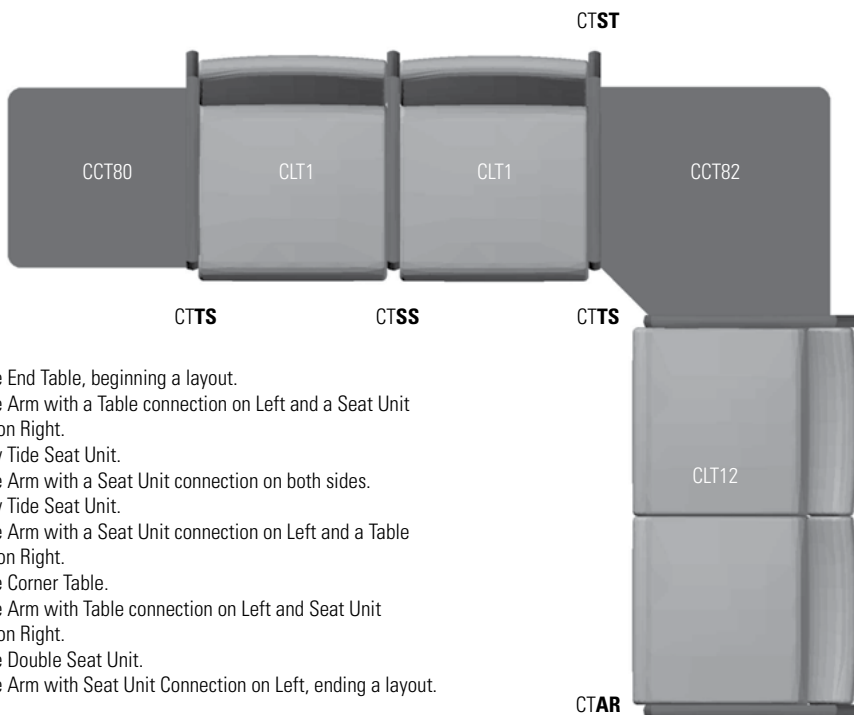

- CCT80** Coastal Tide End Table, beginning a layout.
- CTTS** Coastal Tide Arm with a Table connection on Left and a Seat Unit connection on Right.
- CLT1** Coastal Low Tide Seat Unit.
- CTSS** Coastal Tide Arm with a Seat Unit connection on both sides.
- CLT1** Coastal Low Tide Seat Unit.
- CTST** Coastal Tide Arm with a Seat Unit connection on Left and a Table connection on Right.
- CCT82** Coastal Tide Corner Table.
- CTTS** Coastal Tide Arm with Table connection on Left and Seat Unit connection on Right.
- CLT12** Coastal Tide Double Seat Unit.
- CTAR** Coastal Tide Arm with Seat Unit Connection on Left, ending a layout.

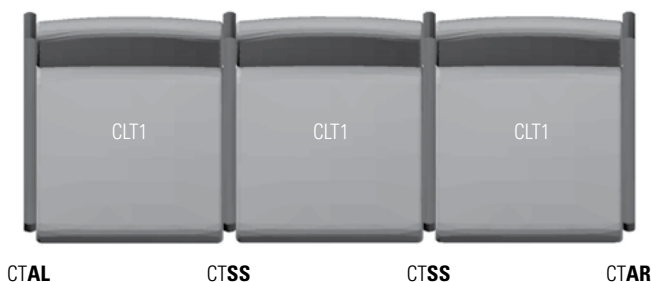

- CTAL** Coastal Tide Arm, beginning a layout, connecting to a Seat Unit on right.
- CLT1** Coastal Low Tide Seat Unit.
- CTSS** Coastal Tide Arm with a Seat Unit connection on both sides.
- CLT1** Coastal Low Tide Seat Unit.
- CTSS** Coastal Tide Arm with a Seat Unit connection on both sides.
- CLT1** Coastal Low Tide Seat Unit.
- CTAR** Coastal Tide Arm with Seat Unit Connection on Left, ending a layout.



TIDE FOOTSTOOL

	MODEL	H	YARDS	COM	M	COL						
						O	P	R	S	T	U	W/WL
FOOTSTOOL W: 19.25 D: 19.5	CTFS1	13.25	1.5	470	526	593	655	721	785	851	916	1013
	CTFS2	18	1.5	515	571	638	700	766	830	896	961	1058



	MODEL	DESCRIPTION	PRICE
RECESSED PULL HANDLE	RPH(B/G)	Specify Black (B) or Gray (G)	86 LIST



PRODUCT OPTIONS

MOISTURE BARRIER \$22 List / Yard
FIRE WALL / CA T.B. 133 \$82 List / Yard
WEIGHTED / THEFT DETERRENT \$305 List / 25 lb Weight

LOW TIDE REPLACEMENT BACK ONLY

	MODEL	SW	YARDS	COM	M	COL						
						O	P	R	S	T	U	W/WL
LOW TIDE SINGLE BACK	CLB1	22	1	292	329	374	415	459	502	546	589	654
	Cover Only	22	1	85	122	167	208	252	295	339	382	447
	CLB2	27	1.5	383	439	506	568	634	698	764	829	926
	Cover Only	27	1.5	128	184	251	313	379	443	509	574	671
	CLB3	32	1.5	462	518	585	647	713	777	843	908	1005
	Cover Only	32	1.5	128	184	251	313	379	443	509	574	671
	CLB4	42	1.5	569	625	692	754	820	884	950	1015	1112
	Cover Only	42	1.5	128	184	251	313	379	443	509	574	671



HIGH TIDE REPLACEMENT BACK ONLY

	MODEL	SW	YARDS	COM	M	COL						
						O	P	R	S	T	U	W/WL
HIGH TIDE SINGLE BACK	CHB1	22	1.25	328	374	431	482	537	591	646	699	781
	Cover Only	22	1.25	106	152	209	260	315	369	424	477	559
	CHB2	27	1.75	396	461	540	611	688	764	841	916	1030
	Cover Only	27	1.75	149	214	293	364	441	517	594	669	783
	CHB3	32	1.75	498	563	642	713	790	866	943	1018	1132
	Cover Only	32	1.75	149	214	293	364	441	517	594	669	783
	CHB4	42	2	600	674	764	846	934	1020	1108	1194	1324
	Cover Only	42	2	170	244	334	416	504	590	678	764	894



PATIENT TIDE REPLACEMENT BACK ONLY

	MODEL	SW	YARDS	COM	M	COL						
						O	P	R	S	T	U	W/WL
PATIENT TIDE SINGLE BACK	CPB1	22	2	534	608	698	780	868	954	1042	1128	1258
	Cover Only	22	2	170	244	334	416	504	590	678	764	894
	CPB2	27	2.25	642	725	827	919	1018	1115	1214	1310	1457
	Cover Only	27	2.25	191	274	376	468	567	664	763	859	1006





TIDE REPLACEMENT SEAT ONLY

	MODEL	SW	YARDS	COM	M	COL						W/WL
						O	P	R	S	T	U	
TIDE STANDARD SEAT 	CTS1	22	1	288	325	370	411	455	498	542	585	650
	Cover Only	22	1	85	122	167	208	252	295	339	382	447
	CTS2	27	1	328	365	410	451	495	538	582	625	690
	Cover Only	27	1	85	122	167	208	252	295	339	382	447
	CTS3	32	1.25	470	516	573	624	679	733	788	841	923
	Cover Only	32	1.25	106	152	209	260	315	369	424	477	559
	CTS4	42	1.5	595	651	718	780	846	910	976	1041	1138
	Cover Only	42	1.5	128	184	251	313	379	443	509	574	671

	MODEL	SW	YARDS	COM	M	COL						W/WL
						O	P	R	S	T	U	
TIDE ISLAND SEAT 	CIS1	22	1	288	325	370	411	455	498	542	585	650
	Cover Only	22	1	85	122	167	208	252	295	339	382	447
	CIS2	27	1	328	365	410	451	495	538	582	625	690
	Cover Only	27	1	85	122	167	208	252	295	339	382	447
	CIS3	32	1.25	470	516	573	624	679	733	788	841	923
	Cover Only	32	1.25	106	152	209	260	315	369	424	477	559
	CIS4	42	1.5	595	651	718	780	846	910	976	1041	1138
	Cover Only	42	1.5	128	184	251	313	379	443	509	574	671

MODEL	PRICE
ISLAND SEAT STAINLESS STEEL REPLACEMENT SLEEVES ONLY CTSLEEVES4	91 LIST/CHAIR

TIDE METAL | ARM CAP REPLACEMENTS

MODEL	GRADE	A	B	C	D
SOLID SURFACE ARM CAPS 	ACTMS Stocked Solid Surface	206 LIST/PR	206 LIST/PR	242 LIST/PR	274 LIST/PR
	Non-stocked (per color, per order) ADD	410 NET	450 NET	490 NET	520 NET



COASTAL COLLECTION METAL | BENCHES



CERTIFIED
CLEAN AIR GOLD

Healthier
Hospitals

COMPONENT-BASED
CONSTRUCTION

2K STATIC
CAPACITY

1K DROP
CAPACITY

COASTAL METAL BENCHES WITH SOLID SURFACE ARM CAPS

POWDER COATED STEEL

	MODEL	YARDS	COM	M	COL O	P	R	S	T	U	W/WL
44.25 BENCH W: 44.25 D: 21.25 H: 20.75 SW: 42 SD: 21 SH: 18.5	CBNM-7-42	2	1473	1547	1637	1719	1807	1893	1981	2067	2197
62.25 BENCH W: 62.25 SW: 60	CBNM-7-60	3	1791	1902	2037	2160	2292	2421	2553	2682	2877
74.25 BENCH W: 74.25 SW: 72	CBNM-7-72	3.5	1990	2120	2277	2421	2575	2725	2879	3030	3257

COASTAL METAL BENCHES | ARM CAPS

SOLID SURFACE ARM CAPS

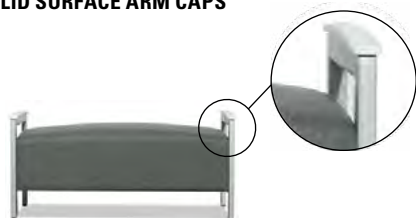

MODEL	GRADE	A	B	C	D
ACBMS	Stocked Solid Surface	NC	NC	38 LIST/PR	68LIST/PR
	Non-stocked (per color, per order)	ADD	410 NET	450 NET	490 NET 520 NET

COASTAL METAL BENCHES | OTHER OPTIONS

STAINLESS STEEL STAND-OFFS



Shown on Coastal Metal Bench

MODEL	DESCRIPTION	PRICE
SPANNERS	Adds 1.5" to seat width and overall width for cleanability	194 LIST/SET

SECURE BOTTOM COVERS



MODEL	SEAT WIDTH	PRICE
SBCCB42	42"	174 LIST
SBCCB60	60"	246 LIST
SBCCB72	72"	246 LIST

NOTE: Secure Bottom Covers include tamper-resistant fasteners.











PRODUCT OPTIONS

- MOISTURE BARRIER** \$22 List / Yard
- FIRE WALL / CA T.B. 133** \$82 List / Yard
- WEIGHTED / THEFT DETERRENT** \$305 List / 25 lb Weight
\$610 List / 50 lb Weight













METAL PEDESTAL BASE WITH SOLID SURFACE TOPS

POWDER COATED STEEL

		MODEL	GRADE	A	B	C	D
22 SQUARE x 17.5H W: 22 D: 22 H: 17.5		CMTPS-222217	Stocked .5"-thick Solid Surface	1026	1111	1232	1384
			Non-stocked (per color, per order)	ADD	410 NET	450 NET	490 NET
22 SQUARE x 20.5H W: 22 D: 22 H: 20.5		CMTPS-222220	Stocked .5"-thick Solid Surface	1026	1111	1232	1384
			Non-stocked (per color, per order)	ADD	410 NET	450 NET	490 NET
28 SQUARE x 17.5H W: 28 D: 28 H: 17.5		CMTPS-282817	Stocked .5"-thick Solid Surface	1387	1496	1657	1875
			Non-stocked (per color, per order)	ADD	410 NET	450 NET	490 NET
28 SQUARE x 20.5H W: 28 D: 28 H: 20.5		CMTPS-282820	Stocked .5"-thick Solid Surface	1387	1496	1657	1875
			Non-stocked (per color, per order)	ADD	410 NET	450 NET	490 NET
18 ROUND x 17.5H DIA: 18 H: 17.5		CMTPR-1817	Stocked .5"-thick Solid Surface	953	1029	1139	1313
			Non-stocked (per color, per order)	ADD	410 NET	450 NET	490 NET
18 ROUND x 20.5H DIA: 18 H: 20.5		CMTPR-1820	Stocked .5"-thick Solid Surface	953	1029	1139	1313
			Non-stocked (per color, per order)	ADD	410 NET	450 NET	490 NET
22 ROUND x 17.5H DIA: 22 H: 17.5		CMTPR-2217	Stocked .5"-thick Solid Surface	1026	1111	1232	1384
			Non-stocked (per color, per order)	ADD	410 NET	450 NET	490 NET
22 ROUND x 20.5H DIA: 22 H: 20.5		CMTPR-2220	Stocked .5"-thick Solid Surface	1026	1111	1232	1384
			Non-stocked (per color, per order)	ADD	410 NET	450 NET	490 NET
28 ROUND x 17.5H DIA: 28 H: 17.5		CMTPR-2817	Stocked .5"-thick Solid Surface	1387	1496	1657	1875
			Non-stocked (per color, per order)	ADD	410 NET	450 NET	490 NET
28 ROUND x 20.5H DIA: 28 H: 20.5		CMTPR-2820	Stocked .5"-thick Solid Surface	1387	1496	1657	1875
			Non-stocked (per color, per order)	ADD	410 NET	450 NET	490 NET



METAL CYLINDER LEGS WITH SOLID SURFACE TOPS

		MODEL	GRADE		A	B	C	D
22 SQUARE x 17.5H W: 22 D: 22 H: 17.5		CMTLS-222217	Stocked .5"-thick Solid Surface		1065	1150	1271	1423
			Non-stocked (per color, per order)	ADD	410 NET	450 NET	490 NET	520 NET
22 SQUARE x 20.5H W: 22 D: 22 H: 20.5		CMTLS-222220	Stocked .5"-thick Solid Surface		1065	1150	1271	1423
			Non-stocked (per color, per order)	ADD	410 NET	450 NET	490 NET	520 NET
28 SQUARE x 17.5H W: 28 D: 28 H: 17.5		CMTLS-222217	Stocked .5"-thick Solid Surface		1307	1416	1577	1795
			Non-stocked (per color, per order)	ADD	410 NET	450 NET	490 NET	520 NET
28 SQUARE x 20.5H W: 28 D: 28 H: 20.5		CMTLS-222220	Stocked .5"-thick Solid Surface		1307	1416	1577	1795
			Non-stocked (per color, per order)	ADD	410 NET	450 NET	490 NET	520 NET
18 ROUND x 17.5H DIA: 18 H: 17.5		CMTLR-1817	Stocked .5"-thick Solid Surface		992	1068	1178	1352
			Non-stocked (per color, per order)	ADD	410 NET	450 NET	490 NET	520 NET
18 ROUND x 20.5H DIA: 18 H: 20.5		CMTLR-1820	Stocked .5"-thick Solid Surface		992	1068	1178	1352
			Non-stocked (per color, per order)	ADD	410 NET	450 NET	490 NET	520 NET
22 ROUND x 17.5H DIA: 22 H: 17.5		CMTLR-2217	Stocked .5"-thick Solid Surface		1065	1150	1271	1423
			Non-stocked (per color, per order)	ADD	410 NET	450 NET	490 NET	520 NET
22 ROUND x 20.5H DIA: 22 H: 20.5		CMTLR-2220	Stocked .5"-thick Solid Surface		1065	1150	1271	1423
			Non-stocked (per color, per order)	ADD	410 NET	450 NET	490 NET	520 NET
28 ROUND x 17.5H DIA: 28 H: 17.5		CMTLR-2817	Stocked .5"-thick Solid Surface		1307	1416	1577	1795
			Non-stocked (per color, per order)	ADD	410 NET	450 NET	490 NET	520 NET
28 ROUND x 20.5H DIA: 28 H: 20.5		CMTLR-2820	Stocked .5"-thick Solid Surface		1307	1416	1577	1795
			Non-stocked (per color, per order)	ADD	410 NET	450 NET	490 NET	520 NET

COASTAL COLLECTION | WOOD

BAY WOOD	CCW 2 - 4
MARINA WOOD	CCW 5 - 6
MARINA UPHOLSTERED ARM WITH WOOD LEGS	CCW 7 - 9
MARINA / BAY OTTOMAN WITH WOOD LEGS	CCW 10
REEF ROCKER	CCW 11 - 12
REEF WOOD	CCW 13 - 14
REEF II WOOD WITH CLEAN-OUT	CCW 15 - 16
REEF UPHOLSTERED ARM WITH WOOD LEGS	CCW 17 - 18
TIDE WOOD	CCW 19 - 22
TIDE WOOD SYSTEM SEATING & TABLES	CCW 23 - 24
TIDE WOOD SYSTEM SPECIFICATIONS	CCW 25
TIDE FOOTSTOOLS	CCW 26
TIDE REPLACEMENT COMPONENTS/COVERS	CCW 27
COASTAL WOOD BENCHES	CCW 28



COASTAL COLLECTION WOOD | BAY WOOD



CERTIFIED
CLEAN AIR GOLD



COMPONENT-BASED
CONSTRUCTION

2K STATIC
CAPACITY

1K DROP
CAPACITY

BAY WOOD - WALL SAVER DESIGN

HARD MAPLE

	MODEL	BACK STYLE	YARDS	COM	M	COL O	P	R	S	T	U	W/WL
CHAIR - 22" SW W: 22 D: 29.5 H: 37 SW: 22 SD: 19 SH: 19 BH: 20	CBAY-1-22	Tapered	2.75	1238	1340	1464	1576	1697	1816	1937	2055	2234
	CBAYS-1-22	Straight	2.75	1238	1340	1464	1576	1697	1816	1937	2055	2234
CHAIR - 27" SW W: 27 SW: 27	CBAY-1-27	Tapered	3.25	1400	1520	1667	1800	1943	2083	2226	2365	2577
	CBAYS-1-27	Straight	3.25	1400	1520	1667	1800	1943	2083	2226	2365	2577
CHAIR - 32" SW W: 32 SW: 32	CBAY-1-32	Tapered	4	1646	1794	1974	2138	2314	2486	2662	2834	3094
	CBAYS-1-32	Straight	4	1646	1794	1974	2138	2314	2486	2662	2834	3094
CHAIR - 42" SW W: 42 SW: 42	CBAY-1-42	Tapered	4.5	1999	2166	2368	2553	2751	2944	3142	3336	3628
	CBAYS-1-42	Straight	4.5	1999	2166	2368	2553	2751	2944	3142	3336	3628
SETTEE W: 44 SW: 44	CBAYS-2	Straight	5.5	2290	2494	2741	2967	3209	3445	3687	3924	4281
SOFA W: 66 SW: 66	CBAYS-3	Straight	8.25	3342	3647	4019	4357	4720	5075	5438	5792	6329

BAY WOOD | LEG OPTIONS

	MODEL	DESCRIPTION	PRICE
WOOD LEGS 	CB4L	Wall Saver. Specify finish.	No Upcharge

	MODEL	DESCRIPTION	PRICE
5" HEAVY DUTY CASTERS 	5C1	Not Wall Saver. Set of 4 Locking Casters.	184 LIST/SET OF 4
		NOTE: Recommended for use with 22", 27", 32"sw only. When specified with Tablets on 22" and 27"sw, a 25lb weight is required and you must add \$305 to the list price.	

	MODEL	SEAT WIDTH	PRICE
PLINTH BASE INCLUDES SECURE BOTTOM COVERS 	PB-SBCPL	22"	210 LIST
		27"	306 LIST
		32"	470 LIST
		42"	765 LIST

NOTE: Secure Bottom Covers include tamper-resistant fasteners.

PLINTH BASE HDPE COLOR OPTIONS

Black, Charcoal, Gray, White



Powder Coat selection required for tablet post.

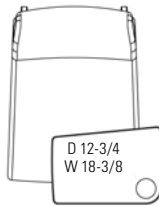
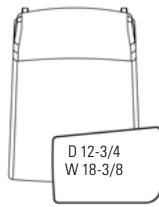

With Cup Holder option

CHOOSE POSITION

(4)



(5)



(4) - Tablet on right as seated

(5) - Tablet on left as seated

SOLID SURFACE TABLET OPTION

MODEL	GRADE		A	B	C	D
ST-(4/5)	Stocked		812 LIST	848 LIST	900 LIST	983 LIST
	Non-stocked (per color, per order)	ADD	410 NET	450NET	490 NET	520 NET

LAMINATE OVER PLYWOOD CORE/EDGE TABLET OPTION

MODEL	GRADE		PRICE
LT-(4/5)	Stocked (Laminate tablets have a plywood edge. Specify finish.)		637 LIST
	Non-stocked (per color, per order)	ADD	50 NET

VENEER OVER PLYWOOD CORE/EDGE TABLET OPTION

MODEL	GRADE		PRICE
VT-(4/5)	Standard Wood Finish		637 LIST
	Custom Finish (one time charge per color)	ADD	300 NET

CUP HOLDER

MODEL	FINISH	PRICE
CUPIN	Brushed Aluminum	216 LIST



BAY WOOD | OTHER OPTIONS

	MODEL	DESCRIPTION	PRICE
RECESSED PULL HANDLE	RPH(B/G)	For use with Casters option. Specify Black (B) or Gray (G).	86 LIST



	MODEL	SEAT WIDTH	PRICE
SECURE BOTTOM COVERS	SBC	22"	167 LIST
		27"	177 LIST
		32"	177 LIST
		42"	201 LIST



Shown on Marina Wood Arm

NOTE: Secure Bottom Covers include tamper-resistant fasteners.

PRODUCT OPTIONS

- MOISTURE BARRIER** \$22 List / Yard
- FIRE WALL / CA T.B. 133** \$82 List / Yard
- PERMA-COAT WOOD LEG PROTECTOR** \$35 List / Leg
- WEIGHTED / THEFT DETERRENT** \$305 List / 25 lb Weight
- \$610 List / 50 lb Weight



COASTAL COLLECTION WOOD | MARINA WOOD









CERTIFIED
CLEAN AIR GOLD



MARINA WOOD - WALL SAVER DESIGN

HARD MAPLE

	MODEL	BACK STYLE	YARDS	COM	M	COL	O	P	R	S	T	U	W/WL
CHAIR - 22" SW W: 25 D: 29.5 H: 37 SW: 22 SD: 19 SH: 19 BH: 20 AH: 26 	CMAR-1-22	Tapered	2.75	1734	1836	1960	2072	2193	2312	2433	2551	2730	
	CMARS-1-22	Straight	2.75	1734	1836	1960	2072	2193	2312	2433	2551	2730	
CHAIR - 27" SW W: 30 SW: 27 	CMAR-1-27	Tapered	3.25	1896	2016	2163	2296	2439	2579	2722	2861	3073	
	CMARS-1-27	Straight	3.25	1896	2016	2163	2296	2439	2579	2722	2861	3073	
CHAIR - 32" SW W: 35 SW: 32 	CMAR-1-32	Tapered	4	2142	2290	2470	2634	2810	2982	3158	3330	3590	
	CMARS-1-32	Straight	4	2142	2290	2470	2634	2810	2982	3158	3330	3590	
CHAIR - 42" SW W: 45 SW: 42 	CMAR-1-42	Tapered	4.5	2495	2662	2864	3049	3247	3440	3638	3832	4124	
	CMARS-1-42	Straight	4.5	2495	2662	2864	3049	3247	3440	3638	3832	4124	
SETTEE W: 47 SW: 44 	CMARS-2	Straight	5.5	2786	2990	3237	3463	3705	3941	4183	4420	4777	
SOFA W: 69 SW: 66 	CMARS-3	Straight	8.25	3838	4143	4515	4853	5216	5571	5934	6288	6825	

MARINA WOOD | ARM CAP OPTIONS

	MODEL	GRADE	A	B	C	D
SOLID SURFACE ARM CAPS 	ACMS	Stocked Solid Surface	372 LIST/PR	372 LIST/PR	410 LIST/PR	438 LIST/PR
		Non-stocked (per color, per order)	ADD 410 NET	450 NET	490 NET	520 NET

	MODEL	DESCRIPTION	PRICE
URETHANE ARM CAPS 	ACT2U	Available in Black, Ginger, Nutmeg, Mocha, and Saffron	206 LIST/PR



CHOOSE POSITION

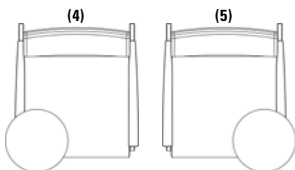

(4) - Tablet on right as seated

(5) - Tablet on left as seated

13" ROUND SOLID SURFACE TABLET OPTION

MODEL	GRADE		A	B	C	D
ST4-(4/5)	Stocked		613 LIST	636 LIST	668 LIST	722 LIST
	Non-stocked (per color, per order)	ADD	410 NET	450 NET	490 NET	520 NET

13" ROUND LAMINATE OVER PLYWOOD CORE/EDGE TABLET OPTION

MODEL	GRADE		PRICE
LT4-(4/5)	Stocked (Laminate tablets have a plywood edge. Specify finish.)		524 LIST
	Non-stocked (per color, per order)	ADD	50 NET

13" ROUND VENEER OVER PLYWOOD CORE/EDGE TABLET OPTION

MODEL	GRADE		PRICE
VT4-(4/5)	Standard Wood Finish		524 LIST
	Custom Finish (one time charge per color)	ADD	300 NET

MARINA WOOD | OTHER OPTIONS

STAINLESS STEEL STAND-OFFS

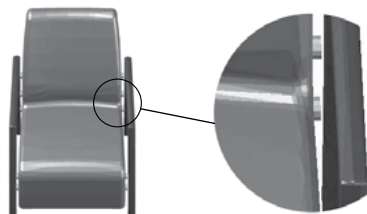

MODEL	DESCRIPTION	PRICE
SPANNERS	Adds 1.5" to seat width and overall width for cleanability	233 LIST/SET

SECURE BOTTOM COVERS



MODEL	SEAT WIDTH	PRICE
SBC	22"	167 LIST
	27"	177 LIST
	32"	177 LIST
	42"	201 LIST







NOTE: Secure Bottom Covers include tamper-resistant fasteners.

PRODUCT OPTIONS

- MOISTURE BARRIER \$22 List / Yard
- FIRE WALL / CA T.B. 133 \$82 List / Yard
- PERMA-COAT WOOD LEG PROTECTOR \$35 List / Leg
- WEIGHTED / THEFT DETERRENT \$305 List / 25 lb Weight
- \$610 List / 50 lb Weight



MARINA UPHOLSTERED ARM WITH WOOD LEGS - WALL SAVER DESIGN

	MODEL	BACK STYLE	YARDS	COM	M	COL							W/WL
						O	P	R	S	T	U		
CHAIR - 22" SW W: 30 D: 29.5 H: 37 SW: 22 SD: 19 SH: 19 BH: 20 AH: 26		CMU-1-22	Tapered	5.25	1992	2186	2423	2638	2869	3095	3326	3551	3893
	CMUS-1-22	Straight	5.25	1992	2186	2423	2638	2869	3095	3326	3551	3893	
CHAIR - 27" SW W: 35 SW: 27		CMU-1-27	Tapered	5.75	2154	2367	2626	2861	3114	3362	3615	3862	4236
	CMUS-1-27	Straight	5.75	2154	2367	2626	2861	3114	3362	3615	3862	4236	
CHAIR - 32" SW W: 40 SW: 32		CMU-1-32	Tapered	6.5	2400	2641	2933	3200	3486	3765	4051	4331	4753
	CMUS-1-32	Straight	6.5	2400	2641	2933	3200	3486	3765	4051	4331	4753	
CHAIR - 42" SW W: 50 SW: 42		CMU-1-42	Tapered	7	2753	3012	3327	3614	3922	4223	4531	4832	5287
	CMUS-1-42	Straight	7	2753	3012	3327	3614	3922	4223	4531	4832	5287	
SETTEE W: 52 SW: 44		CMUS-2	Straight	8	3044	3340	3700	4028	4380	4724	5076	5420	5940
	SOFA W: 74 SW: 66		CMUS-3	Straight	10.75	4096	4494	4978	5418	5891	6354	6827	7289

MARINA UPHOLSTERED ARM | ARM CAP OPTIONS

MODEL	GRADE	A	B	C	D	
		SOLID SURFACE ARM CAPS	ACMUS	Stocked Solid Surface	460 LIST/PR	460 LIST/PR
		Non-stocked (per color, per order)	ADD 410 NET	450 NET	490 NET	520 NET

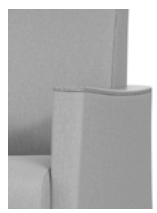

MODEL	DESCRIPTION	PRICE	
WOOD ARM CAPS	ACMM	Solid Wood. Specify finish.	316 LIST/PR





Tablets available in Upholstered Arms with and without Arm Caps.



With Cup Holder Option

CHOOSE POSITION

(4)

(5)

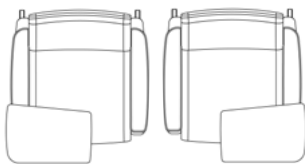

(4) - Tablet on right as seated

(5) - Tablet on left as seated

SOLID SURFACE TABLET OPTION

MODEL	GRADE		A	B	C	D
ST-(4/5)	Stocked		723 LIST	759 LIST	811 LIST	894 LIST
	Non-stocked (per color, per order)	ADD	410 NET	450 NET	490 NET	520 NET

LAMINATE OVER PLYWOOD CORE/EDGE TABLET OPTION

MODEL	GRADE		PRICE
LT-(4/5)	Stocked (Laminate tablets have a plywood edge. Specify finish.)		548 LIST
	Non-stocked (per color, per order)	ADD	50 NET

VENEER OVER PLYWOOD CORE/EDGE TABLET OPTION

MODEL	GRADE		PRICE
VT-(4/5)	Standard Wood Finish		548 LIST
	Custom Finish (one time charge per color)	ADD	300 NET

CUP HOLDER

MODEL	FINISH	PRICE
CUPIN	Brushed Aluminum	216 LIST



MARINA UPHOLSTERED ARM | OTHER OPTIONS

	MODEL	DESCRIPTION	PRICE
STAINLESS STEEL STAND-OFFS	SPANNERS	Adds 1.5" to seat width and overall width for cleanability	233 LIST/SET

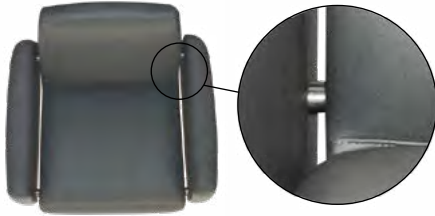

	MODEL	SEAT WIDTH	PRICE
SECURE BOTTOM COVERS	SBC	22"	167 LIST
		27"	177 LIST
		32"	177 LIST
		42"	201 LIST

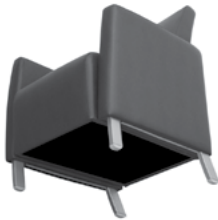

NOTE: Secure Bottom Covers include tamper-resistant fasteners.

	MODEL	SEAT WIDTH	PRICE
PLINTH BASE INCLUDES SECURE BOTTOM COVERS	CB22PB	22"	210 LIST
	CB27PB	27"	306 LIST
	CB32PB	32"	470 LIST
	CB42PB	42"	765 LIST



NOTE: Secure Bottom Covers include tamper-resistant fasteners.

PLINTH BASE HDPE COLOR OPTIONS

Black, Charcoal, Gray, White

PRODUCT OPTIONS

- MOISTURE BARRIER** \$22 List / Yard
- FIRE WALL / CA T.B. 133** \$82 List / Yard
- PERMA-COAT WOOD LEG PROTECTOR** \$35 List / Leg
- WEIGHTED / THEFT DETERRENT** \$305 List / 25 lb Weight
\$610 List / 50 lb Weight



MARINA / BAY OTTOMAN WITH WOOD LEGS

	MODEL	YARDS	COM	M	COL							
					O	P	R	S	T	U	W / WL	
OTTOMAN WITH WOOD LEGS	CMOT1	1.5	811	867	934	996	1062	1126	1192	1257	1354	

W: 22 H: 14-18

D: 24



MARINA / BAY OTTOMAN WITH WOOD LEGS | OTHER OPTIONS

	MODEL	PRICE
SECURE BOTTOM COVERS	SBC Marina / Bay Ottoman	191 LIST

NOTE: Secure Bottom Covers include tamper-resistant fasteners.

PRODUCT OPTIONS

- MOISTURE BARRIER** \$22 List / Yard
- FIRE WALL / CA T.B. 133** \$82 List / Yard
- PERMA-COAT WOOD LEG PROTECTOR** \$35 List / Leg
- WEIGHTED / THEFT DETERRENT** \$305 List / 25 lb Weight



COASTAL COLLECTION WOOD | REEF ROCKER



CERTIFIED
CLEAN AIR GOLD



REEF ROCKER

MOTION SEATING

	MODEL	BACK STYLE	YARDS	COM	M	COL	P	R	S	T	U	W/WL
CHAIR - 24" SW	RFRK-1-24	Tapered	6	2557	2779	3049	3295	3559	3817	4081	4339	4729
W: 34 D: 32.5 H: 37	RFRKC-1-24	Tapered	6	2557	2779	3049	3295	3559	3817	4081	4339	4729
SW: 24 SD: 21 SH: 17.5	RFRKS-1-24	Straight	6	2557	2779	3049	3295	3559	3817	4081	4339	4729
BH: 23 AH: 25.5	RFRKSC-1-24	Straight	6	2557	2779	3049	3295	3559	3817	4081	4339	4729



Standard
(RFRK or RFRKS)



Clean Out
(RFRKC or RFRKSC)

REEF ROCKER | BASE OPTIONS

	MODEL	DESCRIPTION	PRICE
PLYWOOD ROCKER BASE	RFRCKRW	Standard Wood Finish	No Upcharge
		Custom Finish (one time charge per color)	ADD 300 NET



	MODEL	DESCRIPTION	PRICE
HDPE ROCKER BASE	RFRCKRB	Black HDPE	No Upcharge
	RFRCKRG	Gray HDPE	No Upcharge



REEF ROCKER | ARM CAP OPTIONS

	MODEL	GRADE	A	B	C	D
SOLID SURFACE ARM CAPS	ACRFUS	Stocked Solid Surface	460 LIST/PR	460 LIST/PR	580 LIST/PR	702 LIST/PR
		Non-stocked (per color, per order)	ADD 410 NET	450 NET	490 NET	520 NET



	MODEL	DESCRIPTION	PRICE
WOOD ARM CAPS	ACRFM	Standard Wood Finish	346 LIST/PR
		Custom Finish (one time charge per color)	ADD 300 NET





	MODEL	SEAT WIDTH	PRICE
SECURE BOTTOM COVERS	SBCRF24	24"	142 LIST



Shown on Marina Wood Chair

NOTE: Secure Bottom Covers include tamper-resistant fasteners.

PRODUCT OPTIONS

- MOISTURE BARRIER** \$22 List / Yard
- FIRE WALL / CA T.B. 133** \$82 List / Yard



COASTAL COLLECTION WOOD | REEF WOOD







CERTIFIED
CLEAN AIR GOLD



REEF WOOD

HARD MAPLE

	MODEL	BACK STYLE	YARDS	COM	M	COL	O	P	R	S	T	U	W/WL
CHAIR - 24" SW W: 27 D: 29.5 H: 37.5 SW: 24 SD: 21 SH: 17.5 BH: 23 AH: 24.5		CRF-1-24	Tapered	3.5	2205	2335	2492	2636	2790	2940	3094	3245	3472
		CRFS-1-24	Straight	3.5	2205	2335	2492	2636	2790	2940	3094	3245	3472
CHAIR - 44" SW W: 47 SW: 44		CRF-1-44	Tapered	4.5	3052	3219	3421	3606	3804	3997	4195	4389	4681
		CRFS-1-44	Straight	4.5	3052	3219	3421	3606	3804	3997	4195	4389	4681
SETTEE W: 51 SW: 48		CRFS-2	Straight	7	3694	3953	4268	4555	4863	5164	5472	5773	6228
SOFA W: 75 SW: 72		CRFS-3	Straight	10.5	5183	5572	6044	6475	6937	7388	7850	8302	8984

REEF WOOD | ARM CAP OPTIONS

	MODEL	GRADE	A	B	C	D
SOLID SURFACE ARM CAPS 	ACRFS	Stocked Solid Surface	344 LIST/PR	358 LIST/PR	380 LIST/PR	416 LIST/PR
		Non-stocked (per color, per order)	ADD 410 NET	450 NET	490 NET	520 NET

	MODEL	DESCRIPTION	PRICE
URETHANE ARM CAPS 	ACRU	Available in Black, Ginger, Nutmeg, Mocha, and Saffron	246 LIST/PR



REEF WOOD | OTHER OPTIONS

	MODEL	DESCRIPTION	PRICE
STAINLESS STEEL STAND-OFFS	SPANNERS	Adds 1.5" to seat width and overall width for cleanability	233 LIST/SET

	MODEL	SEAT WIDTH	PRICE
SECURE BOTTOM COVERS	SBC	24"	142 LIST
		44"	176 LIST



Shown on Marina Wood Chair

NOTE: Secure Bottom Covers include tamper-resistant fasteners.

PRODUCT OPTIONS

- MOISTURE BARRIER** \$22 List / Yard
- FIRE WALL / CA T.B. 133** \$82 List / Yard
- PERMA-COAT WOOD LEG PROTECTOR** \$35 List / Leg
- WEIGHTED / THEFT DETERRENT** \$305 List / 25 lb Weight
\$610 List / 50 lb Weight



COASTAL COLLECTION WOOD | REEF II WOOD



CERTIFIED
CLEAN AIR GOLD

Healthier
Hospitals

COMPONENT-BASED
CONSTRUCTION

2K STATIC
CAPACITY

1K DROP
CAPACITY

REEF II WOOD WITH CLEAN-OUT

HARD MAPLE

CHAIR - 24" SW

W: 27.5 D: 32 H: 36.5
SW: 24 SD: 21 SH: 17.5
BH: 23 AH: 24.5



MODEL	BACK STYLE	YARDS	COM	M	COL	O	P	R	S	T	U	W/WL
CRF-1-24	Tapered	3.5	2205	2335	2492	2636	2790	2940	3094	3245	3472	
CRFS-1-24	Straight	3.5	2205	2335	2492	2636	2790	2940	3094	3245	3472	

CHAIR - 44" SW

W: 47.5
SW: 44



CRF-1-44	Tapered	4.5	3052	3219	3421	3606	3804	3997	4195	4389	4681	
CRFS-1-44	Straight	4.5	3052	3219	3421	3606	3804	3997	4195	4389	4681	

SETTEE

W: 51.5
SW: 48



CRFS-2	Straight	7	3694	3953	4268	4555	4863	5164	5472	5773	6228	
--------	----------	---	------	------	------	------	------	------	------	------	------	--

SOFA

W: 75.5
SW: 72

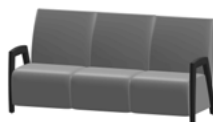

CRFS-3	Straight	10.5	5183	5572	6044	6475	6937	7388	7850	8302	8984	
--------	----------	------	------	------	------	------	------	------	------	------	------	--



Reef Standard Arm



Reef II Clean-Out Arm

REEF II WOOD WITH CLEAN-OUT | ARM CAP OPTIONS

SOLID SURFACE ARM CAPS



MODEL	GRADE	A	B	C	D
ACRFS	Stocked Solid Surface	344 LIST/PR	358 LIST/PR	380 LIST/PR	416 LIST/PR
	Non-stocked (per color, per order)	ADD 410 NET	450 NET	490 NET	520 NET



REEF II WOOD WITH CLEAN-OUT | OTHER OPTIONS

	MODEL	DESCRIPTION	PRICE
STAINLESS STEEL STAND-OFFS	SPANNERS	Adds 1.5" to seat width and overall width for cleanability	233 LIST/SET

	MODEL	SEAT WIDTH	PRICE
SECURE BOTTOM COVERS	SBC	24"	142 LIST
		44"	176 LIST



Shown on Marina Wood Chair

NOTE: Secure Bottom Covers include tamper-resistant fasteners.

PRODUCT OPTIONS

- MOISTURE BARRIER** \$22 List / Yard
- FIRE WALL / CA T.B. 133** \$82 List / Yard
- PERMA-COAT WOOD LEG PROTECTOR** \$35 List / Leg
- WEIGHTED / THEFT DETERRENT** \$305 List / 25 lb Weight
- \$610 List / 50 lb Weight



COASTAL COLLECTION WOOD | REEF WOOD



CERTIFIED
CLEAN AIR GOLD



REEF UPHOLSTERED ARM WITH WOOD LEGS

HARD MAPLE

CHAIR - 24" SW

W: 34 D: 32.5 H: 37
SW: 24 SD: 21 SH: 17.5
BH: 23 AH: 24.5



MODEL	BACK STYLE	YARDS	COM	M	COL								W/WL
					O	P	R	S	T	U			
CRFU-1-24	Tapered	6	2557	2779	3049	3295	3559	3817	4081	4339	4729		
CRFUC-1-24	Tapered	6	2557	2779	3049	3295	3559	3817	4081	4339	4729		
CRFUS-1-24	Straight	6	2557	2779	3049	3295	3559	3817	4081	4339	4729		
CRFUCS-1-24	Straight	6	2557	2779	3049	3295	3559	3817	4081	4339	4729		

CHAIR - 44" SW

W: 54
SW: 44



CRFU-1-44	Tapered	7	3404	3663	3978	4265	4573	4874	5182	5483	5938	
CRFUC-1-44	Tapered	7	3404	3663	3978	4265	4573	4874	5182	5483	5938	
CRFUS-1-44	Straight	7	3404	3663	3978	4265	4573	4874	5182	5483	5938	
CRFUCS-1-44	Straight	7	3404	3663	3978	4265	4573	4874	5182	5483	5938	

SETTEE

W: 58
SW: 48



CRFUS-2	Straight	9.5	4046	4398	4825	5215	5633	6041	6459	6868	7485	
CRFUCS-2	Straight	9.5	4046	4398	4825	5215	5633	6041	6459	6868	7485	

SOFA

W: 82
SW: 72



CRFUS-3	Straight	13	5535	6016	6601	7134	7706	8265	8837	9396	10241	
CRFUCS-3	Straight	13	5535	6016	6601	7134	7706	8265	8837	9396	10241	

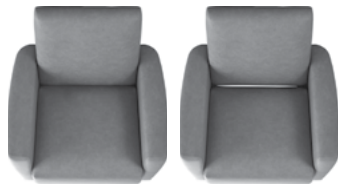

Standard
(CRFU or CRFUS)

Clean-Out
(CRFUC or CRFUCS)

REEF UPHOLSTERED ARM | ARM CAP OPTIONS

SOLID SURFACE ARM CAPS

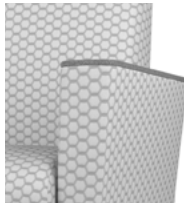

MODEL	GRADE	A	B	C	D
ACRFUS	Stocked Solid Surface	460 LIST/PR	460 LIST/PR	580 LIST/PR	702 LIST/PR
	Non-stocked (per color, per order)	ADD	410 NET	450 NET	490 NET

WOOD ARM CAPS



MODEL	DESCRIPTION	PRICE
ACRFM	Solid Wood. Specify finish.	346 LIST/PR



REEF UPHOLSTERED ARM | TABLET OPTIONS

ALL INTEGRA TABLETS HAVE A 300LB CAPACITY



Tablets available in Upholstered Arms with and without Arm Caps.

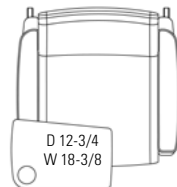

With Cup Holder Option

CHOOSE POSITION

(4)

(5)



(4) - Tablet on right as seated

(5) - Tablet on left as seated

SOLID SURFACE TABLET OPTION

MODEL	GRADE	A	B	C	D
ST-(4/5)	Stocked	723 LIST	759 LIST	811 LIST	894 LIST
	Non-stocked (per color, per order)	ADD 410 NET	450 NET	490 NET	520 NET

LAMINATE OVER PLYWOOD CORE/EDGE TABLET OPTION

MODEL	GRADE	PRICE
LT-(4/5)	Stocked (Laminate tablets have a plywood edge. Specify finish.)	548 LIST
	Non-stocked (per color, per order)	ADD 50 NET

VENEER OVER PLYWOOD CORE/EDGE TABLET OPTION

MODEL	GRADE	PRICE
VT-(4/5)	Standard Wood Finish	548 LIST
	Custom Finish (one time charge per color)	ADD 300 NET

CUP HOLDER

MODEL	FINISH	PRICE
CUPIN	Brushed Aluminum	216 LIST

REEF UPHOLSTERED ARM | OTHER OPTIONS

SECURE BOTTOM COVERS



Shown on Marina Upholstered Arm Chair

MODEL	SEAT WIDTH	PRICE
SBC	24"	142 LIST
	44"	176 LIST

NOTE: Secure Bottom Covers include tamper-resistant fasteners.

PRODUCT OPTIONS

- MOISTURE BARRIER \$22 List / Yard
- FIRE WALL / CA T.B. 133 \$82 List / Yard
- PERMA-COAT WOOD LEG PROTECTOR \$35 List / Leg
- WEIGHTED / THEFT DETERRENT \$305 List / 25 lb Weight
- \$610 List / 50 lb Weight



COASTAL COLLECTION WOOD | TIDE WOOD



CERTIFIED
CLEAN AIR GOLD





COMPONENT-BASED
CONSTRUCTION

2K STATIC
CAPACITY



1K DROP
CAPACITY

LOW TIDE WOOD - WALL SAVER DESIGN



CLEAN-OUT SEAT DESIGN

		MODEL	W	SW	YARDS	COM	M	COL O	P	R	S	T	U	W/WL
CHAIR H: 33 D: 27 SH: 18.5 SD: 19 BH: 16.5 AH: 16		CTLO-1-22	25	22	2	1454	1528	1618	1700	1788	1874	1962	2048	2178
		CTLO-1-27	30	27	2.5	1595	1688	1800	1903	2013	2120	2230	2338	2500
		CTLO-1-32	35	32	2.75	1840	1942	2066	2178	2299	2418	2539	2657	2836
		CTLO-1-42	45	42	3	2103	2214	2349	2472	2604	2733	2865	2994	3189
SETTEE		CTLO-2	47	44	4	2105	2253	2433	2597	2773	2945	3121	3293	3553
ORTHO HEIGHT CHAIR H: 39.5 D: 28.25 SH: 24.5 AH: 31.5		CTLOOR-1-22	25	22	2	1823	1897	1987	2069	2157	2243	2331	2417	2547
		CTLOOR-1-27	30	27	2.5	2025	2118	2230	2333	2443	2550	2660	2768	2930
		CTLOOR-1-32	35	32	2.75	2319	2421	2545	2657	2778	2897	3018	3136	3315

HIGH TIDE WOOD



		MODEL	W	SW	YARDS	COM	M	COL O	P	R	S	T	U	W/WL
CHAIR H: 36.5 D: 27 SH: 18.5 SD: 19 BH: 20 AH: 16		CTHI-1-22	25	22	2.25	1490	1573	1675	1767	1866	1963	2062	2158	2305
		CTHI-1-27	30	27	2.75	1608	1710	1834	1946	2067	2186	2307	2425	2604
		CTHI-1-32	35	32	3	1876	1987	2122	2245	2377	2506	2638	2767	2962
		CTHI-1-42	45	42	3.5	2134	2264	2421	2565	2719	2869	3023	3174	3401
SETTEE		CTHI-2	47	44	4.5	2177	2344	2546	2731	2929	3122	3320	3514	3806
ORTHO HEIGHT CHAIR H: 42.5 D: 28.75 SH: 24.5 AH: 31.5		CTHIOR-1-22	25	22	2.25	1859	1942	2044	2136	2235	2332	2431	2527	2674
		CTHIOR-1-27	30	27	2.75	2038	2140	2264	2376	2497	2616	2737	2855	3034
		CTHIOR-1-32	35	32	3	2355	2466	2601	2724	2856	2985	3117	3246	3441

PATIENT BACK TIDE WOOD



		MODEL	W	SW	YARDS	COM	M	COL O	P	R	S	T	U	W/WL
CHAIR H: 48 D: 28 SH: 18.5 SD: 20 BH: 30 AH: 26		CTPT-1-22	25	22	3	1696	1807	1942	2065	2197	2326	2458	2587	2782
		CTPT-1-27	30	27	3.25	1854	1974	2121	2254	2397	2537	2680	2819	3031
ORTHO HEIGHT CHAIR H: 53.5 D: 29.5 SH: 24.5 AH: 31.5		CTPTOR-1-22	25	22	3	2065	2176	2311	2434	2566	2695	2827	2956	3151
		CTPTOR-1-27	30	27	3.25	2284	2404	2551	2684	2827	2967	3110	3249	3461



LOW TIDE WOOD ARMLESS - WALL SAVER DESIGN

	MODEL	W	SW	YARDS	COM	M	COL O	P	R	S	T	U	W/WL	
CHAIR H: 33 D: 27 SH: 18.5 SD: 19 BH: 16.5		CTALO-1-22	25	22	2	1454	1528	1618	1700	1788	1874	1962	2048	2178
		CTALO-1-27	30	27	2.5	1595	1688	1800	1903	2013	2120	2230	2338	2500
		CTALO-1-32	35	32	2.75	1840	1942	2066	2178	2299	2418	2539	2657	2836
		CTALO-1-42	45	42	3	2103	2214	2349	2472	2604	2733	2865	2994	3189
SETTEE 	CTALO-2	47	44	4	2105	2253	2433	2597	2773	2945	3121	3293	3553	

HIGH TIDE WOOD ARMLESS

	MODEL	W	SW	YARDS	COM	M	COL O	P	R	S	T	U	W/WL	
CHAIR H: 36.5 D: 27 SH: 18.5 SD: 19 BH: 20		CTAHI-1-22	25	22	2.25	1490	1573	1675	1767	1866	1963	2062	2158	2305
		CTAHI-1-27	30	27	2.75	1608	1710	1834	1946	2067	2186	2307	2425	2604
		CTAHI-1-32	35	32	3	1876	1987	2122	2245	2377	2506	2638	2767	2962
		CTAHI-1-42	45	42	3.5	2134	2264	2421	2565	2719	2869	3023	3174	3401
SETTEE 	CTAHI-2	47	44	4.5	2177	2344	2546	2731	2929	3122	3320	3514	3806	

PATIENT BACK TIDE WOOD ARMLESS

	MODEL	W	SW	YARDS	COM	M	COL O	P	R	S	T	U	W/WL	
CHAIR H: 48 D: 28 SH: 18.5 SD: 20 BH: 30		CTAPT-1-22	25	22	3	1696	1807	1942	2065	2197	2326	2458	2587	2782
		CTAPT-1-27	30	27	3.25	1854	1974	2121	2254	2397	2537	2680	2819	3031

TIDE WOOD | SEAT OPTIONS

	DESCRIPTION	PRICE
CLEAN-OUT SEAT 	Standard on Tide seating. Allows for easier cleaning and has Wear Point Seat Rotation.	No Upcharge

	MODEL	DESCRIPTION	PRICE
ISLAND SEAT / ALL-SIDE CLEAN-OUT 	CI	All sides clean out. Includes Stainless Steel Covers.	91 LIST/SEAT

NOTE: Also available on System Seating shown on next page. Allows for easiest cleaning and has Wear Point Seat Rotation.



TIDE WOOD | ARM CAP OPTIONS

SOLID SURFACE ARM CAPS



MODEL	GRADE	A	B	C	D
ACTS	Stocked Solid Surface	372 LIST/PR	372 LIST/PR	410 LIST/PR	438 LIST/PR
	Non-stocked (per color, per order)	ADD 410 NET	450 NET	490 NET	520 NET

URETHANE ARM CAPS



MODEL	DESCRIPTION	PRICE
ACTU	Available in Black, Ginger, Nutmeg, Mocha, and Saffron	206 LIST/PR

TIDE WOOD | TABLET OPTIONS

ALL INTEGRA TABLETS HAVE A 300LB CAPACITY

Available on all Tide Wood Arms, Freestanding and Systems.

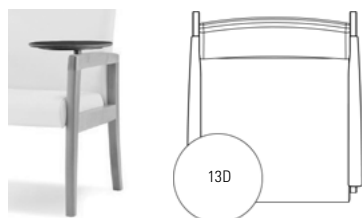

CHOOSE POSITION

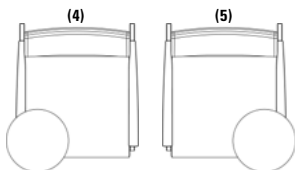

(4) - Tablet on right as seated

(5) - Tablet on left as seated

13" ROUND SOLID SURFACE TABLET OPTION

MODEL	GRADE	A	B	C	D
ST4-(4/5)	Stocked	613 LIST	636 LIST	668 LIST	722 LIST
	Non-stocked (per color, per order)	ADD 410 NET	450 NET	490 NET	520 NET

13" ROUND LAMINATE OVER PLYWOOD CORE/EDGE TABLET OPTION

MODEL	GRADE	PRICE
LT4-(4/5)	Stocked (Laminate tablets have a plywood edge. Specify finish.)	524 LIST
	Non-stocked (per color, per order)	ADD 50 NET

13" ROUND VENEER OVER PLYWOOD CORE/EDGE TABLET OPTION

MODEL	GRADE	PRICE
VT4-(4/5)	Standard Wood Finish	524 LIST
	Custom Finish (one time charge per color)	ADD 300 NET



TIDE WOOD | OTHER OPTIONS

2" CASTERS



MODEL	DESCRIPTION	PRICE
415C	Available on 22" and 27"-wide chairs ONLY. Set of 4 Locking Casters.	136 LIST/SET OF 4

CONNECTING BRACKET



Shown on Tide Metal

MODEL	DESCRIPTION	PRICE
CTMGB	Powder Coat color must be specified	235 LIST

PRODUCT OPTIONS

- MOISTURE BARRIER** \$22 List / Yard
- FIRE WALL / CA T.B. 133** \$82 List / Yard
- TAMPER-RESISTANT FASTENERS** \$51 List / Chair
- PERMA-COAT WOOD LEG PROTECTOR** \$35 List / Leg



COASTAL COLLECTION WOOD | TIDE WOOD SYSTEMS

TIDE WOOD SYSTEM ARMS

HARD MAPLE

TIDE WOOD ARM (WITH ARM)

W: 1.5
D: 26
H: 26



MODEL		PRICE
CT(_)		
AL/TS or AR/ST	Arm Left (AL)/Table-to-Seat Connection (TS) or Arm Right (AR)/Seat-to-Table Connection (ST)	396 LIST
SS	Seat-to-Seat Connection (SS)	426 LIST

TIDE WOOD ARM (ARMLESS)

W: 1.5
D: 26
H: 24.5



MODEL		PRICE
CTA(_)		
AL/TS or AR/ST	Arm Left (AL)/Table-to-Seat Connection (TS) or Arm Right (AR)/Seat-to-Table Connection (ST)	396 LIST
SS	Seat-to-Seat Connection (SS)	426 LIST

LOW TIDE SYSTEM SEATS

SINGLE SEAT

SD: 19 BH: 16.5



MODEL	SW	YARDS	COM	M	COL								W/WL
					O	P	R	S	T	U			
CLT1	22	2	662	736	826	908	996	1082	1170	1256	1386		
CLT2	27	2.5	803	896	1008	1111	1221	1328	1438	1546	1708		
CLT3	32	2.75	1048	1150	1274	1386	1507	1626	1747	1865	2044		
CLT4	42	3	1311	1422	1557	1680	1812	1941	2073	2202	2397		

DOUBLE SEAT



CLT12	44	4	1315	1463	1643	1807	1983	2155	2331	2503	2763
-------	----	---	------	------	------	------	------	------	------	------	------

HIGH TIDE SYSTEM SEATS

SINGLE SEATS

SD: 19 BH: 20



MODEL	SW	YARDS	COM	M	COL								W/WL
					O	P	R	S	T	U			
CHT1	22	2.25	698	781	883	975	1074	1171	1270	1366	1513		
CHT2	27	2.75	816	918	1042	1154	1275	1394	1515	1633	1812		
CHT3	32	3	1084	1195	1330	1453	1585	1714	1846	1975	2170		
CHT4	42	3.5	1342	1472	1629	1773	1927	2077	2231	2382	2609		

DOUBLE SEAT



CHT12	44	4.5	1385	1552	1754	1939	2137	2330	2528	2722	3014
-------	----	-----	------	------	------	------	------	------	------	------	------

TIDE PATIENT SYSTEM SEATS

SINGLE SEATS

SD: 20 BH: 30



MODEL	SW	YARDS	COM	M	COL								W/WL
					O	P	R	S	T	U			
CPT1	22	3	904	1015	1150	1273	1405	1534	1666	1795	1990		
CPT2	27	3.25	1062	1182	1329	1462	1605	1745	1888	2027	2239		

PRODUCT OPTIONS

- MOISTURE BARRIER** \$22 List / Yard
- FIRE WALL / CA T.B. 133** \$82 List / Yard
- TAMPER-RESISTANT FASTENERS** \$51 List / Chair
- PERMA-COAT WOOD LEG PROTECTOR** \$35 List / Leg
- ARM CAPS, TABLETS, AND ISLAND SEAT OPTIONS** See pages CCW-20 and CCW-21.



TIDE WOOD SYSTEM TABLES

	MODEL	TOP	PRICE
END TABLE W: 21 D: 21 H: 18	CCT80	Veneer over Solid Wood Edge	989 LIST
	CCT80-L	Stocked Laminate over Solid Wood Edge	1038 LIST
		Non-stocked Laminate (per color, per order)	ADD 50 NET



NOTE: Custom Wood Finish (CWF) is a one-time upcharge of 300 NET per color.

Add SOLID SURFACE ONLAY price to Veneer price above

SOLID SURFACE ONLAY UPCHARGE	A	B	C	D
Stocked	792 LIST	792 LIST	885 LIST	979 LIST
Non-stocked (per color, per order)	ADD 410 NET	450 NET	490 NET	520 NET

NOTE: 1/2" Solid Surface Onlay will increase overall height by 1/2".

	MODEL	TOP	PRICE
IN-LINE TABLE W: 21 D: 21 H: 18	CCT81	Veneer over Solid Wood Edge	796 LIST
	CCT81-L	Stocked Laminate over Solid Wood Edge	836 LIST
		Non-stocked Laminate (per color, per order)	ADD 50 NET



NOTE: Custom Wood Finish (CWF) is a one-time upcharge of 300 NET per color.

Add SOLID SURFACE ONLAY price to Veneer price above

SOLID SURFACE ONLAY UPCHARGE	A	B	C	D
Stocked	792 LIST	792 LIST	885 LIST	979 LIST
Non-stocked (per color, per order)	ADD 410 NET	450 NET	490 NET	520 NET

NOTE: 1/2" Solid Surface Onlay will increase overall height by 1/2".

	MODEL	TOP	PRICE
60° IN-LINE TABLE W: 21 D: 21 H: 18	CCT86	Veneer over Solid Wood Edge	881 LIST
	CCT86-L	Stocked Laminate over Solid Wood Edge	925 LIST
		Non-Stocked Laminate (per color, per order)	ADD 50 NET



NOTE: Custom Wood Finish (CWF) is a one-time upcharge of 300 NET per color.

Add SOLID SURFACE ONLAY price to Veneer price above

SOLID SURFACE ONLAY UPCHARGE	A	B	C	D
Stocked	792LIST	792 LIST	885 LIST	979 LIST
Non-stocked (per color, per order)	ADD 410 NET	450 NET	490 NET	520 NET

NOTE: 1/2" Solid Surface Onlay will increase overall height by 1/2".

	MODEL	TOP	PRICE
90° TWO-WAY TABLE W: 26 D: 21 H: 18	CCT82	Veneer over Solid Wood Edge	1171 LIST
	CCT82-L	Stocked Laminate over Solid Wood Edge	1230 LIST
		Non-Stocked Laminate (per color, per order)	ADD 50 NET



NOTE: Custom Wood Finish (CWF) is a one-time upcharge of 300 NET per color.

Add SOLID SURFACE ONLAY price to Veneer price above

SOLID SURFACE ONLAY UPCHARGE	A	B	C	D
Stocked	1034 LIST	1034 LIST	1156 LIST	1277 LIST
Non-stocked (per color, per order)	ADD 410 NET	450 NET	490 NET	520 NET

NOTE: 1/2" Solid Surface Onlay will increase overall height by 1/2".

PRODUCT INFORMATION

- A-Tables have 1-3/4"-thick tops, solid wood edges, and solid wood legs.
- For Freestanding A-Tables, see Table Collections.

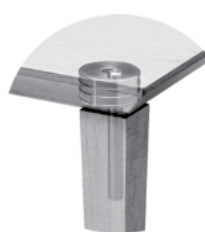

Integra A-Tables and A-Benches are built just as solidly as the rest of our products, featuring our innovatively engineered and ultra-strong steel CAM & PIN connection. The CAM & PIN are epoxied to the top and leg, creating a beautiful and clean design guaranteed to remain strong.



TIDE WOOD SYSTEM SPECIFICATION

Integra systems are listed separately from the freestanding product of each series throughout this price list. The components are specific to the model and are all shown within the systems sections. Each system arm, system seat, and system table has a specific item number. System arms must have placement specified as shown below, and system tables must specify choice of edge and leg details.

WHEN SPECIFYING SYSTEMS, ALWAYS ITEMIZE COMPONENTS AS YOU STAND FACING THE CONFIGURATION. BEGIN YOUR LAYOUT AT THE LEFT AND END AT THE RIGHT.

The seat unit and table components are shown in each system area of this price list.

All System orders require a layout at the time of order. This is to ensure you are ordering all components necessary for that layout.

System arms use an alpha designation which describes their placement:

- SS** is for Seat-to-Seat Connection
- ST** is for Seat-to-Table Connection
- TS** is for Table-to-Seat Connection
- AR** is for Arm Right
- AL** is for Arm Left

EXAMPLES (in Tide series):

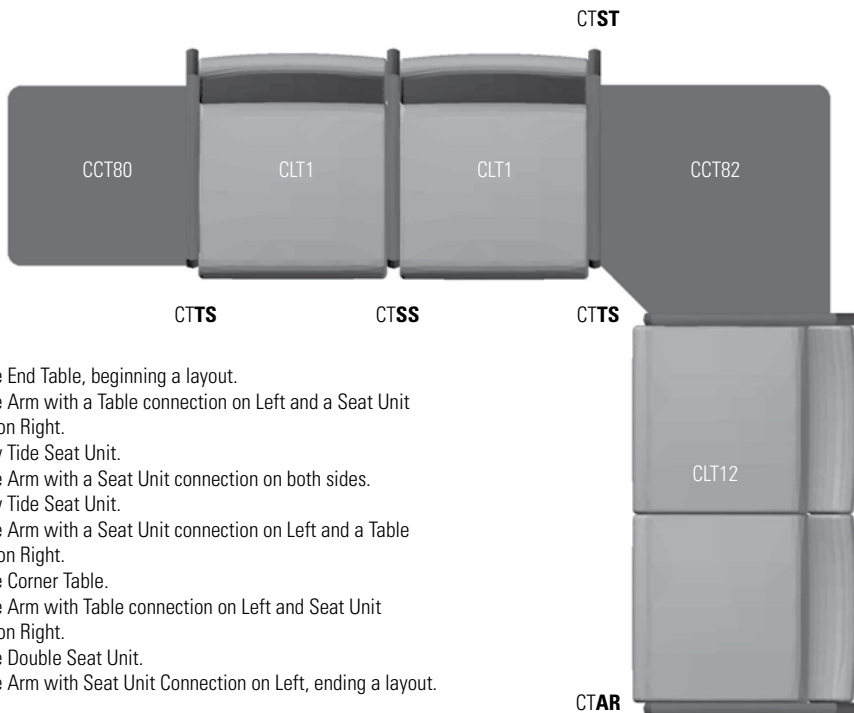

- CCT80** Coastal Tide End Table, beginning a layout.
- CTSS** Coastal Tide Arm with a Table connection on Left and a Seat Unit connection on Right.
- CLT1** Coastal Low Tide Seat Unit.
- CTSS** Coastal Tide Arm with a Seat Unit connection on both sides.
- CLT1** Coastal Low Tide Seat Unit.
- CTST** Coastal Tide Arm with a Seat Unit connection on Left and a Table connection on Right.
- CCT82** Coastal Tide Corner Table.
- CTSS** Coastal Tide Arm with Table connection on Left and Seat Unit connection on Right.
- CLT12** Coastal Tide Double Seat Unit.
- CTAR** Coastal Tide Arm with Seat Unit Connection on Left, ending a layout.

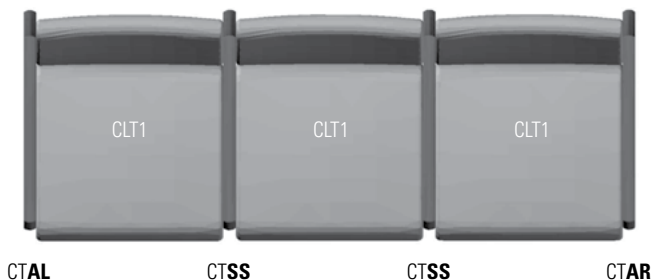

- CTAL** Coastal Tide Arm, beginning a layout, connecting to a Seat Unit on right.
- CLT1** Coastal Low Tide Seat Unit.
- CTSS** Coastal Tide Arm with a Seat Unit connection on both sides.
- CLT1** Coastal Low Tide Seat Unit.
- CTSS** Coastal Tide Arm with a Seat Unit connection on both sides.
- CLT1** Coastal Low Tide Seat Unit.
- CTAR** Coastal Tide Arm with Seat Unit Connection on Left, ending a layout.



TIDE FOOTSTOOL

FOOTSTOOL

W: 19.25 D: 19.5



MODEL	H	YARDS	COM	M	COL							
					O	P	R	S	T	U	W/WL	
CTFS1	13.25	1.5	470	526	593	655	721	785	851	916	1013	
CTFS2	18	1.5	515	571	638	700	766	830	896	961	1058	

RECESSED PULL HANDLE



MODEL	DESCRIPTION	PRICE
RPH(B/G)	Specify Black (B) or Gray (G)	86 LIST

PRODUCT OPTIONS

MOISTURE BARRIER \$22 List / Yard
FIRE WALL / CA T.B. 133 \$82 List / Yard
WEIGHTED / THEFT DETERRENT \$305 List / 25 lb Weight

LOW TIDE REPLACEMENT BACK ONLY

LOW TIDE SINGLE BACK



MODEL	SW	YARDS	COM	M	COL							
					O	P	R	S	T	U	W/WL	
CLB1	22	1	292	329	374	415	459	502	546	589	654	
Cover Only	22	1	85	122	167	208	252	295	339	382	447	
CLB2	27	1.5	383	439	506	568	634	698	764	829	926	
Cover Only	27	1.5	128	184	251	313	379	443	509	574	671	
CLB3	32	1.5	462	518	585	647	713	777	843	908	1005	
Cover Only	32	1.5	128	184	251	313	379	443	509	574	671	
CLB4	42	1.5	569	625	692	754	820	884	950	1015	1112	
Cover Only	42	1.5	128	184	251	313	379	443	509	574	671	

HIGH TIDE REPLACEMENT BACK ONLY

HIGH TIDE SINGLE BACK



MODEL	SW	YARDS	COM	M	COL							
					O	P	R	S	T	U	W/WL	
CHB1	22	1.25	328	374	431	482	537	591	646	699	781	
Cover Only	22	1.25	106	152	209	260	315	369	424	477	559	
CHB2	27	1.75	396	461	540	611	688	764	841	916	1030	
Cover Only	27	1.75	149	214	293	364	441	517	594	669	783	
CHB3	32	1.75	498	563	642	713	790	866	943	1018	1132	
Cover Only	32	1.75	149	214	293	364	441	517	594	669	783	
CHB4	42	2	600	674	764	846	934	1020	1108	1194	1324	
Cover Only	42	2	170	244	334	416	504	590	678	764	894	

PATIENT TIDE REPLACEMENT BACK ONLY

PATIENT TIDE SINGLE BACK



MODEL	SW	YARDS	COM	M	COL							
					O	P	R	S	T	U	W/WL	
CPB1	22	2	534	608	698	780	868	954	1042	1128	1258	
Cover Only	22	2	170	244	334	416	504	590	678	764	894	
CPB2	27	2.25	642	725	827	919	1018	1115	1214	1310	1457	
Cover Only	27	2.25	191	274	376	468	567	664	763	859	1006	



TIDE REPLACEMENT SEAT ONLY

	MODEL	SW	YARDS	COM	M	COL						W/WL
						O	P	R	S	T	U	
TIDE STANDARD SEAT 	CTS1	22	1	288	325	370	411	455	498	542	585	650
	Cover Only	22	1	85	122	167	208	252	295	339	382	447
	CTS2	27	1	328	365	410	451	495	538	582	625	690
	Cover Only	27	1	85	122	167	208	252	295	339	382	447
	CTS3	32	1.25	470	516	573	624	679	733	788	841	923
	Cover Only	32	1.25	106	152	209	260	315	369	424	477	559
	CTS4	42	1.5	595	651	718	780	846	910	976	1041	1138
	Cover Only	42	1.5	128	184	251	313	379	443	509	574	671

	MODEL	SW	YARDS	COM	M	COL						W/WL
						O	P	R	S	T	U	
TIDE ISLAND SEAT 	CIS1	22	1	288	325	370	411	455	498	542	585	650
	Cover Only	22	1	85	122	167	208	252	295	339	382	447
	CIS2	27	1	328	365	410	451	495	538	582	625	690
	Cover Only	27	1	85	122	167	208	252	295	339	382	447
	CIS3	32	1.25	470	516	573	624	679	733	788	841	923
	Cover Only	32	1.25	106	152	209	260	315	369	424	477	559
	CIS4	42	1.5	595	651	718	780	846	910	976	1041	1138
	Cover Only	42	1.5	128	184	251	313	379	443	509	574	671

MODEL	PRICE
ISLAND SEAT STAINLESS STEEL REPLACEMENT SLEEVES ONLY CTSLEEVES4	91 LIST/CHAIR

TIDE WOOD | ARM CAP REPLACEMENTS

MODEL	DESCRIPTION	PRICE
URETHANE ARM CAP REPLACEMENTS ACTU	Available in Black, Ginger, Nutmeg, Mocha, and Saffron	206 LIST/PR



SOLID SURFACE ARM CAP REPLACEMENTS	Solid Surface Arm Caps are only replaceable as a complete Tide Wood Arm. See page CCW-23 for System Arm price.
---	--



COASTAL COLLECTION WOOD | BENCHES





CERTIFIED
CLEAN AIR GOLD



COASTAL WOOD BENCHES

HARD MAPLE

	MODEL	YARDS	COM	M	COL O	P	R	S	T	U	W/WL
45 BENCH W: 45 D: 21 H: 19.5 SW: 42 SD: 21 SH: 18.5	 CBN-7-42	2	1261	1335	1425	1507	1595	1681	1769	1855	1985
63 BENCH W: 63 SW: 60	 CBN-7-60	3	1579	1690	1825	1948	2080	2209	2341	2470	2665
75 BENCH W: 75 SW: 72	 CBN-7-72	3.5	1778	1908	2065	2209	2363	2513	2667	2818	3045

COASTAL WOOD BENCHES | ARM CAPS

	MODEL	GRADE	A	B	C	D
SOLID SURFACE ARM CAPS 	ACCBS	Stocked Solid Surface	212 LIST/PR	212 LIST/PR	250 LIST/PR	280 LIST/PR
		Non-stocked (per color, per order)	ADD 410 NET	450 NET	490 NET	520 NET

COASTAL WOOD BENCHES | OTHER OPTIONS

	MODEL	DESCRIPTION	PRICE
STAINLESS STEEL STAND-OFFS 	SPANNERS	Adds 1.5" to seat width and overall width for cleanability	194 LIST/SET

Shown on Coastal Metal Bench

	MODEL	SEAT WIDTH	PRICE
SECURE BOTTOM COVERS 	SBC	42"	174 LIST
		60"	246 LIST
		72"	246 LIST

NOTE: Secure Bottom Covers include tamper-resistant fasteners.

PRODUCT OPTIONS

- MOISTURE BARRIER** \$22 List / Yard
- FIRE WALL / CA T.B. 133** \$82 List / Yard
- PERMA-COAT WOOD LEG PROTECTOR** \$35 List / Leg
- WEIGHTED / THEFT DETERRENT** \$305 List / 25 lb Weight
\$610 List / 50 lb Weight

COFFEE HOUSE COLLECTION

STANDARD BACK SEATING	CHC 2 - 3
HIGH BACK SEATING	CHC 4 - 5
COFFEE HOUSE OPTIONS	CHC 6 - 9
COUNTERS	CHC 10 - 13
HIGH BACK OPTIONS	CHC 14 - 15
SYSTEM SEATING	CHC 16 - 25
OTTOMANS	CHC 26 - 29
SYSTEM SPECIFICATIONS	CHC 30 - 31



COFFEE HOUSE COLLECTION | STANDARD BACK



CERTIFIED
CLEAN AIR GOLD



COMPONENT-BASED
CONSTRUCTION

2K STATIC
CAPACITY

1K DROP
CAPACITY

CH - STANDARD OR CLEAN-OUT SEAT

MODULAR DESIGN

			MODEL	SEAT STYLE	YARDS	COM	M	COL			P	R	S	T	U	W/WL
22" STRAIGHT		W: 22.5 D: 30 H: 33 SW: 22.5 SD: 19.5 SH: 18 BH: 17	CST-1-22	Standard	3.25	1406	1526	1673	1806	1949	2089	2232	2371	2583		
			COST-1-22	Clean-Out	3.5	1518	1648	1805	1949	2103	2253	2407	2558	2785		
26" STRAIGHT		W: 26 SW: 26	CST-1-26	Standard	3.75	1587	1726	1895	2048	2213	2375	2540	2701	2945		
			COST-1-26	Clean-Out	3.75	1698	1837	2006	2159	2324	2486	2651	2812	3056		
30" STRAIGHT		W: 30 SW: 30	CST-1-30	Standard	3.75	1781	1920	2089	2242	2407	2569	2734	2895	3139		
			COST-1-30	Clean-Out	3.75	1892	2031	2200	2353	2518	2680	2845	3006	3250		
36" STRAIGHT		W: 36 SW: 36	CST-1-36	Standard	4.5	2253	2420	2622	2807	3005	3198	3396	3590	3882		
			COST-1-36	Clean-Out	4.5	2364	2531	2733	2918	3116	3309	3507	3701	3993		
45" STRAIGHT		W: 45 SW: 45	CST-1-45	Standard	5.75	2340	2553	2812	3047	3300	3548	3801	4048	4422		
			COST-1-45	Clean-Out	5.75	2507	2720	2979	3214	3467	3715	3968	4215	4589		
54" STRAIGHT		W: 54 SW: 54	CST-1-54	Standard	7	2819	3078	3393	3680	3988	4289	4597	4898	5353		
			COST-1-54	Clean-Out	7	2987	3246	3561	3848	4156	4457	4765	5066	5521		
60" STRAIGHT		W: 60 SW: 60	CST-1-60	Standard	7	3227	3486	3801	4088	4396	4697	5005	5306	5761		
			COST-1-60	Clean-Out	7	3393	3652	3967	4254	4562	4863	5171	5472	5927		
66" STRAIGHT		W: 66 SW: 66	CST-1-66	Standard	7.5	3635	3913	4250	4558	4888	5210	5540	5863	6350		
			COST-1-66	Clean-Out	7.5	3801	4079	4416	4724	5054	5376	5706	6029	6516		
72" STRAIGHT		W: 72 SW: 72	CST-1-72	Standard	7.5	4041	4319	4656	4964	5294	5616	5946	6269	6756		
			COST-1-72	Clean-Out	7.5	4208	4486	4823	5131	5461	5783	6113	6436	6923		

NOTE: Custom widths may be available. Please contact Customer Service if another size is needed.



CH - STANDARD OR CLEAN-OUT SEAT

	MODEL	SEAT STYLE	YARDS	COM	M	COL						W/WL
						O	P	R	S	T	U	
22.5° INSIDE CURVE	CIC-1-22	Standard	3.75	1784	1923	2092	2245	2410	2572	2737	2898	3142
	COIC-1-22	Clean-Out	3.75	1896	2035	2204	2357	2522	2684	2849	3010	3254

W: 22.5-34 D: 30 H: 33
 SW: 22.5-34 SD: 19.5 SH: 18
 BH: 17



45° INSIDE CURVE	CIC-1-45	Standard	5.25	2215	2409	2646	2861	3092	3318	3549	3774	4116
	COIC-1-45	Clean-Out	5.25	2378	2572	2809	3024	3255	3481	3712	3937	4279

W: 22.5-45
 SW: 22.5-45



22.5° OUTSIDE CURVE	COC-1-22	Standard	3.5	1786	1916	2073	2217	2371	2521	2675	2826	3053
	COOC-1-22	Clean-Out	3.5	1897	2027	2184	2328	2482	2632	2786	2937	3164

W: 34 D: 30 H: 33
 SW: 34 SD: 19.5 SH: 18
 BH: 17



45° OUTSIDE CURVE	COC-1-45	Standard	5	2213	2398	2623	2828	3048	3263	3483	3698	4023
	COOC-1-45	Clean-Out	5	2323	2508	2733	2938	3158	3373	3593	3808	4133

W: 45
 SW: 45



90° INSIDE CORNER	CEC-1-90	Standard	5.5	2217	2421	2668	2894	3136	3372	3614	3851	4208
	COEC-1-90	Clean-Out	5.5	2438	2642	2889	3115	3357	3593	3835	4072	4429

W: 30
 SW: 19.5



NOTE: 5 Legs used

90° END UNITS (LT/RT)	CEC-1-90-(4/5)	Standard	5.5	2132	2336	2583	2809	3051	3287	3529	3766	4123
	COEC-1-90-(4/5)	Clean-Out	6	2353	2575	2845	3091	3355	3613	3877	4135	4525

W: 30
 SW: 19.5



4 - Right as seated (Left End) 5 - Left as seated (Right End)

NOTE: Must choose placement: (4) Right as seated (Left End) or (5) Left as seated (Right End)

26° END UNITS (LT/RT)	CEC-1-26-(4/5)	Standard	6	2583	2805	3075	3321	3585	3843	4107	4365	4755
	COEC-1-26-(4/5)	Clean-Out	6	2689	2911	3181	3427	3691	3949	4213	4471	4861

W: 37
 SW: 26



4 - Right as seated (Left End) 5 - Left as seated (Right End)

NOTE: Must choose placement: (4) Right as seated (Left End) or (5) Left as seated (Right End)



COFFEE HOUSE COLLECTION | HIGH BACK









CERTIFIED
CLEAN AIR GOLD

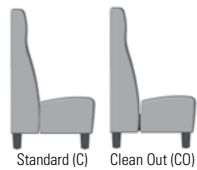

HBCH - STANDARD OR CLEAN-OUT SEAT

MODULAR DESIGN

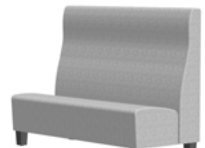
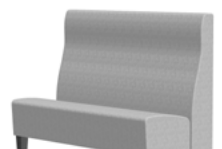
						COL							
	MODEL	SEAT STYLE	YARDS	COM	M	O	P	R	S	T	U	W/WL	
22" STRAIGHT W: 22.5 D: 30 H: 50 SW: 22.5 SD: 19.5 SH: 18 BH: 33													
													CSTH1-1-22
	COSTH1-1-22	Clean-Out	5	1858	2043	2268	2473	2693	2908	3128	3343	3668	
26" STRAIGHT W: 26 SW: 26													
													CSTH1-1-26
	COSTH1-1-26	Clean-Out	5	2093	2278	2503	2708	2928	3143	3363	3578	3903	
30" STRAIGHT W: 30 SW: 30													
													CSTH1-1-30
	COSTH1-1-30	Clean-Out	5	2351	2536	2761	2966	3186	3401	3621	3836	4161	
36" STRAIGHT W: 36 SW: 36													
													CSTH1-1-36
	COSTH1-1-36	Clean-Out	5.5	2809	3013	3260	3486	3728	3964	4206	4443	4800	
45" STRAIGHT W: 45 SW: 45													
													CSTH1-1-45
	COSTH1-1-45	Clean-Out	7.5	3123	3401	3738	4046	4376	4698	5028	5351	5838	
54" STRAIGHT W: 54 SW: 54													
													CSTH1-1-54
	COSTH1-1-54	Clean-Out	10	3675	4045	4495	4905	5345	5775	6215	6645	7295	
60" STRAIGHT W: 60 SW: 60													
													CSTH1-1-60
	COSTH1-1-60	Clean-Out	10	4113	3835	4933	5343	5783	6213	6653	7083	7733	
66" STRAIGHT W: 66 SW: 66													
													CSTH1-1-66
	COSTH1-1-66	Clean-Out	10.5	4551	4940	5412	5843	6305	6756	7218	7670	8352	
72" STRAIGHT W: 72 SW: 72													
													CSTH1-1-72
	COSTH1-1-72	Clean-Out	10.5	4989	5378	5850	6281	6743	7194	7656	8108	8790	



HBCH - STANDARD OR CLEAN-OUT SEAT

	MODEL	SEAT STYLE	YARDS	COM	M	COL							W/WL
						O	P	R	S	T	U		
22.5° INSIDE CURVE	CICH1-1-22	Standard	5	2253	2438	2663	2868	3088	3303	3523	3738	4063	
	COICH1-1-22	Clean-Out	5	2365	2550	2775	2980	3200	3415	3635	3850	4175	

W: 22.5-34 **D:** 30 **H:** 50
SW: 22.5-34 **SD:** 19.5 **SH:** 18
BH: 33



45° INSIDE CURVE

W: 22.5-45
SW: 22.5-45



CICH1-1-45	Standard	7	2841	3100	3415	3702	4010	4311	4619	4920	5375
COICH1-1-45	Clean-Out	7	3004	3263	3578	3865	4173	4474	4782	5083	5538

22.5° OUTSIDE CURVE

W: 34 **D:** 30 **H:** 50
SW: 34 **SD:** 19.5 **SH:** 18
BH: 33



COCH1-1-22	Standard	5.5	2212	2416	2663	2889	3131	3367	3609	3846	4203
COOCH1-1-22	Clean-Out	5.5	2323	2527	2774	3000	3242	3478	3720	3957	4314

45° OUTSIDE CURVE

W: 45
SW: 45



COCH1-1-45	Standard	6	2762	2984	3254	3500	3764	4022	4286	4544	4934
COOCH1-1-45	Clean-Out	6	2872	3094	3364	3610	3874	4132	4396	4654	5044

90° INSIDE CORNER

W: 30
SW: 19.5
 NOTE: 5 Legs used



CECH1-1-90	Standard	8.75	2975	3299	3693	4051	4436	4813	5198	5574	6143
COECH1-1-90	Clean-Out	8.75	3196	3520	3914	4272	4657	5034	5419	5795	6364

90° END UNITS (LT/RT)

W: 30
SW: 19.5



4 - Right as seated (Left End) **5** - Left as seated (Right End)

CECH1-1-90-(4/5)	Standard	8.75	2890	3214	3608	3966	4351	4728	5113	5489	6058
COECH1-1-90-(4/5)	Clean-Out	9.25	3111	3453	3870	4249	4656	5054	5461	5858	6460

NOTE: Must choose placement: (4) Right as seated (Left End) or (5) Left as seated (Right End)

26" END UNITS (LT/RT)

W: 37
SW: 26





4 - Right as seated (Left End) **5** - Left as seated (Right End)

CECH1-1-26-(4/5)	Standard	10.25	3469	3848	4310	4730	5181	5622	6073	6513	7180
COECH1-1-26-(4/5)	Clean-Out	10.25	3575	3954	4416	4836	5287	5728	6179	6619	7286

NOTE: Must choose placement: (4) Right as seated (Left End) or (5) Left as seated (Right End)



COFFEE HOUSE | GANGING OPTIONS

		MODEL	PRICE
RIGID PLATE CONNECTOR		RPC	26 LIST
CENTER POST LEG		RPL1	106 LIST

COFFEE HOUSE | LEG OPTIONS

		MODEL	PRICE
BRUSHED ALUMINUM LEGS		4BA	No Upcharge

		MODEL	DESCRIPTION	PRICE
WOOD LEGS		GGCH4	Specify Wood Finish	No Upcharge

		MODEL	DESCRIPTION	PRICE
HIDE & GO MOBILITY		HGCH4	Wood legs with in-line casters in front and dome glides in back. Specify Wood finish. NOTE: Recommended on 22", 26", 30", 36"sw Straight units ONLY. Not recommended on High Back seating.	30 LIST

		MODEL	DESCRIPTION	PRICE
5" HEAVY DUTY CASTERS		5C1	Set of 4 Locking Black Casters NOTE: Recommended on 22", 26", 30", 36"sw units ONLY. Not recommended on High Back seating.	136 LIST/SET OF 4

		MODEL	DESCRIPTION	PRICE
POWDER COAT SLED BASE		CHSB(_)	Powder coat color must be specified. Not available in Brushed Chrome finish.	300 LIST/PR



COFFEE HOUSE | ARM OPTIONS

UPHOLSTERED ARMS

D: 26
H: 26



MODEL	W	YARDS	COM	M	COL								
					O	P	R	S	T	U	W/WL		
CU(L/R)2													
PAIR LEFT (L) and RIGHT (R) ARMS	11	2.5	826	919	1031	1134	1244	1351	1461	1569	1731		
EACH LEFT (L) or RIGHT (R) ARM	5.5	1.25	413	459	516	567	622	676	731	784	866		

BENT WOOD ARMS

D: 26
H: 25



MODEL	W	PRICE
BB(L/R)		
PAIR LEFT (L) and RIGHT (R) ARMS	11	676
EACH LEFT (L) or RIGHT (R) ARM	5.5	338

ATRIUM ARMS

D: 26
H: 26



MODEL	W	DESCRIPTION	PRICE
BC(L/R)		Brushed Chrome Solid Steel Arm	
PAIR LEFT (L) and RIGHT (R) ARMS	4		1062
EACH LEFT (L) or RIGHT (R) ARM	2		531

METAL T-ARMS

D: 10
H: 25.75



MODEL	W	PRICE	A	B	C	D
CHPA(L/R)						
PAIR LEFT (L) and RIGHT (R) ARMS		1034 LIST/PR				
Stocked Solid Surface Arm Caps	2.75		NC	NC	18 LIST/PR	44 LIST/PR
Non-stocked (per color, per order)	2.75		ADD 410 NET	450 NET	490 NET	520 NET
EACH LEFT (L) or RIGHT (R) ARM		517 LIST/ARM				
Stocked Solid Surface Arm Caps	1.375		NC	NC	9 LIST/EA	22 LIST/EA
Non-stocked (per color, per order)	1.375		ADD 410 NET	450 NET	490 NET	520 NET



Powder Coat selection required for tablet post.

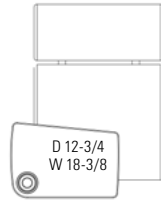
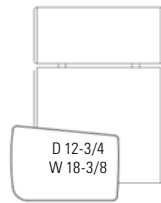

With Cup Holder option

CHOOSE POSITION

(4)

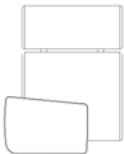

(5)

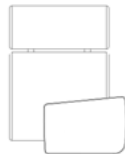

(4) - Tablet on right as seated

(5) - Tablet on left as seated

SOLID SURFACE TABLET OPTION

MODEL	GRADE		A	B	C	D
ST-(4/5)	Stocked		812 LIST	848 LIST	900 LIST	983 LIST
	Non-stocked (per color, per order)	ADD	410 NET	450 NET	490 NET	520 NET

LAMINATE OVER PLYWOOD CORE/EDGE TABLET OPTION

MODEL	GRADE		PRICE
LT-(4/5)	Stocked (Laminate tablets have a plywood edge. Specify finish.)		637 LIST
	Non-stocked (per color, per order)	ADD	50 NET

VENEER OVER PLYWOOD CORE/EDGE TABLET OPTION

MODEL	GRADE		PRICE
VT-(4/5)	Standard Wood Finish		637 LIST
	Custom Finish (one time charge per color)	ADD	300 NET

CUP HOLDER

MODEL	FINISH	PRICE
CUPIN	Brushed Aluminum	216 LIST

NOTE: Coffee House 22" Chair with Casters and external tablet adds 25lbs of weight



COFFEE HOUSE | OTHER OPTIONS

	MODEL	DESCRIPTION	PRICE
RECESSED PULL HANDLE	RPH(B/G)	For use with mobile options. Specify Black (B) or Gray (G).	86 LIST

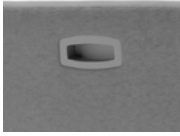

	MODEL	DESCRIPTION	PRICE
ELECTRICAL / POWER PORT	XE3(COLOR)(4/5)	(1) Dual USB and (2) Standard Plug-Ins. Available in All Black (B), All White (W) and Silver with White Outlets (S).	543 LIST/EACH



(B) ALL BLACK



(W) ALL WHITE



(S) SILVER WITH WHITE OUTLETS

NOTE: Must choose placement in front panel: (4) Electrical on right as seated or (5) Electrical on left as seated

PRODUCT OPTIONS

- MOISTURE BARRIER** \$22 List / Yard
- FIRE WALL / CA T.B. 133** \$82 List / Yard
- TAMPER-RESISTANT FASTENERS** \$51 List / Chair
- PERMA-COAT WOOD LEG PROTECTOR** \$35 List / Leg
- WEIGHTED / THEFT DETERRENT** \$305 List / 25 lb Weight
\$610 List / 50 lb Weight



COFFEE HOUSE COLLECTION | HIGH BACK



CERTIFIED
CLEAN AIR GOLD



COUNTERS AT 42"H, 36"H, and 30"H

MODULAR DESIGN

22 COUNTER

W: 21.5 D: 10



MODEL	TOP	PRICE
CNTR-ST-22-V	Maple Veneer over Plywood Core/Edge	576
CNTR-ST-22-L	Stocked Laminate over Plywood Core/Edge	576
	Non-stocked Laminate (per color, per order)	ADD 50 NET

NOTE: Custom Wood Finish (CWF) is a one-time upcharge of 300 NET per color.

MODEL	SOLID SURFACE TOP
CNTR-ST-22-S	Stocked Contact Integra Customer Service for Pricing.

26 COUNTER

W: 25 D: 10



MODEL	TOP	PRICE
CNTR-ST-26-V	Maple Veneer over Plywood Core/Edge	600
CNTR-ST-26-L	Stocked Laminate over Plywood Core/Edge	600
	Non-stocked Laminate (per color, per order)	ADD 50 NET

NOTE: Custom Wood Finish (CWF) is a one-time upcharge of 300 NET per color.

MODEL	SOLID SURFACE TOP
CNTR-ST-26-S	Stocked Contact Integra Customer Service for Pricing.

30 COUNTER

W: 29 D: 10



MODEL	TOP	PRICE
CNTR-ST-30-V	Maple Veneer over Plywood Core/Edge	633
CNTR-ST-30-L	Stocked Laminate over Plywood Core/Edge	633
	Non-stocked Laminate (per color, per order)	ADD 50 NET

NOTE: Custom Wood Finish (CWF) is a one-time upcharge of 300 NET per color.

MODEL	SOLID SURFACE TOP
CNTR-ST-30-S	Stocked Contact Integra Customer Service for Pricing.

36 COUNTER

W: 35 D: 10



MODEL	TOP	PRICE
CNTR-ST-36-V	Maple Veneer over Plywood Core/Edge	687
CNTR-ST-36-L	Stocked Laminate over Plywood Core/Edge	687
	Non-stocked Laminate (per color, per order)	ADD 50 NET

NOTE: Custom Wood Finish (CWF) is a one-time upcharge of 300 NET per color.

MODEL	SOLID SURFACE TOP
CNTR-ST-36-S	Stocked Contact Integra Customer Service for Pricing.

45 COUNTER

W: 44 D: 10



MODEL	TOP	PRICE
CNTR-ST-45-V	Maple Veneer over Plywood Core/Edge	744
CNTR-ST-45-L	Stocked Laminate over Plywood Core/Edge	744
	Non-stocked Laminate (per color, per order)	ADD 50 NET

NOTE: Custom Wood Finish (CWF) is a one-time upcharge of 300 NET per color.

MODEL	SOLID SURFACE TOP
CNTR-ST-45-S	Stocked Contact Integra Customer Service for Pricing.



COUNTERS AT 42"H, 36"H, and 30"H

	MODEL	TOP	PRICE
54 COUNTER W: 53 D: 10	CNTR-ST-54-V	Maple Veneer over Plywood Core/Edge	948
	CNTR-ST-54-L	Stocked Laminate over Plywood Core/Edge	948
		Non-stocked Laminate (per color, per order)	ADD 50 NET

NOTE: Custom Wood Finish (CWF) is a one-time upcharge of 300 NET per color.

MODEL	SOLID SURFACE TOP
CNTR-ST-54-S	Stocked Contact Integra Customer Service for Pricing.

	MODEL	TOP	PRICE
60 COUNTER W: 59 D: 10	CNTR-ST-60-V	Maple Veneer over Plywood Core/Edge	1054
	CNTR-ST-60-L	Stocked Laminate over Plywood Core/Edge	1054
		Non-stocked Laminate (per color, per order)	ADD 50 NET

NOTE: Custom Wood Finish (CWF) is a one-time upcharge of 300 NET per color.

MODEL	SOLID SURFACE TOP
CNTR-ST-60-S	Stocked Contact Integra Customer Service for Pricing.

	MODEL	TOP	PRICE
66 COUNTER W: 65 D: 10	CNTR-ST-66-V	Maple Veneer over Plywood Core/Edge	1159
	CNTR-ST-66-L	Stocked Laminate over Plywood Core/Edge	1159
		Non-stocked Laminate (per color, per order)	ADD 50 NET

NOTE: Custom Wood Finish (CWF) is a one-time upcharge of 300 NET per color.

MODEL	SOLID SURFACE TOP
CNTR-ST-66-S	Stocked Contact Integra Customer Service for Pricing.

	MODEL	TOP	PRICE
72 COUNTER W: 71 D: 10	CNTR-ST-72-V	Maple Veneer over Plywood Core/Edge	1264
	CNTR-ST-72-L	Stocked Laminate over Plywood Core/Edge	1264
		Non-stocked Laminate (per color, per order)	ADD 50 NET

NOTE: Custom Wood Finish (CWF) is a one-time upcharge of 300 NET per color.

MODEL	SOLID SURFACE TOP
CNTR-ST-72-S	Stocked Contact Integra Customer Service for Pricing.



INSIDE & OUTSIDE CURVE COUNTERS

22.5° INSIDE CURVE COUNTER

W: 38 D: 10



MODEL	TOP	PRICE
CNTR-IC-22-V	Maple Veneer over Plywood Core/Edge	744
CNTR-IC-22-L	Stocked Laminate over Plywood Core/Edge	744
	Non-stocked Laminate (per color, per order)	ADD 50 NET

NOTE: Custom Wood Finish (CWF) is a one-time upcharge of 300 NET per color.

MODEL	SOLID SURFACE TOP
CNTR-IC-22-S	Stocked Contact Integra Customer Service for Pricing.

NOTE: When using 22.5° Inside Curve Counters, a 25lb weight is required and you must add \$305 to the list price.

45° INSIDE CURVE COUNTER

W: 52.5 D: 10



MODEL	TOP	PRICE
CNTR-IC-45-V	Maple Veneer over Plywood Core/Edge	882
CNTR-IC-45-L	Stocked Laminate over Plywood Core/Edge	882
	Non-stocked Laminate (per color, per order)	ADD 50 NET

NOTE: Custom Wood Finish (CWF) is a one-time upcharge of 300 NET per color.

MODEL	SOLID SURFACE TOP
CNTR-IC-45-S	Stocked Contact Integra Customer Service for Pricing.

NOTE: When using 45° Inside Curve Counters, a 25lb weight is required and you must add \$305 to the list price.

22.5° OUTSIDE CURVE COUNTER

W: 22 D: 10



MODEL	TOP	PRICE
CNTR-OC-22-V	Maple Veneer over Plywood Core/Edge	576
CNTR-OC-22-L	Stocked Laminate over Plywood Core/Edge	576
	Non-stocked Laminate (per color, per order)	ADD 50 NET

NOTE: Custom Wood Finish (CWF) is a one-time upcharge of 300 NET per color.

MODEL	SOLID SURFACE TOP
CNTR-OC-22-S	Stocked Contact Integra Customer Service for Pricing.

45° OUTSIDE CURVE COUNTER

W: 21 D: 10



MODEL	TOP	PRICE
CNTR-OC-45-V	Maple Veneer over Plywood Core/Edge	576
CNTR-OC-45-L	Stocked Laminate over Plywood Core/Edge	576
	Non-stocked Laminate (per color, per order)	ADD 50 NET

NOTE: Custom Wood Finish (CWF) is a one-time upcharge of 300 NET per color.

MODEL	SOLID SURFACE TOP
CNTR-OC-45-S	Stocked Contact Integra Customer Service for Pricing.



CORNER COUNTERS

90° COUNTER

W: 28.5 D: 10



MODEL	TOP	PRICE
CNTR-IC-90-(4/5)-V	Maple Veneer over Plywood Core/Edge	744
CNTR-IC-90-(4/5)-L	Stocked Laminate over Plywood Core/Edge	744
	Non-stocked Laminate (per color, per order)	ADD 50 NET

NOTE: Custom Wood Finish (CWF) is a one-time upcharge of 300 NET per color.

MODEL	SOLID SURFACE TOP
CNTR-IC-90-(4/5)-S	Stocked Contact Integra Customer Service for Pricing.

NOTE: Must choose placement: (4) Right as seated (Left End) or (5) Left as seated (Right End)

(2) 90° COUNTERS

W: 40 D: 10

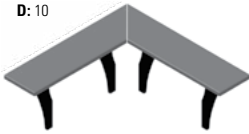

MODEL	TOP	PRICE
CNTR-IC-90-B-V	Maple Veneer over Plywood Core/Edge	1488
CNTR-IC-90-B-L	Stocked Laminate over Plywood Core/Edge	1488
	Non-stocked Laminate (per color, per order)	ADD 50 NET

NOTE: Custom Wood Finish (CWF) is a one-time upcharge of 300 NET per color.

MODEL	SOLID SURFACE TOP
CNTR-90-B-S	Stocked Contact Integra Customer Service for Pricing.



COFFEE HOUSE COLLECTION | HIGH BACK



CERTIFIED
CLEAN AIR GOLD



HBCH DIVIDER PANEL

MODULAR DESIGN

DIVIDER PANEL

W: 2 D: 26
H: 45



MODEL

YARDS

COM

M

O

P

R

S

T

U

W/WL

CUP(L/R)

2.75

614

716

840

952

1073

1192

1313

1431

1610

NOTE: Must choose placement: (L) CH Divider Panel Left as facing unit or (5) CH Divider Panel Right as facing unit
Can be added to existing High Back Coffee House seating and field installed.

PRODUCT OPTIONS

MOISTURE BARRIER \$22 List / Yard

FIRE WALL / CA T.B. 133 \$82 List / Yard

HBCH DIVIDER PANEL | TABLET OPTIONS

ALL INTEGRA TABLETS HAVE A 300LB CAPACITY



Powder Coat selection required for tablet post.

As shown on 30" SW, COM Fabric, Sled Base
Unit only 3210 LIST
Unit with Solid Surface Tablet 3956 LIST

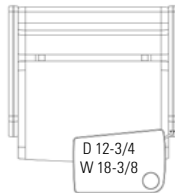
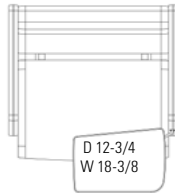

With Cup Holder option

SOLID SURFACE TABLET OPTION

MODEL	GRADE	A	B	C	D
ST-(4/5)	Stocked	901 LIST	93 LIST	989 LIST	1072 LIST
	Non-stocked (per color, per order)	ADD 410 NET	450 NET	490 NET	520 NET

LAMINATE OVER PLYWOOD CORE/EDGE TABLET OPTION

MODEL	GRADE	PRICE
LT-(4/5)	Stocked (Laminate tablets have a plywood edge. Specify finish.)	726 LIST
	Non-stocked (per color, per order)	ADD 50 NET

VENEER OVER PLYWOOD CORE/EDGE TABLET OPTION

MODEL	GRADE	PRICE
VT-(4/5)	Standard Wood Finish	726 LIST
	Custom Finish (one time charge per color)	ADD 300 NET

CHOOSE POSITION

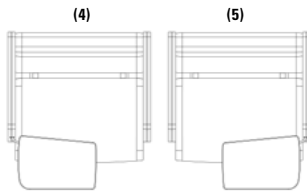

(4) - Tablet on right as seated

(5) - Tablet on left as seated

CUP HOLDER

MODEL	FINISH	PRICE
CUPIN	Brushed Aluminum	216 LIST



HBCH DIVIDER PANEL | OTHER OPTIONS

	MODEL	DESCRIPTION	PRICE
STAINLESS STEEL STAND-OFFS	SPANNERS	Adds 1.5" to seat width and overall width for cleanability	109 LIST/PANEL
	NOTE: Stand-offs allow for the best cleaning and sanitizing access to all areas of the seating.		

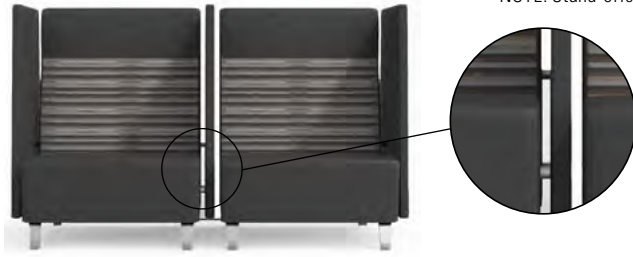

	MODEL	DESCRIPTION	PRICE
RIGID PLATE CONNECTOR	RPCDP	Can be used with or without spanners	48 LIST/EACH



COFFEE HOUSE COLLECTION | STANDARD BACK SYSTEMS



CERTIFIED
CLEAN AIR GOLD











COMPONENT-BASED
CONSTRUCTION

2K STATIC
CAPACITY

1K DROP
CAPACITY

CH SYSTEMS - STANDARD OR CLEAN-OUT SEAT









MODULAR DESIGN

			MODEL	SEAT STYLE	YARDS	COM	M	COL				T	U	W/WL
								O	P	R	S			
22" STRAIGHT		Standard (C) Clean Out (CO)	CST-0-22	Standard	3.25	1066	1186	1333	1466	1609	1749	1892	2031	2243
			COST-0-22	Clean-Out	3.5	1178	1308	1465	1609	1763	1913	2067	2218	2445
W: 22.5	D: 30	H: 33												
SW: 22.5	SD: 19.5	SH: 18												
BH: 17														
26" STRAIGHT			CST-0-26	Standard	3.75	1247	1386	1555	1708	1873	2035	2200	2361	2605
			COST-0-26	Clean-Out	3.75	1358	1497	1666	1819	1984	2146	2311	2472	2716
W: 26														
SW: 26														
30" STRAIGHT			CST-0-30	Standard	3.75	1441	1580	1749	1902	2067	2229	2394	2555	2799
			COST-0-30	Clean-Out	3.75	1552	1691	1860	2013	2178	2340	2505	2666	2910
W: 30														
SW: 30														
36" STRAIGHT			CST-0-36	Standard	4.5	1913	2080	2282	2467	2665	2858	3056	3250	3542
			COST-0-36	Clean-Out	4.5	2024	2191	2393	2578	2776	2969	3167	3361	3653
W: 36														
SW: 36														
45" STRAIGHT			CST-0-45	Standard	5.75	2000	2213	2472	2707	2960	3208	3461	3708	4082
			COST-0-45	Clean-Out	5.75	2167	2380	2639	2874	3127	3375	3628	3875	4249
W: 45														
SW: 45														
54" STRAIGHT			CST-0-54	Standard	7	2479	2738	3053	3340	3648	3949	4257	4558	5013
			COST-0-54	Clean-Out	7	2647	2906	3221	3508	3816	4117	4425	4726	5181
W: 54														
SW: 54														
60" STRAIGHT			CST-0-60	Standard	7	2887	3146	3461	3748	4056	4357	4665	4966	5421
			COST-0-60	Clean-Out	7	3053	3312	3627	3914	4222	4523	4831	5132	5587
W: 60														
SW: 60														
66" STRAIGHT			CST-0-66	Standard	7.5	3295	3573	3910	4218	4548	4870	5200	5523	6010
			COST-0-66	Clean-Out	7.5	3461	3739	4076	4384	4714	5036	5366	5689	6176
W: 66														
SW: 66														
72" STRAIGHT			CST-0-72	Standard	7.5	3701	3979	4316	4624	4954	5276	5606	5929	6416
			COST-0-72	Clean-Out	7.5	3868	4146	4483	4791	5121	5443	5773	6096	6583
W: 72														
SW: 72														

NOTE: Custom widths may be available. Please contact Customer Service if another size is needed.



CH SYSTEMS - STANDARD OR CLEAN-OUT SEAT

	MODEL	SEAT STYLE	YARDS	COM	M	COL							W/WL
						O	P	R	S	T	U		
22.5° INSIDE CURVE W: 22.5-34 D: 30 H: 33 SW: 22.5-34 SD: 19.5 SH: 18 BH: 17		CIC-0-22	Standard	3.75	1444	1583	1752	1905	2070	2232	2397	2558	2802
		COIC-0-22	Clean-Out	3.75	1556	1695	1864	2017	2182	2344	2509	2670	2914
45° INSIDE CURVE W: 22.5-45 SW: 22.5-45		CIC-0-45	Standard	5.25	1875	2069	2306	2521	2752	2978	3209	3434	3776
		COIC-0-45	Clean-Out	5.25	2038	2232	2469	2684	2915	3141	3372	3597	3939
22.5° OUTSIDE CURVE W: 34 D: 30 H: 33 SW: 34 SD: 19.5 SH: 18 BH: 17		COC-0-22	Standard	3.5	1446	1576	1733	1877	2031	2181	2335	2486	2713
		COOC-0-22	Clean-Out	3.5	1557	1687	1844	1988	2142	2292	2446	2597	2824
45° OUTSIDE CURVE W: 45 SW: 45		COC-0-45	Standard	5	1873	2058	2283	2488	2708	2923	3143	3358	3683
		COOC-0-45	Clean-Out	5	1983	2168	2393	2598	2818	3033	3253	3468	3793
90° INSIDE CORNER W: 30 SW: 19.5 NOTE: 5 Legs used		CEC-0-90	Standard	5.5	1792	1996	2243	2469	2711	2947	3189	3426	3783
		COEC-0-90	Clean-Out	5.5	2013	2217	2464	2690	2932	3168	3410	3647	4004
90° END UNITS (LT/RT) W: 30 SW: 19.5		CEC-0-90-(4/5)	Standard	5.5	1792	1996	2243	2469	2711	2947	3189	3426	3783
		COEC-0-90-(4/5)	Clean-Out	6	2013	2235	2505	2751	3015	3273	3537	3795	4185
		NOTE: Must choose placement: (4) Right as seated (Left End) or (5) Left as seated (Right End)											
26° END UNITS (LT/RT) W: 37 SW: 26		CEC-0-26-(4/5)	Standard	6	2243	2465	2735	2981	3245	3503	3767	4025	4415
		COEC-0-26-(4/5)	Clean-Out	6	2349	2571	2841	3087	3351	3609	3873	4131	4521
		NOTE: Must choose placement: (4) Right as seated (Left End) or (5) Left as seated (Right End)											



COFFEE HOUSE COLLECTION | HIGH BACK SYSTEMS







CERTIFIED
CLEAN AIR GOLD

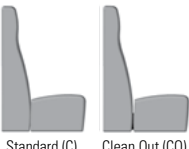

HBCH SYSTEMS- STANDARD OR CLEAN-OUT SEAT

MODULAR DESIGN

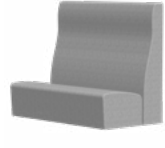
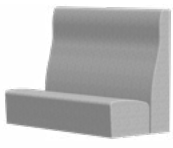
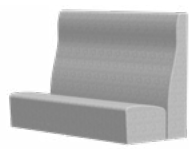
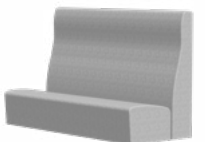
		MODEL	SEAT STYLE	YARDS	COM	M	COL O	P	R	S	T	U	W/WL
22" STRAIGHT		CSTH1-0-22	Standard	4.75	1406	1582	1796	1990	2199	2404	2613	2817	3126
		COSTH1-0-22	Clean-Out	5	1518	1703	1928	2133	2353	2568	2788	3003	3328
W: 22.5	D: 30	H: 50											
SW: 22.5	SD: 19.5	SH: 18											
BH: 33													
			Standard (C)	Clean Out (CO)									
26" STRAIGHT		CSTH1-0-26	Standard	5	1642	1827	2052	2257	2477	2692	2912	3127	3452
		COSTH1-0-26	Clean-Out	5	1753	1938	2163	2368	2588	2803	3023	3238	3563
W: 26													
SW: 26													
30" STRAIGHT		CSTH1-0-30	Standard	5	1900	2085	2310	2515	2735	2950	3170	3385	3710
		COSTH1-0-30	Clean-Out	5	2011	2196	2421	2626	2846	3061	3281	3496	3821
W: 30													
SW: 30													
36" STRAIGHT		CSTH1-0-36	Standard	5.5	2358	2562	2809	3035	3277	3513	3755	3992	4349
		COSTH1-0-36	Clean-Out	5.5	2469	2673	2920	3146	3388	3624	3866	4103	4460
W: 36													
SW: 36													
45" STRAIGHT		CSTH1-0-45	Standard	7.5	2616	2894	3231	3539	3869	4191	4521	4844	5331
		COSTH1-0-45	Clean-Out	7.5	2783	3061	3398	3706	4036	4358	4688	5011	5498
W: 45													
SW: 45													
54" STRAIGHT		CSTH1-0-54	Standard	10	3167	3537	3987	4397	4837	5267	5707	6137	6787
		COSTH1-0-54	Clean-Out	10	3335	3705	4155	4565	5005	5435	5875	6305	6955
W: 54													
SW: 54													
60" STRAIGHT		CSTH1-0-60	Standard	10	3607	3977	4427	4837	5277	5707	6147	6577	7227
		COSTH1-0-60	Clean-Out	10	3773	4143	4593	5003	5443	5873	6313	6743	7393
W: 60													
SW: 60													
66" STRAIGHT		CSTH1-0-66	Standard	10.5	4045	4434	4906	5337	5799	6250	6712	7164	7846
		COSTH1-0-66	Clean-Out	10.5	4211	4600	5072	5503	5965	6416	6878	7330	8012
W: 66													
SW: 66													
72" STRAIGHT		CSTH1-0-72	Standard	10.5	4482	4173	5343	5774	6236	6687	7149	7601	8283
		COSTH1-0-72	Clean-Out	10.5	4649	5038	5510	5941	6403	6854	7316	7768	8450
W: 72													
SW: 72													



HBCH SYSTEMS - STANDARD OR CLEAN-OUT SEAT

	MODEL	SEAT STYLE	YARDS	COM	M	COL						W/WL
						O	P	R	S	T	U	
22.5° INSIDE CURVE W: 22.5-34 D: 30 H: 50 SW: 22.5-34 SD: 19.5 SH: 18 BH: 33	CICH1-0-22	Standard	5	1913	2098	2323	2528	2748	2963	3183	3398	3723
	COICH1-0-22	Clean-Out	5	2025	2210	2435	2640	2860	3075	3295	3510	3835



45° INSIDE CURVE W: 22.5-45 SW: 22.5-45	CICH1-0-45	Standard	7	2501	2760	3075	3362	3670	3971	4279	4580	5035
	COICH1-0-45	Clean-Out	7	2664	2923	3238	3525	3833	4134	4442	4743	5198



22.5° OUTSIDE CURVE W: 34 D: 30 H: 50 SW: 34 SD: 19.5 SH: 18 BH: 33	COCH1-0-22	Standard	5.25	1872	2066	2303	2518	2749	2975	3206	3431	3773
	COOCH1-0-22	Clean-Out	5.25	1983	2177	2414	2629	2860	3086	3317	3542	3884



45° OUTSIDE CURVE W: 45 SW: 45	COCH1-0-45	Standard	6	2422	2644	2914	3160	3424	3682	3946	4204	4594
	COOCH1-0-45	Clean-Out	6	2532	2754	3024	3270	3534	3792	4056	4314	4704



90° INSIDE CORNER W: 30 SW: 19.5 NOTE: 5 Legs used	CECH1-0-90	Standard	8.75	2550	2874	3268	3626	4011	4388	4773	5149	5718
	COECH1-0-90	Clean-Out	8.75	2771	3095	3489	3847	4232	4609	4994	5370	5939



90° END UNITS (LT/RT) W: 30 SW: 19.5 NOTE: Must choose placement: (4) Right as seated (Left End) or (5) Left as seated (Right End)	CECH1-0-90 (4/5)	Standard	8.75	2550	2874	3268	3626	4011	4388	4773	5149	5718
	COECH1-0-90 (4/5)	Clean-Out	9.25	2771	3095	3489	3847	4232	4609	4994	5370	5939



4 - Right as seated (Left End)



5 - Left as seated (Right End)

26° END UNITS (LT/RT) W: 37 SW: 26 NOTE: Must choose placement: (4) Right as seated (Left End) or (5) Left as seated (Right End)	CECH1-0-26 (4/5)	Standard	10.25	3129	3508	3970	4390	4841	5282	5733	6173	6840
	COECH1-0-26 (4/5)	Clean-Out	10.25	3235	3614	4076	4496	4947	5388	5839	6279	6946





4 - Right as seated (Left End)



5 - Left as seated (Right End)



SYSTEMS | GANGING OPTIONS

		MODEL	PRICE
RIGID PLATE CONNECTOR		RPC	26 LIST
CENTER POST LEG		RPL1	106 LIST

SYSTEMS | LEG OPTIONS

		MODEL	PRICE
BRUSHED ALUMINUM LEGS		4BA	340 LIST/SET OF 4

	MODEL	DESCRIPTION	PRICE
WOOD LEGS	GGCH4	Specify Wood Finish	340 LIST/SET OF 4

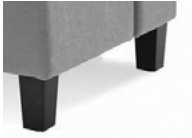

	MODEL	DESCRIPTION	PRICE
POWDER COAT SLED BASE	CHSB(_1)	Powder coat color must be specified. Not available in Brushed Chrome finish.	320 LIST EACH

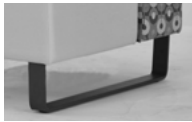

	MODEL	DESCRIPTION	PRICE
SEAT-TO-SEAT SLED BASE	CHSBSS(_)	Powder coat color must be specified. Not available in Brushed Chrome finish.	435 LIST EACH

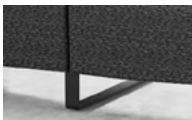



SYSTEMS | ARM OPTIONS

UPHOLSTERED ARMS

D: 26

H: 26



MODEL	W	YARDS	COM	M	COL								W/WL
					O	P	R	S	T	U			
CU(L/R)2													
PAIR LEFT (L) and RIGHT (R) ARMS	11	2.5	826	919	1031	1134	1244	1351	1461	1569	1731		
EACH LEFT (L) or RIGHT (R) ARM	5.5	1.25	413	459	516	567	622	676	731	784	866		

BENT WOOD ARMS

D: 26

H: 25



MODEL	W	PRICE
BB(L/R)		
PAIR LEFT (L) and RIGHT (R) ARMS	11	676
EACH LEFT (L) or RIGHT (R) ARM	5.5	338

ATRIUM ARMS

D: 26

H: 26



MODEL	W	DESCRIPTION	PRICE
BC(L/R)		Brushed Chrome Solid Steel Arm	
PAIR LEFT (L) and RIGHT (R) ARMS	4		1062
EACH LEFT (L) or RIGHT (R) ARM	2		531

METAL T-ARMS

D: 10

H: 25.75



MODEL	W	PRICE	A	B	C	D
CHPA(L/R)						
PAIR LEFT (L) and RIGHT (R) ARMS		1034 LIST/PR				
Stocked Solid Surface Arm Caps	2.75		NC	NC	18 LIST/PR	44 LIST/PR
Non-stocked (per color, per order)	2.75		ADD 410 NET	450 NET	490 NET	520 NET
EACH LEFT (L) or RIGHT (R) ARM		517 LIST/ARM				
Stocked Solid Surface Arm Caps	1.375		NC	NC	9 LIST/EA	22 LIST/EA
Non-stocked (per color, per order)	1.375		ADD 410 NET	450 NET	490 NET	520 NET



SYSTEMS | 10" WIDE TABLE ARM OPTIONS

	MODEL		W	YARDS	COM	M	COL							W/WL
							O	P	R	S	T	U		
10" WIDE TABLE ARMS - TALL	C1U(L/R/S)	Upholstered	10	2	619	693	783	865	953	1039	1127	1213	1343	
D: 29	C1K(L/R/S)	Capped	10	1.5	619	675	742	804	870	934	1000	1065	1162	



H: 24.5

NOTE: Specify cap selection from options below and add to capped arm price.
Must choose placement: (L) Left Arm, (R) Right Arm or (S) Seat-to-Seat Arm

	MODEL		W	YARDS	COM	M	COL							W/WL
							O	P	R	S	T	U		
10" WIDE TABLE ARMS - SHORT	C2U(L/R/S)	Upholstered	10	1.75	571	636	715	786	863	939	1016	1091	1205	
D: 29	C2K(L/R/S)	Capped	10	1.25	571	617	674	725	780	834	889	942	1024	



H: 18

NOTE: Specify cap selection from options below and add to capped arm price.
Must choose placement: (L) Left Arm, (R) Right Arm or (S) Seat-to-Seat Arm

10" WIDE | ARM CAP OPTIONS

MODEL	GRADE		A	B	C	D
		Non-stocked (per color, per order)	ADD 410 NET	450 NET	490 NET	520 NET

NOTE: Cap pricing should be added to Capped Arm price. Solid Surface Arm Cap is 1/2" thick.
Pricing above does NOT include legs. Please specify GGCH2 (2 wood legs) or 2BA (2 brushed aluminum legs if legs are required and add \$170 to the list price.

MODEL	DESCRIPTION	PRICE
LAMINATE/PLYWOOD EDGE ARM CAPS	ACCHL	Stocked (Laminate arm caps have a plywood edge. Specify finish.)
		258 LIST
		Non-stocked (per color, per order)
		ADD 50 NET

NOTE: Cap pricing should be added to Capped Arm price.
Pricing above does NOT include legs. Please specify GGCH2 (2 wood legs) or 2BA (2 brushed aluminum legs if legs are required and add \$170 to the list price.

MODEL	DESCRIPTION	PRICE
MAPLE VENEER/PLYWOOD EDGE ARM CAPS	ACCVB	Maple Veneer/Plywood Edge. Specify finish.
		258 LIST

NOTE: Custom Wood Finish (CWF) is a one-time upcharge of 300 NET per color.
Cap pricing should be added to Capped Arm price.
Pricing above does NOT include legs. Please specify GGCH2 (2 wood legs) or 2BA (2 brushed aluminum legs if legs are required and add \$170 to the list price.



SYSTEMS | 6" WIDE TABLE ARM OPTIONS

	MODEL		W	YARDS	COM	M	COL							W/WL
							O	P	R	S	T	U		
6" WIDE TABLE ARMS - TALL	CH3U(L/R/S)	Upholstered	6	1.75	462	527	606	677	754	830	907	982	1096	
D: 29	CH3K(L/R/S)	Capped	6	1.5	462	518	585	647	713	777	843	908	1005	



H: 24.5

NOTE: Specify cap selection from options below and add to capped arm price.
Must choose placement: (L) Left Arm, (R) Right Arm or (S) Seat-to-Seat Arm

	MODEL		W	YARDS	COM	M	COL							W/WL
							O	P	R	S	T	U		
6" WIDE TABLE ARMS - SHORT	CH4U(L/R/S)	Upholstered	6	1.5	409	465	532	594	660	724	790	855	952	
D: 29	CH4K(L/R/S)	Capped	6	1.25	409	455	512	563	618	672	727	780	862	



H: 18

NOTE: Specify cap selection from options below and add to capped arm price.
Must choose placement: (L) Left Arm, (R) Right Arm or (S) Seat-to-Seat Arm

6" WIDE | ARM CAP OPTIONS

	MODEL	GRADE		A	B	C	D
		Non-stocked (per color, per order)	ADD	410 NET	450 NET	490 NET	520 NET

NOTE: Cap pricing should be added to Capped Arm price. Solid Surface Arm Cap is 1/2"-thick.
Pricing above does NOT include legs. Please specify GGCH2 (2 wood legs) or 2BA (2 brushed aluminum legs if legs are required and add \$170 to the list price.

	MODEL	DESCRIPTION		PRICE
		Non-stocked (per color, per order)	ADD	50 NET

NOTE: Cap pricing should be added to Capped Arm price.
Pricing above does NOT include legs. Please specify GGCH2 (2 wood legs) or 2BA (2 brushed aluminum legs if legs are required and add \$170 to the list price.

	MODEL	DESCRIPTION		PRICE

NOTE: Custom Wood Finish (CWF) is a one-time upcharge of 300 NET per color.
Cap pricing should be added to Capped Arm price.
Pricing above does NOT include legs. Please specify GGCH2 (2 wood legs) or 2BA (2 brushed aluminum legs if legs are required and add \$170 to the list price.



SYSTEMS | 22.5° WEDGE TABLE ARM OPTIONS

		COL										
	MODEL	W	YARDS	COM	M	O	P	R	S	T	U	W/WL
22.5° WEDGE TABLE ARMS - TALL	C3U(L/R/S) Upholstered	6	2	785	859	949	1031	1119	1205	1293	1379	1509
	C3K(L/R/S) Capped	6	1.5	785	841	908	970	1036	1100	1166	1231	1328

D: 29
H: 24.5



NOTE: Specify cap selection from options below and add to capped arm price.
Must choose placement: (L) Left Arm, (R) Right Arm or (S) Seat-to-Seat Arm

		COL										
	MODEL	W	YARDS	COM	M	O	P	R	S	T	U	W/WL
22.5° WEDGE TABLE ARMS - SHORT	C4U(L/R/S) Upholstered	6	1.75	731	796	875	946	1023	1099	1176	1251	1365
	C4K(L/R/S) Capped	6	1.25	731	777	834	885	940	994	1049	1102	1184

D: 29
H: 18



NOTE: Specify cap selection from options below and add to capped arm price.
Must choose placement: (L) Left Arm, (R) Right Arm or (S) Seat-to-Seat Arm

22.5° WEDGE | ARM CAP OPTIONS

	MODEL	GRADE	A	B	C	D
SOLID SURFACE ARM CAPS	ACCHWSS	Stocked Solid Surface	527 LIST	596 LIST	695 LIST	853 LIST
		Non-stocked (per color, per order)	ADD 410 NET	450 NET	490 NET	520 NET

NOTE: Cap pricing should be added to Capped Arm price. Solid Surface Arm Cap is 1/2" thick.
Pricing above does NOT include legs. Please specify GGCH3 (3 wood legs) or 3BA (3 brushed aluminum legs if legs are required and add \$255 to the list price.

	MODEL	DESCRIPTION	PRICE
LAMINATE/PLYWOOD EDGE ARM CAPS	ACCHWL	Stocked (Laminate arm caps have a plywood edge. Specify finish.)	281 LIST
		Non-stocked (per color, per order)	ADD 50 NET

NOTE: Cap pricing should be added to Capped Arm price.
Pricing above does NOT include legs. Please specify GGCH3 (3 wood legs) or 3BA (3 brushed aluminum legs if legs are required and add \$255 to the list price.

	MODEL	DESCRIPTION	PRICE
MAPLE VENEER/PLYWOOD EDGE ARM CAPS	ACCVWB	Maple Veneer/Plywood Edge. Specify finish.	281 LIST

NOTE: Custom Wood Finish (CWF) is a one-time upcharge of 300 NET per color.
Cap pricing should be added to Capped Arm price.
Pricing above does NOT include legs. Please specify GGCH3 (3 wood legs) or 3BA (3 brushed aluminum legs if legs are required and add \$255 to the list price.



SYSTEMS | OTHER OPTIONS

	MODEL	DESCRIPTION	PRICE
RECESSED PULL HANDLE	RPH(B/G)	For use with mobile options. Specify Black (B) or Gray (G).	86 LIST

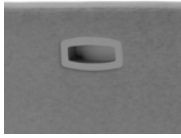

	MODEL	DESCRIPTION	PRICE
ELECTRICAL / POWER PORT	XE3(COLOR)(4/5)	(1) Dual USB and (2) Standard Plug-Ins. Available in All Black (B), All White (W) and Silver with White Outlets (S).	543 LIST/EACH



(B) ALL BLACK



(W) ALL WHITE



(S) SILVER WITH WHITE OUTLETS

NOTE: For Seating, must choose placement in front panel: (4) Electrical on right as seated or (5) Electrical on left as seated
For Tables/Arms, must choose placement in top or front: (4) Electrical on top or (5) Electrical on front

PRODUCT OPTIONS

- MOISTURE BARRIER** \$22 List / Yard
- FIRE WALL / CA T.B. 133** \$82 List / Yard
- TAMPER-RESISTANT FASTENERS** \$51 List / Chair
- PERMA-COAT WOOD LEG PROTECTOR** \$35 List / Leg
- WEIGHTED / THEFT DETERRENT** \$305 List / 25 lb Weight
\$610 List / 50 lb Weight









COFFEE HOUSE COLLECTION | OTTOMANS



CERTIFIED CLEAN AIR GOLD



UPHOLSTERED AND WITH TABLE TOPS

	MODEL	TOP (HARD TOPS ARE 1/2" THICK)	YARDS	COM	M	COL						W/WL	
						O	P	R	S	T	U		
CHAISE W: 22.5 D: 22.75 H: 19	COT1	Upholstered	1.75	1002	1067	1146	1217	1294	1370	1447	1522	1636	
													
30 x 30 SQUARE W: 30 D: 30 H: 17.5	COT2	Upholstered	2.5	1100	1193	1305	1408	1518	1625	1735	1843	2005	
	COT2-L	Stocked Laminate/Plywood Edge	2	1604	1678	1768	1850	1938	2024	2112	2198	2328	
	COT2-S	Stocked Solid Surface	A	2	1881	1955	2045	2127	2215	2301	2389	2475	2605
			B	2	2013	2087	2177	2259	2347	2433	2521	2607	2737
			C	2	2202	2276	2366	2448	2536	2622	2710	2796	2926
D			2	2505	2579	2669	2751	2839	2925	3013	3099	3229	
													
60 x 30 RECTANGLE W: 60 D: 30 H: 17.5	COT3	Upholstered	4.5	1715	1882	2084	2269	2467	2660	2858	3052	3344	
	COT3-L	Stocked Laminate/Plywood Edge	3.5	2544	2674	2831	2975	3129	3279	3433	3584	3811	
	COT3-S	Stocked Solid Surface	A	3.5	3007	3137	3294	3438	3592	3742	3896	4047	4274
			B	3.5	3270	3400	3557	3701	3855	4005	4159	4310	4537
			C	3.5	3649	3779	3936	4080	4234	4384	4538	4689	4916
D			3.5	4256	4386	4543	4687	4841	4991	5145	5296	5523	
													
60 x 30 HALF ROUND W: 60 D: 30 H: 17.5	COT15	Upholstered	4.5	1715	1882	2084	2269	2467	2660	2858	3052	3344	
	COT15-L	Stocked Laminate/Plywood Edge	3.5	2544	2674	2831	2975	3129	3279	3433	3584	3811	
	COT15-S	Stocked Solid Surface	A	3.5	2889	3019	3176	3320	3474	3624	3778	3929	4156
			B	3.5	3151	3281	3438	3582	3736	3886	4040	4191	4418
			C	3.5	3532	3662	3819	3963	4117	4267	4421	4572	4799
D			3.5	4137	4267	4424	4568	4722	4872	5026	5177	5404	
													
18 ROUND DIA: 18 H: 17.5	COT6	Upholstered	1.25	1008	1054	1111	1162	1217	1271	1326	1379	1461	
	COT6-L	Stocked Laminate/Plywood Edge	1.25	1385	1431	1488	1539	1594	1648	1703	1756	1838	
	COT6-S	Stocked Solid Surface	A	1.25	1355	1401	1458	1509	1564	1618	1673	1726	1808
			B	1.25	1431	1477	1534	1585	1640	1694	1749	1802	1884
			C	1.25	1540	1586	1643	1694	1749	1803	1858	1911	1993
D			1.25	1712	1758	1815	1866	1921	1975	2030	2083	2165	
													
24 ROUND DIA: 24 H: 17.5	COT4	Upholstered	1.25	1008	1054	1111	1162	1217	1271	1326	1379	1461	
	COT4-L	Stocked Laminate/Plywood Edge	1.25	1385	1431	1488	1539	1594	1648	1703	1756	1838	
	COT4-S	Stocked Solid Surface	A	1.25	1594	1640	1697	1748	1803	1857	1912	1965	2047
			B	1.25	1698	1744	1801	1852	1907	1961	2016	2069	2151
			C	1.25	1852	1898	1955	2006	2061	2115	2170	2223	2305
D			1.25	2092	2138	2195	2246	2301	2355	2410	2463	2545	
													
30 ROUND DIA: 30 H: 17.5	COT7	Upholstered	2.5	1100	1193	1305	1408	1518	1625	1735	1843	2005	
	COT7-L	Stocked Laminate/Plywood Edge	1.5	1604	1660	1727	1789	1855	1919	1985	2050	2147	
	COT7-S	Stocked Solid Surface	A	1.5	1843	1899	1966	2028	2094	2158	2224	2289	2386
			B	1.5	1975	2031	2098	2160	2226	2290	2356	2421	2518
			C	1.5	2165	2221	2288	2350	2416	2480	2546	2611	2708
D			1.5	2467	2523	2590	2652	2718	2782	2848	2913	3010	
													





NON-STOCKED / CUSTOM FINISH UPCHARGES

Non-Stocked Laminate (per color, per order)	ADD	50 NET
Custom Wood Finish (CWF) (one-time upcharge)	ADD	300 NET

		A	B	C	D
Non-Stocked Solid Surface (per color, per order)	ADD	410 NET	450 NET	490 NET	520 NET



COFFEE HOUSE OTTOMANS

	MODEL	TOP (HARD TOPS ARE 1/2"-THICK)	YARDS	COM	M	COL							
						O	P	R	S	T	U	W/WL	
36 ROUND DIA: 36 H: 17.5 	COT8	Upholstered	3.5	1429	1559	1716	1860	2014	2164	2318	2469	2696	
	COT8-L	Stocked Laminate/Plywood Edge	2.5	2026	2119	2231	2334	2444	2551	2661	2769	2931	
	COT8-S	Stocked Solid Surface	A	2.5	2644	2737	2849	2952	3062	3169	3279	3387	3549
			B	2.5	2854	2947	3059	3162	3272	3379	3489	3597	3759
			C	2.5	3157	3250	3362	3465	3575	3682	3792	3900	4062
D			2.5	3643	3736	3848	3951	4061	4168	4278	4386	4548	
42 ROUND DIA: 42 H: 17.5 	COT9	Upholstered	4.5	1885	2052	2254	2439	2637	2830	3028	3222	3514	
	COT9-L	Stocked Laminate/Plywood Edge	2.5	2679	2772	2884	2987	3097	3204	3314	3422	3584	
	COT9-S	Stocked Solid Surface	A	2.5	3096	3189	3301	3404	3514	3621	3731	3839	4001
			B	2.5	3359	3452	3564	3667	3777	3884	3994	4102	4264
			C	2.5	3739	3832	3944	4047	4157	4264	4374	4482	4644
D			2.5	4346	4439	4551	4654	4764	4871	4981	5089	5251	
22.5° WEDGE W: 35 D: 30 H: 17.5 	COT22	Upholstered	3.5	1429	1559	1716	1860	2014	2164	2318	2469	2696	
	COT22-L	Stocked Laminate/Plywood Edge	3	1856	1967	2102	2225	2357	2486	2618	2747	2942	
	COT22-S	Stocked Solid Surface	A	3	2267	2378	2513	2636	2768	2897	3029	3158	3353
			B	3	2332	2443	2578	2701	2833	2962	3094	3223	3418
			C	3	2424	2535	2670	2793	2925	3054	3186	3315	3510
D			3	2578	2689	2824	2947	3079	3208	3340	3469	3664	
45° WEDGE W: 45 D: 31 H: 17.5 	COT45	Upholstered	3.5	1584	1714	1871	2015	2169	2319	2473	2624	2851	
	COT45-L	Stocked Laminate/Plywood Edge	3	2235	2346	2481	2604	2736	2865	2997	3126	3321	
	COT45-S	Stocked Solid Surface	A	3	2537	2648	2783	2906	3038	3167	3299	3428	3623
			B	3	2625	2736	2871	2994	3126	3255	3387	3516	3711
			C	3	2750	2861	2996	3119	3251	3380	3512	3641	3836
D			3	2942	3053	3188	3311	3443	3572	3704	3833	4028	
NON-STOCKED / CUSTOM FINISH UPCHARGES	Non-Stocked Laminate (per color, per order)		ADD		50 NET								
	Custom Wood Finish (CWF) (one-time upcharge)		ADD		300 NET								
						A	B	C	D				
	Non-Stocked Solid Surface (per color, per order)		ADD		410 NET	450 NET	490 NET	520 NET					



COFFEE HOUSE OTTOMANS | LEG OPTIONS

	MODEL	PRICE
BRUSHED ALUMINUM LEGS	4BA	No Upcharge



	MODEL	DESCRIPTION	PRICE
WOOD LEGS	GGCH4	Specify Wood Finish	No Upcharge



	MODEL	DESCRIPTION	PRICE
3" CASTERS	43C	Set of 4 Locking Casters. Reduces overall height by 2"	No Upcharge



	MODEL	DESCRIPTION	PRICE
5" HEAVY DUTY CASTERS	5C1	Set of 4 Locking Black Casters	136 LIST/SET OF 4

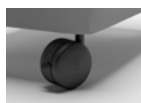

	MODEL	DESCRIPTION	PRICE
POWDER COAT SLED BASE	CHSB(_)	Powder coat color must be specified. Not available in Brushed Chrome finish.	300 LIST/PR
	NOTE: Only available on 30x30 Square, 60x30 Rectangle, 22.5° Wedge, and 45° Wedge Ottomans.		



	MODEL	DESCRIPTION	PRICE
5" BAR LEGS	5BR4() PC	Powder Coat Finish	96 LIST/SET OF 4
	5BR4() BC	Brushed Chrome Finish	264 LIST/SET OF 4

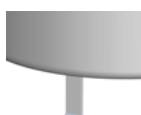

NOTE: Coordinating Leg to the Sled Bases for Round Ottomans



COFFEE HOUSE OTTOMANS | TABLET OPTIONS

ALL INTEGRA TABLETS HAVE A 300LB CAPACITY

Only available on 30 x 30 Square, 60 x 30 Rectangle, 22.5° Wedge and 45° Wedge Ottomans



Powder Coat selection required for tablet post.

STANDARD PLACEMENT

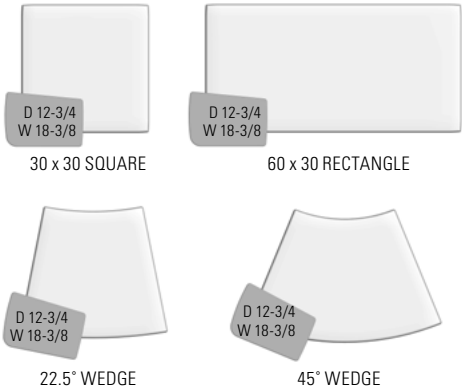

SOLID SURFACE TABLET OPTION

MODEL	GRADE		A	B	C	D
ST-(4/5)	Stocked		812 LIST	848 LIST	900 LIST	983 LIST
	Non-stocked (per color, per order)	ADD	410 NET	450 NET	490 NET	520 NET

LAMINATE OVER PLYWOOD CORE/EDGE TABLET OPTION

MODEL	GRADE	PRICE
LT-(4/5)	Stocked (Laminate tablets have a plywood edge. Specify finish.)	637 LIST
	Non-stocked (per color, per order)	ADD 50 NET

VENEER OVER PLYWOOD CORE/EDGE TABLET OPTION

MODEL	GRADE	PRICE
VT-(4/5)	Standard Wood Finish	637 LIST
	Custom Finish (one time charge per color)	ADD 300 NET

CUP HOLDER

MODEL	FINISH	PRICE
CUPIN	Brushed Aluminum	216 LIST

ELECTRICAL / POWER PORT



MODEL	DESCRIPTION	PRICE
XE3(COLOR)(4/5)	(1) Dual USB and (2) Standard Plug-Ins. Available in All Black (B), All White (W) and Silver with White Outlets (S).	543 LIST/EACH

NOTE: Only available on 30 x 30 Square, 60 x 30 Rectangle, 22.5° Wedge and 45° Wedge Ottomans

PRODUCT OPTIONS

MOISTURE BARRIER	\$22 List / Yard
FIRE WALL / CA T.B. 133	\$82 List / Yard
TAMPER-RESISTANT FASTENERS	\$51 List / Chair
PERMA-COAT WOOD LEG PROTECTOR	\$35 List / Leg
WEIGHTED / THEFT DETERRENT	\$305 List / 25 lb Weight \$610 List / 50 lb Weight



COFFEE HOUSE COLLECTION | SYSTEM SPECIFICATION

SAMPLE CONFIGURATIONS

Inside Semi-Circle Configuration

(8) 22.5° Inside Curved Units

All freestanding units ganged with RPCs - Rigid Plate Connectors
Approximate space needed is 7' 6" x 15'



"L" Corner Configuration

90° Corner Unit and 30" & 45" Straight Units with 10" wide Table/Arms & Optional Tablet

Approximate space needed is 5' 10" x 7' 1"

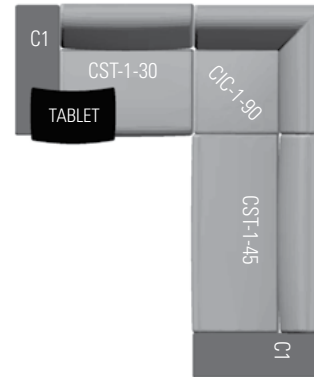

Inside or Outside Semi-Circle Configurations

(4) 45° Inside or Outside Curved Units

All Freestanding units ganged with RPCs - Rigid Plate Connectors
Approximate space needed is 5' x 10' for each

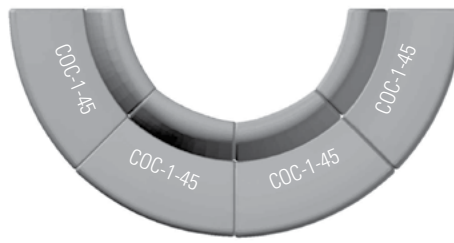

High Back Sofa

26" Left End, 26" Straight & 26" Right End Units.

Approximate space needed is 2' 6" x 8' 3"



Wave Configuration

(4) 45° Inside and (2) 45° Outside Units with a 10" wide Table/Arm in the middle and (2) Wedge Table/Arms & Optional Tablets, Freestanding units ganged with RPCs - Rigid Plate Connectors - except the 10" wide Table/Arm which is Bolted to the adjoining units. Approximate space needed is 3' 6" x 21'



Back to Back Seating Configuration

Varying seat widths and 10" wide Table/Arms, Freestanding Half Oval and Rectangular Ottomans used for maximum seating ganged with Bolts & RPCs - Rigid Plate Connectors for stability.

Approximate space needed is 5' x 15' 6"



HIGH BACK COFFEE HOUSE PRIVACY SEATING

Available in Single (shown), Double, Triple and Quad (shown). Use 26" End Units and add options as desired. Contact Customer Service for additional assistance on specifications.

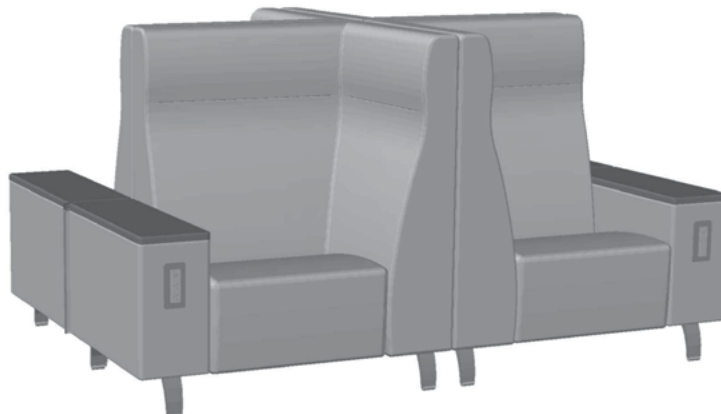



COFFEE HOUSE COLLECTION | SYSTEM SPECIFICATION

GANGING BRACKET INFORMATION

NOTE: The following drawings are shown from the view of the bottom of the units.

Use Bolt and RPC for stability.
Can Use Bolt on both sides.

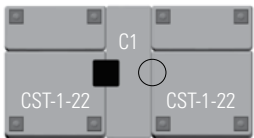

Use Bolt any time 10" wide
Table/Arm is on end.

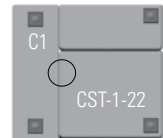

Use RPC for stability.
The Wedge Table Arm with 3 legs is freestanding,
so any of the ganging techniques can be used.

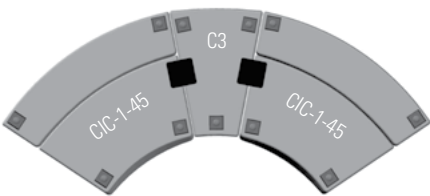

Use Bolt on both sides for stability.
The Wedge Table Arm with no legs cannot stand alone,
so only Bolt connections can be used.

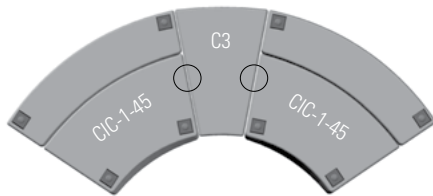



This settee configuration uses (1) RPL - Center Post
Leg and Bolts connecting the 10" Table arms on
each side of the system 2-seat unit for stability.

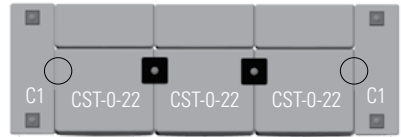

This sofa configuration uses (2) RPLs - Center Post
Legs and Bolts connecting the 10" Table arms on
each side of the system 3-seat unit for stability.



KEY TO COFFEE HOUSE COLLECTION GANGING BRACKETS

-  **RPC** - Rigid Plate Connector provides a semi-permanent connection
-  **BOLT** - Bolt Connection provides a permanent connection
-  **RPL** - Center Post Leg provides a strong leg connection between system seats

KALLISE LOUNGE COLLECTION

KL3 - 3" WIDE UPHOLSTERED ARM	KLC 2 - 4
KL5 - 5" WIDE UPHOLSTERED ARM	KLC 5 - 7
KALLISE BENCHES & OTTOMANS	KLC 8 - 9
KALLISE TABLES	KLC 10 - 12



KALLISE LOUNGE COLLECTION | KL3





CERTIFIED
CLEAN AIR GOLD



KL3 - 3" WIDE UPHOLSTERED ARM

STANDARD WITH POWDER COATED LEGS

	MODEL	LEG HEIGHT	YARDS	COM	M	COL	P	R	S	T	U	W/WL
CHAIR	KL38-1	8"H Legs	4.25	1497	1654	1846	2020	2207	2390	2577	2759	3036
W: 30.5 D: 30 H: 32 SW: 24 SD: 21 SH: 18 BH: 16 AH: 24												
SETTEE	KL38-2	8"H Legs	6.5	2282	2523	2815	3082	3368	3647	3933	4213	4635
W: 54.5 SW: 48												
SOFA	KL38-3	8"H Legs	8.75	3067	3391	3785	4143	4528	4905	5290	5666	6235
W: 78.5 SW: 72												

KL3 | LEG OPTIONS

	MODEL	DESCRIPTION	PRICE
8"H STEEL CYLINDER LEGS WITH POWDER COAT FINISH	KL()4	Powder coat color must be specified	No Upcharge



	MODEL	DESCRIPTION	PRICE
8"H SOLID WOOD LEGS	KLW4	Standard Wood Finish	100 LIST/SET OF 4



	MODEL	DESCRIPTION	PRICE
8"H STEEL SLED BASE WITH POWDER COAT FINISH	KLS()	Powder coat color must be specified	360 LIST/SET OF 2



	MODEL	FOR USE WITH	DESCRIPTION	ADD TO LEG PRICE
8"H CASTERS (STRAIGHT LEGS ONLY)	KL()C4	Powder Coat Legs	Set of 4 Non-Locking Black Casters	52 LIST/SET OF 4
	KLWC4	Solid Wood Legs	Set of 4 Non-Locking Black Casters	156 LIST/SET OF 4



NOTE: Recommended for use on Chairs only, not on Settees and Sofas.

	MODEL	FOR USE WITH	DESCRIPTION	ADD TO LEG PRICE
8"H COMBINATION CASTERS AND LEGS (STRAIGHT LEGS ONLY)	KL()C2F/C2R	Powder Coat Legs	Set of 2 Non-Locking Casters in Front and 2 Standard Legs in Rear	26 LIST/SET OF 2
	KLWC2F/C2R	Solid Wood Legs	Set of 2 Non-Locking Casters in Front and 2 Standard Legs in Rear	128 LIST/SET OF 2



NOTE: C2F - (2) 2" Non-locking Casters in Front and (2) Standard Legs in Rear
C2R - (2) Standard Legs in Front and (2) 2" Non-locking Casters in Rear

Recommended for use on Chairs only, not on Settees and Sofas.



KL3 | ARM CAP OPTIONS

SOLID SURFACE ARM CAPS



MODEL	GRADE	A	B	C	D
ACKL3S	Stocked Solid Surface	292 LIST/PR	316 LIST/PR	350 LIST/PR	404 LIST/PR
	Non-stocked (per color, per order)	ADD 410 NET	450 NET	490 NET	520 NET

NOTE: Arm Caps are flat on the top with tapering beveled edges. The flat surface is 9/16" less than width of arm.

LAMINATE/PLYWOOD EDGE ARM CAPS



MODEL	DESCRIPTION	PRICE
ACKL3L	Stocked Laminate over Plywood Core/Edge. Specify finish.	180 LIST/PR
	Non-stocked (per color, per order)	ADD 50 NET

NOTE: Arm Caps are flat on the top with tapering beveled edges. The flat surface is 9/16" less than width of arm.

MAPLE VENEER OVER PLYWOOD CORE/EDGE ARM CAPS



MODEL	DESCRIPTION	PRICE
ACKL3M	Maple Veneer over Plywood Core/Edge. Specify finish.	202 LIST/PR

NOTE: Arm Caps are flat on the top with tapering beveled edges. The flat surface is 9/16" less than width of arm. Custom Wood Finish (CWF) is a one-time upcharge of 300 NET per color.

KL3 | TABLET OPTIONS

ALL INTEGRA TABLETS HAVE A 300LB CAPACITY



Tablets available in Upholstered Arms with and without Arm Caps.

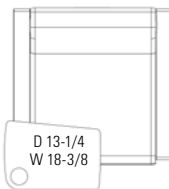
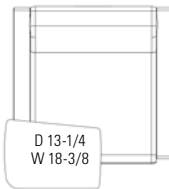

With Cup Holder Option

CHOOSE POSITION

(4)

(5)

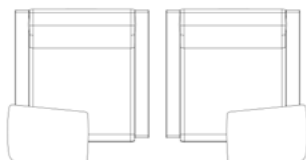

(4) - Tablet on right as seated

(5) - Tablet on left as seated

SOLID SURFACE TABLET OPTION

MODEL	GRADE	A	B	C	D
ST-(4/5)	Stocked	723 LIST/PR	759 LIST/PR	811 LIST/PR	894 LIST/PR
	Non-stocked (per color, per order)	ADD 410 NET	115 NET	490 NET	520 NET

LAMINATE OVER PLYWOOD CORE/EDGE TABLET OPTION

MODEL	GRADE	PRICE
LT-(4/5)	Stocked (Laminate tablets have a plywood edge. Specify finish.)	548 LIST
	Non-stocked (per color, per order)	ADD 50 NET

VENEER OVER PLYWOOD CORE/EDGE TABLET OPTION

MODEL	GRADE	PRICE
VT-(4/5)	Standard Wood Finish	548 LIST
	Custom Finish (one time charge per color)	ADD 300 NET

CUP HOLDER

MODEL	FINISH	PRICE
CUPIN	Brushed Aluminum	216 LIST



KL3 | OTHER OPTIONS

	MODEL	DESCRIPTION	PRICE
RECESSED PULL HANDLE	RPH(B/G)	For use with mobile options. Specify Black (B) or Gray (G).	86 LIST



	MODEL	DESCRIPTION	PRICE
ELECTRICAL / POWER PORT	EP(COLOR)	(1) Standard Plug-In. Available in Black, Gray, Poppy and White.	114 LIST/EACH
	ES(COLOR)	(2) USB Ports. Available in Black, Gray, Poppy and White.	288 LIST/EACH



PRODUCT OPTIONS

- MOISTURE BARRIER** \$22 List / Yard
- FIRE WALL / CA T.B. 133** \$82 List / Yard
- TAMPER-RESISTANT FASTENERS** \$51 List / Chair
- PERMA-COAT WOOD LEG PROTECTOR** \$35 List / Leg



KALLISE LOUNGE COLLECTION | KL5



CERTIFIED
CLEAN AIR GOLD





COMPONENT-BASED
CONSTRUCTION

2K STATIC
CAPACITY

1K DROP
CAPACITY

KL5 - 5" WIDE UPHOLSTERED ARM

STANDARD WITH POWDER COATED LEGS

	MODEL	LEG HEIGHT	YARDS	COM	M	COL O	P	R	S	T	U	W/WL	
CHAIR W: 33.5 D: 30 H: 32 SW: 24 SD: 21 SH: 18 BH: 16 AH: 24		KL58-1	8"H Legs	4.25	1527	1684	1876	2050	2237	2420	2607	2789	3066
SETTEE W: 57.5 SW: 48		KL58-2	8"H Legs	6.5	2312	2553	2845	3112	3398	3677	3963	4243	4665
SOFA W: 81.5 SW: 72		KL58-3	8"H Legs	8.75	3097	3421	3815	4173	4558	4935	5320	5696	6265

KL5 | LEG OPTIONS

	MODEL	DESCRIPTION	PRICE
8"H STEEL CYLINDER LEGS WITH POWDER COAT FINISH	KL()4	Powder coat color must be specified	No Upcharge



	MODEL	DESCRIPTION	PRICE
8"H SOLID WOOD LEGS	KLW4	Standard Wood Finish	100 LIST/SET OF 4



	MODEL	DESCRIPTION	PRICE
8"H STEEL SLED BASE WITH POWDER COAT FINISH	KLS()	Powder coat color must be specified	360 LIST/SET OF 2



	MODEL	FOR USE WITH	DESCRIPTION	ADD TO LEG PRICE
8"H CASTERS (STRAIGHT LEGS ONLY)	KL()C4	Powder Coat Legs	Set of 4 Non-Locking Black Casters	52 LIST/SET OF 4
	KLWC4	Solid Wood Legs	Set of 4 Non-Locking Black Casters	156 LIST/SET OF 4



NOTE: Recommended for use on Chairs only, not on Settees and Sofas.

	MODEL	FOR USE WITH	ADD TO LEG PRICE
8"H COMBINATION CASTERS AND LEGS (STRAIGHT LEGS ONLY)	KL()C2F/C2R	Powder Coat Legs	26 LIST/SET OF 2
	KLWC2F/C2R	Solid Wood Legs	128 LIST/SET OF 2



NOTE: C2F - (2) 2" Non-locking Casters in Front and (2) Standard Legs in Rear
C2R - (2) Standard Legs in Front and (2) 2" Non-locking Casters in Rear

Recommended for use on Chairs only, not on Settees and Sofas.



KL5 | ARM CAP OPTIONS

SOLID SURFACE ARM CAPS

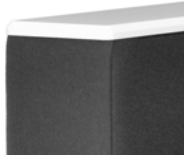

MODEL	GRADE	A	B	C	D
ACKL5S	Stocked Solid Surface	372 LIST/PR	402 LIST/PR	452 LIST/PR	526 LIST/PR
	Non-stocked (per color, per order)	ADD 410 NET	115 Net	490 NET	520 NET

NOTE: Arm Caps are flat on the top with tapering beveled edges. The flat surface is 9/16" less than width of arm.

LAMINATE/PLYWOOD EDGE ARM CAPS



MODEL	DESCRIPTION	PRICE
ACKL5L	Stocked Laminate over Plywood Core/Edge. Specify finish.	210 LIST/PR
	Non-stocked (per color, per order)	ADD 50 NET

NOTE: Arm Caps are flat on the top with tapering beveled edges. The flat surface is 9/16" less than width of arm.

MAPLE VENEER OVER PLYWOOD CORE/EDGE ARM CAPS



MODEL	DESCRIPTION	PRICE
ACKL5M	Maple Veneer over Plywood Core/Edge. Specify finish.	246 LIST/PR

NOTE: Arm Caps are flat on the top with tapering beveled edges. The flat surface is 9/16" less than width of arm. Custom Wood Finish (CWF) is a one-time upcharge of 300 NET per color.

KL5 | TABLET OPTIONS

ALL INTEGRA TABLETS HAVE A 300LB CAPACITY



Tablets available in Upholstered Arms with and without Arm Caps.

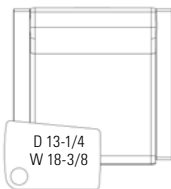
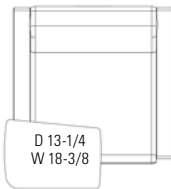

CHOOSE POSITION

(4)

(5)

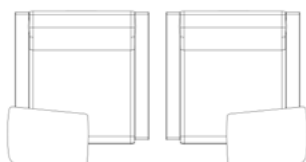

(4) - Tablet on right as seated

(5) - Tablet on left as seated

SOLID SURFACE TABLET OPTION

MODEL	GRADE	A	B	C	D
ST-(4/5)	Stocked	723 LIST	759 LIST	811 LIST	894 LIST
	Non-stocked (per color, per order)	ADD 410 NET	450 NET	490 NET	520 NET

LAMINATE OVER PLYWOOD CORE/EDGE TABLET OPTION

MODEL	GRADE	PRICE
LT-(4/5)	Stocked (Laminate tablets have a plywood edge. Specify finish.)	548 LIST
	Non-stocked (per color, per order)	ADD 50 NET

VENEER OVER PLYWOOD CORE/EDGE TABLET OPTION

MODEL	GRADE	PRICE
VT-(4/5)	Standard Wood Finish	548 LIST
	Custom Finish (one time charge per color)	ADD 300 NET

CUP HOLDER

MODEL	FINISH	PRICE
CUPIN	Brushed Aluminum	216 LIST



KL5 | OTHER OPTIONS

	MODEL	DESCRIPTION	PRICE
RECESSED PULL HANDLE	RPH(B/G)	For use with mobile options. Specify Black (B) or Gray (G).	86 LIST



	MODEL	DESCRIPTION	PRICE
ELECTRICAL / POWER PORT	EP(COLOR)	(1) Standard Plug-In. Available in Black, Gray, Poppy and White.	114 LIST/EACH
	ES(COLOR)	(2) USB Ports. Available in Black, Gray, Poppy and White.	288 LIST/EACH



PRODUCT OPTIONS

- MOISTURE BARRIER** \$22 List / Yard
- FIRE WALL / CA T.B. 133** \$82 List / Yard
- TAMPER-RESISTANT FASTENERS** \$51 List / Chair
- PERMA-COAT WOOD LEG PROTECTOR** \$35 List / Leg



KALLISE LOUNGE COLLECTION | OTTOMANS & BENCHES





CERTIFIED CLEAN AIR GOLD





KALLISE OTTOMANS

STANDARD WITH POWDER COATED LEGS

	MODEL	TOP (HARD TOPS ARE 1/2"-THICK)	GRADE	YARDS	COM	M	COL				T	U	W/WL
							O	P	R	S			
24 x 22 RECTANGLE W: 24 D: 22 H: 18  Upholstered Ottoman  Ottoman with Top	K01	Upholstered		1.5	687	743	810	872	938	1002	1068	1133	1230
	K0T1-L	Stocked Laminate/Plywood Edge		1	781	818	863	904	948	991	1035	1078	1143
	K0T1-V	Maple Veneer/Plywood Edge		1	954	991	1036	1077	1121	1164	1208	1251	1316
	K0T1-S	Stocked Solid Surface	A	1	1259	1296	1341	1382	1426	1469	1513	1556	1621
			B	1	1339	1376	1421	1462	1506	1549	1593	1636	1701
		C	1	1454	1491	1536	1577	1621	1664	1708	1751	1816	
		D	1	1638	1675	1720	1761	1805	1848	1892	1935	2000	

NOTE: Laminate tops have a plywood edge. Specify finish.

30 x 22 RECTANGLE W: 30 D: 22 H: 18  Upholstered Ottoman  Ottoman with Top	K02	Upholstered		1.75	792	857	936	1007	1084	1160	1237	1312	1426
	K0T2-L	Stocked Laminate/Plywood Edge		1.25	944	990	1047	1098	1153	1207	1262	1315	1397
	K0T2-V	Maple Veneer/Plywood Edge		1.25	1111	1157	1214	1265	1320	1374	1429	1482	1564
	K0T2-S	Stocked Solid Surface	A	1.25	1392	1438	1495	1546	1601	1655	1710	1763	1845
			B	1.25	1470	1516	1573	1624	1679	1733	1788	1841	1923
		C	1.25	1586	1632	1689	1740	1795	1849	1904	1957	2039	
		D	1.25	1769	1815	1872	1923	1978	2032	2087	2140	2222	



NOTE: Laminate tops have a plywood edge. Specify finish.

NON-STOCKED / CUSTOM FINISH UPCHARGES

Non-Stocked Laminate (per color, per order)	ADD	50 NET
Custom Wood Finish (CWF) (one-time upcharge)	ADD	300 NET

		A	B	C	D
Non-Stocked Solid Surface (per color, per order)	ADD	410 NET	450 NET	490 NET	520 NET

KALLISE BENCHES

	MODEL	YARDS	COM	M	COL				T	U	W/WL
					O	P	R	S			
48 x 22 BENCH W: 48 D: 22 H: 18 	K03	2	912	986	1076	1158	1246	1332	1420	1506	1636
60 x 22 BENCH W: 60 D: 22 H: 18 	K04	3	1126	1237	1372	1495	1627	1756	1888	2017	2212
72 x 22 BENCH W: 72 D: 22 H: 18 	K05	3.25	1234	1354	1501	1634	1777	1917	2060	2199	2411



KALLISE BENCHES | OPTIONS



Metal Wrap



Available on 48", 60", and 72"-wide benches

METAL WRAP WITH SOLID SURFACE TABLE TOP

MODEL	GRADE		A	B	C	D
KOWT1S	Stocked		913 LIST	982 LIST	1079 LIST	1237 LIST
	Non-stocked (per color, per order)	ADD	410 NET	450 NET	490 NET	520 NET

METAL WRAP WITH LAMINATE/PLYWOOD EDGE TABLE TOP

MODEL	GRADE		PRICE
KOWT1L	Stocked (Laminate table top has a plywood edge. Specify finish.)		762 LIST
	Non-stocked (per color, per order)	ADD	50 NET

METAL WRAP WITH MAPLE VENEER/PLYWOOD EDGE TABLE TOP

MODEL	GRADE		PRICE
KOWT1V	Standard Wood Finish		762 LIST
	Custom Finish (one time charge per color)	ADD	300 NET

NOTE: Powder Coat finish must be specified. Can be secured to bench, please specify.

KALLISE OTTOMANS AND BENCHES | LEG OPTIONS

8"H STEEL CYLINDER LEGS WITH POWDER COAT FINISH



MODEL	DESCRIPTION	PRICE
KL(__)4	Powder coat color must be specified	No Upcharge

8"H SOLID WOOD LEGS



MODEL	DESCRIPTION	PRICE
KLW4	Standard Wood Finish	100 LIST/SET OF 4

8"H STEEL SLED BASE WITH POWDER COAT FINISH



MODEL	DESCRIPTION	PRICE
KLOS(__)	Powder coat color must be specified	361 LIST/SET OF 2

PRODUCT OPTIONS

MOISTURE BARRIER	\$22 List / Yard
FIRE WALL / CA T.B. 133	\$82 List / Yard
TAMPER-RESISTANT FASTENERS	\$51 List / Chair
PERMA-COAT WOOD LEG PROTECTOR	\$35 List / Leg



KALLISE LOUNGE COLLECTION | TABLES

LAMINATE AND SOLID SURFACE TOPS COMPLIANT WITH



CERTIFIED CLEAN AIR GOLD



KALLISE TABLES - ROUND, SQUARE, AND RECTANGLE

22 ROUND x 18H

DIA: 22 H: 18



MODEL	TOP (1.5"-THICK)	POWDER COAT LEGS (PC)	WOOD LEGS (WL)
KLTB-M-22D18(____)	Veneer over Plywood Core/Edge*	982	982
KLTB-L-22D18(____)	Stocked Laminate over Plywood Core/Edge	982	982
	Non-stocked Laminate (per color, per order)	ADD 50 NET	50 NET

NOTE: Custom Wood Finish (CWF) is a one-time upcharge of 300 NET per color.

MODEL	SOLID SURFACE TOP (1.5"-THICK)	POWDER COAT LEGS			
		A	B	C	D
KLTB-S-22D18PC	Stocked	1727 LIST	1727 LIST	2133 LIST	2505 LIST
	Non-stocked (per color, per order)	ADD 410 NET	450 NET	490 NET	520 NET

MODEL	SOLID SURFACE TOP (1.5"-THICK)	WOOD LEGS			
		A	B	C	D
KLTB-S-22D18WL	Stocked	1727 LIST	1727 LIST	2133 LIST	2505 LIST
	Non-stocked (per color, per order)	ADD 410 NET	450 NET	490 NET	520 NET

*Veneer Tops are not compliant with Clean Air Gold Certification or Healthier Hospitals Initiative.

22 ROUND x 22H

DIA: 22 H: 22



MODEL	TOP (1.5"-THICK)	POWDER COAT LEGS (PC)	WOOD LEGS (WL)
KLTB-M-22D22(____)	Veneer over Plywood Core/Edge*	998	998
KLTB-L-22D22(____)	Stocked Laminate over Plywood Core/Edge	998	998
	Non-stocked Laminate (per color, per order)	ADD 50 NET	50 NET

NOTE: Custom Wood Finish (CWF) is a one-time upcharge of 300 NET per color.

MODEL	SOLID SURFACE TOP (1.5"-THICK)	POWDER COAT LEGS			
		A	B	C	D
KLTB-S-22D22PC	Stocked	1743 LIST	1743 LIST	2149 LIST	2521 LIST
	Non-stocked (per color, per order)	ADD 410 NET	450 NET	490 NET	520 NET

MODEL	SOLID SURFACE TOP (1.5"-THICK)	WOOD LEGS			
		A	B	C	D
KLTB-S-22D22WL	Stocked	1743 LIST	1743 LIST	2149 LIST	2521 LIST
	Non-stocked (per color, per order)	ADD 410 NET	450 NET	490 NET	520 NET

*Veneer Tops are not compliant with Clean Air Gold Certification or Healthier Hospitals Initiative.



KALLISE TABLES - ROUND, SQUARE, AND RECTANGLE

22 SQUARE x 18H

W: 22 D: 22

H: 18



MODEL	TOP (1.5"-THICK)	POWDER COAT LEGS (PC)	WOOD LEGS (WL)
KLTB-M-222218 (__)	Veneer over Plywood Core/Edge*	937	937
KLTB-L-222218 (__)	Stocked Laminate over Plywood Core/Edge	937	937
	Non-stocked Laminate (per color, per order)	ADD 50 NET	50 NET

NOTE: Custom Wood Finish (CWF) is a one-time upcharge of 300 NET per color.

MODEL	SOLID SURFACE TOP (1.5"-THICK)	POWDER COAT LEGS			
		A	B	C	D
KLTB-S-222218PC	Stocked	1727 LIST	1727 LIST	2133 LIST	2505 LIST
	Non-stocked (per color, per order)	ADD 410 NET	450 NET	490 NET	520 NET

MODEL	SOLID SURFACE TOP (1.5"-THICK)	WOOD LEGS			
		A	B	C	D
KLTB-S-222218WL	Stocked	1727 LIST	1727 LIST	2133 LIST	2505 LIST
	Non-stocked (per color, per order)	ADD 410 NET	450 NET	490 NET	520 NET

*Veneer Tops are not compliant with Clean Air Gold Certification or Healthier Hospitals Initiative.

22 SQUARE x 22H

W: 22 D: 22

H: 22



MODEL	TOP (1.5"-THICK)	POWDER COAT LEGS (PC)	WOOD LEGS (WL)
KLTB-M-222222 (__)	Veneer over Plywood Core/Edge*	953	953
KLTB-L-222222 (__)	Stocked Laminate over Plywood Core/Edge	953	953
	Non-stocked Laminate (per color, per order)	ADD 50 NET	50 NET

NOTE: Custom Wood Finish (CWF) is a one-time upcharge of 300 NET per color.

MODEL	SOLID SURFACE TOP (1.5"-THICK)	POWDER COAT LEGS			
		A	B	C	D
KLTB-S-222222PC	Stocked	1743 LIST	1743 LIST	2149 LIST	2521 LIST
	Non-stocked (per color, per order)	ADD 410 NET	450 NET	490 NET	520 NET

MODEL	SOLID SURFACE TOP (1.5"-THICK)	WOOD LEGS			
		A	B	C	D
KLTB-S-222222WL	Stocked	1743 LIST	1743 LIST	2149 LIST	2521 LIST
	Non-stocked (per color, per order)	ADD 410 NET	450 NET	490 NET	520 NET

*Veneer Tops are not compliant with Clean Air Gold Certification or Healthier Hospitals Initiative.



KALLISE TABLES - ROUND, SQUARE, AND RECTANGLE

	MODEL	TOP (1.5"-THICK)	POWDER COAT LEGS (PC)	WOOD LEGS (WL)
46 x 20 RECTANGLE W: 46 D: 20 H: 18	KLTB-M-462018 (__)	Veneer over Plywood Core/Edge*	1138	1138
	KLTB-L-462018 (__)	Stocked Laminate over Plywood Core/Edge	1138	1138
		Non-stocked Laminate (per color, per order)	ADD 50 NET	50 NET



NOTE: Custom Wood Finish (CWF) is a one-time upcharge of 300 NET per color.

MODEL	SOLID SURFACE TOP (1.5"-THICK)	POWDER COAT LEGS			
		A	B	C	D
KLTB-S-462018PC	Stocked	2473 LIST	2473 LIST	3121 LIST	3717 LIST
	Non-stocked (per color, per order)	ADD 410 NET	450 NET	490 NET	520 NET

MODEL	SOLID SURFACE TOP (1.5"-THICK)	WOOD LEGS			
		A	B	C	D
KLTB-S-462018WL	Stocked	2473 LIST	2473 LIST	3121 LIST	3717 LIST
	Non-stocked (per color, per order)	ADD 410 NET	450 NET	490 NET	520 NET

*Veneer Tops are not compliant with Clean Air Gold Certification or Healthier Hospitals Initiative.

	MODEL	TOP (1.5"-THICK)	POWDER COAT LEGS (PC)	WOOD LEGS (WL)
46 x 16 RECTANGLE W: 46 D: 16 H: 29	KLTB-M-461629 (__)	Veneer over Plywood Core/Edge*	1290	1290
	KLTB-L-461629 (__)	Stocked Laminate over Plywood Core/Edge	1290	1290
		Non-stocked Laminate (per color, per order)	ADD 50 NET	50 NET



NOTE: Custom Wood Finish (CWF) is a one-time upcharge of 300 NET per color.

MODEL	SOLID SURFACE TOP (1.5"-THICK)	POWDER COAT LEGS			
		A	B	C	D
KLTB-S-461629PC	Stocked	2625 LIST	2625 LIST	3273 LIST	3869 LIST
	Non-stocked (per color, per order)	ADD 410 NET	450 NET	490 NET	520 NET

MODEL	SOLID SURFACE TOP (1.5"-THICK)	WOOD LEGS			
		A	B	C	D
KLTB-S-461629WL	Stocked	2625 LIST	2625 LIST	3273 LIST	3869 LIST
	Non-stocked (per color, per order)	ADD 410 NET	450 NET	490 NET	520 NET

*Veneer Tops are not compliant with Clean Air Gold Certification or Healthier Hospitals Initiative.

KALLISE TABLES | OPTIONS

	MODEL	DESCRIPTION	PRICE
3/4" GLASS TOP	GLASS	3/4" Glass (set on top)	Contact Customer Service for Options and Pricing



PRODUCT OPTIONS

PERMA-COAT WOOD LEG PROTECTOR \$35 List / Leg



PAX LOUNGE COLLECTION

PAX SEATING	PLC 2 - 3
PAX POUFS	PLC 4 - 5
PAX TABLES	PLC 6 - 9



PAX LOUNGE COLLECTION | WOOD LEGS



CERTIFIED
CLEAN AIR GOLD



PAX SOLID WOOD LEGS

	MODEL	YARDS	COM	M	COL O	P	R	S	T	U	W/WL
CHAIR	PLU-1	4.75	1904	2080	2294	2488	2697	2902	3111	3315	3624
W: 30.5 D: 30 H: 32 SW: 24 SD: 21 SH: 18 BH: 16 AH: 24											
SETTEE	PLU-2	7	2740	2999	3314	3601	3909	4210	4518	4819	5274
W: 54.5 SW: 48											
SOFA	PLU-3	9.25	3593	3935	4352	4731	5138	5536	5943	6340	6942
W: 78.5 SW: 72											

PAX SOLID WOOD LEGS WITH METAL SLEEVES

	MODEL	YARDS	COM	M	COL O	P	R	S	T	U	W/WL
CHAIR	PLU-S-1	4.75	2028	2204	2418	2612	2821	3026	3235	3439	3748
W: 30.5 D: 30 H: 32 SW: 24 SD: 21 SH: 18 BH: 16 AH: 24											
SETTEE	PLU-S-2	7	2864	3123	3438	3725	4033	4334	4642	4943	5398
W: 54.5 SW: 48											
SOFA	PLU-S-2	9.25	3717	4059	4476	4855	5262	5660	6067	6464	7066
W: 78.5 SW: 72											

PAX LOUNGE | TABLET OPTIONS

ALL INTEGRA TABLETS HAVE A 300LB CAPACITY

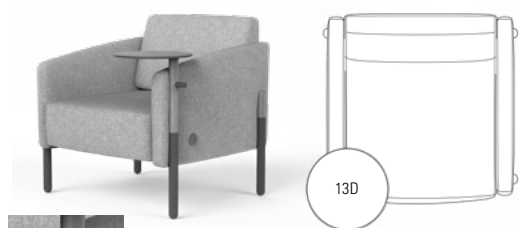

Personal Item Hook is standard on all Tablets

CHOOSE POSITION

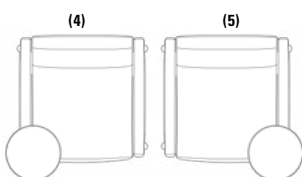

(4) - Tablet on right as seated
(5) - Tablet on left as seated

13" ROUND SOLID SURFACE TABLET OPTION

MODEL	GRADE	A	B	C	D
ST4-(4/5)	Stocked	613 LIST	636 LIST	668 LIST	722 LIST
	Non-stocked (per color, per order)	ADD 410 NET	450 NET	490 NET	520 NET

13" ROUND LAMINATE OVER PLYWOOD CORE/EDGE TABLET OPTION

MODEL	GRADE	PRICE
LT4-(4/5)	Stocked (Laminate tablets have a plywood edge. Specify finish.)	524 LIST
	Non-stocked (per color, per order)	ADD 50 NET

13" ROUND VENEER OVER PLYWOOD CORE/EDGE TABLET OPTION

MODEL	GRADE	PRICE
VT4-(4/5)	Standard Wood Finish	524 LIST
	Custom Finish (one time charge per color)	ADD 300 NET



PAX LOUNGE | OTHER OPTIONS

	MODEL	DESCRIPTION	PRICE
RECESSED PULL HANDLE	RPH(B/G)	For use with Casters option. Specify Black (B) or Gray (G).	86 LIST



	MODEL	DESCRIPTION	PRICE
ELECTRICAL / POWER PORT	EP(COLOR)	(1) Standard Plug-In. Available in Black, Gray, Poppy and White.	114 LIST/EACH
	ES(COLOR)	(2) USB Ports. Available in Black, Gray, Poppy and White.	288 LIST/EACH



	MODEL	DESCRIPTION	PRICE
2" CASTERS	PLGC	Set of 4 Non-Locking Casters	56 LIST/SET OF 4



NOTE: Recommended for use on Chairs only, not on Settees and Sofas.

PRODUCT OPTIONS

- MOISTURE BARRIER** \$22 List / Yard
- FIRE WALL / CA T.B. 133** \$82 List / Yard
- TAMPER-RESISTANT FASTENERS** \$51 List / Chair
- PERMA-COAT WOOD LEG PROTECTOR** \$35 List / Leg
- WEIGHTED / THEFT DETERRENT** \$305 List / 25 lb Weight
\$610 List / 50 lb Weight



PAX LOUNGE COLLECTION | POUFS



CERTIFIED
CLEAN AIR GOLD



PAX POUFS - ROUND, SQUARE, AND RECTANGLE

18 ROUND x 18H

DIA: 18 H: 18



MODEL	TOP (HARD TOPS ARE 1/2"-THICK)	GRADE	YARDS	COM	M	COL	O	P	R	S	T	U	W/WL
PLOT18D18U	Upholstered		2.25	739	822	924	1016	1115	1212	1311	1407	1554	
PLOT18D18L	Stocked Laminate/Plywood Edge		1.5	760	816	883	945	1011	1075	1141	1206	1303	
PLOT18D18V	Maple Veneer/Plywood Edge		1.5	760	816	883	945	1011	1075	1141	1206	1303	
PLOT18D18S	Stocked Solid Surface	A	1.5	1002	1058	1125	1187	1253	1317	1383	1448	1545	
		B	1.5	1075	1131	1198	1260	1326	1390	1456	1521	1618	
		C	1.5	1178	1234	1301	1363	1429	1493	1559	1624	1721	
		D	1.5	1344	1400	1467	1529	1595	1659	1725	1790	1887	

18 ROUND x 22H

DIA: 18 H: 22

PLOT18D22U	Upholstered		2.5	755	848	960	1063	1173	1280	1390	1498	1660	
PLOT18D22L	Stocked Laminate/Plywood Edge		1.75	776	841	920	991	1068	1144	1221	1296	1410	
PLOT18D22V	Maple Veneer/Plywood Edge		1.75	776	841	920	991	1068	1144	1221	1296	1410	
PLOT18D22S	Stocked Solid Surface	A	1.75	1018	1083	1162	1233	1310	1386	1463	1538	1652	
		B	1.75	1091	1156	1235	1306	1383	1459	1536	1611	1725	
		C	1.75	1194	1259	1338	1409	1486	1562	1639	1714	1828	
		D	1.75	1360	1425	1504	1575	1652	1728	1805	1880	1994	

22 ROUND x 18H

DIA: 22 H: 18

PLOT22D18U	Upholstered		3	815	926	1061	1184	1316	1445	1577	1706	1901	
PLOT22D18L	Stocked Laminate/Plywood Edge		2	849	923	1013	1095	1183	1269	1357	1443	1573	
PLOT22D18V	Maple Veneer/Plywood Edge		2	849	923	1013	1095	1183	1269	1357	1443	1573	
PLOT22D18S	Stocked Solid Surface	A	2	1138	1212	1302	1384	1472	1558	1646	1732	1862	
		B	2	1211	1285	1375	1457	1545	1631	1719	1805	1935	
		C	2	1313	1387	1477	1559	1647	1733	1821	1907	2037	
		D	2	1479	1553	1643	1725	1813	1899	1987	2073	2203	

22 ROUND x 22H

DIA: 22 H: 22

PLOT22D22U	Upholstered		3.25	832	952	1099	1232	1375	1515	1658	1797	2009	
PLOT22D22L	Stocked Laminate/Plywood Edge		2.25	865	948	1050	1142	1241	1338	1437	1533	1680	
PLOT22D22V	Maple Veneer/Plywood Edge		2.25	865	948	1050	1142	1241	1338	1437	1533	1680	
PLOT22D22S	Stocked Solid Surface	A	2.25	1154	1237	1339	1431	1530	1627	1726	1822	1969	
		B	2.25	1227	1310	1412	1504	1603	1700	1799	1895	2042	
		C	2.25	1330	1413	1515	1607	1706	1803	1902	1998	2145	
		D	2.25	1497	1580	1682	1774	1873	1970	2069	2165	2312	

18 SQUARE x 18H

W: 18 H: 18 D: 18



PLOT181818U	Upholstered		2.25	710	793	895	987	1086	1183	1282	1378	1525	
PLOT181818L	Stocked Laminate/Plywood Edge		1.5	731	787	854	916	982	1046	1112	1177	1274	
PLOT181818V	Maple Veneer/Plywood Edge		1.5	731	787	854	916	982	1046	1112	1177	1274	
PLOT181818S	Stocked Solid Surface	A	1.5	951	1007	1074	1136	1202	1266	1332	1397	1494	
		B	1.5	1025	1081	1148	1210	1276	1340	1406	1471	1568	
		C	1.5	1128	1184	1251	1313	1379	1443	1509	1574	1671	
		D	1.5	1293	1349	1416	1478	1544	1608	1674	1739	1836	

NON-STOCKED / CUSTOM FINISH UPCHARGES

Non-Stocked Laminate (per color, per order)	ADD	50 NET			
Custom Wood Finish (CWF) (one-time upcharge)	ADD	300 NET			
			A	B	C
Non-Stocked Solid Surface (per color, per order)	ADD	410 NET	450 NET	490 NET	520 NET



PAX POUFS - ROUND, SQUARE, AND RECTANGLE

	MODEL	TOP (HARD TOPS ARE 1/2"-THICK)	GRADE	YARDS	COM	M	COL				U	W/WL	
							O	P	R	S			T
18 SQUARE x 22H W: 18 D: 18 H: 22 	PLOT181822U	Upholstered		2.5	727	820	932	1035	1145	1252	1362	1470	1632
	PLOT181822L	Stocked Laminate/Plywood Edge		1.75	748	813	892	963	1040	1116	1193	1268	1382
	PLOT181822V	Maple Veneer/Plywood Edge		1.75	748	813	892	963	1040	1116	1193	1268	1382
	PLOT181822S	Stocked Solid Surface	A	1.75	969	1034	1113	1184	1261	1337	1414	1489	1603
			B	1.75	1042	1107	1186	1257	1334	1410	1487	1562	1676
	C		1.75	1145	1210	1289	1360	1437	1513	1590	1665	1779	
	D		1.75	1311	1376	1455	1526	1603	1679	1756	1831	1945	
22 SQUARE x 18H W: 22 D: 22 H: 18	PLOT222218U	Upholstered		3	792	903	1038	1161	1293	1422	1554	1683	1878
	PLOT222218L	Stocked Laminate/Plywood Edge		2	819	893	983	1065	1153	1239	1327	1413	1543
	PLOT222218V	Maple Veneer/Plywood Edge		2	819	893	983	1065	1153	1239	1327	1413	1543
	PLOT222218S	Stocked Solid Surface	A	2	1085	1159	1249	1331	1419	1505	1593	1679	1809
			B	2	1170	1244	1334	1416	1504	1590	1678	1764	1894
	C		2	1291	1365	1455	1537	1625	1711	1799	1885	2015	
	D		2	1486	1560	1650	1732	1820	1906	1994	2080	2210	
22 SQUARE x 22H W: 22 D: 22 H: 22	PLOT222222U	Upholstered		3.25	811	931	1078	1211	1354	1494	1637	1776	1988
	PLOT222222L	Stocked Laminate/Plywood Edge		2.25	838	921	1023	1115	1214	1311	1410	1506	1653
	PLOT222222V	Maple Veneer/Plywood Edge		2.25	838	921	1023	1115	1214	1311	1410	1506	1653
	PLOT222222S	Stocked Solid Surface	A	2.25	1103	1186	1288	1380	1479	1576	1675	1771	1918
			B	2.25	1188	1271	1373	1465	1564	1661	1760	1856	2003
	C		2.25	1310	1393	1495	1587	1686	1783	1882	1978	2125	
	D		2.25	1504	1587	1689	1781	1880	1977	2076	2172	2319	
46 x 20 RECTANGLE W: 46 D: 20 H: 18 	PLB4620U	Upholstered		3.75	1147	1286	1455	1608	1773	1935	2100	2261	2505
	PLB4620L	Stocked Laminate/Plywood Edge		2.75	1247	1349	1473	1585	1706	1825	1946	2064	2243
	PLB4620V	Maple Veneer/Plywood Edge		2.75	1247	1349	1473	1585	1706	1825	1946	2064	2243
	PLB4620S	Stocked Solid Surface	A	2.75	1791	1893	2017	2129	2250	2369	2490	2608	2787
			B	2.75	1959	2061	2185	2297	2418	2537	2658	2776	2955
	C		2.75	2204	2306	2430	2542	2663	2782	2903	3021	3200	
	D		2.75	2590	2692	2816	2928	3049	3168	3289	3407	3586	

NON-STOCKED / CUSTOM FINISH UPCHARGES

Non-Stocked Laminate (per color, per order)	ADD	50 NET			
Custom Wood Finish (CWF) (one-time upcharge)	ADD	300 NET			
			A	B	C
Non-Stocked Solid Surface (per color, per order)	ADD	410 NET	450 NET	490 NET	520 NET

PAX POUFS | OPTIONS

	MODEL	PRICE
PULL HANDLE	PLPL	30 LIST



PRODUCT OPTIONS

MOISTURE BARRIER	\$22 List / Yard
FIRE WALL / CA T.B. 133	\$82 List / Yard
TAMPER-RESISTANT FASTENERS	\$51 List / Chair
WEIGHTED / THEFT DETERRENT	\$305 List / 25 lb Weight
	\$610 List / 50 lb Weight



PAX LOUNGE COLLECTION | TABLES

LAMINATE AND SOLID SURFACE TOPS COMPLIANT WITH



CERTIFIED CLEAN AIR GOLD



PAX TABLES - ROUND, SQUARE, AND RECTANGLE

18 ROUND x 18H

DIA: 18 H: 18



MODEL	TOP (1.5"-THICK)	PRICE
PLT18D18V	Veneer over Plywood Core/Edge*	807
PLT18D18L	Stocked Laminate over Plywood Core/Edge	807
	Non-Stocked Laminate (per color, per order)	ADD 50 NET

NOTE: Custom Wood Finish (CWF) is a one-time upcharge of 300 NET per color.

MODEL	SOLID SURFACE TOP (1.5"-THICK)	A	B	C	D
PLT18D18S	Stocked	1432 LIST	1565 LIST	1964 LIST	2395 LIST
	Non-stocked (per color, per order)	ADD 410 NET	450 NET	490 NET	520 NET

18 ROUND x 22H

DIA: 18 H: 22



MODEL	TOP (1.5"-THICK)	PRICE
PLT18D22V	Veneer over Plywood Core/Edge*	843
PLT18D22L	Stocked Laminate over Plywood Core/Edge	843
	Non-Stocked Laminate (per color, per order)	ADD 50 NET

NOTE: Custom Wood Finish (CWF) is a one-time upcharge of 300 NET per color.

MODEL	SOLID SURFACE TOP (1.5"-THICK)	A	B	C	D
PLT18D22S	Stocked	1468 LIST	1601 LIST	2000 LIST	2431 LIST
	Non-stocked (per color, per order)	ADD 410 NET	450 NET	490 NET	520 NET

22 ROUND x 18H

DIA: 22 H: 18



MODEL	TOP (1.5"-THICK)	PRICE
PLT22D18V	Veneer over Plywood Core/Edge*	955
PLT22D18L	Stocked Laminate over Plywood Core/Edge	955
	Non-Stocked Laminate (per color, per order)	ADD 50 NET

NOTE: Custom Wood Finish (CWF) is a one-time upcharge of 300 NET per color.

MODEL	SOLID SURFACE TOP (1.5"-THICK)	A	B	C	D
PLT22D18S	Stocked	1661 LIST	1827 LIST	2325 LIST	2855 LIST
	Non-stocked (per color, per order)	ADD 410 NET	450 NET	490 NET	520 NET

22 ROUND x 22H

DIA: 22 H: 22



MODEL	TOP (1.5"-THICK)	PRICE
PLT22D22V	Veneer over Plywood Core/Edge*	991
PLT22D22L	Stocked Laminate over Plywood Core/Edge	991
	Non-Stocked Laminate (per color, per order)	ADD 50 NET

NOTE: Custom Wood Finish (CWF) is a one-time upcharge of 300 NET per color.

MODEL	SOLID SURFACE TOP (1.5"-THICK)	A	B	C	D
PLT22D22S	Stocked	1697 LIST	1863 LIST	2361 LIST	2891 LIST
	Non-stocked (per color, per order)	ADD 410 NET	450 NET	490 NET	520 NET

27 ROUND x 18H

DIA: 27 H: 18



MODEL	TOP (1.5"-THICK)	PRICE
PLT27D18V	Veneer over Plywood Core/Edge*	1049
PLT27D18L	Stocked Laminate over Plywood Core/Edge	1049
	Non-Stocked Laminate (per color, per order)	ADD 50 NET

NOTE: Custom Wood Finish (CWF) is a one-time upcharge of 300 NET per color.

MODEL	SOLID SURFACE TOP (1.5"-THICK)	A	B	C	D
PLT27D18S	Stocked	2064 LIST	2363 LIST	3027 LIST	3791 LIST
	Non-stocked (per color, per order)	ADD 410 NET	450 NET	490 NET	520 NET

*Veneer Tops are not compliant with Clean Air Gold Certification or Healthier Hospitals Initiative



PAX TABLES - ROUND, SQUARE, AND RECTANGLE

27 ROUND x 22H

DIA: 27 H: 22



MODEL	TOP (1.5"-THICK)	PRICE
PLT27D22V	Veneer over Plywood Core/Edge*	1085
PLT27D22L	Stocked Laminate over Plywood Core/Edge	1085
	Non-Stocked Laminate (per color, per order)	ADD 50 NET

NOTE: Custom Wood Finish (CWF) is a one-time upcharge of 300 NET per color.

MODEL	SOLID SURFACE TOP (1.5"-THICK)	A	B	C	D
PLT27D22S	Stocked	2100 LIST	2399 LIST	3063 LIST	3827 LIST
	Non-stocked (per color, per order)	ADD 410 NET	450 NET	490 NET	520 NET

18 SQUARE x 18H

W: 18 D: 18 H: 18



MODEL	TOP (1.5"-THICK)	PRICE
PLT181818V	Veneer over Plywood Core/Edge*	807
PLT181818L	Stocked Laminate over Plywood Core/Edge	807
	Non-Stocked Laminate (per color, per order)	ADD 50 NET

NOTE: Custom Wood Finish (CWF) is a one-time upcharge of 300 NET per color.

MODEL	SOLID SURFACE TOP (1.5"-THICK)	A	B	C	D
PLT181818S	Stocked	1450 LIST	1582 LIST	1981 LIST	2411 LIST
	Non-stocked (per color, per order)	ADD 410 NET	450 Net	490 NET	520 NET

18 SQUARE x 22H

W: 18 D: 18 H: 18



MODEL	TOP (1.5"-THICK)	PRICE
PLT181822V	Veneer over Plywood Core/Edge*	843
PLT181822L	Stocked Laminate over Plywood Core/Edge	843
	Non-Stocked Laminate (per color, per order)	ADD 50 NET

NOTE: Custom Wood Finish (CWF) is a one-time upcharge of 300 NET per color.

MODEL	SOLID SURFACE TOP (1.5"-THICK)	A	B	C	D
PLT181822S	Stocked	1486 LIST	1618 LIST	2017 LIST	2447 LIST
	Non-stocked (per color, per order)	ADD 410 NET	450 NET	490 NET	520 NET

22 SQUARE x 18H

W: 22 D: 22 H: 18



MODEL	TOP (1.5"-THICK)	PRICE
PLT222218V	Veneer over Plywood Core/Edge*	944
PLT222218L	Stocked Laminate over Plywood Core/Edge	944
	Non-Stocked Laminate (per color, per order)	ADD 50 NET

NOTE: Custom Wood Finish (CWF) is a one-time upcharge of 300 NET per color.

MODEL	SOLID SURFACE TOP (1.5"-THICK)	A	B	C	D
PLT222218S	Stocked	1661 LIST	1827 LIST	2325 LIST	2855 LIST
	Non-stocked (per color, per order)	ADD 410 NET	450 NET	490 NET	520 NET

22 SQUARE x 22H

W: 22 D: 22 H: 22



MODEL	TOP (1.5"-THICK)	PRICE
PLT222222V	Veneer over Plywood Core/Edge*	980
PLT222222L	Stocked Laminate over Plywood Core/Edge	980
	Non-Stocked Laminate (per color, per order)	ADD 50 NET

NOTE: Custom Wood Finish (CWF) is a one-time upcharge of 300 NET per color.

MODEL	SOLID SURFACE TOP (1.5"-THICK)	A	B	C	D
PLT222222S	Stocked	1697 LIST	1863 LIST	2361 LIST	2891 LIST
	Non-stocked (per color, per order)	ADD 410 NET	450 NET	490 NET	520 NET

*Veneer Tops are not compliant with Clean Air Gold Certification or Healthier Hospitals Initiative



PAX TABLES - ROUND, SQUARE, AND RECTANGLE

27 SQUARE x 18H

W: 27 D: 27 H: 18



MODEL	TOP (1.5"-THICK)	PRICE
PLT272718V	Veneer over Plywood Core/Edge*	1057
PLT272718L	Stocked Laminate over Plywood Core/Edge	1057
	Non-Stocked Laminate (per color, per order)	ADD 50 NET

NOTE: Custom Wood Finish (CWF) is a one-time upcharge of 300 NET per color.

MODEL	SOLID SURFACE TOP (1.5"-THICK)	A	B	C	D
PLT272718S	Stocked	2133 LIST	2431 LIST	3095 LIST	3858 LIST
	Non-stocked (per color, per order)	ADD 410 NET	450 NET	490 NET	520 NET

27 SQUARE x 22H

W: 27 D: 27 H: 22



MODEL	TOP (1.5"-THICK)	PRICE
PLT272722V	Veneer over Plywood Core/Edge*	1093
PLT272722L	Stocked Laminate over Plywood Core/Edge	1093
	Non-Stocked Laminate (per color, per order)	ADD 50 NET

NOTE: Custom Wood Finish (CWF) is a one-time upcharge of 300 NET per color.

MODEL	SOLID SURFACE TOP (1.5"-THICK)	A	B	C	D
PLT272722S	Stocked	2169 LIST	2467 LIST	3131 LIST	3894 LIST
	Non-stocked (per color, per order)	ADD 410 NET	450 Net	490 NET	520 NET

46 x 20 RECTANGLE x 18H

W: 46 D: 20 H: 18



MODEL	TOP (1.5"-THICK)	PRICE
PLT462018V	Veneer over Plywood Core/Edge*	1017
PLT462018L	Stocked Laminate over Plywood Core/Edge	1017
	Non-Stocked Laminate (per color, per order)	ADD 50 NET

NOTE: Custom Wood Finish (CWF) is a one-time upcharge of 300 NET per color.

MODEL	SOLID SURFACE TOP (1.5"-THICK)	A	B	C	D
PLT462018S	Stocked	2521 LIST	2853 LIST	3683 LIST	4679 LIST
	Non-stocked (per color, per order)	ADD 410 NET	450 NET	490 NET	520 NET

46 x 20 RECTANGLE x 22H

W: 46 D: 20 H: 22



MODEL	TOP (1.5"-THICK)	PRICE
PLT462022V	Veneer over Plywood Core/Edge*	1053
PLT462022L	Stocked Laminate over Plywood Core/Edge	1053
	Non-Stocked Laminate (per color, per order)	ADD 50 NET

NOTE: Custom Wood Finish (CWF) is a one-time upcharge of 300 NET per color.

MODEL	SOLID SURFACE TOP (1.5"-THICK)	A	B	C	D
PLT462022S	Stocked	2557 LIST	2889 LIST	3719 LIST	4715 LIST
	Non-stocked (per color, per order)	ADD 410 NET	450 NET	490 NET	520 NET

*Veneer Tops are not compliant with Clean Air Gold Certification or Healthier Hospitals Initiative



PAX TABLES - ROUND, SQUARE, AND RECTANGLE

46 x 20 RECTANGLE x 29H

W: 46 D: 20 H: 29



MODEL	TOP (1.5"-THICK)	PRICE
PLT462029V	Veneer over Plywood Core/Edge*	1133
PLT462029L	Stocked Laminate over Plywood Core/Edge	1133
	Non-Stocked Laminate (per color, per order)	ADD 50 NET

NOTE: Custom Wood Finish (CWF) is a one-time upcharge of 300 NET per color.

MODEL	SOLID SURFACE TOP (1.5"-THICK)	A	B	C	D
PLT462029S	Stocked	2637 LIST	2969 LIST	3799 LIST	4795 LIST
	Non-stocked (per color, per order)	ADD 410 NET	450 NET	490 NET	520 NET

46 x 16 RECTANGLE x 18H

W: 46 D: 16 H: 18



MODEL	TOP (1.5"-THICK)	PRICE
PLT461618V	Veneer over Plywood Core/Edge*	1017
PLT461618L	Stocked Laminate over Plywood Core/Edge	1017
	Non-Stocked Laminate (per color, per order)	ADD 50 NET

NOTE: Custom Wood Finish (CWF) is a one-time upcharge of 300 NET per color.

MODEL	SOLID SURFACE TOP (1.5"-THICK)	A	B	C	D
PLT461618S	Stocked	2047 LIST	2346 LIST	3010 LIST	3774 LIST
	Non-stocked (per color, per order)	ADD 410 NET	450 NET	490 NET	520 NET

46 x 16 RECTANGLE x 22H

W: 46 D: 16 H: 22



MODEL	TOP (1.5"-THICK)	PRICE
PLT461622V	Veneer over Plywood Core/Edge*	1053
PLT461622L	Stocked Laminate over Plywood Core/Edge	1053
	Non-Stocked Laminate (per color, per order)	ADD 50 NET

NOTE: Custom Wood Finish (CWF) is a one-time upcharge of 300 NET per color.

MODEL	SOLID SURFACE TOP (1.5"-THICK)	A	B	C	D
PLT461622S	Stocked	2083 LIST	2382 LIST	3046 LIST	3810 LIST
	Non-stocked (per color, per order)	ADD 410 NET	450 Net	490 NET	520 NET

46 x 16 RECTANGLE x 29H

W: 46 D: 16 H: 29



MODEL	TOP (1.5"-THICK)	PRICE
PLT461629V	Veneer over Plywood Core/Edge*	1133
PLT461629L	Stocked Laminate over Plywood Core/Edge	1133
	Non-Stocked Laminate (per color, per order)	ADD 50 NET

NOTE: Custom Wood Finish (CWF) is a one-time upcharge of 300 NET per color.

MODEL	SOLID SURFACE TOP (1.5"-THICK)	A	B	C	D
PLT461629S	Stocked	2163 LIST	2462 LIST	3126 LIST	3890 LIST
	Non-stocked (per color, per order)	ADD 410 NET	450 NET	490 NET	520 NET

*Veneer Tops are not compliant with Clean Air Gold Certification or Healthier Hospitals Initiative

PAX TABLES | OPTIONS

MODEL	DESCRIPTION	PRICE
METAL SLEEVES	PLGS Available in all Powder Coat finishes	124 LIST/TABLE

PRODUCT OPTIONS

PERMA-COAT WOOD LEG PROTECTOR \$35 List / Leg

PYXIS COLLECTION

PYXIS SEATING	PC 2
PYXIS BENCHES	PC 3
PYXIS SYSTEMS	PC 4
PYXIS SYSTEM SPECIFICATIONS	PC 4



PYXIS COLLECTION | P3









CERTIFIED
CLEAN AIR GOLD

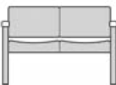

PYXIS P3 - CONTEMPORARY PANEL - CLEAN-OUT DESIGN

HARD MAPLE

WEAR POINT SEAT ROTATION

		MODEL	W	SW	YARDS	COM	M	COL	P	R	S	T	U	W/WL
CHAIRS														
														
H: 33	D: 27	P3-1-21	26	21	3.35	1494	1618	1769	1906	2053	2198	2345	2489	2707
SH: 18.5	SD: 19	P3-1-24	29	24	3.55	1563	1694	1854	2000	2156	2309	2465	2617	2848
BH: 16	AH: 26	P3-1-27	32	27	4.25	1646	1803	1995	2169	2356	2539	2726	2908	3185
		P3BR-1-30	35	30	4.25	2009	2166	2358	2532	2719	2902	3089	3271	3548
		P3BR-1-36	41	36	4.75	2162	2338	2552	2746	2955	3160	3369	3573	3882
		P3BR-1-42	47	42	4.75	2327	2503	2717	2911	3120	3325	3534	3738	4047
SETTEE														
		P3-2	47	42	4.95	2144	2327	2550	2753	2971	3184	3401	3614	3936
SOFA														
		P3-3	68	63	6.55	2802	3044	3339	3608	3896	4178	4466	4747	5173
ORTHO HEIGHT CHAIRS														
														
H: 39	D: 27	P3OR-1-21	26	21	3.6	1633	1766	1928	2076	2234	2389	2547	2702	2936
SH: 24	SD: 19	P3OR-1-24	29	24	3.8	1713	1854	2025	2180	2348	2511	2678	2842	3089
BH: 16	AH: 32	P3OR-1-27	32	27	4.5	1797	1964	2166	2351	2549	2742	2940	3134	3426

PYXIS P3 | LEG OPTIONS

	MODEL	PRICE
BRUSHED ALUMINUM NAVE LEG	4NL	324 LIST/SET OF 4

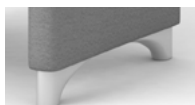

PRODUCT OPTIONS

- MOISTURE BARRIER** \$22 List / Yard
- FIRE WALL / CA T.B. 133** \$82 List / Yard
- TAMPER-RESISTANT FASTENERS** \$51 List / Chair



PYXIS COLLECTION | PYXIS BENCHES



CERTIFIED
CLEAN AIR GOLD



Healthier
Hospitals

COMPONENT-BASED
CONSTRUCTION

2K STATIC
CAPACITY

1K DROP
CAPACITY

PYXIS BENCH P3 - CONTEMPORARY PANEL

	MODEL	W	SW	YARDS	COM	M	COL	P	R	S	T	U	W/WL
SINGLE SEAT BENCH	P3B1	26	21	2.25	1183	1266	1368	1460	1559	1656	1755	1851	1998
H: 21 D: 25 SH: 18.5 SD: 25													
DOUBLE SEAT BENCH	P3B2	47	42	3	1529	1640	1775	1898	2030	2159	2291	2420	2615
													
TRIPLE SEAT BENCH	P3B3	68	63	3.75	1884	2023	2192	2345	2510	2672	2837	2998	3242
													

PRODUCT OPTIONS

- MOISTURE BARRIER** \$22 List / Yard
- FIRE WALL / CA T.B. 133** \$82 List / Yard
- TAMPER-RESISTANT FASTENERS** \$51 List / Chair



PYXIS SYSTEM ARMS

HARD MAPLE

	MODEL	W	YARDS	COM	M	COL							W/WL
						O	P	R	S	T	U		
P3 - CONTEMPORARY PANEL	P3-XX												
	AL or AR	2.5	0.875	286	318	358	394	432	470	508	546	603	
	SS	2.5	0.875	314	346	386	422	460	498	536	574	631	



PYXIS SYSTEM SEATS - OPEN BACK

	MODEL	SW	YARDS	COM	M	COL							W/WL
						O	P	R	S	T	U		
SINGLE SEATS	PS11	21	1.6	676	735	807	873	943	1012	1082	1151	1255	
	PS14	24	1.8	745	812	893	966	1046	1123	1202	1280	1397	
	PS17	27	2.5	828	921	1033	1136	1246	1353	1463	1571	1733	
	PS1B	30	2.5	1191	1284	1396	1499	1609	1716	1826	1934	2096	
	PS1B36	36	3	1344	1455	1590	1713	1845	1974	2106	2235	2430	
	PS1B42	42	3	1509	1620	1755	1878	2010	2139	2271	2400	2595	
DOUBLE SEAT	PS21	42	3.2	1325	1443	1587	1719	1859	1997	2138	2275	2483	
TRIPLE SEAT	PS31	63	4.8	1982	2160	2376	2572	2784	2990	3201	3408	3720	



PRODUCT OPTIONS

- MOISTURE BARRIER** \$22 List / Yard
- FIRE WALL / CA T.B. 133** \$82 List / Yard
- TAMPER-RESISTANT FASTENERS** \$51 List / Chair

PYXIS SYSTEM SPECIFICATION

Integra systems are listed separately from the freestanding product of each series throughout this price list. The components are specific to the model and are all shown within the systems sections. Each system arm, system seat, and system table has a specific item number. System arms must have placement specified as shown below.

WHEN SPECIFYING SYSTEMS, ALWAYS ITEMIZE COMPONENTS AS YOU STAND FACING THE CONFIGURATION. BEGIN YOUR LAYOUT AT THE LEFT AND END AT THE RIGHT.

All System orders require a layout at the time of order. This is to ensure you are ordering all components necessary for that layout.

System arms use an alpha designation which describes their placement:

- SS** is for Seat-to-Seat Connection
- AR** is for Arm Right
- AL** is for Arm Left

EXAMPLES (in Tide series):



CTAL CTSS CTSS CTAR

- CTAL** Coastal Tide Arm, beginning a layout, connecting to a Seat Unit on right.
- CLT1** Coastal Low Tide Seat Unit.
- CTSS** Coastal Tide Arm with a Seat Unit connection on both sides.
- CLT1** Coastal Low Tide Seat Unit.
- CTSS** Coastal Tide Arm with a Seat Unit connection on both sides.
- CLT1** Coastal Low Tide Seat Unit.
- CTAR** Coastal Tide Arm with Seat Unit Connection on Left, ending a layout.

TABLE COLLECTIONS

A-TABLES	ITC 2 - 7
CUBE TABLES WITH SELF EDGE	ITC 8 - 10
DRUM TABLES WITH SELF EDGE	ITC 11 - 13
CUBE TABLES WITH SOLID WOOD EDGE	ITC 14 - 16
DRUM TABLES WITH SOLID WOOD EDGE	ITC 17 - 19
KIXSY PULL-UP TABLE	ITC 20

OTHER TABLES IN THEIR RESPECTIVE COLLECTION

ALPINE TABLES	ALC 19 - 29
COASTAL METAL TABLES	CCM 22
KALLISE TABLES	KLC 10 - 12
PAX TABLES	PLC 6 - 9
RENDEZVOUS TABLES	TLC 15 - 16
TRIA TABLES	TC 12 - 14
VALAYO TABLES	VC 4



TABLE COLLECTIONS | A-TABLES

SPECIFICATION INFORMATION

PLEASE USE THE FOLLOWING SEQUENCE WHEN SPECIFYING A-TABLES:

1. ITEM NUMBER: ATB-F-M4824(EE)18(LL)

The item number for each table is the combination of its wood species (M=Hard Maple), top size (48x24) and edge detail (EE) followed by height (18) and leg style (LL).

2. LAMINATE ITEM NUMBER: ATB-F-M-L-4824(EE)18(LL)

Add L to part #.

3. EDGE DETAIL OPTION: (EE)

Specify edge detail. The edge option code is two letters corresponding to the following edge details.

EXAMPLE:

ATB-F	-	M		4824	SQ	18	PS
<small>SERIES</small>		<small>WOOD SPECIES</small>	<small>LAMINATE</small>	<small>TOP SIZE</small>	<small>EDGE DETAIL</small>	<small>HEIGHT</small>	<small>LEG STYLE</small>
ATB-F	-	M	-L	4824	SQ	18	PS

BEADED COVE (BC)

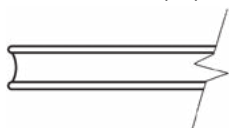

BEADED (BD)

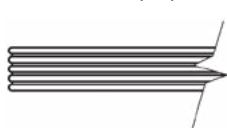

CHAMFER (CF)

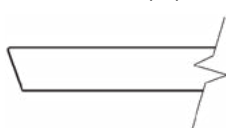

COASTAL (CT)

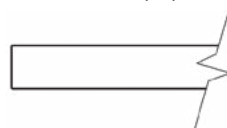

SQUARE (SQ)

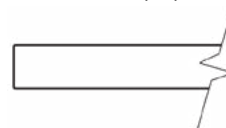

4. LEG STYLE: (LL)

Specify leg style. The leg style code is two letters corresponding to the following leg styles.

FLARED LEG (FL)



PIROUETTE LEG (PL)



TAPERED LEG (TL)



ROUND LEG (RL)



CABRIOLE LEG (CL)



COASTAL LEG (CT)



PARSONS LEG (PS)



AVAILABLE LEG & EDGE COMBINATIONS

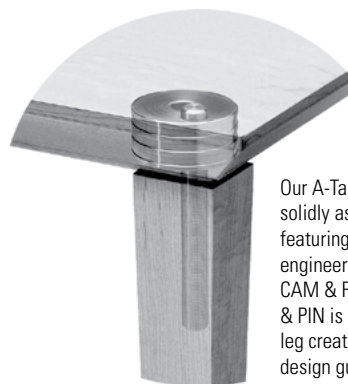

	BEADED COVE (BC)	BEADED (BD)	CHAMFER (CF)	SQUARE (SQ)	COASTAL (CT)
FLARED (FL)	✓	✓	✓	✓	✓
PIROUETTE (PL)	✓	✓	✓	✓	✓
TAPERED (TL)	✓	✓	✓	✓	✓
ROUND (RL)	✓	✓	✓	✓	✓
CABRIOLE (CL)	✓	✓	✓	✓	NA
COASTAL (CT)	✓	✓	✓	✓	✓
PARSONS (PS)	✓	✓	✓	✓	✓



Our A-Tables are built just as solidly as the rest of our products featuring our innovatively engineered and ultra-strong steel CAM & PIN connection. The CAM & PIN is epoxied to the top and leg creating a beautiful and clean design guaranteed to hold up.





A-TABLES - SQUARE

		MODEL	TOP (1.75"-THICK)	HARD MAPLE TL, PL, FL, RL, CT, PS	HARD MAPLE CL
18 SQUARE x 18H W: 18 D: 18 H: 18		ATB-F-M181818(LL)	Veneer	1116	1392
		ATB-F-M-L-181818(LL)	Stocked Laminate	1172	1462
18 SQUARE x 21H W: 18 D: 18 H: 21		ATB-F-M181821(LL)	Veneer	1168	1440
		ATB-F-M-L-181821(LL)	Stocked Laminate	1226	1512
18 SQUARE x 24H W: 18 D: 18 H: 24		ATB-F-M181824(LL)	Veneer	1208	1478
		ATB-F-M-L-181824(LL)	Stocked Laminate	1268	1552

Add SOLID SURFACE ONLY price to Veneer price above

18 x 18 SOLID SURFACE ONLY UPCHARGE	A	B	C	D
Stocked	583 LIST	583 LIST	652 LIST	719 LIST
Non-stocked (per color, per order)	ADD 410 NET	450 NET	490 NET	520 NET

NOTE: 1/2" Solid Surface Onlay will increase overall height by 1/2".

		MODEL	TOP (1.75"-THICK)	HARD MAPLE TL, PL, FL, RL, CT, PS	HARD MAPLE CL
21 SQUARE x 18H W: 21 D: 21 H: 18		ATB-F-M212118(LL)	Veneer	1185	1461
		ATB-F-M-L-212118(LL)	Stocked Laminate	1244	1534
21 SQUARE x 21H W: 21 D: 21 H: 21		ATB-F-M212121(LL)	Veneer	1237	1509
		ATB-F-M-L-212121(LL)	Stocked Laminate	1299	1584
21 SQUARE x 24H W: 21 D: 21 H: 24		ATB-F-M212124(LL)	Veneer	1277	1547
		ATB-F-M-L-212124(LL)	Stocked Laminate	1341	1624

Add SOLID SURFACE ONLY price to Veneer price above

21 x 21 SOLID SURFACE ONLY UPCHARGE	A	B	C	D
Stocked	792 LIST	792 LIST	885 LIST	979 LIST
Non-stocked (per color, per order)	ADD 410 NET	450 NET	490 NET	520 NET

NOTE: 1/2" Solid Surface Onlay will increase overall height by 1/2".



**NON-STOCKED / CUSTOM
FINISH UPCHARGES**

Non-Stocked Laminate (per color, per order)	ADD	50 NET
Custom Wood Finish (CWF) (one-time upcharge)	ADD	300 NET

NOTE: Not all edges available with each leg option. Please see ITC-2 for details.





A-TABLES - SQUARE

		MODEL	TOP (1.75"-THICK)	HARD MAPLE TL, PL, FL, RL, CT, PS	HARD MAPLE CL
24 SQUARE x 18H W: 24 D: 24 H: 18		ATB-F-M242418(LL)	Veneer	1335	1611
		ATB-F-M-L-242418(LL)	Stocked Laminate	1402	1692
24 SQUARE x 21H W: 24 D: 24 H: 21		ATB-F-M242421(LL)	Veneer	1387	1659
		ATB-F-M-L-242421(LL)	Stocked Laminate	1456	1742
24 SQUARE x 24H W: 24 D: 24 H: 24		ATB-F-M242424(LL)	Veneer	1427	1697
		ATB-F-M-L-242424(LL)	Stocked Laminate	1498	1782

Add SOLID SURFACE ONLAY price to Veneer price above

24 x 24 SOLID SURFACE ONLAY UPCHARGE	A	B	C	D
Stocked	1034 LIST	1034 LIST	1156 LIST	1277 LIST
Non-stocked (per color, per order)	ADD 410 NET	450 NET	490 NET	520 NET



NOTE: 1/2" Solid Surface Onlay will increase overall height by 1/2".

		MODEL	TOP (1.75"-THICK)	HARD MAPLE TL, PL, FL, RL, CT, PS	HARD MAPLE CL
30 SQUARE x 18H W: 30 D: 30 H: 18		ATB-F-M303018(LL)	Veneer	1547	1823
		ATB-F-M-L-303018(LL)	Stocked Laminate	1624	1914
30 SQUARE x 21H W: 30 D: 30 H: 21		ATB-F-M303021(LL)	Veneer	1599	1871
		ATB-F-M-L-303021(LL)	Stocked Laminate	1679	1965
30 SQUARE x 24H W: 30 D: 30 H: 24		ATB-F-M303024(LL)	Veneer	1639	1909
		ATB-F-M-L-303024(LL)	Stocked Laminate	1721	2004

Add SOLID SURFACE ONLAY price to Veneer price above

30 x 30 SOLID SURFACE ONLAY UPCHARGE	A	B	C	D
Stocked	1616 LIST	1616 LIST	1806 LIST	1997 LIST
Non-stocked (per color, per order)	ADD 410 NET	450 NET	490 NET	520 NET

NOTE: 1/2" Solid Surface Onlay will increase overall height by 1/2".

		MODEL	TOP (1.75"-THICK)	HARD MAPLE TL, PL, FL, RL, CT, PS	HARD MAPLE CL
36 SQUARE x 18H W: 36 D: 36 H: 18		ATB-F-M363618(LL)	Veneer	1795	2071
		ATB-F-M-L-363618(LL)	Stocked Laminate	1885	2175
36 SQUARE x 29H W: 36 D: 36 H: 29		ATB-F-M363629(LL)	Veneer	1959	2243
		ATB-F-M-L-363629(LL)	Stocked Laminate	2057	2355

Add SOLID SURFACE ONLAY price to Veneer price above

36 x 36 SOLID SURFACE ONLAY UPCHARGE	A	B	C	D
Stocked	2328 LIST	2328 LIST	2601 LIST	2875 LIST
Non-stocked (per color, per order)	ADD 410 NET	450 NET	490 NET	520 NET

NOTE: 1/2" Solid Surface Onlay will increase overall height by 1/2".

NON-STOCKED / CUSTOM FINISH UPCHARGES

Non-Stocked Laminate (per color, per order)	ADD	50 NET
Custom Wood Finish (CWF) (one-time upcharge)	ADD	300 NET

NOTE: Not all edges available with each leg option. Please see ITC-2 for details.



A-TABLES - RECTANGLE

48 x 24 RECTANGLE

W: 48 D: 24
H: 18

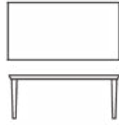

MODEL	TOP (1.75"-THICK)	HARD MAPLE TL, PL, FL, RL, CT, PS	HARD MAPLE CL
ATB-F-M482418(LL)	Veneer	1704	1980
ATB-F-M-L-482418(LL)	Stocked Laminate	1789	2079

Add SOLID SURFACE ONLAY price to Veneer price above

48 x 24 SOLID SURFACE ONLAY UPCHARGE	A	B	C	D
Stocked	2069 LIST	2069 LIST	2313 LIST	2556 LIST
Non-stocked (per color, per order)	ADD 410 NET	450 NET	490 NET	520 NET

NOTE: 1/2" Solid Surface Onlay will increase overall height by 1/2".

54 x 18 RECTANGLE

W: 54 D: 18
H: 29



MODEL	TOP (1.75"-THICK)	HARD MAPLE TL, PL, FL, RL, CT, PS	HARD MAPLE CL
ATB-F-M541829(LL)	Veneer	1781	2065
ATB-F-M-L-541829(LL)	Stocked Laminate	1870	2168

Add SOLID SURFACE ONLAY price to Veneer price above

54 x 18 SOLID SURFACE ONLAY UPCHARGE	A	B	C	D
Stocked	1745 LIST	1745 LIST	1950 LIST	2157 LIST
Non-stocked (per color, per order)	ADD 410 NET	450 NET	490 NET	520 NET

NOTE: 1/2" Solid Surface Onlay will increase overall height by 1/2".

NON-STOCKED / CUSTOM FINISH UPCHARGES

Non-Stocked Laminate (per color, per order)	ADD	50 NET
Custom Wood Finish (CWF) (one-time upcharge)	ADD	300 NET

NOTE: Not all edges available with each leg option. Please see ITC-2 for details.



A-TABLES - ROUND

18 ROUND x 18H DIA: 18 H: 18		MODEL	TOP	HARD MAPLE TL, PL, FL, RL, CT, PS	HARD MAPLE CL
		ATB-F-M18D18(LL)	Veneer	1201	1477
		ATB-F-M-L-18D18(LL)	Stocked Laminate	1261	1551

18 ROUND x 21H DIA: 18 H: 21		ATB-F-M18D21(LL)	Veneer	1253	1525
		ATB-F-M-L-18D21(LL)	Stocked Laminate	1316	1601

18 ROUND x 24H DIA: 18 H: 24		ATB-F-M18D24(LL)	Veneer	1293	1563
		ATB-F-M-L-18D24(LL)	Stocked Laminate	1358	1641

Add SOLID SURFACE ONLY price to Veneer price above

18 DIA SOLID SURFACE ONLY UPCHARGE	A	B	C	D
Stocked	583 LIST	583 LIST	652 LIST	719 LIST
Non-stocked (per color, per order)	ADD 410 NET	450 NET	490 NET	520 NET

NOTE: 1/2" Solid Surface Onlay will increase overall height by 1/2".

24 ROUND x 18H DIA: 24 H: 18		MODEL	TOP	HARD MAPLE TL, PL, FL, RL, CT, PS	HARD MAPLE CL
		ATB-F-M24D18(LL)	Veneer	1380	1656
		ATB-F-M-L-24D18(LL)	Stocked Laminate	1449	1739

24 ROUND x 21H DIA: 24 H: 21		ATB-F-M24D21(LL)	Veneer	1432	1704
		ATB-F-M-L-24D21(LL)	Stocked Laminate	1504	1789

24 ROUND x 24H DIA: 24 H: 24		ATB-F-M24D24(LL)	Veneer	1472	1742
		ATB-F-M-L-24D24(LL)	Stocked Laminate	1546	1829

Add SOLID SURFACE ONLY price to Veneer price above

24 DIA SOLID SURFACE ONLY UPCHARGE	A	B	C	D
Stocked	1034 LIST	1034 LIST	1156 LIST	1277 LIST
Non-stocked (per color, per order)	ADD 410 NET	450 NET	490 NET	520 NET

NOTE: 1/2" Solid Surface Onlay will increase overall height by 1/2".

30 ROUND x 18H DIA: 30 H: 18		MODEL	TOP	HARD MAPLE TL, PL, FL, RL, CT, PS	HARD MAPLE CL
		ATB-F-M30D18(LL)	Veneer	1606	1882
		ATB-F-M-L-30D18(LL)	Stocked Laminate	1686	1976

30 ROUND x 21H DIA: 30 H: 21		ATB-F-M30D21(LL)	Veneer	1658	1930
		ATB-F-M-L-30D21(LL)	Stocked Laminate	1741	2027

30 ROUND x 24H DIA: 30 H: 24		ATB-F-M30D24(LL)	Veneer	1698	1968
		ATB-F-M-L-30D24(LL)	Stocked Laminate	1783	2066

Add SOLID SURFACE ONLY price to Veneer price above

30 DIA SOLID SURFACE ONLY UPCHARGE	A	B	C	D
Stocked	1616 LIST	1616 LIST	1806 LIST	1997 LIST
Non-stocked (per color, per order)	ADD 410 NET	450 NET	490 NET	520 NET



NOTE: 1/2" Solid Surface Onlay will increase overall height by 1/2".

NON-STOCKED / CUSTOM FINISH UPCHARGES	Non-Stocked Laminate (per color, per order)	ADD	50 NET
	Custom Wood Finish (CWF) (one-time upcharge)	ADD	300 NET

NOTE: Not all edges available with each leg option. Please see ITC-2 for details.



A-TABLES - ROUND AND OVAL

	MODEL	TOP	HARD MAPLE	
			TL, PL, FL, RL, CT, PS	CL
36 ROUND x 18H DIA: 36 H: 18 	ATB-F-M36D18(LL)	Veneer	1890	2166
	ATB-F-M-L-36D18(LL)	Stocked Laminate	1985	2274
36 ROUND x 29H DIA: 36 H: 29 	ATB-F-M36D29(LL)	Veneer	2054	2338
	ATB-F-M-L-36D29(LL)	Stocked Laminate	2157	2455

Add SOLID SURFACE ONLAY price to Veneer price above

36 DIA SOLID SURFACE ONLAY UPCHARGE	A	B	C	D
Stocked	2328 LIST	2328 LIST	2601 LIST	2875 LIST
Non-stocked (per color, per order)	ADD 410 NET	450 NET	490 NET	520 NET

NOTE: 1/2" Solid Surface Onlay will increase overall height by 1/2".

	MODEL	TOP	HARD MAPLE	
			TL, PL, FL, RL, CT, PS	CL
48 X 22 OVAL W: 48 D: 22 H: 18 	ATB-F-M4822OV18(LL)	Veneer	1733	2009
	ATB-F-M-L-4822OV18(LL)	Stocked Laminate	1820	2109

Add SOLID SURFACE ONLAY price to Veneer price above

48 X 22 SOLID SURFACE ONLAY UPCHARGE	A	B	C	D
Stocked	1897 LIST	1897 LIST	2120 LIST	2345 LIST
Non-stocked (per color, per order)	ADD 410 NET	450 NET	490 NET	520 NET

NOTE: 1/2" Solid Surface Onlay will increase overall height by 1/2".

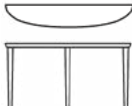
	MODEL	TOP	HARD MAPLE	
			TL, PL, FL, RL, CT, PS	CL
54 X 16 HALF OVAL W: 54 D: 16 H: 29 	ATB-F-M5416HO29(LL)	Veneer	1646	1859
	ATB-F-M-L-5416HO29(LL)	Stocked Laminate	1728	1952

Add SOLID SURFACE ONLAY price to Veneer price above

54 X 16 SOLID SURFACE ONLAY UPCHARGE	A	B	C	D
Stocked	1551 LIST	1551 LIST	1737 LIST	1916 LIST
Non-stocked (per color, per order)	ADD 410 NET	450 NET	490 NET	520 NET

NOTE: 1/2" Solid Surface Onlay will increase overall height by 1/2".

NON-STOCKED / CUSTOM FINISH UPCHARGES

Non-Stocked Laminate (per color, per order)	ADD	50 NET
Custom Wood Finish (CWF) (one-time upcharge)	ADD	300 NET

NOTE: Not all edges available with each leg option. Please see ITC-2 for details.

A-TABLES | OPTIONS

MODEL	DESCRIPTION	PRICE
3/4" GLASS TOP 	GLASS 3/4" Glass (set on top)	Contact Customer Service for Options and Pricing

PRODUCT OPTIONS

PERMA-COAT WOOD LEG PROTECTOR \$35 List / Leg



CUBE WITH SELF EDGE

HARD MAPLE OR LAMINATE

		MODEL	TOP	PLINTH BASE VP, LP, BP, NB	BLACK METAL PLINTH MP	WOOD/ALUM LEGS MW, CW, BA	METAL LEGS BC, BM
18 SQUARE x 18H W: 18 D: 18 H: 18		CV1-181818-(_)	Veneer	1864	2017	1952	2128
		CL1-181818-(_)	Stocked Laminate	1491	1644	1579	1755
18 SQUARE x 21H W: 18 D: 18 H: 21		CV1-181821-(_)	Veneer	1996	2149	2084	2260
		CL1-181821-(_)	Stocked Laminate	1560	1713	1648	1824
18 SQUARE x 24H W: 18 D: 18 H: 24		CV1-181824-(_)	Veneer	2128	2281	2216	2392
		CL1-181824-(_)	Stocked Laminate	1609	1762	1697	1873

Add SOLID SURFACE ONLAY price to prices above

18 x 18 SOLID SURFACE ONLAY UPCHARGE	A	B	C	D
Stocked	583 LIST	583 LIST	652 LIST	719 LIST
Non-stocked (per color, per order)	ADD 410 NET	450 NET	490 NET	520 NET

NOTE: 1/2" Solid Surface Onlay will increase overall height by 1/2".

	MODEL	DESCRIPTION	PRICE
18 x 18 BOTTOM EDGE PROTECTOR	EPOC18	For use with 18" Square Tables	ADD 86 LIST

		MODEL	TOP	PLINTH BASE VP, LP, BP, NB	BLACK METAL PLINTH MP	WOOD/ALUM LEGS MW, CW, BA	METAL LEGS BC, BM
24 SQUARE x 18H W: 24 D: 24 H: 18		CV1-242418-(_)	Veneer	2279	2464	2341	2517
		CL1-242418-(_)	Stocked Laminate	1721	1906	1783	1959
24 SQUARE x 21H W: 24 D: 24 H: 21		CV1-242421-(_)	Veneer	2415	2600	2477	2653
		CL1-242421-(_)	Stocked Laminate	1805	1990	1867	2043
24 SQUARE x 24H W: 24 D: 24 H: 24		CV1-242424-(_)	Veneer	2603	2788	2665	2841
		CL1-242424-(_)	Stocked Laminate	1875	2060	1937	2113

Add SOLID SURFACE ONLAY price to prices above

24 x 24 SOLID SURFACE ONLAY UPCHARGE	A	B	C	D
Stocked	1034 LIST	1034 LIST	1156 LIST	1277 LIST
Non-stocked (per color, per order)	ADD 410 NET	450 NET	490 NET	520 NET

NOTE: 1/2" Solid Surface Onlay will increase overall height by 1/2".

	MODEL	DESCRIPTION	PRICE
24 x 24 BOTTOM EDGE PROTECTOR	EPOC24	For use with 24" Square Tables	ADD 201 LIST

KEY FOR SPECIFYING CUBE TABLES:

Replace () in the product code with the following to specify legs/base. NOTE: Plinth Base Shown.

- VP or LP** 3"H Plinth Base with matching Veneer (VP) or Laminate (LP)
- BP** 3"H Plinth Base with Black Laminate
- MP** 3"H Black Metal Plinth Base
- MW** 5"H Hard Maple Legs (to match Tria Wood Legs)
- CW** 5"H Hard Maple Legs (to match Coffee House Wood Legs)
- BC** 5"H Brushed Chrome Metal Legs (to match Tria Tables)
- BM** 5"H Black Metal Legs (to match Tria Tables)
- BA** 5"H Brushed Aluminum Legs (to match Coffee House Aluminum Legs)
- NB** No Base

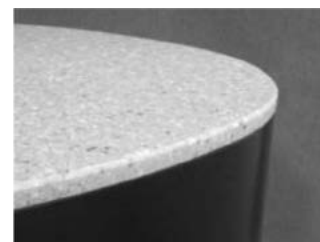

SELF EDGE
DETAIL
WITH SOLID
SURFACE TOP



CUBE WITH SELF EDGE

		MODEL	TOP	PLINTH BASE VP, LP, BP, NB	BLACK METAL PLINTH MP	WOOD/ALUM LEGS MW, CW, BA	METAL LEGS BC, BM
30 SQUARE x 18H		CV1-303018 (_)	Veneer	2920	3209	2959	3135
		CL1-303018 (_)	Stocked Laminate	1999	2288	2038	2214
30 SQUARE x 21H		CV1-303021 (_)	Veneer	3052	3341	3091	3267
		CL1-303021 (_)	Stocked Laminate	2144	2433	2183	2359
30 SQUARE x 24H		CV1-303024 (_)	Veneer	3144	3433	3183	3359
		CL1-303024 (_)	Stocked Laminate	2231	2520	2270	2446

Add SOLID SURFACE ONLAY price to prices above

30 x 30 SOLID SURFACE ONLAY UPCHARGE	A	B	C	D
Stocked	1616 LIST	1616 LIST	1806 LIST	1997 LIST
Non-stocked (per color, per order)	ADD 410 NET	450 NET	490 NET	520 NET

NOTE: 1/2" Solid Surface Onlay will increase overall height by 1/2".

	MODEL	DESCRIPTION	PRICE
30 x 30 BOTTOM EDGE PROTECTOR	EPOC30	For use with 30" Square Tables	ADD 227 LIST

		MODEL	TOP	PLINTH BASE VP, LP, BP, NB	BLACK METAL PLINTH MP	WOOD/ALUM LEGS MW, CW, BA	METAL LEGS BC, BM
36 SQUARE x 18H		CV1-363618 (_)	Veneer	3442	3769	3434	3610
		CL1-363618 (_)	Stocked Laminate	2304	2631	2296	2472
36 SQUARE x 21H		CV1-363621 (_)	Veneer	3531	3858	3523	3699
		CL1-363621 (_)	Stocked Laminate	2470	2797	2462	2638
36 SQUARE x 24H		CV1-363624 (_)	Veneer	3705	4032	3697	3873
		CL1-363624 (_)	Stocked Laminate	2574	2901	2566	2742

Add SOLID SURFACE ONLAY price to prices above

36 x 36 SOLID SURFACE ONLAY UPCHARGE	A	B	C	D
Stocked	2328 LIST	2328 LIST	2601 LIST	2875 LIST
Non-stocked (per color, per order)	ADD 410 NET	450 NET	490 NET	520 NET

NOTE: 1/2" Solid Surface Onlay will increase overall height by 1/2".

	MODEL	DESCRIPTION	PRICE
36 x 36 BOTTOM EDGE PROTECTOR	EPOC36	For use with 36" Square Tables	ADD 325 LIST

NON-STOCKED / CUSTOM FINISH UPCHARGES

Non-Stocked Laminate (per color, per order)	ADD	50 NET
Custom Wood Finish (CWF) (one-time upcharge)	ADD	300 NET

KEY FOR SPECIFYING CUBE TABLES:

Replace () in the product code with the following to specify legs/base. NOTE: Plinth Base Shown.

- VP or LP** 3"H Plinth Base with matching Veneer (VP) or Laminate (LP)
- BP** 3"H Plinth Base with Black Laminate
- MP** 3"H Black Metal Plinth Base
- MW** 5"H Hard Maple Legs (to match Tria Wood Legs)
- CW** 5"H Hard Maple Legs (to match Coffee House Wood Legs)
- BC** 5"H Brushed Chrome Metal Legs (to match Tria Tables)
- BM** 5"H Black Metal Legs (to match Tria Tables)
- BA** 5"H Brushed Aluminum Legs (to match Coffee House Aluminum Legs)
- NB** No Base

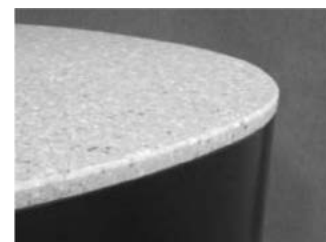

**SELF EDGE
DETAIL
WITH SOLID
SURFACE TOP**



ELECTRICAL / POWER PORT

Power Ports are available on Cube tables; however, due to the many sizes and options available, a drawing will be required for each table (when sizes or placement vary) showing the Power Port location desired. Power Ports must be placed on a flat surface.

Tables will be subject to a custom engineering fee of \$300 NET for each different sized table or tables requiring different Power Port locations. Contact Integra Customer Service for Pricing.

3/4" GLASS TOP



MODEL	DESCRIPTION	PRICE
GLASS	3/4" Glass (set on top)	Contact Customer Service for Options and Pricing

PRODUCT OPTIONS

PERMA-COAT WOOD LEG PROTECTOR	\$35 List / Leg
--------------------------------------	-----------------



TABLE COLLECTIONS | DRUMS

COMPONENT-BASED CONSTRUCTION

DRUM WITH SELF EDGE

HARD MAPLE OR LAMINATE

		MODEL	TOP	PLINTH BASE VP, LP, BP, NB	BLACK METAL PLINTH MP	WOOD/ALUM LEGS MW, CW, BA	METAL LEGS BC, BM
18 ROUND x 18H DIA: 18 H: 18		DV1-18D18-(<u> </u>)	Veneer	1754	1874	1842	2018
		DL1-18D18-(<u> </u>)	Stocked Laminate	1424	1544	1512	1688
18 ROUND x 21H DIA: 18 H: 21		DV1-18D21-(<u> </u>)	Veneer	1864	1984	1952	2128
		DL1-18D21-(<u> </u>)	Stocked Laminate	1468	1588	1556	1732
18 ROUND x 24H DIA: 18 H: 24		DV1-18D24-(<u> </u>)	Veneer	1971	2091	2059	2235
		DL1-18D24-(<u> </u>)	Stocked Laminate	1510	1630	1598	1774

Add SOLID SURFACE ONLAY price to prices above

18 DIA SOLID SURFACE ONLAY UPCHARGE	A	B	C	D
Stocked	583 LIST	583 LIST	652 LIST	719 LIST
Non-stocked (per color, per order)	ADD 410 NET	450 NET	490 NET	520 NET

NOTE: 1/2" Solid Surface Onlay will increase overall height by 1/2".

	MODEL	DESCRIPTION	PRICE
18 DIA BOTTOM EDGE PROTECTOR	EPOD18	For use with 18" Round Tables	ADD 86 LIST

		MODEL	TOP	PLINTH BASE VP, LP, BP, NB	BLACK METAL PLINTH MP	WOOD/ALUM LEGS MW, CW, BA	METAL LEGS BC, BM
24 ROUND x 18H DIA: 24 H: 18		DV1-24D18-(<u> </u>)	Veneer	2078	2232	2140	2316
		DL1-24D18-(<u> </u>)	Stocked Laminate	1610	1764	1672	1848
24 ROUND x 21H DIA: 24 H: 21		DV1-24D21-(<u> </u>)	Veneer	2176	2330	2238	2414
		DL1-24D21-(<u> </u>)	Stocked Laminate	1678	1832	1740	1916
24 ROUND x 24H DIA: 24 H: 24		DV1-24D24-(<u> </u>)	Veneer	2292	2446	2354	2530
		DL1-24D24-(<u> </u>)	Stocked Laminate	1769	1923	1831	2007

Add SOLID SURFACE ONLAY price to prices above

24 DIA SOLID SURFACE ONLAY UPCHARGE	A	B	C	D
Stocked	1034 LIST	1034 LIST	1156 LIST	1277 LIST
Non-stocked (per color, per order)	ADD 410 NET	450 NET	490 NET	520 NET

NOTE: 1/2" Solid Surface Onlay will increase overall height by 1/2".

	MODEL	DESCRIPTION	PRICE
24 DIA BOTTOM EDGE PROTECTOR	EPOD24	For use with 24" Round Tables	ADD 129 LIST

NON-STOCKED / CUSTOM FINISH UPCHARGES	Non-Stocked Laminate (per color, per order)	ADD 50 NET
	Custom Wood Finish (CWF) (one-time upcharge)	ADD 300 NET

KEY FOR SPECIFYING DRUM TABLES:

Replace () in the product code with the following to specify legs/base. NOTE: Plinth Base Shown.

- VP or LP** 3"H Plinth Base with matching Veneer (VP) or Laminate (LP)
- BP** 3"H Plinth Base with Black Laminate
- MP** 3"H Black Metal Plinth Base
- MW** 5"H Hard Maple Legs (to match Tria Wood Legs)
- CW** 5"H Hard Maple Legs (to match Coffee House Wood Legs)
- BC** 5"H Brushed Chrome Metal Legs (to match Tria Tables)
- BM** 5"H Black Metal Legs (to match Tria Tables)
- BA** 5"H Brushed Aluminum Legs (to match Coffee House Aluminum Legs)
- NB** No Base

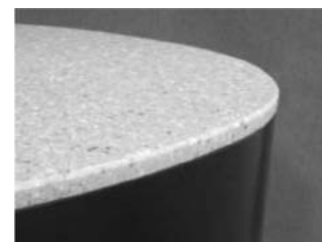

SELF EDGE
DETAIL
WITH SOLID
SURFACE TOP



DRUM WITH SELF EDGE

		MODEL	TOP	PLINTH BASE VP, LP, BP, NB	BLACK METAL PLINTH MP	WOOD/ALUM LEGS MW, CW, BA	METAL LEGS BC, BM
30 ROUND x 18H DIA: 30 H: 18		DV1-30D18-()	Veneer	2634	2865	2673	2849
		DL1-30D18-()	Stocked Laminate	1973	2204	2012	2188
30 ROUND x 21H DIA: 30 H: 21		DV1-30D21-()	Veneer	2817	3048	2856	3032
		DL1-30D21-()	Stocked Laminate	2058	2289	2097	2273
30 ROUND x 24H DIA: 30 H: 24		DV1-30D24-()	Veneer	2944	3175	2983	3159
		DL1-30D24-()	Stocked Laminate	2119	2350	2158	2334

Add SOLID SURFACE ONLAY price to prices above

30 DIA SOLID SURFACE ONLAY UPCHARGE	A	B	C	D
Stocked	1616 LIST	1616 LIST	1806 LIST	1997 LIST
Non-stocked (per color, per order)	ADD 410 NET	450 NET	490 NET	520 NET

NOTE: 1/2" Solid Surface Onlay will increase overall height by 1/2".

	MODEL	DESCRIPTION	PRICE
30 DIA BOTTOM EDGE PROTECTOR	EPOD30	For use with 30" Round Tables	ADD 227 LIST

		MODEL	TOP	PLINTH BASE VP, LP, BP, NB	BLACK METAL PLINTH MP	WOOD/ALUM LEGS MW, CW, BA	METAL LEGS BC, BM
36 ROUND x 18H DIA: 36 H: 18		DV1-36D18-()	Veneer	2991	3242	2983	3159
		DL1-36D18-()	Stocked Laminate	2252	2503	2244	2420
36 ROUND x 21H DIA: 36 H: 21		DV1-36D21-()	Veneer	3230	3481	3222	3398
		DL1-36D21-()	Stocked Laminate	2421	2672	2413	2589
36 ROUND x 24H DIA: 36 H: 24		DV1-36D24-()	Veneer	3416	3667	3408	3584
		DL1-36D24-()	Stocked Laminate	2558	2809	2550	2726

Add SOLID SURFACE ONLAY price to prices above

36 DIA SOLID SURFACE ONLAY UPCHARGE	A	B	C	D
Stocked	2328 LIST	2328 LIST	2601 LIST	2875 LIST
Non-stocked (per color, per order)	ADD 410 NET	450 NET	490 NET	520 NET

NOTE: 1/2" Solid Surface Onlay will increase overall height by 1/2".

	MODEL	DESCRIPTION	PRICE
36 DIA BOTTOM EDGE PROTECTOR	EPOD36	For use with 36" Round Tables	ADD 325 LIST

NON-STOCKED / CUSTOM FINISH UPCHARGES	Non-Stocked Laminate (per color, per order)	ADD 50 NET
	Custom Wood Finish (CWF) (one-time upcharge)	ADD 300 NET

KEY FOR SPECIFYING DRUM TABLES:

Replace () in the product code with the following to specify legs/base. NOTE: Plinth Base Shown.

VP or LP	3"H Plinth Base with matching Veneer (VP) or Laminate (LP)
BP	3"H Plinth Base with Black Laminate
MP	3"H Black Metal Plinth Base
MW	5"H Hard Maple Legs (to match Tria Wood Legs)
CW	5"H Hard Maple Legs (to match Coffee House Wood Legs)
BC	5"H Brushed Chrome Metal Legs (to match Tria Tables)
BM	5"H Black Metal Legs (to match Tria Tables)
BA	5"H Brushed Aluminum Legs (to match Coffee House Aluminum Legs)
NB	No Base

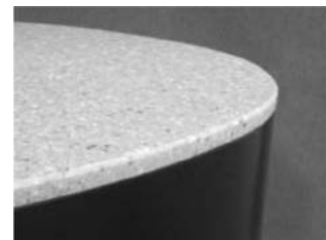

**SELF EDGE
DETAIL
WITH SOLID
SURFACE TOP**



ELECTRICAL / POWER PORT

Power Ports are available on Drum tables; however, due to the many sizes and options available, a drawing will be required for each table (when sizes or placement vary) showing the Power Port location desired. Power Ports must be placed on a flat surface.

Tables will be subject to a custom engineering fee of \$300 NET for each different sized table or tables requiring different Power Port locations. Contact Integra Customer Service for Pricing.

3/4" GLASS TOP



MODEL	DESCRIPTION	PRICE
GLASS	3/4" Glass (set on top)	Contact Customer Service for Options and Pricing

PRODUCT OPTIONS

PERMA-COAT WOOD LEG PROTECTOR \$35 List / Leg



CUBE WITH 3/4" RADIUS ED SOLID WOOD EDGE

HARD MAPLE OR LAMINATE

	MODEL	TOP	PLINTH BASE VP, LP, BP, NB	BLACK METAL PLINTH MP	WOOD/ALUM LEGS MW, CW, BA	METAL LEGS BC, BM
18 SQUARE x 18H W: 18 D: 18 H: 18	CV2-181818 (_)	Veneer	2544	2697	2632	2808
	CL2-181818 (_)	Stocked Laminate	2484	2637	2572	2748
18 SQUARE x 21H W: 18 D: 18 H: 21	CV2-181821 (_)	Veneer	2676	2829	2764	2940
	CL2-181821 (_)	Stocked Laminate	2544	2697	2632	2808
18 SQUARE x 24H W: 18 D: 18 H: 24	CV2-181824 (_)	Veneer	2795	2948	2883	3059
	CL2-181824 (_)	Stocked Laminate	2585	2738	2673	2849

Add SOLID SURFACE ONLAY price to prices above

18 x 18 SOLID SURFACE ONLAY UPCHARGE	A	B	C	D
Stocked	583 LIST	583 LIST	652 LIST	719 LIST
Non-stocked (per color, per order)	ADD 410 NET	450 NET	490 NET	520 NET

NOTE: 1/2" Solid Surface Onlay will increase overall height by 1/2".

MODEL	DESCRIPTION	PRICE
18 x 18 BOTTOM EDGE PROTECTOR EPOC18	For use with 18" Square Tables	ADD 86 LIST

	MODEL	TOP	PLINTH BASE VP, LP, BP, NB	BLACK METAL PLINTH MP	WOOD/ALUM LEGS MW, CW, BA	METAL LEGS BC, BM
24 SQUARE x 18H W: 24 D: 24 H: 18	CV2-242418 (_)	Veneer	3027	3212	3089	3265
	CL2-242418 (_)	Stocked Laminate	2843	3028	2905	3081
24 SQUARE x 21H W: 24 D: 24 H: 21	CV2-242421 (_)	Veneer	3193	3378	3255	3431
	CL2-242421 (_)	Stocked Laminate	2942	3127	3004	3180
24 SQUARE x 24H W: 24 D: 24 H: 24	CV2-242424 (_)	Veneer	3377	3562	3439	3615
	CL2-242424 (_)	Stocked Laminate	3005	3190	2893	3243

Add SOLID SURFACE ONLAY price to prices above

24 x 24 SOLID SURFACE ONLAY UPCHARGE	A	B	C	D
Stocked	1034 LIST	1034 LIST	1156 LIST	1277 LIST
Non-stocked (per color, per order)	ADD 410 NET	450 NET	490 NET	520 NET

NOTE: 1/2" Solid Surface Onlay will increase overall height by 1/2".

MODEL	DESCRIPTION	PRICE
24 x 24 BOTTOM EDGE PROTECTOR EPOC24	For use with 24" Square Tables	ADD 201 LIST

NON-STOCKED / CUSTOM FINISH UPCHARGES	Non-Stocked Laminate (per color, per order)	ADD 50 NET
	Custom Wood Finish (CWF) (one-time upcharge)	ADD 300 NET

KEY FOR SPECIFYING CUBE TABLES:

Replace () in the product code with the following to specify legs/base. NOTE: Plinth Base Shown.

- VP or LP** 3"H Plinth Base with matching Veneer (VP) or Laminate (LP)
- BP** 3"H Plinth Base with Black Laminate
- MP** 3"H Black Metal Plinth Base
- MW** 5"H Hard Maple Legs (to match Tria Wood Legs)
- CW** 5"H Hard Maple Legs (to match Coffee House Wood Legs)
- BC** 5"H Brushed Chrome Metal Legs (to match Tria Tables)
- BM** 5"H Black Metal Legs (to match Tria Tables)
- BA** 5"H Brushed Aluminum Legs (to match Coffee House Aluminum Legs)
- NB** No Base



SOLID WOOD EDGE DETAIL WITH SOLID SURFACE TOP
Will have 3/4" exposed edge detail as shown.



CUBE WITH 3/4" RADIUS ED SOLID WOOD EDGE

	MODEL	TOP	PLINTH BASE VP, LP, BP, NB	BLACK METAL PLINTH MP	WOOD/ALUM LEGS MW, CW, BA	METAL LEGS BC, BM
30 SQUARE x 18H W: 30 D: 30 H: 18	CV2-303018- (_)	Veneer	3804	4093	3843	4019
	CL2-303018- (_)	Stocked Laminate	3238	3527	3277	3453
30 SQUARE x 21H W: 30 D: 30 H: 21	CV2-303021- (_)	Veneer	3921	4210	3960	4136
	CL2-303021- (_)	Stocked Laminate	3395	3684	3434	3610
30 SQUARE x 24H W: 30 D: 30 H: 24	CV2-303024- (_)	Veneer	4027	4316	4066	4242
	CL2-303024- (_)	Stocked Laminate	3478	3767	3517	3693

Add SOLID SURFACE ONLAY price to prices above

30 x 30 SOLID SURFACE ONLAY UPCHARGE	A	B	C	D
Stocked	1616 LIST	1616 LIST	1806 LIST	1997 LIST
Non-stocked (per color, per order)	ADD 410 NET	450 NET	490 NET	520 NET

NOTE: 1/2" Solid Surface Onlay will increase overall height by 1/2".

	MODEL	DESCRIPTION	PRICE
30 x 30 BOTTOM EDGE PROTECTOR	EPOC30	For use with 30" Square Tables	ADD 227 LIST

	MODEL	TOP	PLINTH BASE VP, LP, BP, NB	BLACK METAL PLINTH MP	WOOD/ALUM LEGS MW, CW, BA	METAL LEGS BC, BM
36 SQUARE x 18H W: 36 D: 36 H: 18	CV2-363618- (_)	Veneer	4409	4736	4401	4577
	CL2-363618- (_)	Stocked Laminate	3656	3983	3648	3824
36 SQUARE x 21H W: 36 D: 36 H: 21	CV2-363621- (_)	Veneer	4495	4822	4487	4663
	CL2-363621- (_)	Stocked Laminate	3835	4162	3827	4003
36 SQUARE x 24H W: 36 D: 36 H: 24	CV2-363624- (_)	Veneer	4656	4983	4648	4824
	CL2-363624- (_)	Stocked Laminate	3997	4324	3989	4165

Add SOLID SURFACE ONLAY price to prices above

36 x 36 SOLID SURFACE ONLAY UPCHARGE	A	B	C	D
Stocked	2328 LIST	2328 LIST	2601 LIST	2875 LIST
Non-stocked (per color, per order)	ADD 410 NET	450 NET	490 NET	520 NET

NOTE: 1/2" Solid Surface Onlay will increase overall height by 1/2".

	MODEL	DESCRIPTION	PRICE
36 x 36 BOTTOM EDGE PROTECTOR	EPOC36	For use with 36" Square Tables	ADD 325 LIST

NON-STOCKED / CUSTOM FINISH UPCHARGES

Non-Stocked Laminate (per color, per order)	ADD	50 NET
Custom Wood Finish (CWF) (one-time upcharge)	ADD	300 NET

KEY FOR SPECIFYING CUBE TABLES:

Replace () in the product code with the following to specify legs/base. NOTE: Plinth Base Shown.

VP or LP	3"H Plinth Base with matching Veneer (VP) or Laminate (LP)
BP	3"H Plinth Base with Black Laminate
MP	3"H Black Metal Plinth Base
MW	5"H Hard Maple Legs (to match Tria Wood Legs)
CW	5"H Hard Maple Legs (to match Coffee House Wood Legs)
BC	5"H Brushed Chrome Metal Legs (to match Tria Tables)
BM	5"H Black Metal Legs (to match Tria Tables)
BA	5"H Brushed Aluminum Legs (to match Coffee House Aluminum Legs)
NB	No Base



SOLID WOOD EDGE DETAIL WITH SOLID SURFACE TOP
Will have 3/4" exposed edge detail as shown.



CUBE WITH 3/4" RADIUS SOLID WOOD EDGE | OPTIONS

ELECTRICAL / POWER PORT

Power Ports are available on Cube tables; however, due to the many sizes and options available, a drawing will be required for each table (when sizes or placement vary) showing the Power Port location desired. Power Ports must be placed on a flat surface.

Tables will be subject to a custom engineering fee of \$300 NET for each different sized table or tables requiring different Power Port locations. Contact Integra Customer Service for Pricing.

3/4" GLASS TOP



MODEL	DESCRIPTION	PRICE
GLASS	3/4" Glass (set on top)	Contact Customer Service for Options and Pricing

PRODUCT OPTIONS

PERMA-COAT WOOD LEG PROTECTOR	\$33 List / Leg
--------------------------------------	-----------------



TABLE COLLECTIONS | DRUMS

COMPONENT-BASED CONSTRUCTION

DRUM WITH 3/4" RADIUSED SOLID WOOD EDGE

HARD MAPLE OR LAMINATE

		MODEL	TOP	PLINTH BASE VP, LP, BP, NB	BLACK METAL PLINTH MP	WOOD/ALUM LEGS MW, CW, BA	METAL LEGS BC, BM
18 ROUND x 18H DIA: 18 H: 18		DV2-18D18-(_)	Veneer	2413	2533	2501	2677
		DL2-18D18-(_)	Stocked Laminate	2413	2533	2501	2677
18 ROUND x 21H DIA: 18 H: 21		DV2-18D21-(_)	Veneer	2523	2643	2611	2787
		DL2-18D21-(_)	Stocked Laminate	2523	2643	2611	2787
18 ROUND x 24H DIA: 18 H: 24		DV2-18D24-(_)	Veneer	2639	2759	2727	2903
		DL2-18D24-(_)	Stocked Laminate	2585	2705	2673	2849

Add SOLID SURFACE ONLAY price to prices above

18 DIA SOLID SURFACE ONLAY UPCHARGE	A	B	C	D
Stocked	583 LIST	583 LIST	652 LIST	719 LIST
Non-stocked (per color, per order)	ADD 410 NET	450 NET	490 NET	520 NET

NOTE: 1/2" Solid Surface Onlay will increase overall height by 1/2".

	MODEL	DESCRIPTION	PRICE
18 DIA BOTTOM EDGE PROTECTOR	EPOD18	For use with 18" Round Tables	ADD 86 LIST

		MODEL	TOP	PLINTH BASE VP, LP, BP, NB	BLACK METAL PLINTH MP	WOOD/ALUM LEGS MW, CW, BA	METAL LEGS BC, BM
24 ROUND x 18H DIA: 24 H: 18		DV2-24D18-(_)	Veneer	2835	2989	2897	3073
		DL2-24D18-(_)	Stocked Laminate	2835	2989	2897	3073
24 ROUND x 21H DIA: 24 H: 21		DV2-24D21-(_)	Veneer	2942	3096	3004	3180
		DL2-24D21-(_)	Stocked Laminate	2942	3096	3004	3180
24 ROUND x 24H DIA: 24 H: 24		DV2-24D24-(_)	Veneer	3057	3211	3119	3295
		DL2-24D24-(_)	Stocked Laminate	3005	3159	3067	3243

Add SOLID SURFACE ONLAY price to prices above

24 DIA SOLID SURFACE ONLAY UPCHARGE	A	B	C	D
Stocked	1034 LIST	1034 LIST	1156 LIST	1277 LIST
Non-stocked (per color, per order)	ADD 410 NET	450 NET	490 NET	520 NET

NOTE: 1/2" Solid Surface Onlay will increase overall height by 1/2".

	MODEL	DESCRIPTION	PRICE
24 DIA BOTTOM EDGE PROTECTOR	EPOD24	For use with 24" Round Tables	ADD 129 LIST

NON-STOCKED / CUSTOM FINISH UPCHARGES	Non-Stocked Laminate (per color, per order)	ADD 50 NET
	Custom Wood Finish (CWF) (one-time upcharge)	ADD 300 NET

KEY FOR SPECIFYING DRUM TABLES:

Replace () in the product code with the following to specify legs/base. NOTE: Plinth Base Shown.

- VP or LP** 3"H Plinth Base with matching Veneer (VP) or Laminate (LP)
- BP** 3"H Plinth Base with Black Laminate
- MP** 3"H Black Metal Plinth Base
- MW** 5"H Hard Maple Legs (to match Tria Wood Legs)
- CW** 5"H Hard Maple Legs (to match Coffee House Wood Legs)
- BC** 5"H Brushed Chrome Metal Legs (to match Tria Tables)
- BM** 5"H Black Metal Legs (to match Tria Tables)
- BA** 5"H Brushed Aluminum Legs (to match Coffee House Aluminum Legs)
- NB** No Base



SOLID WOOD EDGE DETAIL WITH SOLID SURFACE TOP
Will have 3/4" exposed edge detail as shown.



DRUM WITH 3/4" RADIUS SOLID WOOD EDGE

		MODEL	TOP	PLINTH BASE VP, LP, BP, NB	BLACK METAL PLINTH MP	WOOD/ALUM LEGS MW, CW, BA	METAL LEGS BC, BM
30 ROUND x 18H DIA: 30 H: 18		DV2-30D18- (_)	Veneer	3493	3724	3532	3708
		DL2-30D18- (_)	Stocked Laminate	3238	3469	3277	3453
30 ROUND x 21H DIA: 30 H: 21		DV2-30D21- (_)	Veneer	3679	3910	3718	3894
		DL2-30D21- (_)	Stocked Laminate	3395	3626	3434	3610
30 ROUND x 24H DIA: 30 H: 24		DV2-30D24- (_)	Veneer	3795	4026	3834	4010
		DL2-30D24- (_)	Stocked Laminate	3478	3709	3517	3693

Add SOLID SURFACE ONLAY price to prices above

30 DIA SOLID SURFACE ONLAY UPCHARGE	A	B	C	D
Stocked	1616 LIST	1616 LIST	1806 LIST	1997 LIST
Non-stocked (per color, per order)	ADD 410 NET	450 NET	490 NET	520 NET

NOTE: 1/2" Solid Surface Onlay will increase overall height by 1/2".

	MODEL	DESCRIPTION	PRICE
30 DIA BOTTOM EDGE PROTECTOR	EPOD30	For use with 30" Round Tables	ADD 227 LIST

		MODEL	TOP	PLINTH BASE VP, LP, BP, NB	BLACK METAL PLINTH MP	WOOD/ALUM LEGS MW, CW, BA	METAL LEGS BC, BM
36 ROUND x 18H DIA: 36 H: 18		DV2-36D18- (_)	Veneer	3952	4203	3944	4120
		DL2-36D18- (_)	Stocked Laminate	3656	3907	3648	3824
36 ROUND x 21H DIA: 36 H: 21		DV2-36D21- (_)	Veneer	4192	4443	4184	4360
		DL2-36D21- (_)	Stocked Laminate	3835	4086	3827	4003
36 ROUND x 24H DIA: 36 H: 24		DV2-36D24- (_)	Veneer	4285	4536	4277	4453
		DL2-36D24- (_)	Stocked Laminate	3997	4248	3989	4165

Add SOLID SURFACE ONLAY price to prices above

36 DIA SOLID SURFACE ONLAY UPCHARGE	A	B	C	D
Stocked	2328 LIST	2328 LIST	2601 LIST	2875 LIST
Non-stocked (per color, per order)	ADD 410 NET	450 NET	490 NET	520 NET

NOTE: 1/2" Solid Surface Onlay will increase overall height by 1/2".

	MODEL	DESCRIPTION	PRICE
36 DIA BOTTOM EDGE PROTECTOR	EPOD36	For use with 36" Round Tables	ADD 325 LIST

NON-STOCKED / CUSTOM FINISH UPCHARGES	Non-Stocked Laminate (per color, per order)	ADD 50 NET
	Custom Wood Finish (CWF) (one-time upcharge)	ADD 300 NET

KEY FOR SPECIFYING DRUM TABLES:

Replace () in the product code with the following to specify legs/base. NOTE: Plinth Base Shown.

VP or LP	3"H Plinth Base with matching Veneer (VP) or Laminate (LP)
BP	3"H Plinth Base with Black Laminate
MP	3"H Black Metal Plinth Base
MW	5"H Hard Maple Legs (to match Tria Wood Legs)
CW	5"H Hard Maple Legs (to match Coffee House Wood Legs)
BC	5"H Brushed Chrome Metal Legs (to match Tria Tables)
BM	5"H Black Metal Legs (to match Tria Tables)
BA	5"H Brushed Aluminum Legs (to match Coffee House Aluminum Legs)
NB	No Base



SOLID WOOD EDGE DETAIL WITH SOLID SURFACE TOP
Will have 3/4" exposed edge detail as shown.



ELECTRICAL / POWER PORT

Power Ports are available on Drum tables; however, due to the many sizes and options available, a drawing will be required for each table (when sizes or placement vary) showing the Power Port location desired. Power Ports must be placed on a flat surface.

Tables will be subject to a custom engineering fee of \$300 NET for each different sized table or tables requiring different Power Port locations. Contact Integra Customer Service for Pricing.

3/4" GLASS TOP



MODEL	DESCRIPTION	PRICE
GLASS	3/4" Glass (set on top)	Contact Customer Service for Options and Pricing

PRODUCT OPTIONS

PERMA-COAT WOOD LEG PROTECTOR \$35 List / Leg



SOLID SURFACE TOP

W: 15 D: 17 H: 27.25



MODEL	GRADE	A	B	C	D
KIXSY-SS	Stocked	978 LIST	1007 LIST	1051 LIST	1120 LIST
	Non-stocked (per color, per order)	ADD 410 NET	450 NET	490 NET	520 NET

NOTE: Must specify powder coat finish for base.

LAMINATE/PLYWOOD EDGE TOP

W: 15 D: 17 H: 27.25

MODEL	GRADE	PRICE
KIXSY-LM	Stocked (Laminate tablets have a plywood edge. Specify finish.)	810 LIST
	Non-stocked (per color, per order)	ADD 50 NET

NOTE: Must specify powder coat finish for base.



THE LOUNGE COLLECTION

ELITE	TLC 2 - 5
FLAIR	TLC 6 - 9
RENDEZVOUS	TLC 10 - 13
RENDEZVOUS OTTOMANS	TLC 14
RENDEZVOUS TABLES	TLC 15 - 16
RENDEZVOUS SQUARED	TLC 17 - 20
RENDEZVOUS SQUARED OTTOMANS	TLC 21
SOIRÉE	TLC 22 - 24
SOIRÉE OTTOMANS	TLC 25



THE LOUNGE COLLECTION | ELITE



CERTIFIED
CLEAN AIR GOLD

Healthier
Hospitals



COMPONENT-BASED
CONSTRUCTION

2K STATIC
CAPACITY

1K DROP
CAPACITY

ELITE UPHOLSTERED ARM

STANDARD WITH SOLID WOOD LEGS

	MODEL	YARDS	COM	M	COL O	P	R	S	T	U	W/WL
CHAIR W: 33 D: 30.5 H: 32 SW: 24 SD: 21 SH: 18.5 BH: 16 AH: 23.25	 EL-1	5.5	2033	2237	2484	2710	2952	3188	3430	3667	4024
SETTEE W: 57 SW: 48	 EL-2	8.5	3123	3438	3820	4169	4543	4908	5282	5648	6200
SOFA W: 81 SW: 72	 EL-3	11.5	4199	4625	5142	5614	6120	6614	7120	7615	8362

ELITE | LEG OPTIONS

	MODEL	DESCRIPTION	PRICE
TRIANGULAR WOOD LEGS	EL4M	Specify Wood Finish on Hard Maple	No Upcharge



	MODEL	DESCRIPTION	PRICE
SQUARE WOOD LEGS	GGE4	Specify Wood Finish on Hard Maple	No Upcharge



	MODEL	DESCRIPTION	PRICE
HIDE & GO MOBILITY	HGRS4	Wood legs with in-line casters in front and dome glides in back. Specify Wood finish.	64 LIST



NOTE: Recommended for use on Chairs only, not on Settees and Sofas.

	MODEL	DESCRIPTION	PRICE
3" HEAVY DUTY CASTERS	43C	Set of 4 Locking Casters	108 LIST/SET OF 4



NOTE: Recommended for use on Chairs only, not on Settees and Sofas.

	MODEL	DESCRIPTION	PRICE
BRUSHED ALUMINUM NAVE LEG	4NL		108 LIST/SET OF 4



	MODEL	DESCRIPTION	PRICE
BAR LEGS	EL4S		128 LIST/SET OF 4





ELITE | ARM CAP OPTIONS

SOLID SURFACE ARM CAPS



MODEL	GRADE		A	B	C	D
ACES	Stocked Solid Surface		396 LIST/PR	424 LIST/PR	462 LIST/PR	528 LIST/PR
	Non-stocked (per color, per order)	ADD	410 NET	450 NET	490 NET	520 NET

NOTE: Arm Caps are contoured; they are not flat.

WOOD ARM CAPS



MODEL	DESCRIPTION	PRICE
ACEM	Solid Wood. Specify finish.	316 LIST/PR

NOTE: Arm Caps are contoured; they are not flat.

Custom Wood Finish (CWF) is a one-time upcharge of 300 NET per color.

ELITE | TABLET OPTIONS

ALL INTEGRA TABLETS HAVE A 300LB CAPACITY



Tablets available in Upholstered Arms with and without Arm Caps.

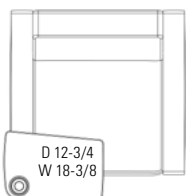
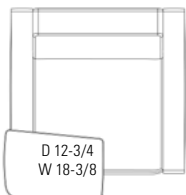

With Cup Holder Option

CHOOSE POSITION

(4)

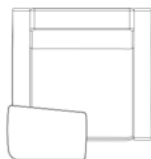

(4) - Tablet on right as seated

(5)

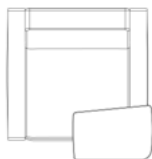

(5) - Tablet on left as seated

SOLID SURFACE TABLET OPTION

MODEL	GRADE		A	B	C	D
ST-(4/5)	Stocked		723 LIST	759 LIST	811 LIST	894 LIST
	Non-stocked (per color, per order)	ADD	410 NET	450 NET	490 NET	520 NET

LAMINATE OVER PLYWOOD CORE/EDGE TABLET OPTION

MODEL	GRADE	PRICE
LT-(4/5)	Stocked (Laminate tablets have a plywood edge. Specify finish.)	548 LIST
	Non-stocked (per color, per order)	ADD 50 NET

VENEER OVER PLYWOOD CORE/EDGE TABLET OPTION

MODEL	GRADE	PRICE
VT-(4/5)	Standard Wood Finish	548 LIST
	Custom Finish (one time charge per color)	ADD 300 NET

CUP HOLDER

MODEL	FINISH	PRICE
CUPIN	Brushed Aluminum	216 LIST



ELITE | OTHER OPTIONS

	MODEL	DESCRIPTION	PRICE
METAL SHELF	SHF24M	Black Metal	602 LIST



	MODEL	DESCRIPTION	PRICE
RECESSED PULL HANDLE	RPH(B/G)	For use with mobile options. Specify Black (B) or Gray (G).	86 LIST



	MODEL	DESCRIPTION	PRICE
ELECTRICAL / POWER PORT	XE3(COLOR)(4/5)	(1) Dual USB and (2) Standard Plug-Ins. Available in All Black (B), All White (W) and Silver with White Outlets (S).	543 LIST/EACH



(B) ALL BLACK



(W) ALL WHITE



(S) SILVER WITH WHITE OUTLETS



NOTE: Must choose placement in front panel: (4) Electrical on right as seated or (5) Electrical on left as seated

PRODUCT OPTIONS





- MOISTURE BARRIER** \$22 List / Yard
- FIRE WALL / CA T.B. 133** \$82 List / Yard
- TAMPER-RESISTANT FASTENERS** \$51 List / Chair
- PERMA-COAT WOOD LEG PROTECTOR** \$35 List / Leg
- WEIGHTED / THEFT DETERRENT** \$610 List / 50 lb Weight



ELITE OTTOMANS

		MODEL	YARDS	COM	M	COL						W/WL
						O	P	R	S	T	U	
SINGLE		ELOT1	3	959	1070	1205	1328	1460	1589	1721	1850	2045
W: 26 D: 22 H: 18.5												
DOUBLE		ELOT2	4	1327	1475	1655	1819	1995	2167	2343	2515	2775
W: 48 D: 22 H: 18.5												
BIG OTTO		ELOT3	4.5	1546	1713	1915	2100	2298	2491	2689	2883	3175
W: 36 D: 36 H: 18.5												

ELITE OTTOMANS | LEG OPTIONS

	MODEL	DESCRIPTION	PRICE
TRIANGULAR WOOD LEGS		EL4M Specify Wood Finish on Hard Maple	No Upcharge
SQUARE WOOD LEGS		GGE4 Specify Wood Finish on Hard Maple	No Upcharge
3" HEAVY DUTY CASTERS		43C Set of 4 Locking Casters	108 LIST/SET OF 4
BRUSHED ALUMINUM NAVE LEG		4NL	108 LIST/SET OF 4
BAR LEGS		EL4S	128 LIST/SET OF 4

PRODUCT OPTIONS

- MOISTURE BARRIER** \$22 List / Yard
- FIRE WALL / CA T.B. 133** \$82 List / Yard
- TAMPER-RESISTANT FASTENERS** \$51 List / Chair
- PERMA-COAT WOOD LEG PROTECTOR** \$35 List / Leg
- WEIGHTED / THEFT DETERRENT** \$305 List / 25 lb Weight



THE LOUNGE COLLECTION | FLAIR



CERTIFIED
CLEAN AIR GOLD

Healthier
Hospitals



COMPONENT-BASED
CONSTRUCTION

2K STATIC
CAPACITY



1K DROP
CAPACITY

FLAIR UPHOLSTERED ARM

STANDARD WITH SOLID WOOD LEGS

	MODEL	YARDS	COM	M	COL O	P	R	S	T	U	W/WL
CHAIR	FLAIR-1	6.25	2008	2239	2521	2777	3052	3321	3596	3864	4271
W: 34 D: 32 H: 33.5 SW: 21 SD: 20 SH: 18.5 BH: 18 AH: 24											
SETTEE	FLAIR-2	9.5	3043	3395	3822	4212	4630	5038	5456	5865	6482
W: 55 SW: 42											
SOFA	FLAIR-3	12.75	4086	4558	5132	5654	6215	6764	7325	7873	8702
W: 76 SW: 63											

FLAIR UPHOLSTERED ARM - OVERSIZE

	MODEL	YARDS	COM	M	COL O	P	R	S	T	U	W/WL
CHAIR	FLAIRO-1	7	2311	2570	2885	3172	3480	3781	4089	4390	4845
W: 39 D: 32 H: 33.5 SW: 26 SD: 20 SH: 18.5 BH: 18 AH: 24											
SETTEE	FLAIRO-2	11	3689	4096	4591	5042	5526	5999	6483	6956	7671
W: 65 SW: 52											
SOFA	FLAIRO-3	15	4904	5459	6134	6749	7409	8054	8714	9359	10334
W: 91 SW: 78											



FLAIR | LEG OPTIONS

WOOD LEGS



MODEL	DESCRIPTION	PRICE
GGF4	Specify Wood Finish on Hard Maple	No Upcharge

HIDE & GO MOBILITY



MODEL	DESCRIPTION	PRICE
HGF4	Wood legs with in-line casters in front and dome glides in back. Specify Wood finish.	64 LIST

NOTE: Recommended for use on Chairs only, not on Settees and Sofas.

3"H HEAVY DUTY CASTERS



MODEL	DESCRIPTION	PRICE
43C	Set of 4 Locking Casters	108 LIST/SET OF 4

NOTE: Recommended for use on Chairs only, not on Settees and Sofas.

3"H BRUSHED ALUMINUM NAVE LEGS



MODEL	PRICE
4NL	108 LIST/SET OF 4

FLAIR | TABLET OPTIONS

ALL INTEGRA TABLETS HAVE A 300LB CAPACITY

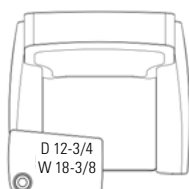

With Cup Holder Option

CHOOSE POSITION

(4)

(5)



(4) - Tablet on right as seated

(5) - Tablet on left as seated

SOLID SURFACE TABLET OPTION

MODEL	GRADE	A	B	C	D
ST-(4/5)	Stocked	723 LIST	759 LIST	811 LIST	894 LIST
	Non-stocked (per color, per order)	ADD 410 NET	450 NET	490 NET	520 NET

LAMINATE OVER PLYWOOD CORE/EDGE TABLET OPTION

MODEL	GRADE	PRICE
LT-(4/5)	Stocked (Laminate tablets have a plywood edge. Specify finish.)	548 LIST
	Non-stocked (per color, per order)	ADD 50 NET

VENEER OVER PLYWOOD CORE/EDGE TABLET OPTION

MODEL	GRADE	PRICE
VT-(4/5)	Standard Wood Finish	548 LIST
	Custom Finish (one time charge per color)	ADD 300 NET

CUP HOLDER

MODEL	FINISH	PRICE
CUPIN	Brushed Aluminum	216 LIST



FLAIR | OTHER OPTIONS

	MODEL	FOR USE WITH	DESCRIPTION	PRICE
METAL SHELF	SHF21M	Flair Seating	Black Metal	514 LIST
	SHF26M	Flair Oversize	Black Metal	602 LIST



	MODEL	DESCRIPTION	PRICE
RECESSED PULL HANDLE	RPH(B/G)	For use with mobile options. Specify Black (B) or Gray (G).	86 LIST



	MODEL	DESCRIPTION	PRICE
ELECTRICAL / POWER PORT	XE3(COLOR)(4/5)	(1) Dual USB and (2) Standard Plug-Ins. Available in All Black (B), All White (W) and Silver with White Outlets (S).	543 LIST/EACH



(B) ALL BLACK



(W) ALL WHITE



(S) SILVER WITH WHITE OUTLETS



NOTE: Must choose placement in front panel: (4) Electrical on right as seated or (5) Electrical on left as seated

PRODUCT OPTIONS



- MOISTURE BARRIER** \$22 List / Yard
- FIRE WALL / CA T.B. 133** \$82 List / Yard
- TAMPER-RESISTANT FASTENERS** \$51 List / Chair
- PERMA-COAT WOOD LEG PROTECTOR** \$35 List / Leg
- WEIGHTED / THEFT DETERRENT** \$610 List / 50 lb Weight



FLAIR AND SOIRÉE OTTOMANS

		MODEL	YARDS	COM	M	COL						W / WL
						O	P	R	S	T	U	
SINGLE		SOT1	3	959	1070	1205	1328	1460	1589	1721	1850	2045
W: 26 D: 22 H: 18.5												
DOUBLE		SOT2	4	1327	1475	1655	1819	1995	2167	2343	2515	2775
W: 48 D: 22 H: 18.5												
BIG OTTO		SOT3	4.5	1546	1713	1915	2100	2298	2491	2689	2883	3175
W: 36 D: 36 H: 18.5												

FLAIR AND SOIRÉE OTTOMANS | LEG OPTIONS

	MODEL	DESCRIPTION	PRICE
WOOD LEGS		GGF4 Specify Wood Finish on Hard Maple	No Upcharge
3" HEAVY DUTY CASTERS		43C Set of 4 Locking Casters	108 LIST/SET OF 4
3"H BRUSHED ALUMINUM NAVE LEGS		4NL	108 LIST/SET OF 4

PRODUCT OPTIONS

- MOISTURE BARRIER** \$22 List / Yard
- FIRE WALL / CA T.B. 133** \$82 List / Yard
- TAMPER-RESISTANT FASTENERS** \$51 List / Chair
- PERMA-COAT WOOD LEG PROTECTOR** \$35 List / Leg
- WEIGHTED / THEFT DETERRENT** \$305 List / 25 lb Weight



THE LOUNGE COLLECTION | RENDEZVOUS



CERTIFIED
CLEAN AIR GOLD

Healthier
Hospitals





COMPONENT-BASED
CONSTRUCTION

2K STATIC
CAPACITY



1K DROP
CAPACITY

RENDEZVOUS UPHOLSTERED ARM

STANDARD WITH SOLID WOOD LEGS

	MODEL	YARDS	COM	M	COL O	P	R	S	T	U	W/WL
CHAIR	RU-1	5	1803	1988	2213	2418	2638	2853	3073	3288	3613
W: 33 D: 32 H: 33 SW: 21 SD: 20 SH: 19.5 BH: 16 AH: 24											
SETTEE	RU-2	7.5	2710	2988	3325	3633	3963	4285	4615	4938	5425
W: 54 SW: 42											
SOFA	RU-3	10	3614	3984	4434	4844	5284	5714	6154	6584	7234
W: 75 SW: 63											
HIGHER BACK - 18"H	HB										57 LIST/BACK
H: 35 SH: 18											

RENDEZVOUS UPHOLSTERED ARM - OVERSIZE

	MODEL	YARDS	COM	M	COL O	P	R	S	T	U	W/WL
CHAIR	RUO-1	6	2085	2307	2577	2823	3087	3345	3609	3867	4257
W: 38 D: 32 H: 35 SW: 26 SD: 20 SH: 19.5 BH: 18 AH: 24											
SETTEE	RUO-2	9.5	3271	3623	4050	4440	4858	5266	5684	6093	6710
W: 64 SW: 52											
SOFA	RUO-3	13	4454	4935	5520	6053	6625	7184	7756	8315	9160
W: 90 SW: 78											



RENDEZVOUS | LEG OPTIONS

	MODEL	DESCRIPTION	PRICE
3"H WOOD LEG	GGR4M	Hard Maple Legs	No Upcharge



	MODEL	DESCRIPTION	PRICE
3"H HIDE & GO MOBILITY	HGR4	Wood legs with in-line casters in front and dome glides in back. Specify Wood finish.	64 LIST



NOTE: Recommended for use on Chairs only, not on Settees and Sofas.

	MODEL	DESCRIPTION	PRICE
3" HEAVY DUTY CASTERS	43C	Set of 4 Locking Casters	108 LIST/SET OF 4



NOTE: Recommended for use on Chairs only, not on Settees and Sofas.

	MODEL	DESCRIPTION	PRICE
3"H BRUSHED ALUMINUM NAVE LEGS	4NL		108 LIST/SET OF 4



	MODEL	DESCRIPTION	PRICE
2"H WOOD LEGS	R4M	Hard Maple Legs	No Upcharge



NOTE: 2" High legs (the original leg & base) reduce the seat height and overall height by 1" on seating

	MODEL	DESCRIPTION	PRICE
2"H WOOD BASE	RMB	Available in Hard Maple only	64 LIST/PAIR



NOTE: 2" High legs (the original leg & base) reduce the seat height and overall height by 1" on seating

RENDEZVOUS | ARM CAP OPTIONS

	MODEL	GRADE	A	B	C	D
SOLID SURFACE ARM CAPS	ACRS	Stocked Solid Surface	492 LIST/PR	534 LIST/PR	598 LIST/PR	702 LIST/PR
		Non-stocked (per color, per order)	ADD	410 NET	450 NET	490 NET



	MODEL	DESCRIPTION	PRICE
WOOD ARM CAPS	ACRM	Hard Maple Arm Caps	412 LIST/PR



NOTE: Custom Wood Finish (CWF) is a one-time upcharge of 300 NET per color.



Tablets available in Upholstered Arms with and without Arm Caps.

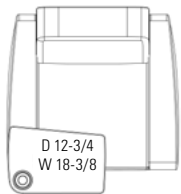
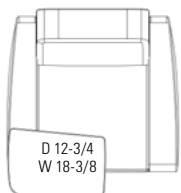

With Cup Holder Option

CHOOSE POSITION

(4)

(5)



(4) - Tablet on right as seated

(5) - Tablet on left as seated

SOLID SURFACE TABLET OPTION

MODEL	GRADE		A	B	C	D
ST-(4/5)	Stocked		723 LIST	759 LIST	811 LIST	894 LIST
	Non-stocked (per color, per order)	ADD	410 NET	450 NET	490 NET	520 NET

LAMINATE OVER PLYWOOD CORE/EDGE TABLET OPTION

MODEL	GRADE		PRICE
LT-(4/5)	Stocked (Laminate tablets have a plywood edge. Specify finish.)		548 LIST
	Non-stocked (per color, per order)	ADD	50 NET

VENEER OVER PLYWOOD CORE/EDGE TABLET OPTION

MODEL	GRADE		PRICE
VT-(4/5)	Standard Wood Finish		548 LIST
	Custom Finish (one time charge per color)	ADD	300 NET

CUP HOLDER

MODEL	FINISH	PRICE
CUPIN	Brushed Aluminum	216 LIST



RENDEZVOUS | OTHER OPTIONS

METAL SHELF



MODEL	FOR USE WITH	DESCRIPTION	PRICE
SHF21M	Rendezvous Seating	Black Metal	514 LIST
SHF26M	Rendezvous Oversize Seating	Black Metal	568 LIST

RECESSED PULL HANDLE



MODEL	DESCRIPTION	PRICE
RPH(B/G)	For use with mobile options. Specify Black (B) or Gray (G).	86 LIST

ELECTRICAL / POWER PORT



(B) ALL BLACK



(W) ALL WHITE



(S) SILVER WITH WHITE OUTLETS

MODEL	DESCRIPTION	PRICE
XE3(COLOR)(4/5)	(1) Dual USB and (2) Standard Plug-Ins. Available in All Black (B), All White (W) and Silver with White Outlets (S).	543 LIST/EACH

NOTE: Must choose placement in front panel: (4) Electrical on right as seated or (5) Electrical on left as seated

PRODUCT OPTIONS

MOISTURE BARRIER	\$22 List / Yard
FIRE WALL / CA T.B. 133	\$82 List / Yard
TAMPER-RESISTANT FASTENERS	\$51 List / Chair
PERMA-COAT WOOD LEG PROTECTOR	\$35 List / Leg
WEIGHTED / THEFT DETERRENT	\$305 List / 25 lb Weight \$610 List / 50 lb Weight



THE LOUNGE COLLECTION | RENDEZVOUS



CERTIFIED
CLEAN AIR GOLD

Healthier
Hospitals



COMPONENT-BASED
CONSTRUCTION

2K STATIC
CAPACITY





1K DROP
CAPACITY

RENDEZVOUS OTTOMANS

HARD MAPLE OR WHITE OAK LEGS

	MODEL	YARDS	COM	M	COL O	P	R	S	T	U	W/WL
SINGLE W: 26 D: 22 H: 19.5	 ROT1	3	959	1070	1205	1328	1460	1589	1721	1850	2045
DOUBLE W: 48 D: 22 H: 19.5	 ROT2	4	1327	1475	1655	1819	1995	2167	2343	2515	2775
BIG OTTO W: 36 D: 36 H: 19.5	 ROT3	4.5	1546	1713	1915	2100	2298	2491	2689	2883	3175

RENDEZVOUS OTTOMANS | LEG OPTIONS

	MODEL	DESCRIPTION	PRICE
3"H WOOD LEGS 	GGF4M	Hard Maple Legs	No Upcharge
3" HEAVY DUTY CASTERS 	43C	Set of 4 Locking Casters	108 LIST/SET OF 4
3"H BRUSHED ALUMINUM NAVE LEGS 	4NL		108 LIST/SET OF 4
2"H WOOD LEGS 	ROT4M	Hard Maple Legs	No Upcharge

NOTE: 2" High legs (the original leg & base) reduce the seat height and overall height by 1" on seating

PRODUCT OPTIONS

- MOISTURE BARRIER** \$22 List / Yard
- FIRE WALL / CA T.B. 133** \$82 List / Yard
- TAMPER-RESISTANT FASTENERS** \$51 List / Chair
- PERMA-COAT WOOD LEG PROTECTOR** \$35 List / Leg
- WEIGHTED / THEFT DETERRENT** \$305 List / 25 lb Weight

RENDEZVOUS BENCH

	MODEL	APRON	YARDS	COM	M	COL O	P	R	S	T	U	W/WL
HARD MAPLE BENCH W: 48 D: 22 H: 18.5	 RTBN	Straight	2	1270	1344	1434	1516	1604	1690	1778	1864	1994

PRODUCT OPTIONS

- MOISTURE BARRIER** \$22 List / Yard
- FIRE WALL / CA T.B. 133** \$82 List / Yard
- PERMA-COAT WOOD LEG PROTECTOR** \$35 List / Leg



RENDEZVOUS TABLES

HARD MAPLE OR WHITE OAK

22 SQUARE x 18H

W: 22
D: 22
H: 18

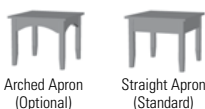

Arched Apron (Optional)
Straight Apron (Standard)
For Arched Apron, add **A** to end of model number.

MODEL	TOP MATERIAL OPTIONS	PRICE
RT222218	Solid Maple	869
RT-L-222218	Stocked Laminate over Solid Wood Edge	912
	Non-stocked Laminate (per color, per order)	ADD 50 NET

NOTE: Custom Wood Finish (CWF) is a one-time upcharge of 300 NET per color.

Add SOLID SURFACE ONLAY price to Solid Maple price above

SOLID SURFACE ONLAY UPCHARGE	A	B	C	D
Stocked	934 LIST	934 LIST	971 LIST	1074 LIST
Non-stocked (per color, per order)	ADD 410 NET	450 NET	490 NET	520 NET

NOTE: 1/2" Solid Surface Onlay will increase overall height by 1/2".

22 SQUARE x 22H

W: 22
D: 22
H: 22



MODEL	TOP MATERIAL OPTIONS	PRICE
RT222222	Solid Maple	901
RT-L-222222	Stocked Laminate over Solid Wood Edge	946
	Non-stocked Laminate (per color, per order)	ADD 50 NET

NOTE: Custom Wood Finish (CWF) is a one-time upcharge of 300 NET per color.

Add SOLID SURFACE ONLAY price to Solid Maple price above

SOLID SURFACE ONLAY UPCHARGE	A	B	C	D
Stocked	934 LIST	934 LIST	971 LIST	1074 LIST
Non-stocked (per color, per order)	ADD 410 NET	450 NET	490 NET	520 NET

NOTE: 1/2" Solid Surface Onlay will increase overall height by 1/2".

30 SQUARE x 18H

W: 30
D: 30
H: 18



MODEL	TOP MATERIAL OPTIONS	PRICE
RT303018	Solid Maple	1103
RT-L-303018	Stocked Laminate over Solid Wood Edge	1158
	Non-stocked Laminate (per color, per order)	ADD 50 NET

NOTE: Custom Wood Finish (CWF) is a one-time upcharge of 300 NET per color.

Add SOLID SURFACE ONLAY price to Solid Maple price above

SOLID SURFACE ONLAY UPCHARGE	A	B	C	D
Stocked	1616 LIST	1616 LIST	1806 LIST	1997 LIST
Non-stocked (per color, per order)	ADD 410 NET	450 NET	490 NET	520 NET

NOTE: 1/2" Solid Surface Onlay will increase overall height by 1/2".

30 SQUARE x 22H

W: 30
D: 30
H: 22



MODEL	TOP MATERIAL OPTIONS	PRICE
RT303022	Solid Maple	1135
RT-L-303022	Stocked Laminate over Solid Wood Edge	1192
	Non-stocked Laminate (per color, per order)	ADD 50 NET

NOTE: Custom Wood Finish (CWF) is a one-time upcharge of 300 NET per color.

Add SOLID SURFACE ONLAY price to Solid Maple price above

SOLID SURFACE ONLAY UPCHARGE	A	B	C	D
Stocked	1616 LIST	1616 LIST	1806 LIST	1997 LIST
Non-stocked (per color, per order)	ADD 410 NET	450 NET	490 NET	520 NET

NOTE: 1/2" Solid Surface Onlay will increase overall height by 1/2".



RENDEZVOUS TABLES

	MODEL	TOP MATERIAL OPTIONS	PRICE
COFFEE TABLE W: 48 D: 22 H: 18	RT482218	Solid Maple	1158
	RT-L-482218	Stocked Laminate over Solid Wood Edge	1216
		Non-stocked Laminate (per color, per order)	ADD 50 NET



NOTE: Custom Wood Finish (CWF) is a one-time upcharge of 300 NET per color.

Add SOLID SURFACE ONLAY price to Solid Maple price above

SOLID SURFACE ONLAY UPCHARGE	A	B	C	D
Stocked	1897 LIST	1897 LIST	2120 LIST	2345 LIST
Non-stocked (per color, per order)	ADD 410 NET	450 NET	490 NET	520 NET

NOTE: 1/2" Solid Surface Onlay will increase overall height by 1/2".

	MODEL	TOP MATERIAL OPTIONS	PRICE
CONSOLE TABLE W: 48 D: 16 H: 27	RT481627	Solid Maple	1109
	RT-L-481627	Stocked Laminate over Solid Wood Edge	1164
		Non-stocked Laminate (per color, per order)	ADD 50 NET



NOTE: Custom Wood Finish (CWF) is a one-time upcharge of 300 NET per color.

Add SOLID SURFACE ONLAY price to Solid Maple price above

SOLID SURFACE ONLAY UPCHARGE	A	B	C	D
Stocked	1378 LIST	1378 LIST	1541 LIST	1703 LIST
Non-stocked (per color, per order)	ADD 410 NET	450 NET	490 NET	520 NET

NOTE: 1/2" Solid Surface Onlay will increase overall height by 1/2".

RENDEZVOUS TABLES | OPTIONS

	MODEL	DESCRIPTION	PRICE
3/4" GLASS TOP	GLASS	3/4" Glass (set on top)	Contact Customer Service for Options and Pricing



PRODUCT OPTIONS

TAMPER-RESISTANT FASTENERS \$51 List / Chair
PERMA-COAT WOOD LEG PROTECTOR \$35 List / Leg



THE LOUNGE COLLECTION | RENDEZVOUS SQUARED



CERTIFIED
CLEAN AIR GOLD

Healthier
Hospitals





COMPONENT-BASED
CONSTRUCTION

2K STATIC
CAPACITY



1K DROP
CAPACITY

RENDEZVOUS SQUARED UPHOLSTERED ARM

STANDARD WITH SOLID WOOD LEGS

	MODEL	YARDS	COM	M	COL O	P	R	S	T	U	W/WL
CHAIR	RSU-1	5	1871	2056	2281	2486	2706	2921	3141	3356	3681
W: 33 D: 32 H: 33 SW: 21 SD: 20 SH: 19.5 BH: 16 AH: 24											
SETTEE	RSU-2	7.5	2778	3056	3393	3701	4031	4353	4683	5006	5493
W: 54 SW: 42											
SOFA	RSU-3	10	3682	4052	4502	4912	5352	5782	6222	6652	7302
W: 75 SW: 63											
HIGHER BACK - 18"H	HB										57 LIST/BACK
H: 35 SH: 18											

RENDEZVOUS SQUARED UPHOLSTERED ARM - OVERSIZE

	MODEL	YARDS	COM	M	COL O	P	R	S	T	U	W/WL
CHAIR	RSUO-1	6	2153	2375	2645	2891	3155	3413	3677	3935	4325
W: 38 D: 32 H: 35 SW: 26 SD: 20 SH: 19.5 BH: 18 AH: 24											
SETTEE	RSUO-2	9.5	3339	3691	4118	4508	4926	5334	5752	6161	6778
W: 64 SW: 52											
SOFA	RSUO-3	13	4522	5003	5588	6121	6693	7252	7824	8383	9228
W: 90 SW: 78											



RENDEZVOUS SQUARED | LEG OPTIONS

	MODEL	DESCRIPTION	PRICE
3"H WOOD LEGS	GGRS4	Specify Hard Maple or White Oak Legs	No Upcharge



	MODEL	DESCRIPTION	PRICE
3"H HIDE & GO MOBILITY	HGRS4	Wood legs with in-line casters in front and dome glides in back. Specify Wood finish.	64 LIST



NOTE: Recommended for use on Chairs only, not on Settees and Sofas.

	MODEL	DESCRIPTION	PRICE
3"H HEAVY DUTY CASTERS	43C	Set of 4 Locking Casters	108 LIST/SET OF 4



NOTE: Recommended for use on Chairs only, not on Settees and Sofas.

	MODEL	DESCRIPTION	PRICE
3"H BRUSHED ALUMINUM NAVE LEGS	4NL		108 LIST/SET OF 4



	MODEL	DESCRIPTION	PRICE
3"H BRUSHED ALUMINUM SLEEVES	QAS34	Slide over Solid Wood Legs	48 LIST/SET OF 4



	MODEL	DESCRIPTION	PRICE
2"H WOOD LEGS	Q4M	Specify Hard Maple or White Oak Legs	No Upcharge



NOTE: 2" High legs (the original leg & base) reduce the seat height and overall height by 1" on seating

	MODEL	DESCRIPTION	PRICE
2"H WOOD BASE	QMB	Base available in Hard Maple only	64 LIST/PAIR



NOTE: 2" High legs (the original leg & base) reduce the seat height and overall height by 1" on seating



RENDEZVOUS SQUARED | ARM CAP OPTIONS

1/2" THICK SOLID SURFACE ARM CAPS



MODEL	GRADE	A	B	C	D
ACQS	Stocked Solid Surface	454 LIST/PR	496 LIST/PR	554 LIST/PR	648 LIST/PR
	Non-stocked (per color, per order)	ADD 410 NET	450 NET	490 NET	520 NET

WOOD ARM CAPS

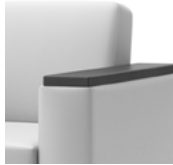

MODEL	DESCRIPTION	PRICE
ACQM	Hard Maple Arm Caps	372 LIST/PR

NOTE: Custom Wood Finish (CWF) is a one-time upcharge of 300 NET per color.

RENDEZVOUS SQUARED | TABLET OPTIONS

ALL INTEGRA TABLETS HAVE A 300LB CAPACITY



Tablets available in Upholstered Arms with and without Arm Caps.

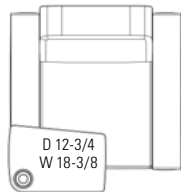
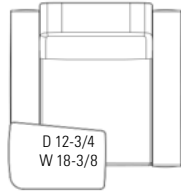

With Cup Holder Option

CHOOSE POSITION

(4)

(5)

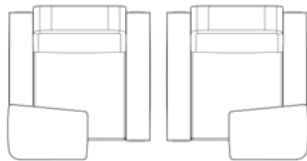

(4) - Tablet on right as seated

(5) - Tablet on left as seated

SOLID SURFACE TABLET OPTION

MODEL	GRADE	A	B	C	D
ST-(4/5)	Stocked	723 LIST	759 LIST	811 LIST	894 LIST
	Non-stocked (per color, per order)	ADD 410 NET	450 NET	490 NET	520 NET

LAMINATE OVER PLYWOOD CORE/EDGE TABLET OPTION

MODEL	GRADE	PRICE
LT-(4/5)	Stocked (Laminate tablets have a plywood edge. Specify finish.)	548 LIST
	Non-stocked (per color, per order)	ADD 50 NET

LAMINATE OVER PLYWOOD CORE/EDGE TABLET OPTION

MODEL	GRADE	PRICE
VT-(4/5)	Standard Wood Finish	548 LIST
	Custom Finish (one time charge per color)	ADD 300 NET

CUP HOLDER

MODEL	FINISH	PRICE
CUPIN	Brushed Aluminum	216 LIST



RENDEZVOUS SQUARED | OTHER OPTIONS

METAL SHELF



MODEL	FOR USE WITH	DESCRIPTION	PRICE
SHF21M	Rendezvous Squared Seating	Black Metal	514 LIST
SHF26M	Rendezvous Squared Oversize Seating	Black Metal	602 LIST

RECESSED PULL HANDLE



MODEL	DESCRIPTION	PRICE
RPH(B/G)	For use with mobile options. Specify Black (B) or Gray (G).	86 LIST

ELECTRICAL / POWER PORT



(B) ALL BLACK



(W) ALL WHITE



(S) SILVER WITH WHITE OUTLETS

MODEL	DESCRIPTION	PRICE
XE3(COLOR)(4/5)	(1) Dual USB and (2) Standard Plug-Ins. Available in All Black (B), All White (W) and Silver with White Outlets (S).	543 LIST/EACH

NOTE: Must choose placement in front panel: (4) Electrical on right as seated or (5) Electrical on left as seated

PRODUCT OPTIONS

MOISTURE BARRIER	\$22 List / Yard
FIRE WALL / CA T.B. 133	\$82 List / Yard
TAMPER-RESISTANT FASTENERS	\$51 List / Chair
PERMA-COAT WOOD LEG PROTECTOR	\$35 List / Leg
WEIGHTED / THEFT DETERRENT	\$305 List / 25 lb Weight \$610 List / 50 lb Weight



THE LOUNGE COLLECTION | RENDEZVOUS SQUARED





CERTIFIED CLEAN AIR GOLD





RENDEZVOUS SQUARED OTTOMANS

HARD MAPLE OR WHITE OAK LEGS

		MODEL	YARDS	COM	M	COL	P	R	S	T	U	W/WL
SINGLE		RSOT1	3	959	1070	1205	1328	1460	1589	1721	1850	2045
W: 26 D: 22 H: 19.5												
DOUBLE		RSOT2	4	1327	1475	1655	1819	1995	2167	2343	2515	2775
W: 48 D: 22 H: 19.5												
BIG OTTO		RSOT3	4.5	1546	1713	1915	2100	2298	2491	2689	2883	3175
W: 36 D: 36 H: 19.5												

RENDEZVOUS SQUARED OTTOMANS | LEG OPTIONS

	MODEL	DESCRIPTION	PRICE
3"H WOOD LEGS	GGRS4	Hard Maple Legs	No Upcharge
			

	MODEL	DESCRIPTION	PRICE
3" HEAVY DUTY CASTERS	43C	Set of 4 Locking Casters	106 LIST/SET OF 4
			

	MODEL	DESCRIPTION	PRICE
3"H BRUSHED ALUMINUM NAVE LEGS	4NL		106 LIST/SET OF 4
			

	MODEL	DESCRIPTION	PRICE
3"H BRUSHED ALUMINUM SLEEVES	QAS34		48 LIST/SET OF 4
			

	MODEL	DESCRIPTION	PRICE
2"H WOOD LEGS	Q4M	Hard Maple Legs	No Upcharge
			

NOTE: 2" High legs (the original leg & base) reduce the seat height and overall height by 1" on seating

PRODUCT OPTIONS

- MOISTURE BARRIER** \$22 List / Yard
- FIRE WALL / CA T.B. 133** \$82 List / Yard
- TAMPER-RESISTANT FASTENERS** \$51 List / Chair
- PERMA-COAT WOOD LEG PROTECTOR** \$35 List / Leg
- WEIGHTED / THEFT DETERRENT** \$305 List / 25 lb Weight

RENDEZVOUS SQUARED TABLES

NOTE: See Rendezvous Tables section on page TLC-15.



THE LOUNGE COLLECTION | SOIRÉE



CERTIFIED
CLEAN AIR GOLD





COMPONENT-BASED
CONSTRUCTION

2K STATIC
CAPACITY



1K DROP
CAPACITY

SOIRÉE UPHOLSTERED ROLLED ARM

STANDARD WITH SOLID WOOD LEGS

	MODEL	YARDS	COM	M	COL O	P	R	S	T	U	W/WL
CHAIR W: 39.5 D: 32 H: 33.5 SW: 21 SD: 20 SH: 18.5 BH: 18 AH: 24	 REE-1	6	2376	2598	2868	3114	3378	3636	3900	4158	4548
SETTEE W: 60.5 SW: 42	 REE-2	9.25	3410	3752	4169	4548	4955	5353	5760	6157	6759
SOFA W: 81.5 SW: 63	 REE-3	12.5	4453	4916	5478	5991	6541	7078	7628	8166	8978

SOIRÉE UPHOLSTERED ROLLED ARM - OVERSIZE

	MODEL	YARDS	COM	M	COL O	P	R	S	T	U	W/WL
CHAIR W: 44.5 D: 32 H: 33.5 SW: 26 SD: 20 SH: 18.5 BH: 18 AH: 24	 REEO-1	6.75	2679	2929	3233	3509	3806	4097	4394	4684	5123
SETTEE W: 70.5 SW: 52	 REEO-2	10.75	4056	4454	4938	5378	5851	6314	6787	7249	7948
SOFA W: 96.5 SW: 78	 REEO-3	14.75	5433	5979	6643	7247	7896	8531	9180	9814	10773



SOIRÉE | LEG OPTIONS

WOOD LEGS



MODEL	DESCRIPTION	PRICE
GGF4	Specify Wood Finish on Hard Maple	No Upcharge

3"H HIDE & GO MOBILITY



MODEL	DESCRIPTION	PRICE
HGF4	Wood legs with in-line casters in front and dome glides in back. Specify Wood finish.	64 LIST

NOTE: Recommended for use on Chairs only, not on Settees and Sofas.

3" HEAVY DUTY CASTERS



MODEL	DESCRIPTION	PRICE
43C	Set of 4 Locking Casters	108 LIST/SET OF 4

NOTE: Recommended for use on Chairs only, not on Settees and Sofas.

3"H BRUSHED ALUMINUM NAVE LEGS



MODEL	PRICE
4NL	108 LIST/SET OF 4

SOIRÉE | TABLET OPTIONS

ALL INTEGRA TABLETS HAVE A 300LB CAPACITY

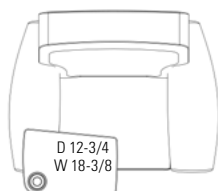
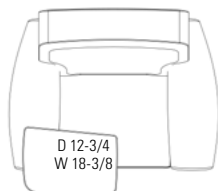

With Cup Holder Option

CHOOSE POSITION

(4)



(5)



(4) - Tablet on right as seated

(5) - Tablet on left as seated

SOLID SURFACE TABLET OPTION

MODEL	GRADE	A	B	C	D
ST-(4/5)	Stocked	723 LIST	759 LIST	811 LIST	894 LIST
	Non-stocked (per color, per order)	ADD 410 NET	450 NET	490 NET	520 NET

LAMINATE OVER PLYWOOD CORE/EDGE TABLET OPTION

MODEL	GRADE	PRICE
LT-(4/5)	Stocked (Laminate tablets have a plywood edge. Specify finish.)	548 LIST
	Non-stocked (per color, per order)	ADD 50 NET

LAMINATE OVER PLYWOOD CORE/EDGE TABLET OPTION

MODEL	GRADE	PRICE
VT-(4/5)	Standard Wood Finish	548 LIST
	Custom Finish (one time charge per color)	ADD 300 NET

CUP HOLDER

MODEL	FINISH	PRICE
CUPIN	Brushed Aluminum	216 LIST



SOIRÉE | OTHER OPTIONS

	MODEL	FOR USE WITH	DESCRIPTION	PRICE
METAL SHELF	SHF21M	Soirée Seating	Black Metal	514 LIST
	SHF26M	Soirée Oversize Seating	Black Metal	602 LIST

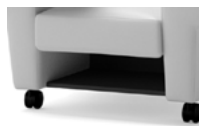

	MODEL	DESCRIPTION	PRICE
RECESSED PULL HANDLE	RPH(B/G)	For use with mobile options. Specify Black (B) or Gray (G).	86 LIST



	MODEL	DESCRIPTION	PRICE
ELECTRICAL / POWER PORT	XE3(COLOR)(4/5)	(1) Dual USB and (2) Standard Plug-Ins. Available in All Black (B), All White (W) and Silver with White Outlets (S).	543 LIST/EACH



(B) ALL BLACK



(W) ALL WHITE



(S) SILVER WITH WHITE OUTLETS



NOTE: Must choose placement in front panel: (4) Electrical on right as seated or (5) Electrical on left as seated

PRODUCT OPTIONS



- MOISTURE BARRIER** \$22 List / Yard
- FIRE WALL / CA T.B. 133** \$82 List / Yard
- TAMPER-RESISTANT FASTENERS** \$51 List / Chair
- PERMA-COAT WOOD LEG PROTECTOR** \$35 List / Leg
- WEIGHTED / THEFT DETERRENT** \$610 List / 50 lb Weight



FLAIR AND SOIRÉE OTTOMANS

		MODEL	YARDS	COM	M	COL						W / WL
						O	P	R	S	T	U	
SINGLE		SOT1	3	959	1070	1205	1328	1460	1589	1721	1850	2045
W: 26 D: 22 H: 18.5												
DOUBLE		SOT2	4	1327	1475	1655	1819	1995	2167	2343	2515	2775
W: 48 D: 22 H: 18.5												
BIG OTTO		SOT3	4.5	1546	1713	1915	2100	2298	2491	2689	2883	3175
W: 36 D: 36 H: 18.5												

FLAIR AND SOIRÉE OTTOMANS | LEG OPTIONS

	MODEL	DESCRIPTION	PRICE
WOOD LEGS		GGF4 Specify Wood Finish on Hard Maple	No Upcharge
3" HEAVY DUTY CASTERS		43C Set of 4 Locking Casters	108 LIST/SET OF 4
3"H BRUSHED ALUMINUM NAVE LEGS		4NL	108 LIST/SET OF 4

PRODUCT OPTIONS

- MOISTURE BARRIER** \$22 List / Yard
- FIRE WALL / CA T.B. 133** \$82 List / Yard
- TAMPER-RESISTANT FASTENERS** \$51 List / Chair
- PERMA-COAT WOOD LEG PROTECTOR** \$35 List / Leg
- WEIGHTED / THEFT DETERRENT** \$305 List / 25 lb Weight



TRIA COLLECTION

TRIA UPHOLSTERED ARM WITH STRAIGHT BACK	TC 2 - 4
TRIA SQUARE ARM WITH STRAIGHT BACK	TC 5 - 7
TRIA OTTOMANS	TC 8
TRIA SYSTEMS	TC 9 - 11
TRIA TABLES	TC 12 - 14



TRIA COLLECTION | TRIA



CERTIFIED
CLEAN AIR GOLD

Healthier
Hospitals

COMPONENT-BASED
CONSTRUCTION



2K STATIC
CAPACITY

1K DROP
CAPACITY

TRIA UPHOLSTERED ARM WITH STRAIGHT BACK

CLEAN-OUT SEAT DESIGN

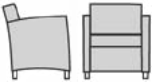
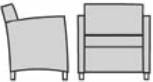

WEAR POINT SEAT ROTATION

	MODEL	ARM OPTION	YARDS	COM	M	COL	O	P	R	S	T	U	W/WL
CHAIR		TU-1-(C/D)	No Arm Caps	5	2118	2303	2528	2733	2953	3168	3388	3603	3928
W: 29 D: 28.5 H: 31/33 SW: 21 SD: 19.5 SH: 19 BH: 14/16 AH: 25.25 CHOOSE BACK HEIGHT: 14 (C) OR 16 (D)													
OVERSIZED CHAIR		TUO-1-(C/D)	No Arm Caps	5.25	2245	2439	2676	2891	3122	3348	3579	3804	4146
W: 32 SW: 24													
SETTEE		TU-2-(C/D)	No Arm Caps	7.5	3201	3479	3816	4124	4454	4776	5106	5429	5916
W: 50 SW: 42													
SOFA		TU-3-(C/D)	No Arm Caps	10	4274	4644	5094	5504	5944	6374	6814	7244	7894
W: 71 SW: 63													

NOTE: Back Height must be specified: (C) 14" High Back or (D) 16" High Back

WHEN SPECIFYING THE ARM CAP OPTION, MODEL # WILL CHANGE TO TK-X-(C/D)

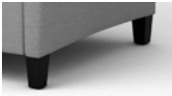
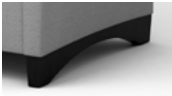
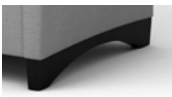
TRIA UPHOLSTERED ARM | LEG OPTIONS

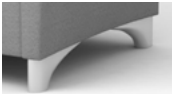
	MODEL	DESCRIPTION	PRICE	
WOOD LEGS		T4M	Hard Maple Legs	No Upcharge
WOOD BASE		TMB	Hard Maple	No Upcharge
HIDE & GO MOBILITY IN WOOD BASE		HGTB2	Wood base with in-line casters in front and dome glides in back. Specify Wood finish.	164 LIST
				NOTE: Recommended for use on Chairs only, not on Settees and Sofas
3" HEAVY DUTY CASTERS		43C	Set of 4 Locking Casters	140 LIST/SET OF 4
				NOTE: Recommended for use on Chairs only, not on Settees and Sofas
BRUSHED ALUMINUM NAVE LEGS		4NL		140 LIST/SET OF 4



TRIA UPHOLSTERED ARM | ARM CAP OPTIONS

WHEN SPECIFYING THE ARM CAP OPTION, MODEL # WILL CHANGE TO TK-X-(C/D)

SOLID SURFACE ARM CAPS



MODEL	GRADE	A	B	C	D
ACTRS	Stocked Solid Surface	424 LIST/PR	452 LIST/PR	492 LIST/PR	560 LIST/PR
	Non-stocked (per color, per order)	ADD 410 NET	450 NET	490 NET	520 NET

NOTE: No overhang on Tria Solid Surface Arm Caps.

WOOD ARM CAPS

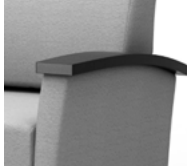

MODEL	DESCRIPTION	PRICE
ACTM	Solid Wood. Specify finish.	304 LIST/PR

NOTE: Custom Wood Finish (CWF) is a one-time upcharge of 300 NET per color.

TRIA UPHOLSTERED ARM | TABLET OPTIONS

ALL INTEGRA TABLETS HAVE A 300LB CAPACITY



Tablets available in Upholstered Arms with and without Arm Caps.

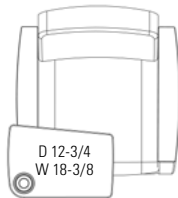
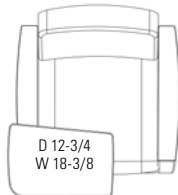

With Cup Holder Option

CHOOSE POSITION

(4)



(4) - Tablet on right as seated

(5)



(5) - Tablet on left as seated

SOLID SURFACE TABLET OPTION

MODEL	GRADE	A	B	C	D
ST-(4/5)	Stocked	723 LIST	759 LIST	811 LIST	894 LIST
	Non-stocked (per color, per order)	ADD 410 NET	450 NET	490 NET	520 NET

LAMINATE OVER PLYWOOD CORE/EDGE TABLET OPTION

MODEL	GRADE	PRICE
LT-(4/5)	Stocked (Laminate tablets have a plywood edge. Specify finish.)	548 LIST
	Non-stocked (per color, per order)	ADD 50 NET

VENEER OVER PLYWOOD CORE/EDGE TABLET OPTION

MODEL	GRADE	PRICE
VT-(4/5)	Standard Wood Finish	548 LIST
	Custom Finish (one time charge per color)	ADD 300 NET

CUP HOLDER

MODEL	FINISH	PRICE
CUPIN	Brushed Aluminum	216 LIST



TRIA UPHOLSTERED ARM | OTHER OPTIONS

	MODEL	DESCRIPTION	PRICE
METAL SHELF	SHF21M	Black Metal	514 LIST



	MODEL	DESCRIPTION	PRICE
RECESSED PULL HANDLE	RPH(B/G)	For use with mobile options. Specify Black (B) or Gray (G).	86 LIST

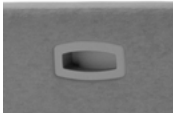

	MODEL	DESCRIPTION	PRICE
ELECTRICAL / POWER PORT	XE3(COLOR)(4/5)	(1) Dual USB and (2) Standard Plug-Ins. Available in All Black (B), All White (W) and Silver with White Outlets (S).	543 LIST/EACH



(B) ALL BLACK



(W) ALL WHITE



(S) SILVER WITH WHITE OUTLETS

NOTE: Must choose placement in front panel: (4) Electrical on right as seated or (5) Electrical on left as seated

PRODUCT OPTIONS

- MOISTURE BARRIER** \$22 List / Yard
- FIRE WALL / CA T.B. 133** \$82 List / Yard
- TAMPER-RESISTANT FASTENERS** \$51 List / Chair
- PERMA-COAT WOOD LEG PROTECTOR** \$35 List / Leg
- WEIGHTED / THEFT DETERRENT** \$610 List / 50 lb Weight



TRIA COLLECTION | TRIA







CERTIFIED CLEAN AIR GOLD



TRIA SQUARE ARM WITH STRAIGHT BACK

CLEAN-OUT SEAT DESIGN







WEAR POINT SEAT ROTATION

	MODEL	YARDS	COM	M	COL	P	R	S	T	U	W/WL
CHAIR W: 29 D: 28.5 H: 31/33 SW: 21 SD: 19.5 SH: 19 BH: 14/16 AH: 25 CHOOSE BACK HEIGHT: 14 (C) OR 16 (D)	 TQU-1-(C/D)	5	2060	2245	2470	2675	2895	3110	3330	3545	3870
OVERSIZED CHAIR W: 32 SW: 24	 TQUO-1-(C/D)	5.25	2187	2381	2618	2833	3064	3290	3521	3746	4088
SETTEE W: 50 SW: 42	 TQU-2-(C/D)	7.5	3143	3421	3758	4066	4396	4718	5048	5371	5858
SOFA W: 71 SW: 63	 TQU-3-(C/D)	10	4216	4586	5036	5446	5886	6316	6756	7186	7836

NOTE: Back Height must be specified: (C) 14" High Back or (D) 16" High Back

WHEN SPECIFYING THE ARM CAP OPTION, MODEL # WILL CHANGE TO TQK-X-(C/D)

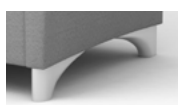
TRIA SQUARE ARM | LEG OPTIONS

	MODEL	DESCRIPTION	PRICE
TRIANGULAR WOOD LEGS 	EL4M	Hard Maple	No Upcharge
SQUARE WOOD LEGS 	GGRS4	Hard Maple	No Upcharge
HIDE & GO MOBILITY 	HGRS4	Wood legs with in-line casters in front and dome glides in back. Specify Wood finish.	64 LIST
		NOTE: Recommended for use on Chairs only, not on Settees and Sofas	
3" HEAVY DUTY CASTERS 	43C	Set of 4 Locking Casters	108 LIST/SET OF 4
		NOTE: Recommended for use on Chairs only, not on Settees and Sofas	
BRUSHED ALUMINUM NAVE LEGS 	4NL		108 LIST/SET OF 4
BAR LEGS 	EL4S	Solid Steel Legs with Brushed Chrome finish	128 LIST/SET OF 4



TRIA SQUARE ARM | ARM CAP OPTIONS

WHEN SPECIFYING THE ARM CAP OPTION, MODEL # WILL CHANGE TO TQK-X-(C/D)

SOLID SURFACE ARM CAPS



MODEL	GRADE	A	B	C	D
ACTQS	Stocked Solid Surface	382 LIST/PR	404 LIST/PR	440 LIST/PR	498 LIST/PR
	Non-stocked (per color, per order)	ADD 410 NET	450 NET	490 NET	520 NET

NOTE: Arm Caps are contoured; they are not flat.

WOOD ARM CAPS

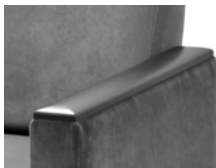

MODEL	DESCRIPTION	PRICE
ACTQM	Solid Hard Maple. Specify finish.	398 LIST/PR

NOTE: Arm Caps are contoured; they are not flat.

Custom Wood Finish (CWF) is a one-time upcharge of 300 NET per color.

TRIA SQUARE ARM | TABLET OPTIONS

ALL INTEGRA TABLETS HAVE A 300LB CAPACITY



Tablets available in Upholstered Arms with and without Arm Caps.

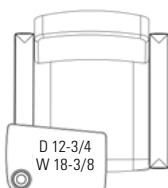
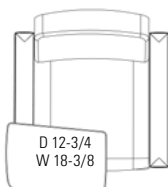

With Cup Holder Option

CHOOSE POSITION

(4)

(5)

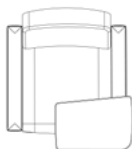
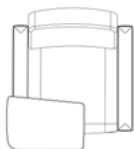

(4) - Tablet on right as seated

(5) - Tablet on left as seated

SOLID SURFACE TABLET OPTION

MODEL	GRADE	A	B	C	D
ST-(4/5)	Stocked	723 LIST	759 LIST	811 LIST	894 LIST
	Non-stocked (per color, per order)	ADD 410 NET	450 NET	490 NET	520 NET

LAMINATE OVER PLYWOOD CORE/EDGE TABLET OPTION

MODEL	GRADE	PRICE
LT-(4/5)	Stocked (Laminate tablets have a plywood edge. Specify finish.)	548 LIST
	Non-stocked (per color, per order)	ADD 50 NET

VENEER OVER PLYWOOD CORE/EDGE TABLET OPTION

MODEL	GRADE	PRICE
VT-(4/5)	Standard Wood Finish	548 LIST
	Custom Finish (one time charge per color)	ADD 300 NET

CUP HOLDER

MODEL	FINISH	PRICE
CUPIN	Brushed Aluminum	216 LIST



TRIA SQUARE ARM | OTHER OPTIONS

	MODEL	DESCRIPTION	PRICE
METAL SHELF	SHF21M	Black Metal	514 LIST



	MODEL	DESCRIPTION	PRICE
RECESSED PULL HANDLE	RPH(B/G)	For use with mobile options. Specify Black (B) or Gray (G).	86 LIST

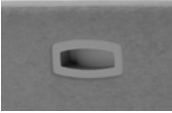

	MODEL	DESCRIPTION	PRICE
ELECTRICAL / POWER PORT	XE3(COLOR)(4/5)	(1) Dual USB and (2) Standard Plug-Ins. Available in All Black (B), All White (W) and Silver with White Outlets (S).	543 LIST/EACH



(B) ALL BLACK



(W) ALL WHITE



(S) SILVER WITH WHITE OUTLETS

NOTE: Must choose placement in front panel: (4) Electrical on right as seated or (5) Electrical on left as seated

PRODUCT OPTIONS

- MOISTURE BARRIER** \$22 List / Yard
- FIRE WALL / CA T.B. 133** \$82 List / Yard
- TAMPER-RESISTANT FASTENERS** \$51 List / Chair
- PERMA-COAT WOOD LEG PROTECTOR** \$35 List / Leg
- WEIGHTED / THEFT DETERRENT** \$610 List / 50 lb Weight





TRIA COLLECTION | TRIA



CERTIFIED
CLEAN AIR GOLD



TRIA OTTOMANS

		MODEL	YARDS	COM	M	COL O	P	R	S	T	U	W/WL
SINGLE		TOT1	2	940	1014	1104	1186	1274	1360	1448	1534	1664
W: 20 D: 20 H: 18												
DOUBLE		TOT2	3.5	1410	1540	1697	1841	1995	2145	2299	2450	2677
W: 40 D: 20 H: 18												

TRIA OTTOMANS | LEG OPTIONS

	MODEL	DESCRIPTION	PRICE
WOOD LEGS	3TRT4	Hard Maple Legs	No Upcharge

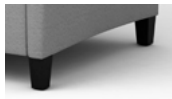

	MODEL	DESCRIPTION	PRICE
3" HEAVY DUTY CASTERS	43C	Set of 4 Locking Casters	168 LIST/SET OF 4



	MODEL	DESCRIPTION	PRICE
BRUSHED ALUMINUM NAVE LEGS	4NL		168 LIST/SET OF 4

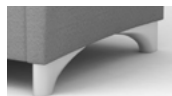

PRODUCT OPTIONS

- MOISTURE BARRIER** \$22 List / Yard
- FIRE WALL / CA T.B. 133** \$82 List / Yard
- TAMPER-RESISTANT FASTENERS** \$51 List / Chair
- PERMA-COAT WOOD LEG PROTECTOR** \$35 List / Leg
- WEIGHTED / THEFT DETERRENT** \$305 List / 25 lb Weight





TRIA WOOD CAP AND UPHOLSTERED ARM SYSTEMS

CLEAN-OUT SEAT DESIGN

	MODEL	YARDS	COM	M	COL							
					O	P	R	S	T	U	W/WL	
UPHOLSTERED ARM												
W: 4 D: 25 H: 25.25		TU-0-(L)										
SW: 4		AL or AR	1.25	523	569	626	677	732	786	841	894	976
		SS	1.25	629	675	732	783	838	892	947	1000	1082
WOOD CAP ARM												
W: 4.5 D: 25 H: 25.25		TK-0-(L)										
SW: 4.5		AL or AR	1	675	721	778	829	884	938	993	1046	1128
		SS	1	781	827	884	935	990	1044	1099	1152	1234
SYSTEM SEATS WITH STRAIGHT BACK												
SINGLE SEAT												
W: 21 SD: 19.5 SH: 19		1(C/D)S	2.5	1072	1165	1277	1380	1490	1597	1707	1815	1977
SW: 21												
BH: 14/16												
CHOOSE BACK HEIGHT: 14 (C) OR 16 (D)												
DOUBLE SEAT												
		2(C/D)S	5	2155	2340	2565	2770	2990	3205	3425	3640	3965
TRIPLE SEAT												
		3(C/D)S	7.5	3228	3506	3843	4151	4481	4803	5133	5456	5943
NOTE: Back Height must be specified: (C) 14" High Back or (D) 16" High Back												

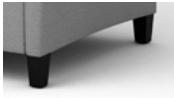

TRIA SYSTEM SEATING | LEG OPTIONS

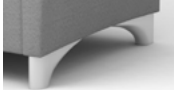
	MODEL	DESCRIPTION	PRICE
WOOD LEGS	T2M	Hard Maple Legs	No Upcharge
			
WOOD BASE	TMB1	Hard Maple	No Upcharge
			
BRUSHED ALUMINUM NAVE LEGS	2NL		70 LIST/SET OF 2
			

TRIA SYSTEM SEATING | OTHER OPTIONS

	MODEL	DESCRIPTION	PRICE
ELECTRICAL / POWER PORT	XE3(COLOR)(4/5)	(1) Dual USB and (2) Standard Plug-Ins. Available in All Black (B), All White (W) and Silver with White Outlets (S).	543 LIST/EACH



(B) ALL BLACK



(W) ALL WHITE



(S) SILVER WITH WHITE OUTLETS

NOTE: Must choose placement in front panel: (4) Electrical on right as seated or (5) Electrical on left as seated

PRODUCT OPTIONS

MOISTURE BARRIER \$22 List / Yard
FIRE WALL / CA T.B. 133 \$82 List / Yard
TAMPER-RESISTANT FASTENERS \$51 List / Chair
PERMA-COAT WOOD LEG PROTECTOR \$35 List / Leg
WEIGHTED / THEFT DETERRENT \$610 List / 50 lb Weight



TRIA FREESTANDING OR SYSTEM TABLES

	MODEL	TOP	PRICE
HALF TABLE W: 10.5 D: 32 H: 16		THT-F	Hard Maple Veneer 2269
		THT-F-L	Stocked Laminate 2382
		Non-stocked Laminate (per color, per order)	ADD 50 NET

	MODEL	TOP	PRICE
FULL TABLE W: 21 D: 34 H: 18		TFT-F	Hard Maple Veneer 2731
		TFT-F-L	Stocked Laminate 2866
		Non-stocked Laminate (per color, per order)	ADD 50 NET

	MODEL	TOP	PRICE
CORNER TABLE W: 32 D: 32 H: 18		TCT-F	Hard Maple Veneer 4050
		TCT-F-L	Stocked Laminate 4250
		Non-stocked Laminate (per color, per order)	ADD 50 NET

NOTE: Custom Wood Finish (CWF) is a one-time upcharge of 300 NET per color.
A self-edge will be used for THT, TFT and TCT tables with laminate or glass tops.

TRIA FREESTANDING OR SYSTEM TABLES | OPTIONS

	MODEL	DESCRIPTION	PRICE
ELECTRICAL / POWER PORT	XE3(COLOR)	(1) Dual USB and (2) Standard Plug-Ins. Available in All Black (B), All White (W) and Silver with White Outlets (S).	543 LIST/EACH

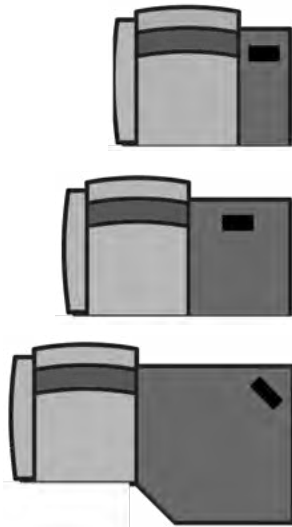

(B) ALL BLACK



(W) ALL WHITE



(S) SILVER WITH WHITE OUTLETS

	MODEL	DESCRIPTION	PRICE
3/4" GLASS TOP	GLASS	3/4" Glass (set on top)	Contact Customer Service for Options and Pricing



PRODUCT OPTIONS

PERMA-COAT WOOD LEG PROTECTOR \$35 List / Leg



TRIA TABLES

HARD MAPLE OR LAMINATE TOPS WITH SOLID WOOD OR METAL LEGS

15 ROUND x 22H

DIA: 15 H: 22



MODEL	TOP	WOOD LEGS (WL)	BRUSHED CHROME LEGS (BC)	BLACK METAL LEGS (BM)
TT-F-400-22(_)	Hard Maple Veneer	1812	2156	2156
TT-F-400L-22(_)	Stocked Laminate	2203	2547	2547
	Non-stocked Laminate (per color, per order) ADD	50 NET	50 NET	50 NET

NOTE: Custom Wood Finish (CWF) is a one-time upcharge of 300 NET per color.

Add SOLID SURFACE ONLAY price to Solid Maple price above

SOLID SURFACE ONLAY UPCHARGE	A	B	C	D
Stocked	404 LIST	404 LIST	453 LIST	500 LIST
Non-stocked (per color, per order) ADD	410 NET	450 NET	490 NET	520 NET

NOTE: 1/2" Solid Surface Onlay will increase overall height by 1/2".

24 ROUND x 22H

DIA: 24 H: 22



MODEL	TOP	WOOD LEGS (WL)	BRUSHED CHROME LEGS (BC)	BLACK METAL LEGS (BM)
TT-F-405-22(_)	Hard Maple Veneer	2219	2563	2563
TT-F-405L-22(_)	Stocked Laminate	2474	2818	2818
	Non-stocked Laminate (per color, per order) ADD	50 NET	50 NET	50 NET

NOTE: Custom Wood Finish (CWF) is a one-time upcharge of 300 NET per color.

Add SOLID SURFACE ONLAY price to Solid Maple price above

SOLID SURFACE ONLAY UPCHARGE	A	B	C	D
Stocked	1034 LIST	1034 LIST	1156 LIST	1277 LIST
Non-stocked (per color, per order) ADD	410 NET	450 NET	490 NET	520 NET

NOTE: 1/2" Solid Surface Onlay will increase overall height by 1/2".

30 ROUND x 16H

DIA: 30 H: 16



MODEL	TOP	WOOD LEGS (WL)	BRUSHED CHROME LEGS (BC)	BLACK METAL LEGS (BM)
TT-F-420-16(_)	Hard Maple Veneer	2291	2603	2603
TT-F-420L-16(_)	Stocked Laminate	2466	2778	2778
	Non-stocked Laminate (per color, per order) ADD	50 NET	50 NET	50 NET

NOTE: Custom Wood Finish (CWF) is a one-time upcharge of 300 NET per color.

Add SOLID SURFACE ONLAY price to Solid Maple price above

SOLID SURFACE ONLAY UPCHARGE	A	B	C	D
Stocked	1616 LIST	1616 LIST	1806 LIST	1997 LIST
Non-stocked (per color, per order) ADD	410 NET	450 NET	490 NET	520 NET

NOTE: 1/2" Solid Surface Onlay will increase overall height by 1/2".

30 ROUND x 22H

DIA: 30 H: 22



MODEL	TOP	WOOD LEGS (WL)	BRUSHED CHROME LEGS (BC)	BLACK METAL LEGS (BM)
TT-F-420-22(_)	Hard Maple Veneer	2319	2663	2663
TT-F-420L-22(_)	Stocked Laminate	2494	2838	2838
	Non-stocked Laminate (per color, per order) ADD	50 NET	50 NET	50 NET

NOTE: Custom Wood Finish (CWF) is a one-time upcharge of 300 NET per color.

Add SOLID SURFACE ONLAY price to Solid Maple price above

SOLID SURFACE ONLAY UPCHARGE	A	B	C	D
Stocked	1616 LIST	1616 LIST	1806 LIST	1997 LIST
Non-stocked (per color, per order) ADD	410 NET	450 NET	490 NET	520 NET

NOTE: 1/2" Solid Surface Onlay will increase overall height by 1/2".



TRIA TABLES

36 ROUND x 16H

DIA: 36 H: 16



MODEL	TOP	WOOD LEGS (WL)	BRUSHED CHROME LEGS (BC)	BLACK METAL LEGS (BM)
TT-F-425-16(_)	Hard Maple Veneer	2740	3052	3052
TT-F-425L-16(_)	Stocked Laminate	2940	3252	3252
	Non-stocked Laminate (per color, per order) ADD	50 NET	50 NET	50 NET

NOTE: Custom Wood Finish (CWF) is a one-time upcharge of 300 NET per color.

Add SOLID SURFACE ONLAY price to Solid Maple price above

SOLID SURFACE ONLAY UPCHARGE	A	B	C	D
Stocked	2328 LIST	2328 LIST	2601 LIST	2875 LIST
Non-stocked (per color, per order) ADD	410 NET	450 NET	490 NET	520 NET

NOTE: 1/2" Solid Surface Onlay will increase overall height by 1/2".

36 ROUND x 22H

DIA: 36 H: 22



MODEL	TOP	WOOD LEGS (WL)	BRUSHED CHROME LEGS (BC)	BLACK METAL LEGS (BM)
TT-F-425-22(_)	Hard Maple Veneer	2768	3112	3112
TT-F-425L-22(_)	Stocked Laminate	2968	3312	3312
	Non-stocked Laminate (per color, per order) ADD	50 NET	50 NET	50 NET

NOTE: Custom Wood Finish (CWF) is a one-time upcharge of 300 NET per color.

Add SOLID SURFACE ONLAY price to Solid Maple price above

SOLID SURFACE ONLAY UPCHARGE	A	B	C	D
Stocked	2328 LIST	2328 LIST	2601 LIST	2875 LIST
Non-stocked (per color, per order) ADD	410 NET	450 NET	490 NET	520 NET

NOTE: 1/2" Solid Surface Onlay will increase overall height by 1/2".

48 OVAL x 16H

W: 48 D: 22

H: 16



MODEL	TOP	WOOD LEGS (WL)	BRUSHED CHROME LEGS (BC)	BLACK METAL LEGS (BM)
TT-F-410-16(_)	Hard Maple Veneer	2532	2844	2844
TT-F-410L-16(_)	Stocked Laminate	2702	3014	3014
	Non-stocked Laminate (per color, per order) ADD	50 NET	50 NET	50 NET

NOTE: Custom Wood Finish (CWF) is a one-time upcharge of 300 NET per color.

Add SOLID SURFACE ONLAY price to Solid Maple price above

SOLID SURFACE ONLAY UPCHARGE	A	B	C	D
Stocked	1897 LIST	1897 LIST	2120 LIST	2345 LIST
Non-stocked (per color, per order) ADD	410 NET	450 NET	490 NET	520 NET

NOTE: 1/2" Solid Surface Onlay will increase overall height by 1/2".

54 HALF OVAL x 27H

W: 53.5 D: 14

H: 27



MODEL	TOP	WOOD LEGS (WL)	BRUSHED CHROME LEGS (BC)	BLACK METAL LEGS (BM)
TT-F-430-27(_)	Hard Maple Veneer	2794	3290	3290
TT-F-430L-27(_)	Stocked Laminate	2983	3479	3479
	Non-stocked Laminate (per color, per order) ADD	50 NET	50 NET	50 NET

NOTE: Custom Wood Finish (CWF) is a one-time upcharge of 300 NET per color.

Add SOLID SURFACE ONLAY price to Solid Maple price above

SOLID SURFACE ONLAY UPCHARGE	A	B	C	D
Stocked	1359 LIST	1359 LIST	1518 LIST	1677 LIST
Non-stocked (per color, per order) ADD	410 NET	450 NET	490 NET	520 NET

NOTE: 1/2" Solid Surface Onlay will increase overall height by 1/2".



3/4" GLASS TOP



MODEL	DESCRIPTION	PRICE
GLASS	3/4" Glass (set on top)	Contact Customer Service for Options and Pricing

PRODUCT OPTIONS

PERMA-COAT WOOD LEG PROTECTOR \$35 List / Leg

VALAYO COLLECTION

VALAYO CHAIRS	VC 2
VALAYO UPHOLSTERED TOP BENCHES	VC 3
VALAYO HARD TOP BENCHES AND TABLES	VC 4



VALAYO COLLECTION | CHAIRS





CERTIFIED
CLEAN AIR GOLD





VALAYO CHAIRS

SOLID STEEL WITH POWDER COAT (PC) OR BRUSHED CHROME (BC)

	MODEL	YARDS	COM	M	COL							
					O	P	R	S	T	U	W/WL	
CHAIR - 26" W: 26 D: 27.5 H: 34 SW: 22 SD: 18.5 SH: 18.5 BH: 17.5 AH: 26 	VL-1-26 PC	2.75	1847	1949	2073	2185	2306	2425	2546	2664	2843	
	VL-1-26 BC	2.75	1847	1949	2073	2185	2306	2425	2546	2664	2843	
CHAIR - 32" W: 32 SW: 28 	VL-1-32 PC	2.75	1953	2055	2179	2291	2412	2531	2652	2770	2949	
	VL-1-32 BC	2.75	1953	2055	2179	2291	2412	2531	2652	2770	2949	
CHAIR - 46" W: 46 SW: 42 	VL-1-46 PC	3.5	2375	2505	2662	2806	2960	3110	3264	3415	3642	
	VL-1-46 BC	3.5	2375	2505	2662	2806	2960	3110	3264	3415	3642	

VALAYO CHAIRS ARMLESS

	MODEL	YARDS	COM	M	COL							
					O	P	R	S	T	U	W/WL	
CHAIR - 26" W: 26 D: 27.5 H: 34 SW: 26 SD: 18.5 SH: 18.5 BH: 17.5 	VLA-1-26 PC	2.75	1793	1895	2019	2131	2252	2371	2492	2610	2789	
	VLA-1-26 BC	2.75	1793	1895	2019	2131	2252	2371	2492	2610	2789	
CHAIR - 32" W: 32 SW: 32 	VLA-1-32 PC	2.75	1899	2001	2125	2237	2358	2477	2598	2716	2895	
	VLA-1-32 BC	2.75	1899	2001	2125	2237	2358	2477	2598	2716	2895	
CHAIR - 46" W: 46 SW: 46 	VLA-1-46 PC	3.5	2321	2451	2608	2752	2906	3056	3210	3361	3588	
	VLA-1-46 BC	3.5	2321	2451	2608	2752	2906	3056	3210	3361	3588	

VALAYO CHAIRS | ARM CAP OPTIONS

	MODEL	GRADE	A	B	C	D
SOLID SURFACE ARM CAPS 	ACVLS	Stocked Solid Surface	192 LIST/PR	198 LIST/PR	206 LIST/PR	222 LIST/PR
		Non-stocked (per color, per order)	ADD	410 NET	450 NET	490 NET

VALAYO CHAIRS | OTHER OPTIONS

	MODEL	DESCRIPTION	PRICE
GANGING BRACKET 	VLGB	Only available in Powder Coat	58 LIST

PRODUCT OPTIONS

MOISTURE BARRIER \$22 List / Yard
FIRE WALL / CA T.B. 133 \$82 List / Yard



VALAYO COLLECTION | BENCHES



CERTIFIED
CLEAN AIR GOLD





COMPONENT-BASED
CONSTRUCTION

2K STATIC
CAPACITY

1K DROP
CAPACITY

VALAYO UPHOLSTERED TOP BENCHES WITH ARMS



SOLID STEEL WITH POWDER COAT (PC) OR BRUSHED CHROME (BC)

	MODEL	YARDS	COM	M	COL				S	T	U	W/WL
					O	P	R					
BENCH - 26" W: 26 D: 24 SW: 20.5 SH: 18.5 AH: 26 	VLBN-7-26 PC	1	1639	1676	1721	1762	1806	1849	1893	1936	2001	
	VLBN-7-26 BC	1	1639	1676	1721	1762	1806	1849	1893	1936	2001	
BENCH - 46" W: 46 D: 24 SW: 40.5 SH: 18.5 AH: 26 	VLBN-7-46 PC	1.5	1845	1901	1968	2030	2096	2160	2226	2291	2388	
	VLBN-7-46 BC	1.5	1845	1901	1968	2030	2096	2160	2226	2291	2388	
BENCH - 72" W: 72 D: 24 SW: 66.5 SH: 18.5 AH: 26 	VLBN-7-72 PC	2.25	2182	2265	2367	2459	2558	2655	2754	2850	2997	
	VLBN-7-72 BC	2.25	2182	2265	2367	2459	2558	2655	2754	2850	2997	

VALAYO UPHOLSTERED TOP BENCHES | ARM CAP OPTIONS

	MODEL	GRADE	A	B	C	D
SOLID SURFACE ARM CAPS 	ACVLS	Stocked Solid Surface	192 LIST/PR	198 LIST/PR	206 LIST/PR	222 LIST/PR
		Non-stocked (per color, per order) ADD	410 NET	450 NET	490 NET	520 NET

VALAYO UPHOLSTERED TOP BENCHES ARMLESS

	MODEL	YARDS	COM	M	COL				S	T	U	W/WL
					O	P	R					
BENCH - 26" W: 26 D: 23 SW: 26 SH: 18.5 	VLABN-7-26 PC	1	1381	1418	1463	1504	1548	1591	1635	1678	1743	
	VLABN-7-26 BC	1	1381	1418	1463	1504	1548	1591	1635	1678	1743	
BENCH - 46" W: 46 D: 23 SW: 46 SH: 18.5 	VLABN-7-46 PC	1.5	1587	1643	1710	1772	1838	1902	1968	2033	2130	
	VLABN-7-46 BC	1.5	1587	1643	1710	1772	1838	1902	1968	2033	2130	
BENCH - 72" W: 72 D: 23 SW: 72 SH: 18.5 	VLABN-7-72 PC	2.25	1924	2007	2109	2201	2300	2397	2496	2592	2739	
	VLABN-7-72 BC	2.25	1924	2007	2109	2201	2300	2397	2496	2592	2739	

PRODUCT OPTIONS

MOISTURE BARRIER \$22 List / Yard
FIRE WALL / CA T.B. 133 \$82 List / Yard



VALAYO COLLECTION | BENCHES AND TABLES

LAMINATE AND SOLID SURFACE TOPS COMPLIANT WITH



CERTIFIED CLEAN AIR GOLD

Healthier Hospitals

COMPONENT-BASED CONSTRUCTION

VALAYO HARD TOP BENCHES AND TABLES

SOLID STEEL WITH POWDER COAT (PC) OR BRUSHED CHROME (BC)

BENCH / TABLE - 20"

W: 20

D: 20 (top) / 23 (overall)

CHOOSE HEIGHT:

H: 16.5 (TABLE) OR 18.5 (BENCH)



MODEL	TOP (1.5"-THICK)	POWDER COAT LEGS (PC)	BRUSHED CHROME LEGS (BC)
VLTB-M-2020	Veneer*	1281	1281
VLTB-L-2020	Stocked Laminate	1281	1281
	Non-stocked Laminate (per color, per order)	ADD 50 Net	50 Net

NOTE: Custom Wood Finish (CWF) is a one-time upcharge of 300 NET per color.

MODEL	SOLID SURFACE TOP (1.5"-THICK)		POWDER COAT LEGS			
			A	B	C	D
VLTB-S-2020PC	Stocked		1790	1790	2095	2377
	Non-stocked (per color, per order)	ADD	410 NET	450 NET	490 NET	520 NET

MODEL	SOLID SURFACE TOP (1.5"-THICK)		BRUSHED CHROME LEGS			
			A	B	C	D
VLTB-S-2020BC	Stocked		1790	1790	2095	2377
	Non-stocked (per color, per order)	ADD	410 NET	450 NET	490 NET	520 NET

NOTE: Height must be specified - 16.5" for Table or 18.5" for Bench

*Veneer Tops are not compliant with Clean Air Gold Certification or Healthier Hospitals Initiative.

BENCH / TABLE - 46"

W: 46

D: 20 (top) / 23 (overall)

CHOOSE HEIGHT:

H: 16.5 (TABLE) OR 18.5 (BENCH)



MODEL	TOP (1.5"-THICK)	POWDER COAT LEGS (PC)	BRUSHED CHROME LEGS (BC)
VLTB-M-4620	Veneer*	1457	1457
VLTB-L-4620	Stocked Laminate	1457	1457
	Non-stocked Laminate (per color, per order)	ADD 50 Net	50 Net

NOTE: Custom Wood Finish (CWF) is a one-time upcharge of 300 NET per color.

MODEL	SOLID SURFACE TOP (1.5"-THICK)		POWDER COAT LEGS			
			A	B	C	D
VLTB-S-4620 PC	Stocked		2716	2716	3325	3889
	Non-stocked (per color, per order)	ADD	410 NET	450 NET	490 NET	520 NET

MODEL	SOLID SURFACE TOP (1.5"-THICK)		BRUSHED CHROME LEGS			
			A	B	C	D
VLTB-S-4620 BC	Stocked		2716	2716	3325	3889
	Non-stocked (per color, per order)	ADD	410 NET	450 NET	490 NET	520 NET

NOTE: Height must be specified - 16.5" for Table or 18.5" for Bench

*Veneer Tops are not compliant with Clean Air Gold Certification or Healthier Hospitals Initiative.

WELLNESS DIVIDER

WELLNESS DIVIDER

WD 2



WELLNESS DIVIDER



CERTIFIED
CLEAN AIR GOLD



COMPONENT-BASED
CONSTRUCTION

FREESTANDING WELLNESS DIVIDER

	MODEL	DESCRIPTION	PRICE
FREESTANDING WELLNESS DIVIDER W: 23.75 D: 13 H: 52 WT: 26 lbs	WDPC2	Silver Powder Coat with White HDPE	551
	WDPC1	Silver Powder Coat with Transparent Polycarbonate	699



NOTE: Additional Powder Coat colors are available at a 10% upcharge and possible longer lead time than Silver.

REPLACEMENT DIVIDERS

SCR1HD1	Replacement White HDPE	157
SCR1AC1	Replacement Transparent Polycarbonate	305



White HDPE Divider (WDPC2)

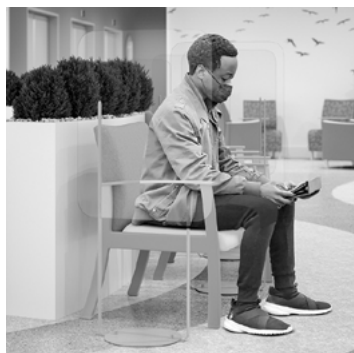
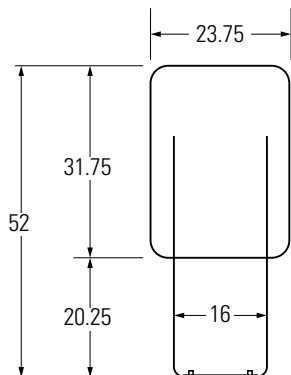

Transparent Polycarbonate Divider (WDPC1)

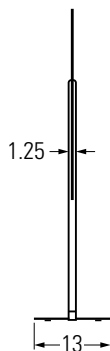

Education | Healthcare | Workplace

Integra[®]

800.235.0234 | integraseating.com

© 2021 INTEGRA, WALWORTH, WISCONSIN

072022