

Price Guide

AUGUST 2022



L A Z B O Y[®]
HEALTHCARE

KNÚ[®]

wood

T = Thermofoil Only
 * = Wood & Thermofoil



015T bisque 042-1 black* 233-1 espresso* 251-1 golden maple* 310 aria*



431-1 dark cherry* 530-1 medium maple* 663 mahogany* 683 walnut* 725 elm* 956T matte stone



829 baroque* 994 coffee* 548T northern grey 591T crystal white

metal



042 black 211 silver frost 540 pewter

*additional metal finishes available
 (contact customer service for a quote)

poly

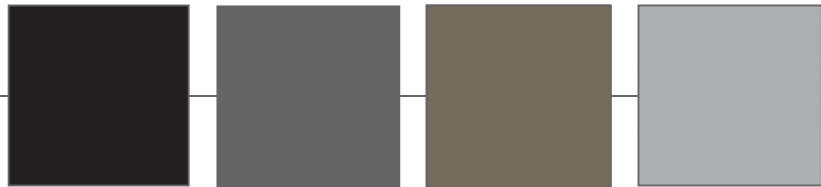

black carbon taupe titanium

solid

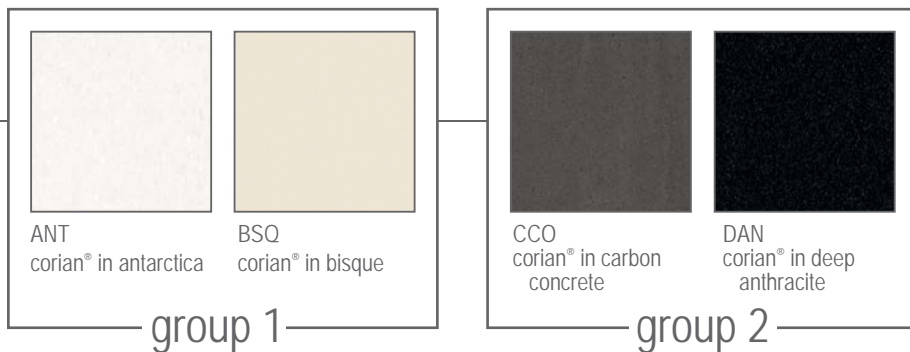

ANT corian® in antarctica BSQ corian® in bisque

CCO corian® in carbon concrete DAN corian® in deep anthracite

group 1

group 2



Made in the USA*

*With Domestic + Foreign Parts

*See notes on product pages for group 2 solid surface price upcharge. Unless otherwise noted solid surface prices in price guide are for group 1 finishes.

**Additional solid surface finishes available
 (contact customer service for a quote)

Index by Number.....	4-7
Terms + Conditions.....	8-9
Warranty Information.....	10
HealthTrust Information.....	11
CAL 117 CAL 133 UL Listing Take Back Program.....	12
Certifications Contracts.....	13
Finishes Moisture Barrier Options.....	14
Fabric Repeats.....	15
COM.....	16
COM Form.....	17
COF Form.....	18
Frame + Arm Cap Options.....	19
Product Pages.....	21-241
Guest Visitor Tandem Seating.....	21
Kadia Mod.....	22
Ottoman.....	29, 38
Koncert Metal.....	31
Koncert Wood.....	40
Hip Chairs Behavioral Health.....	49
Hip Chairs.....	50
Behavioral Health.....	52
Lounge Upholstered Lounge Tandem Seating.....	59
Assymble.....	60
Kascade.....	93
Dalton.....	76
Koncert Lounge.....	105
Kadia Mod Upholstered.....	79
Koncert Upholstered.....	111
Occasional Tables.....	127
K-Series Tables.....	128
Recliners.....	131
Ordering Guide.....	132
450 Series.....	145
Durable® 750 Series.....	205
Recliner Options.....	134
Durable® 550 Series.....	149
Lift Recliner Series.....	218
350 Series.....	136
Durable® 650 Series.....	158
Sleep Chairs Sleep Sofas.....	229
Kadia Mod.....	232
Harmony.....	235
EV.....	233
Oxley.....	236
Rêma.....	234
Max.....	238

MODEL	PAGE	MODEL	PAGE	MODEL	PAGE	MODEL	PAGE
AS10NC.....	61	EB4037.....	206	E1017.....	166	H5047.....	201
AS10N.....	61	EB4067.....	212	E1042.....	202	H5057.....	217
AS12AF.....	62	EB4137.....	206	E1047.....	198	H5117.....	164
AS12AJ.....	62	EB4167.....	212	E1062.....	193	H5118.....	177
AS12AU.....	62	EBC1037.....	207	E1067.....	183	H5137.....	211
AS12AW.....	62	EBC1067.....	213	E1117.....	166	H5147.....	201
AS12LF.....	63	EBC1137.....	207	E1118.....	173	H5157.....	217
AS12LJ.....	63	EBC1167.....	213	E1125.....	150	KAM10BHJ.....	25
AS12LU.....	63	EBC4037.....	206	E1125L.....	152	KAM10BHU.....	25
AS12LW.....	63	EBC4067.....	212	E1125R.....	151	KAM10BHW.....	25
AS12RF.....	64	EBC4137.....	206	E1127.....	154	KAM10BJ.....	24
AS12RJ.....	64	EBC4167.....	212	E1127L.....	156	KAM10BU.....	24
AS12RU.....	64	EC1017.....	166	E1127R.....	155	KAM10BW.....	24
AS12RW.....	64	EC1042.....	202	E1142.....	202	KAM10BHJP.....	51
AS20N.....	61	EC1047.....	198	E1147.....	198	KAM10BHJPU.....	51
AS22AF.....	65	EC1062.....	193	E1162.....	193	KAM10BHIPW.....	51
AS22AJ.....	65	EC1067.....	183	E1167.....	183	KAM10HIPJ.....	51
AS22AU.....	65	EC1117.....	166	E1304.....	140	KAM10HIPU.....	51
AS22AW.....	65	EC1118.....	173	E1306.....	142	KAM10HIPW.....	51
AS22LF.....	66	EC1125.....	150	E1307.....	141	KAM10HJ.....	24
AS22LJ.....	66	EC1125L.....	152	E1716.....	143	KAM10HU.....	24
AS22LU.....	66	EC1125R.....	151	E2017.....	165	KAM10HW.....	24
AS22LW.....	66	EC1127.....	154	E2062.....	194	KAM10J.....	23
AS22RF.....	67	EC1127L.....	156	E2067.....	184	KAM10U.....	23
AS22RJ.....	67	EC1127R.....	155	E2117.....	165	KAM10W.....	23
AS22RU.....	67	EC1142.....	202	E2118.....	172	KAM12J.....	23
AS22RW.....	67	EC1147.....	189	E2162.....	194	KAM12U.....	23
AS30N.....	61	EC1162.....	193	E2167.....	184	KAM12W.....	23
AS32AF.....	68	EC1167.....	183	E3017.....	159	KAM20IBLJ.....	26
AS32AJ.....	68	EC1304.....	140	E3062.....	188	KAM20IBLU.....	26
AS32AU.....	68	EC1306.....	142	E3067.....	178	KAM20IBLW.....	26
AS32AW.....	68	EC1307.....	141	E3117.....	159	KAM20IBRJ.....	27
AS32LF.....	69	EC2017.....	165	E3162.....	188	KAM20IBRU.....	27
AS32LJ.....	69	EC2062.....	194	E3167.....	178	KAM20IBRW.....	27
AS32LU.....	69	EC2067.....	184	E4017.....	163	KAM20IJ.....	26
AS32LW.....	69	EC2117.....	165	E4062.....	192	KAM20IU.....	26
AS32RF.....	70	EC2118.....	172	E4067.....	182	KAM20IW.....	26
AS32RJ.....	70	EC2162.....	194	E4117.....	163	KAM20J.....	25
AS32RU.....	70	EC2167.....	184	E4118.....	171	KAM20U.....	25
AS32RW.....	70	EC3017.....	159	E4125.....	153	KAM20W.....	25
AS90IC.....	71	EC3062.....	188	E4127.....	157	KAM30IBCJ.....	28
AS90OC.....	71	EC3067.....	178	E4162.....	192	KAM30IBCU.....	28
ASB2424.....	72	EC3117.....	159	E4167.....	182	KAM30IBCW.....	28
ASB2448.....	72	EC3162.....	188	GOT00.....	144	KAM30IBLJ.....	28
ASB2472.....	72	EC3167.....	178	HC5017.....	164	KAM30IBLU.....	28
ASB3024.....	72	EC4017.....	163	HC5037.....	211	KAM30IBLW.....	28
ASB3048.....	72	EC4062.....	192	HC5047.....	201	KAM30IBRJ.....	29
ASB3072.....	72	EC4067.....	182	HC5057.....	217	KAM30IBRU.....	29
AST10.....	73	EC4117.....	163	HC5117.....	164	KAM30IBRW.....	29
AST15.....	73	EC4118.....	171	HC5118.....	177	KAM30IJ.....	27
AST90.....	73	EC4125.....	153	HC5137.....	211	KAM30IU.....	27
DL10.....	77	EC4127.....	157	HC5147.....	201	KAM30IW.....	27
DL20.....	77	EC4162.....	192	HC5157.....	217	KAS10A.....	94
DL30.....	78	EC4167.....	182	H1700.....	235	KAS10BA.....	96
EB1037.....	207	E0700.....	233	H1800.....	235	KAS10BF.....	96
EB1067.....	213	E0722.....	233	H1900.....	235	KAS10F.....	94
EB1137.....	207	E0800.....	233	H5017.....	164	KAS13A.....	95
EB1167.....	213	E0900.....	233	H5037.....	211	KAS13BA.....	97

MODEL	PAGE	MODEL	PAGE	MODEL	PAGE	MODEL	PAGE
KAS13BF.....	97	KMBC1037.....	210	KMU30IBLF.....	91	KOT10BHIPW.....	50
KAS13F.....	95	KMBC1067.....	216	KMU30IBLJ.....	91	KOT10HIPU.....	50
KAS18A.....	98	KMBC1137.....	210	KMU30IBLU.....	91	KOT10HIPW.....	50
KAS18F.....	98	KMBC1167.....	216	KMU30IBLW.....	91	KOT10HU.....	33
KAS20A.....	99	KMB1037.....	210	KMU30IBRF.....	92	KOT10HW.....	33
KAS20F.....	99	KMB1067.....	216	KMU30IBRJ.....	92	KOT10U.....	32
KAS23A.....	100	KMB1137.....	210	KMU30IBRU.....	92	KOT10W.....	32
KAS23F.....	100	KMB1167.....	216	KMU30IBRW.....	92	KOT12U.....	32
KAS28A.....	101	KMC1017.....	169	KMU30IF.....	89	KOT12W.....	32
KAS28F.....	101	KMC1062.....	197	KMU30IJ.....	89	KOT19UM.....	52
KAS30A.....	102	KMC1067.....	187	KMU30IU.....	89	KOT19WM.....	52
KAS30F.....	102	KMC1117.....	169	KMU30IW.....	89	KOT19U.....	52
KAS33A.....	103	KMC1118.....	176	KMU30J.....	88	KOT19W.....	52
KAS33F.....	103	KMC1162.....	197	KMU30J.....	88	KOT2020.....	128
KAS38A.....	104	KMC1167.....	187	KMU30U.....	88	KOT20IBLU.....	35
KAS38F.....	104	KMC3017.....	162	KMU30W.....	88	KOT20IBLU.....	35
KB1037.....	209	KMC3062.....	191	KM1017.....	169	KOT20IBLW.....	35
KB1067.....	215	KMC3067.....	181	KM1062.....	197	KOT20IBRU.....	36
KB1137.....	209	KMC3117.....	162	KM1067.....	187	KOT20IBRW.....	36
KB1167.....	215	KMC3162.....	191	KM1117.....	169	KOT20IU.....	35
KBC1037.....	209	KMC3167.....	181	KM1118.....	176	KOT20IW.....	35
KBC1067.....	215	KMU10BF.....	81	KM1162.....	197	KOT20U.....	34
KBC1137.....	209	KMU10BJ.....	81	KM1167.....	187	KOT20W.....	34
KBC1167.....	215	KMU10BU.....	81	KM1700.....	232	KOT2420.....	128
KC1017.....	168	KMU10BW.....	81	KM1722.....	232	KOT24R.....	129
KC1042.....	204	KMU10F.....	80	KM1800.....	232	KOT29IU.....	53
KC1047.....	200	KMU10J.....	80	KM1900.....	232	KOT29IW.....	53
KC1062.....	196	KMU10U.....	80	KM3017.....	162	KOT29U.....	53
KC1067.....	186	KMU10W.....	80	KM3062.....	191	KOT29W.....	53
KC1117.....	168	KMU20F.....	82	KM3067.....	181	KOT30IBCU.....	37
KC1118.....	175	KMU20IBLF.....	86	KM3117.....	162	KOT30IBCW.....	37
KC1125.....	150	KMU20IBLJ.....	86	KM3162.....	191	KOT30IBLU.....	37
KC1127.....	154	KMU20IBLU.....	86	KM3167.....	181	KOT30IBLU.....	37
KC1142.....	204	KMU20IBLW.....	86	KOL10BU.....	106	KOT30IBLW.....	37
KC1147.....	200	KMU20IBRF.....	87	KOL10BW.....	106	KOT30IBRU.....	38
KC1162.....	196	KMU20IBRJ.....	87	KOL10U.....	106	KOT30IBRW.....	38
KC1167.....	186	KMU20IBRU.....	87	KOL10W.....	106	KOT30IU.....	36
KC1304.....	140	KMU20IBRW.....	87	KOL20IBLU.....	108	KOT30IW.....	36
KC1306.....	142	KMU20IF.....	83	KOL20IBLW.....	108	KOT3636.....	128
KC1307.....	141	KMU20IJ.....	83	KOL20IBRU.....	108	KOT36R.....	129
KC1L04.....	225	KMU20ITF.....	84	KOL20IBRW.....	108	KOT39IU.....	54
KC1P04.....	228	KMU20ITJ.....	84	KOL20IU.....	107	KOT39IW.....	54
KC3017.....	161	KMU20ITU.....	84	KOL20IW.....	107	KOT4820.....	128
KC3062.....	190	KMU20ITW.....	84	KOL20U.....	107	KOU10BF.....	113
KC3067.....	180	KMU20IU.....	83	KOL20W.....	107	KOU10BJ.....	113
KC3117.....	161	KMU20IW.....	83	KOL30IBCU.....	109	KOU10BU.....	113
KC3162.....	190	KMU20J.....	82	KOL30IBCW.....	109	KOU10BW.....	113
KC3167.....	180	KMU20TF.....	85	KOL30IBLU.....	110	KOU10F.....	112
KC8004.....	138	KMU20TJ.....	85	KOL30IBLW.....	110	KOU10J.....	112
KC8014.....	138	KMU20TU.....	85	KOL30IBRU.....	110	KOU10U.....	112
KC8L04.....	226	KMU20TW.....	85	KOL30IBRW.....	110	KOU10W.....	112
KC8L14.....	226	KMU20U.....	82	KOL30IBRW.....	110	KOU15T.....	125
KC8P04.....	227	KMU20W.....	82	KOL30IU.....	109	KOU19F.....	55
KC8P14.....	227	KMU30F.....	88	KOL30IW.....	109	KOU19FM.....	55
KL1017.....	170	KMU30IBCF.....	90	KOT00.....	29, 38	KOU20F.....	114
KL1117.....	170	KMU30IBCJ.....	90	KOT10BHU.....	34	KOU20IBLF.....	118
KLC1017.....	170	KMU30IBCJ.....	90	KOT10BHW.....	34	KOU20IBLJ.....	118
KLC1117.....	170	KMU30IBCU.....	90	KOT10BU.....	33	KOU20IBLU.....	118
		KMU30IBCU.....	90	KOT10BW.....	33	KOU20IBLW.....	118
		KMU30IBCW.....	90	KOT10BHIPU.....	50	KOU20IBRF.....	119

MODEL	PAGE	MODEL	PAGE	MODEL	PAGE	MODEL	PAGE
KOU20IBRJ.....	119	KT6M3636B4.....	130	RB1037.....	208	R1722.....	234
KOU20IBRU.....	119	KT6M4820B2.....	130	RB1067.....	214	R1800.....	234
KOU20IBRW.....	119	KTC03.....	47	RB1137.....	208	R1900.....	234
KOU20IF.....	115	KTC07.....	30, 39	RB1167.....	214	R3017.....	160
KOU20IJ.....	115	KTE07L.....	30, 39	RC1017.....	167	R3062.....	189
KOU20ITF.....	116	KTE07R.....	30, 39	RC1042.....	203	R3067.....	179
KOU20ITJ.....	116	KTI07.....	30, 39	RC1047.....	199	R3117.....	160
KOU20ITU.....	116	KTI03.....	47	RC1062.....	195	R3162.....	189
KOU20ITW.....	116	KWE03L.....	47	RC1067.....	185	R3167.....	179
KOU20IU.....	115	KWE03R.....	47	RC1117.....	167	R7M18.....	219
KOU20IW.....	115	K0017.....	137	RC1118.....	174	R7M62.....	221
KOU20J.....	114	K0107.....	146	RC1125.....	150	R7M67.....	220
KOU20TF.....	117	K0167.....	147	RC1125L.....	152	R7P18.....	222
KOU20TJ.....	117	K1017.....	168	RC1125R.....	151	R7P62.....	224
KOU20TU.....	117	K1042.....	204	RC1127.....	154	R7P67.....	223
KOU20TW.....	117	K1047.....	200	RC1127L.....	156		
KOU20U.....	114	K1062.....	196	RC1127R.....	155		
KOU20W.....	114	K1067.....	186	RC1142.....	203		
KOU29F.....	56	K1117.....	168	RC1147.....	199		
KOU29IF.....	56	K1118.....	175	RC1162.....	195		
KOU30F.....	120	K1125.....	150	RC1167.....	185		
KOU30IBCF.....	122	K1127.....	154	RC1304.....	140		
KOU30IBCF.....	122	K1142.....	204	RC1306.....	142		
KOU30IBCU.....	122	K1147.....	200	RC1307.....	141		
KOU30IBCW.....	122	K1162.....	196	RC3017.....	160		
KOU30IBLF.....	123	K1167.....	186	RC3062.....	189		
KOU30IBLJ.....	123	K1304.....	140	RC3067.....	179		
KOU30IBLU.....	123	K1306.....	142	RC3117.....	160		
KOU30IBLW.....	123	K1307.....	141	RC3162.....	189		
KOU30IBRF.....	124	K1716.....	143	RC3167.....	179		
KOU30IBRJ.....	124	K1L04.....	225	RC7M18.....	219		
KOU30IBRU.....	124	K1P04.....	228	RC7M62.....	221		
KOU30IBRW.....	124	K3017.....	161	RC7M67.....	220		
KOU30IF.....	121	K3062.....	190	RC7P18.....	222		
KOU30IJ.....	121	K3067.....	180	RC7P62.....	224		
KOU30IU.....	121	K3117.....	161	RC7P67.....	223		
KOU30IW.....	121	K3162.....	190	R1017.....	167		
KOU30J.....	120	K3167.....	180	R1042.....	203		
KOU30U.....	120	K8004.....	138	R1047.....	199		
KOU30W.....	120	K8006.....	139	R1062.....	195		
KOU39F.....	57	K8014.....	138	R1067.....	185		
KOU39IF.....	57	K8016.....	139	R1117.....	167		
KOU90T.....	125	K8L04.....	226	R1118.....	174		
KOW10.....	41	K8L14.....	226	R1125.....	150		
KOW10B.....	42	K8P04.....	227	R1125L.....	152		
KOW10BH.....	42	K8P14.....	227	R1125R.....	151		
KOW10H.....	41	M0107.....	148	R1127.....	154		
KOW20.....	43	N70XXXUF.....	240	R1127L.....	156		
KOW20I.....	43	N78XXXUF.....	240	R1127R.....	155		
KOW20IBL.....	44	ON2076UF.....	237	R1142.....	203		
KOW20IBR.....	44	ON2076HPUF.....	237	R1147.....	199		
KOW30I.....	45	ON2176UF.....	237	R1162.....	195		
KOW30IBC.....	45	OO2176UF.....	237	R1167.....	185		
KOW30IBL.....	46	OW2176UF.....	237	R1304.....	140		
KOW30IBR.....	46	RBC1037.....	208	R1306.....	142		
KT6C4820B2.....	130	RBC1067.....	214	R1307.....	141		
KT6E2020B1.....	130	RBC1137.....	208	R1700.....	234		
KT6E2420B3.....	130	RBC1167.....	214	R1716.....	143		

Order Information

All prices shown in this price book are list prices in US Dollars. Prices are subject to change without notice. The customer's purchase order must include complete information or order will be held from production until all information is provided. The customer bears sole responsibility for order correctness. Orders are subject to Knú, LLC's terms and conditions, regardless of the terms and conditions set forth on the buyer's/customer's purchase order forms. All customer orders must receive credit approval before the order can be entered into production.

Mail, Fax, or E-mail Purchase Orders To

Knú, LLC | DBA / La-Z-Boy Healthcare & Knú Comfort
 P.O. Box 9, Ferdinand, IN 47532
 Phone: 812.367.2068 | Fax: 812.367.2493
 E-mail: customerservice@getknu.com

Payment Terms

Terms are NET 30 days from shipment. If an invoice is not paid in full, within the terms, a monthly finance charge will be assessed at a rate of 1.5% per month or the highest amount permitted by applicable state law. The customer will be liable for any collection and/or attorney fees incurred in the collection of past due accounts.

Selling Information

Distribution of this price list does not in itself constitute an offer to sell. Orders may only be placed by customers authorized by Knú, LLC management.

Order Acknowledgment

The customer will receive an order acknowledgement by e-mail or fax. Upon receipt of this acknowledgement it is the customer's responsibility to check the accuracy of the order and notify customer service of any errors. Once an order is acknowledged, Knú, LLC will be responsible for shipping exactly the items acknowledged at the prices acknowledged. No changes may be made once an order has been placed into production. The order will be shipped upon completion of production. Every effort will be made to ship orders within the acknowledged ship dates. Acknowledged ship dates, however, are contingent upon conditions beyond our control. We cannot make promises for delivery dates as service by transportation companies varies from destination to destination.

Order Cancellations

Cancellations must be communicated via email or fax to customer service and not to the sales representative. A cancellation penalty will apply. After an order is acknowledged and placed into production, cancellations cannot be accepted.

Packaging

All prices include packaging. Assembled chairs are normally shipped one per carton unless otherwise specified. All of our packaging and cartons meet or exceed ICC specifications.

Freight Terms & Conditions

All product is shipped F.O.B. the Knú, LLC factory, with freight prepaid to the continental U.S. destination (dealer's dock or territorial warehouse) and does not include home delivery. International shipments, shipments to Puerto Rico, Hawaii, and Alaska are freight prepaid to the port of exit. For special packing for these shipments, call Customer Service for quote. Customers must select a standard delivery location for their orders. Docks at the selected delivery location must be equipped to handle a 53' trailer. When a Knú, LLC customer/dealer warehouse is selected as the default delivery location, it is understood that Knú, LLC pays freight cost to the default delivery location only, and no further. The customer is responsible for all charges from this point. Knú, LLC utilizes freight carriers that are dedicated furniture specialists. For all deliveries, it is understood that Knú, LLC or its agents are making a dock delivery only, and any further work of truck unloading, delivery beyond the dock, installation, and/or removal of packaging is not authorized or paid for by Knú, LLC. Home delivery is not included and must be negotiated prior to order placement. For all deliveries, whether to the customer location or drop shipment, any circumstances that result in the delay of our carrier (including unsuitable receiving facilities, or facilities not open or available), will result in service charges applied at the rate of \$75 per hour. Where re-delivery is necessary because of these circumstances, the full cost of re-delivery will be charged.

International shipments, shipments into Puerto Rico, and shipments into the states of Hawaii and Alaska are freight prepaid to the port of exit. Please call Customer Service for a quote on special packing for overseas container shipments. Knú, LLC reserves the right to implement a fuel surcharge or freight fee and also reserves the right to select the most appropriate F.O.B. point, carrier, and routing on all shipments. Orders with a NET of \$1,500 or less are subject to a \$250 Shipping and Handling Fee. All Knú, LLC products are carefully inspected and properly packaged by trained personnel before leaving the factory. The transportation company assumes full responsibility for safe delivery upon acceptance of the shipment. All shipments are delivered to the freight company in good condition. If a shipment is received that has visible damage, product shortages or if delivery has been delayed by the freight company the following steps must be taken:

1. Before signing for the merchandise, make notations of all visible damage and/or shortages on the Bill of Lading. The delivering freight company may not accept responsibility for damage and/or shortages if proper notification of the alleged problem is not given when signing for the merchandise. If visual damage is not apparent, sign the delivery receipt "no visual damage". This will allow recourse for a concealed damage claim. Claims for freight damage, concealed or otherwise, must be filed within ten (10) days of the original delivery date.
2. Do not refuse merchandise damaged in transit. The delivering freight company (not Knú, LLC) is responsible for damage to goods which occur in transit or storage.
3. Failure to make claims against Knú, LLC or its designated carrier within ten (10) days shall constitute acceptance of the merchandise and a waiver of any defects, errors, or shortages discovered upon inspection.
4. If a claim is filed you must retain all shipping cartons and packing material for inspection by the carrier agent.

Storage Policy

Upon written notice, Knú | La-Z-Boy will provide storage, once an order is completed, for up to five (5) calendar days at no charge. Any order requiring storage beyond five (5) calendar days will be subject to a storage fee.

Return Merchandise

No returns of merchandise will be accepted without written authorization from Knú corporate office customer service. Before a return of merchandise is authorized, Knú factory sales representative reserves the right to inspect the furniture in question. Any item(s) that has been approved for return must be returned properly packed and in the original factory carton. All freight charges for returned product are the responsibility of the customer. Unauthorized returns will not be accepted and will be returned to customer freight collect. Upon receipt, all returned merchandise will be thoroughly inspected and the results compared to the reason given for the return stated on the authorization form. Any discrepancies, such as additional damage, signs of usage, missing parts, etc., will result in an adjustment to the amount of the credit issued.

Customer Satisfaction

Our goal at Knú, LLC is to ensure that our customers are completely satisfied with our products. If a problem arises with La-Z-Boy Healthcare | Knú Comfort after the warranty period, Knú, LLC will make its best effort to satisfy the customer in a manner that is fair to all concerned.

Important Notes

1. COM orders must contain the fabric supplier name, pattern name, and color name of the pattern you wish to order.
2. Directional covers, such as stripes, patterns, and plaids may not meet your satisfaction due to contoured shapes and tufting on some furniture styles. Should one of these designs be selected, we will do our best to manufacture the furniture to meet your satisfaction. However, such orders are not subject to return.
3. Textiles listed are supplied by the fabric suppliers and not all colors of the textile listed may be available.
4. Once an order for cut yardage is acknowledged, adjustments or cancellations will result in a restocking fee for the purchase price of the fabric.
5. Not all textiles are available in CAL 133.
6. Non-Warranty Service Orders: Please Call Customer Service for Pricing. (812.367.2068/phone)

La-Z-Boy Healthcare warrants the products it manufactures against defects in material and workmanship under normal use and service for the expected useful life of the product from the date of shipment. This limited warranty is valid only to the original purchaser using the product for its intended purpose, provided the product is covered in its original cover. This warranty does not apply to expected changes resulting from normal wear and tear, use and aging of the product. Specifically excluded from this limited warranty are defects and damage resulting from abuse, neglect, misuse, or excessive use. Product alteration, substitution of components or materials, improper cleaning or repair, and installation and handling damages are also not covered by this warranty. All other express or implied warranties made by agents, dealers, sales representatives or any other representatives, including any warranty of merchantability or fitness for a particular purpose, are hereby excluded.

There are no representations as to the capacity or performance of the products sold hereunder except as set forth in the price book or quotation specifications, if any, and such representations are expressly conditioned upon the correctness of the data furnished by purchaser and upon the products being properly installed and maintained.

Knú, LLC's sole obligation shall be to repair any defective product or product component covered under this warranty, including shipping and labor, during the warranty period. In no event shall Knú, LLC be liable for any consequential or incidental damages, including lost profits or revenues incurred by the purchaser with respect to any goods furnished by Knú, LLC. Expenses incurred by purchaser in repairing or replacing Knú, LLC's product must be pre-approved in writing by Knú, LLC.

Knú, LLC offers no warranty on the following product components or characteristics: all forms of upholstery, including fabric, vinyl and leather, as well as wood grain, color and texture. Knú, LLC offers no warranty on COM, COL, or any other special order fabric used at the request of the Purchaser. Warranties offered by cover suppliers to Knú, LLC, if any, are hereby assigned to Purchaser.

In the event a product has to be returned to the factory for verification of a defect and/or repair, it must be pre-approved in writing by Knú, LLC, freight pre-paid, and include a copy of the original invoice with the date and name of original purchaser.

Knú, LLC hereby assigns to the original owner any and all warranties offered by its component suppliers. To the extent the terms of these warranties differ from the terms of the Limited Warranty, the terms of the suppliers' component warranties shall apply. However, Knú, LLC does not guarantee that the component supplier will comply with any terms of the warranty of such supplier.

KNÚ, LLC WILL NOT BE LIABLE FOR ANY CONSEQUENTIAL OR INCIDENTAL DAMAGES INCLUDING ANY LOSS, EXPENSE, OR DAMAGE OTHER THAN TO THE PRODUCT ITSELF THAT MAY RESULT FROM A DEFECT IN THE PRODUCT. SOME STATES DO NOT ALLOW FOR THE EXCLUSION OR LIMITATION OF CONSEQUENTIAL AND INCIDENTAL DAMAGES, SO THE ABOVE LIMITATION OR EXCLUSION MAY NOT APPLY.

KNÚ, LLC MAKES NO IMPLIED WARRANTIES OF MERCHANTABILITY OR FITNESS FOR A PARTICULAR PURPOSE. THESE AND ALL OTHER IMPLIED WARRANTIES ARE SPECIFICALLY DISCLAIMED. SOME STATES DO NOT ALLOW AN EXCLUSION OR LIMITATION ON HOW LONG AN IMPLIED WARRANTY LASTS, SO THE ABOVE LIMITATIONS OR EXCLUSIONS MAY NOT APPLY.

THIS WARRANTY GIVES YOU, THE ORIGINAL PURCHASER, SPECIFIC LEGAL RIGHTS AND YOU MAY ALSO HAVE OTHER RIGHTS THAT VARY FROM STATE TO STATE. EXCEPT FOR SUCH OTHER RIGHTS, THE REMEDIES PROVIDED UNDER THIS WARRANTY STATE THE LIMIT OF KNÚ, LLC'S RESPONSIBILITIES.



U.S. General Services Administration
 GSA Contract #: GS-28F-0008V
 Contract Period: 12/3/08 – 12/2/2023
 Price List Effective Date: 07/01/2020
 Knú, LLC. DBA: La-Z-Boy Healthcare & Knú Comfort
 Website: www.lzbcontract.com

- 1. Special Item Number (SIN):
 - 337121H Household, Dormitory & Quarters Furniture
 - 339113H Healthcare Furniture
 - OLM Order-Level Materials
 - 33721 Office Furniture

- 2. Delivery Time: 5 weeks ARO (35 Days ARO)

- 3. Point of Production: 1300 North Broad Street, Leland, MS 38756

- 4. FOB Terms: FOB Origin, Freight Prepay, Plus a \$250 handling fee for all orders less than \$1,500.00 Net International shipments, shipments into Puerto Rico, and shipments into the states of Hawaii and Alaska are freight prepaid to the port of exit. Please call Customer Service for a quote on special packing for overseas container shipments

- 5. Prompt Payment Terms: Net 30

- 6. Minimum Order: \$100 Net

- 7. Maximum Order: \$200,000 Net

- 8. Warranty: Standard Commercial Warranty

- 9A. Ordering Address: Knú, LLC | DBA / La-Z-Boy Healthcare & Knú Comfort
P.O. Box 9, Ferdinand, IN 47532

- 9B. Remit to Address: Knú, LLC | DBA / La-Z-Boy Healthcare & Knú Comfort
1597 Momentum Place, Chicago, IL 60689

- 10. Credit Cards Accepted: Visa, MasterCard, Discover, and American Express

- 11. Return Policy/Restocking Fee: No returns of merchandise will be accepted without written authorization from Knú, LLC. If authorized, the customer will pay all freight charges and a 30% (Net Price) restocking fee will be assessed.

- 12. Cancellation Policy: No charge prior to production. After production has begun, only actual costs that the contractor can demonstrate will be charged.

- 13. Rental, Maintenance, Repair: N/A

- 14. Repair Parts: See Warranty

- 15. List of Participating Dealers: Contact Customer Service

- 16. Dealer Registration: The name of the dealer must appear on the GSA Purchase Order.

- 17. GSA Customer Service: E-Mail: gsasales@getknu.com | Phone: 812-367-0120 | Fax: 812-367-2493

- 18. DUNS Number: 197589893
 FED ID Number: 20-2599789
 Cage Code Number: 4CDO5

- 19. GSA Discount: 61.2% Off List

CAL 117 | CAL 133

All Knú, LLC standard upholstered seating and the filling materials used in the construction of our seating, either meet or exceed the flammability requirements of Cal 117-2013. Knú, LLC will manufacture its seating when requested by a customer or where required by law to meet or exceed the flammability requirements of California Technical Bulletin 133. CAL TB133 requires actual tests of the complete unit and not just the components as CAL 117-2013 does. CAL TB133 is specific to the fabric, frame, and all filaments.

Knú, LLC recommends the use of a CAL 117-2013 Fabric, Fire Resistant Foam, and a Fire Resistant Barrier for a successful CAL TB133 burn test; however, this alone does not guarantee a product will pass the burn test. The cost of a burn test is \$500 (net) plus the cost of the product, along with the barrier and the fabric. Please allow a minimum of six (6) weeks for the production of the product and the completion of the test. Once the product successfully passes the burn test a certificate will be supplied.

If you do not need actual certification, the product can be upholstered using Fire Resistant Foam and the Fire Resistant Barrier at an upcharge of \$80 List per yard. Use the COM yardage requirements for your upcharge formula. COM yardage requirements are located on the individual product pages. (Please note that your COM fabric selection must pass CAL 117-2013 which will be stated in your fabric specifications.)

When sending in COM to have CAL TB133 added, Knú, LLC will need an additional yardage amount equal to either 5% of the total yardage, or 1 yard, whichever is the greatest. CAL TB133 cannot be added to leather.

CAL TB133 outlines the method and technique to which the furniture should be tested. Beyond that, it leaves classifications of furniture fabric to the discretion of the manufacturer/supplier of the fabric over which Knú, LLC has no control. Knú, LLC has tested a variety of chairs and fabrics with successful test results. Knú, LLC then cross-referenced similar models to see which ones would be applicable; however, this does not constitute a certification of an actual burn test.

The following upholstered frames have passed the CAL TB133 Fire Test for furniture manufactured for public area use. Please contact customer service for pricing and lead times.

Model

Dalton DL10
EV Collection E4017
Harmony H5017

Textile

Maharam Article Flume (458600-013)
CF Stinson Script Spearmint (ST10)
Arc-Com Frontier AC - 67492
CF Stinson Script Palm (SCT 20)
Maharam Medium Marina (022)
Momentum Bravo Tumbleweed

UL Listing

All electrical components used in Knú, LLC products are UL listed. A UL listing for an entire Knú, LLC product can be obtained at an additional charge. Please contact customer service for pricing and lead times.

Note: Knú, LLC makes no recommendations or representations regarding whether CAL 133 certification or UL listing is required for the lawful use of Knú, LLC products. It is the sole responsibility of the customer to ascertain and comply with the laws, ordinances, regulations and codes of their particular jurisdiction that apply to their use of Knú, LLC products.

Product Take Back Program

Knú, LLC is proud to offer ANEW to customers dedicated to strengthening their community network by repurposing their furniture, fixtures, and architectural materials to those in need. In 2014, Knú, LLC committed to making this relationship a part of our strategic sales strategy. Visit www.anewfound.org for more information.

To initiate a product take back strategy, contact Customer Service at customerservice@getknu.com.

Certifications



General Services Administration (GSA)

www.gsa.gov
www.gsaadvantage.gov



GREENGUARD Gold Certification | www.greenguard.org

GREENGUARD Gold Certification (formerly known as GREENGUARD Children & Schools Certification) offers stricter certification criteria, considers safety factors to account for sensitive individuals (such as children and the elderly), and ensures that a product is acceptable for use in environments such as schools and healthcare facilities. It is referenced by both The Collaborative for High Performance Schools (CHPS) and the Leadership in Energy and Environmental Design (LEED) Building Rating System.



level® Certification | www.levelcertified.org

BIFMA's e3 Furniture Sustainability Standard is a voluntary, multi-attribute standard that measures the degree of sustainability of furniture. This standard evaluates product and company environmental attributes and compliance systems in a wide range of elements, including Materials, Energy & Atmosphere, Human & Ecosystem Health, and Social Responsibility.



Healthier Hospitals | A Practice Greenhealth Program) | www.healthierhospitals.org

Healthier Hospitals Initiative encourages manufacturers to provide information on furniture that meets the (HH) goal of Safer Chemicals Challenge. Knú Comfort | La-Z-Boy Healthcare offers a complete line of healthcare furniture that meets the Healthy Interiors goal of the Safer Chemicals Challenge – creating healthcare seating environments that are free from hazardous chemicals.

Finishes

GREENGUARD Indoor Air Quality Certified® wood finish is standard on all La-Z-Boy Healthcare & Knú Comfort exposed wood finishes

Wood Finishes

042-1	Black
233-1	Espresso
251-1	Golden Maple
310	Aria
431-1	Dark Cherry
530-1	Medium Maple
663	Mahogany
683	Walnut
725	Elm
829	Baroque
994	Coffee

Thermofoil Finishes

042T	Black
233T	Espresso
251T	Golden Maple
310T	Aria
431T	Dark Cherry
530T	Medium Maple
663T	Mahogany
683T	Walnut
725T	Elm
829T	Baroque
994T	Coffee
548T	Northern Grey
591T	Crystal White
956T	Matte Stone
015T	Bisque

Powder Coat Finishes*

042	Black
211	Silver Frost
540	Pewter

*All colors not available on all metal frames.

Polyurethane Finishes*

Black
Carbon
Taupe
Titanium

*All colors not available on all collections.

Solid Surface Finishes

Corian Antarctica (Group 1)
Corian Bisque (Group 1)
Corian Carbon Concrete (Group 2)
Corian Deep Anthracite (Group 2)

Customer's Own Finish (COF)

Color panels must be submitted to the following address for matching purposes:

Knú, LLC | DBA / La-Z-Boy Healthcare & Knú Comfort
ATTN: COF Department
824 W. 23rd Street, P.O. Box 9, Ferdinand, IN 47532

Knú, LLC will provide a matching finish sample for customer's approval prior to acknowledgment of the order. The order will not be scheduled for production until an approved finish sample has been received. A \$400 List Per Finish price will apply per order.

Moisture Barrier Options

Moisture barriers that are designed to prevent liquid penetration to the foam and other filling materials are available on most items at an additional charge. Moisture barriers are applied between the upholstery cover and filling materials. The following list price upcharge will apply to each surface on which the protective barriers may be applied.

MBB Chair/Recliner Back	\$59 List
MBS Chair/Recliner Seat	\$59 List
MB2B Bariatric Chair/Bariatric Recliner Back	\$89 List
MB2S Bariatric Chair/Bariatric Recliner Seat	\$89 List
MB3B Loveseat Back	\$119 List
MB3S Loveseat Seat	\$119 List
MB4B Sofa/Sleep Sofa Back	\$179 List
MB4S Sofa/Sleep Sofa Seat	\$179 List
MB5B Sleep Chair Back	\$59 List
MB5SE Sleep Chair Seat and Extensions	\$179 List (per seat)

The chart below represents a patterned fabric being selected with a repeat. When a multiple repeat is present, the calculation for the yardage needed is determined by adding the vertical and horizontal measurements together and then referring to the chart for the extra yardage required. For example: on a guest chair a 4" vertical repeat and a 5" horizontal repeat requires 18.5% if the pattern is directed across the roll, 23.5% if the pattern is directed up the roll and 28.5% for a 2-Way repeat.

RR
Across the Roll
Railroaded

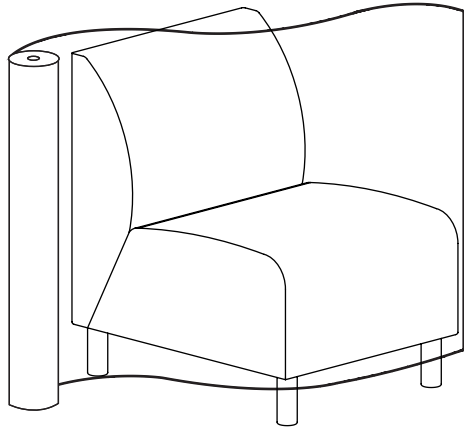

UR
Up the Roll

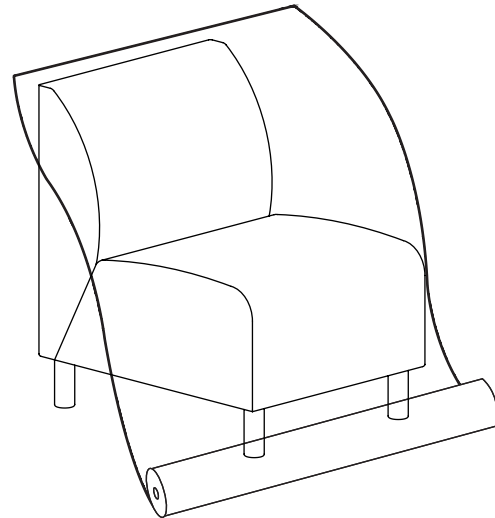

Guest/Visitor and Tandem Seating

Repeat (in inches)	Cut Across The Roll (RR)	Cut Up The Roll (UR)	2-Way
¼" - 3"	Add 7.5%	Add 12.5%	Add 12.5%
3 ¼" - 6"	Add 16.5%	Add 20%	Add 21.5%
6 ¼" - 9"	Add 18.5%	Add 23.5%	Add 28.5%
9 ¼" - 12"	Add 23%	Add 28%	Add 33.5%
12 ¼" - 15"	Add 25%	Add 30%	Add 35%
15 ¼" - 33"	Add 35%	Add 40%	Add 45%

Upholstered Lounge/Tandem Seating and Sleep Chairs/Sleep Sofas

Repeat (in inches)	Cut Across The Roll (RR)	Cut Up The Roll (UR)	2-Way
¼" - 3"	Add 8%	Add 13%	Add 13%
3 ¼" - 6"	Add 17.5%	Add 22.5%	Add 22.5%
6 ¼" - 9"	Add 18.5%	Add 23.5%	Add 26.5%
9 ¼" - 15"	Add 20%	Add 25%	Add 30%
15 ¼" - 21"	Add 30%	Add 35%	Add 40%
21 ¼" - 33"	Add 35%	Add 40%	Add 45%

Recliners/Gliders

Repeat (in inches)	Cut Across The Roll (RR)	Cut Up The Roll (UR)	2-Way
¼" - 3"	Add 9%	Add 14%	Add 14%
3 ¼" - 9"	Add 13.5%	Add 17%	Add 18.5%
9 ¼" - 15"	Add 20%	Add 25%	Add 30%
15 ¼" - 21"	Add 25%	Add 30%	Add 35%
21 ¼" - 33"	Add 30%	Add 35%	Add 40%

COM (Customer's Own Material)

All Knú, LLC seating styles are available in COM. Prices are listed in the column containing the Grade of COM. Yardage requirements are based on non-directional 54" wide (between selvage edges) fabric. All fabrics must be backed with an appropriate type backing. Do not send wall coverings or drapery fabrics. COM material must be shipped from fabric supplier in continuous yardage. Knú, LLC cannot accept individual pieces of the same fabric.

Please complete the COM form and ship form along with the fabric sample for approval prepaid to:

Knú, LLC | DBA / La-Z-Boy Healthcare & Knú Comfort
ATTN: COM Department
P. O. Box 9, One Best Drive
Ferdinand, IN 47532

Once COM fabric has been approved send COM yardage to:

Knú, LLC | DBA / La-Z-Boy Healthcare & Knú Comfort
ATTN: COM Department
1300 North Broad Street, Leland, MS 38756

Please send purchase order to:

Knú, LLC | DBA / La-Z-Boy Healthcare & Knú Comfort
P.O. Box 9, Ferdinand, IN 47532
Fax: 812-367-2493
E-mail: customerservice@getknu.com

Knú, LLC must receive the purchase order prior to receiving the COM yardage. Lead time does not begin until the COM yardage has been received by the COM Department at Leland, MS.

Please attach a sample of your material to the COM form and indicate the direction it is to be applied. Unless otherwise directed, all COM will be applied up the roll with no pattern. Since some fabrics are reversible, please attach the fabric such that the exposed side is facing outward. Knú, LLC does not warrant COM fabrics.

Refer to individual product pages for standard COM yardage requirements. For fabrics with railroads or repeats please refer to the chart on page 15.

When sending in COM to have CAL133 backing added, Knú, LLC will need an additional yardage amount equal to either 5% of the total yardage, or 1 yard, whichever is the greatest.

When COM is accepted, Knú, LLC assumes no responsibility for the appearance, behavior, or durability of the COM. Knú, LLC will inspect all COM fabrics upon receipt at the plant, but will not be held responsible for variations of dye lots, wear, fading, pattern matches, and/or flaws.

COM Form

(Entire form must be filled out.)



COM FORM

Dealer Name:		Fabric Supplier:		
Address:		Pattern Name & Number:	Total Yardage Being Provided:	
City/State/Zip:				
Contact Name:		Pattern Repeat (in inches) <i>*Order will not be processed w/out this information.</i>		
Telephone:		None:	Vertical:	Horizontal:
Dealer Account #:		Purchase Order #:		

Quantity	Model Number	Textile Supplier/Textile Color Name/Number	Finish	Tag

Attach fabric sample below, face side up in the direction it is to be applied to the chair.

*Please Note: COM material must be shipped in continuous yardage from the fabric supplier.
We cannot accept piece mill yardage or individual pieces of the same fabric.

*Fabric must be tagged with the PO# and dealer name.

*Fabric will be applied according to supplier recommendation unless otherwise instructed.

*Add 1 yard or 5% (whichever is the greater of the 2) if CAL133 will be added to COM.

Ship This Form with Sample To:

Knú, LLC
 DBA/La-Z-Boy Contract Furniture
 Attention: COM Department
 P.O. BOX 9
 824 W 23rd Street
 Ferdinand, IN 47532

Send Purchase Order To:

Knú, LLC
 DBA/La-Z-Boy Contract Furniture
 P.O. Box 9
 Ferdinand, IN 47532
 Fax: 812.367.2493
 customerservice@getknu.com

Ship COM/COL Yardage To:

Knú, LLC
 DBA/La-Z-Boy Contract Furniture
 Attention: COM Department
 1300 North Broad Street
 Leland, MS 38756

COF Form

(Entire form must be filled out.)

Dealer Name:**Address:****City/State/Zip:****Contact Name:****Telephone:****Dealer Account #:****Purchase Order #:****Project/End User:**

Quantity	Model Number	Finish Supplier/Finish Color Name/Number	Wood Species	Tag

*Attach finish sample below.***Ship This Form with Sample To:**

Knú, LLC
 DBA/La-Z-Boy Contract Furniture
 Attention: COF Department
 1300 North Broad Street
 Leland, MS 38756

Send Purchase Order To:

Knú, LLC
 DBA/La-Z-Boy Contract Furniture
 P.O. Box 9
 Ferdinand, IN 47532
 Fax: 812.367.2493
 customerservice@getknu.com

Frame Index

<i>Collection Name</i>	<i>Pewter {540}</i>	<i>Silver Frost {211}</i>	<i>Wood {Any Color}</i>
Koncert Metal Visitor	✘	✘	
Koncert Wood Visitor			✘
Koncert Metal Lounge	✘	✘	
Kadia Mod Visitor	✘	✘	

Arm Cap Index

<i>Arm Cap</i>	<i>Collection Availability</i>
Black Urethane	All Models Showing Urethane Arm Caps
Carbon Urethane	EV, Rêma, Konzert, Kadia, Kure, Max, Dalton, Assymble, Max, Oxley
Taupe Urethane	EV, Rêma, Konzert, Kadia, Kure, Max, Dalton, Assymble, Max, Oxley
Titanium Urethane	EV, Rêma, Konzert, Kadia, Kure, Max, Dalton, Assymble, Max, Oxley
Corian® Solid Surface	EV, Rêma, Konzert Recliners, Konzert Upholstered Lounge, Kadia, Max, Oxley, Dalton, Assymble
Wood {any color}	All Models Showing Wood Arm Caps

GUEST | VISITOR | TANDEM SEATING COLLECTIONS

▪ Kadia Mod by Knú Comfort®	22
▪ Koncert Metal by Knú Comfort®	31
▪ Koncert Wood by Knú Comfort®	40
▪ K-Series Ottoman by Knú Comfort®	29,38

Kadia Mod Visitor Seating

Standard Product Information

- Passive Flex Back
- Clean-out between Seat and Back
- High Quality Comfort Webbing in Guest Seats
- 16 Gauge Steel Frame
- Molded Seat Foam
- 1.7 Density Back Foam TB117-2013
- Heavy Steel Rails Connect Arms and Seats
- Field Replaceable Components
- Wall-Saver Leg Design
- Adjustable Glides

Dimensions

- | | |
|-------------------------------|---------|
| ▪ Width (Guest) | 24.5" |
| ▪ Width (Bariatric) | 33.5" |
| ▪ Depth | 31" |
| ▪ Height | 34" |
| ▪ Seat Width (Guest) | 20.75" |
| ▪ Seat Width (Bariatric) | 29.5" |
| ▪ Weight Capacity (Guest) | 550 lbs |
| ▪ Weight Capacity (Bariatric) | 750 lbs |



Featuring a Modified Arm Design

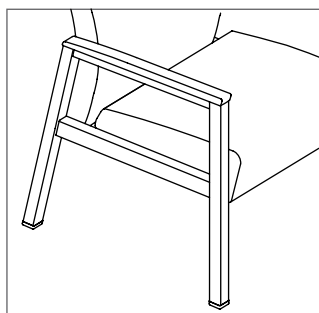

Wood and Urethane Arm Cap Finishes

Please refer to page 14.

Powder Coat Frame Finishes

Standard color is 540 Pewter. 211 Silver Frost is also available upon request. For other metal powder coat finishes, please contact Customer Service at customerservice@getknu.com.

Solid Surface Arm Cap Options

Solid Surface Arm Cap finishes and groups listed on page 14. Please contact Customer Service for pricing and availability of non-standard colors.

CAL TB133

Please refer to page 12.

Moisture Barrier Options

Please refer to page 14.

TO ORDER, SPECIFY

- 1. Model Number 3. Finish
- 2. Textile 4. Options

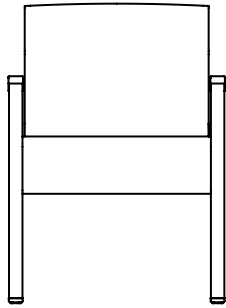

KAM10 - GUEST CHAIR WITH ARM CAPS

DIMENSIONS

Width	24.5	Seat Width	20.75	Back Height	15
Depth	29.5	Seat Depth	19.5	Arm Height	25.5
Height	33.25	Seat Height	18.25	Weight	45
COM	2 YDS				

PRICING WITH URETHANE ARM CAPS - KAM10U

COM	4	5	6	7	8	9	10	11
1359	1379	1429	1459	1529	1589	1629	1699	1869

PRICING WITH WOOD ARM CAPS - KAM10W

COM	4	5	6	7	8	9	10	11
1359	1379	1429	1459	1529	1589	1629	1699	1869

PRICING WITH SOLID SURFACE ARM CAPS - KAM10J

COM	4	5	6	7	8	9	10	11
1919	1939	1999	2029	2089	2149	2199	2269	2429

**For above model with solid surface arm caps, add \$100 List for Group 2 solid surface finish*

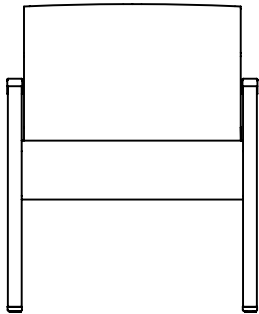
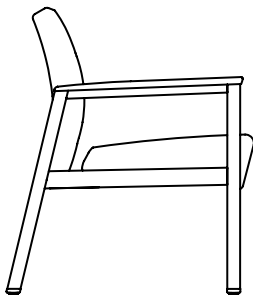

KAM12 - GUEST CHAIR WITH ARM CAPS - 24" Seat

DIMENSIONS

Width	27.25	Seat Width	24	Back Height	15
Depth	29.5	Seat Depth	19.5	Arm Height	25.5
Height	33.25	Seat Height	18.25	Weight	50
COM	2 YDS				

PRICING WITH URETHANE ARM CAPS - KAM12U

COM	4	5	6	7	8	9	10	11
1449	1469	1529	1559	1609	1669	1709	1779	1929

PRICING WITH WOOD ARM CAPS - KAM12W

COM	4	5	6	7	8	9	10	11
1449	1469	1529	1559	1609	1669	1709	1779	1929

PRICING WITH SOLID SURFACE ARM CAPS - KAM12J

COM	4	5	6	7	8	9	10	11
1989	2019	2069	2099	2149	2219	2259	2319	2479

**For above model with solid surface arm caps, add \$100 List for Group 2 solid surface finish*

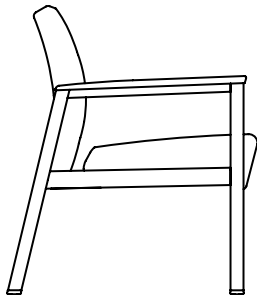

TO ORDER, SPECIFY

- 1. Model Number
- 2. Textile
- 3. Finish
- 4. Options

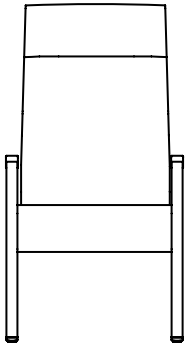

KAM10H - HIGH BACK GUEST CHAIR WITH ARM CAPS

DIMENSIONS

Width	24.5	Seat Width	20.75	Back Height	26.75
Depth	29.5	Seat Depth	19	Arm Height	25.5
Height	45.5	Seat Height	18.25	Weight	50
COM	2 YDS				

PRICING WITH URETHANE ARM CAPS - KAM10HU

COM	4	5	6	7	8	9	10	11
1589	1599	1639	1669	1749	1809	1849	1919	2089

PRICING WITH WOOD ARM CAPS - KAM10HW

COM	4	5	6	7	8	9	10	11
1589	1599	1639	1669	1749	1809	1849	1919	2089

PRICING WITH SOLID SURFACE ARM CAPS - KAM10HJ

COM	4	5	6	7	8	9	10	11
2149	2159	2219	2249	2299	2359	2399	2499	2639

**For above model with solid surface arm caps, add \$100 List for Group 2 solid surface finish*

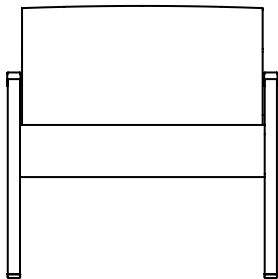
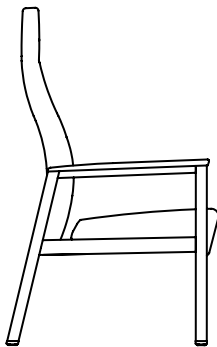

KAM10B - BARIATRIC GUEST CHAIR WITH ARM CAPS

DIMENSIONS

Width	33.5	Seat Width	29.5	Back Height	15
Depth	29.5	Seat Depth	19.5	Arm Height	25.5
Height	33.25	Seat Height	18.25	Weight	65
COM	3 YDS				

PRICING WITH URETHANE ARM CAPS - KAM10BU

COM	4	5	6	7	8	9	10	11
1629	1659	1749	1819	1879	1999	2079	2169	2349

PRICING WITH WOOD ARM CAPS - KAM10BW

COM	4	5	6	7	8	9	10	11
1629	1659	1749	1819	1879	1999	2079	2169	2349

PRICING WITH SOLID SURFACE ARM CAPS - KAM10BJ

COM	4	5	6	7	8	9	10	11
2229	2259	2309	2379	2469	2559	2659	2739	2919

**For above model with solid surface arm caps, add \$100 List for Group 2 solid surface finish*

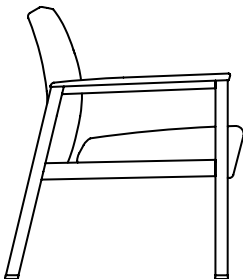

TO ORDER, SPECIFY

- 1. Model Number 3. Finish
- 2. Textile 4. Options

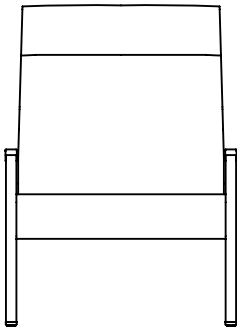

KAM10BH - BARIATRIC HIGH BACK GUEST CHAIR WITH ARM CAPS

DIMENSIONS

Width	33.5	Seat Width	29.5	Back Height	26.75
Depth	29.5	Seat Depth	19	Arm Height	25.5
Height	33.25	Seat Height	18.25	Weight	72
COM	3.5 YDS				

PRICING WITH URETHANE ARM CAPS - KAM10BHU

COM	4	5	6	7	8	9	10	11
2049	2169	2279	2369	2449	2579	2719	2829	3049

PRICING WITH WOOD ARM CAPS - KAM10BHW

COM	4	5	6	7	8	9	10	11
2049	2169	2279	2369	2449	2579	2719	2829	3049

PRICING WITH SOLID SURFACE ARM CAPS - KAM10BHJ

COM	4	5	6	7	8	9	10	11
2629	2759	2839	2959	3009	3169	3279	3439	3609

**For above model with solid surface arm caps, add \$100 List for Group 2 solid surface finish*

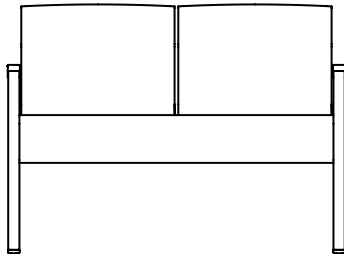
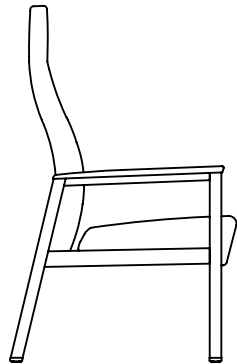

KAM20 - 2 SEAT GUEST CHAIR WITH ARM CAPS

DIMENSIONS

Width	45.5	Seat Width	42	Back Height	15
Depth	29.5	Seat Depth	19.5	Arm Height	25.5
Height	33.25	Seat Height	18.25	Weight	79
COM	3 YDS				

PRICING WITH URETHANE ARM CAPS - KAM20U

COM	4	5	6	7	8	9	10	11
2169	2229	2299	2369	2459	2569	2679	2759	2919

PRICING WITH WOOD ARM CAPS - KAM20W

COM	4	5	6	7	8	9	10	11
2169	2229	2299	2369	2459	2569	2679	2759	2919

PRICING WITH SOLID SURFACE ARM CAPS - KAM20J

COM	4	5	6	7	8	9	10	11
2769	2809	2859	2959	3019	3159	3239	3309	3459

**For above model with solid surface arm caps, add \$100 List for Group 2 solid surface finish*

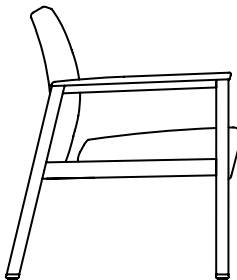

TO ORDER, SPECIFY

- 1. Model Number
- 2. Textile
- 3. Finish
- 4. Options

KAM20I - 2 SEAT GUEST CHAIR WITH ARM CAPS, INTERVENING ARM

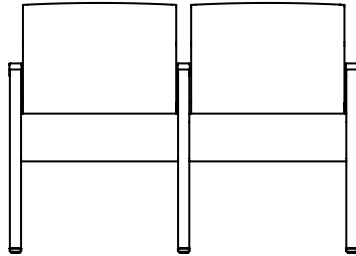

DIMENSIONS

Width	47	Seat Width	20.75	Back Height	15
Depth	29.5	Seat Depth	19.5	Arm Height	25.5
Height	33.25	Seat Height	18.25	Weight	82
COM	3 YDS				

PRICING WITH URETHANE ARM CAPS - KAM20IU

COM	4	5	6	7	8	9	10	11
2459	2499	2569	2629	2749	2829	2959	3029	3249

PRICING WITH WOOD ARM CAPS - KAM20IW

COM	4	5	6	7	8	9	10	11
2459	2499	2569	2629	2749	2829	2959	3029	3249

PRICING WITH SOLID SURFACE ARM CAPS - KAM20IJ

COM	4	5	6	7	8	9	10	11
3319	3379	3439	3499	3619	3699	3819	3879	4089

**For above model with solid surface arm caps, add \$150 List for Group 2 solid surface finish*

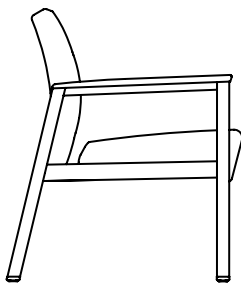

KAM20IBL - 2 SEAT GUEST CHAIR WITH ARM CAPS, 29.5" LEFT FACING BARIATRIC, INTERVENING ARM

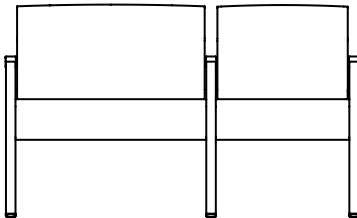

DIMENSIONS

Width	58	Seat Width	29.5	Back Height	15
Depth	29.5	Seat Depth	19.5	Arm Height	25.5
Height	33.25	Seat Height	18.25	Weight	87
COM	3.5 YDS				

PRICING WITH URETHANE ARM CAPS - KAM20IBLU

COM	4	5	6	7	8	9	10	11
2799	2819	2919	2999	3089	3219	3379	3469	3669

PRICING WITH WOOD ARM CAPS - KAM20IBLW

COM	4	5	6	7	8	9	10	11
2799	2819	2919	2999	3089	3219	3379	3469	3669

PRICING WITH SOLID SURFACE ARM CAPS - KAM20IBLJ

COM	4	5	6	7	8	9	10	11
3679	3699	3759	3869	3959	4089	4219	4319	4499

**For above model with solid surface arm caps, add \$150 List for Group 2 solid surface finish*

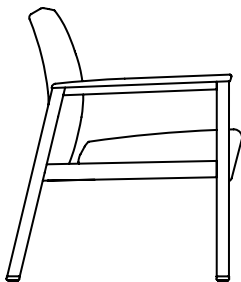

TO ORDER, SPECIFY

- 1. Model Number 3. Finish
- 2. Textile 4. Options

KAM20IBR - 2 SEAT GUEST CHAIR WITH ARM CAPS, 29.5" RIGHT FACING BARIATRIC, INTERVENING ARM

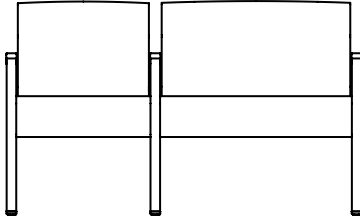

DIMENSIONS

Width	58	Seat Width	29.5	Back Height	15
Depth	29.5	Seat Depth	19.5	Arm Height	25.5
Height	33.25	Seat Height	18.25	Weight	87
COM	3.5 YDS				

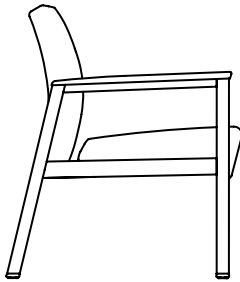

PRICING WITH URETHANE ARM CAPS - KAM20IBRU

COM	4	5	6	7	8	9	10	11
2799	2819	2919	2999	3089	3219	3379	3469	3669

PRICING WITH WOOD ARM CAPS - KAM20IBRW

COM	4	5	6	7	8	9	10	11
2799	2819	2919	2999	3089	3219	3379	3469	3669

PRICING WITH SOLID SURFACE ARM CAPS - KAM20IBRJ

COM	4	5	6	7	8	9	10	11
3679	3699	3759	3869	3959	4089	4219	4319	4499

**For above model with solid surface arm caps, add \$150 List for Group 2 solid surface finish*

KAM30I - 3 SEAT GUEST CHAIR WITH ARM CAPS, INTERVENING ARM

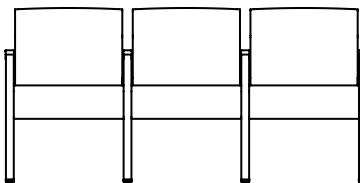

DIMENSIONS

Width	69.5	Seat Width	20.75	Back Height	15
Depth	29.5	Seat Depth	19.5	Arm Height	25.5
Height	33.25	Seat Height	18.25	Weight	120
COM	4.5 YDS				

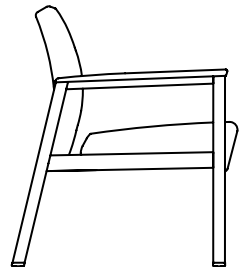

PRICING WITH URETHANE ARM CAPS - KAM30IU

COM	4	5	6	7	8	9	10	11
3289	3329	3469	3549	3689	3869	4079	4139	4439

PRICING WITH WOOD ARM CAPS - KAM30IW

COM	4	5	6	7	8	9	10	11
3289	3329	3469	3549	3689	3869	4079	4139	4439

PRICING WITH SOLID SURFACE ARM CAPS - KAM30IJ

COM	4	5	6	7	8	9	10	11
4459	4499	4619	4699	4839	5019	5219	5269	5549

**For above model with solid surface arm caps, add \$200 List for Group 2 solid surface finish*

TO ORDER, SPECIFY

- 1. Model Number
- 2. Textile
- 3. Finish
- 4. Options

KAM30IBC - 3 SEAT GUEST CHAIR WITH ARM CAPS, 29.5" CENTER BARIATRIC, INTERVENING ARM

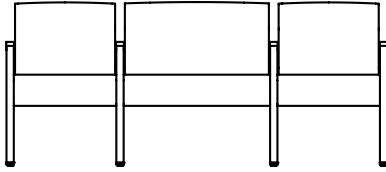

DIMENSIONS

Width	80.5	Seat Width	29.5	Back Height	15
Depth	29.5	Seat Depth	19.5	Arm Height	25.5
Height	33.25	Seat Height	18.25	Weight	127
COM	4.5 YDS				

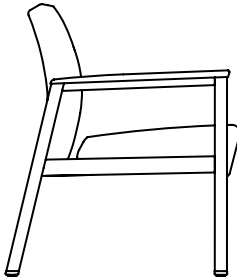

PRICING WITH URETHANE ARM CAPS - KAM30IBCU

COM	4	5	6	7	8	9	10	11
3809	3869	3999	4129	4329	4509	4649	4799	4879

PRICING WITH WOOD ARM CAPS - KAM30IBCW

COM	4	5	6	7	8	9	10	11
3809	3869	3999	4129	4329	4509	4649	4799	4879

PRICING WITH SOLID SURFACE ARM CAPS - KAM30IBCJ

COM	4	5	6	7	8	9	10	11
4999	5029	5149	5279	5479	5659	5799	5909	5989

**For above model with solid surface arm caps, add \$200 List for Group 2 solid surface finish*

KAM30IBL - 3 SEAT GUEST CHAIR WITH ARM CAPS, 29.5" LEFT FACING BARIATRIC, INTERVENING ARM

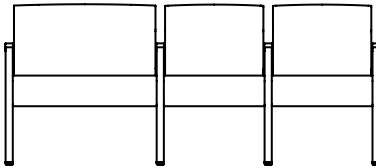

DIMENSIONS

Width	80.5	Seat Width	29.5	Back Height	15
Depth	29.5	Seat Depth	19.5	Arm Height	25.5
Height	33.25	Seat Height	18.25	Weight	127
COM	4.5 YDS				

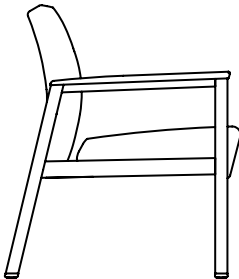

PRICING WITH URETHANE ARM CAPS - KAM30IBLU

COM	4	5	6	7	8	9	10	11
3809	3869	3999	4129	4329	4509	4649	4799	4879

PRICING WITH WOOD ARM CAPS - KAM30IBLW

COM	4	5	6	7	8	9	10	11
3809	3869	3999	4129	4329	4509	4649	4799	4879

PRICING WITH SOLID SURFACE ARM CAPS - KAM30IBLJ

COM	4	5	6	7	8	9	10	11
4999	5029	5149	5279	5479	5659	5799	5909	5989

**For above model with solid surface arm caps, add \$200 List for Group 2 solid surface finish*

TO ORDER, SPECIFY

- 1. Model Number 3. Finish
- 2. Textile 4. Options

KAM30IBR - 3 SEAT GUEST CHAIR WITH ARM CAPS, 29.5" RIGHT FACING BARIATRIC, INTERVENING ARM

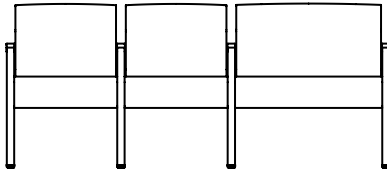

DIMENSIONS

Width	80.5	Seat Width	29.5	Back Height	15
Depth	29.5	Seat Depth	19.5	Arm Height	25.5
Height	33.25	Seat Height	18.25	Weight	127
COM	4.5 YDS				

PRICING WITH URETHANE ARM CAPS - KAM30IBRU

COM	4	5	6	7	8	9	10	11
3809	3869	3999	4129	4329	4509	4649	4799	4879

PRICING WITH WOOD ARM CAPS - KAM30IBRW

COM	4	5	6	7	8	9	10	11
3809	3869	3999	4129	4329	4509	4649	4799	4879

PRICING WITH SOLID SURFACE ARM CAPS - KAM30IBRJ

COM	4	5	6	7	8	9	10	11
4999	5029	5149	5279	5479	5659	5799	5909	5989

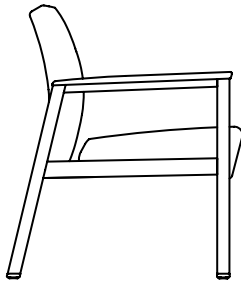

**For above model with solid surface arm caps, add \$200 List for Group 2 solid surface finish*

KOT00 - OTTOMAN

COM IS IN YARDS

COM	4	5	6	7	8	9	10	11
879	889	929	959	989	1059	1109	1139	1159

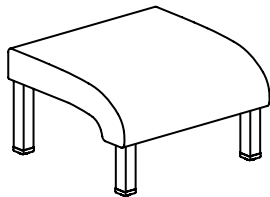

<i>W</i>	<i>D</i>	<i>H</i>	<i>Weight</i>	<i>COM</i>
19	18.5	12	12.1	1

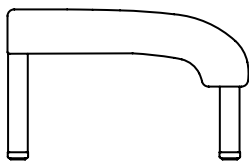

TO ORDER, SPECIFY

- 1. Model Number 3. Finish
- 2. Textile 4. Options

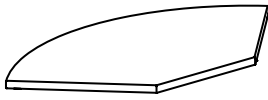

KTC07 - CORNER GANGING TABLE

DIMENSIONS

Width	37	Depth	16	Height	15
Weight	32				

LIST PRICE - 1089

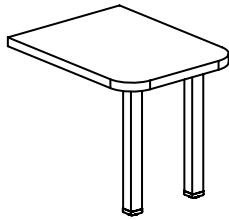

KTE07L - LEFT END GANGING TABLE (FACING)

DIMENSIONS

Width	15.5	Depth	20	Height	15
Weight	19				

LIST PRICE - 879

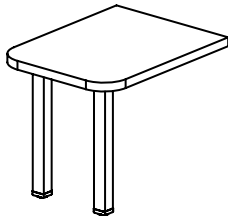

KTE07R - RIGHT END GANGING TABLE (FACING)

DIMENSIONS

Width	15.5	Depth	20	Height	15
Weight	19				

LIST PRICE - 879

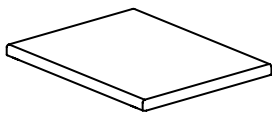

KTI07 - INTERVENING GANGING TABLE

DIMENSIONS

Width	15.5	Depth	20	Height	15
Weight	17				

LIST PRICE - 749

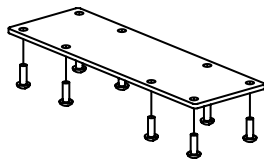

GANG BRKT KOT - GANGING BRACKET (TO GANG CHAIRS TOGETHER)

DIMENSIONS

Width	11	Depth	.25	Height	3.5
Weight	2				

LIST PRICE - 79



PT - TABLE UNDERMOUNT POWER

DIMENSIONS

Width	9	Depth	1.85	Height	2.25
-------	---	-------	------	--------	------

LIST PRICE - 259

Koncert Metal Visitor Seating

Standard Product Information

- Passive Flex Back
- Clean-Out Between Seat and Back
- High Quality Comfort Webbing in Guest Seats
- 16 Gauge Steel Frame
- Molded Seat Foam
- 1.7 Density Back Foam TB117-2013
- Heavy Steel Rails Connect Arms and Seats
- Field Replaceable Components
- Wall-Saver Leg Design
- Adjustable Glides

Dimensions

▪ Width (Guest)	24.5"
▪ Width (Bariatric)	33.5"
▪ Depth	29.5"
▪ Height	33.25"
▪ Seat Width (Guest)	20.75"
▪ Seat Width (Bariatric)	29.5"
▪ Weight Capacity (Guest)	550 lbs
▪ Weight Capacity (Bariatric)	750 lbs



Wood and Urethane Arm Cap Finishes

Please refer to page 14.

CAL TB133

Please refer to page 12.

Moisture Barrier Options

Please refer to page 14.

Powder Coat Finish Options

Standard color is 540 Pewter. 211 Silver Frost is also available upon request. For other metal powder coat finishes, please contact Customer Service at customerservice@getknu.com.



TO ORDER, SPECIFY

- 1. Model Number
- 2. Textile
- 3. Finish
- 4. Options

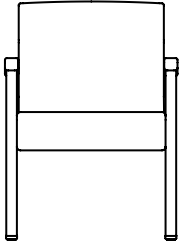

KOT10 - GUEST CHAIR WITH ARM CAPS

DIMENSIONS

Width	24.5	Seat Width	20.75	Back Height	15
Depth	29.5	Seat Depth	19.5	Arm Height	25.75
Height	33.25	Seat Height	18.25	Weight	56
COM	2 YDS				

PRICING WITH URETHANE ARM CAPS - KOT10U

COM	4	5	6	7	8	9	10	11
1359	1379	1429	1459	1529	1589	1629	1699	1869

PRICING WITH WOOD ARM CAPS - KOT10W

COM	4	5	6	7	8	9	10	11
1359	1379	1429	1459	1529	1589	1629	1699	1869

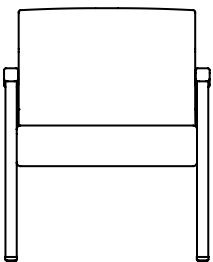
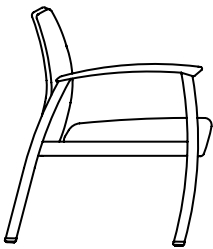

KOT12 - GUEST CHAIR WITH ARM CAPS - 24" Seat

DIMENSIONS

Width	27.25	Seat Width	24	Back Height	15
Depth	29.5	Seat Depth	19.5	Arm Height	25.75
Height	33.25	Seat Height	18.25	Weight	61
COM	2 YDS				

PRICING WITH URETHANE ARM CAPS - KOT12U

COM	4	5	6	7	8	9	10	11
1449	1469	1529	1559	1609	1669	1709	1779	1929

PRICING WITH WOOD ARM CAPS - KOT12W

COM	4	5	6	7	8	9	10	11
1449	1469	1529	1559	1609	1669	1709	1779	1929

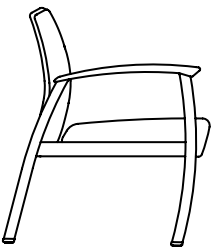

TO ORDER, SPECIFY

- 1. Model Number
- 2. Textile
- 3. Finish
- 4. Options

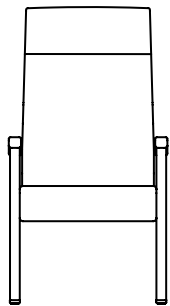

KOT10H - HIGH BACK GUEST CHAIR WITH ARM CAPS

DIMENSIONS

Width	24.5	Seat Width	20.75	Back Height	26.75
Depth	29.5	Seat Depth	19	Arm Height	25.75
Height	45	Seat Height	18.25	Weight	61
COM	2 YDS				

PRICING WITH URETHANE ARM CAPS - KOT10HU

<i>COM</i>	4	5	6	7	8	9	10	11
1589	1599	1639	1669	1749	1809	1849	1919	2089

PRICING WITH WOOD ARM CAPS - KOT10HW

<i>COM</i>	4	5	6	7	8	9	10	11
1589	1599	1639	1669	1749	1809	1849	1919	2089

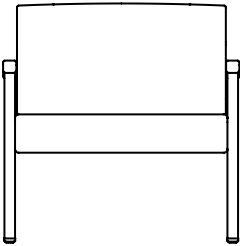
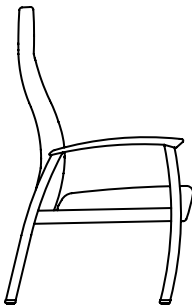

KOT10B - BARIATRIC CHAIR WITH ARM CAPS

DIMENSIONS

Width	33.5	Seat Width	29.5	Back Height	15
Depth	29.5	Seat Depth	19.5	Arm Height	25.75
Height	33.25	Seat Height	18.25	Weight	76
COM	3 YDS				

PRICING WITH URETHANE ARM CAPS - KOT10BU

<i>COM</i>	4	5	6	7	8	9	10	11
1629	1659	1749	1819	1879	1999	2079	2169	2349

PRICING WITH WOOD ARM CAPS - KOT10BW

<i>COM</i>	4	5	6	7	8	9	10	11
1629	1659	1749	1819	1879	1999	2079	2169	2349

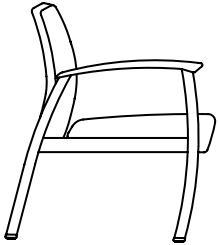

TO ORDER, SPECIFY

- 1. Model Number
- 2. Textile
- 3. Finish
- 4. Options

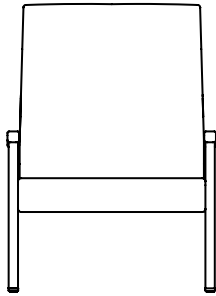

KOT10BH - HIGH BACK BARIATRIC CHAIR WITH ARM CAPS

DIMENSIONS

Width	33.5	Seat Width	29.5	Back Height	26.75
Depth	29.5	Seat Depth	19	Arm Height	25.75
Height	45	Seat Height	18.25	Weight	83
COM	3 YDS				

PRICING WITH URETHANE ARM CAPS - KOT10BHU

COM	4	5	6	7	8	9	10	11
2049	2169	2279	2369	2449	2579	2719	2829	3049

PRICING WITH WOOD ARM CAPS - KOT10BHW

COM	4	5	6	7	8	9	10	11
2049	2169	2279	2369	2449	2579	2719	2829	3049

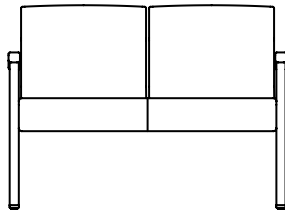
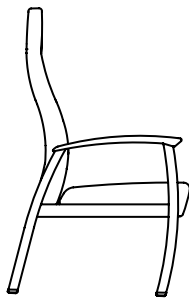

KOT20 - 2 SEAT GUEST CHAIR WITH ARM CAPS

DIMENSIONS

Width	45.5	Seat Width	42	Back Height	15
Depth	29.5	Seat Depth	19.5	Arm Height	25.75
Height	33.25	Seat Height	18.25	Weight	90
COM	3 YDS				

PRICING WITH URETHANE ARM CAPS - KOT20U

COM	4	5	6	7	8	9	10	11
2169	2229	2299	2369	2459	2569	2679	2759	2919

PRICING WITH WOOD ARM CAPS - KOT20W

COM	4	5	6	7	8	9	10	11
2169	2229	2299	2369	2459	2569	2679	2759	2919

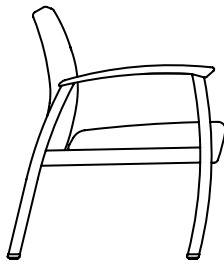

TO ORDER, SPECIFY

- 1. Model Number
- 2. Textile
- 3. Finish
- 4. Options

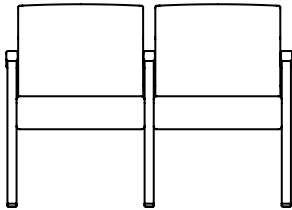

KOT20I - 2 SEAT GUEST CHAIR WITH INTERVENING ARM, ARM CAPS

DIMENSIONS

Width	47	Seat Width	20.75	Back Height	15
Depth	29.5	Seat Depth	19.5	Arm Height	25.75
Height	33.25	Seat Height	18.25	Weight	101
COM	3 YDS				

PRICING WITH URETHANE ARM CAPS - KOT20IU

COM	4	5	6	7	8	9	10	11
2459	2499	2569	2629	2749	2829	2959	3029	3249

PRICING WITH WOOD ARM CAPS - KOT20IW

COM	4	5	6	7	8	9	10	11
2459	2499	2569	2629	2749	2829	2959	3029	3249

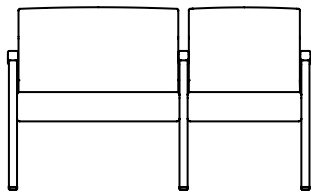
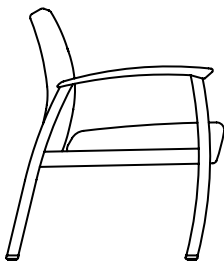

KOT20IBL - 2 SEAT 29.5" LEFT (FACING) BARIATRIC CHAIR WITH INTERVENING ARM, ARM CAPS

DIMENSIONS

Width	58	Seat Width	29.5	Back Height	15
Depth	29.5	Seat Depth	19.5	Arm Height	25.75
Height	33.25	Seat Height	18.25	Weight	115
COM	3.5 YDS				

PRICING WITH URETHANE ARM CAPS - KOT20IBLU

COM	4	5	6	7	8	9	10	11
2799	2819	2919	2999	3089	3219	3379	3469	3669

PRICING WITH WOOD ARM CAPS - KOT20IBLW

COM	4	5	6	7	8	9	10	11
2799	2819	2919	2999	3089	3219	3379	3469	3669

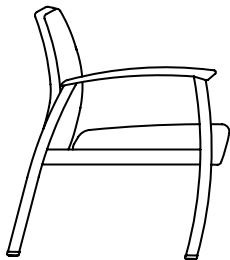

TO ORDER, SPECIFY

- 1. Model Number
- 2. Textile
- 3. Finish
- 4. Options

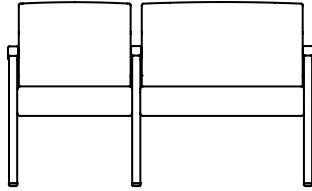

KOT20IBR - 2 SEAT 29.5" RIGHT (FACING) BARIATRIC WITH INTERVENING ARM, ARM CAPS

DIMENSIONS

Width	58	Seat Width	29.5	Back Height	15
Depth	29.5	Seat Depth	19.5	Arm Height	25.75
Height	33.25	Seat Height	18.25	Weight	115
COM	3.5 YDS				

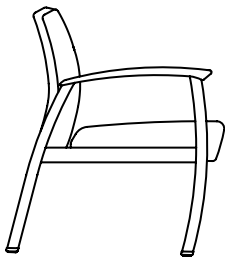

PRICING WITH URETHANE ARM CAPS - KOT20IBRU

COM	4	5	6	7	8	9	10	11
2799	2819	2919	2999	3089	3219	3379	3469	3669

PRICING WITH WOOD ARM CAPS - KOT20IBRW

COM	4	5	6	7	8	9	10	11
2799	2819	2919	2999	3089	3219	3379	3469	3669

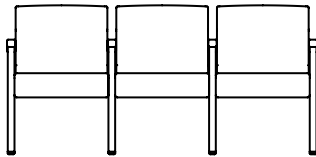

KOT30I - 3 SEAT GUEST CHAIR WITH INTERVENING ARMS, ARM CAPS

DIMENSIONS

Width	69.5	Seat Width	20.75	Back Height	15
Depth	29.5	Seat Depth	19.5	Arm Height	25.75
Height	33.25	Seat Height	18.25	Weight	141
COM	4.5 YDS				

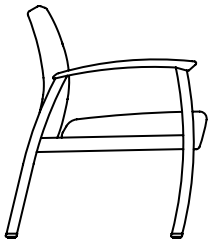

PRICING WITH URETHANE ARM CAPS - KOT30IU

COM	4	5	6	7	8	9	10	11
3289	3329	3469	3549	3689	3869	4079	4139	4439

PRICING WITH WOOD ARM CAPS - KOT30IW

COM	4	5	6	7	8	9	10	11
3289	3329	3469	3549	3689	3869	4079	4139	4439

TO ORDER, SPECIFY

- 1. Model Number
- 2. Textile
- 3. Finish
- 4. Options

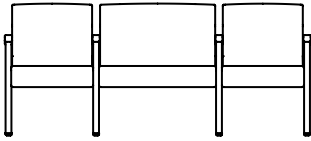

KOT30IBC - 3 SEAT 29.5" CENTER BARIATRIC WITH INTERVENING ARMS, ARM CAPS

DIMENSIONS

Width	80.5	Seat Width	29.5	Back Height	15
Depth	29.5	Seat Depth	19.5	Arm Height	25.75
Height	33.25	Seat Height	18.25	Weight	154
COM	4.5 YDS				

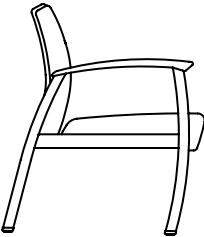

PRICING WITH URETHANE ARM CAPS - KOT30IBCU

<i>COM</i>	4	5	6	7	8	9	10	11
3809	3869	3999	4129	4329	4509	4649	4799	4879

PRICING WITH WOOD ARM CAPS - KOT30IBCW

<i>COM</i>	4	5	6	7	8	9	10	11
3809	3869	3999	4129	4329	4509	4649	4799	4879

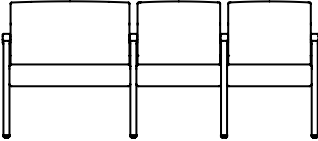

KOT30IBL - 3 SEAT 29.5" LEFT (FACING) BARIATRIC WITH INTERVENING ARMS, ARM CAPS

DIMENSIONS

Width	80.5	Seat Width	29.5	Back Height	15
Depth	29.5	Seat Depth	19.5	Arm Height	25.75
Height	33.25	Seat Height	18.25	Weight	154
COM	4.5 YDS				

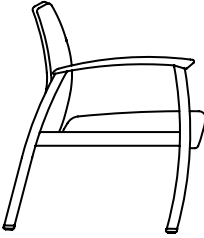

PRICING WITH URETHANE ARM CAPS - KOT30IBLU

<i>COM</i>	4	5	6	7	8	9	10	11
3809	3869	3999	4129	4329	4509	4649	4799	4879

PRICING WITH WOOD ARM CAPS - KOT30IBLW

<i>COM</i>	4	5	6	7	8	9	10	11
3809	3869	3999	4129	4329	4509	4649	4799	4879

TO ORDER, SPECIFY

- 1. Model Number
- 2. Textile
- 3. Finish
- 4. Options

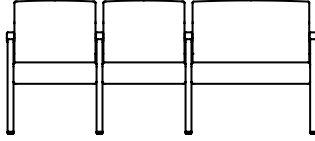

KOT30IBR - 3 SEAT 29.5" RIGHT (FACING) BARIATRIC WITH INTERVENING ARMS, ARM CAPS

DIMENSIONS

Width	80.5	Seat Width	29.5	Back Height	15
Depth	29.5	Seat Depth	19.5	Arm Height	25.75
Height	33.25	Seat Height	18.25	Weight	154
COM	4.5 YDS				

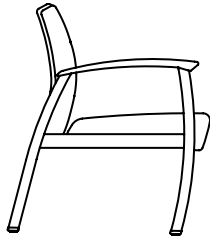

PRICING WITH URETHANE ARM CAPS - KOT30IBRU

<i>COM</i>	4	5	6	7	8	9	10	11
3809	3869	3999	4129	4329	4509	4649	4799	4879

PRICING WITH WOOD ARM CAPS - KOT30IBRW

<i>COM</i>	4	5	6	7	8	9	10	11
3809	3869	3999	4129	4329	4509	4649	4799	4879

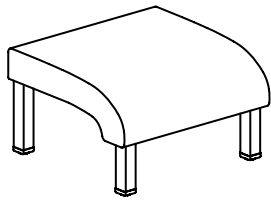

KOT00 - OTTOMAN

COM IS IN YARDS

<i>COM</i>	4	5	6	7	8	9	10	11
879	889	929	959	989	1059	1109	1139	1159

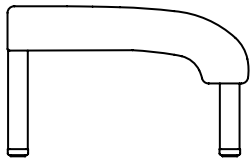

<i>W</i>	<i>D</i>	<i>H</i>	<i>Weight</i>	<i>COM</i>
19	18.5	12	12.1	1

TO ORDER, SPECIFY

- 1. Model Number 3. Finish
- 2. Textile 4. Options

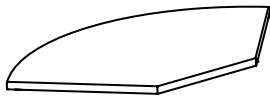

KTC07 - CORNER GANGING TABLE - THERMOFOIL

DIMENSIONS

Width 37 Depth 16 Height 15 Weight 32
LIST PRICE - 1089

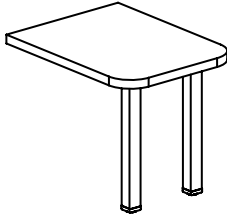

KTE07L - LEFT END GANGING TABLE (FACING) - THERMOFOIL

DIMENSIONS

Width 15.5 Depth 20 Height 15 Weight 19
LIST PRICE - 879

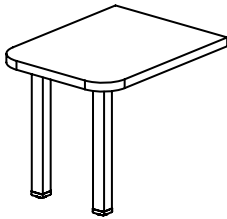

KTE07R - RIGHT END GANGING TABLE (FACING) - THERMOFOIL

DIMENSIONS

Width 15.5 Depth 20 Height 15 Weight 19
LIST PRICE - 879

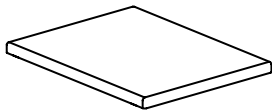

KTI07 - INTERVENING GANGING TABLE - THERMOFOIL

DIMENSIONS

Width 19 Depth 15.5 Height 15 Weight 17
LIST PRICE - 749

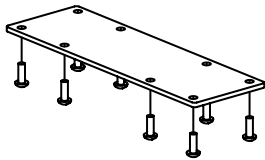

GANG BRKT KOT - GANGING BRACKET (TO GANG CHAIRS TOGETHER)

DIMENSIONS

Width 11 Depth .25 Height 3.5
 Weight 2
LIST PRICE - 79



PT - TABLE UNDERMOUNT POWER

DIMENSIONS

Width 9 Depth 1.85 Height 2.25
LIST PRICE - 259

Koncert Wood Visitor Seating

Standard Product Information

- Passive Flex Back
- Clean-Out Between Seat and Back
- High Quality Comfort Webbing in Guest Seats
- Solid European Beech Frame
- Molded Seat Foam
- 1.7 Density Back Foam TB117-2013
- Heavy Steel Rails Connect Arms and Seats
- Field Replaceable Components
- Wall-Saver Leg Design
- Adjustable Glides
- Mortise and Tenon Joint Construction

Dimensions

▪ Width (Guest)	24.5"
▪ Width (Bariatric)	33.5"
▪ Depth	29.5"
▪ Height	33.25"
▪ Seat Width (Guest)	20.75"
▪ Seat Width (Bariatric)	29.5"
▪ Weight Capacity (Guest)	550 lbs
▪ Weight Capacity (Bariatric)	750 lbs



Wood Frame Finish Options

Please refer to page 14.

Moisture Barrier Options

Please refer to page 14.

CAL TB133

Please refer to page 12.

TO ORDER, SPECIFY

- 1. Model Number 3. Finish
- 2. Textile 4. Options

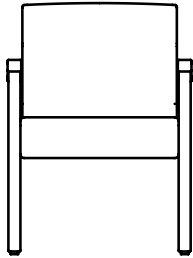

KOW10 - GUEST CHAIR

DIMENSIONS

Width	24.5	Seat Width	20.75	Back Height	15
Depth	29.5	Seat Depth	19.5	Arm Height	25.5
Height	33.25	Seat Height	18.25	Weight	50
COM	2 YDS				

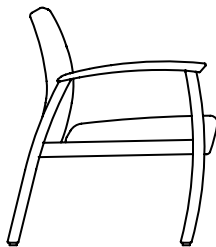

PRICING - KOW10

<i>COM</i>	<i>4</i>	<i>5</i>	<i>6</i>	<i>7</i>	<i>8</i>	<i>9</i>	<i>10</i>	<i>11</i>
1409	1419	1469	1519	1559	1629	1669	1769	1919

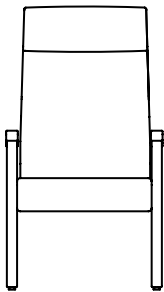

KOW10H - HIGH BACK GUEST CHAIR

DIMENSIONS

Width	24.5	Seat Width	20.75	Back Height	26.25
Depth	29.5	Seat Depth	19	Arm Height	25.5
Height	45	Seat Height	18.25	Weight	55
COM	2 YDS				

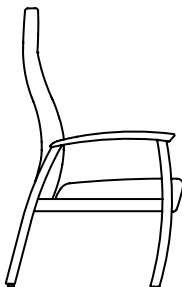

PRICING - KOW10H

<i>COM</i>	<i>4</i>	<i>5</i>	<i>6</i>	<i>7</i>	<i>8</i>	<i>9</i>	<i>10</i>	<i>11</i>
1629	1639	1679	1729	1799	1859	1899	1989	2149

TO ORDER, SPECIFY

- 1. Model Number
- 2. Textile
- 3. Finish
- 4. Options

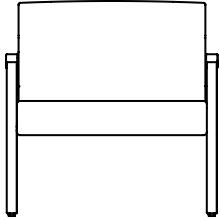

KOW10B - BARIATRIC GUEST CHAIR

DIMENSIONS

Width	33.5	Seat Width	29.5	Back Height	15
Depth	29.5	Seat Depth	19.5	Arm Height	25.5
Height	33.25	Seat Height	18.25	Weight	70
COM	3 YDS				

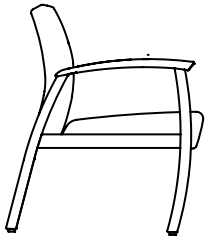

PRICING - KOW10B

COM	4	5	6	7	8	9	10	11
1679	1709	1799	1859	1929	2049	2139	2239	2409

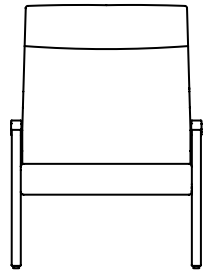

KOW10BH - BARIATRIC HIGH BACK GUEST CHAIR

DIMENSIONS

Width	33.5	Seat Width	29.5	Back Height	26.75
Depth	29.5	Seat Depth	19	Arm Height	25.5
Height	45	Seat Height	18.25	Weight	77
COM	3 YDS				

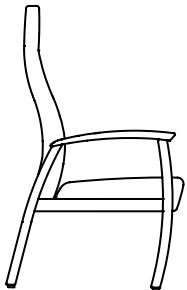

PRICING - KOW10BH

COM	4	5	6	7	8	9	10	11
2099	2259	2329	2459	2509	2679	2789	2979	3149

TO ORDER, SPECIFY

- 1. Model Number 3. Finish
- 2. Textile 4. Options

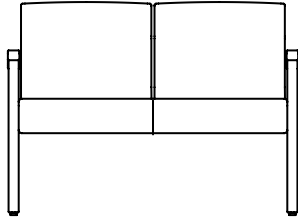

KOW20 - 2 SEAT GUEST CHAIR

DIMENSIONS

Width	45.5	Seat Width	42	Back Height	15
Depth	29.5	Seat Depth	19.5	Arm Height	25.5
Height	33.25	Seat Height	18.25	Weight	82
COM	3 YDS				

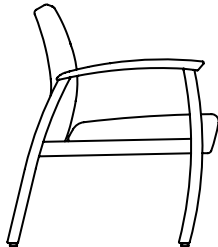

PRICING - KOW20

COM	4	5	6	7	8	9	10	11
2249	2289	2349	2459	2519	2659	2749	2829	2989

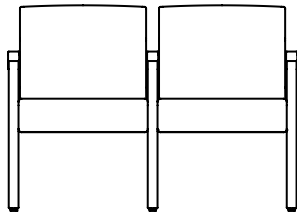

KOW20I - 2 SEAT GUEST CHAIR WITH INTERVENING ARM

DIMENSIONS

Width	47	Seat Width	20.75	Back Height	15
Depth	29.5	Seat Depth	19.5	Arm Height	25.5
Height	33.25	Seat Height	18.25	Weight	95
COM	3 YDS				

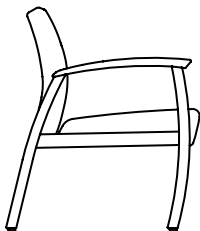

PRICING - KOW20I

COM	4	5	6	7	8	9	10	11
2519	2559	2659	2729	2809	2929	3039	3119	3329

TO ORDER, SPECIFY

- 1. Model Number
- 2. Textile
- 3. Finish
- 4. Options

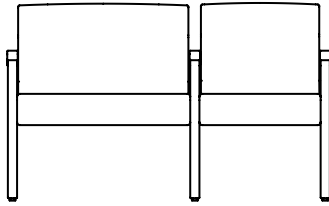

KOW20IBL - 2 SEAT 29.5" LEFT (FACING) BARIATRIC GUEST CHAIR WITH INTERVENING ARM

DIMENSIONS

Width	56.25	Seat Width	20.75	Back Height	15
Depth	29.5	Seat Depth	19.5	Arm Height	25.5
Height	33.25	Seat Height	18.25	Weight	109
COM	3.5 YDS				

PRICING - KOW20IBL

<i>COM</i>	<i>4</i>	<i>5</i>	<i>6</i>	<i>7</i>	<i>8</i>	<i>9</i>	<i>10</i>	<i>11</i>
2859	2889	2999	3069	3199	3299	3459	3559	3929

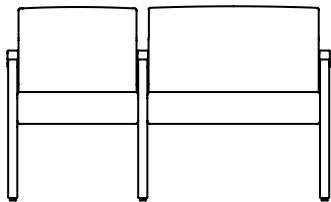
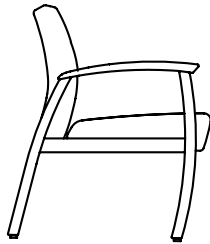

KOW20IBR - 2 SEAT 29.5" RIGHT (FACING) BARIATRIC GUEST CHAIR WITH INTERVENING ARM

DIMENSIONS

Width	56.25	Seat Width	20.75	Back Height	15
Depth	29.5	Seat Depth	19.5	Arm Height	25.5
Height	33.25	Seat Height	18.25	Weight	109
COM	3.5 YDS				

PRICING - KOW20IBR

<i>COM</i>	<i>4</i>	<i>5</i>	<i>6</i>	<i>7</i>	<i>8</i>	<i>9</i>	<i>10</i>	<i>11</i>
2859	2889	2999	3069	3199	3299	3459	3559	3929

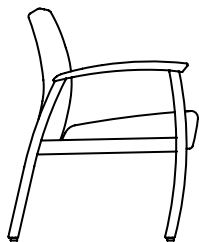

TO ORDER, SPECIFY

- 1. Model Number 3. Finish
- 2. Textile 4. Options

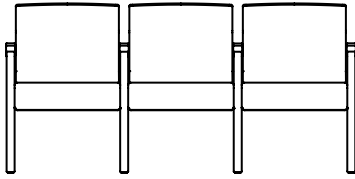

KOW30I - 3 SEAT GUEST CHAIR WITH INTERVENING ARMS

DIMENSIONS

Width	69.5	Seat Width	20.75	Back Height	15
Depth	29.5	Seat Depth	19.5	Arm Height	25.5
Height	33.25	Seat Height	18.25	Weight	129
COM	4.5 YDS				

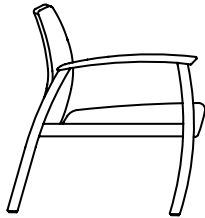

PRICING - KOW30I

<i>COM</i>	4	5	6	7	8	9	10	11
3399	3449	3549	3669	3809	3969	4189	4249	4569

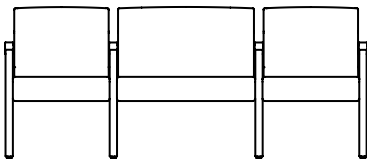

KOW30IBC - 3 SEAT 29.5" CENTER BARIATRIC GUEST CHAIR WITH INTERVENING ARMS

DIMENSIONS

Width	78.25	Seat Width	20.75	Back Height	15
Depth	29.5	Seat Depth	19.5	Arm Height	25.5
Height	33.25	Seat Height	18.25	Weight	148
COM	4.5 YDS				

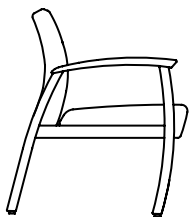

PRICING - KOW30IBC

<i>COM</i>	4	5	6	7	8	9	10	11
3929	3969	4129	4239	4439	4649	4789	4929	5039

TO ORDER, SPECIFY

- 1. Model Number
- 2. Textile
- 3. Finish
- 4. Options

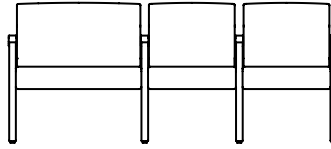

KOW30IBL - 3 SEAT 29.5" LEFT (FACING) BARIATRIC GUEST CHAIR WITH INTERVENING ARMS

DIMENSIONS

Width	78.25	Seat Width	20.75	Back Height	15
Depth	29.5	Seat Depth	19.5	Arm Height	25.5
Height	33.25	Seat Height	18.25	Weight	148
COM	4.5 YDS				

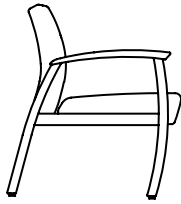

PRICING - KOW30IBL

<i>COM</i>	4	5	6	7	8	9	10	11	
	3929	3969	4129	4239	4439	4649	4789	4929	5039

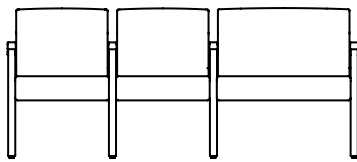

KOW30IBR - 3 SEAT 29.5" RIGHT (FACING) BARIATRIC GUEST CHAIR WITH INTERVENING ARMS

DIMENSIONS

Width	78.25	Seat Width	20.75	Back Height	15
Depth	29.5	Seat Depth	19.5	Arm Height	25.5
Height	33.25	Seat Height	18.25	Weight	148
COM	4.5 YDS				

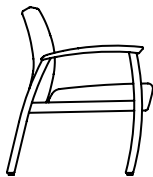

PRICING - KOW30IBR

<i>COM</i>	4	5	6	7	8	9	10	11	
	3929	3969	4129	4239	4439	4649	4789	4929	5039

TO ORDER, SPECIFY

- 1. Model Number 3. Finish
- 2. Textile 4. Options

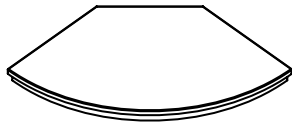

KTC03 - CORNER GANGING TABLE - THERMOFOIL

DIMENSIONS

Width 37 Depth 16 Height 15 Weight 36

LIST PRICE - 1069

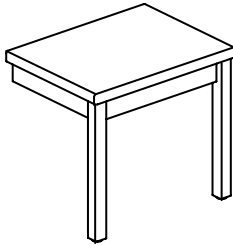

KWE03L - LEFT END GANGING TABLE (FACING) - THERMOFOIL

DIMENSIONS

Width 15.5 Depth 20 Height 15 Weight 20

LIST PRICE - 909

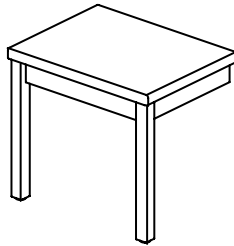

KWE03R - RIGHT END GANGING TABLE (FACING) - THERMOFOIL

DIMENSIONS

Width 15.5 Depth 20 Height 15 Weight 20

LIST PRICE - 909

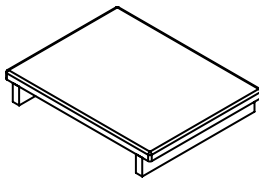

KT103 - INTERVENING GANGING TABLE - THERMOFOIL

DIMENSIONS

Width 15.5 Depth 20 Height 15 Weight 19

LIST PRICE - 739

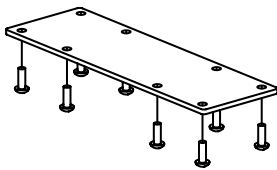

GANG BRKT KOT - GANGING BRACKET (TO GANG CHAIRS TOGETHER)

DIMENSIONS

Width 11 Depth .25 Height 3.5

Weight 2

LIST PRICE - 79

HIP CHAIRS | BEHAVIORAL HEALTH COLLECTIONS

- Koncert Hip Chairs by Knú Comfort®50
- Kadia Mod Hip Chairs by Knú Comfort®51
- Koncert Behavioral Health Chairs by Knú Comfort®52

TO ORDER, SPECIFY

- 1. Model Number
- 2. Textile
- 3. Finish
- 4. Options

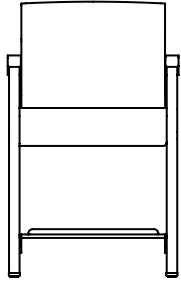

KOT10HIP - HIP CHAIR WITH ARM CAPS

DIMENSIONS

Width	24.5	Seat Width	20.75	Back Height	15
Depth	31	Seat Depth	19.5	Arm Height	31.75
Height	39.25	Seat Height	24.25	Weight	61.5
COM	2 YDS				

PRICING WITH URETHANE ARM CAPS - KOT10HIPU

COM	4	5	6	7	8	9	10	11
1909	1919	1979	2009	2049	2139	2179	2259	2409

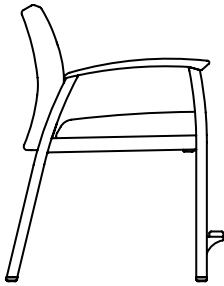

PRICING WITH WOOD ARM CAPS - KOT10HIPW

COM	4	5	6	7	8	9	10	11
1909	1919	1979	2009	2049	2139	2179	2259	2409

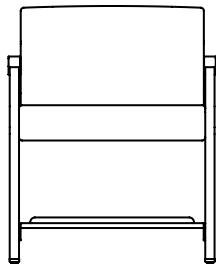

KOT10BHIP - BARIATRIC HIP CHAIR WITH ARM CAPS

DIMENSIONS

Width	33.5	Seat Width	29.5	Back Height	15
Depth	31	Seat Depth	19.5	Arm Height	31.75
Height	39.25	Seat Height	24.25	Weight	81.5
COM	3 YDS				

PRICING WITH URETHANE ARM CAPS - KOT10BHIPU

COM	4	5	6	7	8	9	10	11
2289	2329	2359	2399	2479	2629	2739	2789	2999

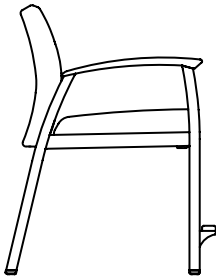

PRICING WITH WOOD ARM CAPS - KOT10BHIPW

COM	4	5	6	7	8	9	10	11
2289	2329	2359	2399	2479	2629	2739	2789	2999

TO ORDER, SPECIFY

- 1. Model Number 3. Finish
- 2. Textile 4. Options

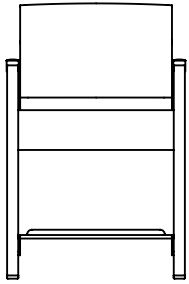

KAM10HIP - HIP CHAIR WITH ARM CAPS

DIMENSIONS

Width	24.5	Seat Width	20.75	Back Height	16
Depth	31	Seat Depth	22	Arm Height	31.5
Height	39.25	Seat Height	22.75	Weight	58
COM	2 YDS				

PRICING WITH URETHANE ARM CAPS - KAM10HIPU

COM	4	5	6	7	8	9	10	11
1909	1919	1979	2009	2049	2139	2179	2259	2409

PRICING WITH WOOD ARM CAPS - KAM10HIPW

COM	4	5	6	7	8	9	10	11
1909	1919	1979	2009	2049	2139	2179	2259	2409

PRICING WITH SOLID SURFACE ARM CAPS - KAM10HIPJ

COM	4	5	6	7	8	9	10	11
2489	2499	2539	2569	2609	2719	2759	2819	2989

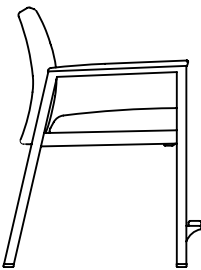

**For above model with solid surface arm caps, add \$100 List for Group 2 solid surface finish*

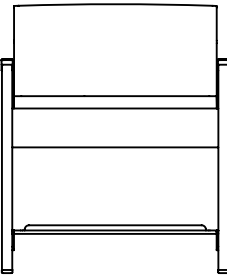

KAM10BHIP - BARIATRIC HIP CHAIR WITH ARM CAPS

DIMENSIONS

Width	33.5	Seat Width	29.5	Back Height	16
Depth	31	Seat Depth	22	Arm Height	31.5
Height	39.25	Seat Height	22.75	Weight	78
COM	3 YDS				

PRICING WITH URETHANE ARM CAPS - KAM10BHIPU

COM	4	5	6	7	8	9	10	11
2289	2329	2359	2399	2479	2629	2739	2789	2999

PRICING WITH WOOD ARM CAPS - KAM10BHIPW

COM	4	5	6	7	8	9	10	11
2289	2329	2359	2399	2479	2629	2739	2789	2999

PRICING WITH SOLID SURFACE ARM CAPS - KAM10BHIPJ

COM	4	5	6	7	8	9	10	11
2849	2909	2939	2979	3039	3209	3299	3359	3559

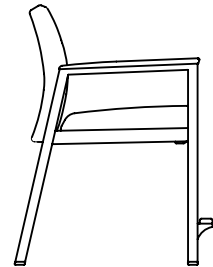

**For above model with solid surface arm caps, add \$100 List for Group 2 solid surface finish*



TO ORDER, SPECIFY

- 1. Model Number
- 2. Textile
- 3. Finish
- 4. Options

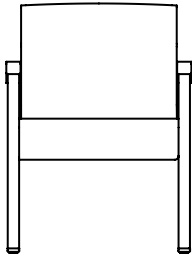

KOT19 - BEHAVIORAL HEALTH CHAIR WITH ARM CAPS

DIMENSIONS

Width	24.5	Seat Width	20.75	Back Height	15
Depth	29.5	Seat Depth	19.5	Arm Height	25.75
Height	33.25	Seat Height	18.25	Weight	62
COM	2 YDS				

PRICING WITH URETHANE ARM CAPS - KOT19U

COM	4	5	6	7	8	9	10	11
1799	1849	1869	1889	1919	1999	2059	2069	2159

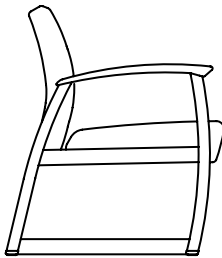

PRICING WITH WOOD ARM CAPS - KOT19W

COM	4	5	6	7	8	9	10	11
1799	1849	1869	1889	1919	1999	2059	2069	2159

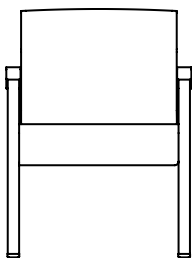

KOT19M - BEHAVIORAL HEALTH CHAIR WITH ARM CAPS, ADDITIONAL WEIGHT

DIMENSIONS

Width	24.5	Seat Width	20.75	Back Height	15
Depth	29.5	Seat Depth	19.5	Arm Height	25.75
Height	33.25	Seat Height	18.25	Weight	96
COM	2 YDS				

PRICING WITH URETHANE ARM CAPS - KOT19UM

COM	4	5	6	7	8	9	10	11
2129	2159	2169	2229	2259	2319	2369	2399	2479

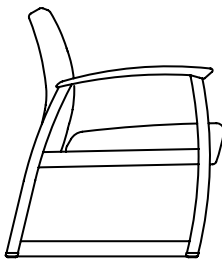

PRICING WITH WOOD ARM CAPS - KOT19WM

COM	4	5	6	7	8	9	10	11
2129	2159	2169	2229	2259	2319	2369	2399	2479

TO ORDER, SPECIFY

- 1. Model Number 3. Finish
- 2. Textile 4. Options

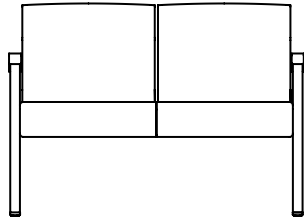

KOT29 - 2 SEAT BEHAVIORAL HEALTH CHAIR WITH ARM CAPS

DIMENSIONS

Width	45.5	Seat Width	42	Back Height	15
Depth	29.5	Seat Depth	19.5	Arm Height	25.75
Height	33.25	Seat Height	18.25	Weight	95
COM	3 YDS				

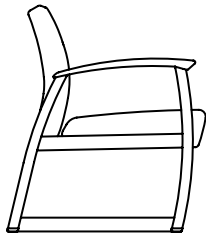

PRICING WITH URETHANE ARM CAPS - KOT29U

COM	4	5	6	7	8	9	10	11
2799	2889	2929	2989	3039	3159	3269	3399	3539

PRICING WITH WOOD ARM CAPS - KOT29W

COM	4	5	6	7	8	9	10	11
2799	2889	2929	2989	3039	3159	3269	3399	3539

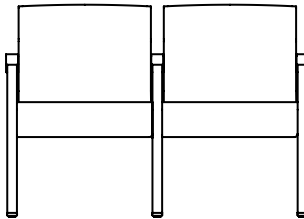

KOT29I - 2 SEAT BEHAVIORAL HEALTH CHAIR WITH INTERVENING ARM, ARM CAPS

DIMENSIONS

Width	47	Seat Width	20.75	Back Height	15
Depth	29.5	Seat Depth	19.5	Arm Height	25.75
Height	33.25	Seat Height	18.25	Weight	110
COM	3 YDS				

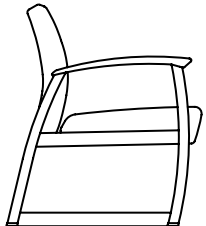

PRICING WITH URETHANE ARM CAPS - KOT29IU

COM	4	5	6	7	8	9	10	11
3349	3449	3469	3609	3689	3779	3919	3999	4169

PRICING WITH WOOD ARM CAPS - KOT29IW

COM	4	5	6	7	8	9	10	11
3349	3449	3469	3609	3689	3779	3919	3999	4169

TO ORDER, SPECIFY

- 1. Model Number
- 2. Textile
- 3. Finish
- 4. Options

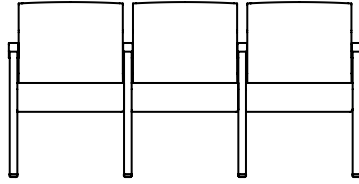

KOT39I - 3 SEAT BEHAVIORAL HEALTH CHAIR WITH INTERVENING ARMS, ARM CAPS

DIMENSIONS

Width	69.5	Seat Width	20.75	Back Height	15
Depth	29.5	Seat Depth	19.5	Arm Height	25.75
Height	33.25	Seat Height	18.25	Weight	159
COM	4.5 YDS				

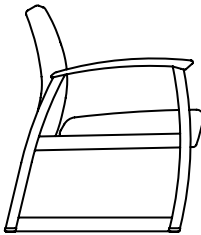

PRICING WITH URETHANE ARM CAPS - KOT39IU

COM	4	5	6	7	8	9	10	11
4599	4829	4869	4899	5039	5199	5379	5489	5749

PRICING WITH WOOD ARM CAPS - KOT39IW

COM	4	5	6	7	8	9	10	11
4599	4829	4869	4899	5039	5199	5379	5489	5749

TO ORDER, SPECIFY

- 1. Model Number
- 2. Textile
- 3. Finish
- 4. Options

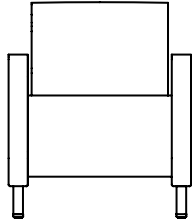

KOU19F - BEHAVIORAL HEALTH LOUNGE CHAIR WITH UPHOLSTERED ARMS

DIMENSIONS

Width	27.25	Seat Width	21.75	Back Height	15.75
Depth	30	Seat Depth	19	Arm Height	25
Height	33.75	Seat Height	18	Weight	88
COM	4 YDS				

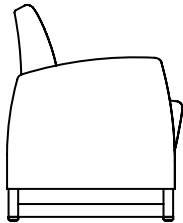

PRICING WITH UPHOLSTERED ARMS - KOU19F

COM	4	5	6	7	8	9	10	11	
	2499	2539	2559	2619	2719	2809	2969	3119	3429

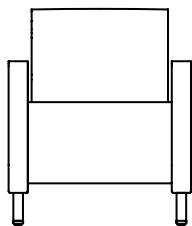

KOU19FM - BEHAVIORAL HEALTH LOUNGE CHAIR WITH UPHOLSTERED ARMS, ADDITIONAL WEIGHT

DIMENSIONS

Width	27.25	Seat Width	21.75	Back Height	15.75
Depth	30	Seat Depth	19	Arm Height	25
Height	33.75	Seat Height	18	Weight	123
COM	4 YDS				

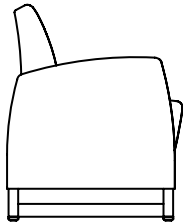

PRICING WITH UPHOLSTERED ARMS - KOU19FM

COM	4	5	6	7	8	9	10	11	
	2829	2859	2889	2949	3019	3129	3269	3429	3729



TO ORDER, SPECIFY

- 1. Model Number
- 2. Textile
- 3. Finish
- 4. Options

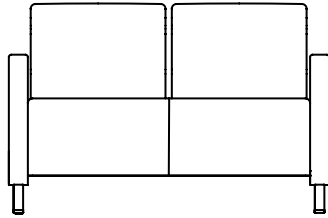

KOU29F - BEHAVIORAL HEALTH LOUNGE LOVESEAT WITH UPHOLSTERED ARMS

DIMENSIONS

Width	49.75	Seat Width	44	Back Height	15.75
Depth	30	Seat Depth	19	Arm Height	25
Height	33.75	Seat Height	18	Weight	126
COM	5.5 YDS				

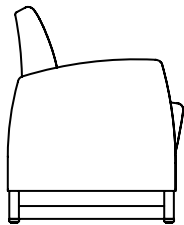

PRICING WITH UPHOLSTERED ARMS - KOU29F

COM	4	5	6	7	8	9	10	11
3609	3689	3709	3789	3889	3999	4129	4429	4739

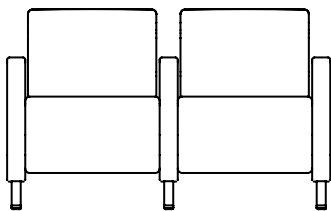

KOU29IF - 2 SEAT BEHAVIORAL HEALTH LOUNGE CHAIR WITH INTERVENING ARM, UPHOLSTERED ARMS

DIMENSIONS

Width	51.75	Seat Width	21.75	Back Height	15.75
Depth	30	Seat Depth	19	Arm Height	25
Height	33.75	Seat Height	18	Weight	152
COM	6.5 YDS				

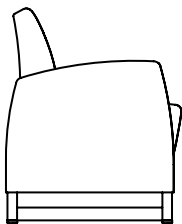

PRICING WITH UPHOLSTERED ARMS - KOU29IF

COM	4	5	6	7	8	9	10	11
4339	4419	4429	4619	4829	5019	5189	5509	6109

TO ORDER, SPECIFY

- 1. Model Number
- 2. Textile
- 3. Finish
- 4. Options

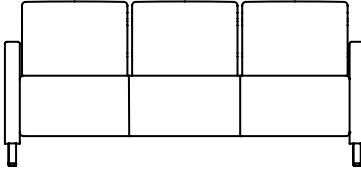

KOU39F - BEHAVIORAL HEALTH SOFA WITH UPHOLSTERED ARMS

DIMENSIONS

Width	71.75	Seat Width	66.5	Back Height	15.75
Depth	30	Seat Depth	19	Arm Height	25
Height	33.75	Seat Height	18	Weight	161
COM	7.5 YDS				

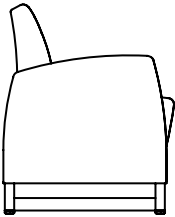

PRICING WITH UPHOLSTERED ARMS - KOU39F

COM	4	5	6	7	8	9	10	11
4499	4699	4709	4819	5089	5319	5509	5959	6429

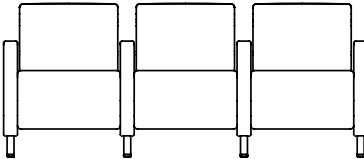

KOU39IF - 3 SEAT BEHAVIORAL HEALTH LOUNGE CHAIR WITH INTERVENING ARM, UPHOLSTERED ARMS

DIMENSIONS

Width	76.25	Seat Width	21.75	Back Height	15.75
Depth	30	Seat Depth	19	Arm Height	25
Height	33.75	Seat Height	18	Weight	208
COM	9 YDS				

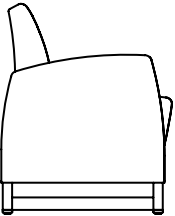

PRICING WITH UPHOLSTERED ARMS - KOU39IF

COM	4	5	6	7	8	9	10	11
5829	6059	6119	6229	6519	6889	7189	7639	8399



LOUNGE | UPHOLSTERED LOUNGE | TANDEM SEATING COLLECTIONS

- Assymble Modular Lounge by Knú Comfort®60
- Dalton Lounge by Knú Comfort®76
- Kadia Mod Upholstered Lounge by Knú Comfort®79
- Cascade Lounge by Knú Comfort®93
- Koncert Lounge by Knú Comfort®105
- Koncert Upholstered Lounge by Knú Comfort®111

Assymble Lounge Seating

Standard Product Information

- Seat and back frames are poplar plywood construction; joints are CNC cut/puzzle-jointed, glued, stapled together, and reinforced with corner blocks for superior strength.
- Seat Foam is 2.5 Density Foam that Meets CAL 117 Fire Standards
- Back Foam is 1.7 Density High Resilience Foam that Meets CAL 117 Fire Standards
- 10-Gauge Heavy-Duty Steel Springs in Back
- 7.5-Gauge Steel Sinuous Seat Springs for Lasting Comfort
- Round Legs in 211 Silver Frost
- Adjustable Glides
- Standard with Ganging Bracket (Armless units only)

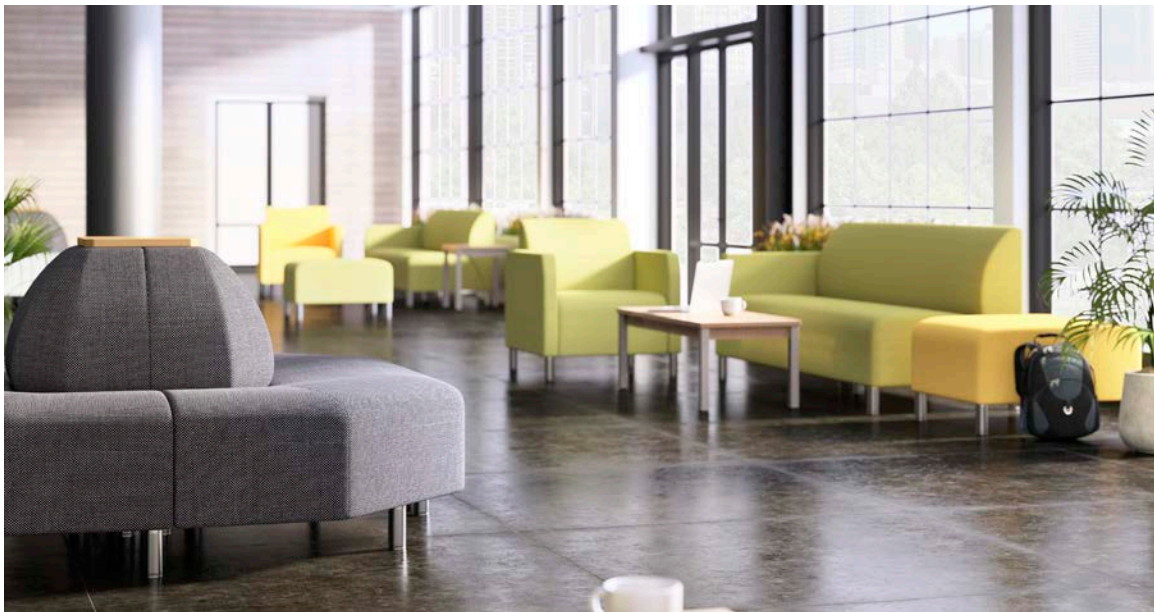

Power Options

PU1-1 Power (Add \$209 List Upcharge)

Power Details

(2) USB Ports (1) AC Outlet

Electrical Rating: 125V, 60Hz, 12A

Length of Power Cord: 10'

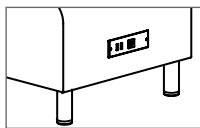

Power Installation

Armless Models: Power Installed on Front Center of Seat

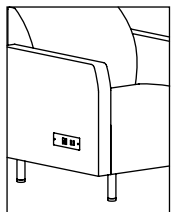

Single Seat w/Arms

Power Installed on Side of Left Arm (facing)

Left Arm Models

Power Installed on Side of Left Arm (facing)

Right Arm Models

Power Installed on Side of Right Arm (facing)

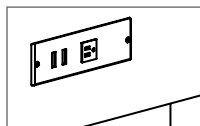
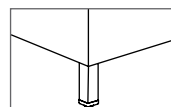

Table Models

Power Installed on Front Center of Table

Leg + Tablet Options



Leg Option

211SL Silver Frost Square Leg (No Upcharge)
*042 Black and 540 Pewter Also Available

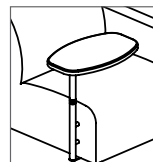

Tablet Options for Armless Models

PPTL Pivot Pole Tablet Left Side (facing)
Thermofoil Top
(Add \$399 List Upcharge)

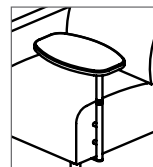

PPTR Pivot Pole Tablet Right Side (facing)
Thermofoil Top
(Add \$399 List Upcharge)

Powder Coat Finish Options (Legs)

- 211 Silver Frost (Standard)
- 042 Black
- 540 Pewter

Moisture Barrier Options

Please refer to page 14.

CAL TB133

Please refer to page 12.

TO ORDER, SPECIFY

- 1. Model Number
- 2. Textile
- 3. Finish
- 4. Options

AS10N - ARMLESS LOUNGE CHAIR

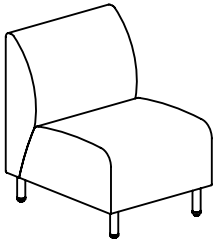

DIMENSIONS

Width	24.5	Seat Width	24.5	Back Height	14.25
Depth	30.75	Seat Depth	21.5	Arm Height	N/A
Height	32.75	Seat Height	18.5	Weight	48
COM	3 YDS				

PRICING - AS10N

<i>COM</i>	4	5	6	7	8	9	10	11	
	1559	1579	1619	1659	1729	1829	1889	2029	2459

AS10NC - ARMLESS LOUNGE CHAIR ON CASTERS

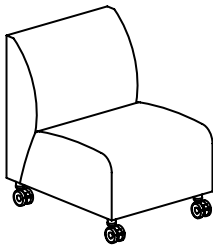

DIMENSIONS

Width	24.5	Seat Width	24.5	Back Height	14.25
Depth	30.75	Seat Depth	21.5	Arm Height	N/A
Height	32.75	Seat Height	18.5	Weight	48
COM	3 YDS				

PRICING - AS10NC

<i>COM</i>	4	5	6	7	8	9	10	11	
	1789	1819	1859	1899	1979	2059	2119	2259	2679

AS20N - ARMLESS LOVESEAT

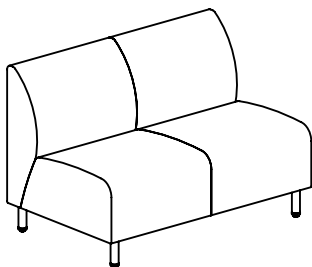

DIMENSIONS

Width	48.75	Seat Width	48.75	Back Height	14.25
Depth	30.75	Seat Depth	21.5	Arm Height	N/A
Height	32.75	Seat Height	18.5	Weight	94
COM	4.5 YDS				

PRICING - AS20N

<i>COM</i>	4	5	6	7	8	9	10	11	
	2519	2579	2699	2789	2929	3079	3209	3459	4069

AS30N - ARMLESS SOFA

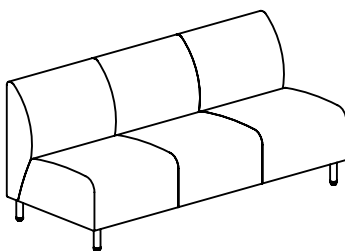

DIMENSIONS

Width	72.75	Seat Width	72.75	Back Height	14.25
Depth	30.75	Seat Depth	21.5	Arm Height	N/A
Height	32.75	Seat Height	18.5	Weight	138
COM	8.5 YDS				

PRICING - AS30N

<i>COM</i>	4	5	6	7	8	9	10	11	
	3499	3639	3759	3939	4149	4389	4579	4959	6109

TO ORDER, SPECIFY

- 1. Model Number
- 2. Textile
- 3. Finish
- 4. Options

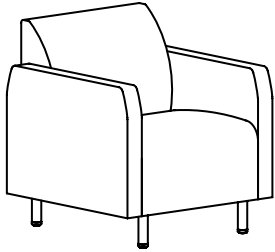

AS12AF - SINGLE SEAT LOUNGE CHAIR WITH UPHOLSTERED ARMS

DIMENSIONS

Width	29.5	Seat Width	24	Back Height	14.25
Depth	30.75	Seat Depth	21.5	Arm Height	26
Height	32.75	Seat Height	18.5	Weight	78
COM	5 YDS				

PRICING WITH UPHOLSTERED ARMS - AS12AF

COM	4	5	6	7	8	9	10	11
2069	2159	2309	2449	2619	2809	2999	3309	3669

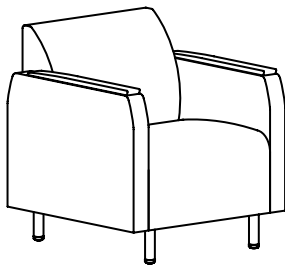

AS12A- SINGLE SEAT LOUNGE CHAIR WITH ARM CAPS

DIMENSIONS

Width	29.5	Seat Width	24	Back Height	14.25
Depth	30.75	Seat Depth	21.5	Arm Height	26.5
Height	32.75	Seat Height	18.5	Weight	78
COM	5 YDS				

PRICING WITH URETHANE ARM CAPS - AS12AU

COM	4	5	6	7	8	9	10	11
2249	2369	2489	2609	2799	3009	3169	3479	3859

PRICING WITH WOOD ARM CAPS - AS12AW

COM	4	5	6	7	8	9	10	11
2309	2429	2539	2699	2849	3059	3229	3529	3909

PRICING WITH SOLID SURFACE ARM CAPS - AS12AJ

COM	4	5	6	7	8	9	10	11
2659	2759	2909	3039	3219	3409	3589	3909	4259

**For above model with solid surface arm caps, add \$200 List for Group 2 solid surface finish*

TO ORDER, SPECIFY

- 1. Model Number
- 2. Textile
- 3. Finish
- 4. Options

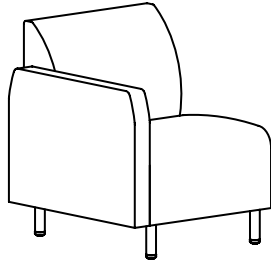

AS12LF - SINGLE SEAT LOUNGE CHAIR, LEFT SIDE (FACING) UPHOLSTERED ARM

DIMENSIONS

Width	27	Seat Width	24	Back Height	14.25
Depth	30.75	Seat Depth	21.5	Arm Height	26
Height	32.75	Seat Height	18.5	Weight	64
COM	3.5 YDS				

PRICING WITH UPHOLSTERED ARM - AS12LF

COM	4	5	6	7	8	9	10	11
1769	1839	1929	2029	2139	2299	2399	2629	3119

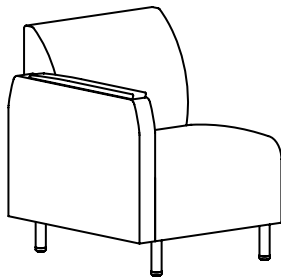

AS12L - SINGLE SEAT LOUNGE CHAIR, LEFT SIDE (FACING) ARM WITH ARM CAP

DIMENSIONS

Width	27	Seat Width	24	Back Height	14.25
Depth	30.75	Seat Depth	21.5	Arm Height	26.5
Height	32.75	Seat Height	18.5	Weight	64
COM	3.5 YDS				

PRICING WITH URETHANE ARM CAP - AS12LU

COM	4	5	6	7	8	9	10	11
1869	1939	2029	2109	2259	2379	2509	2729	3209

PRICING WITH WOOD ARM CAP - AS12LW

COM	4	5	6	7	8	9	10	11
1889	1979	2049	2129	2279	2399	2539	2749	3239

PRICING WITH SOLID SURFACE ARM CAP - AS12LJ

COM	4	5	6	7	8	9	10	11
2069	2139	2239	2329	2449	2599	2709	2939	3429

**For above model with solid surface arm caps, add \$100 List for Group 2 solid surface finish*

TO ORDER, SPECIFY

- 1. Model Number
- 2. Textile
- 3. Finish
- 4. Options

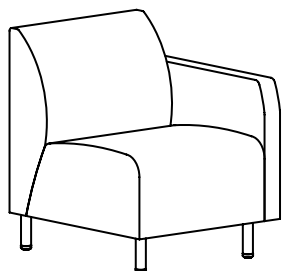

AS12RF - SINGLE SEAT LOUNGE CHAIR, RIGHT SIDE (FACING) UPHOLSTERED ARM

DIMENSIONS

Width	27	Seat Width	24	Back Height	14.25
Depth	30.75	Seat Depth	21.5	Arm Height	26
Height	32.75	Seat Height	18.5	Weight	64
COM	3.5 YDS				

PRICING WITH UPHOLSTERED ARM - AS12RF

COM	4	5	6	7	8	9	10	11
1769	1839	1929	2029	2139	2299	2399	2629	3119

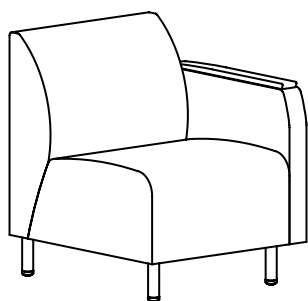

AS12R - SINGLE SEAT LOUNGE CHAIR, RIGHT SIDE (FACING) ARM WITH ARM CAP

DIMENSIONS

Width	27	Seat Width	24	Back Height	14.25
Depth	30.75	Seat Depth	21.5	Arm Height	26.5
Height	32.75	Seat Height	18.5	Weight	64
COM	3.5 YDS				

PRICING WITH URETHANE ARM CAP - AS12RU

COM	4	5	6	7	8	9	10	11
1869	1939	2029	2109	2259	2379	2509	2729	3209

PRICING WITH WOOD ARM CAP - AS12RW

COM	4	5	6	7	8	9	10	11
1889	1979	2049	2129	2279	2399	2539	2749	3239

PRICING WITH SOLID SURFACE ARM CAP - AS12RJ

COM	4	5	6	7	8	9	10	11
2069	2139	2239	2329	2449	2599	2709	2939	3429

**For above model with solid surface arm caps, add \$100 List for Group 2 solid surface finish*

TO ORDER, SPECIFY

- 1. Model Number
- 2. Textile
- 3. Finish
- 4. Options

AS22AF - 2 SEAT LOUNGE WITH UPHOLSTERED ARMS

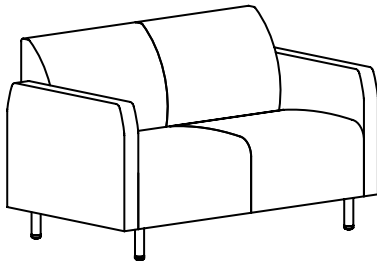

DIMENSIONS

Width	53.5	Seat Width	48.5	Back Height	14.25
Depth	30.75	Seat Depth	21.5	Arm Height	26
Height	32.75	Seat Height	18.5	Weight	123
COM	7 YDS				

PRICING WITH UPHOLSTERED ARMS - AS22AF

COM	4	5	6	7	8	9	10	11
3029	3179	3299	3479	3679	3929	4129	4499	5349

AS22A - 2 SEAT LOUNGE WITH ARM CAPS

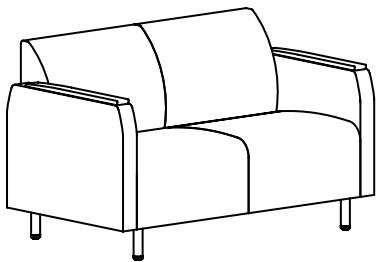

DIMENSIONS

Width	53.5	Seat Width	48.5	Back Height	14.25
Depth	30.75	Seat Depth	21.5	Arm Height	26.5
Height	32.75	Seat Height	18.5	Weight	123
COM	7 YDS				

PRICING WITH URETHANE ARM CAPS - AS22AU

COM	4	5	6	7	8	9	10	11
3229	3349	3489	3659	3879	4109	4289	4659	5509

PRICING WITH WOOD ARM CAPS - AS22AW

COM	4	5	6	7	8	9	10	11
3289	3419	3559	3709	3929	4159	4359	4729	5559

PRICING WITH SOLID SURFACE ARM CAPS - AS22AJ

COM	4	5	6	7	8	9	10	11
3629	3769	3899	4079	4269	4519	4719	5099	5949

**For above model with solid surface arm caps, add \$200 List for Group 2 solid surface finish*

TO ORDER, SPECIFY

- 1. Model Number
- 2. Textile
- 3. Finish
- 4. Options

AS22LF - 2 SEAT LOUNGE, LEFT SIDE (FACING) UPHOLSTERED ARM

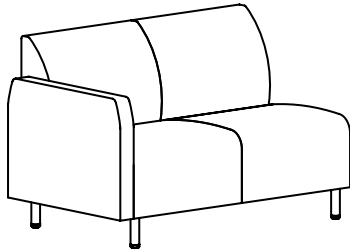

DIMENSIONS

Width	51	Seat Width	48.5	Back Height	14.25
Depth	30.75	Seat Depth	21.5	Arm Height	26
Height	32.75	Seat Height	18.5	Weight	111
COM	6 YDS				

PRICING WITH UPHOLSTERED ARM - ASS22LF

COM	4	5	6	7	8	9	10	11
2779	2859	2969	3129	3279	3489	3649	3939	4589

AS22L- 2 SEAT LOUNGE, LEFT SIDE (FACING) ARM WITH ARM CAP

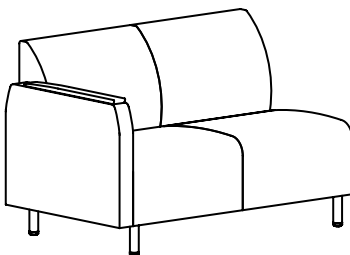

DIMENSIONS

Width	51	Seat Width	48.5	Back Height	14.25
Depth	30.75	Seat Depth	21.5	Arm Height	26.5
Height	32.75	Seat Height	18.5	Weight	111
COM	6 YDS				

PRICING WITH URETHANE ARM CAPS - AS22LU

COM	4	5	6	7	8	9	10	11
2869	2969	3059	3219	3389	3579	3739	4039	4669

PRICING WITH WOOD ARM CAPS - AS22LW

COM	4	5	6	7	8	9	10	11
2909	2989	3079	3239	3409	3609	3759	4069	4699

PRICING WITH SOLID SURFACE ARM CAPS - AS22LJ

COM	4	5	6	7	8	9	10	11
3079	3169	3269	3439	3579	3789	3949	4239	4889

**For above model with solid surface arm caps, add \$100 List for Group 2 solid surface finish*

TO ORDER, SPECIFY

- 1. Model Number 3. Finish
- 2. Textile 4. Options

AS22RF - 2 SEAT LOUNGE, RIGHT SIDE (FACING) UPHOLSTERED ARM

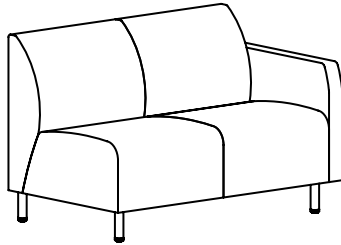

DIMENSIONS

Width	51	Seat Width	48.5	Back Height	14.25
Depth	30.75	Seat Depth	21.5	Arm Height	26
Height	32.75	Seat Height	18.5	Weight	111
COM	6 YDS				

PRICING WITH UPHOLSTERED ARM - AS22RF

COM	4	5	6	7	8	9	10	11
2779	2859	2969	3129	3279	3489	3649	3939	4589

AS22R- 2 SEAT LOUNGE, RIGHT SIDE (FACING) ARM WITH ARM CAP

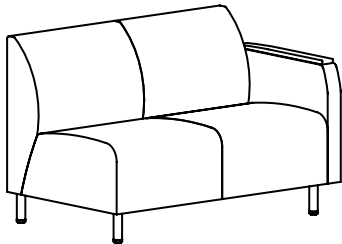

DIMENSIONS

Width	51	Seat Width	48.5	Back Height	14.25
Depth	30.75	Seat Depth	21.5	Arm Height	26.5
Height	32.75	Seat Height	18.5	Weight	111
COM	6 YDS				

PRICING WITH URETHANE ARM CAPS - AS22RU

COM	4	5	6	7	8	9	10	11
2869	2969	3059	3219	3389	3579	3739	4039	4669

PRICING WITH WOOD ARM CAPS - AS22RW

COM	4	5	6	7	8	9	10	11
2909	2989	3079	3239	3409	3609	3759	4069	4699

PRICING WITH SOLID SURFACE ARM CAPS - AS22RJ

COM	4	5	6	7	8	9	10	11
3079	3169	3269	3439	3579	3789	3949	4239	4889

**For above model with solid surface arm caps, add \$100 List for Group 2 solid surface finish*

TO ORDER, SPECIFY

- 1. Model Number
- 2. Textile
- 3. Finish
- 4. Options

AS32AF - 3 SEAT LOUNGE WITH UPHOLSTERED ARMS

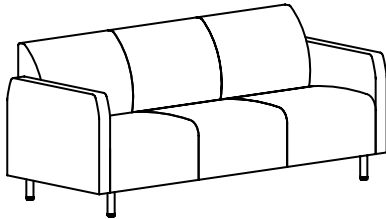

DIMENSIONS

Width	77.5	Seat Width	72.5	Back Height	14.25
Depth	30.75	Seat Depth	21.5	Arm Height	26
Height	32.75	Seat Height	18.5	Weight	167
COM	10.5 YDS				

PRICING WITH UPHOLSTERED ARMS - AS32AF

COM	4	5	6	7	8	9	10	11	
	3979	4149	4369	4609	4899	5269	5539	6069	7019

AS32A- 3 SEAT LOUNGE WITH ARM CAPS

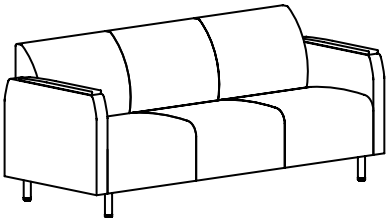

DIMENSIONS

Width	77.5	Seat Width	72.5	Back Height	14.25
Depth	30.75	Seat Depth	21.5	Arm Height	26.5
Height	32.75	Seat Height	18.5	Weight	167
COM	10.5 YDS				

PRICING WITH URETHANE ARM CAPS - AS32AU

COM	4	5	6	7	8	9	10	11	
	4169	4349	4549	4799	5089	5439	5719	6249	7189

PRICING WITH WOOD ARM CAPS - AS32AW

COM	4	5	6	7	8	9	10	11	
	4229	4409	4619	4849	5139	5499	5769	6299	7239

PRICING WITH SOLID SURFACE ARM CAPS - AS32AJ

COM	4	5	6	7	8	9	10	11	
	4579	4739	4959	5199	5499	5859	6129	6669	7619

**For above model with solid surface arm caps, add \$200 List for Group 2 solid surface finish*

TO ORDER, SPECIFY

- | | |
|-----------------|------------|
| 1. Model Number | 3. Finish |
| 2. Textile | 4. Options |

AS32LF - 3 SEAT LOUNGE, LEFT SIDE (FACING) UPHOLSTERED ARM

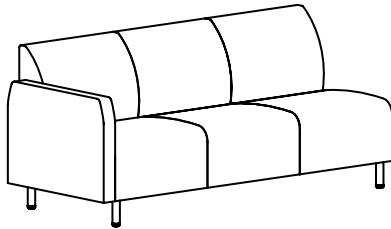

DIMENSIONS

Width	75	Seat Width	72.5	Back Height	14.25
Depth	30.75	Seat Depth	21.5	Arm Height	26
Height	32.75	Seat Height	18.5	Weight	153
COM	9.5 YDS				

PRICING WITH UPHOLSTERED ARMS - AS32LF

<i>COM</i>	4	5	6	7	8	9	10	11	
	3669	3779	3959	4139	4379	4659	4879	5319	6429

AS32L - 3 SEAT LOUNGE, LEFT SIDE (FACING) ARM WITH ARM CAPS

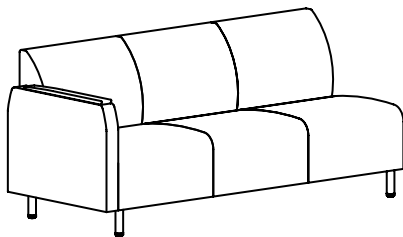

DIMENSIONS

Width	75	Seat Width	72.5	Back Height	14.25
Depth	30.75	Seat Depth	21.5	Arm Height	26.5
Height	32.75	Seat Height	18.5	Weight	153
COM	9.5 YDS				

PRICING WITH URETHANE ARM CAPS - AS32LU

<i>COM</i>	4	5	6	7	8	9	10	11	
	3749	3899	4069	4229	4469	4769	4969	5399	6509

PRICING WITH WOOD ARM CAPS - AS32LW

<i>COM</i>	4	5	6	7	8	9	10	11	
	3779	3919	4089	4269	4509	4789	4999	5429	6529

PRICING WITH SOLID SURFACE ARM CAPS - AS32LJ

<i>COM</i>	4	5	6	7	8	9	10	11	
	3969	4089	4259	4439	4679	4959	5179	5619	6729

**For above model with solid surface arm caps, add \$100 List for Group 2 solid surface finish*

TO ORDER, SPECIFY

- 1. Model Number
- 2. Textile
- 3. Finish
- 4. Options

AS32RF - 3 SEAT LOUNGE, RIGHT SIDE (FACING) UPHOLSTERED ARM

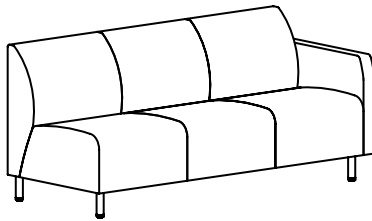

DIMENSIONS

Width	75	Seat Width	72.5	Back Height	14.25
Depth	30.75	Seat Depth	21.5	Arm Height	26
Height	32.75	Seat Height	18.5	Weight	153
COM	9.5 YDS				

PRICING WITH UPHOLSTERED ARMS - AS32RF

COM	4	5	6	7	8	9	10	11	
	3669	3779	3959	4139	4379	4659	4879	5319	6429

AS32R - 3 SEAT LOUNGE, RIGHT SIDE (FACING) ARM WITH ARM CAPS

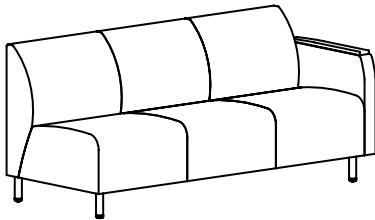

DIMENSIONS

Width	75	Seat Width	72.5	Back Height	14.25
Depth	30.75	Seat Depth	21.5	Arm Height	26.5
Height	32.75	Seat Height	18.5	Weight	153
COM	9.5 YDS				

PRICING WITH URETHANE ARM CAPS - AS32RU

COM	4	5	6	7	8	9	10	11	
	3749	3899	4069	4229	4469	4769	4969	5399	6509

PRICING WITH WOOD ARM CAPS - AS32RW

COM	4	5	6	7	8	9	10	11	
	3779	3919	4089	4269	4509	4789	4999	5429	6529

PRICING WITH SOLID SURFACE ARM CAPS - AS32RJ

COM	4	5	6	7	8	9	10	11	
	3969	4089	4259	4439	4679	4959	5179	5619	6729

**For above model with solid surface arm caps, add \$100 List for Group 2 solid surface finish*

TO ORDER, SPECIFY

- 1. Model Number
- 2. Textile
- 3. Finish
- 4. Options

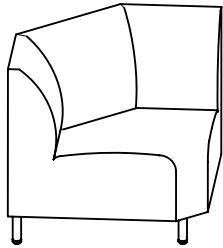

AS901C - 90 DEGREE INSIDE CORNER LOUNGE CHAIR

DIMENSIONS

Width	51.25	Seat Width	50	Back Height	14.25
Depth	34.5	Seat Depth	25.5	Arm Height	N/A
Height	32.75	Seat Height	18.5	Weight	75
COM	4 YDS				

PRICING - AS901C

COM	4	5	6	7	8	9	10	11
2169	2289	2349	2449	2529	2709	2799	3049	3669

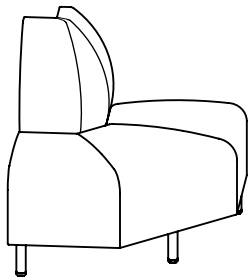

AS900C - 90 DEGREE OUTSIDE CORNER LOUNGE CHAIR

DIMENSIONS

Width	50.5	Seat Width	50.5	Back Height	14.25
Depth	34.5	Seat Depth	22.5	Arm Height	N/A
Height	32.75	Seat Height	18.5	Weight	69
COM	3 YDS				

PRICING - AS900C

COM	4	5	6	7	8	9	10	11
2119	2229	2299	2369	2479	2639	2749	2999	3619

TO ORDER, SPECIFY

- 1. Model Number
- 2. Textile
- 3. Finish
- 4. Options

ASB2424 - 24" ONE SEAT BENCH

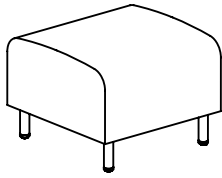

DIMENSIONS

Width	24.5	Seat Width	24.5	Weight	32				
Depth	24.5	Seat Depth	24.5	COM	2 YDS				
Height	18.5	Seat Height	18.5						
COM	4	5	6	7	8	9	10	11	
	1199	1209	1229	1239	1269	1369	1399	1449	1789

ASB2448 - 24" TWO SEAT BENCH

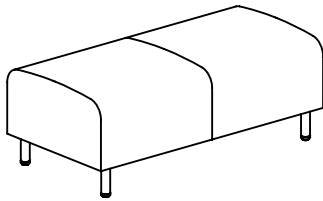

DIMENSIONS

Width	48.5	Seat Width	48.5	Weight	62				
Depth	24.5	Seat Depth	24.5	COM	2.5 YDS				
Height	18.5	Seat Height	18.5						
COM	4	5	6	7	8	9	10	11	
	1979	2009	2049	2089	2119	2219	2239	2329	2599

ASB2472 - 24" THREE SEAT BENCH

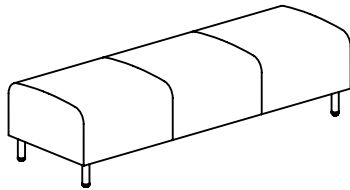

DIMENSIONS

Width	72.5	Seat Width	72.5	Weight	85				
Depth	24.5	Seat Depth	24.5	COM	3.5 YDS				
Height	18.5	Seat Height	18.5						
COM	4	5	6	7	8	9	10	11	
	2349	2379	2429	2469	2499	2559	2679	2909	3299

ASB3024 - 30" ONE SEAT BENCH

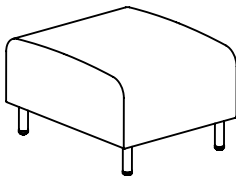

DIMENSIONS

Width	24.5	Seat Width	24.5	Weight	37				
Depth	30.35	Seat Depth	30.5	COM	3 YDS				
Height	18.5	Seat Height	18.5						
COM	4	5	6	7	8	9	10	11	
	1289	1299	1309	1329	1389	1469	1519	1619	2079

ASB3048 - 30" TWO SEAT BENCH

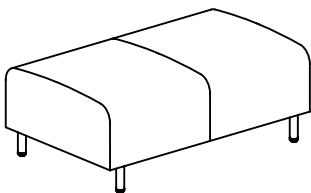

DIMENSIONS

Width	48.5	Seat Width	48.5	Weight	67				
Depth	30.5	Seat Depth	30.5	COM	3 YDS				
Height	18.5	Seat Height	18.5						
COM	4	5	6	7	8	9	10	11	
	2089	2119	2159	2229	2269	2319	2339	2459	2749

ASB3072 - 30" THREE SEAT BENCH

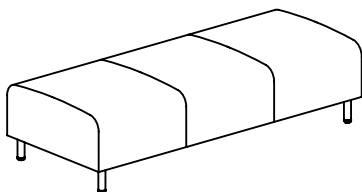

DIMENSIONS

Width	72.5	Seat Width	72.5	Weight	92				
Depth	30.5	Seat Depth	30.5	COM	4.5 YDS				
Height	18.5	Seat Height	18.5						
COM	4	5	6	7	8	9	10	11	
	2589	2609	2679	2719	2749	2789	2909	3129	3779

Product Specifications

- Standard with Silver Frost Round Legs
- Optional Silver Frost Square Legs Available

Options

Please refer to page 60.

Moisture Barrier Options

Please refer to page 14.

Powder Coat Finish

- 211 Silver Frost {Standard}
- 042 Black
- 540 Pewter

Thermofoil Finishes

Please refer to page 14.

Solid Surface Finishes

Please refer to page 14.

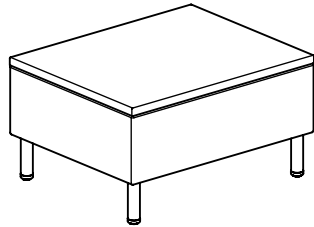

AST10 - TABLE - THERMOFOIL

DIMENSIONS

Width: 24.5 Depth: 29.75 Height: 15.5 Weight: 51 COM: 1.5 YDS

COM	4	5	6	7	8	9	10	11	
	1329	1369	1419	1439	1449	1469	1479	1569	1839

AST10 - TABLE - SOLID SURFACE

DIMENSIONS

Width: 24.5 Depth: 29.75 Height: 15.5 Weight: 65

*CONTACT CUSTOMER SERVICE FOR SOLID SURFACE TABLE PRICING

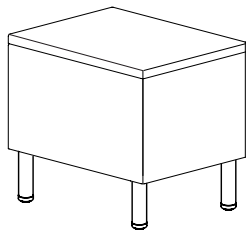

AST15 - INLINE TABLE (GANGING NOT RECOMMENDED) - THERMOFOIL

DIMENSIONS

Width: 16 Depth: 20.25 Height: 15.5 Weight: 34 COM: 1.5 YDS

COM	4	5	6	7	8	9	10	11	
	1099	1109	1119	1389	1149	1179	1189	1219	1539

AST15 - INLINE TABLE (GANGING NOT RECOMMENDED) - SOLID SURFACE

DIMENSIONS

Width: 16 Depth: 20.25 Height: 15.5 Weight: 40

*CONTACT CUSTOMER SERVICE FOR SOLID SURFACE TABLE PRICING

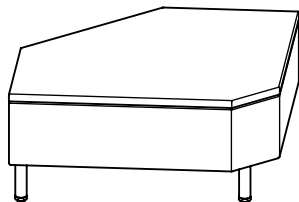

AST90 - 90 DEGREE TABLE - THERMOFOIL

DIMENSIONS

Width: 50.75 Depth: 34.75 Height: 15.5 Weight: 78 COM: 1.5 YDS

COM	4	5	6	7	8	9	10	11	
	1859	1909	1939	1989	2019	2049	2099	2179	2289

AST90 - 90 DEGREE TABLE - SOLID SURFACE

DIMENSIONS

Width 50.75 Depth 34.75 Height 15.5 Weight 100

*CONTACT CUSTOMER SERVICE FOR SOLID SURFACE TABLE PRICING

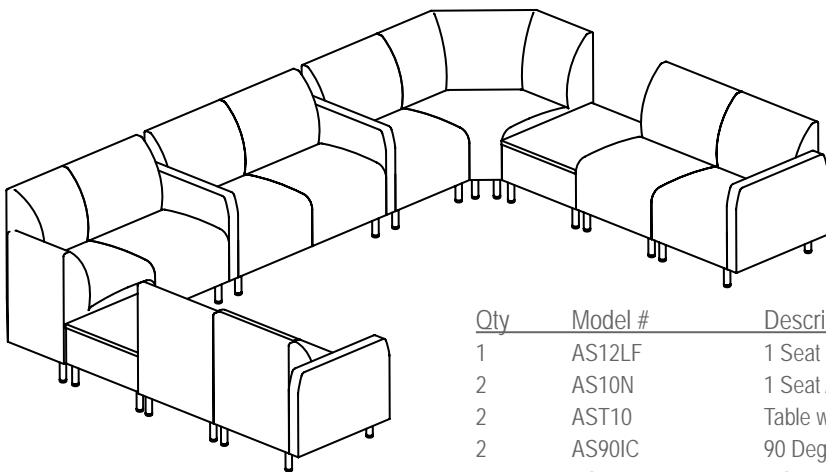

Qty	Model #	Description
1	AS12LF	1 Seat with Left Side Facing Fully Upholstered Arm
2	AS10N	1 Seat Armless Chair
2	AST10	Table with Thermofoil Top
2	AS90IC	90 Degree Inside Corner Chair
1	AS12RF	1 Seat Right Facing Arm with Fully Upholstered Arm
2	AS22RF	2 Seat Right Facing Arm with Fully Upholstered Arm

*Refer to pages 60 - 73 for unit pricing.

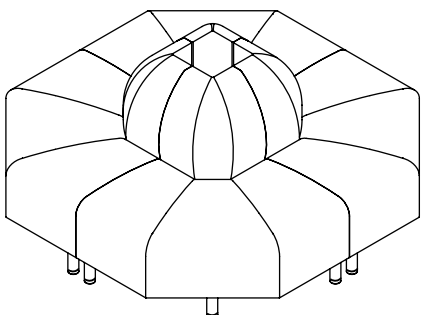

Qty	Model #	Description
4	AS90OC	90 Degree Outside Corner

*Refer to pages 60 - 73 for unit pricing.

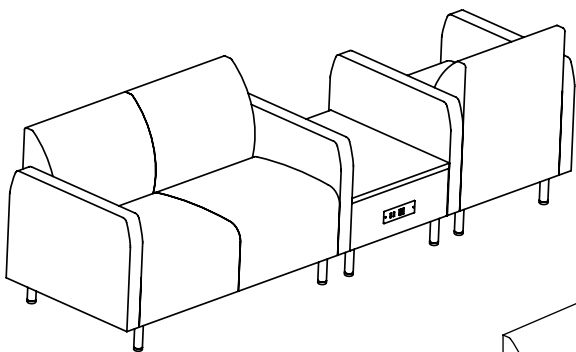

Qty	Model #	Description
1	AS22AF	2 Seat Chair w/ Square Upholstered Arms
1	AST10	Table with Thermofoil Top with Power
1	AS12AF	1 Seat Chair w/ Square Upholstered Arms

*Refer to pages 60 - 73 for unit pricing.

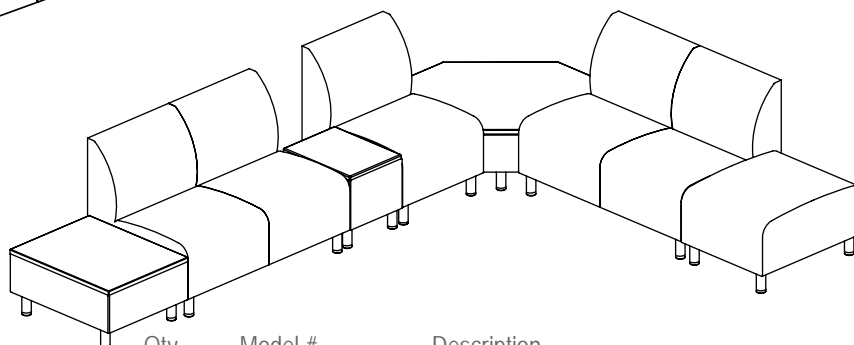

Qty	Model #	Description
1	AST10	Table with Thermofoil Top
2	AS20N	2 Seat Armless Chair
1	AST15	End Table with Thermofoil Top
1	AS10N	1 Seat Armless Chair
1	AST90	90 Degree Table with Thermofoil Top
1	ASB3024	30" One Seat Bench

*Refer to pages 60 - 73 for unit pricing.

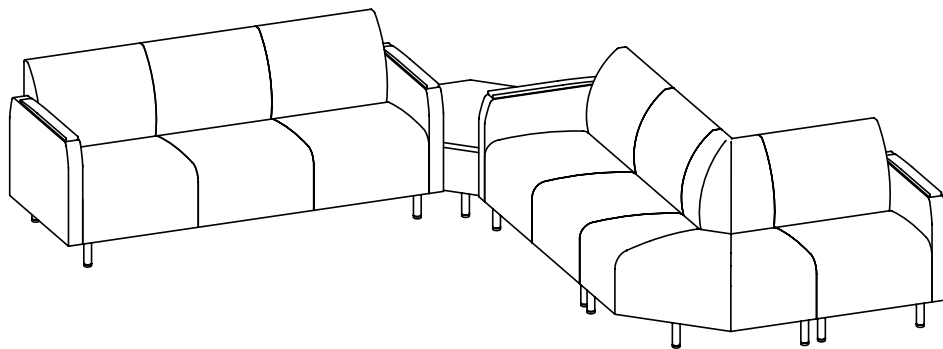

Qty	Model #	Description
1	AS32AU	3 Seat with Urethane Arm Caps
1	AST90	90 Degree Table with Thermofoil Top
1	AS22LU	2 Seat Left Side Facing Arm with Urethane Arm Cap
1	AS90OC	90 Degree Outside Corner Chair
1	AS12RU	1 Seat Right Side Facing Arm with Urethane Arm Cap

**Refer to pages 60 - 73 for unit pricing.*

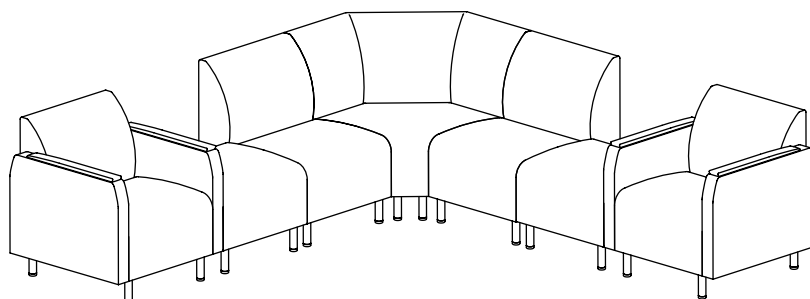

Qty	Model #	Description
2	AS12AU	1 Seat with Urethane Arm Caps
2	ASB2424	24" One Seat Bench
2	AS10N	1 Seat Armless Chair
1	AS90IC	90 Degree Inside Corner Chair

**Refer to pages 60 - 73 for unit pricing.*

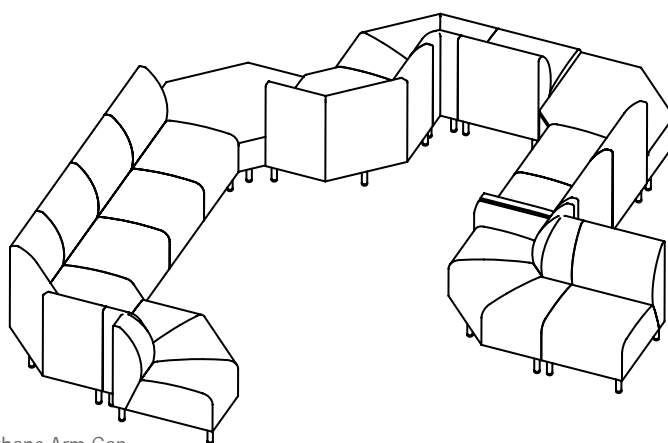

Qty	Model #	Description
3	AS90OC	90 Degree Outside Corner Chair
2	AS90IC	90 Degree Inside Corner Chair
1	AS30N	3 Seat Armless Chair
2	AST90	90 Degree Table with Thermofoil Top
2	AS10N	1 Seat Armless Chair
1	AS22RU	2 Seat Right Side Facing Arm with Urethane Arm Cap

**Refer to pages 60 - 73 for unit pricing.*

Dalton Lounge Seating

Standard Product Information

- Seat and back frames are poplar plywood construction; joints are CNC cut/puzzle-jointed, glued, stapled together, and reinforced with corner blocks for superior strength
- Seat Foam is 2.5 Density Foam that Meets CAL 117 Fire Standards
- Back Foam is 1.7 Density High Resilience Foam that Meets CAL 117 Fire Standards
- 7.5 Gauge Steel Sinuous Seat Springs
- European Beech Wood Feet Feature a Fixed Glide
- All Feet Options Utilize a Common Height and Mounting Hole for Field Adaptability
- Fully Upholstered Arms, Wood, Urethane, or Solid Surface Arm Caps
- Arms are Bolted to Seat/Back Center Sections. Arms can be easily replaced in field if necessary.

Dimensions

▪ Width (Chair)	28.25"
▪ Width (Loveseat)	50.75"
▪ Width (Sofa)	72.75"
▪ Depth	30"
▪ Height	33"
▪ Seat Width (Chair)	22.5"
▪ Seat Width (Loveseat)	45"
▪ Seat Width (Sofa)	67"
▪ Weight Capacity (Chair)	350 lbs
▪ Weight Capacity (Loveseat)	500 lbs
▪ Weight Capacity (Sofa)	750 lbs



Feet Options

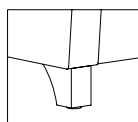

WF Standard Wood Feet

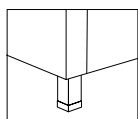

MF Metal Feet (Add \$359)
Silver Frost Square Leg
*540 Pewter Also Available

Moisture Barrier Options

Please refer to page 14.

CAL TB133

Please refer to page 12.

Arm Cap Options

*Please refer to page 14 for Finishes

- F Fully Upholstered Arms (Standard)
- W Wood Arm Cap*
(Add \$229 List per pair)
- U Urethane Arm Cap*
(Add \$169 List per pair)
- J Solid Surface Arm Cap
(Add \$689 List per pair Group 1,
add \$889 List per pair Group 2)

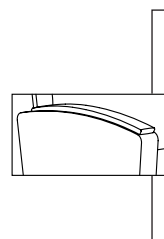

TO ORDER, SPECIFY

- | | |
|-----------------|------------|
| 1. Model Number | 3. Finish |
| 2. Textile | 4. Options |

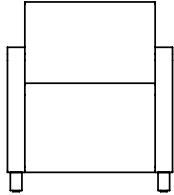

DL10 - SINGLE SEAT LOUNGE CHAIR WITH UPHOLSTERED ARMS

(ARM CAP OPTION AVAILABLE, REFER TO PAGE 76)

DIMENSIONS

Width	28.25	Seat Width	22.5	Back Height	15
Depth	30	Seat Depth	19	Arm Height	25.5
Height	33	Seat Height	18.5	Weight	76
COM	4.5 YDS				

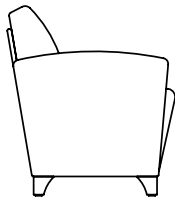

PRICING WITH UPHOLSTERED ARMS - DL10

<i>COM</i>	4	5	6	7	8	9	10	11	
	1879	1999	2079	2199	2319	2499	2619	2869	3669

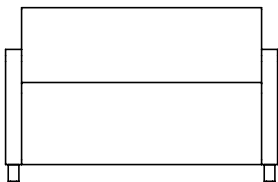

DL20 - LOVESEAT WITH UPHOLSTERED ARMS

(ARM CAP OPTION AVAILABLE, REFER TO PAGE 76)

DIMENSIONS

Width	50.75	Seat Width	45	Back Height	15
Depth	30	Seat Depth	19	Arm Height	25.5
Height	33	Seat Height	18.5	Weight	113
COM	6.5 YDS				

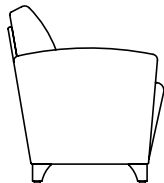

PRICING WITH UPHOLSTERED ARMS - DL20

<i>COM</i>	4	5	6	7	8	9	10	11	
	2639	2779	2919	3069	3279	3509	3689	4039	4889

TO ORDER, SPECIFY

- 1. Model Number
- 2. Textile
- 3. Finish
- 4. Options

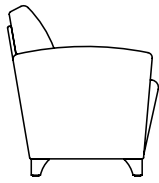
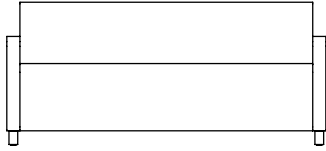

DL30 - SOFA WITH UPHOLSTERED ARMS
 (ARM CAPS AVAILABLE, REFER TO PAGE 76)

DIMENSIONS

Width	72.75	Seat Width	67	Back Height	15
Depth	30	Seat Depth	19	Arm Height	25.5
Height	33	Seat Height	18.5	Weight	144
COM	7.5 YDS				

PRICING WITH UPHOLSTERED ARMS - DL30

<i>COM</i>	<i>4</i>	<i>5</i>	<i>6</i>	<i>7</i>	<i>8</i>	<i>9</i>	<i>10</i>	<i>11</i>
3309	3499	3689	3909	4179	4509	4749	5219	6109

Kadia Mod Upholstered Lounge Seating

Standard Product Information

- Fully Upholstered Arms, Urethane, Wood, or Corian® Solid Surface Arm Caps
- Passive Flex Back
- Seat Clean-Out
- Wall-Saver Leg Design
- Metal Feet with Adjustable Glides
- All Interior Joints are CNC Cut/Puzzle-Jointed, Corner Blocked, Screwed, and Glued Together
- Commercial Grade Double Walled Plywood Interior Frame
- 14 Gauge Steel Support Tubes Connect Arms
- Seat Foam is 2.8 High Resilience Density Foam that Meets CAL 117 Fire Standards
- Back Foam is 1.7 Density Foam that Meets CAL 117 Fire Standards
- Comfort Webbing in Seats
- Steel Sinuous Springs in Back
- Field Replaceable Components

Dimensions

▪ Width (Standard Chair)	28.25"
▪ Width (Bariatric Chair)	34.75"
▪ Depth	29"
▪ Height	32.75"
▪ Seat Width (Standard Chair)	22"
▪ Seat Width (Bariatric Chair)	29.5"
▪ Weight Capacity (Standard Chair)	550 lbs
▪ Weight Capacity (Bariatric Chair)	750 lbs



Power Options

- PU1-2 Power (Add \$209 List Upcharge)
 Power will be installed on outside of left arm facing

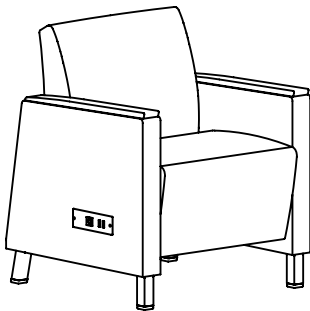

KMU10U shown with optional power (PU1-2)

CAL TB133

Please refer to page 12.

Arm Cap Options

Please refer to page 14 for wood + urethane color options.

- F Fully Upholstered Arms
- U Urethane Arm Caps
- W Wood Arm Caps
- J Corian® Solid Surface Arm Cap

Powder Coat Finish Options (Legs)

- 540 Pewter (Standard)
- 042 Black
- 211 Silver Frost

Moisture Barrier Options

Please refer to page 14.



TO ORDER, SPECIFY

- 1. Model Number
- 2. Textile
- 3. Finish
- 4. Options

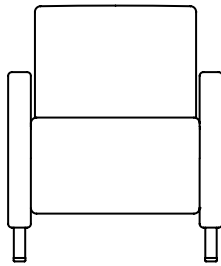

KMU10F - LOUNGE CHAIR WITH UPHOLSTERED ARMS

DIMENSIONS

Width	28.25	Seat Width	22	Back Height	15
Depth	29	Seat Depth	20	Arm Height	25.25
Height	32.75	Seat Height	18.25	Weight	77
COM	3.8 YDS				

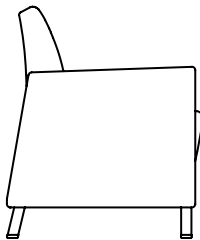

PRICING - KMU10F

COM	4	5	6	7	8	9	10	11
1999	2069	2139	2269	2379	2549	2679	2889	3379

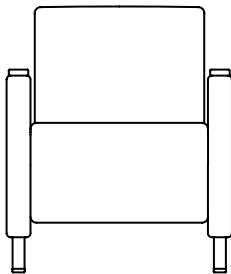

KMU10 - LOUNGE CHAIR WITH ARM CAPS

DIMENSIONS

Width	28.25	Seat Width	22	Back Height	15
Depth	29	Seat Depth	20	Arm Height	25.5
Height	32.75	Seat Height	18.25	Weight	77
COM	3.8 YDS				

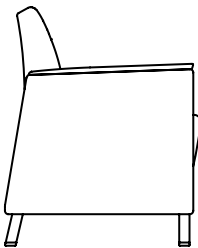

PRICING WITH URETHANE ARM CAPS - KMU10U

COM	4	5	6	7	8	9	10	11
2089	2149	2259	2359	2489	2639	2759	2989	3449

PRICING WITH WOOD ARM CAPS - KMU10W

COM	4	5	6	7	8	9	10	11
2169	2269	2359	2469	2579	2749	2849	3079	3509

PRICING WITH SOLID SURFACE ARM CAPS - KMU10J

COM	4	5	6	7	8	9	10	11
2759	2819	2889	3009	3119	3259	3379	3609	3889

**For above model with solid surface arm caps, add \$200 List for Group 2 solid surface finish*

TO ORDER, SPECIFY

- 1. Model Number 3. Finish
- 2. Textile 4. Options

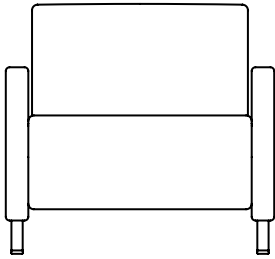

KMU10BF - BARIATRIC LOUNGE CHAIR WITH UPHOLSTERED ARMS

DIMENSIONS

Width	34.75	Seat Width	29.5	Back Height	15
Depth	29	Seat Depth	20	Arm Height	25.25
Height	32.75	Seat Height	18.25	Weight	101
COM	5.4 YDS				

PRICING - KMU10BF

COM	4	5	6	7	8	9	10	11
2349	2429	2509	2589	2729	2839	2959	3209	3819

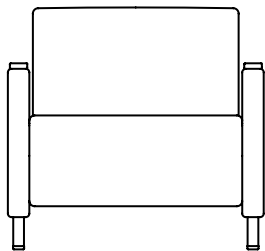
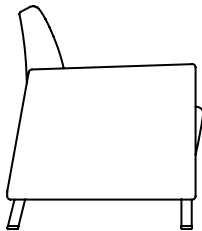

KMU10B - BARIATRIC LOUNGE CHAIR WITH ARM CAPS

DIMENSIONS

Width	34.75	Seat Width	29.5	Back Height	15
Depth	29	Seat Depth	20	Arm Height	25.5
Height	32.75	Seat Height	18.25	Weight	101
COM	5.4 YDS				

PRICING WITH URETHANE ARM CAPS - KMU10BU

COM	4	5	6	7	8	9	10	11
2469	2529	2609	2709	2809	2959	3049	3299	3909

PRICING WITH WOOD ARM CAPS - KMU10BW

COM	4	5	6	7	8	9	10	11
2549	2609	2719	2799	2909	3049	3149	3409	3969

PRICING WITH SOLID SURFACE ARM CAPS - KMU10BJ

COM	4	5	6	7	8	9	10	11
3129	3189	3249	3319	3449	3559	3669	3909	4359

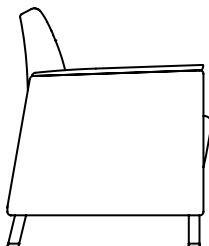

**For above model with solid surface arm caps, add \$200 List for Group 2 solid surface finish*

TO ORDER, SPECIFY

- 1. Model Number 3. Finish
- 2. Textile 4. Options

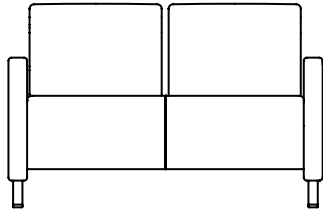

KMU20F - LOVESEAT WITH UPHOLSTERED ARMS

DIMENSIONS

Width	50.25	Seat Width	44	Back Height	15
Depth	29	Seat Depth	20	Arm Height	25.25
Height	32.75	Seat Height	18.25	Weight	121
COM	5.4 YDS				

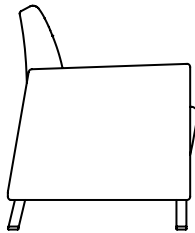

PRICING - KMU20F

COM	4	5	6	7	8	9	10	11
2859	2969	3079	3249	3439	3669	3849	4179	4889

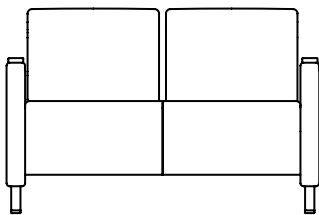

KMU20 - LOVESEAT WITH ARM CAPS

DIMENSIONS

Width	50.25	Seat Width	44	Back Height	15
Depth	29	Seat Depth	20	Arm Height	25.5
Height	32.75	Seat Height	18.25	Weight	121
COM	6 YDS				

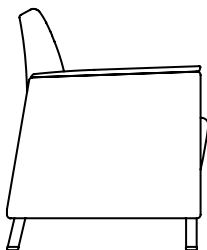

PRICING WITH URETHANE ARM CAPS - KMU20U

COM	4	5	6	7	8	9	10	11
2959	3059	3209	3349	3529	3749	3929	4279	4979

PRICING WITH WOOD ARM CAPS - KMU20W

COM	4	5	6	7	8	9	10	11
3049	3179	3289	3449	3639	3869	4019	4379	5039

PRICING WITH SOLID SURFACE ARM CAPS - KMU20J

COM	4	5	6	7	8	9	10	11
3629	3719	3849	3979	4169	4379	4549	4889	5399

**For above model with solid surface arm caps, add \$200 List for Group 2 solid surface finish*

TO ORDER, SPECIFY

- 1. Model Number 3. Finish
- 2. Textile 4. Options

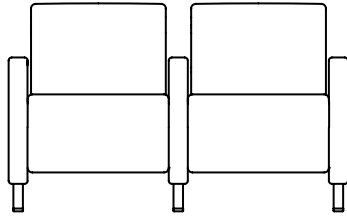

KMU20IF - 2 SEAT LOUNGE WITH INTERVENING ARM, UPHOLSTERED ARMS

DIMENSIONS

Width	52	Seat Width	22	Back Height	15
Depth	29	Seat Depth	20	Arm Height	25.25
Height	32.75	Seat Height	18.25	Weight	141
COM	6.9 YDS				

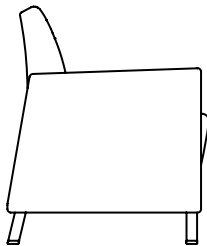

PRICING - KMU20IF

COM	4	5	6	7	8	9	10	11
3489	3619	3749	3939	4169	4419	4619	5029	5799

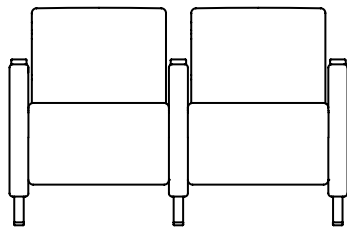

KMU20I - 2 SEAT LOUNGE WITH INTERVENING ARM, ARM CAPS

DIMENSIONS

Width	52	Seat Width	22	Back Height	15
Depth	29	Seat Depth	20	Arm Height	25.5
Height	32.75	Seat Height	18.25	Weight	141
COM	6.5 YDS				

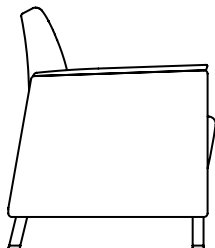

PRICING WITH URETHANE ARM CAPS - KMU20IU

COM	4	5	6	7	8	9	10	11
3659	3759	3909	4099	4319	4579	4769	5159	5959

PRICING WITH WOOD ARM CAPS - KMU20IW

COM	4	5	6	7	8	9	10	11
3809	3919	4079	4229	4459	4729	4899	5309	6109

PRICING WITH SOLID SURFACE ARM CAPS - KMU20IJ

COM	4	5	6	7	8	9	10	11
4639	4739	4879	5059	5259	5509	5669	6069	6759

**For above model with solid surface arm caps, add \$300 List for Group 2 solid surface finish*

TO ORDER, SPECIFY

- 1. Model Number 3. Finish
- 2. Textile 4. Options

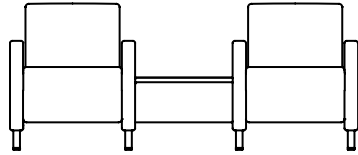

KMU20ITF - 2 SEAT LOUNGE WITH INTERVENING TABLE, INTERVENING ARMS, UPHOLSTERED ARMS

DIMENSIONS

Width	77.5	Seat Width	22	Back Height	15
Depth	29	Seat Depth	20	Arm Height	25.25
Height	32.75	Seat Height	18.25	Weight	182
COM	8 YDS				

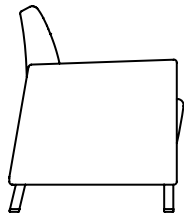

PRICING - KMU20ITF

<i>COM</i>	4	5	6	7	8	9	10	11
	4469	4609	4819	5029	5309	5619	5859	6359 7019

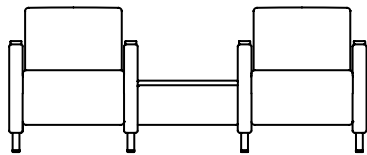

KMU20IT - 2 SEAT LOUNGE WITH INTERVENING TABLE, INTERVENING ARMS, ARM CAPS

DIMENSIONS

Width	77.5	Seat Width	22	Back Height	15
Depth	29	Seat Depth	20	Arm Height	25.5
Height	32.75	Seat Height	18.25	Weight	182
COM	7.9 YDS				

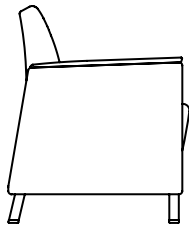

PRICING WITH URETHANE ARM CAPS - KMU20ITU

<i>COM</i>	4	5	6	7	8	9	10	11
	4889	5029	5219	5429	5709	5749	5859	6249 7209

PRICING WITH WOOD ARM CAPS - KMU20ITW

<i>COM</i>	4	5	6	7	8	9	10	11
	5089	5249	5429	5609	5899	6209	6439	6929 7349

PRICING WITH SOLID SURFACE ARM CAPS - KMU20ITJ

<i>COM</i>	4	5	6	7	8	9	10	11
	6009	6139	6309	6489	6759	7059	7269	7769 8389

*CONTACT CUSTOMER SERVICE FOR SOLID SURFACE TABLE PRICING

*For above model with solid surface arm caps, add \$400 List for Group 2 solid surface finish caps

TO ORDER, SPECIFY

- 1. Model Number 3. Finish
- 2. Textile 4. Options

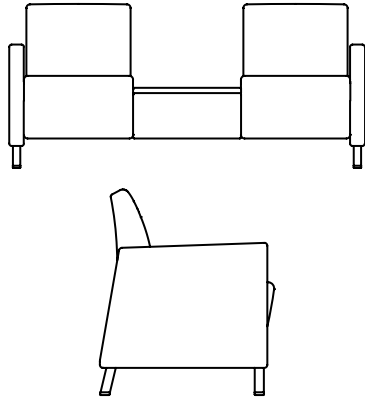

KMU20TF - 2 SEAT LOUNGE WITH INTERVENING TABLE, NO INTERVENING ARMS, UPHOLSTERED ARMS

DIMENSIONS

Width	72	Seat Width	22	Back Height	15
Depth	29	Seat Depth	20	Arm Height	25.25
Height	32.75	Seat Height	18.25	Weight	155
COM	6.1 YDS				

PRICING - KMU20TF

<i>COM</i>	4	5	6	7	8	9	10	11	
	3939	4069	4239	4419	4659	4929	5149	5589	6109

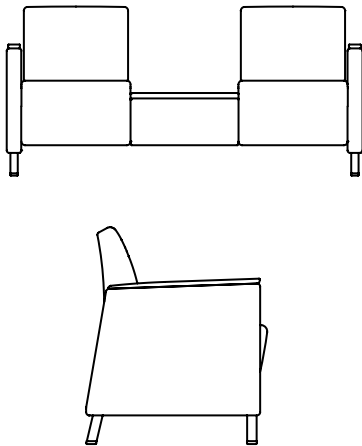

KMU20T - 2 SEAT LOUNGE WITH INTERVENING TABLE, NO INTERVENING ARMS, ARM CAPS

DIMENSIONS

Width	72	Seat Width	22	Back Height	15
Depth	29	Seat Depth	20	Arm Height	25.5
Height	32.75	Seat Height	18.25	Weight	155
COM	6.1 YDS				

PRICING WITH URETHANE ARM CAPS - KMU20TU

<i>COM</i>	4	5	6	7	8	9	10	11	
	4219	4349	4519	4689	4929	5219	5419	5859	6239

PRICING WITH WOOD ARM CAPS - KMU20TW

<i>COM</i>	4	5	6	7	8	9	10	11	
	4399	4539	4689	4869	5109	5379	5579	6029	6269

PRICING WITH SOLID SURFACE ARM CAPS - KMU20TJ

<i>COM</i>	4	5	6	7	8	9	10	11	
	4689	4829	4999	5149	5389	5669	5859	6299	6789

*CONTACT CUSTOMER SERVICE FOR SOLID SURFACE TABLE PRICING

*For above model with solid surface arm caps, add \$200 List for Group 2 solid surface finish caps

TO ORDER, SPECIFY

- 1. Model Number
- 2. Textile
- 3. Finish
- 4. Options

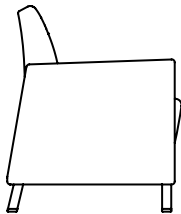
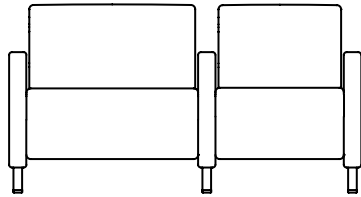

KMU20IBLF - 2 SEAT LOUNGE LEFT BARIATRIC (FACING) WITH INTERVENING ARM, UPHOLSTERED ARMS

DIMENSIONS

Width	59.5	Seat Width	22 (29.5 bariatric)	Back Height	15
Depth	29	Seat Depth	20	Arm Height	25.25
Height	32.75	Seat Height	18.25	Weight	151
COM	7.1 YDS				

PRICING - KMU20IBLF

COM	4	5	6	7	8	9	10	11	
	3859	3969	4129	4309	4509	4789	4959	5319	6109

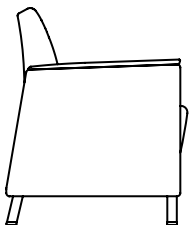
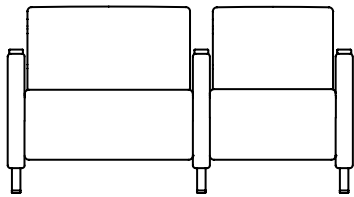

KMU20IBL - 2 SEAT LOUNGE LEFT BARIATRIC (FACING) WITH INTERVENING ARM, ARM CAPS

DIMENSIONS

Width	59.5	Seat Width	22 (29.5 bariatric)	Back Height	15
Depth	29	Seat Depth	20	Arm Height	25.5
Height	32.75	Seat Height	18.25	Weight	151
COM	7 YDS				

PRICING WITH URETHANE ARM CAPS - KMU20IBLU

COM	4	5	6	7	8	9	10	11	
	4009	4129	4279	4439	4649	4919	5109	5479	6269

PRICING WITH WOOD ARM CAPS - KMU20IBLW

COM	4	5	6	7	8	9	10	11	
	4169	4279	4429	4599	4809	5069	5259	5599	6379

PRICING WITH SOLID SURFACE ARM CAPS - KMU20IBLJ

COM	4	5	6	7	8	9	10	11	
	5019	5109	5259	5389	5599	5849	6019	6379	7059

**For above model with solid surface arm caps, add \$300 List for Group 2 solid surface finish*

TO ORDER, SPECIFY

- 1. Model Number 3. Finish
- 2. Textile 4. Options

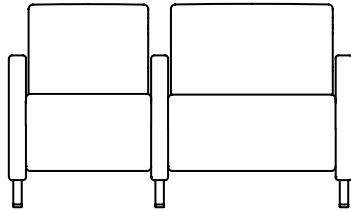

KMU20IBRF - 2 SEAT LOUNGE RIGHT BARIATRIC (FACING) WITH INTERVENING ARM, UPHOLSTERED ARMS

DIMENSIONS

Width	59.5	Seat Width	22 (29.5 bariatric)	Back Height	15
Depth	29	Seat Depth	20	Arm Height	25.25
Height	32.75	Seat Height	18.25	Weight	151
COM	7.1 YDS				

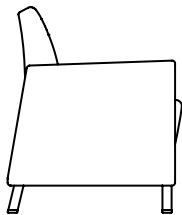

PRICING - KMU20IBRF

COM	4	5	6	7	8	9	10	11
3859	3969	4129	4309	4509	4789	4959	5319	6109

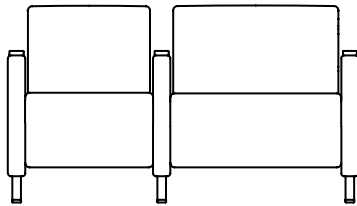

KMU20IBR - 2 SEAT LOUNGE RIGHT BARIATRIC (FACING) WITH INTERVENING ARM, ARM CAPS

DIMENSIONS

Width	59.5	Seat Width	22 (29.5 bariatric)	Back Height	15
Depth	29	Seat Depth	20	Arm Height	25.5
Height	32.75	Seat Height	18.25	Weight	151
COM	7 YDS				

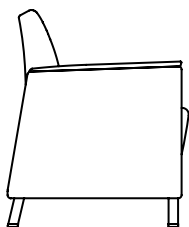

PRICING WITH URETHANE ARM CAPS - KMU20IBRU

COM	4	5	6	7	8	9	10	11
4009	4129	4279	4439	4649	4919	5109	5479	6269

PRICING WITH WOOD ARM CAPS - KMU20IBRW

COM	4	5	6	7	8	9	10	11
4169	4279	4429	4599	4809	5069	5259	5599	6379

PRICING WITH SOLID SURFACE ARM CAPS - KMU20IBRJ

COM	4	5	6	7	8	9	10	11
5019	5109	5259	5389	5599	5849	6019	6379	7059

**For above model with solid surface arm caps, add \$300 List for Group 2 solid surface finish*

TO ORDER, SPECIFY

- 1. Model Number 3. Finish
- 2. Textile 4. Options

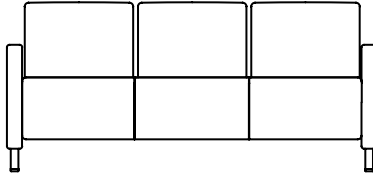

KMU30F - SOFA WITH UPHOLSTERED ARMS

DIMENSIONS

Width	71.5	Seat Width	66.5	Back Height	15
Depth	29	Seat Depth	20	Arm Height	25.25
Height	32.75	Seat Height	18.25	Weight	154
COM	7.1 YDS				

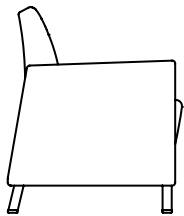

PRICING - KMU30F

COM	4	5	6	7	8	9	10	11
3739	3899	4089	4269	4539	4829	5069	5529	6429

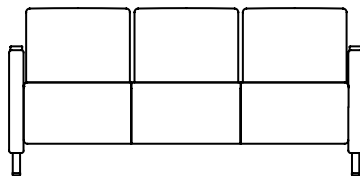

KMU30 - SOFA WITH ARM CAPS

DIMENSIONS

Width	71.5	Seat Width	66.5	Back Height	15
Depth	29	Seat Depth	20	Arm Height	25.5
Height	32.75	Seat Height	18.25	Weight	154
COM	7.1 YDS				

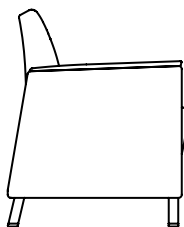

PRICING WITH URETHANE ARM CAPS - KMU30U

COM	4	5	6	7	8	9	10	11
3849	3989	4169	4369	4619	4909	5159	5619	6509

PRICING WITH WOOD ARM CAPS - KMU30W

COM	4	5	6	7	8	9	10	11
3949	4109	4279	4459	4729	5019	5269	5719	6609

PRICING WITH SOLID SURFACE ARM CAPS - KMU30J

COM	4	5	6	7	8	9	10	11
4509	4649	4829	5019	5249	5529	5769	6239	6939

**For above model with solid surface arm caps, add \$200 List for Group 2 solid surface finish*

TO ORDER, SPECIFY

- 1. Model Number 3. Finish
- 2. Textile 4. Options

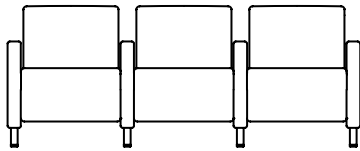

KMU30IF - 3 SEAT LOUNGE WITH INTERVENING UPHOLSTERED ARMS

DIMENSIONS

Width	76.5	Seat Width	22	Back Height	15
Depth	29	Seat Depth	20	Arm Height	25.25
Height	32.75	Seat Height	18.25	Weight	197
COM	9.2 YDS				

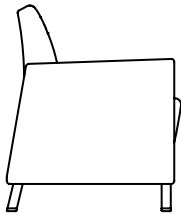

PRICING - KMU30IF

<i>COM</i>	4	5	6	7	8	9	10	11	
	4929	5119	5359	5599	5939	6299	6629	7199	7939

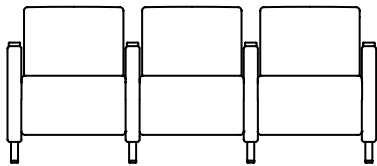

KMU30I - 3 SEAT LOUNGE WITH INTERVENING ARMS, ARM CAPS

DIMENSIONS

Width	76.5	Seat Width	22	Back Height	15
Depth	29	Seat Depth	20	Arm Height	25.5
Height	32.75	Seat Height	18.25	Weight	197
COM	9.2 YDS				

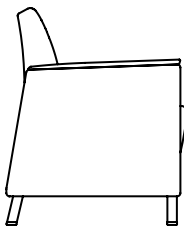

PRICING WITH URETHANE ARM CAPS - KMU30IU

<i>COM</i>	4	5	6	7	8	9	10	11	
	5149	5319	5559	6809	6139	6499	6809	7399	8159

PRICING WITH WOOD ARM CAPS - KMU30IW

<i>COM</i>	4	5	6	7	8	9	10	11	
	5349	5539	5769	6009	6319	6699	6999	7589	8259

PRICING WITH SOLID SURFACE ARM CAPS - KMU30IJ

<i>COM</i>	4	5	6	7	8	9	10	11	
	6479	6639	6859	7099	7399	7749	8029	8599	9149

**For above model with solid surface arm caps, add \$400 List for Group 2 solid surface finish*

TO ORDER, SPECIFY

- 1. Model Number 3. Finish
- 2. Textile 4. Options

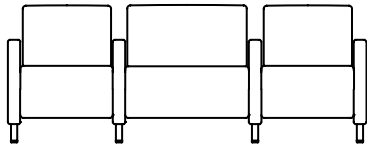

KMU30IBCF - 3 SEAT LOUNGE CENTER BARIATRIC WITH INTERVENING UPHOLSTERED ARMS

DIMENSIONS

Width	84.25	Seat Width	22 (29.5 bariatric)	Back Height	15
Depth	29	Seat Depth	20	Arm Height	25.25
Height	32.75	Seat Height	18.25	Weight	206
COM	9.6 YDS				

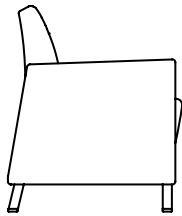

PRICING - KMU30IBCF

COM	4	5	6	7	8	9	10	11	
	5479	5619	5859	6079	6329	6679	6929	7509	8259

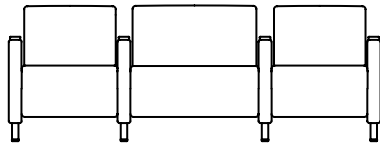

KMU30IBC - 3 SEAT LOUNGE CENTER BARIATRIC WITH INTERVENING ARMS, ARM CAPS

DIMENSIONS

Width	84.25	Seat Width	22 (29.5 bariatric)	Back Height	15
Depth	29	Seat Depth	20	Arm Height	25.5
Height	32.75	Seat Height	18.25	Weight	206
COM	9.5 YDS				

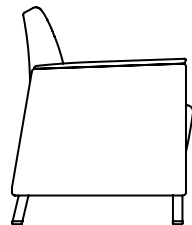

PRICING WITH URETHANE ARM CAPS - KMU30IBCU

COM	4	5	6	7	8	9	10	11	
	5679	5839	6059	6279	6539	6879	7129	7689	8509

PRICING WITH WOOD ARM CAPS - KMU30IBCW

COM	4	5	6	7	8	9	10	11	
	5889	6039	6269	6489	6739	7069	7309	7889	8609

PRICING WITH SOLID SURFACE ARM CAPS - KMU30IBCJ

COM	4	5	6	7	8	9	10	11	
	6999	7159	7359	7569	7809	8119	8339	8919	9459

**For above model with solid surface arm caps, add \$400 List for Group 2 solid surface finish*

TO ORDER, SPECIFY

- 1. Model Number 3. Finish
- 2. Textile 4. Options

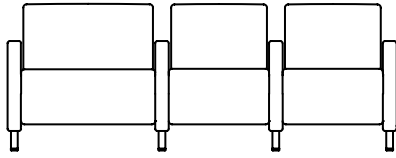

KMU30IBLF - 3 SEAT LOUNGE LEFT BARIATRIC (FACING) WITH INTERVENING UPHOLSTERED ARMS

DIMENSIONS

Width	84.25	Seat Width	22 (29.5 bariatric)	Back Height	15
Depth	29	Seat Depth	20	Arm Height	25.25
Height	32.75	Seat Height	18.25	Weight	206
COM	9.6 YDS				

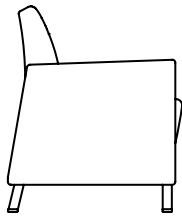

PRICING - KMU30IBLF

<i>COM</i>	4	5	6	7	8	9	10	11	
	5479	5619	5859	6079	6329	6679	6929	7509	8259

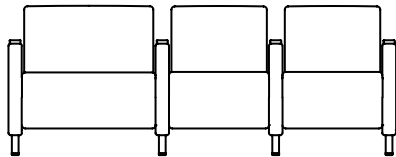

KMU30IBL - 3 SEAT LOUNGE LEFT BARIATRIC (FACING) WITH INTERVENING ARMS, ARM CAPS

DIMENSIONS

Width	84.25	Seat Width	22 (29.5 bariatric)	Back Height	15
Depth	29	Seat Depth	20	Arm Height	25.5
Height	32.75	Seat Height	18.25	Weight	206
COM	9.5 YDS				

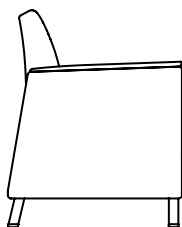

PRICING WITH URETHANE ARM CAPS - KMU30IBLU

<i>COM</i>	4	5	6	7	8	9	10	11	
	5679	5839	6059	6279	6539	6879	7129	7689	8509

PRICING WITH WOOD ARM CAPS - KMU30IBLW

<i>COM</i>	4	5	6	7	8	9	10	11	
	5889	6039	6269	6489	6739	7069	7309	7889	8609

PRICING WITH SOLID SURFACE ARM CAPS - KMU30IBLJ

<i>COM</i>	4	5	6	7	8	9	10	11	
	6999	7159	7359	7569	7809	8119	8339	8919	9459

**For above model with solid surface arm caps, add \$400 List for Group 2 solid surface finish*

TO ORDER, SPECIFY

- 1. Model Number 3. Finish
- 2. Textile 4. Options

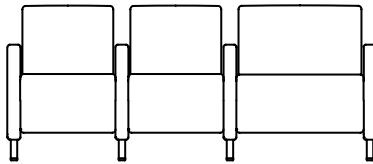

KMU30IBRF - 3 SEAT LOUNGE RIGHT BARIATRIC (FACING) WITH INTERVENING UPHOLSTERED ARMS

DIMENSIONS

Width	84.25	Seat Width	22 (29.5 bariatric)	Back Height	15
Depth	29	Seat Depth	20	Arm Height	25.25
Height	32.75	Seat Height	18.25	Weight	206
COM	9.6 YDS				

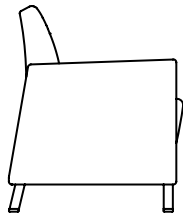

PRICING - KMU30IBRF

COM	4	5	6	7	8	9	10	11
5479	5619	5859	6079	6329	6679	6929	7509	8259

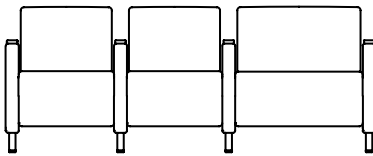

KMU30IBR - 3 SEAT LOUNGE RIGHT BARIATRIC (FACING) WITH INTERVENING ARMS, ARM CAPS

DIMENSIONS

Width	84.25	Seat Width	22 (29.5 bariatric)	Back Height	15
Depth	29	Seat Depth	20	Arm Height	25.5
Height	32.75	Seat Height	18.25	Weight	206
COM	9.5 YDS				

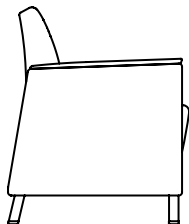

PRICING WITH URETHANE ARM CAPS - KMU30IBRU

COM	4	5	6	7	8	9	10	11
5679	5839	6059	6279	6539	6879	7129	7689	8509

PRICING WITH WOOD ARM CAPS - KMU30IBRW

COM	4	5	6	7	8	9	10	11
5889	6039	6269	6489	6739	7069	7309	7889	8609

PRICING WITH SOLID SURFACE ARM CAPS - KMU30IBRJ

COM	4	5	6	7	8	9	10	11
6999	7159	7359	7569	7809	8119	8339	8919	9459

**For above model with solid surface arm caps, add \$400 List for Group 2 solid surface finish*

Kascade Lounge Seating

Standard Product Information

- All Interior Joints are CNC Cut/Puzzle-Jointed, Corner Blocked, Screwed, and Glued Together
- Commercial Grade Double Walled Plywood Interior Frame
- 14 Gauge Steel Support Tubes Connect Arms
- Seat Foam is 2.8 High Resilience Density Foam that Meets CAL 117 Fire Standards
- Back Foam is 2.5 Density Foam that Meets CAL 117 Fire Standards
- Steel Sinuous Seat and Back Springs
- Field Replaceable Components
- Seat Clean-Out
- Metal or Wood Legs Standard with Adjustable Glides
- Kiln-Dried Hardwood Interior Components



Leg Options

Please specify ML or WL when ordering.

- ML 4 Metal Legs with Adjustable Glides
540 Pewter {Standard}
- WL 4 Wood Legs with Adjustable Glides
Please refer to page 10 for color options
- WTL 4 Wood Tapered Legs with Adjustable Glides
(Add \$279 List Upcharge)

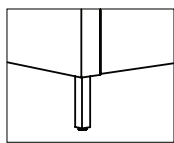

ML

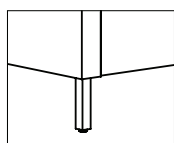

WL

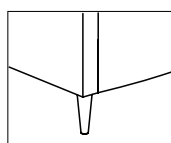

WTL

Power Option

PU1-2 Power (Add \$209 List Upcharge) - Narrow Arm Models

PU1-3 Power (Add \$209 List Upcharge) - Wide Arm Models

Power will be installed on outside of left arm facing - 3.5" arms

Power will be installed on front left arm facing - 8.5" arms

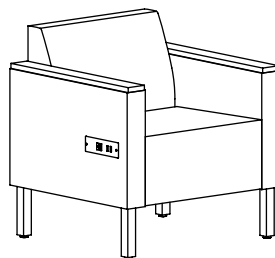

Moisture Barrier Options

Please refer to page 14.

CAL TB133

Please refer to page 12.



TO ORDER, SPECIFY

- 1. Model Number
- 2. Textile
- 3. Finish
- 4. Options

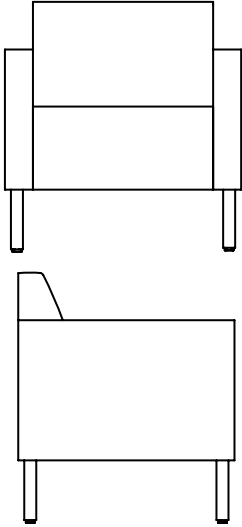

KAS10F - LOUNGE CHAIR | 3.5" ARMS, 22" SEAT WIDTH, 27.75" DEPTH, UPHOLSTERED ARMS

DIMENSIONS

Width	29.5	Seat Width	22.25	Back Height	14.5
Depth	27.75	Seat Depth	19.125	Arm Height	25.25
Height	31.75	Seat Height	18.375	Weight	71
COM	4 YDS				

PRICING - KAS10F

COM	4	5	6	7	8	9	10	11
1839	1939	2029	2089	2249	2369	2509	2749	3269

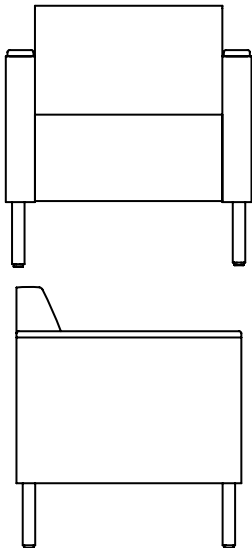

KAS10A - LOUNGE CHAIR | 3.5" ARMS, 22" SEAT WIDTH, 27.75" DEPTH, THERMOFOIL ARM CAPS

DIMENSIONS

Width	29.5	Seat Width	22.25	Back Height	14.5
Depth	27.75	Seat Depth	19.125	Arm Height	26
Height	31.75	Seat Height	18.375	Weight	74
COM	4 YDS				

PRICING - KAS10A

COM	4	5	6	7	8	9	10	11
1929	2019	2099	2199	2349	2499	2609	2839	3349

**Please contact us for Solid Surface Arm Cap pricing*

TO ORDER, SPECIFY

- 1. Model Number 3. Finish
- 2. Textile 4. Options

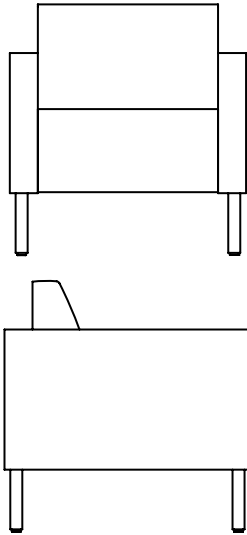

KAS13F - LOUNGE CHAIR | 3.5" ARMS, 22" SEAT WIDTH, 31.25" DEPTH, UPHOLSTERED ARMS

DIMENSIONS

Width	29.5	Seat Width	22.25	Back Height	14.5
Depth	31.25	Seat Depth	19.125	Arm Height	25.25
Height	31.75	Seat Height	18.375	Weight	90
COM	4 YDS				

PRICING - KAS13F

COM	4	5	6	7	8	9	10	11
1939	2029	2119	2239	2359	2539	2659	2909	3499

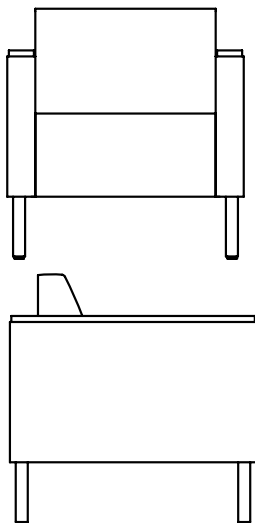

KAS13A - LOUNGE CHAIR | 3.5" ARMS, 22" SEAT WIDTH, 31.25" DEPTH, THERMOFOIL ARM CAPS, BACK RAIL CAPS

DIMENSIONS

Width	29.5	Seat Width	22.25	Back Height	14.5
Depth	31.25	Seat Depth	19.125	Arm Height	26
Height	31.75	Seat Height	18.375	Weight	93
COM	4 YDS				

PRICING - KAS13A

COM	4	5	6	7	8	9	10	11
2039	2119	2229	2329	2469	2629	2749	2999	3549

**Please contact us for Solid Surface Arm Cap pricing*

TO ORDER, SPECIFY

- 1. Model Number
- 2. Textile
- 3. Finish
- 4. Options

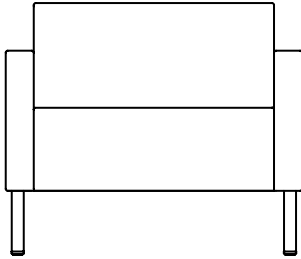

KAS10BF- BARIATRIC LOUNGE CHAIR | 3.5" ARMS, 30" SEAT WIDTH, 27.75" DEPTH, UPHOLSTERED ARMS

DIMENSIONS

Width	37.25	Seat Width	30	Back Height	14.5
Depth	27.25	Seat Depth	19.125	Arm Height	25.25
Height	31.75	Seat Height	18.375	Weight	80
COM	5 YDS				

PRICING - KAS10BF

COM	4	5	6	7	8	9	10	11
2009	2089	2169	2289	2399	2599	2709	2969	3709

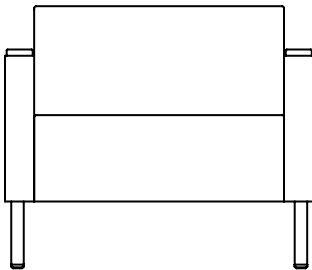
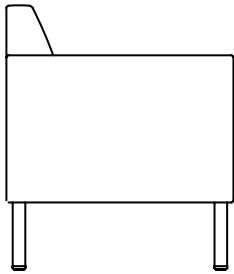

KAS10BA - BARIATRIC LOUNGE CHAIR | 3.5" ARMS, 30" SEAT WIDTH, 27.75" DEPTH, THERMOFOIL ARM CAPS

DIMENSIONS

Width	37.25	Seat Width	30	Back Height	14.5
Depth	27.75	Seat Depth	19.125	Arm Height	26
Height	31.75	Seat Height	18.375	Weight	83
COM	5 YDS				

PRICING - KAS10BA

COM	4	5	6	7	8	9	10	11
2069	2139	2259	2349	2489	2659	2769	3019	3789

**Please contact us for Solid Surface Arm Cap pricing*

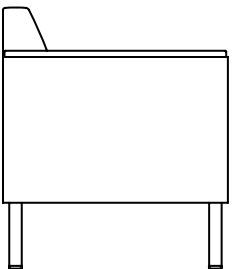

TO ORDER, SPECIFY

- 1. Model Number 3. Finish
- 2. Textile 4. Options

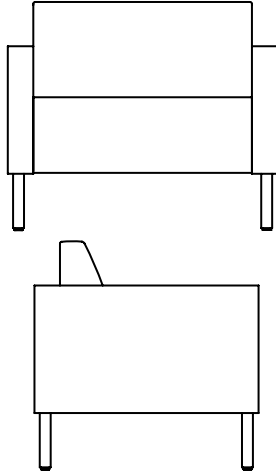

KAS13BF - BARIATRIC LOUNGE CHAIR | 3.5" ARMS, 30" SEAT WIDTH, 31.25" DEPTH, UPHOLSTERED ARMS

DIMENSIONS

Width	37.25	Seat Width	30	Back Height	14.5
Depth	31.25	Seat Depth	19.125	Arm Height	25.25
Height	31.75	Seat Height	18.375	Weight	100
COM	5 YDS				

PRICING - KAS13BF

<i>COM</i>	4	5	6	7	8	9	10	11
2109	2169	2299	2379	2519	2699	2799	3059	3999

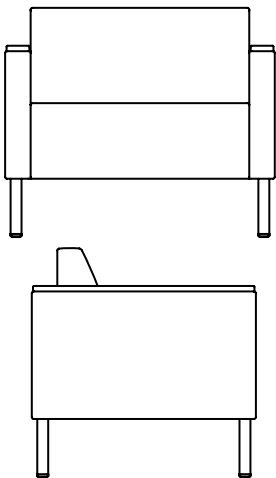

KAS13BA - BARIATRIC LOUNGE CHAIR | 3.5" ARMS, 30" SEAT WIDTH, 31.25" DEPTH, THERMOFOIL ARM CAPS, BACK RAIL CAPS

DIMENSIONS

Width	37.25	Seat Width	30	Back Height	14.5
Depth	31.25	Seat Depth	19.125	Arm Height	26
Height	31.75	Seat Height	18.375	Weight	103
COM	5 YDS				

PRICING - KAS13BA

<i>COM</i>	4	5	6	7	8	9	10	11
2199	2309	2389	2499	2629	2789	2909	3159	4099

**Please contact us for Solid Surface Arm Cap pricing*

TO ORDER, SPECIFY

- 1. Model Number
- 2. Textile
- 3. Finish
- 4. Options

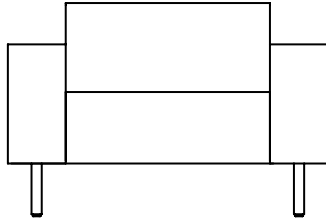

KAS18F- LOUNGE CHAIR | 8.5" ARMS, 30" SEAT WIDTH, 31.25" DEPTH, UPHOLSTERED ARMS

DIMENSIONS

Width	48	Seat Width	30	Back Height	14.5
Depth	31.25	Seat Depth	19.125	Arm Height	25.25
Height	31.75	Seat Height	18.375	Weight	89
COM	5 YDS				

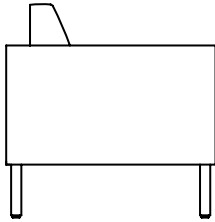

PRICING - KAS18F

COM	4	5	6	7	8	9	10	11
2149	2259	2349	2449	2569	2749	2849	3099	4159

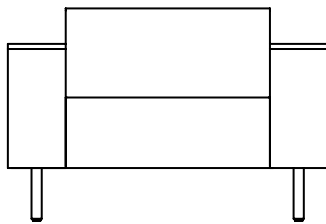

KAS18A - LOUNGE CHAIR | 8.5" ARMS, 30" SEAT WIDTH, 31.25" DEPTH, THERMOFOIL ARM CAPS AND BACK RAIL CAPS

DIMENSIONS

Width	48	Seat Width	30	Back Height	14.5
Depth	31.25	Seat Depth	19.125	Arm Height	25.25
Height	31.75	Seat Height	18.375	Weight	92
COM	5 YDS				

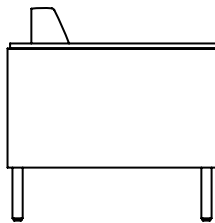

PRICING - KAS18A

COM	4	5	6	7	8	9	10	11
2299	2399	2489	2579	2729	2869	2999	3239	4309

**Please contact us for Solid Surface Arm Cap pricing*

TO ORDER, SPECIFY

- 1. Model Number 3. Finish
- 2. Textile 4. Options

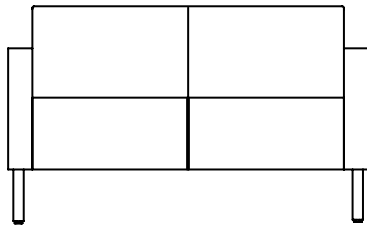

KAS20F - 2 SEAT LOUNGE CHAIR | 3.5" ARMS, 27.75" DEPTH, UPHOLSTERED ARMS

DIMENSIONS

Width	51	Seat Width	44.5	Back Height	14.5
Depth	27.75	Seat Depth	19.125	Arm Height	25.25
Height	31.75	Seat Height	18.375	Weight	99
COM	5.5 YDS				

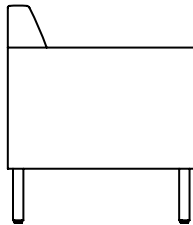

PRICING - KAS20F

<i>COM</i>	<i>4</i>	<i>5</i>	<i>6</i>	<i>7</i>	<i>8</i>	<i>9</i>	<i>10</i>	<i>11</i>
2609	2749	2869	3019	3229	3459	3639	3979	4449

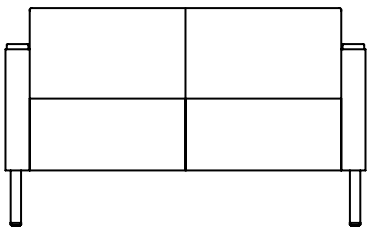

KAS20A - 2 SEAT LOUNGE CHAIR | 3.5" ARMS, 27.75" DEPTH, THERMOFOIL ARM CAPS

DIMENSIONS

Width	51	Seat Width	44.5	Back Height	14.5
Depth	27.75	Seat Depth	19.125	Arm Height	26
Height	31.75	Seat Height	18.375	Weight	102
COM	5.5 YDS				

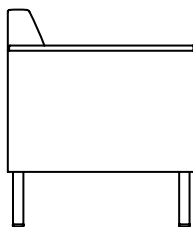

PRICING - KAS20A

<i>COM</i>	<i>4</i>	<i>5</i>	<i>6</i>	<i>7</i>	<i>8</i>	<i>9</i>	<i>10</i>	<i>11</i>
2689	2809	2949	3089	3289	3519	3699	4049	4549

**Please contact us for Solid Surface Arm Cap pricing*

TO ORDER, SPECIFY

- 1. Model Number
- 2. Textile
- 3. Finish
- 4. Options

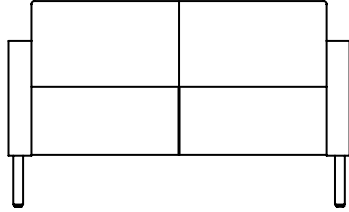

KAS23F- 2 SEAT LOUNGE CHAIR | 3.5" ARMS, 31.25" DEPTH, UPHOLSTERED ARMS

DIMENSIONS

Width	52	Seat Width	44.5	Back Height	14.5
Depth	31.25	Seat Depth	19.125	Arm Height	25.25
Height	31.75	Seat Height	18.375	Weight	125
COM	5.5 YDS				

PRICING - KAS23F

COM	4	5	6	7	8	9	10	11
3019	3129	3239	3389	3559	3729	3909	4229	4869

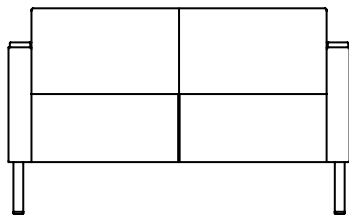
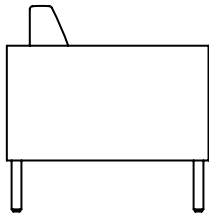

KAS23A- 2 SEAT LOUNGE CHAIR | 3.5" ARMS, 31.25" DEPTH, THERMOFOIL ARM CAPS AND BACK RAIL CAPS

DIMENSIONS

Width	52	Seat Width	44.5	Back Height	14.5
Depth	31.25	Seat Depth	19.125	Arm Height	26
Height	31.75	Seat Height	18.375	Weight	128
COM	5.5 YDS				

PRICING - KAS23A

COM	4	5	6	7	8	9	10	11
3149	3259	3359	3479	3719	3899	4019	4379	5039

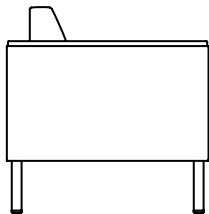

**Please contact us for Solid Surface Arm Cap pricing*

TO ORDER, SPECIFY

- 1. Model Number 3. Finish
- 2. Textile 4. Options

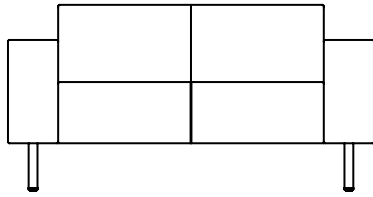

KAS28F - 2 SEAT LOUNGE CHAIR | 8.5" ARMS, 31.25" DEPTH, UPHOLSTERED ARMS

DIMENSIONS

Width	64	Seat Width	44.5	Back Height	14.5
Depth	31.25	Seat Depth	19.125	Arm Height	25.25
Height	31.75	Seat Height	18.375	Weight	133
COM	6.5 YDS				

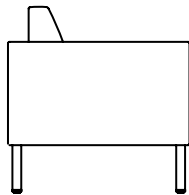

PRICING - KAS28F

<i>COM</i>	<i>4</i>	<i>5</i>	<i>6</i>	<i>7</i>	<i>8</i>	<i>9</i>	<i>10</i>	<i>11</i>
3059	3189	3279	3419	3629	3779	3939	4289	4809

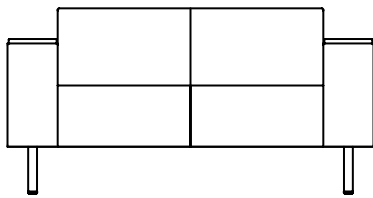

KAS28A - 2 SEAT LOUNGE CHAIR | 8.5" ARMS, 31.25" DEPTH, THERMOFOIL ARM CAPS, BACK RAIL CAPS

DIMENSIONS

Width	64	Seat Width	44.5	Back Height	14.5
Depth	31.25	Seat Depth	19.125	Arm Height	26
Height	31.75	Seat Height	18.375	Weight	136
COM	6.5 YDS				

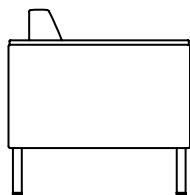

PRICING - KAS28A

<i>COM</i>	<i>4</i>	<i>5</i>	<i>6</i>	<i>7</i>	<i>8</i>	<i>9</i>	<i>10</i>	<i>11</i>
3199	3299	3419	3519	3759	3939	4069	4409	4919

**Please contact us for Solid Surface Arm Cap pricing*

TO ORDER, SPECIFY

- 1. Model Number 3. Finish
- 2. Textile 4. Options

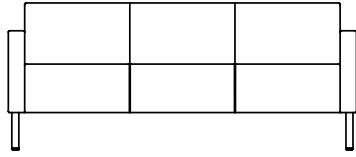

KAS30F - 3 SEAT LOUNGE CHAIR | 3.5" ARMS, 27.75" DEPTH, UPHOLSTERED ARMS

DIMENSIONS

Width	74	Seat Width	66.5	Back Height	14.5
Depth	27.75	Seat Depth	19.125	Arm Height	25.25
Height	31.75	Seat Height	18.375	Weight	123
COM	7 YDS				

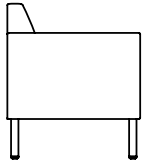

PRICING - KAS30F

COM	4	5	6	7	8	9	10	11	
	3259	3429	3589	3819	3979	4339	4569	4969	5629

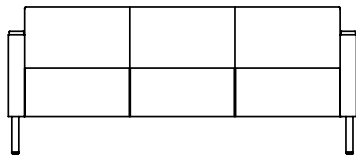

KAS30A - 3 SEAT LOUNGE CHAIR | 3.5" ARMS, 27.75" DEPTH, THERMOFOIL ARM CAPS

DIMENSIONS

Width	74	Seat Width	66.5	Back Height	14.5
Depth	27.75	Seat Depth	19.125	Arm Height	26
Height	31.75	Seat Height	18.375	Weight	126
COM	7 YDS				

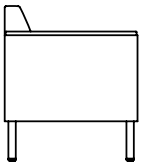

PRICING - KAS30A

COM	4	5	6	7	8	9	10	11	
	3299	3479	3649	3889	4039	4349	4619	5019	5779

**Please contact us for Solid Surface Arm Cap pricing*

TO ORDER, SPECIFY

- 1. Model Number 3. Finish
- 2. Textile 4. Options

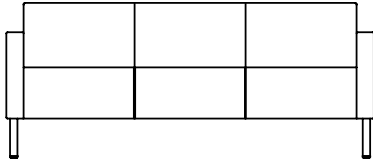

KAS33F - 3 SEAT LOUNGE CHAIR | 3.5" ARMS, 31.25" DEPTH, UPHOLSTERED ARMS

DIMENSIONS

Width	74	Seat Width	66.75	Back Height	14.5
Depth	31.25	Seat Depth	19.125	Arm Height	25.25
Height	31.75	Seat Height	18.375	Weight	152

COM 7.5 YDS

PRICING - KAS33F

COM	4	5	6	7	8	9	10	11
3639	3769	3959	4139	4389	4669	4919	5359	6079

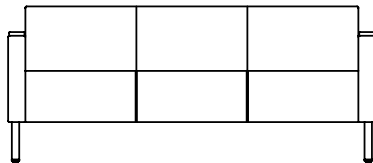
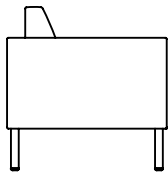

KAS33A - 3 SEAT LOUNGE CHAIR | 3.5" ARMS, 31.25" DEPTH, THERMOFOIL ARM CAPS, BACK RAIL CAPS

DIMENSIONS

Width	74	Seat Width	66.75	Back Height	14.5
Depth	31.25	Seat Depth	19.125	Arm Height	26
Height	31.75	Seat Height	18.375	Weight	155

COM 7.5 YDS

PRICING - KAS33A

COM	4	5	6	7	8	9	10	11
3749	3909	4089	4269	4519	4799	5039	5489	6199

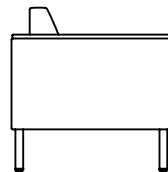

**Please contact us for Solid Surface Arm Cap pricing*

TO ORDER, SPECIFY

- 1. Model Number
- 2. Textile
- 3. Finish
- 4. Options

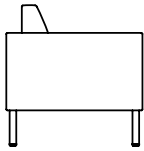
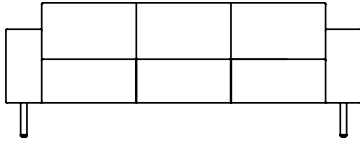

KAS38F - 3 SEAT LOUNGE CHAIR | 8.5" ARMS, 31.25" DEPTH, UPHOLSTERED ARMS

DIMENSIONS

Width	85	Seat Width	66.75	Back Height	14.5
Depth	31.25	Seat Depth	19.125	Arm Height	25.25
Height	31.75	Seat Height	18.375	Weight	173
COM	8 YDS				

PRICING - KAS38F

COM	4	5	6	7	8	9	10	11
3689	3819	3999	4189	4439	4729	4999	5399	6239

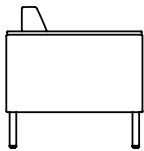
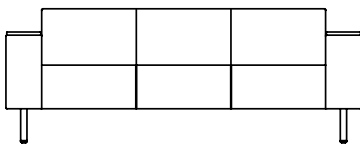

KAS38A - 3 SEAT LOUNGE CHAIR | 8.5" ARMS, 31.25" DEPTH, THERMOFOIL ARM CAPS

DIMENSIONS

Width	85	Seat Width	66.75	Back Height	14.5
Depth	31.25	Seat Depth	19.125	Arm Height	26
Height	31.75	Seat Height	18.375	Weight	176
COM	8 YDS				

PRICING - KAS38A

COM	4	5	6	7	8	9	10	11
3839	3979	4149	4349	4589	4869	5129	5549	6379

**Please contact us for Solid Surface Arm Cap pricing*

Koncert Lounge Seating

Standard Product Information

- Passive Flex Back
- Clean-Out Between Seat and Back
- High Quality Comfort Webbing in Guest Seats and Sinuous Springs in Backs
- 16 Gauge Steel Frame
- 2.8 Density HR Seat Foam TB117-2013
- 1.7 Density Back Foam TB117-2013
- Heavy Steel Rails Connect Arms and Seats
- Field Replaceable Components
- Wall-Saver Leg Design
- Adjustable Glides

Dimensions

▪ Width (Guest)	25.75"
▪ Width (Bariatric)	33.5"
▪ Depth	32"
▪ Height	33"
▪ Seat Width (Guest)	22"
▪ Seat Width (Bariatric)	29.5"
▪ Weight Capacity (Guest)	550 lbs
▪ Weight Capacity (Bariatric)	750 lbs



Wood and Urethane Arm Cap Finishes

Please refer to page 14.

CAL TB133

Please refer to page 12.

Moisture Barrier Options

Please refer to page 14.

Powder Coat Finish Options

Standard color is 540 Pewter. 211 Silver Frost is also available upon request. For other metal powder coat finishes, please contact Customer Service at customerservice@getknu.com.



TO ORDER, SPECIFY

- 1. Model Number
- 2. Textile
- 3. Finish
- 4. Options

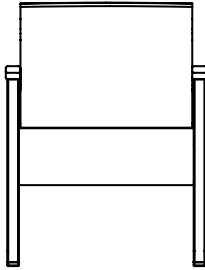

KOL10 - LOUNGE CHAIR WITH ARM CAPS

DIMENSIONS

Width	25.75	Seat Width	22	Back Height	15
Depth	32	Seat Depth	19	Arm Height	25.5
Height	33	Seat Height	18	Weight	62
COM	2 YDS				

PRICING WITH URETHANE ARM CAPS - KOL10U

COM	4	5	6	7	8	9	10	11
1769	1799	1829	1889	1939	2029	2139	2269	2499

PRICING WITH WOOD ARM CAPS - KOL10W

COM	4	5	6	7	8	9	10	11
1769	1799	1829	1889	1939	2029	2139	2269	2499

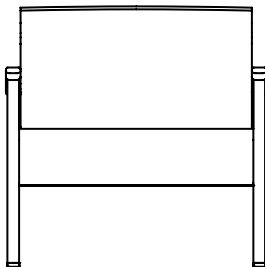
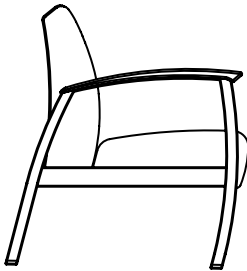

KOL10B - BARIATRIC LOUNGE WITH ARM CAPS

DIMENSIONS

Width	33.5	Seat Width	29.5	Back Height	15
Depth	32	Seat Depth	19	Arm Height	25.5
Height	33	Seat Height	18	Weight	76
COM	3 YDS				

PRICING WITH URETHANE ARM CAPS - KOL10BU

COM	4	5	6	7	8	9	10	11
1999	2019	2059	2139	2249	2359	2489	2549	2919

PRICING WITH WOOD ARM CAPS - KOL10BW

COM	4	5	6	7	8	9	10	11
1999	2019	2059	2139	2249	2359	2489	2549	2919

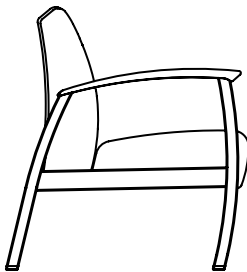

TO ORDER, SPECIFY

- 1. Model Number
- 2. Textile
- 3. Finish
- 4. Options

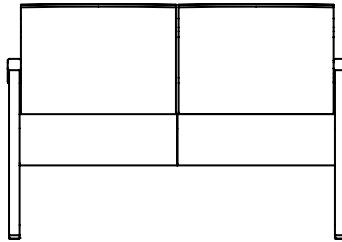

KOL20 - 2 SEAT LOUNGE CHAIR WITH ARM CAPS

DIMENSIONS

Width	48.25	Seat Width	44.25	Back Height	15
Depth	32	Seat Depth	19	Arm Height	25.5
Height	33	Seat Height	18	Weight	100
COM	3.5 YDS				

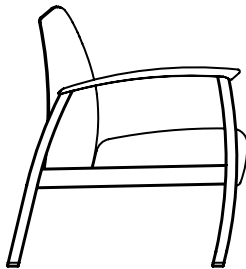

PRICING WITH URETHANE ARM CAPS - KOL20U

COM	4	5	6	7	8	9	10	11	
	2599	2639	2719	2809	2929	3069	3209	3329	3819

PRICING WITH WOOD ARM CAPS - KOL20W

COM	4	5	6	7	8	9	10	11	
	2599	2639	2719	2809	2929	3069	3209	3329	3819

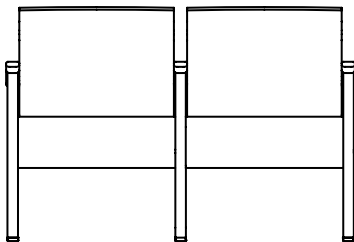

KOL20I - 2 SEAT LOUNGE CHAIR WITH INTERVENING ARM AND ARM CAPS

DIMENSIONS

Width	49.5	Seat Width	22	Back Height	15
Depth	32	Seat Depth	19	Arm Height	25.5
Height	33	Seat Height	18	Weight	112
COM	3.5 YDS				

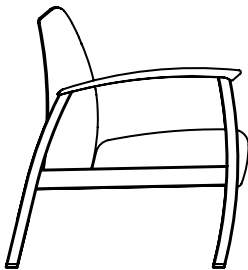

PRICING WITH URETHANE ARM CAPS - KOL20IU

COM	4	5	6	7	8	9	10	11	
	3319	3419	3499	3669	3859	4089	4349	4499	4589

PRICING WITH WOOD ARM CAPS - KOL20IW

COM	4	5	6	7	8	9	10	11	
	3319	3419	3499	3669	3859	4089	4349	4499	4589

TO ORDER, SPECIFY

- 1. Model Number
- 2. Textile
- 3. Finish
- 4. Options

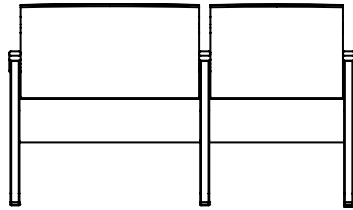

KOL20IBL - 2 SEAT 29.5" LEFT BARIATRIC (FACING) LOUNGE CHAIR WITH INTERVENING ARM, ARM CAPS

DIMENSIONS

Width	57.25	Seat Width	29.5	Back Height	15
Depth	32	Seat Depth	19	Arm Height	25.5
Height	33	Seat Height	18	Weight	123
COM	4 YDS				

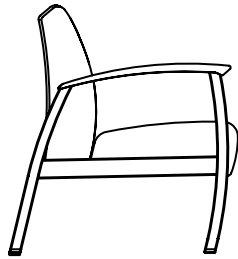

PRICING WITH URETHANE ARM CAPS - KOL20IBLU

COM	4	5	6	7	8	9	10	11
3269	3319	3409	3499	3649	3819	3999	4129	4589

PRICING WITH WOOD ARM CAPS - KOL20IBLW

COM	4	5	6	7	8	9	10	11
3269	3319	3409	3499	3649	3819	3999	4129	4589

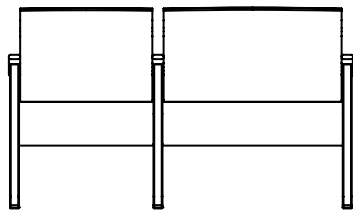

KOL20IBR - 2 SEAT 29.5" RIGHT BARIATRIC (FACING) LOUNGE CHAIR WITH INTERVENING ARM, ARM CAPS

DIMENSIONS

Width	57.25	Seat Width	29.5	Back Height	15
Depth	32	Seat Depth	19	Arm Height	25.5
Height	33	Seat Height	18	Weight	123
COM	4 YDS				

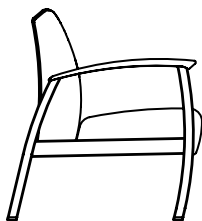

PRICING WITH URETHANE ARM CAPS - KOL20IBRU

COM	4	5	6	7	8	9	10	11
3269	3319	3409	3499	3649	3819	3999	4129	4589

PRICING WITH WOOD ARM CAPS - KOL20IBRW

COM	4	5	6	7	8	9	10	11
3269	3319	3409	3499	3649	3819	3999	4129	4589

TO ORDER, SPECIFY

- 1. Model Number 3. Finish
- 2. Textile 4. Options

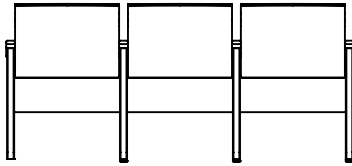

KOL30I - 3 SEAT LOUNGE CHAIR WITH INTERVENING ARMS, ARM CAPS

DIMENSIONS

Width	73.5	Seat Width	22	Back Height	15
Depth	32	Seat Depth	19	Arm Height	25.5
Height	33	Seat Height	18	Weight	158
COM	5.5 YDS				

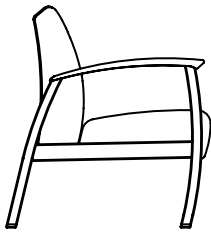

PRICING WITH URETHANE ARM CAPS - KOL30IU

COM	4	5	6	7	8	9	10	11
4509	4619	4679	4869	5069	5349	5579	5799	5959

PRICING WITH WOOD ARM CAPS - KOL30IW

COM	4	5	6	7	8	9	10	11
4509	4619	4679	4869	5069	5349	5579	5799	5959

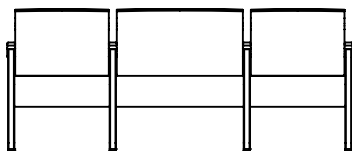

KOL30IBC - 3 SEAT 29.5" CENTER BARIATRIC LOUNGE CHAIR WITH INTERVENING ARMS, ARM CAPS

DIMENSIONS

Width	81.25	Seat Width	29.5	Back Height	15
Depth	32	Seat Depth	19	Arm Height	25.5
Height	33	Seat Height	18	Weight	153
COM	5.5 YDS				

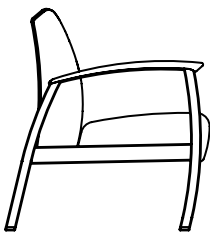

PRICING WITH URETHANE ARM CAPS - KOL30IBCU

COM	4	5	6	7	8	9	10	11
4359	4449	4559	4689	4899	5149	5419	5619	5959

PRICING WITH WOOD ARM CAPS - KOL30BCW

COM	4	5	6	7	8	9	10	11
4359	4449	4559	4689	4899	5149	5419	5619	5959

TO ORDER, SPECIFY

- 1. Model Number
- 2. Textile
- 3. Finish
- 4. Options

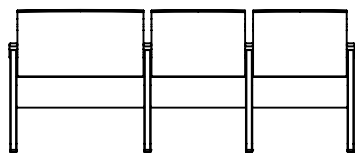

KOL30IBL - 3 SEAT 29.5" LEFT (FACING) BARIATRIC LOUNGE CHAIR WITH INTERVENING ARMS, ARM CAPS

DIMENSIONS

Width	81.25	Seat Width	29.5	Back Height	15
Depth	32	Seat Depth	19	Arm Height	25.5
Height	33	Seat Height	18	Weight	153
COM	5.5 YDS				

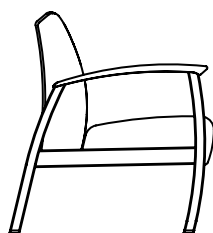

PRICING WITH URETHANE ARM CAPS - KOL30IBLU

COM	4	5	6	7	8	9	10	11
4359	4449	4559	4689	4899	5149	5419	5619	5959

PRICING WITH WOOD ARM CAPS - KOL30IBLW

COM	4	5	6	7	8	9	10	11
4359	4449	4559	4689	4899	5149	5419	5619	5959

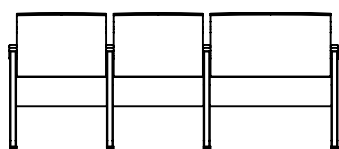

KOL30IBR - 3 SEAT 29.5" RIGHT (FACING) BARIATRIC LOUNGE CHAIR WITH INTERVENING ARMS, ARM CAPS

DIMENSIONS

Width	81.25	Seat Width	29.5	Back Height	15
Depth	32	Seat Depth	19	Arm Height	25.5
Height	33	Seat Height	18	Weight	153
COM	5.5 YDS				

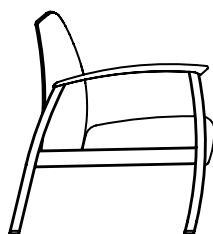

PRICING WITH URETHANE ARM CAPS - KOL30IBRU

COM	4	5	6	7	8	9	10	11
4359	4449	4559	4689	4899	5149	5419	5619	5959

PRICING WITH WOOD ARM CAPS - KOL30IBRW

COM	4	5	6	7	8	9	10	11
4359	4449	4559	4689	4899	5149	5419	5619	5959

Koncert Upholstered Lounge Seating

Standard Product Information

- Fully Upholstered Arms, Urethane, Wood, or Corian® Solid Surface Arm Caps
- Passive Flex Back
- Seat Clean-Out
- Wall-Saver Leg Design
- Wood Feet Standard {Metal Feet Option}
- All Interior Joints are CNC Cut/Puzzle-Jointed, Corner Blocked, Screwed, and Glued Together
- Commercial Grade Double Walled Plywood Interior Frame
- 14 Gauge Steel Support Tubes Connect Arms
- Seat Foam is 2.8 High Resilience Density Foam that Meets CAL 117 Fire Standards
- Back Foam is 1.7 Density Foam that Meets CAL 117 Fire Standards
- Comfort Webbing in Seats and Sinuous Springs in Backs
- Field Replaceable Components

Dimensions

▪ Width (Standard Chair)	27.25"
▪ Width (Bariatric Chair)	34.5"
▪ Depth	30"
▪ Height	33.75"
▪ Seat Width (Standard Chair)	21.75"
▪ Seat Width (Bariatric Chair)	29.5"
▪ Weight Capacity (Standard Chair)	550 lbs
▪ Weight Capacity (Bariatric Chair)	750 lbs



Power Options

PU1-2 Power (Add \$209 List Upcharge)
 Power will be installed on outside of left arm facing

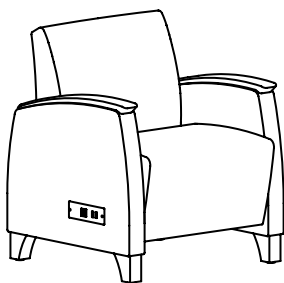

KOU10U shown with optional power (PU1-2)

CAL TB133

Please refer to page 12.

Feet Options

Please specify MF or WF when ordering.
 Available in 042 Black, 211 Silver Frost, and 540 Pewter.

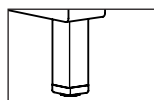

MF4-LEG4 4 Metal Feet (Add \$109 List Upcharge) - 1 Seat
 6 Metal Feet (Add \$169 List Upcharge) - 2 Seats
 8 Metal Feet (Add \$229 List Upcharge) - 3 Seats

Arm Cap Options

Please refer to page 14 for wood + urethane + solid surface color options.

- F Fully Upholstered Arms
- U Urethane Arm Caps
- W Wood Arm Caps
- J Corian® Solid Surface

Moisture Barrier Options

Please refer to page 14.



TO ORDER, SPECIFY

- 1. Model Number
- 2. Textile
- 3. Finish
- 4. Options

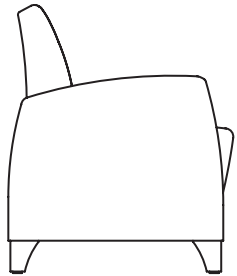
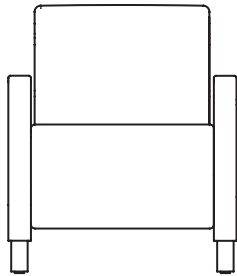

KOU10F - UPHOLSTERED LOUNGE CHAIR WITH UPHOLSTERED ARMS

DIMENSIONS

Width	27.25	Seat Width	21.75	Back Height	15.75
Depth	30	Seat Depth	19	Arm Height	25
Height	33.75	Seat Height	18	Weight	82
COM	4 YDS				

PRICING - KOU10F

COM	4	5	6	7	8	9	10	11
1999	2069	2139	2269	2379	2549	2679	2889	3379

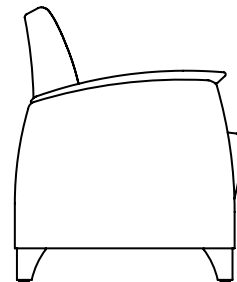
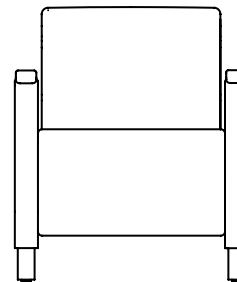

KOU10 - UPHOLSTERED LOUNGE CHAIR WITH ARM CAPS

DIMENSIONS

Width	27.25	Seat Width	21.75	Back Height	15.75
Depth	30	Seat Depth	19	Arm Height	26
Height	33.75	Seat Height	18	Weight	82
COM	4 YDS				

PRICING WITH URETHANE ARM CAPS - KOU10U

COM	4	5	6	7	8	9	10	11
2089	2149	2259	2359	2489	2639	2759	2989	3449

PRICING WITH WOOD ARM CAPS - KOU10W

COM	4	5	6	7	8	9	10	11
2169	2269	2359	2469	2579	2749	2849	3079	3509

PRICING WITH SOLID SURFACE ARM CAPS - KOU10J

COM	4	5	6	7	8	9	10	11
2759	2819	2889	3009	3119	3259	3379	3609	3889

**For above model with solid surface arm caps, add \$200 List for Group 2 solid surface finish*

TO ORDER, SPECIFY

- 1. Model Number 3. Finish
- 2. Textile 4. Options

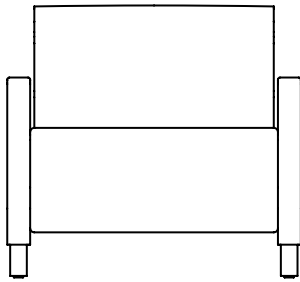

KOU10BF - BARIATRIC UPHOLSTERED LOUNGE CHAIR WITH UPHOLSTERED ARMS

DIMENSIONS

Width	34.5	Seat Width	29.5	Back Height	15.75
Depth	30	Seat Depth	19	Arm Height	25
Height	33.75	Seat Height	18	Weight	102
COM	4.5 YDS				

PRICING - KOU10BF

<i>COM</i>	4	5	6	7	8	9	10	11
2349	2429	2509	2589	2729	2839	2959	3209	3819

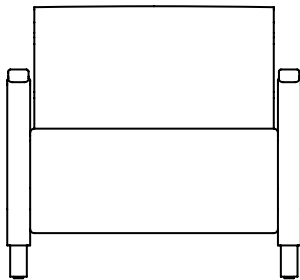
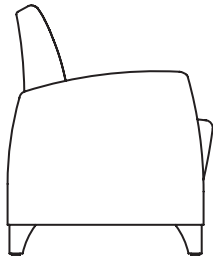

KOU10B - BARIATRIC UPHOLSTERED LOUNGE CHAIR WITH ARM CAPS

DIMENSIONS

Width	34.5	Seat Width	29.5	Back Height	15.75
Depth	30	Seat Depth	19	Arm Height	26
Height	33.75	Seat Height	18	Weight	102
COM	4.5 YDS				

PRICING WITH URETHANE ARM CAPS - KOU10BU

<i>COM</i>	4	5	6	7	8	9	10	11
2469	2529	2609	2709	2809	2959	3049	3299	3909

PRICING WITH WOOD ARM CAPS - KOU10BW

<i>COM</i>	4	5	6	7	8	9	10	11
2549	2609	2719	2799	2909	3049	3149	3409	3969

PRICING WITH SOLID SURFACE ARM CAPS - KOU10BJ

<i>COM</i>	4	5	6	7	8	9	10	11
3129	3189	3249	3319	3449	3559	3669	3909	4359

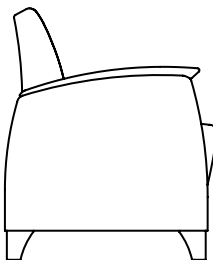

**For above model with solid surface arm caps, add \$200 List for Group 2 solid surface finish*

TO ORDER, SPECIFY

- 1. Model Number 3. Finish
- 2. Textile 4. Options

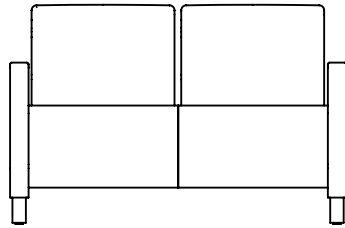

KOU20F - 2 SEAT UPHOLSTERED LOUNGE CHAIR WITH UPHOLSTERED ARMS

DIMENSIONS

Width	49.75	Seat Width	44	Back Height	15.75
Depth	30	Seat Depth	19	Arm Height	25
Height	33.75	Seat Height	18	Weight	120
COM	5.5 YDS				

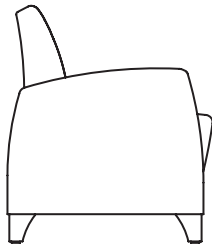

PRICING - KOU20F

COM	4	5	6	7	8	9	10	11
2859	2969	3079	3249	3439	3669	3849	4179	4889

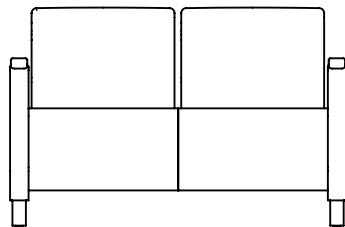

KOU20 - 2 SEAT UPHOLSTERED LOUNGE CHAIR WITH ARM CAPS

DIMENSIONS

Width	49.75	Seat Width	44	Back Height	15.75
Depth	30	Seat Depth	19	Arm Height	26
Height	33.75	Seat Height	18	Weight	120
COM	5.5 YDS				

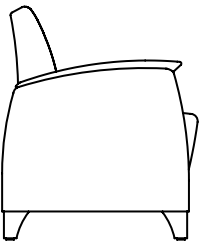

PRICING WITH URETHANE ARM CAPS - KOU20U

COM	4	5	6	7	8	9	10	11
2959	3059	3209	3349	3529	3749	3929	4279	4979

PRICING WITH WOOD ARM CAPS - KOU20W

COM	4	5	6	7	8	9	10	11
3049	3179	3289	3449	3639	3869	4019	4379	5039

PRICING WITH SOLID SURFACE ARM CAPS - KOU20J

COM	4	5	6	7	8	9	10	11
3629	3719	3849	3979	4169	4379	4549	4889	5399

**For above model with solid surface arm caps, add \$200 List for Group 2 solid surface finish*

TO ORDER, SPECIFY

- 1. Model Number 3. Finish
- 2. Textile 4. Options

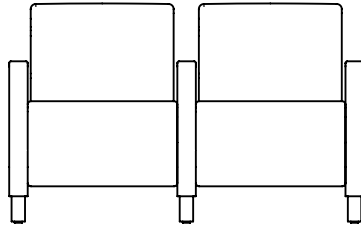

KOU20IF - 2 SEAT UPHOLSTERED LOUNGE CHAIR WITH INTERVENING ARM, UPHOLSTERED ARMS

DIMENSIONS

Width	51.75	Seat Width	21.75	Back Height	15.75
Depth	30	Seat Depth	19	Arm Height	25
Height	33.75	Seat Height	18	Weight	140
COM	6.5 YDS				

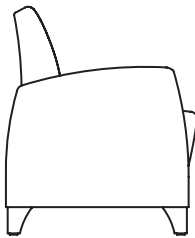

PRICING - KOU20IF

<i>COM</i>	4	5	6	7	8	9	10	11	
	3489	3619	3749	3939	4169	4419	4619	5029	5799

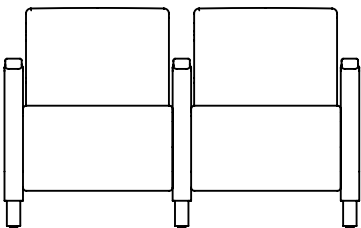

KOU20I - 2 SEAT UPHOLSTERED LOUNGE CHAIR WITH INTERVENING ARM, ARM CAPS

DIMENSIONS

Width	51.75	Seat Width	21.75	Back Height	15.75
Depth	30	Seat Depth	19	Arm Height	26
Height	33.75	Seat Height	18	Weight	140
COM	6.5 YDS				

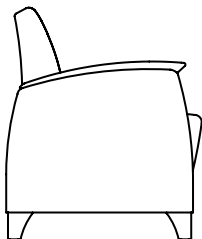

PRICING WITH URETHANE ARM CAPS - KOU20IU

<i>COM</i>	4	5	6	7	8	9	10	11	
	3659	3759	3909	4099	4319	4579	4769	5159	5959

PRICING WITH WOOD ARM CAPS - KOU20IW

<i>COM</i>	4	5	6	7	8	9	10	11	
	3809	3919	4079	4229	4459	4729	4899	5309	6109

PRICING WITH SOLID SURFACE ARM CAPS - KOU20IJ

<i>COM</i>	4	5	6	7	8	9	10	11	
	4639	4739	4879	5059	5259	5509	5669	6069	6759

**For above model with solid surface arm caps, add \$300 List for Group 2 solid surface finish*

TO ORDER, SPECIFY

- 1. Model Number
- 2. Textile
- 3. Finish
- 4. Options

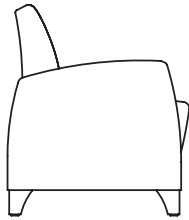
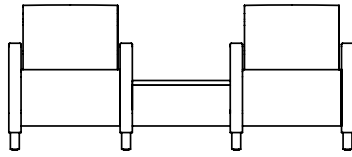

KOU20ITF - 2 SEAT LOUNGE CHAIR WITH INTERVENING TABLE, INTERVENING ARMS, UPHOLSTERED ARMS

DIMENSIONS

Width	76.25	Seat Width	21.75	Back Height	15.75
Depth	30	Seat Depth	19	Arm Height	25
Height	33.75	Seat Height	18	Weight	180
COM	7 YDS				

PRICING - KOU20ITF

COM	4	5	6	7	8	9	10	11
4469	4609	4819	5029	5309	5619	5859	6359	7019

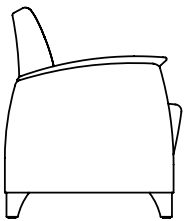
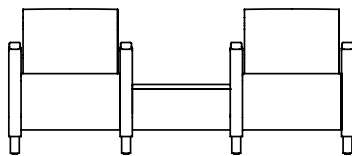

KOU20IT - 2 SEAT LOUNGE CHAIR WITH INTERVENING TABLE, INTERVENING ARMS, ARM CAPS

DIMENSIONS

Width	76.25	Seat Width	21.75	Back Height	15.75
Depth	30	Seat Depth	19	Arm Height	26
Height	33.75	Seat Height	18	Weight	180
COM	7 YDS				

PRICING WITH URETHANE ARM CAPS - KOU20ITU

COM	4	5	6	7	8	9	10	11
4889	5029	5219	5429	5709	5749	5859	6249	7209

PRICING WITH WOOD ARM CAPS - KOU20ITW

COM	4	5	6	7	8	9	10	11
5089	5249	5429	5609	5899	6209	6439	6929	7349

PRICING WITH SOLID SURFACE ARM CAPS - KOU20ITJ

COM	4	5	6	7	8	9	10	11
6009	6139	6309	6489	6759	7059	7269	7769	8389

*CONTACT CUSTOMER SERVICE FOR SOLID SURFACE TABLE PRICING

*For above model with solid surface arm caps, add \$400 List for Group 2 solid surface finish caps

TO ORDER, SPECIFY

- 1. Model Number 3. Finish
- 2. Textile 4. Options

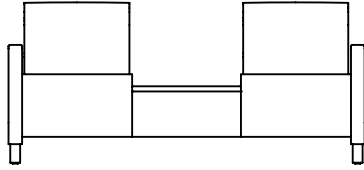

KOU20TF - 2 SEAT LOUNGE CHAIR WITH INTERVENING TABLE, NO INTERVENING ARMS, UPHOLSTERED ARMS

DIMENSIONS

Width	71.75	Seat Width	21.75	Back Height	15.75
Depth	30	Seat Depth	19	Arm Height	25
Height	33.75	Seat Height	18	Weight	155
COM	5.4 YDS				

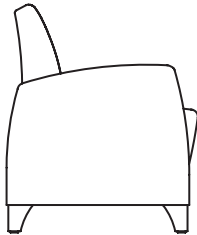

PRICING - KOU20TF

COM	4	5	6	7	8	9	10	11	
	3939	4069	4239	4419	4659	4929	5149	5589	6109

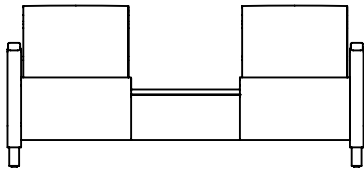

KOU20T - 2 SEAT LOUNGE WITH INTERVENING TABLE, NO INTERVENING ARMS, ARM CAPS

DIMENSIONS

Width	71.75	Seat Width	21.75	Back Height	15.75
Depth	30	Seat Depth	19	Arm Height	26
Height	33.75	Seat Height	18	Weight	155
COM	5.4 YDS				

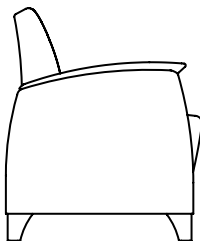

PRICING WITH URETHANE ARM CAPS - KOU20TU

COM	4	5	6	7	8	9	10	11	
	4219	4349	4519	4689	4929	5219	5419	5859	6239

PRICING WITH WOOD ARM CAPS - KOU20TW

COM	4	5	6	7	8	9	10	11	
	4399	4539	4689	4869	5109	5379	5579	6029	6269

PRICING WITH SOLID SURFACE ARM CAPS - KOU20TJ

COM	4	5	6	7	8	9	10	11	
	4689	4829	4999	5149	5389	5669	5859	6229	6789

*CONTACT CUSTOMER SERVICE FOR SOLID SURFACE TABLE PRICING

**For above model with solid surface arm caps, add \$200 List for Group 2 solid surface finish caps*

TO ORDER, SPECIFY

- 1. Model Number
- 2. Textile
- 3. Finish
- 4. Options

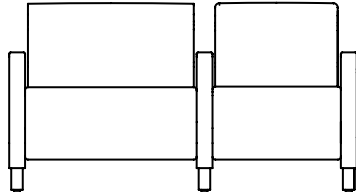

KOU20IBLF - 2 SEAT 29.5" LEFT BARIATRIC (FACING) UPHOLSTERED CHAIR WITH INTERVENING ARM, UPHOLSTERED ARMS

DIMENSIONS

Width	59.125	Seat Width	29.5	Back Height	15.75
Depth	30	Seat Depth	19	Arm Height	25
Height	33.75	Seat Height	18	Weight	150
COM	7 YDS				

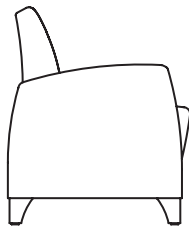

PRICING - KOU20IBLF

COM	4	5	6	7	8	9	10	11
3859	3969	4129	4309	4509	4789	4959	5319	6109

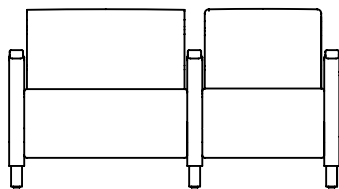

KOU20IBL - 2 SEAT 29.5" LEFT BARIATRIC (FACING) UPHOLSTERED CHAIR WITH INTERVENING ARM, ARM CAPS

DIMENSIONS

Width	59.125	Seat Width	29.5	Back Height	15.75
Depth	30	Seat Depth	19	Arm Height	26
Height	33.75	Seat Height	18	Weight	150
COM	7 YDS				

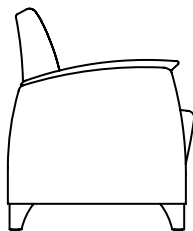

PRICING WITH URETHANE ARM CAPS - KOU20IBLU

COM	4	5	6	7	8	9	10	11
4009	4129	4279	4439	4649	4919	5109	5479	6269

PRICING WITH WOOD ARM CAPS - KOU20IBLW

COM	4	5	6	7	8	9	10	11
4169	4279	4429	4599	4809	5069	5259	5599	6379

PRICING WITH SOLID SURFACE ARM CAPS - KOU20IBLJ

COM	4	5	6	7	8	9	10	11
5019	5109	5259	5389	5599	5849	6019	6379	7059

**For above model with solid surface arm caps, add \$300 List for Group 2 solid surface finish*

TO ORDER, SPECIFY

- 1. Model Number 3. Finish
- 2. Textile 4. Options

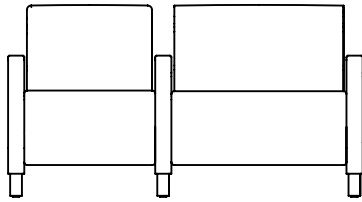

KOU20IBRF - 2 SEAT 29.5" RIGHT BARIATRIC (FACING) UPHOLSTERED CHAIR WITH INTERVENING ARM, UPHOLSTERED ARMS

DIMENSIONS

Width	59.125	Seat Width	29.5	Back Height	15.75
Depth	30	Seat Depth	19	Arm Height	25
Height	33.75	Seat Height	18	Weight	150
COM	7 YDS				

PRICING - KOU20IBRF

<i>COM</i>	4	5	6	7	8	9	10	11
3859	3969	4129	4309	4509	4789	4959	5319	6109

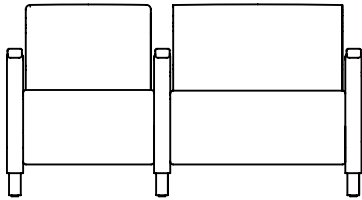
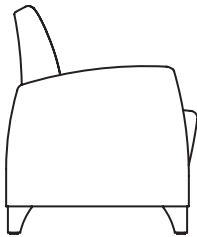

KOU20IBR - 2 SEAT 29.5" RIGHT BARIATRIC (FACING) UPHOLSTERED CHAIR WITH INTERVENING ARM, ARM CAPS

DIMENSIONS

Width	59.125	Seat Width	29.5	Back Height	15.75
Depth	30	Seat Depth	19	Arm Height	26
Height	33.75	Seat Height	18	Weight	150
COM	7 YDS				

PRICING WITH URETHANE ARM CAPS - KOU20IBRU

<i>COM</i>	4	5	6	7	8	9	10	11
4009	4129	4279	4439	4649	4919	5109	5479	6269

PRICING WITH WOOD ARM CAPS - KOU20IBRW

<i>COM</i>	4	5	6	7	8	9	10	11
4169	4279	4429	4599	4809	5069	5259	5599	6379

PRICING WITH SOLID SURFACE ARM CAPS - KOU20IBRJ

<i>COM</i>	4	5	6	7	8	9	10	11
5019	5109	5259	5389	5599	5849	6019	6379	7059

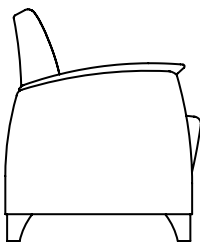

**For above model with solid surface arm caps, add \$300 List for Group 2 solid surface finish*

TO ORDER, SPECIFY

- 1. Model Number
- 2. Textile
- 3. Finish
- 4. Options

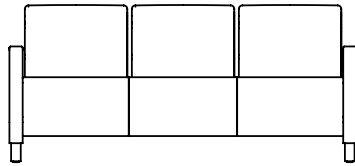

KOU30F - 3 SEAT UPHOLSTERED CHAIR WITH UPHOLSTERED ARMS

DIMENSIONS

Width	71.75	Seat Width	66.5	Back Height	15.75
Depth	30	Seat Depth	19	Arm Height	25
Height	33.75	Seat Height	18	Weight	155
COM	7.5 YDS				

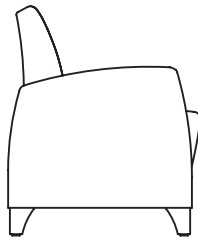

PRICING - KOU30F

COM	4	5	6	7	8	9	10	11	
	3739	3899	4089	4269	4539	4829	5069	5529	6429



KOU30 - 3 SEAT UPHOLSTERED CHAIR WITH ARM CAPS

DIMENSIONS

Width	71.75	Seat Width	66.5	Back Height	15.75
Depth	30	Seat Depth	19	Arm Height	26
Height	33.75	Seat Height	18	Weight	155
COM	7.5 YDS				

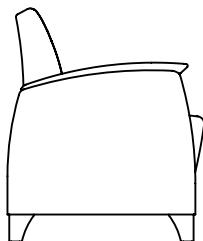

PRICING WITH URETHANE ARM CAPS - KOU30U

COM	4	5	6	7	8	9	10	11	
	3849	3989	4169	4369	4619	4909	5159	5619	6509

PRICING WITH WOOD ARM CAPS - KOU30W

COM	4	5	6	7	8	9	10	11	
	3949	4109	4279	4459	4729	5019	5269	5719	6609

PRICING WITH SOLID SURFACE ARM CAPS - KOU30J

COM	4	5	6	7	8	9	10	11	
	4509	4649	4829	5019	5249	5529	5769	6239	6939

**For above model with solid surface arm caps, add \$200 List for Group 2 solid surface finish*

TO ORDER, SPECIFY

- 1. Model Number 3. Finish
- 2. Textile 4. Options

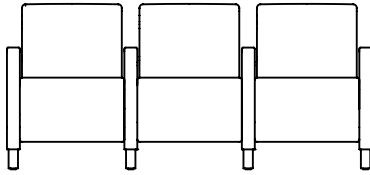

KOU30IF - 3 SEAT UPHOLSTERED LOUNGE CHAIR WITH INTERVENING ARMS, UPHOLSTERED ARMS

DIMENSIONS

Width	76.25	Seat Width	21.75	Back Height	15.75
Depth	30	Seat Depth	19	Arm Height	25
Height	33.75	Seat Height	18	Weight	196
COM	9 YDS				

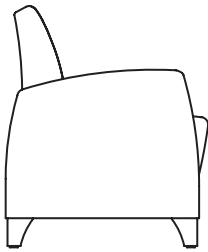

PRICING - KOU30IF

<i>COM</i>	4	5	6	7	8	9	10	11
	4929	5119	5359	5599	5939	6299	7199	7939

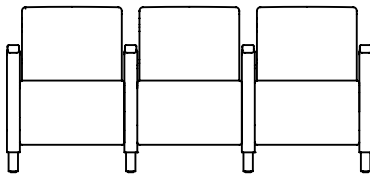

KOU30I - 3 SEAT UPHOLSTERED LOUNGE CHAIR WITH INTERVENING ARMS, ARM CAPS

DIMENSIONS

Width	76.25	Seat Width	21.75	Back Height	15.75
Depth	30	Seat Depth	19	Arm Height	26
Height	33.75	Seat Height	18	Weight	196
COM	9 YDS				

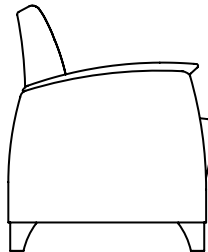

PRICING WITH URETHANE ARM CAPS - KOU30IU

<i>COM</i>	4	5	6	7	8	9	10	11	
	5199	5419	5669	5949	6309	6709	7059	7669	8159

PRICING WITH WOOD ARM CAPS - KOU30IW

<i>COM</i>	4	5	6	7	8	9	10	11	
	5399	5619	5879	6159	6519	6929	7239	7869	8259

PRICING WITH SOLID SURFACE ARM CAPS - KOU30IJ

<i>COM</i>	4	5	6	7	8	9	10	11	
	6479	6639	6859	7099	7399	7749	8029	8599	9149

**For above model with solid surface arm caps, add \$400 List for Group 2 solid surface finish*

TO ORDER, SPECIFY

- 1. Model Number
- 2. Textile
- 3. Finish
- 4. Options

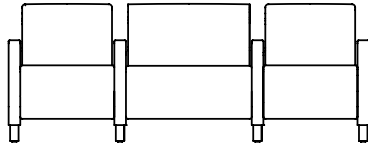

KOU30IBCF - 3 SEAT 29.5" CENTER BARIATRIC UPHOLSTERED CHAIR WITH UPHOLSTERED INTERVENING ARMS

DIMENSIONS

Width	84	Seat Width	29.5	Back Height	15.75
Depth	30	Seat Depth	19	Arm Height	25
Height	33.75	Seat Height	18	Weight	205
COM	9.5 YDS				

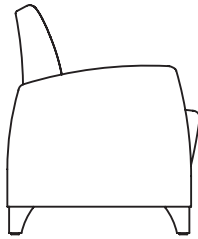

PRICING - KOU30IBCF

COM	4	5	6	7	8	9	10	11
5479	5939	5989	6079	6329	6729	6929	7509	8259

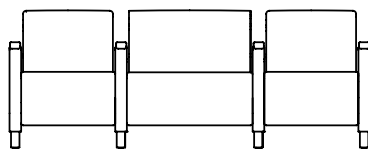

KOU30IBC - 3 SEAT 29.5" CENTER BARIATRIC UPHOLSTERED CHAIR WITH INTERVENING ARMS, ARM CAPS

DIMENSIONS

Width	84	Seat Width	29.5	Back Height	15.75
Depth	30	Seat Depth	19	Arm Height	26
Height	33.75	Seat Height	18	Weight	205
COM	9.5 YDS				

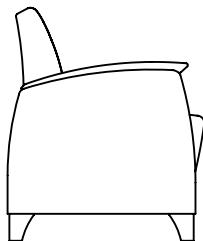

PRICING WITH URETHANE ARM CAPS - KOU30IBCU

COM	4	5	6	7	8	9	10	11
5679	5839	6059	6279	6539	6879	7129	7689	8509

PRICING WITH WOOD ARM CAPS - KOU30IBCW

COM	4	5	6	7	8	9	10	11
5889	6039	6269	6489	6739	7069	7309	7889	8609

PRICING WITH SOLID SURFACE ARM CAPS - KOU30IBCJ

COM	4	5	6	7	8	9	10	11
6999	7159	7359	7569	7809	8119	8339	8919	9459

**For above model with solid surface arm caps, add \$400 List for Group 2 solid surface finish*

TO ORDER, SPECIFY

- 1. Model Number 3. Finish
- 2. Textile 4. Options

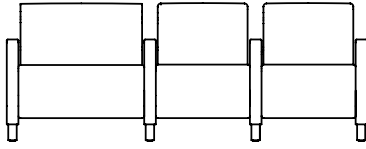

KOU30IBLF - 3 SEAT 29.5" LEFT (FACING) BARIATRIC UPHOLSTERED CHAIR WITH UPHOLSTERED INTERVENING ARMS

DIMENSIONS

Width	84	Seat Width	29.5	Back Height	15.75
Depth	30	Seat Depth	19	Arm Height	25
Height	33.75	Seat Height	18	Weight	205
COM	9.5 YDS				

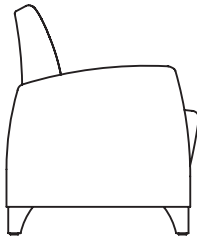

PRICING - KOU30IBLF

<i>COM</i>	4	5	6	7	8	9	10	11	
	5479	5619	5859	6079	6329	6679	6929	7509	8259

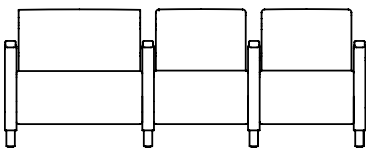

KOU30IBL - 3 SEAT 29.5" LEFT (FACING) BARIATRIC UPHOLSTERED CHAIR WITH INTERVENING ARMS, ARM CAPS

DIMENSIONS

Width	84	Seat Width	29.5	Back Height	15.75
Depth	30	Seat Depth	19	Arm Height	26
Height	33.75	Seat Height	18	Weight	205
COM	9.5 YDS				

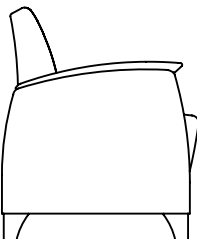

PRICING WITH URETHANE ARM CAPS - KOU30IBLU

<i>COM</i>	4	5	6	7	8	9	10	11	
	5679	5839	6059	6279	6539	6879	7129	7689	8509

PRICING WITH WOOD ARM CAPS - KOU30IBLW

<i>COM</i>	4	5	6	7	8	9	10	11	
	5889	6039	6269	6489	6739	7069	7309	7889	8609

PRICING WITH SOLID SURFACE ARM CAPS - KOU30IBLJ

<i>COM</i>	4	5	6	7	8	9	10	11	
	6999	7159	7359	7569	7809	8119	8339	8919	9459

**For above model with solid surface arm caps, add \$400 List for Group 2 solid surface finish*

TO ORDER, SPECIFY

- 1. Model Number
- 2. Textile
- 3. Finish
- 4. Options

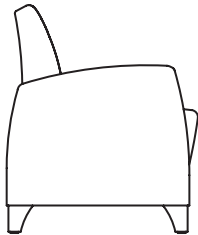
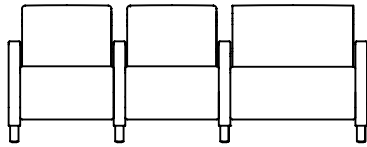

KOU30IBRF - 3 SEAT 29.5" RIGHT (FACING) BARIATRIC UPHOLSTERED CHAIR WITH UPHOLSTERED INTERVENING ARMS

DIMENSIONS

Width	84	Seat Width	29.5	Back Height	15.75
Depth	30	Seat Depth	19	Arm Height	25
Height	33.75	Seat Height	18	Weight	205
COM	9.5 YDS				

PRICING - KOU30IBRF

COM	4	5	6	7	8	9	10	11	
	5479	5619	5859	6079	6329	6679	6929	7509	8259

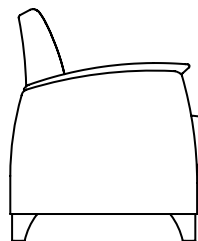
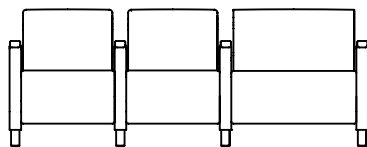

KOU30IBR - 3 SEAT 29.5" RIGHT (FACING) BARIATRIC UPHOLSTERED CHAIR WITH INTERVENING ARMS, ARM CAPS

DIMENSIONS

Width	84	Seat Width	29.5	Back Height	15.75
Depth	30	Seat Depth	19	Arm Height	26
Height	33.75	Seat Height	18	Weight	205
COM	9.5 YDS				

PRICING WITH URETHANE ARM CAPS - KOU30IBRU

COM	4	5	6	7	8	9	10	11	
	5679	5839	6059	6279	6539	6879	7129	7689	8509

PRICING WITH WOOD ARM CAPS - KOU30IBRW

COM	4	5	6	7	8	9	10	11	
	5889	6039	6269	6489	6739	7069	7309	7889	8609

PRICING WITH SOLID SURFACE ARM CAPS - KOU30IBRJ

COM	4	5	6	7	8	9	10	11	
	6999	7159	7359	7569	7809	8119	8339	8919	9459

**For above model with solid surface arm caps, add \$400 List for Group 2 solid surface finish*

Product Specifications

- Pewter Metal Feet or Wood Feet
- Thermofoil Wood Grain Vinyl Top Surface

Options

PU1	Power (Add \$179 List Upcharge)* *Installed on Front Center of Table
MF4-LEG4	4 Metal Legs (Add \$99 List Upcharge)

Wood, Thermofoil, and Powder Coat Finishes

Please refer to page 14.

Solid Surface Finishes

Please refer to page 14.

Moisture Barrier Options

Please refer to page 14.

KOU15T - 15" INLINE TABLE - THERMOFOIL

DIMENSIONS

Width: 16 Depth: 20.25 Height: 19 Weight: 34 COM: 1.5 YDS

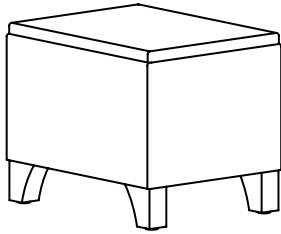

<i>COM</i>	4	5	6	7	8	9	10	11	
	1139	1149	1159	1169	1179	1199	1219	1239	1389

KOU15T - 15" INLINE TABLE - SOLID SURFACE

DIMENSIONS

Width: 16 Depth: 20.25 Height: 19 Weight: 43

*CONTACT CUSTOMER SERVICE FOR SOLID SURFACE TABLE PRICING

KOU90T - 90 DEGREE CORNER TABLE - THERMOFOIL

DIMENSIONS

Width: 45 Depth: 23.75 Height: 18.25 Weight: 60 COM: 1.5 YDS

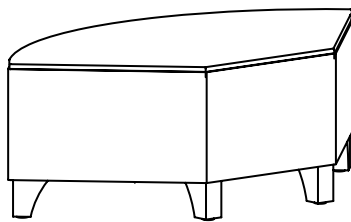

<i>COM</i>	4	5	6	7	8	9	10	11	
	1519	1539	1549	1559	1599	1619	1629	1679	1839

KOU90J - 90 DEGREE CORNER TABLE - SOLID SURFACE

DIMENSIONS

Width: 45 Depth: 23.75 Height: 18.25 Weight: 78

*CONTACT CUSTOMER SERVICE FOR SOLID SURFACE TABLE PRICING

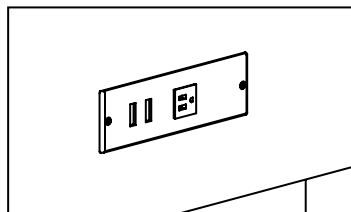

Table Options

PU1 Power (Add \$209 List Upcharge)
(Located on Front of Table)

Power Details

(2) USB Ports
(1) AC Outlet
Electrical Rating: 125V, 60Hz, 12A
Length of Power Cord: 10'

OCCASIONAL TABLE COLLECTIONS

▪ K-Series by Knú Comfort®	128
----------------------------------	-----

Product Specifications

- Thermofoil Wood Grain Vinyl Laminated Top Surface
- Standard Pewter Metal Frame Finish
- Standard with Adjustable Glides

Coordinating Chair Collections

Kadia Cascade
Koncert

TO ORDER, SPECIFY

- | | |
|-----------------|------------|
| 1. Model Number | 3. Finish |
| 2. Textile | 4. Options |

Thermofoil Table Top Finishes*

Please refer to page 14.

**apron only available in wood finishes*

Solid Surface Finishes

Please refer to page 14.

Powder Coat Frame Finishes

- | | |
|-----|--------------|
| 042 | Black |
| 211 | Silver Frost |
| 540 | Pewter |

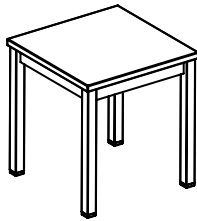

KOT2020 - 20 X 20 SQUARE END TABLE - THERMOFOIL

DIMENSIONS

Width 20 Depth 20 Height 21.25 Weight 29 List Price 919

KOT2020 - 20 X 20 SQUARE END TABLE - SOLID SURFACE

DIMENSIONS

Width 20 Depth 20 Height 21.25 Weight 40

*CONTACT CUSTOMER SERVICE FOR SOLID SURFACE TABLE PRICING

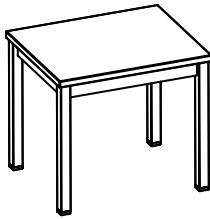

KOT2420 - 24 X 20 RECTANGULAR END TABLE - THERMOFOIL

DIMENSIONS

Width 24 Depth 20 Height 21.25 Weight 32 List Price 929

KOT2420 - 24 X 20 RECTANGULAR END TABLE - SOLID SURFACE

DIMENSIONS

Width 24 Depth 20 Height 21.25 Weight 46

*CONTACT CUSTOMER SERVICE FOR SOLID SURFACE TABLE PRICING

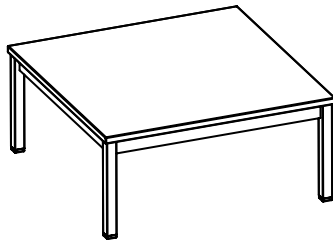

KOT3636 - 36 X 36 SQUARE MAGAZINE TABLE - THERMOFOIL

DIMENSIONS

Width 36 Depth 36 Height 16.25 Weight 66 List Price 1349

KOT3636 - 36 X 36 SQUARE MAGAZINE TABLE - SOLID SURFACE

DIMENSIONS

Width 36 Depth 36 Height 16.25 Weight 102

*CONTACT CUSTOMER SERVICE FOR SOLID SURFACE TABLE PRICING

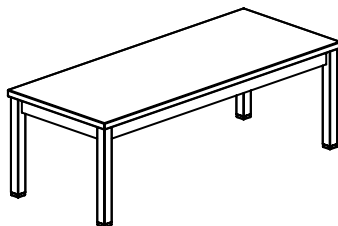

KOT4820 - 48 X 20 RECTANGULAR MAGAZINE TABLE - THERMOFOIL

DIMENSIONS

Width 48 Depth 20 Height 16.25 Weight 52 List Price 1149

KOT4820 - 48 X 20 RECTANGULAR MAGAZINE TABLE - SOLID SURFACE

DIMENSIONS

Width 48 Depth 20 Height 16.25 Weight 79

*CONTACT CUSTOMER SERVICE FOR SOLID SURFACE TABLE PRICING



Product Specifications

- Thermofoil Wood Grain Vinyl Laminated Top Surface
- Standard Pewter Metal Frame Finish
- Standard with Adjustable Glides

Thermofoil Table Top Finishes*

Please refer to page 14.

**apron only available in wood finishes*

Coordinating Chair Collections

Kadia Cascade
Koncert

Solid Surface Finishes

Please refer to page 14.

Powder Coat Frame Finishes

042 Black
211 Silver Frost
540 Pewter

TO ORDER, SPECIFY

- | | |
|-----------------|------------|
| 1. Model Number | 3. Finish |
| 2. Textile | 4. Options |

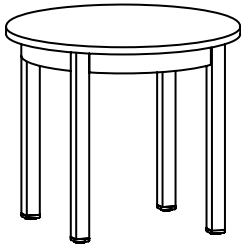

KOT24R - 24" ROUND OCCASIONAL TABLE - THERMOFOIL

DIMENSIONS

Width 24 Depth 24 Height 21 Weight 43 List Price 959

KOT24R - 24" ROUND OCCASIONAL TABLE - SOLID SURFACE

DIMENSIONS

Width 24 Depth 24 Height 21 Weight 57

*CONTACT CUSTOMER SERVICE FOR SOLID SURFACE TABLE PRICING

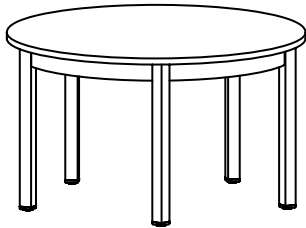

KOT36R - 36" ROUND MAGAZINE TABLE - THERMOFOIL

DIMENSIONS

Width 36 Depth 36 Height 16 Weight 63 List Price 1209

KOT36R - 36" ROUND MAGAZINE TABLE - SOLID SURFACE

DIMENSIONS

Width 36 Depth 36 Height 16 Weight 92

*CONTACT CUSTOMER SERVICE FOR SOLID SURFACE TABLE PRICING

Product Specifications

- Thermofoil Wood Grain Vinyl Laminated Top Surface
- Tables Feature Multi-Step Catalyzed Varnish
- Legs, Apron Rails, and Shelf all Wood

TO ORDER, SPECIFY

- | | |
|-----------------|------------|
| 1. Model Number | 3. Finish |
| 2. Textile | 4. Options |

Thermofoil Table Top Finishes*

Please refer to page 14.

**apron only available in wood finishes*

Solid Surface Finishes

Please refer to page 14.

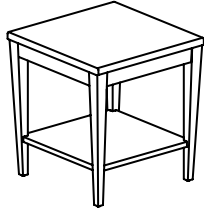

KT6E2020B1 - 20 X 20 SQUARE END TABLE - THERMOFOIL

DIMENSIONS

Width 20 Depth 20 Height 21 Weight 35 List Price 1179

KT6E2020B1 - 20 X 20 SQUARE END TABLE - SOLID SURFACE

DIMENSIONS

Width 20 Depth 20 Height 21 Weight 46

*CONTACT CUSTOMER SERVICE FOR SOLID SURFACE TABLE PRICING

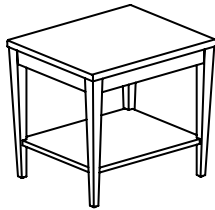

KT6E2420B3 - 24 X 20 RECTANGULAR END TABLE - THERMOFOIL

DIMENSIONS

Width 24 Depth 20 Height 21 Weight 39 List Price 1209

KT6E2420B3 - 24 X 20 RECTANGULAR END TABLE - SOLID SURFACE

DIMENSIONS

Width 24 Depth 20 Height 21 Weight 53

*CONTACT CUSTOMER SERVICE FOR SOLID SURFACE TABLE PRICING

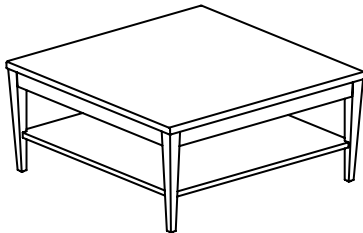

KT6M3636B4 - 36 X 36 SQUARE MAGAZINE TABLE - THERMOFOIL

DIMENSIONS

Width 36 Depth 36 Height 16 Weight 70 List Price 1599

KT6M3636B4 - 36 X 36 SQUARE MAGAZINE TABLE - SOLID SURFACE

DIMENSIONS

Width 36 Depth 36 Height 16 Weight 106

*CONTACT CUSTOMER SERVICE FOR SOLID SURFACE TABLE PRICING

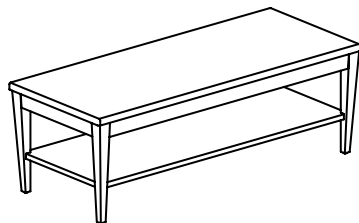

KT6M4820B2 - 48 X 20 RECTANGULAR MAGAZINE TABLE - THERMOFOIL

DIMENSIONS

Width 48 Depth 20 Height 16 Weight 54 List Price 1469

KT6M4820B2 - 48 X 20 RECTANGULAR MAGAZINE TABLE - SOLID SURFACE

DIMENSIONS

Width 48 Depth 20 Height 16 Weight 81

*CONTACT CUSTOMER SERVICE FOR SOLID SURFACE TABLE PRICING

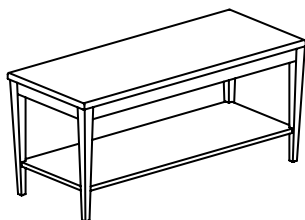

KT6C4820B2 - 48 X 20 RECTANGULAR CONSOLE TABLE - THERMOFOIL

DIMENSIONS

Width 48 Depth 20 Height 29 Weight 53 List Price 1589

KT6C4820B2 - 48 X 20 RECTANGULAR CONSOLE TABLE - SOLID SURFACE

DIMENSIONS

Width 48 Depth 20 Height 29 Weight 80

*CONTACT CUSTOMER SERVICE FOR SOLID SURFACE TABLE PRICING



RECLINER COLLECTIONS

▪ Recliner Ordering Guide Arm + Back Styles.....	132
▪ Recliner Options.....	134
▪ 350 Recliner Series by Knú® Healthcare.....	136
▪ 450 Recliner Series by Knú® Healthcare.....	145
▪ Durable® 550 Recliner Series by La-Z-Boy® Healthcare Knú Comfort®...	149
▪ Durable® 650 Recliner Series by La-Z-Boy® Healthcare Knú Comfort®...	158
▪ Durable® 750 Recliner Series by La-Z-Boy® Healthcare Knú Comfort®...	205
▪ Exam Lift Recliner Series by La-Z-Boy® Healthcare Knú Comfort®	218
▪ Lift Recliner Series by Knú® Healthcare.....	218

How to Order

The chart below is a guide to use when building the recliner model number for your purchase order. Please select the body style preferred, the model number, and then the options you would like your recliner to have. If options are not desired, please leave space blank. List your textile, finish, and options below the model number. Price is determined by fabric grade choice. Options are in addition to the recliner price.

Example Below

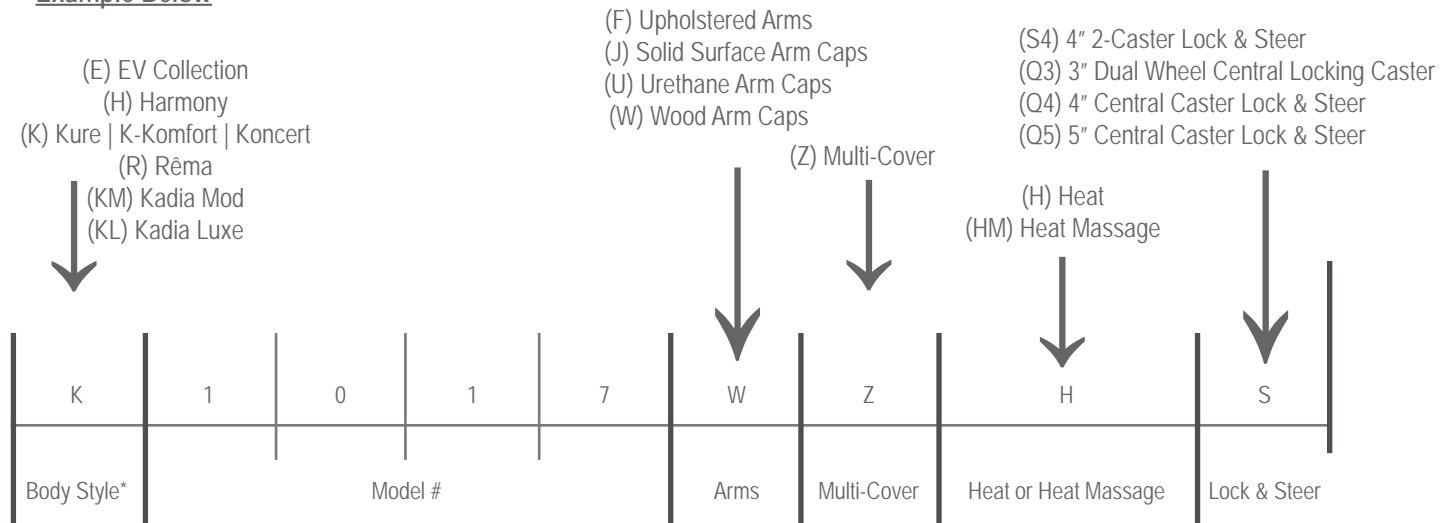

***Options are not available on all models. Please refer to individual product pages for availability.*

Arm + Back Styles



KURE COLLECTION



K-KOMFORT COLLECTION

*shown with back seam



K-KOMFORT COLLECTION

*shown without back seam



RÊMA COLLECTION



KONCERT COLLECTION



HARMONY COLLECTION



EV COLLECTION



KADIA MOD COLLECTION

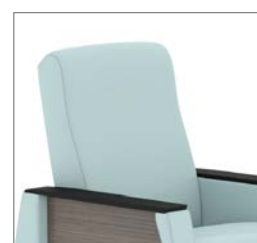

KADIA LUXE COLLECTION

Celebrating 50+ Years of Comfort

La-Z-Boy Healthcare | Knú Comfort, formerly, La-Z-Boy Contract Furniture Group, was founded in 1971 as a Contract Furniture Division, which would target the contract office furniture market, and would grow and expand over the years into hospitality and the healthcare markets. It is widely understood that La-Z-Boy invented and developed the first reclining chair, or recliner, over 80 years ago.

La-Z-Boy Healthcare | Knú Comfort has worked over the years perfecting that recliner mechanism, and currently we feel we have the best on the market. The most durable, dependable, and easy to use recliner. We are proud to have grown over the past 50 years, to narrow our focus and work on our true strengths.



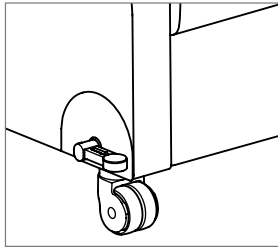

Q3 | 3" Dual Wheel Central Lock Caster (Non-Directional)**
 The Q3 Caster Lock Feature is controlled by a 2-position lever located at the front of the chair on the left arm facing. Lever locks three casters. This feature is non-directional and does not aid in steering. Casters are 3" dual wheel.

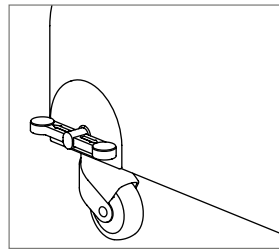

S4 | 4" Single Wheel Lock & Steer Caster
 The 2-Caster Lock and Steer (S4) feature is controlled by a three position lever located at the rear of the chair on the left arm facing. Lever controls rear casters only.

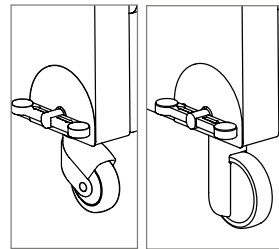

Q4 | 4" & Q5 | 5" Single Wheel Central Lock & Steer Caster**
 The Central Lock and Steer (Q4 & Q5) feature is controlled by a three position lever located at the front of the chair on the left arm facing.

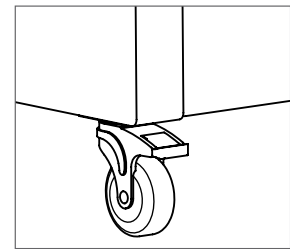

Swivel Locking Casters (SS4)
 Recliners are standard with (3) 4" swivel locking casters and (1) 4" rigid locking caster located in the front of the recliner. Optional swivel locking caster can be exchanged for rigid locking caster.

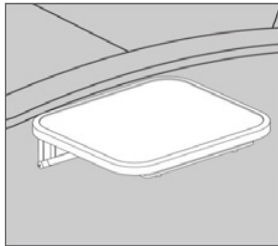

Folding Side Tray (FST)
 Folding Side Tray is mounted on the right side (facing). The small FST measures 12" L x 10-5/8" W and the large FST measures 17" L x 10-5/8" W. When tray is in fold down position, it extends 2-1/2" from the chair arm.

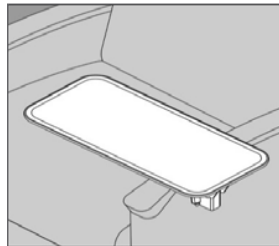

Folding Side Tray (TSL1/TSR1)
 Side Trays can be mounted to the left, right, or both sides of the chair. Side Tray measures 23" L x 10 5/8" W. When tray is in fold down position, it extends 4" from chair arm. Standard: Opposite of the Handle Side

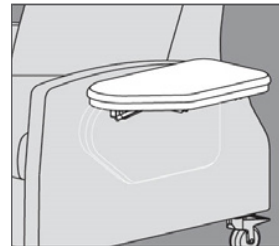

Padded Folding Side Tray (PLFST)
 The PLFST is upholstered allowing patients to comfortably rest their arms during treatment. It measures 17" L x 10-5/8" W. When, in fold down position, tray extends 2-1/2" from side of arm. PLFST requires 1 yard of fabric.

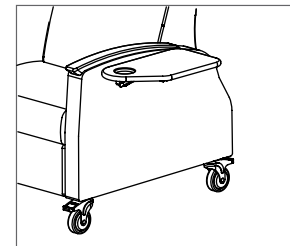

Side Tray with Cup Holder (LFSTRCH)
 Side Trays can be mounted to the left, right, or both sides of the chair. Side Tray measures 23" L x 10 5/8" W. When tray is in fold down position, it extends 4" from chair arm. Standard: Opposite of the Handle Side

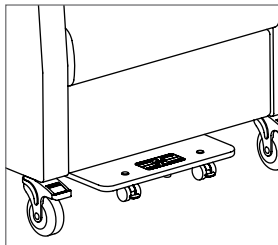

Foot Tray (FT)
 Pull out foot tray easily slides out to support patient's feet for added comfort. (Not intended as a step.)

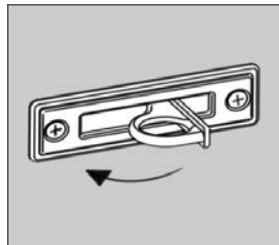

Foley Bag Holder (FBH)
 Accommodates Foley bags and other drainage bags and closes flush with chair when not in use. Located on opposite arm from the handle toward the front of the chair.



Wrist Restraint (WR)
 Located on both sides of the outside arms of medical recliners. Accommodates wrist restraints.

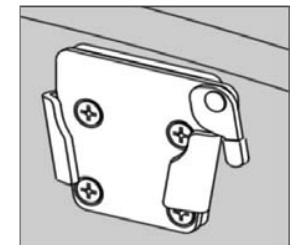

Additional Quick Release Accessory Bracket (QR)
 The Quick Release Bracket is mounted into metal insert nuts and used with the IV Pole and Side Tray. (Can be placed on either side)

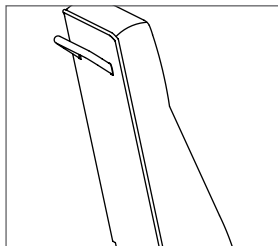

Edge Guard
 Mobile medical recliners feature a standard plastic edge guard around the back of the recliner to protect the chair from minor abrasions.

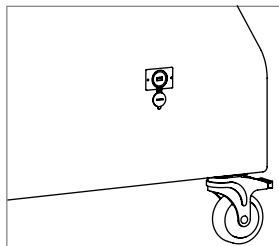

Hospital Grade Power (USB)
 IEC-60601 certified. The USB port offers a rubber plug that can be inserted into the USB connection to provide protection during cleaning. Standard right side facing. *Offered on medical recliners only

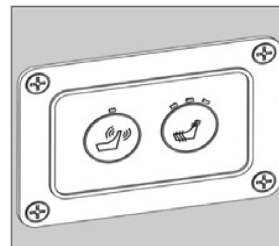

Heat/Heat & Massage Recliners
 Heat (H) and Heat & Massage (HM) Control is located on the inside left arm (facing). Heat temperature is 97 Degrees Low to 105 Degrees High.

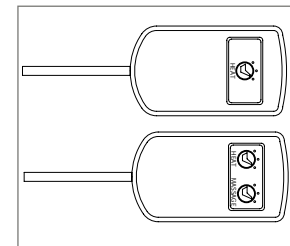

Heat/Heat & Massage Wand
 Heat (HW) and Heat & Massage (HMW) Wand is located on the seat. Heat temperature is 97 Degrees Low to 105 Degrees High.

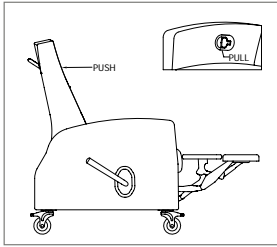

Infinite Position Locking Back Lever
 Infinite Position Locking Back lever allows patient/caregivers to lock back in any recline position. Locking Back Lever is located on the inside of the left arm (facing) on select models. Locking Back Lever is located on the outside of the left arm (facing) on Dual Lateral Transfer Arm models.

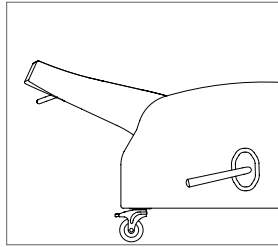

Infinite Position Non-Locking Back
 Patients can adjust seating and back positions to their exact preferences through simple body movement.

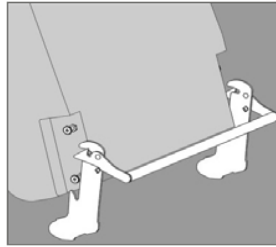

Quick Removable Back
 Medical recliners are standard with removable back for easy cleanability for infectious disease control on select models.

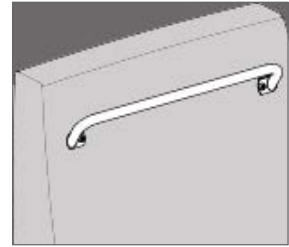

Push Bar
 Mobile medical recliners feature push bar for ease of movement.

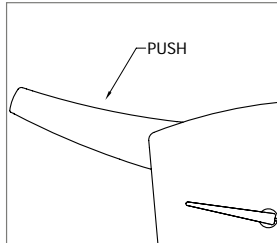

Room Saver Back
 Room Saver recliners sits within 6" of the wall & still fully reclines to 155 degrees. Patients/Visitors can adjust seating and back positions to their exact preferences through simple body movement.

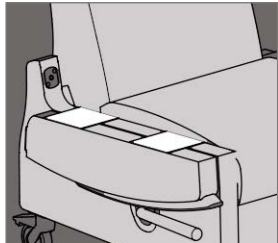

Patient Transfer Arm | Fold Down Arm
 The Patient Transfer (fold down) Arm is located on the Right Side (facing), Left Side (facing), or both sides. Refer to individual product pages for list of available options. When arm is in down position, add 4" to the overall width of the chair. Hinge cover is not available on rocker recliners. **Not available on the Harmony Recliners

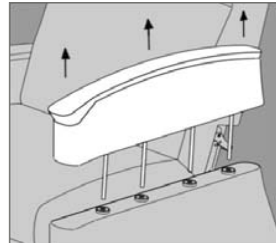

Patient Transfer Arm Removable Arm
 Removable Right Arm (facing) allows for lateral transfer of patient. Refer to individual product pages for list of available options.

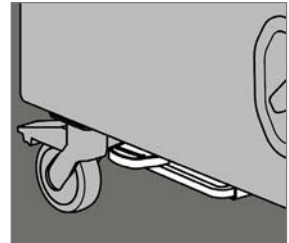

Trendelenburg Option (TE)
 Trendelenburg allows an additional 10° pitch. The Trendelenburg lever is conveniently located on both sides of the recliner.

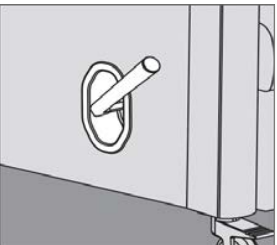

450, 550, 650, & 750 Series Recliner Handle
 Recliners are standard with left side (facing) black handle. Recliner handle assists weakened occupants with footrest elevation. No need to push on back to open recliner footrest.

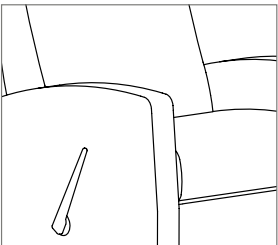

350 Series Recliner Handle
 Recliners are standard with left side (facing) black handle. Recliner handle assists weakened occupants with footrest elevation. No need to push on back to open recliner footrest.

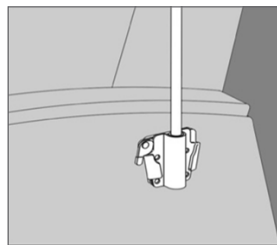

IV Pole and Bracket (IV/DP)
 IV pole and bracket are positioned on the recliner arm (right side facing) toward the back of the chair. Dual IV Poles (DP) also available.



LiquiCell® is an option on all Durable® 650 & 750 Series recliner offerings.

LiquiCell® is a medical technology that protects skin tissues from being stretched and torn, thereby optimizing blood flow. This ultra-thin cell contains a liquid that is in constant motion allowing the body to glide or float with an object. This means greater long-term comfort due to lessened body aches, pain and fatigue.

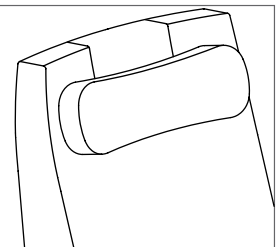

Adjustable Headrest Pillow (AHP)
 Adjustable Headrest Pillow, made out of memory foam, gives additional comfort to a patient or visitor. Adjustable Headrest Pillow requires 1 yard of fabric.

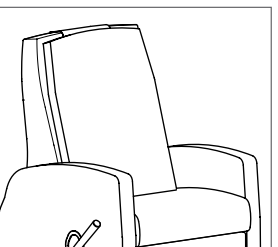

Adjustable Back Pad E Style (ABP-E)
 Adjustable Back Pad, made out of memory foam, gives additional comfort to a patient or visitor. The E Style of the Adjustable Back Pad will be selected for all EV recliner models (not including wingback options). Adjustable Back Pad price is based on fabric grade number.

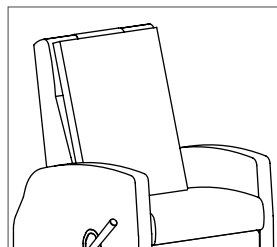

Adjustable Back Pad R Style (ABP-R)
 Adjustable Back Pad, made out of memory foam, gives additional comfort to a patient or visitor. The R Style of the Adjustable Back Pad will be selected for all Rema, Kadia Mod, Kadia Luxe, Harmony, and EV Wingback recliner models. Adjustable Back Pad price is based on fabric grade number.

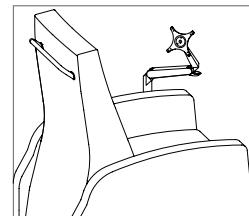

Monitor Arm (MR/L)

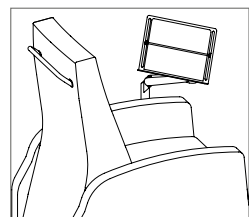

Monitor Arm with Removable Tray (MTR/L)

350 Series

Boasting several different designs and functionalities, the 350 Series is one of our broadest categories. Designed specifically for controlled environments, such as senior living, wellness rooms, or office lounges, the 350 Series offers Gliders, Three Position Recliners, and Power Recliners, among others. The common

thread among all 350 Series models is the trusted comfort we have come to be known for.



Kure | Three Position Recliner - 350 lb Weight Rating

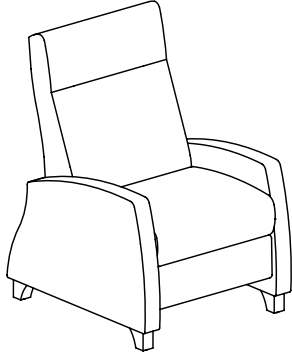

Product Information

- Upholstered Arms
- Seat Foam Density - 2.3 HR (High Resiliency)
- Back Foam Density - 1.75 HR (High Resiliency)
- All Interior Plywood is California Carb Compliant/Phase II
- Removable Back to Clean for Infectious Disease Control
- Mid-Ottoman Calf Support
- 3 Position Recliner
- Foot Rest/Kick-Out Operates by Pushing on Arms of Recliner
- Heavy-Duty Steel Seat Frame
- Standard with Wood Legs

3" Swivel Locking Caster Option

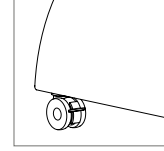

DIMENSIONS | K0017

Width	28	Seat Width	22.5	Back Height	23.5
Depth	37.5	Seat Depth	20.5	Arm Height	25.5
Height	44	Seat Height	19	Weight	97
COM	4 YDS	Seat Depth (kick-out)	41	Distance from Wall	17
Weight Capacity	350 lbs.				

K0017 RECLINER - INFINITE POSITION NON-LOCKING BACK - UPHOLSTERED ARMS STANDARD

COM	4	5	6	7	8	9	10	11
3009	3049	3099	3219	3319	3439	3619	3789	4049

Options	List Price
F Upholstered Arms	Standard
U Urethane Arm Caps	\$169
W Wood Arm Caps*	\$229
J Solid Surface Arm Caps - Group 1	\$619 (Group 2 add \$200)
Z Multi-Cover	Use Highest Grade
EG Edge Guard	Standard
CAL CAL TB133	See page 12
CASTER 3" Swivel Locking Caster	\$199
MBB Moisture Barrier Back	\$59
MBS Moisture Barrier Seat	\$59
LFSTR Lg Right Side (facing) Folding Side Tray	\$249
*Contact Customer Service for Solid Surface Pricing	
LFSTRCH Lg Right Side (facing) Folding Cup Holder Tray	\$319
PLFSTR Padded Lg Right Side (facing) Folding Side Tray	\$379 (Requires 1 yd of fabric)
SFSTR Sm Right Side (facing) Folding Side Tray	\$249
*Contact Customer Service for Solid Surface Pricing	

*Please refer to page 14 for finishes.

Please refer to pages 134/135 for Option descriptions & images.

Please refer to page 132 for the recliner ordering guide.

K-Komfort | Healthcare Room Saver Recliners - 23" Seat - 350 lb Weight Rating

350 SERIES

HEALTHCARE ROOM SAVER RECLINER

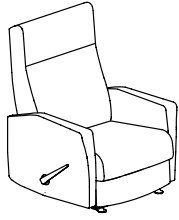

K8004 | KC8004
32" Overall Width

DIMENSIONS | K8004 | K8014 | KC8004 | KC8014

Width	32	Seat Width	23	Back Height	27.5
Depth	35	Seat Depth	21	Arm Height	23.5
Height	40.5	Seat Height	18	Weight	86
COM	5 YDS	COM (Chaise)	6 YDS	Seat Depth (kick-out)	37
Reclined Depth	64	Weight Capacity	350 lbs.	Distance from Wall	6

K8004 ROOM SAVER RECLINER - UPHOLSTERED ARMS

COM	4	5	6	7	8	9	10	11
2199	2289	2349	2489	2619	2769	2979	3209	3549

K8014 ROOM SAVER RECLINER - UPHOLSTERED ARMS

COM	4	5	6	7	8	9	10	11
2119	2159	2279	2379	2549	2709	2869	3099	3419

KC8004 ROOM SAVER CHAISE RECLINER - UPHOLSTERED ARMS

COM	4	5	6	7	8	9	10	11
2489	2539	2609	2749	2889	3029	3229	3459	3809

KC8014 ROOM SAVER CHAISE RECLINER - UPHOLSTERED ARMS

COM	4	5	6	7	8	9	10	11
2389	2449	2539	2659	2809	2969	3129	3359	3669

Note: Must close by using downward pressure on footrest in conjunction with handle.

Options

Z	Multi Cover
CAL	CAL TB133
MBB	Moisture Barrier Back
MBS	Moisture Barrier Seat
LRSP	Large Room Saver Platform

List Price

Use Highest Grade
See page 12
\$59
\$59
\$139



Width: 27"
Height: 1"
Depth: 27"
Weight: 10 lbs

Please refer to page 132 for the recliner ordering guide.

Standard Product Information

- Upholstered Arms are Standard
- Seat Foam Density - 2.3 HR (High Resiliency)
- Back Foam Density - 1.75 HR (High Resiliency)
- All Interior Plywood is California Carb Compliant/Phase II
- Removable Back to Clean for Infectious Disease Control
- Mid-Ottoman Calf Support
- Lumbar Support



K-Komfort | Healthcare Glider Recliners - 23" Seat - 350 lb Weight Rating

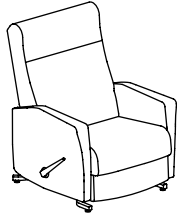

K8006
32" Overall Width

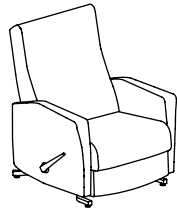

K8016
32" Overall Width

DIMENSIONS | K8006 | K8016

Width	32	Seat Width	23	Back Height	27.5
Depth	36	Seat Depth	21	Arm Height	24.5
Height	40.5	Seat Height	18.5	Weight	92
COM	5 YDS	Seat Depth (kick-out)	37	Reclined Depth	64
Weight Capacity	350 lbs.	Distance from Wall	16.5		

K8006 GLIDER RECLINER - UPHOLSTERED ARMS

COM	4	5	6	7	8	9	10	11
2449	2479	2569	2699	2839	2999	3169	3399	3709

K8016 GLIDER RECLINER - UPHOLSTERED ARMS

COM	4	5	6	7	8	9	10	11
2379	2449	2509	2619	2799	2959	3119	3359	3659

Note: Must close by using downward pressure on footrest in conjunction with handle.

Options

		List Price
Z	Multi Cover	Use Highest Grade
CAL	CAL TB133	See page 12
MBB	Moisture Barrier Back	\$59
MBS	Moisture Barrier Seat	\$59

Please refer to page 132 for the recliner ordering guide.

Standard Product Information

- Upholstered Arms are Standard
- Seat Foam Density - 2.3 HR (High Resiliency)
- Back Foam Density - 1.75 HR (High Resiliency)
- All Interior Plywood is California Carb Compliant/Phase II
- Removable Back to Clean for Infectious Disease Control
- Mid-Ottoman Calf Support
- Lumbar Support



EV, Rêma, Koncert | Room Saver™ Recliners - 22" Seat - 350 lb Weight Rating

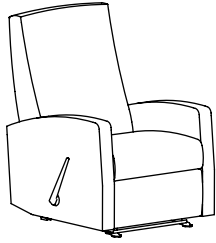

EV | E1304 | EC1304
30.75" Overall Width

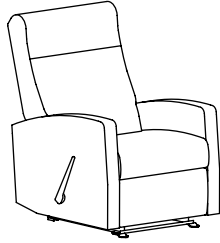

Rêma | R1304 | RC1304
30.75" Overall Width



Koncert | K1304 | KC1304
30.75" Overall Width

DIMENSIONS | E1304 | R1304 | K1304 | Chaise Models

Width	30.75	Seat Width	22.25	Back Height	24
Depth	34.25	Seat Depth	20	Arm Height	23.75
Height	38.5	Seat Height	17.25	Weight	82
COM (Standard)	4 YDS	COM (Chaise)	5 YDS	Seat Depth (kick-out)	37.75
Reclined Depth	66.5	Weight Capacity	350 lbs.	Distance from Wall	6

1304 ROOM SAVER™ RECLINER - UPHOLSTERED ARMS

COM	4	5	6	7	8	9	10	11
2629	2719	2819	2989	3199	3419	3659	3959	4199

C1304 CHAISE ROOM SAVER™ RECLINER - UPHOLSTERED ARMS

COM	4	5	6	7	8	9	10	11
2929	2989	3089	3249	3469	3689	3919	4239	4459

Options	List Price
F Upholstered Arms	Standard
U Urethane Arm Caps*	\$169
W Wood Arm Caps*	\$229
J Solid Surface Arm Caps - Group 1	\$619 (Group 2 add \$200)
Z Multi Cover	Use Highest Grade
CAL CAL TB133	See page 12
MBB Moisture Barrier Back	\$59
MBS Moisture Barrier Seat	\$59
AHP Adjustable Head Rest Pillow*	\$339
*Requires 1 yd of fabric	
LRSP Large Room Saver Platform	\$139

*Please refer to page 14 for finishes.



Width: 27"
Height: 1"
Depth: 27"
Weight: 10 lbs

Please refer to pages 134/135 for Options descriptions & images.
Please refer to page 132 for the recliner ordering guide.

EV, Rêma, Koncert | Mobile Room Saver™ Recliners - 22" Seat - 350 lb Weight Rating



EV | E1307 | EC1307
30.75" Overall Width



Rêma | R1307 | RC1307
30.75" Overall Width

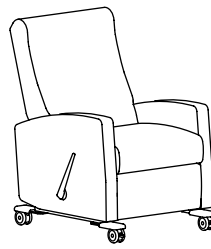

Koncert | K1307 | KC1307
30.75" Overall Width

DIMENSIONS | E1307 | R1307 | K1307 | Chaise Models

Width	30.75	Seat Width	22.25	Back Height	24
Depth	35.25	Seat Depth	20	Arm Height	26.75
Height	43.375	Seat Height	19.75	Weight	98
COM (Standard)	4 YDS	COM (Chaise)	5 YDS	Seat Depth (kick-out)	37.75
Reclined Depth	65.5	Weight Capacity	350 lbs.	Distance from Wall	6

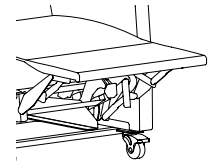

Chaise Model
C1307

1307 ROOM SAVER™ RECLINER - UPHOLSTERED ARMS

COM	4	5	6	7	8	9	10	11
3009	3049	3169	3289	3509	3659	3909	4199	4519

C1307 CHAISE ROOM SAVER™ RECLINER - UPHOLSTERED ARMS

COM	4	5	6	7	8	9	10	11
3289	3319	3439	3579	3779	3919	4179	4459	4789

Options

Options	List Price
F Upholstered Arms	Standard
U Urethane Arm Caps*	\$169
W Wood Arm Caps*	\$229
J Solid Surface Arm Caps - Group 1	\$619 (Group 2 add \$200)
Z Multi Cover	Use Highest Grade
CAL CAL TB133	See page 12
MBB Moisture Barrier Back	\$59
MBS Moisture Barrier Seat	\$59
AHP Adjustable Head Rest Pillow*	\$339

*Requires 1 yd of fabric

*Please refer to page 14 for finishes.

Please refer to pages 134/135 for Option descriptions & images.

Please refer to page 132 for the recliner ordering guide



EV, Rêma, Koncert | Glider Recliners - 22" Seat - 350 lb Weight Rating

350 SERIES



EV | E1306 | EC1306
30.75" Overall Width



Rêma | R1306 | RC1306
30.75" Overall Width



Koncert | K1306 | KC1306
30.75" Overall Width

DIMENSIONS | R1306 | K1306 | Chaise Models

Width	30.75	Seat Width	22.25	Back Height	24.25
Depth	35.25	Seat Depth	20.75	Arm Height	24.25
Height	42	Seat Height	18.5	Weight	93
COM	4 YDS	Seat Depth (kick-out)	36.75	Reclined Depth	64.25
Weight Capacity	350 lbs.	Distance from Wall	16.25		

DIMENSIONS | E1306

Width	30.75	Seat Width	22.25	Back Height	24
Depth	35.25	Seat Depth	20.5	Arm Height	24.25
Height	42	Seat Height	18.5	Weight	94
COM	4 YDS	Seat Depth (kick-out)	36.5	Reclined Depth	64.25
Weight Capacity	350 lbs.	Distance from Wall	17.25		

1306 GLIDER RECLINER - UPHOLSTERED ARMS

COM	4	5	6	7	8	9	10	11
3019	3119	3169	3409	3619	3659	3879	4109	4589

C1306 CHAISE GLIDER RECLINER - UPHOLSTERED ARMS

COM	4	5	6	7	8	9	10	11
3299	3409	3439	3679	3889	3919	4149	4379	4849

Options	List Price
F Upholstered Arms	Standard
U Urethane Arm Caps*	\$169
W Wood Arm Caps*	\$229
J Solid Surface Arm Caps* - Group 1	\$619 (Group 2 add \$200)
Z Multi Cover	Use Highest Grade
CAL CAL TB133	See page 12
MBB Moisture Barrier Back	\$59
MBS Moisture Barrier Seat	\$59

*Please refer to page 14 for finishes.

Please refer to page 132 for the recliner ordering guide.

HEALTHCARE GLIDER RECLINER

EV, Rêma, Konzert | Body Weight Activated Gliders - 22" Seat - 350 lb Weight Rating

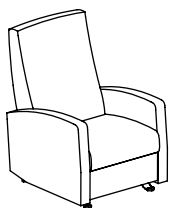

EV | E1716
30.75" Overall Width

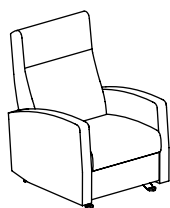

Rêma | R1716
30.75" Overall Width

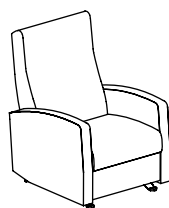

Konzert | K1716
30.75" Overall Width

DIMENSIONS | R1716 | K1716

Width	30.25	Seat Width	22	Back Height	26.5
Depth	34	Seat Depth	21	Arm Height	25
Height	42.5	Seat Height	18.75	Weight	89
COM	6 YDS	Distance from Wall	12	Weight Capacity	350 lbs.

DIMENSIONS | E1716

Width	30.25	Seat Width	22	Back Height	27.5
Depth	34	Seat Depth	21	Arm Height	25
Height	42.5	Seat Height	18.75	Weight	88
COM	6 YDS	Distance from Wall	12	Weight Capacity	350 lbs.

1716 GLIDER - UPHOLSTERED ARMS - BODY WEIGHT ACTIVATED GLIDER

COM	4	5	6	7	8	9	10	11
2659	2739	2799	2909	3049	3219	3429	3629	3909

Options

Options	List Price
F Upholstered Arms	Standard
U Urethane Arm Caps*	\$169
W Wood Arm Caps*	\$229
J Solid Surface Arm Caps* - Group 1	\$619 (Group 2 add \$200)
Z Multi Cover	Use Highest Grade
CAL CAL TB133	See page 12
MBB Moisture Barrier Back	\$59
MBS Moisture Barrier Seat	\$59

*Please refer to page 14 for finishes.

Please refer to page 132 for the recliner ordering guide.



TO ORDER, SPECIFY

- 1. Model Number
- 2. Textile
- 3. Finish
- 4. Options

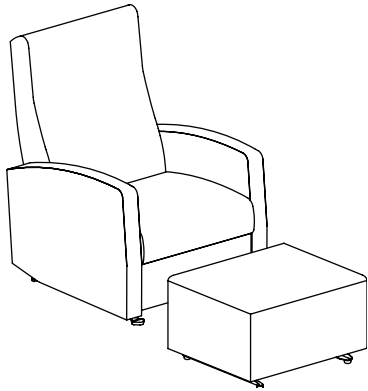

GOT00 - GLIDING OTTOMAN

COM - 2 YDS

COM	4	5	6	7	8	9	10	11
849	859	869	919	959	999	1079	1129	1209

W	D	H	Weight
23.25	19.25	14.75	29

**Can only order ottoman with E1716, R1716, and K1716 glider models.*

450 Series

The 450 Series is our entry-level recliner offering for uncontrolled healthcare environments. Available in our Max and Kure aesthetics, 450 Series utilizes independent leg support and back angle adjustments. Both styles are available with some of our most popular “add on” options to make them a practical choice for a utility recliner when price is a concern, while not sacrificing quality or comfort.



Healthier
Hospitals

Kure | Healthcare Recliner - 22.5" Seat Width - 450 lb Weight Rating

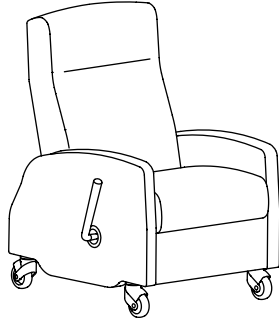

Standard Product Information

- Upholstered Arms
- Seat Foam Density - 2.3 HR (High Resiliency)
- Back Foam Density - 1.75 HR (High Resiliency)
- All Interior Plywood is California Carb Compliant/Phase II
- Removable Back to Clean for Infectious Disease Control
- Mid-Ottoman Calf Support
- (3) 4" Swivel Locking Casters & (1) 4" Rigid Locking Caster
- Back reclines in infinite reclining positions.

DIMENSIONS | K0107

Width	30	Seat Width	22.5	Back Height	24.5
Depth	37	Seat Depth	21	Arm Height	26
Height	44.5	Seat Height	20	Weight	118
COM	4.5 YDS	Seat Depth (kick-out)	37.5	Reclined Depth	71
Weight Capacity	450 lbs.	Distance from Wall	20		

K0107 MOBILE RECLINER - INFINITE POSITION LOCKING BACK - UPH ARMS

COM	4	5	6	7	8	9	10	11	
	3289	3299	3379	3479	3669	3769	3939	4159	5499

Options	List Price	Options	List Price
F Upholstered Arms	Standard	FBH Foley Bag Holder	\$89
U Urethane Arm Caps	\$169	FT Foot Tray	\$279
W Wood Arm Caps*	\$229	IV IV Pole and Bracket	\$249
J Solid Surface Arm Caps* - Group 1	\$619 (Group 2 add \$200)	LFSTR Lg Right Side (facing) Folding Side Tray	\$249
Z Multi-Cover	Use Highest Grade	<i>*Contact Customer Service for Solid Surface Pricing</i>	
S4 2-Caster Lock & Steer	\$569	LFSTRCH Lg Right Side (facing) Folding Cup Holder Tray	\$319
EG Edge Guard	Standard	PLFSTR Padded Lg Right Side (facing) Folding Side Tray	\$379
CAL CAL TB133	See page 12	(Requires 1 yd of fabric)	
MBB Moisture Barrier Back	\$59	QR Additional Quick Release Accessory Bracket	\$69
MBS Moisture Barrier Seat	\$59	SFSTR Sm Right Side (facing) Folding Side Tray	\$249
AHP Adjustable Head Rest Pillow	\$339	<i>*Contact Customer Service for Solid Surface Pricing</i>	
		4S4 All 4" Swivel Locking Caster	\$39
DP Dual IV Poles	\$499	TD3 Dual Side Tray (Dual TSL1/TSR1)**	\$798
MR/L Right/Left Side (facing) Monitor Arm	\$629	TSL1 Left Side (facing) Tray**	\$399
MTR/L Right/Left Side (facing) Monitor Arm with Tray	\$629	TSR1 Right Side (facing) Tray**	\$399
		WR Wrist Restraint (per pair)	\$229

*Please refer to page 14 for finishes.

**Over the lap tray function recommended in seating position.

Please refer to pages 134/135 for Option descriptions & images.

Please refer to page 132 for the recliner ordering guide.

Kure | Mobile Healthcare Recliner - Fold Down Arm - 22.5" Seat - 450 lb Rating

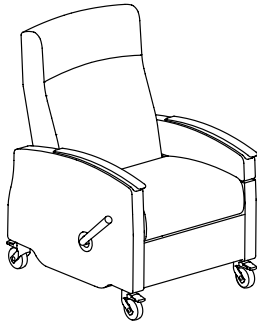

DIMENSIONS | K0167

Width	30	Seat Width	22.5	Back Height	24.5
Depth	37	Seat Depth	21	Arm Height	26
Height	44.5	Seat Height	20	Weight	138
COM	5 YDS	Seat Depth (kick-out)	37.5	Reclined Depth	71
Weight Capacity	450 lbs.	Distance from Wall	20		

K0167 MOBILE RECLINER RIGHT (FACING) FOLD DOWN ARM INFINITE POSITION LOCKING BACK - URETHANE ARM CAPS

COM	4	5	6	7	8	9	10	11
3869	3879	3939	4009	4199	4309	4469	4669	6079

*If patient transfer arm is specified on left side (facing), then handle will be placed on right side (facing) and vice versa.

Options	List Price
U Urethane Arm Caps	Standard
W Wood Arm Caps*	\$229
J Solid Surface Arm Caps* - Group 1	\$619 (Group 2 add \$200)
Z Multi Cover	Use Highest Grade
S4 2-Caster Lock & Steer	\$569
EG Edge Guard	Standard
CAL CAL TB133	See page 12
MBB Moisture Barrier Back	\$59
MBS Moisture Barrier Seat	\$59
AHP Adjustable Head Rest Pillow	\$339
FBH Foley Bag Holder	\$89
FT Foot Tray	\$279
IV IV Pole and Bracket	\$249
4S4 All 4" Swivel Locking Caster	\$39
QR Additional Quick Release Accessory Bracket	\$69
MR/L Right/Left Side (facing) Monitor Arm (non-fold down arm only)	\$629
MTR/L Right/Left Side (facing) Monitor Arm with Tray (non-fold down arm only)	\$629

*Please refer to page 14 for finishes.

AHP option requires 1 yd of fabric.

Please refer to page 132 for the recliner ordering guide.



M0107 | Max Healthcare Recliner - 450 lb Weight Rating

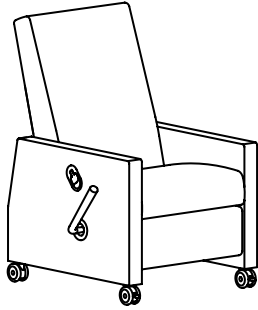

Standard Product Information

- Upholstered Arms are Standard
- Seat Foam Density - 2.3 HR (High Resiliency)
- Back Foam Density - 1.75 HR (High Resiliency)
- All Interior Plywood is California Carb Compliant/Phase II
- Removable Back to Clean for Infectious Disease Control
- Mid-Ottoman Calf Support
- (4) 3" Swivel Locking Casters (Not Intended for Transport)
- Back reclines in infinite reclining positions. Patients can adjust seating and back positions to their exact preference through body movements. Infinite position locking back control lever located left side (facing).

DIMENSIONS | M0107

Width	32.75	Seat Width	22.5	Back Height	24.5
Depth	33.5	Seat Depth	20	Arm Height	25
Height	44	Seat Height	19.5	Weight	98.3
COM	4.1 YDS	Seat Depth (kick-out)	38	Reclined Depth	70
Weight Capacity	450 lbs.	Distance from Wall	18		

M0107 MOBILE RECLINER - INFINITE POSITION LOCKING BACK - UPH ARMS

COM	4	5	6	7	8	9	10	11
2789	2839	2869	3019	3209	3349	3589	3849	5129

Options	List Price	Options	List Price
F Upholstered Arms	Standard	LFSTR Lg Right Side (facing) Folding Side Tray	\$249
U Urethane Arm Caps	\$169	<i>*Contact Customer Service for Solid Surface Pricing</i>	
T Thermofoil Arm Caps*	\$119	LFSTRCH Lg Right Side (facing) Folding Cup Holder Tray	\$319
J Solid Surface Arm Caps* - Group 1	\$619 (Group 2 add \$200)	PLFSTR Padded Lg Right Side (facing) Folding Side Tray	\$379
Z Multi Cover	Use Highest Grade	QR Additional Quick Release Accessory Bracket	\$69
EG Edge Guard	Standard	SFSTR Sm Right Side (facing) Folding Side Tray	\$249
CAL CAL TB133	See page 12	<i>*Contact Customer Service for Solid Surface Pricing</i>	
MBB Moisture Barrier Back	\$59	TD3 Dual Side Tray (Dual TSL1/TSR1)**	\$798
MBS Moisture Barrier Seat	\$59	TSL1 Left Side (facing) Tray**	\$399
FBH Foley Bag Holder	\$89	TSR1 Right Side (facing) Tray**	\$399
MR/L Right/Left Side (facing) Monitor Arm	\$629	WR Wrist Restraint (per pair)	\$229
MTR/L Right/Left Side (facing) Monitor Arm with Tray	\$629		

*Please refer to page 14 for finishes.

**Over the lap tray function recommended in seating position.

PLFSTR option requires 1 yd of fabric.

Please refer to pages 134/135 for Option descriptions & images.

Please refer to page 132 for the recliner ordering guide.

Durable® 550 Series

The Durable® 550 Series is our collection of Rocker Recliners, all featuring our patented Durable® mechanism with fully unitized motion, along with removable back and lift up seat to allow for easy sanitization. Available in both stationary and mobile configurations, as well as patient transfer options, all models in the Durable® 550 Series boast a full flatbed sleep position and a 550 lb weight capacity to make them an exceptional fit for healthcare applications where comfort is key.



EV, Rêma, Koncert | Rocker Recliners - 24" Seat Width - 550 lb Weight Rating

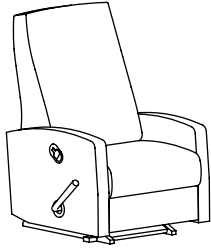

EV | E1125 | EC1125
32.5" Overall Width

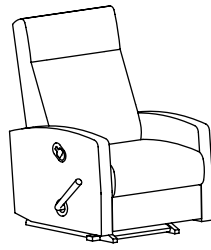

Rêma | R1125 | RC1125
32.5" Overall Width

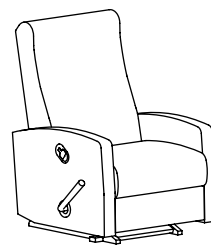

Koncert | K1125 | KC1125
32.5" Overall Width

DIMENSIONS | K1125 | Chaise Models

Width	32.5	Seat Width	23.75	Back Height	24.5
Depth	39	Seat Depth	21	Arm Height	24.75
Height	42	Seat Height	18.75	Weight	127.5
COM (Standard)	5 YDS	COM (Chaise)	6 YDS	Seat Depth (kick-out)	36
Reclined Depth	71	Weight Capacity	550 lbs.	Distance from Wall	18.5

DIMENSIONS | R1125 | Chaise Models

Width	32.5	Seat Width	23.75	Back Height	24.5
Depth	39	Seat Depth	21	Arm Height	24.25
Height	42	Seat Height	18.5	Weight	127.5
COM (Standard)	5 YDS	COM (Chaise)	6 YDS	Seat Depth (kick-out)	36
Reclined Depth	71	Weight Capacity	550 lbs.	Distance from Wall	18.5

DIMENSIONS | E1125 | Chaise Models

Width	32.5	Seat Width	23.75	Back Height	24.5
Depth	34.25	Seat Depth	21	Arm Height	24.25
Height	43.25	Seat Height	18.75	Weight	127.5
COM (Standard)	5 YDS	COM (Chaise)	6 YDS	Seat Depth (kick-out)	36
Reclined Depth	71	Weight Capacity	550 lbs.	Distance from Wall	19.5

1125 ROCKER RECLINER INFINITE POSITION LOCKING BACK - UPH ARMS

COM	4	5	6	7	8	9	10	11
3719	3759	3909	4039	4219	4419	4669	4979	5509

C1125 CHAISE ROCKER RECLINER INFINITE POSITION LOCKING BACK - UPH ARMS

COM	4	5	6	7	8	9	10	11
3989	4049	4169	4319	4499	4679	4929	5239	5759

Options	List Price	Options	List Price
F Upholstered Arms	Standard	MBB Moisture Barrier Back	\$59
U Urethane Arm Caps*	\$169	MBS Moisture Barrier Seat	\$59
W Wood Arm Caps*	\$229	FBH Foley Bag Holder	\$89
J Solid Surface Arm Caps* - Group 1	\$619 (Group 2 add \$200)	QR Additional Quick Release Accessory Bracket	\$69
Z Multi Cover	Use Highest Grade	MR/L Right/Left Side (facing) Monitor Arm	\$629
CAL CAL TB133	See page 12	MTR/L Right/Left Side (facing) Monitor Arm with Tray	\$629
		ABP Adjustable Back Pad (COM - Grade 6)	\$459
		Adjustable Back Pad (Grade 7-11)	\$569

*Please refer to page 14 for finishes.

Please refer to pages 134/135 for Option descriptions & images.

Please refer to page 132 for the recliner ordering guide.



EV, Rêma | Patient Transfer Arm Rocker Recliners - 24" Seat Width - 550 lb Weight Rating

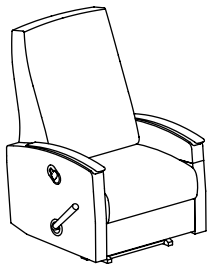

EV | E1125R | EC1125R
32.5" Overall Width

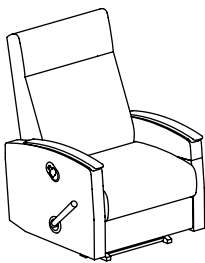

Rêma | R1125R | RC1125R
32.5" Overall Width

DIMENSIONS | E1125R | Chaise Models

Width	32.5	Seat Width	23.75	Back Height	24.5
Depth	34.25	Seat Depth	21	Arm Height	24.25
Height	43.25	Seat Height	18.75	Weight	127.5
COM (Standard)	5 YDS	COM (Chaise)	6 YDS	Seat Depth (kick-out)	36
Reclined Depth	71	Weight Capacity	550 lbs.	Distance from Wall	19.5

DIMENSIONS | R1125R | Chaise Models

Width	32.5	Seat Width	23.75	Back Height	24.5
Depth	39	Seat Depth	21	Arm Height	24.25
Height	42	Seat Height	18.5	Weight	127.5
COM (Standard)	5 YDS	COM (Chaise)	6 YDS	Seat Depth (kick-out)	36
Reclined Depth	71	Weight Capacity	550 lbs.	Distance from Wall	18.5

1125R ROCKER RECLINER INFINITE POSITION LOCKING BACK - RIGHT FACING FOLD DOWN ARM - URETHANE ARM CAPS

COM	4	5	6	7	8	9	10	11	
	4589	4669	4679	4799	4979	5049	5339	5599	5949

C1125R CHAISE ROCKER RECLINER INFINITE POSITION LOCKING BACK RIGHT FACING FOLD DOWN ARM - URETHANE ARM CAPS

COM	4	5	6	7	8	9	10	11	
	4899	5029	5069	5139	5359	5509	5749	6059	6369

*If patient transfer arm is specified on left side (facing), then handle will be placed on right side (facing) and vice versa.

Options	List Price	Options	List Price
U Urethane Arm Caps*	Standard	FBH Foley Bag Holder	\$89
W Wood Arm Caps*	\$229	QR Additional Quick Release Accessory Bracket	\$69
J Solid Surface Arm Caps* - Group 1	\$619 (Group 2 add \$200)	MR/L Right/Left Side (facing) Monitor Arm	\$629
Z Multi Cover	Use Highest Grade	MTR/L Right/Left Side (facing) Monitor Arm with Tray	\$629
CAL CAL TB133	See page 12	ABP Adjustable Back Pad (COM - Grade 6)	\$459
MBB Moisture Barrier Back	\$59	Adjustable Back Pad (Grade 7-11)	\$569
MBS Moisture Barrier Seat	\$59		

*Please refer to page 14 for finishes.

Please refer to pages 134/135 for Option descriptions & images.

Please refer to page 132 for the recliner ordering guide.



EV, Rêma | Patient Transfer Arm Rocker Recliners - 24" Seat Width - 550 lb Weight Rating

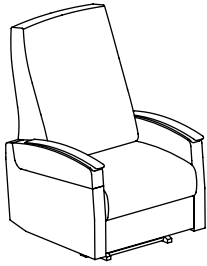

EV | E1125L | EC1125L
32.5" Overall Width

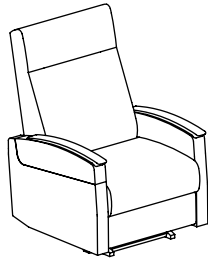

Rêma | R1125L | RC1125L
32.5" Overall Width

DIMENSIONS | E1125L | Chaise Models

Width	32.5	Seat Width	23.75	Back Height	24.5
Depth	34.25	Seat Depth	21	Arm Height	24.25
Height	43.25	Seat Height	18.75	Weight	127.5
COM (Standard)	5 YDS	COM (Chaise)	6 YDS	Seat Depth (kick-out)	36
Reclined Depth	71	Weight Capacity	550 lbs.	Distance from Wall	19.5

DIMENSIONS | R1125L | Chaise Models

Width	32.5	Seat Width	23.75	Back Height	24.5
Depth	39	Seat Depth	21	Arm Height	24.25
Height	42	Seat Height	18.5	Weight	127.5
COM (Standard)	5 YDS	COM (Chaise)	6 YDS	Seat Depth (kick-out)	36
Reclined Depth	71	Weight Capacity	550 lbs.	Distance from Wall	18.5

1125L ROCKER RECLINER INFINITE POSITION LOCKING BACK - LEFT FACING FOLD DOWN ARM - URETHANE ARM CAPS

COM	4	5	6	7	8	9	10	11
4589	4669	4679	4799	4979	5049	5339	5599	5949

C1125L CHAISE ROCKER RECLINER INFINITE POSITION LOCKING BACK - LEFT FACING FOLD DOWN ARM - URETHANE ARM CAPS

COM	4	5	6	7	8	9	10	11
4899	5029	5069	5139	5359	5509	5749	6059	6369

*If patient transfer arm is specified on left side (facing), then handle will be placed on right side (facing) and vice versa.

Options	List Price
U Urethane Arm Caps*	Standard
W Wood Arm Caps*	\$229
J Solid Surface Arm Caps* - Group 1	\$619 (Group 2 add \$200)
Z Multi Cover	Use Highest Grade
CAL CAL TB133	See page 12
MBB Moisture Barrier Back	\$59
MBS Moisture Barrier Seat	\$59
FBH Foley Bag Holder	\$89
QR Additional Quick Release Accessory Bracket	\$69
MR/L Right/Left Side (facing) Monitor Arm	\$629
MTR/L Right/Left Side (facing) Monitor Arm with Tray	\$629
ABP Adjustable Back Pad (COM - Grade 6)	\$459
Adjustable Back Pad (Grade 7-11)	\$569

*Please refer to page 14 for finishes.

Please refer to pages 134/135 for Option descriptions & images.

Please refer to page 132 for the recliner ordering guide.



EV | Rocker Recliners - 24" Seat Width - 550 lb Weight Rating

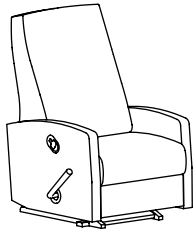

EV | E4125 | EC4125
32" Overall Width

DIMENSIONS | E4125 | EC4125

Width	32	Seat Width	23.75	Back Height	24.5
Depth	34.25	Seat Depth	21	Arm Height	24.25
Height	43.25	Seat Height	18.75	Weight	127.5
COM (Standard)	5 YDS	COM (Chaise)	6 YDS	Seat Depth (kick-out)	36
Reclined Depth	72	Weight Capacity	550 lbs.	Distance from Wall	19.5

E4125 ROCKER RECLINER INFINITE POSITION LOCKING BACK - UPH ARMS

COM	4	5	6	7	8	9	10	11
3719	3759	3909	4039	4219	4419	4669	4979	5509

EC4125 CHAISE ROCKER RECLINER INFINITE POSITION LOCKING BACK - UPH ARMS

COM	4	5	6	7	8	9	10	11
3989	4049	4169	4319	4499	4679	4929	5239	5759

Options

Options	List Price
F Upholstered Arms	Standard
U Urethane Arm Caps*	\$169
W Wood Arm Caps*	\$229
J Solid Surface Arm Caps* - Group 1	\$619 (Group 2 add \$200)
Z Multi Cover	Use Highest Grade
CAL CAL TB133	See page 12
MBB Moisture Barrier Back	\$59
MBS Moisture Barrier Seat	\$59
FBH Foley Bag Holder	\$89
QR Additional Quick Release Accessory Bracket	\$69
MR/L Right/Left Side (facing) Monitor Arm	\$629
MTR/L Right/Left Side (facing) Monitor Arm with Tray	\$629
ABP Adjustable Back Pad (COM - Grade 6)	\$459
Adjustable Back Pad (Grade 7-11)	\$569

*Please refer to page 14 for finishes.

Please refer to pages 134/135 for Option descriptions & images.

Please refer to page 132 for the recliner ordering guide.



EV, Rêma, Koncert | Mobile Rocker Recliners - 24" Seat Width - 550 lb Weight Rating

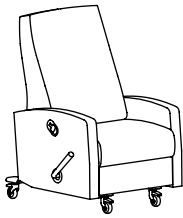

EV | E1127 | EC1127
32.5" Overall Width

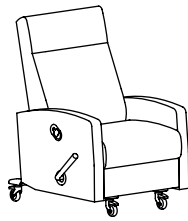

Rêma | R1127 | RC1127
32.5" Overall Width

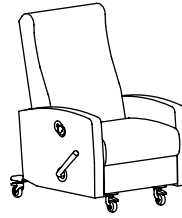

Koncert | K1127 | KC1127
32.5" Overall Width

DIMENSIONS | R1127 | K1127 | Chaise Models

Width	32.5	Seat Width	23.75	Back Height	23.75
Depth	38	Seat Depth	21.5	Arm Height	25
Height	43.5	Seat Height	19.75	Weight	153
COM (Standard)	6 YDS	COM (Chaise)	7 YDS	Seat Depth (kick-out)	37.5
Reclined Depth	72.5	Weight Capacity	550 lbs.	Distance from Wall	19.5

DIMENSIONS | E1127 | Chaise Models

Width	32.5	Seat Width	23.75	Back Height	25
Depth	38	Seat Depth	21.5	Arm Height	25
Height	44.75	Seat Height	19.75	Weight	151
COM (Standard)	6 YDS	COM (Chaise)	7 YDS	Seat Depth (kick-out)	37.5
Reclined Depth	72.5	Weight Capacity	550 lbs.	Distance from Wall	20.5

1127 MOBILE ROCKER RECLINER INFINITE POSITION LOCKING BACK - UPH ARMS

COM	4	5	6	7	8	9	10	11	
	4069	4139	4279	4429	4689	4909	5209	5549	6229

C1127 MOBILE CHAISE ROCKER RECLINER INFINITE POSITION LOCKING BACK - UPH ARMS

COM	4	5	6	7	8	9	10	11	
	4339	4419	4549	4699	4979	5169	5489	5809	6479

Options	List Price
F Upholstered Arms	Standard
U Urethane Arm Caps*	\$169
W Wood Arm Caps*	\$229
J Solid Surface Arm Caps* - Group 1	\$619 (Group 2 add \$200)
Z Multi Cover	Use Highest Grade
CAL CAL TB133	See page 12

Options	List Price
MBB Moisture Barrier Back	\$59
MBS Moisture Barrier Seat	\$59
FBH Foley Bag Holder	\$89
3S4 All 3" Swivel Locking Caster	\$19
AHP Adjustable Headrest Pillow	\$339
(*Requires 1 yd of fabric)	
QR Additional Quick Release Accessory Bracket	\$69
MR/L Right/Left Side (facing) Monitor Arm	\$629
MTR/L Right/Left Side (facing) Monitor Arm with Tray	\$629
ABP Adjustable Back Pad (COM - Grade 6)	\$459
Adjustable Back Pad (Grade 7-11)	\$569

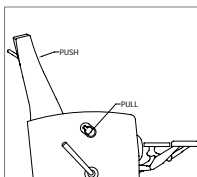

Infinite Position Locking Back Lever

(1127 + 4127 Models Only)

Infinite Position Locking Back lever allows patient/caregivers to lock back in any recline position. Locking Back Lever is located on the inside of the left arm (facing) on select models. Locking Back Lever is located on the outside of the left arm (facing) on Dual Lateral Transfer Arm models.

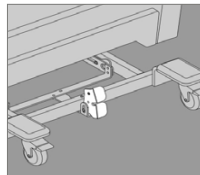

Rocker/Lock Mechanism

(1127 + 4127 Models Only)
The mobile rocker recliner features a locking mechanism that locks the rocker making it easy on the patient for entering/exiting the chair and also during transport.

*Please refer to page 14 for finishes.

Please refer to pages 134/135 for Option descriptions & images.
Please refer to page 132 for the recliner ordering guide.



EV, Rêma | Patient Transfer Arm Mobile Rocker Recliners - 24" Seat Width - 550 lb Weight Rating

DURABLE® 550 SERIES

MOBILE ROCKER RECLINER - PATIENT TRANSFER

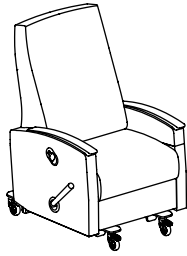

EV | E1127R | EC1127R
32.5" Overall Width

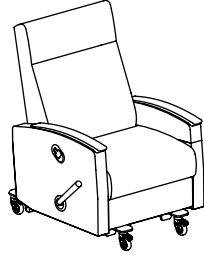

Rêma | R1127R | RC1127R
32.5" Overall Width

DIMENSIONS | E1127R | Chaise Models

Width	32.5	Seat Width	23.75	Back Height	25
Depth	38	Seat Depth	21.5	Arm Height	25
Height	44.75	Seat Height	19.75	Weight	151
COM (Standard)	6 YDS	COM (Chaise)	7 YDS	Seat Depth (kick-out)	37.5
Reclined Depth	72.5	Weight Capacity	550 lbs.	Distance from Wall	20.5

DIMENSIONS | R1127R | Chaise Models

Width	32.5	Seat Width	23.75	Back Height	23.75
Depth	38	Seat Depth	21.5	Arm Height	25
Height	43.5	Seat Height	19.75	Weight	153
COM (Standard)	6 YDS	COM (Chaise)	7 YDS	Seat Depth (kick-out)	37.5
Reclined Depth	72.5	Weight Capacity	550 lbs.	Distance from Wall	19.5

1127R MOBILE ROCKER RECLINER INFINITE POSITION LOCKING BACK - RIGHT FACING FOLD DOWN ARM - URETHANE ARM CAPS

COM	4	5	6	7	8	9	10	11	
	4839	4899	4909	5039	5209	5289	5569	5819	6169

C1127R MOBILE CHAISE ROCKER RECLINER INFINITE POSITION LOCKING BACK - RIGHT FACING FOLD DOWN ARM - URETHANE ARM CAPS

COM	4	5	6	7	8	9	10	11	
	5139	5279	5309	5379	5589	5739	5979	6279	6599

*If patient transfer arm is specified on left side (facing), then handle will be placed on right side (facing) and vice versa.

Options

U	Urethane Arm Caps*	Standard
W	Wood Arm Caps*	\$229
J	Solid Surface Arm Caps* - Group 1	\$619 (Group 2 add \$200)
Z	Multi Cover	Use Highest Grade

Options

CAL	CAL TB133	See page 12
MBB	Moisture Barrier Back	\$59
MBS	Moisture Barrier Seat	\$59
FBH	Foley Bag Holder	\$89
3S4	All 3" Swivel Locking Caster	\$19
AHP	Adjustable Headrest Pillow (*Requires 1 yd of fabric)	\$339
QR	Additional Quick Release Accessory Bracket	\$69
MR/L	Right/Left Side (facing) Monitor Arm (non-fold down arm only)	\$629
MTR/L	Right/Left Side (facing) Monitor Arm with Tray (non-fold down arm only)	\$629
ABP	Adjustable Back Pad (COM - Grade 6)	\$459
	Adjustable Back Pad (Grade 7-11)	\$569

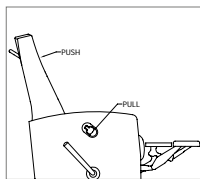

Infinite Position Locking Back Lever
(1127 + 4127 Models Only)
Infinite Position Locking Back lever allows patient/caregivers to lock back in any recline position. Locking Back Lever is located on the inside of the left arm (facing) on select models. Locking Back Lever is located on the outside of the left arm (facing) on Dual Lateral Transfer Arm models.

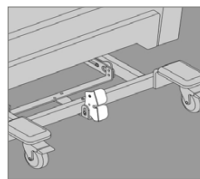

Rocker/Lock Mechanism
(1127 + 4127 Models Only)
The mobile rocker recliner features a locking mechanism that locks the rocker making it easy on the patient for entering/exiting the chair and also during transport.

*Please refer to page 14 for finishes.

Please refer to pages 134/135 for Option descriptions & images.
Please refer to page 132 for the recliner ordering guide.



EV, Rêma | Patient Transfer Arm Mobile Rocker Recliners - 24" Seat Width - 550 lb Weight Rating

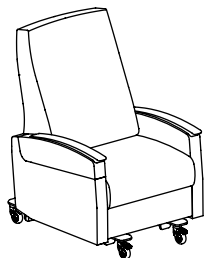

EV | E1127L | EC1127L
32.5" Overall Width

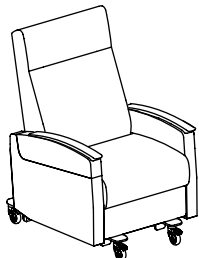

Rêma | R1127L | RC1127L
32.5" Overall Width

DIMENSIONS | E1127L | Chaise Models

Width	32.5	Seat Width	23.75	Back Height	25
Depth	38	Seat Depth	21.5	Arm Height	25
Height	44.75	Seat Height	19.75	Weight	151
COM (Standard)	6 YDS	COM (Chaise)	7 YDS	Seat Depth (kick-out)	37.5
Reclined Depth	72.5	Weight Capacity	550 lbs.	Distance from Wall	20.5

DIMENSIONS | R1127L | Chaise Models

Width	32.5	Seat Width	23.75	Back Height	23.75
Depth	38	Seat Depth	21.5	Arm Height	25
Height	43.5	Seat Height	19.75	Weight	153
COM (Standard)	6 YDS	COM (Chaise)	7 YDS	Seat Depth (kick-out)	37.5
Reclined Depth	72.5	Weight Capacity	550 lbs.	Distance from Wall	19.5

1127L MOBILE ROCKER RECLINER INFINITE POSITION LOCKING BACK - LEFT FACING FOLD DOWN ARM - URETHANE ARM CAPS

COM	4	5	6	7	8	9	10	11
4839	4899	4909	5039	5209	5289	5569	5819	6169

C1127L MOBILE CHAISE ROCKER RECLINER INFINITE POSITION LOCKING BACK - LEFT FACING FOLD DOWN ARM - URETHANE ARM CAPS

COM	4	5	6	7	8	9	10	11
5139	5279	5309	5379	5589	5739	5979	6279	6599

*If patient transfer arm is specified on left side (facing), then handle will be placed on right side (facing) and vice versa.

Options	List Price	Options	List Price
U Urethane Arm Caps*	Standard	MBS Moisture Barrier Seat	\$59
W Wood Arm Caps*	\$229	FBH Foley Bag Holder	\$89
J Solid Surface Arm Caps* - Group 1	\$619 (Group 2 add \$200)	3S4 All 3" Swivel Locking Caster	\$19
Z Multi Cover	Use Highest Grade	AHP Adjustable Headrest Pillow	\$339
CAL CAL TB133	See page 12	(*Requires 1 yd of fabric)	
MBB Moisture Barrier Back	\$59	QR Additional Quick Release Accessory Bracket	\$69
		MR/L Right/Left Side (facing) Monitor Arm	\$629
		(non-fold down arm only)	
		MTR/L Right/Left Side (facing) Monitor Arm with Tray	\$629
		(non-fold down arm only)	
		ABP Adjustable Back Pad (COM - Grade 6)	\$459
		Adjustable Back Pad (Grade 7-11)	\$569

*Please refer to page 14 for finishes.

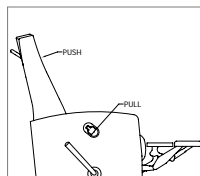

Infinite Position Locking Back Lever
(1127 + 4127 Models Only)

Infinite Position Locking Back lever allows patient/caregivers to lock back in any recline position. Locking Back Lever is located on the inside of the left arm (facing) on select models. Locking Back Lever is located on the outside of the left arm (facing) on Dual Lateral Transfer Arm models.

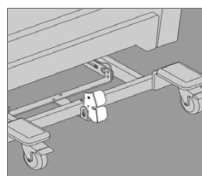

Rocker/Lock Mechanism
(1127 + 4127 Models Only)

The mobile rocker recliner features a locking mechanism that locks the rocker making it easy on the patient for entering/exiting the chair and also during transport.

Please refer to pages 134/135 for Option descriptions & images.
Please refer to page 132 for the recliner ordering guide.



EV | Mobile Rocker Recliners - 24" Seat Width - 550 lb Weight Rating

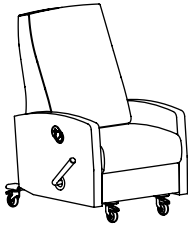

EV | E4127 | EC4127
32.5" Overall Width

DIMENSIONS | E4127 | EC4127

Width	32	Seat Width	23.75	Back Height	25
Depth	38	Seat Depth	21.5	Arm Height	25
Height	44.75	Seat Height	19.75	Weight	151
COM (Standard)	6 YDS	COM (Chaise)	7 YDS	Seat Depth (kick-out)	37.5
Reclined Depth	72.5	Weight Capacity	550 lbs.	Distance from Wall	20.5

E4127 MOBILE ROCKER RECLINER INFINITE POSITION LOCKING BACK - UPH ARMS

COM	4	5	6	7	8	9	10	11
4069	4139	4279	4429	4689	4909	5209	5549	6229

EC4127 MOBILE CHAISE ROCKER RECLINER INFINITE POSITION LOCKING BACK - UPH ARMS

COM	4	5	6	7	8	9	10	11
4339	4419	4549	4699	4979	5169	5489	5809	6479

Options	List Price
F Upholstered Arms	Standard
U Urethane Arm Caps*	\$169
W Wood Arm Caps*	\$229
J Solid Surface Arm Caps* - Group 1	\$619 (Group 2 add \$200)
Z Multi Cover	Use Highest Grade
CAL CAL TB133	See page 12
MBB Moisture Barrier Back	\$59
MBS Moisture Barrier Seat	\$59
FBH Foley Bag Holder	\$89
3S4 (1) 3" Swivel Locking Caster	\$19
AHP Adjustable Headrest Pillow	\$339 (*Requires 1 yd of fabric)
USB Hospital Grade Power	\$459
QR Additional Quick Release Accessory Bracket	\$69
ABP Adjustable Back Pad (COM - Grade 6)	\$459
Adjustable Back Pad (Grade 7-11)	\$569

*Please refer to page 14 for finishes.

Please refer to pages 134/135 for Option descriptions & images.

Please refer to page 132 for the recliner ordering guide.



Durable® 650 Series

The Durable® 650 Series is our premier collection of mobile healthcare recliners. Featuring our patented unitized mechanism that is counter balanced by weight (extending to a true flatbed position), 650 lb weight capacity, and near limitless option configurations to adapt to any environment, the Durable® 650 Series truly encapsulates our core product values of Comfort, Durability, and Performance to make it a recliner choice trusted by patients and caregivers alike. Engineered from the ground up with cleanability in mind, its removable back and lift up seat, along with the absence of entrapment areas make it a strong asset in infection control. Our legacy of Comfort combine with a passion for well-being in the Durable® 650 Series to prove beyond doubt- Comfort Heals®.



EV | Compact Mobile Healthcare Recliners - 22" Seat Width & 650 lb Weight Rating

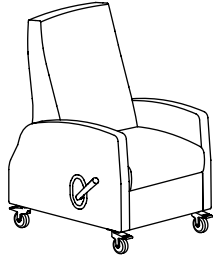

E3017 | E3117
30" Overall Width

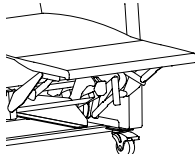

Chaise Model*
EC3017 | EC3117

DIMENSIONS | E3017 | E3117 | EC3017 | EC3117

Width	30	Seat Width	22	Back Height	25
Depth	35.5	Seat Depth	21	Arm Height	27
Height	47	Seat Height	21.5	Weight (3017)	147
COM (Standard)	5.5 YDS	COM (Chaise)	6.5 YDS	Weight (3117)	155
Reclined Depth	76	Seat Depth (kick-out)	39	Distance from Wall	20
Weight Capacity	650 lbs.				

E3017 MOBILE HEALTHCARE RECLINER - INFINITE POSITION NON-LOCKING BACK - UPH ARMS

COM	4	5	6	7	8	9	10	11
3739	3789	3919	4119	4349	4579	4859	5199	6609

E3117 MOBILE HEALTHCARE RECLINER - INFINITE POSITION LOCKING BACK - UPH ARMS

COM	4	5	6	7	8	9	10	11
3989	4109	4199	4389	4649	4869	5169	5269	6699

EC3017 CHAISE MOBILE HEALTHCARE RECLINER - INFINITE POSITION NON-LOCKING BACK - UPH ARMS

COM	4	5	6	7	8	9	10	11
3969	4089	4239	4499	4809	5099	5479	5929	7459

EC3117 CHAISE MOBILE HEALTHCARE RECLINER - INFINITE POSITION LOCKING BACK - UPH ARMS

COM	4	5	6	7	8	9	10	11
4229	4369	4509	4779	5109	5389	5789	5999	7529

Options	List Price	Options	List Price
F Upholstered Arms	Standard	MR/L Right/Left Side (facing) Monitor Arm	\$629
U Urethane Arm Caps*	\$169	MTR/L Right/Left Side (facing) Monitor Arm with Tray	\$629
W Wood Arm Caps*	\$229	4S4 All 4" Swivel Locking Caster	\$39
J Solid Surface Arm Caps* - Group 1	\$619 (Group 2 add \$200)	AHP Adjustable Head Rest Pillow (Requires 1 yd of fabric)	\$339
Z Multi Cover	Use Highest Grade	ABP Adjustable Back Pad (COM-Grade 6) 1.75yd COM	\$459
H Heat (Certified to UL 60601-1)	\$849	Adjustable Back Pad (Grade 7-11)	\$569
HM Heat & Massage (Certified to UL 60601-1)	\$1119	DP Dual IV Poles	\$498
HW Heat Wand (Certified to UL 60601-1)	\$1139	FBH Foley Bag Holder	\$89
HMW Heat & Massage Wand (Certified to UL 60601-1)	\$1369	FT Foot Tray	\$279
S4 4" 2-Caster Lock & Steer	\$569	IV IV Pole and Bracket	\$249
Q3 3" Dual Wheel Central Locking Caster (Non-Directional)	\$1019	LFSTR Lg Right Side (facing) Folding Side Tray	\$249
Q4 4" Central Caster Lock & Steer	\$1019	<i>*Contact Customer Service for Solid Surface Pricing</i>	
Q5 5" Central Caster Lock & Steer	\$1139	LFSTRCH Lg Right Side (facing) Folding Cup Holder Tray	\$319
EG Edge Guard	Standard	PLFSTR Padded Lg Right Side (facing) Folding Side Tray	\$379
CAL CAL TB133	See page 12	<i>(Requires 1 yd of fabric.)</i>	
MBB Moisture Barrier Back	\$59	USB Hospital Grade Power	\$459
MBS Moisture Barrier Seat	\$59	QR Additional Quick Release Accessory Bracket	\$69
LC LiquiCell	\$229	SFSTR Sm Right Side (facing) Folding Side Tray	\$249
(Standard on Heat or Heat & Massage option)		<i>*Contact Customer Service for Solid Surface Pricing</i>	
		TD3 Dual Side Tray (Dual TSL1/TSR1)**	\$798
		TE Trendelenburg	\$339
		TSL1 Left Side (facing) Tray**	\$399
		TSR1 Right Side (facing) Tray**	\$399
		WR Wrist Restraint (per pair)	\$229
		PR1 Paper Roll Holder (takes place of push bar)	\$229

*Please refer to page 14 for finishes.

*Please refer to pages 134/135 for Options descriptions & images and page 132 for recliner ordering guide.

**Over the lap tray function recommended in seating position.



Rêma | Compact Mobile Healthcare Recliners - 22" Seat Width & 650 lb Weight Rating

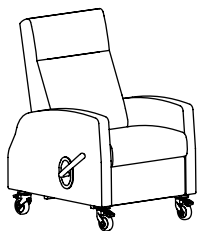

DIMENSIONS | R3017 | R3117 | RC3017 | RC3117

Width	31	Seat Width	22	Back Height	26
Depth	35.5	Seat Depth	21	Arm Height	28
Height	47	Seat Height	21.5	Weight (3017)	158
COM (Standard)	5.1 YDS	COM (Chaise)	6.5 YDS	Weight (3117)	166
Reclined Depth	76	Seat Depth (kick-out)	40	Distance from Wall	20
Weight Capacity	650 lbs.				

R3017 | R3117
31" Overall Width

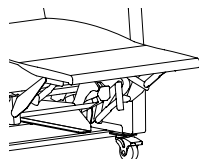

Chaise Model*
RC3017 | RC3117

R3017 MOBILE HEALTHCARE RECLINER - INFINITE POSITION NON-LOCKING BACK - UPH ARMS

COM	4	5	6	7	8	9	10	11
	3739	3789	3919	4119	4349	4579	4859	5199

R3117 MOBILE HEALTHCARE RECLINER - INFINITE POSITION LOCKING BACK - UPH ARMS

COM	4	5	6	7	8	9	10	11
	3989	4109	4199	4389	4649	4869	5169	5269

RC3017 CHAISE MOBILE HEALTHCARE RECLINER - INFINITE POSITION NON-LOCKING BACK - UPH ARMS

COM	4	5	6	7	8	9	10	11
	3969	4089	4239	4499	4809	5099	5479	5929

RC3117 CHAISE MOBILE HEALTHCARE RECLINER - INFINITE POSITION LOCKING BACK - UPH ARMS

COM	4	5	6	7	8	9	10	11
	4229	4369	4509	4779	5109	5389	5789	5999

Options	List Price	Options	List Price
F Upholstered Arms	Standard	AHP Adjustable Head Rest Pillow (Requires 1 yd of fabric)	\$339
U Urethane Arm Caps*	\$169	ABP Adjustable Back Pad (COM-Grade 6) 1.75yd COM	\$459
W Wood Arm Caps*	\$229	Adjustable Back Pad (Grade 7-11)	\$569
J Solid Surface Arm Caps* - Group 1	\$619 (Group 2 add \$200)	DP Dual IV Poles	\$498
Z Multi Cover	Use Highest Grade	IV IV Pole and Bracket	\$249
H Heat (Certified to UL 60601-1)	\$849	LFSTR Lg Right Side (facing) Folding Side Tray	\$249
HM Heat & Massage (Certified to UL 60601-1)	\$1119	*Contact Customer Service for Solid Surface Pricing	
HW Heat Wand (Certified to UL 60601-1)	\$1139	LFSTRCH Lg Right Side (facing) Folding Cup Holder Tray	\$319
HMW Heat & Massage Wand (Certified to UL 60601-1)	\$1369	PLFSTR Padded Lg Right Side (facing) Folding Side Tray	\$379
S4 4" 2-Caster Lock & Steer	\$569	(Requires 1 yd of fabric.)	
Q3 3" Dual Wheel Central Locking Caster (Non-Directional)	\$1019	USB Hospital Grade Power	\$459
Q4 4" Central Caster Lock & Steer	\$1019	QR Additional Quick Release Accessory Bracket	\$69
Q5 5" Central Caster Lock & Steer	\$1139	SFSTR Sm Right Side (facing) Folding Side Tray	\$249
EG Edge Guard	Standard	*Contact Customer Service for Solid Surface Pricing	
CAL CAL TB133	See page 12	TD3 Dual Side Tray (Dual TSL1/TSR1)**	\$798
MBB Moisture Barrier Back	\$59	TE Trendelenburg	\$339
MBS Moisture Barrier Seat	\$59	TSL1 Left Side (facing) Tray**	\$399
4S4 All 4" Swivel Locking Caster	\$39	TSR1 Right Side (facing) Tray**	\$399
MR/L Right/Left Side (facing) Monitor Arm	\$629	WR Wrist Restraint (per pair)	\$229
MTR/L Right/Left Side (facing) Monitor Arm with Tray	\$629	LC LiquiCell	\$229
FBH Foley Bag Holder	\$89	(Standard on Heat or Heat & Massage option)	
FT Foot Tray	\$279	PR1 Paper Roll Holder (takes place of push bar)	\$229

*Please refer to page 14 for finishes.

*Please refer to pages 134/135 for Options descriptions & images and page 132 for recliner ordering guide.

**Over the lap tray function recommended in seating position.



Koncert | Compact Mobile Healthcare Recliners - 22" Seat Width & 650 lb Weight Rating



DIMENSIONS | K3017 | K3117 | KC3017 | KC3117

Width	31	Seat Width	22	Back Height	26
Depth	35.5	Seat Depth	21	Arm Height	28
Height	47	Seat Height	21.5	Weight (3017)	158
COM (Standard)	5.5 YDS	COM (Chaise)	6.5 YDS	Weight (3117)	166
Reclined Depth	76	Seat Depth (kick-out)	40	Distance from Wall	20
Weight Capacity	650 lbs.				

E3017 | E3117
31" Overall Width

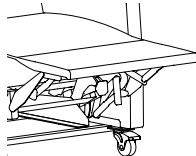

Chaise Model*
KC3017 | KC3117

K3017 MOBILE HEALTHCARE RECLINER - INFINITE POSITION NON-LOCKING BACK - UPH ARMS

COM	4	5	6	7	8	9	10	11
3739	3789	3919	4119	4349	4579	4859	5199	6609

K3117 MOBILE HEALTHCARE RECLINER - INFINITE POSITION LOCKING BACK - UPH ARMS

COM	4	5	6	7	8	9	10	11
3989	4109	4199	4389	4649	4869	5169	5269	6699

KC3017 CHAISE MOBILE HEALTHCARE RECLINER - INFINITE POSITION NON-LOCKING BACK - UPH ARMS

COM	4	5	6	7	8	9	10	11
3969	4089	4239	4499	4809	5099	5479	5929	7459

KC3117 CHAISE MOBILE HEALTHCARE RECLINER- INFINITE POSITION LOCKING BACK - UPH ARMS

COM	4	5	6	7	8	9	10	11
4229	4369	4509	4779	5109	5389	5789	5999	7529

Options	List Price	Options	List Price
F Upholstered Arms	Standard	MR/L Right/Left Side (facing) Monitor Arm	\$629
U Urethane Arm Caps*	\$169	MTR/L Right/Left Side (facing) Monitor Arm with Tray	\$629
W Wood Arm Caps*	\$229	4S4 All 4" Swivel Locking Caster	\$39
J Solid Surface Arm Caps* - Group 1	\$619 (Group 2 add \$200)	AHP Adjustable Head Rest Pillow (Requires 1 yd of fabric)	\$339
Z Multi Cover	Use Highest Grade	ABP Adjustable Back Pad (COM-Grade 6) 1.75yd COM	\$459
H Heat (Certified to UL 60601-1)	\$849	Adjustable Back Pad (Grade 7-11)	\$569
HM Heat & Massage (Certified to UL 60601-1)	\$1119	DP Dual IV Poles	\$498
HW Heat Wand (Certified to UL 60601-1)	\$1139	FBH Foley Bag Holder	\$89
HMW Heat & Massage Wand (Certified to UL 60601-1)	\$1369	FT Foot Tray	\$279
S4 4" 2-Caster Lock & Steer	\$569	IV IV Pole and Bracket	\$249
Q3 3" Dual Wheel Central Locking Caster (Non-Directional)	\$1019	LFSTR Lg Right Side (facing) Folding Side Tray *Contact Customer Service for Solid Surface Pricing	\$249
Q4 4" Central Caster Lock & Steer	\$1019	LFSTRCH Lg Right Side (facing) Folding Cup Holder Tray	\$319
Q5 5" Central Caster Lock & Steer	\$1139	PLFSTR Padded Lg Right Side (facing) Folding Side Tray (Requires 1 yd of fabric.)	\$379
EG Edge Guard	Standard	USB Hospital Grade Power	\$459
CAL CAL TB133	See page 12	QR Additional Quick Release Accessory Bracket	\$69
MBB Moisture Barrier Back	\$59	SFSTR Sm Right Side (facing) Folding Side Tray *Contact Customer Service for Solid Surface Pricing	\$249
MBS Moisture Barrier Seat	\$59	TD3 Dual Side Tray (Dual TSL1/TSR1)**	\$798
LC LiquiCell	\$229	TE Trendelenburg	\$339
(Standard on Heat or Heat & Massage option)		TSL1 Left Side (facing) Tray**	\$399
		TSR1 Right Side (facing) Tray**	\$399
		WR Wrist Restraint (per pair)	\$229
		PR1 Paper Roll Holder (takes place of push bar)	\$229

*Please refer to page 14 for finishes.

*Please refer to pages 134/135 for Options descriptions & images and page 132 for recliner ordering guide.

**Over the lap tray function recommended in seating position.



Kadia Mod | Compact Mobile Healthcare Recliners - 22" Seat Width & 650 lb Weight Rating

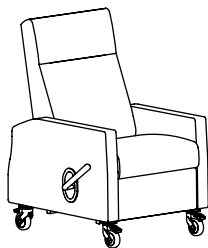

KM3017 | KM3117
31" Overall Width

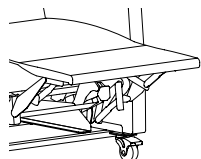

Chaise Model*
KMC3017 | KMC3117

DIMENSIONS | KM3017 | KM3117 | KMC3017 | KMC3117

Width	31	Seat Width	22	Back Height	26
Depth	35.5	Seat Depth	21	Arm Height	26.5
Height	47	Seat Height	21.5	Weight (3017)	158
COM (Standard)	5.1 YDS	COM (Chaise)	6.5 YDS	Weight (3117)	166
Reclined Depth	76	Seat Depth (kick-out)	40	Distance from Wall	20
Weight Capacity	650 lbs.				

KM3017 MOBILE HEALTHCARE RECLINER - INFINITE POSITION NON-LOCKING BACK - UPH ARMS

COM	4	5	6	7	8	9	10	11
3739	3789	3919	4119	4349	4579	4859	5199	6609

KM3117 MOBILE HEALTHCARE RECLINER - INFINITE POSITION LOCKING BACK - UPH ARMS

COM	4	5	6	7	8	9	10	11
3989	4109	4199	4389	4649	4869	5169	5269	6699

KMC3017 CHAISE MOBILE HEALTHCARE RECLINER - INFINITE POSITION NON-LOCKING BACK - UPH ARMS

COM	4	5	6	7	8	9	10	11
3969	4089	4239	4499	4809	5099	5479	5929	7459

KMC3117 CHAISE MOBILE HEALTHCARE RECLINER- INFINITE POSITION LOCKING BACK - UPH ARMS

COM	4	5	6	7	8	9	10	11
4229	4369	4509	4779	5109	5389	5789	5999	7529

Options	List Price	Options	List Price
F Upholstered Arms	Standard	AHP Adjustable Head Rest Pillow (Requires 1 yd of fabric)	\$339
U Urethane Arm Caps*	\$169	ABP Adjustable Back Pad (COM-Grade 6) 1.75yd COM	\$459
W Wood Arm Caps*	\$229	Adjustable Back Pad (Grade 7-11)	\$569
J Solid Surface Arm Caps* - Group 1	\$619 (Group 2 add \$200)	DP Dual IV Poles	\$498
Z Multi Cover	Use Highest Grade	IV IV Pole and Bracket	\$249
H Heat (Certified to UL 60601-1)	\$849	LFSTR Lg Right Side (facing) Folding Side Tray	\$249
HM Heat & Massage (Certified to UL 60601-1)	\$1119	*Contact Customer Service for Solid Surface Pricing	
HW Heat Wand (Certified to UL 60601-1)	\$1139	LFSTRCH Lg Right Side (facing) Folding Cup Holder Tray	\$319
HMW Heat & Massage Wand (Certified to UL 60601-1)	\$1369	PLFSTR Padded Lg Right Side (facing) Folding Side Tray	\$379
S4 4" 2-Caster Lock & Steer	\$569	(Requires 1 yd of fabric.)	
Q3 3" Dual Wheel Central Locking Caster (Non-Directional)	\$1019	USB Hospital Grade Power	\$459
Q4 4" Central Caster Lock & Steer	\$1019	QR Additional Quick Release Accessory Bracket	\$69
Q5 5" Central Caster Lock & Steer	\$1139	SFSTR Sm Right Side (facing) Folding Side Tray	\$249
EG Edge Guard	Standard	*Contact Customer Service for Solid Surface Pricing	
CAL CAL TB133	See page 12	TD3 Dual Side Tray (Dual TSL1/TSR1)**	\$798
MBB Moisture Barrier Back	\$59	TE Trendelenburg	\$339
MBS Moisture Barrier Seat	\$59	TSL1 Left Side (facing) Tray**	\$399
4S4 All 4" Swivel Locking Caster	\$39	TSR1 Right Side (facing) Tray**	\$399
MR/L Right/Left Side (facing) Monitor Arm	\$629	WR Wrist Restraint (per pair)	\$229
MTR/L Right/Left Side (facing) Monitor Arm with Tray	\$629	LC LiquiCell	\$229
FBH Foley Bag Holder	\$89	(Standard on Heat or Heat & Massage option)	
FT Foot Tray	\$279	PR1 Paper Roll Holder (takes place of push bar)	\$229

*Please refer to page 14 for finishes.

*Please refer to pages 134/135 for Options descriptions & images and page 132 for recliner ordering guide.

**Over the lap tray function recommended in seating position.



EV | Mobile Healthcare Recliners - 24" Seat Width & 650 lb Weight Rating

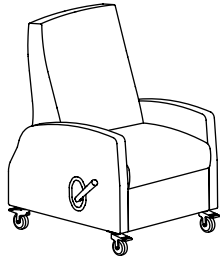

E4017 | E4117
32.5" Overall Width

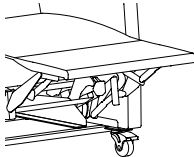

Chaise Model*
EC4017 | EC4117

DIMENSIONS | E4017 | E4117 | EC4017 | EC4117

Width	32.5	Seat Width	24	Back Height	25
Depth	35.5	Seat Depth	21	Arm Height	27
Height	47	Seat Height	21.5	Weight (4017)	147
COM (Standard)	5.5 YDS	COM (Chaise)	6.5 YDS	Weight (4117)	155
Reclined Depth	76	Seat Depth (kick-out)	39	Distance from Wall	20
Weight Capacity	650 lbs.				

E4017 MOBILE HEALTHCARE RECLINER - INFINITE POSITION NON-LOCKING BACK - UPH ARMS

COM	4	5	6	7	8	9	10	11
3739	3789	3919	4119	4349	4579	4859	5199	6609

E4117 MOBILE HEALTHCARE RECLINER - INFINITE POSITION LOCKING BACK - UPH ARMS

COM	4	5	6	7	8	9	10	11
3989	4109	4199	4389	4649	4869	5169	5269	6699

EC4017 MOBILE HEALTHCARE CHAISE RECLINER - INFINITE POSITION NON-LOCKING BACK - UPH ARMS

COM	4	5	6	7	8	9	10	11
3969	4089	4239	4499	4809	5099	5479	5929	7459

EC4117 MOBILE HEALTHCARE CHAISE RECLINER - INFINITE POSITION LOCKING BACK - UPH ARMS

COM	4	5	6	7	8	9	10	11
4229	4369	4509	4779	5109	5389	5789	5999	7529

Options	List Price	Options	List Price
F Upholstered Arms	Standard	MR/L Right/Left Side (facing) Monitor Arm	\$629
U Urethane Arm Caps*	\$169	MTR/L Right/Left Side (facing) Monitor Arm with Tray	\$629
W Wood Arm Caps*	\$229	4S4 All 4" Swivel Locking Caster	\$39
J Solid Surface Arm Caps* - Group 1	\$619 (Group 2 add \$200)	AHP Adjustable Head Rest Pillow (Requires 1 yd of fabric)	\$339
Z Multi Cover	Use Highest Grade	ABP Adjustable Back Pad (COM-Grade 6) 1.75yd COM	\$459
H Heat (Certified to UL 60601-1)	\$849	Adjustable Back Pad (Grade 7-11)	\$569
HM Heat & Massage (Certified to UL 60601-1)	\$1119	DP Dual IV Poles	\$498
HW Heat Wand (Certified to UL 60601-1)	\$1139	FBH Foley Bag Holder	\$89
HMW Heat & Massage Wand (Certified to UL 60601-1)	\$1369	FT Foot Tray	\$279
S4 4" 2-Caster Lock & Steer	\$569	IV IV Pole and Bracket	\$249
Q3 3" Dual Wheel Central Locking Caster (Non-Directional)	\$1019	LFSTR Lg Right Side (facing) Folding Side Tray	\$249
Q4 4" Central Caster Lock & Steer	\$1019	<i>*Contact Customer Service for Solid Surface Pricing</i>	
Q5 5" Central Caster Lock & Steer	\$1139	LFSTRCH Lg Right Side (facing) Folding Cup Holder Tray	\$319
EG Edge Guard	Standard	PLFSTR Padded Lg Right Side (facing) Folding Side Tray	\$379
CAL CAL TB133	See page 12	<i>(Requires 1 yd of fabric.)</i>	
MBB Moisture Barrier Back	\$59	USB Hospital Grade Power	\$459
MBS Moisture Barrier Seat	\$59	QR Additional Quick Release Accessory Bracket	\$69
LC LiquiCell	\$229	SFSTR Sm Right Side (facing) Folding Side Tray	\$249
<i>(Standard on Heat or Heat & Massage option)</i>		<i>*Contact Customer Service for Solid Surface Pricing</i>	
*Please refer to page 14 for finishes.		TD3 Dual Side Tray (Dual TSL1/TSR1)**	\$798
*Please refer to pages 134/135 for Options descriptions & images and page 132 for recliner ordering guide.		TE Trendelenburg	\$339
Over the lap tray function recommended in seating position.		TSL1 Left Side (facing) Tray	\$399
		TSR1 Right Side (facing) Tray**	\$399
		WR Wrist Restraint (per pair)	\$229
		PR1 Paper Roll Holder (takes place of push bar)	\$229



Harmony | Mobile Healthcare Recliners - 24" Seat Width & 650 lb Weight Rating

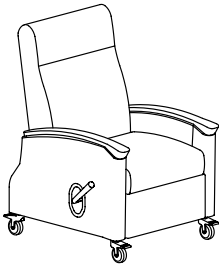

H5017 | H5117
34" Overall Width

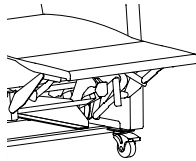

Chaise Model*
HC5017 | HC5117

DIMENSIONS | H5017 | H5117 | HC5017 | HC5117

Width	34	Seat Width	24	Back Height	26
Depth	38	Seat Depth	21	Arm Height	28
Height	47	Seat Height	21.5	Weight (5017)	160
COM	6 YDS	Seat Depth (kick-out)	40	Weight (5117)	168
Reclined Depth	76	Distance from Wall	20	Weight Capacity	650 lbs.

H5017 MOBILE HEALTHCARE RECLINER - INFINITE POSITION NON-LOCKING BACK - URETHANE ARM CAPS

COM	4	5	6	7	8	9	10	11
4119	4179	4279	4439	4689	4889	5149	5489	7099

H5117 MOBILE HEALTHCARE RECLINER - INFINITE POSITION LOCKING BACK - URETHANE ARM CAPS

COM	4	5	6	7	8	9	10	11
4439	4499	4609	4789	5039	5249	5529	5829	7429

HC5017 MOBILE HEALTHCARE CHAISE RECLINER - INFINITE POSITION NON-LOCKING BACK - URETHANE ARM CAPS

COM	4	5	6	7	8	9	10	11
4349	4439	4579	4829	5149	5429	5769	6219	7939

HC5117 MOBILE HEALTHCARE CHAISE RECLINER - INFINITE POSITION LOCKING BACK - URETHANE ARM CAPS

COM	4	5	6	7	8	9	10	11
4669	4769	4899	5159	5499	5779	6139	6559	8289

Options	List Price	Options	List Price
U Urethane Arm Caps*	Standard	AHP Adjustable Head Rest Pillow (Requires 1 yd of fabric)	\$339
W Wood Arm Caps*	\$229	ABP Adjustable Back Pad (COM-Grade 6) 1.75yd COM Adjustable Back Pad (Grade 7-11)	\$459 \$569
Z Multi Cover	Use Highest Grade	DP Dual IV Poles	\$498
H Heat (Certified to UL 60601-1)	\$849	IV IV Pole and Bracket	\$249
HM Heat & Massage (Certified to UL 60601-1)	\$1119	LFSTR Lg Right Side (facing) Folding Side Tray <i>*Contact Customer Service for Solid Surface Pricing</i>	\$249
HW Heat Wand (Certified to UL 60601-1)	\$1139	LFSTRCH Lg Right Side (facing) Folding Cup Holder Tray	\$319
HMW Heat & Massage Wand (Certified to UL 60601-1)	\$1369	PLFSTR Padded Lg Right Side (facing) Folding Side Tray (Requires 1 yd of fabric.)	\$379
S4 4" 2-Caster Lock & Steer	\$569	USB Hospital Grade Power	\$459
EG Edge Guard	Standard	QR Additional Quick Release Accessory Bracket	\$69
CAL CAL TB133	See page 12	SFSTR Sm Right Side (facing) Folding Side Tray <i>*Contact Customer Service for Solid Surface Pricing</i>	\$249
MBB Moisture Barrier Back	\$59	TD3 Dual Side Tray (Dual TSL1/TSR1)**	\$798
MBS Moisture Barrier Seat	\$59	TE Trendelenburg	\$339
4S4 All 4" Swivel Locking Caster	\$39	TSL1 Left Side (facing) Tray**	\$399
ML/R Right/Left Side (facing) Monitor Arm	\$629	TSR1 Right Side (facing) Tray**	\$399
MTL/R Right/Left Side (facing) Monitor Arm with Tray	\$629	WR Wrist Restraint (per pair)	\$229
FBH Foley Bag Holder	\$89	PR1 Paper Roll Holder (takes place of push bar)	\$229
FT Foot Tray	\$279		
LC LiquiCell (Standard on Heat or Heat & Massage option)	\$229		

*Please refer to page 14 for finishes.

**Over the lap tray function recommended in seating position.

Please refer to pages 134/135 for Options descriptions & images and page 132 for recliner ordering guide.



EV | Mobile Healthcare Wingback Recliners - 24" Seat Width & 650 lb Weight Rating

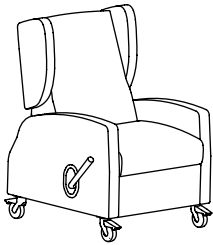

E2017 | E2117
33.5" Overall Width

DIMENSIONS | E2017 | E2117 | EC2017 | EC2117

Width	33.5	Seat Width	24	Back Height	26
Depth	38	Seat Depth	21	Arm Height	28
Height	47	Seat Height	21.5	Weight (2017)	168
COM (Standard)	6 YDS	COM (Chaise)	7 YDS	Weight (2117)	176
Reclined Depth	76	Seat Depth (kick-out)	40	Distance from Wall	20
Weight Capacity	650 lbs.				

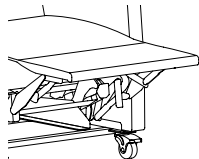

Chaise Model*
EC2017 | EC2117

E2017 MOBILE HEALTHCARE WINGBACK RECLINER - INFINITE POSITION NON-LOCKING BACK - UPH ARMS

COM	4	5	6	7	8	9	10	11
4659	4729	4829	5009	5259	5429	5739	6039	7569

E2117 MOBILE HEALTHCARE WINGBACK RECLINER - INFINITE POSITION LOCKING BACK - UPH ARMS

COM	4	5	6	7	8	9	10	11
4919	5009	5079	5289	5529	5739	6039	6379	7889

EC2017 MOBILE HEALTHCARE WINGBACK CHAISE RECLINER - INFINITE POSITION NON-LOCKING BACK - UPH ARMS

COM	4	5	6	7	8	9	10	11
4909	5009	5149	5379	5719	5979	6349	6769	8279

EC2117 MOBILE HEALTHCARE WINGBACK CHAISE RECLINER - INFINITE POSITION LOCKING BACK - UPH ARMS

COM	4	5	6	7	8	9	10	11
5169	5289	5419	5679	5999	6269	6669	7119	8599

Options	List Price	Options	List Price
F Upholstered Arms	Standard	MR/L Right/Left Side (facing) Monitor Arm	\$629
U Urethane Arm Caps*	\$169	MTR/L Right/Left Side (facing) Monitor Arm with Tray	\$629
W Wood Arm Caps*	\$229	4S4 All 4" Swivel Locking Caster	\$39
J Solid Surface Arm Caps* - Group 1	\$619 (Group 2 add \$200)	AHP Adjustable Head Rest Pillow (Requires 1 yd of fabric)	\$339
Z Multi Cover	Use Highest Grade	ABP Adjustable Back Pad (COM-Grade 6) 1.75yd COM	\$459
H Heat (Certified to UL 60601-1)	\$849	Adjustable Back Pad (Grade 7-11)	\$569
HM Heat & Massage (Certified to UL 60601-1)	\$1119	DP Dual IV Poles	\$498
HW Heat Wand (Certified to UL 60601-1)	\$1139	FBH Foley Bag Holder	\$89
HMW Heat & Massage Wand (Certified to UL 60601-1)	\$1369	FT Foot Tray	\$279
S4 4" 2-Caster Lock & Steer	\$569	IV IV Pole and Bracket	\$249
Q3 3" Dual Wheel Central Locking Caster (Non-Directional)	\$1019	LFSTR Lg Right Side (facing) Folding Side Tray	\$249
Q4 4" Central Caster Lock & Steer	\$1019	<i>*Contact Customer Service for Solid Surface Pricing</i>	
Q5 5" Central Caster Lock & Steer	\$1139	LFSTRCH Lg Right Side (facing) Folding Cup Holder Tray	\$319
EG Edge Guard	Standard	PLFSTR Padded Lg Right Side (facing) Folding Side Tray	\$379
CAL CAL TB133	See page 12	<i>(Requires 1 yd of fabric.)</i>	
MBB Moisture Barrier Back	\$59	USB Hospital Grade Power	\$459
MBS Moisture Barrier Seat	\$59	QR Additional Quick Release Accessory Bracket	\$69
LC LiquiCell	\$229	SFSTR Sm Right Side (facing) Folding Side Tray	\$249
<i>(Standard on Heat or Heat & Massage option)</i>		<i>*Contact Customer Service for Solid Surface Pricing</i>	
		TD3 Dual Side Tray (Dual TSL1/TSR1)**	\$798
		TE Trendelenburg	\$339
		TSL1 Left Side (facing) Tray**	\$399
		TSR1 Right Side (facing) Tray**	\$399
		WR Wrist Restraint (per pair)	\$229
		PR1 Paper Roll Holder (takes place of push bar)	\$229

*Please refer to page 14 for finishes.

*Please refer to pages 134/135 for Options descriptions & images and page 132 for recliner ordering guide.

**Over the lap tray function recommended in seating position.



EV | Mobile Healthcare Recliners - 24" Seat Width & 650 lb Weight Rating

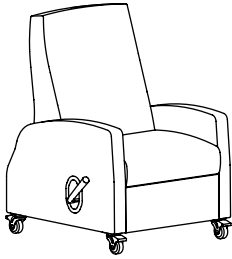

E1017 | E1117
33.5" Overall Width

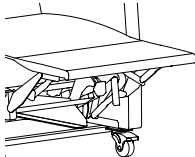

Chaise Model*
EC1017 | EC1117

DIMENSIONS | E1017 | E1117 | EC1017 | EC1117

Width	33.5	Seat Width	24	Back Height	26
Depth	38	Seat Depth	21	Arm Height	28
Height	47	Seat Height	21.5	Weight (1017)	158
COM (Standard)	6 YDS	COM (Chaise)	7 YDS	Weight (1117)	166
Reclined Depth	76	Seat Depth (kick-out)	40	Distance from Wall	20
Weight Capacity	650 lbs.				

E1017 MOBILE HEALTHCARE RECLINER - INFINITE POSITION NON-LOCKING BACK - UPH ARMS

COM	4	5	6	7	8	9	10	11
3779	3869	3989	4169	4399	4619	4899	5249	6809

E1117 MOBILE HEALTHCARE RECLINER - INFINITE POSITION LOCKING BACK - UPH ARMS

COM	4	5	6	7	8	9	10	11
4049	4149	4239	4429	4689	4909	5219	5549	7119

EC1017 MOBILE HEALTHCARE CHAISE RECLINER - INFINITE POSITION NON-LOCKING BACK - UPH ARMS

COM	4	5	6	7	8	9	10	11
4009	4129	4289	4559	4859	5149	5519	5979	7659

EC1117 MOBILE HEALTHCARE CHAISE RECLINER - INFINITE POSITION LOCKING BACK - UPH ARMS

COM	4	5	6	7	8	9	10	11
4289	4419	4569	4829	5149	5439	5839	6269	7969

Options	List Price	Options	List Price
F Upholstered Arms	Standard	AHP Adjustable Head Rest Pillow (Requires 1 yd of fabric)	\$339
U Urethane Arm Caps*	\$169	ABP Adjustable Back Pad (COM-Grade 6) 1.75yd COM	\$459
W Wood Arm Caps*	\$229	Adjustable Back Pad (Grade 7-11)	\$569
J Solid Surface Arm Caps* - Group 1	\$619 (Group 2 add \$200)	DP Dual IV Poles	\$498
Z Multi Cover	Use Highest Grade	IV IV Pole and Bracket	\$249
H Heat (Certified to UL 60601-1)	\$849	LFSTR Lg Right Side (facing) Folding Side Tray	\$249
HM Heat & Massage (Certified to UL 60601-1)	\$1119	*Contact Customer Service for Solid Surface Pricing	
HW Heat Wand (Certified to UL 60601-1)	\$1139	LFSTRCH Lg Right Side (facing) Folding Cup Holder Tray	\$319
HMW Heat & Massage Wand (Certified to UL 60601-1)	\$1369	PLFSTR Padded Lg Right Side (facing) Folding Side Tray	\$379
S4 4" 2-Caster Lock & Steer	\$569	(Requires 1 yd of fabric.)	
Q3 3" Dual Wheel Central Locking Caster (Non-Directional)	\$1019	USB Hospital Grade Power	\$459
Q4 4" Central Caster Lock & Steer	\$1019	QR Additional Quick Release Accessory Bracket	\$69
Q5 5" Central Caster Lock & Steer	\$1139	SFSTR Sm Right Side (facing) Folding Side Tray	\$249
EG Edge Guard	Standard	*Contact Customer Service for Solid Surface Pricing	
CAL CAL TB133	See page 12	TD3 Dual Side Tray (Dual TSL1/TSR1)**	\$798
MBB Moisture Barrier Back	\$59	TE Trendelenburg	\$339
MBS Moisture Barrier Seat	\$59	TSL1 Left Side (facing) Tray**	\$399
4S4 All 4" Swivel Locking Caster	\$39	TSR1 Right Side (facing) Tray**	\$399
MR/L Right/Left Side (facing) Monitor Arm	\$629	WR Wrist Restraint (per pair)	\$229
MTR/L Right/Left Side (facing) Monitor Arm with Tray	\$629	PR1 Paper Roll Holder (takes place of push bar)	\$229
FBH Foley Bag Holder	\$89	LC LiquiCell	\$229
FT Foot Tray	\$279	(Standard on Heat or Heat & Massage option)	

*Please refer to page 14 for finishes.

*Please refer to pages 134/135 for Options descriptions & images and page 132 for recliner ordering guide.

**Over the lap tray function recommended in seating position.



Rêma | Mobile Healthcare Recliners - 24" Seat Width & 650 lb Weight Rating

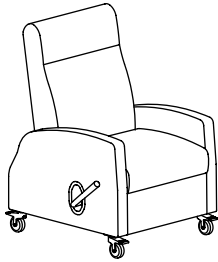

R1017 | R1117
33.5" Overall Width

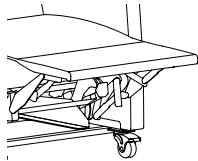

Chaise Model*
RC1017 | RC1117

DIMENSIONS | R1017 | R1117 | RC1017 | RC1117

Width	33.5	Seat Width	24	Back Height	26
Depth	38	Seat Depth	21	Arm Height	28
Height	47	Seat Height	21.5	Weight (1017)	158
COM (Standard)	6 YDS	COM (Chaise)	7 YDS	Weight (1117)	166
Reclined Depth	76	Seat Depth (kick-out)	40	Distance from Wall	20
Weight Capacity	650 lbs.				

R1017 MOBILE HEALTHCARE RECLINER - INFINITE POSITION NON-LOCKING BACK - UPH ARMS

COM	4	5	6	7	8	9	10	11
3779	3869	3989	4169	4399	4619	4899	5249	6809

R1117 MOBILE HEALTHCARE RECLINER - INFINITE POSITION LOCKING BACK - UPH ARMS

COM	4	5	6	7	8	9	10	11
4049	4149	4239	4429	4689	4909	5219	5549	7119

RC1017 MOBILE HEALTHCARE CHAISE RECLINER - INFINITE POSITION NON-LOCKING BACK - UPH ARMS

COM	4	5	6	7	8	9	10	11
4009	4129	4289	4559	4859	5149	5519	5979	7659

RC1117 MOBILE HEALTHCARE CHAISE RECLINER - INFINITE POSITION LOCKING BACK - UPH ARMS

COM	4	5	6	7	8	9	10	11
4289	4419	4569	4829	5149	5439	5839	6269	7969

Options	List Price	Options	List Price
F Upholstered Arms	Standard	MR/L Right/Left Side (facing) Monitor Arm	\$629
U Urethane Arm Caps*	\$169	MTR/L Right/Left Side (facing) Monitor Arm with Tray	\$629
W Wood Arm Caps*	\$229	4S4 All 4" Swivel Locking Caster	\$39
J Solid Surface Arm Caps* - Group 1	\$619 (Group 2 add \$200)	AHP Adjustable Head Rest Pillow	\$339
Z Multi Cover	Use Highest Grade	(Requires 1 yd of fabric)	
H Heat (Certified to UL 60601-1)	\$849	ABP Adjustable Back Pad (COM-Grade 6) 1.75yd COM	\$459
HM Heat & Massage (Certified to UL 60601-1)	\$1119	Adjustable Back Pad (Grade 7-11)	\$569
HW Heat Wand (Certified to UL 60601-1)	\$1139	DP Dual IV Poles	\$498
HMW Heat & Massage Wand (Certified to UL 60601-1)	\$1369	FBH Foley Bag Holder	\$89
S4 4" 2-Caster Lock & Steer	\$569	FT Foot Tray	\$279
Q3 3" Dual Wheel Central Locking Caster	\$1019	IV IV Pole and Bracket	\$249
(Non-Directional)		LFSTR Lg Right Side (facing) Folding Side Tray	\$249
Q4 4" Central Caster Lock & Steer	\$1019	*Contact Customer Service for Solid Surface Pricing	
Q5 5" Central Caster Lock & Steer	\$1139	LFSTRCH Lg Right Side (facing) Folding Cup Holder Tray	\$319
EG Edge Guard	Standard	PLFSTR Padded Lg Right Side (facing) Folding Side Tray	\$379
CAL CAL TB133	See page 12	(Requires 1 yd of fabric.)	
MBB Moisture Barrier Back	\$59	USB Hospital Grade Power	\$459
MBS Moisture Barrier Seat	\$59	QR Additional Quick Release Accessory Bracket	\$69
LC LiquiCell	\$229	SFSTR Sm Right Side (facing) Folding Side Tray	\$249
(Standard on Heat or Heat & Massage option)		*Contact Customer Service for Solid Surface Pricing	
		TD3 Dual Side Tray (Dual TSL1/TSR1)**	\$798
		TE Trendelenburg	\$339
		TSL1 Left Side (facing) Tray**	\$399
		TSR1 Right Side (facing) Tray**	\$399
		WR Wrist Restraint (per pair)	\$229
		PR1 Paper Roll Holder (takes place of push bar)	\$229

*Please refer to page 14 for finishes.

*Please refer to pages 134/135 for Options descriptions & images and page 132 for recliner ordering guide.

**Over the lap tray function recommended in seating position.



Koncert | Mobile Healthcare Recliners - 24" Seat Width & 650 lb Weight Rating

DURABLE® 650 SERIES

STANDARD HEALTHCARE RECLINER

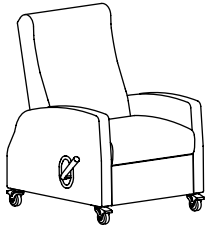

K1017 | K1117
33.5" Overall Width

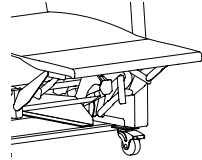

Chaise Model*
KC1017 | KC1117

DIMENSIONS | K1017 | K1117 | KC1017 | KC1117

Width	33.5	Seat Width	24	Back Height	26
Depth	38	Seat Depth	21	Arm Height	28
Height	47	Seat Height	21.5	Weight (1017)	158
COM (Standard)	6 YDS	COM (Chaise)	7 YDS	Weight (1117)	166
Reclined Depth	76	Seat Depth (kick-out)	40	Distance from Wall	20
Weight Capacity	650 lbs.				

K1017 MOBILE HEALTHCARE RECLINER - INFINITE POSITION NON-LOCKING BACK - UPH ARMS

COM	4	5	6	7	8	9	10	11
3779	3869	3989	4169	4399	4619	4899	5249	6809

K1117 MOBILE HEALTHCARE RECLINER - INFINITE POSITION LOCKING BACK - UPH ARMS

COM	4	5	6	7	8	9	10	11
4049	4149	4239	4429	4689	4909	5219	5549	7119

KC1017 MOBILE HEALTHCARE CHAISE RECLINER - INFINITE POSITION NON-LOCKING BACK - UPH ARMS

COM	4	5	6	7	8	9	10	11
4009	4129	4289	4559	4859	5149	5519	5979	7659

KC1117 MOBILE HEALTHCARE CHAISE RECLINER - INFINITE POSITION LOCKING BACK - UPH ARMS

COM	4	5	6	7	8	9	10	11
4289	4419	4569	4829	5149	5439	5839	6269	7969

Options	List Price	Options	List Price
F Upholstered Arms	Standard	AHP Adjustable Head Rest Pillow	\$339
U Urethane Arm Caps*	\$169	(Requires 1 yd of fabric)	
W Wood Arm Caps*	\$229	ABP Adjustable Back Pad (COM-Grade 6) 1.75yd COM	\$459
J Solid Surface Arm Caps* - Group 1	\$619 (Group 2 add \$200)	Adjustable Back Pad (Grade 7-11)	\$569
Z Multi Cover	Use Highest Grade	DP Dual IV Poles	\$498
H Heat (Certified to UL 60601-1)	\$849	IV IV Pole and Bracket	\$249
HM Heat & Massage (Certified to UL 60601-1)	\$1119	LFSTR Lg Right Side (facing) Folding Side Tray	\$249
HW Heat Wand (Certified to UL 60601-1)	\$1139	*Contact Customer Service for Solid Surface Pricing	
HMW Heat & Massage Wand (Certified to UL 60601-1)	\$1369	LFSTRCH Lg Right Side (facing) Folding Cup Holder Tray	\$319
S4 4" 2-Caster Lock & Steer	\$569	PLFSTR Padded Lg Right Side (facing) Folding Side Tray	\$379
Q3 3" Dual Wheel Central Locking Caster (Non-Directional)	\$1019	(Requires 1 yd of fabric.)	
Q4 4" Central Caster Lock & Steer	\$1019	USB Hospital Grade Power	\$459
Q5 5" Central Caster Lock & Steer	\$1139	QR Additional Quick Release Accessory Bracket	\$69
EG Edge Guard	Standard	SFSTR Sm Right Side (facing) Folding Side Tray	\$249
CAL CAL TB133	See page 12	*Contact Customer Service for Solid Surface Pricing	
MBB Moisture Barrier Back	\$59	TD3 Dual Side Tray (Dual TSL1/TSR1)**	\$798
MBS Moisture Barrier Seat	\$59	TE Trendelenburg	\$339
4S4 All 4" Swivel Locking Caster	\$39	TSL1 Left Side (facing) Tray**	\$399
MR/L Right/Left Side (facing) Monitor Arm	\$629	TSR1 Right Side (facing) Tray**	\$399
MTR/L Right/Left Side (facing) Monitor Arm with Tray	\$629	WR Wrist Restraint (per pair)	\$229
FBH Foley Bag Holder	\$89	PR1 Paper Roll Holder (takes place of push bar)	\$229
FT Foot Tray	\$279	LC LiquiCell	\$229
		(Standard on Heat or Heat & Massage option)	

*Please refer to page 14 for finishes.

*Please refer to pages 134/135 for Options descriptions & images and page 132 for recliner ordering guide.

**Over the lap tray function recommended in seating position.



Kadia Mod | Mobile Healthcare Recliners - 24" Seat Width & 650 lb Weight Rating



KM1017 | KM1117
33" Overall Width

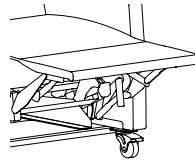

Chaise Model*
KMC1017 | KMC1117

DIMENSIONS | KM1017 | KM1117 | KMC1017 | KMC1117

Width	33	Seat Width	24	Back Height	27
Depth	39	Seat Depth	21	Arm Height	26.5
Height	46	Seat Height	21.5	Weight (1017)	158
COM (Standard)	6 YDS	COM (Chaise)	7 YDS	Weight (1117)	166
Reclined Depth	75	Seat Depth (kick-out)	40	Distance from Wall	17.5
Weight Capacity	650 lbs.				

KM1017 MOBILE HEALTHCARE RECLINER - INFINITE POSITION NON-LOCKING BACK - UPH ARMS

COM	4	5	6	7	8	9	10	11
3779	3869	3989	4169	4399	4619	4899	5249	6809

KM1117 MOBILE HEALTHCARE RECLINER - INFINITE POSITION LOCKING BACK - UPH ARMS

COM	4	5	6	7	8	9	10	11
4049	4149	4239	4429	4689	4909	5219	5549	7119

KMC1017 MOBILE HEALTHCARE CHAISE RECLINER - INFINITE POSITION NON-LOCKING BACK - UPH ARMS

COM	4	5	6	7	8	9	10	11
4009	4129	4289	4559	4859	5149	5519	5979	7659

KMC1117 MOBILE HEALTHCARE CHAISE RECLINER - INFINITE POSITION LOCKING BACK - UPH ARMS

COM	4	5	6	7	8	9	10	11
4289	4419	4569	4829	5149	5439	5839	6269	7969

Options

Options	List Price
F Upholstered Arms	Standard
U Urethane Arm Caps*	\$169
W Wood Arm Caps*	\$229
J Solid Surface Arm Caps* - Group 1	\$619 (Group 2 add \$200)
Z Multi Cover	Use Highest Grade
H Heat (Certified to UL 60601-1)	\$849
HM Heat & Massage (Certified to UL 60601-1)	\$1119
HW Heat Wand (Certified to UL 60601-1)	\$1139
HMW Heat & Massage Wand (Certified to UL 60601-1)	\$1369
S4 4" 2-Caster Lock & Steer	\$569
Q3 3" Dual Wheel Central Locking Caster (Non-Directional)	\$1019
Q4 4" Central Caster Lock & Steer	\$1019
Q5 5" Central Caster Lock & Steer	\$1139
EG Edge Guard	Standard
CAL CAL TB133	See page 12
MBB Moisture Barrier Back	\$59
MBS Moisture Barrier Seat	\$59
LC LiquiCell (Standard on Heat or Heat & Massage option)	\$229

Options

Options	List Price
MR/L Right/Left Side (facing) Monitor Arm	\$629
MTR/L Right/Left Side (facing) Monitor Arm with Tray	\$629
4S4 All 4" Swivel Locking Caster	\$39
AHP Adjustable Head Rest Pillow (Requires 1 yd of fabric)	\$339
ABP Adjustable Back Pad (COM-Grade 6) 1.75yd COM	\$459
Adjustable Back Pad (Grade 7-11)	\$569
DP Dual IV Poles	\$498
FBH Foley Bag Holder	\$89
FT Foot Tray	\$279
IV IV Pole and Bracket	\$249
LFSTR Lg Right Side (facing) Folding Side Tray	\$249
<i>*Contact Customer Service for Solid Surface Pricing</i>	
LFSTRCH Lg Right Side (facing) Folding Cup Holder Tray	\$319
PLFSTR Padded Lg Right Side (facing) Folding Side Tray	\$379
<i>(Requires 1 yd of fabric.)</i>	
USB Hospital Grade Power	\$459
QR Additional Quick Release Accessory Bracket	\$69
SFSTR Sm Right Side (facing) Folding Side Tray	\$249
<i>*Contact Customer Service for Solid Surface Pricing</i>	
TD3 Dual Side Tray (Dual TSL1/TSR1)**	\$798
TE Trendelenburg	\$339
TSL1 Left Side (facing) Tray**	\$399
TSR1 Right Side (facing) Tray**	\$399
WR Wrist Restraint (per pair)	\$229
PR1 Paper Roll Holder (takes place of push bar)	\$229

*Please refer to page 14 for finishes.

*Please refer to pages 134/135 for Options descriptions & images and page 132 for recliner ordering guide.

**Over the lap tray function recommended in seating position.



Kadia Luxe | Mobile Healthcare Recliners - 24" Seat Width & 650 lb Weight Rating

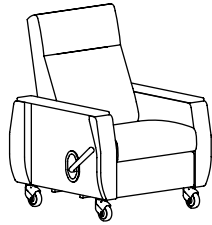

KL1017 | KL1117
34.5" Overall Width

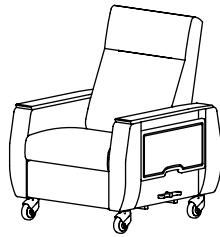

View of Right Side (facing)



View with Tray Up

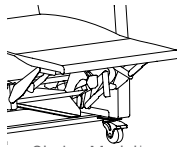

Chaise Model*
KLC1017 | KLC1117

DIMENSIONS | KL1017 | KL1117 | KLC1017 | KLC1117

Width	35	Seat Width	24	Back Height	27
Depth	39	Seat Depth	22	Arm Height	26.5
Height	47	Seat Height	21.5	Weight (1017)	200
COM (Standard)	6 YDS	COM (Chaise)	7 YDS	Weight (1117)	208
Reclined Depth	75	Seat Depth (kick-out)	40	Distance from Wall	17.5
Weight Capacity	650 lbs.				

KL1017 MOBILE HEALTHCARE RECLINER - INFINITE POSITION NON-LOCKING BACK

COM	4	5	6	7	8	9	10	11
5829	5899	5949	6019	6109	6269	6379	6609	6909

KL1117 MOBILE HEALTHCARE RECLINER - INFINITE POSITION LOCKING BACK

COM	4	5	6	7	8	9	10	11
6089	6189	6199	6279	6409	6559	6699	6919	7209

KLC1017 MOBILE HEALTHCARE CHAISE RECLINER - INFINITE POSITION NON-LOCKING BACK

COM	4	5	6	7	8	9	10	11
6059	6169	6239	6409	6559	6809	6989	7349	7759

KLC1117 MOBILE HEALTHCARE CHAISE RECLINER - INFINITE POSITION LOCKING BACK

COM	4	5	6	7	8	9	10	11
6329	6459	6509	6679	6869	7099	7329	7639	8069

*Model comes with tray built into arm, see page 14 for thermofoil finishes.

Options	List Price	Options	List Price
U Urethane Arm Caps*	Standard	MBB Moisture Barrier Back	\$59
Q4 4" Central Caster Lock & Steer	Standard	MBS Moisture Barrier Seat	\$59
EG Edge Guard	Standard	MR/L Right/Left Side (facing) Monitor Arm (only available on non-handle side)	\$629
ST Built in Side Tray	Standard	MTR/L Right/Left Side (facing) Monitor Arm with Tray (only available on non-handle side)	\$629
T Thermofoil Arm Caps*	\$229	AHP Adjustable Head Rest Pillow (Requires 1 yd of fabric)	\$339
J Solid Surface Arm Caps* - Group 1	\$1139 (Group 2 add \$200)	ABP Adjustable Back Pad (COM-Grade 6) 1.75yd COM	\$459
Z Multi Cover	Use Highest Grade	Adjustable Back Pad (Grade 7-11)	\$569
O3 3" Dual Wheel Central Locking Caster (Non-Directional)	No Charge	DP Dual IV Poles	\$498
O5 5" Central Caster Lock & Steer	\$109	IV IV Pole and Bracket	\$249
H Heat (Certified to UL 60601-1)	\$849	USB Hospital Grade Power	\$459
HM Heat & Massage (Certified to UL 60601-1)	\$1119	QR Additional Quick Release Accessory Bracket	\$69
HW Heat Wand (Certified to UL 60601-1)	\$1139	TE Trendelenburg	\$339
HMW Heat & Massage Wand (Certified to UL 60601-1)	\$1369	PR1 Paper Roll Holder (takes place of push bar)	\$229
FBH Foley Bag Holder	\$89	LC LiquiCell (Standard on Heat or Heat & Massage option)	\$229
FT Foot Tray	\$279		

*Please refer to page 14 for finishes.

Please refer to pages 134/135 for Options descriptions & images and page 132 for recliner ordering guide.

EV | Orthopedic Mobile Healthcare Recliners - Locking Footrest - 24" Seat - 650 lb Rating

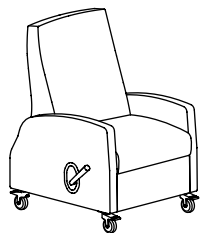

E4118
31.5" Overall Width

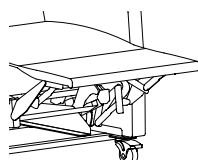

Chaise Model*
EC4118

DIMENSIONS | E4118 | EC4118

Width	31.5	Seat Width	24	Back Height	26
Depth	38	Seat Depth	21	Arm Height	28
Height	47	Seat Height	21.5	Weight	160
COM (Standard)	6 YDS	COM (Chaise)	7 YDS	Weight Capacity	650 lbs.
Reclined Depth	76	Seat Depth (kick-out)	40	Distance from Wall	20

E4118 ORTHOPEDIC MOBILE HEALTHCARE RECLINER INFINITE POSITION LOCKING BACK - UPH ARMS {LOCKING FOOTREST}

COM	4	5	6	7	8	9	10	11	
	4239	4339	4419	4629	4869	5109	5379	5489	6889

EC4118 ORTHOPEDIC MOBILE HEALTHCARE CHAISE RECLINER INFINITE POSITION LOCKING BACK - UPH ARMS {LOCKING FOOTREST}

COM	4	5	6	7	8	9	10	11	
	4479	4599	4749	5019	5339	5629	6019	6209	7889

Options	List Price	Options	List Price
F Upholstered Arms	Standard	AHP Adjustable Head Rest Pillow (Requires 1 yard of fabric)	\$339
U Urethane Arm Caps*	\$169	ABP Adjustable Back Pad (COM-Grade 6) 1.75yd COM	\$459
W Wood Arm Caps*	\$229	Adjustable Back Pad (Grade 7-11)	\$569
J Solid Surface Arm Caps* - Group 1	\$619 (Group 2 add \$200)	DP Dual IV Poles	\$498
Z Multi Cover	Use Highest Grade	FBH Foley Bag Holder	\$89
H Heat (Certified to UL 60601-1)	\$849	FT Foot Tray	\$279
HM Heat & Massage (Certified to UL 60601-1)	\$1119	IV IV Pole and Bracket	\$249
HW Heat Wand (Certified to UL 60601-1)	\$1139	LFSTR Lg Right Side (facing) Folding Side Tray	\$249
HMW Heat & Massage Wand (Certified to UL 60601-1)	\$1369	*Contact Customer Service for Solid Surface Pricing	
S4 4" 2-Caster Lock & Steer	\$569	LFSTRCH Lg Right Side (facing) Folding Cup Holder Tray	\$319
O3 3" Dual Wheel Central Locking Caster (Non-Directional)	\$1019	PLFSTR Padded Lg Right Side (facing) Folding Side Tray (Requires 1 yard of fabric)	\$379
O4 4" Central Caster Lock & Steer	\$1019	USB Hospital Grade Power	\$459
O5 5" Central Caster Lock & Steer	\$1139	QR Additional Quick Release Accessory Bracket	\$69
EG Edge Guard	Standard	SFSTR Sm Right Side (facing) Folding Side Tray	\$249
CAL CAL TB133	See page 12	*Contact Customer Service for Solid Surface Pricing	
MBB Moisture Barrier Back	\$59	TD3 Dual Side Tray (Dual TSL1/TSR1)**	\$798
MBS Moisture Barrier Seat	\$59	TSL1 Left Side (facing) Tray**	\$399
4S4 All 4" Swivel Locking Caster	\$39	TSR1 Right Side (facing) Tray**	\$399
LC LiquiCell (Standard on Heat or Heat & Massage option)	\$229	TE Trendelenburg	\$339
		WR Wrist Restraint (per pair)	\$229
		MR/L Right/Left Side (facing) Monitor Arm	\$629
		MTR/L Right/Left Side (facing) Monitor Arm with Tray	\$629
		PR1 Paper Roll Holder (takes place of push bar)	\$229

*Please refer to page 14 for finishes.

**Over the lap tray function recommended in seating position.

Please refer to pages 134/135 for Option descriptions & images.

Please refer to page 132 for the recliner ordering guide.



EV | Orthopedic Mobile Healthcare Wingback Recliners - Locking Footrest - 24" Seat - 650 lb Rating

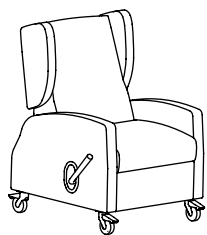

E2118
33.5" Overall Width

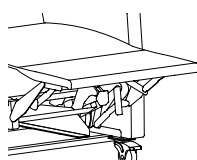

Chaise Model*
EC2118

DIMENSIONS | E2118 | EC2118

Width	33.5	Seat Width	24	Back Height	26
Depth	38	Seat Depth	21	Arm Height	28
Height	47	Seat Height	21.5	Weight	176
COM (Standard)	6 YDS	COM (Chaise)	7 YDS	Weight Capacity	650 lbs.
Reclined Depth	76	Seat Depth (kick-out)	40	Distance from Wall	20

E2118 ORTHOPEDIC MOBILE HEALTHCARE WINGBACK RECLINER - INFINITE POSITION LOCKING BACK - UPH ARMS {LOCKING FOOTREST}

COM	4	5	6	7	8	9	10	11
5169	5219	5319	5509	5769	5969	6259	6589	8099

EC2118 ORTHOPEDIC MOBILE HEALTHCARE CHAISE WINGBACK RECLINER INFINITE POSITION LOCKING BACK - UPH ARMS {LOCKING FOOTREST}

COM	4	5	6	7	8	9	10	11
5419	5519	5649	5909	6229	6499	6889	7339	8969

Options	List Price	Options	List Price
F Upholstered Arms	Standard	AHP Adjustable Head Rest Pillow (Requires 1 yd of fabric)	\$339
U Urethane Arm Caps*	\$169	ABP Adjustable Back Pad (COM-Grade 6) 1.75yd COM	\$459
W Wood Arm Caps*	\$229	Adjustable Back Pad (Grade 7-11)	\$569
J Solid Surface Arm Caps* - Group 1	\$619 (Group 2 add \$200)	DP Dual IV Poles	\$498
Z Multi Cover	Use Highest Grade	IV IV Pole and Bracket	\$249
H Heat (Certified to UL 60601-1)	\$849	LFSTR Lg Right Side (facing) Folding Side Tray	\$249
HM Heat & Massage (Certified to UL 60601-1)	\$1119	*Contact Customer Service for Solid Surface Pricing	
HW Heat Wand (Certified to UL 60601-1)	\$1139	LFSTRCH Lg Right Side (facing) Folding Cup Holder Tray	\$319
HMW Heat & Massage Wand (Certified to UL 60601-1)	\$1369	PLFSTR Padded Lg Right Side (facing) Folding Side Tray	\$379
S4 4" 2-Caster Lock & Steer	\$569	(Requires 1 yd of fabric.)	
Q3 3" Dual Wheel Central Locking Caster (Non-Directional)	\$1019	USB Hospital Grade Power	\$459
Q4 4" Central Caster Lock & Steer	\$1019	QR Additional Quick Release Accessory Bracket	\$69
Q5 5" Central Caster Lock & Steer	\$1139	SFSTR Sm Right Side (facing) Folding Side Tray	\$249
EG Edge Guard	Standard	*Contact Customer Service for Solid Surface Pricing	
CAL CAL TB133	See page 12	TD3 Dual Side Tray (Dual TSL1/TSR1)**	\$798
MBB Moisture Barrier Back	\$59	TE Trendelenburg	\$339
MBS Moisture Barrier Seat	\$59	TSL1 Left Side (facing) Tray**	\$399
4S4 All 4" Swivel Locking Caster	\$39	TSR1 Right Side (facing) Tray**	\$399
MR/L Right/Left Side (facing) Monitor Arm	\$629	WR Wrist Restraint (per pair)	\$229
MTR/L Right/Left Side (facing) Monitor Arm with Tray	\$629	PR1 Paper Roll Holder (takes place of push bar)	\$229
FBH Foley Bag Holder	\$89	LC LiquiCell	\$229
FT Foot Tray	\$279	(Standard on Heat or Heat & Massage option)	

*Please refer to page 14 for finishes.

*Please refer to pages 134/135 for Options descriptions & images and page 132 for recliner ordering guide.

**Over the lap tray function recommended in seating position.



EV | Orthopedic Mobile Healthcare Recliners - Locking Footrest - 24" Seat - 650 lb Rating

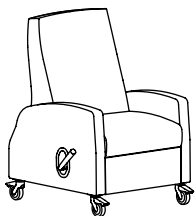

E1118
33.5" Overall Width

DIMENSIONS | E1118 | EC1118

Width	33.5	Seat Width	24	Back Height	26
Depth	38	Seat Depth	21	Arm Height	28
Height	47	Seat Height	21.5	Weight	166
COM (Standard)	6 YDS	COM (Chaise)	7 YDS	Weight Capacity	650 lbs.
Reclined Depth	76	Seat Depth (kick-out)	40	Distance from Wall	20

E1118 ORTHOPEDIC MOBILE HEALTHCARE RECLINER INFINITE POSITION LOCKING BACK - UPH ARMS {LOCKING FOOTREST}

COM	4	5	6	7	8	9	10	11
4309	4379	4459	4669	4909	5149	5429	5779	7169

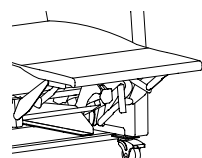

Chaise Model*
EC1118

EC1118 ORTHOPEDIC MOBILE HEALTHCARE CHAISE RECLINER INFINITE POSITION LOCKING BACK - UPH ARMS {LOCKING FOOTREST}

COM	4	5	6	7	8	9	10	11
4549	4659	4799	5059	5379	5679	6059	6509	8189

Options

F	Upholstered Arms	Standard
U	Urethane Arm Caps*	\$169
W	Wood Arm Caps*	\$229
J	Solid Surface Arm Caps* - Group 1	\$619 (Group 2 add \$200)
Z	Multi Cover	Use Highest Grade
H	Heat (Certified to UL 60601-1)	\$849
HM	Heat & Massage (Certified to UL 60601-1)	\$1119
HW	Heat Wand (Certified to UL 60601-1)	\$1139
HMW	Heat & Massage Wand (Certified to UL 60601-1)	\$1369
S4	4" 2-Caster Lock & Steer	\$569
Q3	3" Dual Wheel Central Locking Caster (Non-Directional)	\$1019
Q4	4" Central Caster Lock & Steer	\$1019
Q5	5" Central Caster Lock & Steer	\$1139
EG	Edge Guard	Standard
CAL	CAL TB133	See page 12
MBB	Moisture Barrier Back	\$59
MBS	Moisture Barrier Seat	\$59
LC	LiquiCell (Standard on Heat or Heat & Massage option)	\$229

Options

MR/L	Right/Left Side (facing) Monitor Arm	\$629
MTR/L	Right/Left Side (facing) Monitor Arm with Tray	\$629
4S4	All 4" Swivel Locking Caster	\$39
AHP	Adjustable Head Rest Pillow (Requires 1 yd of fabric)	\$339
ABP	Adjustable Back Pad (COM-Grade 6) 1.75yd COM	\$459
	Adjustable Back Pad (Grade 7-11)	\$569
DP	Dual IV Poles	\$498
FBH	Foley Bag Holder	\$89
FT	Foot Tray	\$279
IV	IV Pole and Bracket	\$249
LFSTR	Lg Right Side (facing) Folding Side Tray *Contact Customer Service for Solid Surface Pricing	\$249
LFSTRCH	Lg Right Side (facing) Folding Cup Holder Tray	\$319
PLFSTR	Padded Lg Right Side (facing) Folding Side Tray (Requires 1 yd of fabric.)	\$379
USB	Hospital Grade Power	\$459
QR	Additional Quick Release Accessory Bracket	\$69
SFSTR	Sm Right Side (facing) Folding Side Tray *Contact Customer Service for Solid Surface Pricing	\$249
TD3	Dual Side Tray (Dual TSL1/TSR1)**	\$798
TE	Trendelenburg	\$339
TSL1	Left Side (facing) Tray**	\$399
TSR1	Right Side (facing) Tray**	\$399
WR	Wrist Restraint (per pair)	\$229
PR1	Paper Roll Holder (takes place of push bar)	\$229

*Please refer to page 14 for finishes.

*Please refer to pages 134/135 for Options descriptions & images and page 132 for recliner ordering guide.

**Over the lap tray function recommended in seating position.



Rêma | Orthopedic Mobile Healthcare Recliners - Locking Footrest - 24" Seat - 650 lb Rating



R1118
33.5" Overall Width

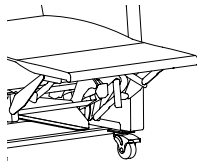

Chaise Model*
RC1118

DIMENSIONS | R1118 | RC1118

Width	33.5	Seat Width	24	Back Height	26
Depth	38	Seat Depth	21	Arm Height	28
Height	47	Seat Height	21.5	Weight	166
COM (Standard)	6 YDS	COM (Chaise)	7 YDS	Weight Capacity	650 lbs.
Reclined Depth	76	Seat Depth (kick-out)	40	Distance from Wall	20

R1118 ORTHOPEDIC MOBILE HEALTHCARE RECLINER INFINITE POSITION LOCKING BACK - UPH ARMS {LOCKING FOOTREST}

COM	4	5	6	7	8	9	10	11
4309	4379	4459	4669	4909	5149	5429	5779	7169

RC1118 ORTHOPEDIC MOBILE HEALTHCARE CHAISE RECLINER INFINITE POSITION LOCKING BACK - UPH ARMS {LOCKING FOOTREST}

COM	4	5	6	7	8	9	10	11
4549	4659	4799	5059	5379	5679	6059	6509	8189

Options	List Price	Options	List Price
F Upholstered Arms	Standard	AHP Adjustable Head Rest Pillow (Requires 1 yd of fabric)	\$339
U Urethane Arm Caps*	\$169	ABP Adjustable Back Pad (COM-Grade 6) 1.75yd COM	\$459
W Wood Arm Caps*	\$229	Adjustable Back Pad (Grade 7-11)	\$569
J Solid Surface Arm Caps* - Group 1	\$619 (Group 2 add \$200)	DP Dual IV Poles	\$498
Z Multi Cover	Use Highest Grade	IV IV Pole and Bracket	\$249
H Heat (Certified to UL 60601-1)	\$849	LFSTR Lg Right Side (facing) Folding Side Tray	\$249
HM Heat & Massage (Certified to UL 60601-1)	\$1119	*Contact Customer Service for Solid Surface Pricing	
HW Heat Wand (Certified to UL 60601-1)	\$1139	LFSTRCH Lg Right Side (facing) Folding Cup Holder Tray	\$319
HMW Heat & Massage Wand (Certified to UL 60601-1)	\$1369	PLFSTR Padded Lg Right Side (facing) Folding Side Tray	\$379
S4 4" 2-Caster Lock & Steer	\$569	(Requires 1 yd of fabric.)	
Q3 3" Dual Wheel Central Locking Caster (Non-Directional)	\$1019	USB Hospital Grade Power	\$459
Q4 4" Central Caster Lock & Steer	\$1019	QR Additional Quick Release Accessory Bracket	\$69
Q5 5" Central Caster Lock & Steer	\$1139	SFSTR Sm Right Side (facing) Folding Side Tray	\$249
EG Edge Guard	Standard	*Contact Customer Service for Solid Surface Pricing	
CAL CAL TB133	See page 12	TD3 Dual Side Tray (Dual TSL1/TSR1)**	\$798
MBB Moisture Barrier Back	\$59	TE Trendelenburg	\$339
MBS Moisture Barrier Seat	\$59	TSL1 Left Side (facing) Tray**	\$399
4S4 All 4" Swivel Locking Caster	\$39	TSR1 Right Side (facing) Tray**	\$399
MR/L Right/Left Side (facing) Monitor Arm	\$629	WR Wrist Restraint (per pair)	\$229
MTR/L Right/Left Side (facing) Monitor Arm with Tray	\$629	PR1 Paper Roll Holder (takes place of push bar)	\$229
FBH Foley Bag Holder	\$89	LC LiquiCell	\$229
FT Foot Tray	\$279	(Standard on Heat or Heat & Massage option)	

*Please refer to page 14 for finishes.

*Please refer to pages 134/135 for Options descriptions & images and page 132 for recliner ordering guide.

**Over the lap tray function recommended in seating position.



Koncert | Orthopedic Mobile Healthcare Recliners - Locking Footrest - 24" Seat - 650 lb Rating

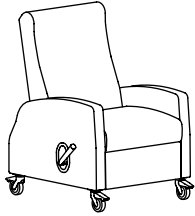

K1118
33.5" Overall Width

DIMENSIONS | K1118 | KC1118

Width	33.5	Seat Width	24	Back Height	26
Depth	38	Seat Depth	21	Arm Height	28
Height	47	Seat Height	21.5	Weight	166
COM (Standard)	6 YDS	COM (Chaise)	7 YDS	Weight Capacity	650 lbs.
Reclined Depth	76	Seat Depth (kick-out)	40	Distance from Wall	20

K1118 ORTHOPEDIC MOBILE HEALTHCARE RECLINER INFINITE POSITION LOCKING BACK - UPH ARMS {LOCKING FOOTREST}

COM	4	5	6	7	8	9	10	11
4309	4379	4459	4669	4909	5149	5429	5779	7169

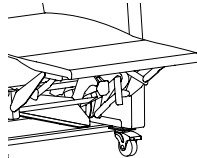

Chaise Model*
KC1118

KC1118 ORTHOPEDIC MOBILE HEALTHCARE CHAISE RECLINER INFINITE POSITION LOCKING BACK - UPH ARMS {LOCKING FOOTREST}

COM	4	5	6	7	8	9	10	11
4549	4659	4799	5059	5379	5679	6059	6509	8189

DURABLE® 650 SERIES

ORTHOPEDIC HEALTHCARE RECLINER

Options	List Price	Options	List Price
F Upholstered Arms	Standard	MR/L Right/Left Side (facing) Monitor Arm	\$629
U Urethane Arm Caps*	\$169	MTR/L Right/Left Side (facing) Monitor Arm with Tray	\$629
W Wood Arm Caps*	\$229	4S4 All 4" Swivel Locking Caster	\$39
J Solid Surface Arm Caps* - Group 1	\$619 (Group 2 add \$200)	AHP Adjustable Head Rest Pillow (Requires 1 yd of fabric)	\$339
Z Multi Cover	Use Highest Grade	ABP Adjustable Back Pad (COM-Grade 6) 1.75yd COM	\$459
H Heat (Certified to UL 60601-1)	\$849	Adjustable Back Pad (Grade 7-11)	\$569
HM Heat & Massage (Certified to UL 60601-1)	\$1119	DP Dual IV Poles	\$498
HW Heat Wand (Certified to UL 60601-1)	\$1139	FBH Foley Bag Holder	\$89
HMW Heat & Massage Wand (Certified to UL 60601-1)	\$1369	FT Foot Tray	\$279
S4 4" 2-Caster Lock & Steer	\$569	IV IV Pole and Bracket	\$249
Q3 3" Dual Wheel Central Locking Caster (Non-Directional)	\$1019	LFSTR Lg Right Side (facing) Folding Side Tray	\$249
Q4 4" Central Caster Lock & Steer	\$1019	<i>*Contact Customer Service for Solid Surface Pricing</i>	
Q5 5" Central Caster Lock & Steer	\$1139	LFSTRCH Lg Right Side (facing) Folding Cup Holder Tray	\$319
EG Edge Guard	Standard	PLFSTR Padded Lg Right Side (facing) Folding Side Tray	\$379
CAL CAL TB133	See page 12	<i>(Requires 1 yd of fabric.)</i>	
MBB Moisture Barrier Back	\$59	USB Hospital Grade Power	\$459
MBS Moisture Barrier Seat	\$59	QR Additional Quick Release Accessory Bracket	\$69
LC LiquiCell	\$229	SFSTR Sm Right Side (facing) Folding Side Tray	\$249
<i>(Standard on Heat or Heat & Massage option)</i>		<i>*Contact Customer Service for Solid Surface Pricing</i>	
*Please refer to page 14 for finishes.		TD3 Dual Side Tray (Dual TSL1/TSR1)**	\$798
*Please refer to pages 134/135 for Options descriptions & images and page 132 for recliner ordering guide.		TE Trendelenburg	\$339
Over the lap tray function recommended in seating position.		TSL1 Left Side (facing) Tray	\$399
		TSR1 Right Side (facing) Tray**	\$399
		WR Wrist Restraint (per pair)	\$229
		PR1 Paper Roll Holder <i>(takes place of push bar)</i>	\$229



Kadia Mod | Orthopedic Mobile Healthcare Recliners - Locking Footrest - 24" Seat - 650 lb Rating



KM1118
33" Overall Width

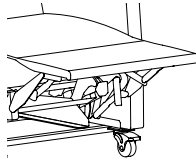

Chaise Model*
KMC1118

DIMENSIONS | KM1118 | KMC1118

Width	33	Seat Width	24	Back Height	27
Depth	39	Seat Depth	21	Arm Height	26.5
Height	47	Seat Height	21.5	Weight	166
COM (Standard)	6 YDS	COM (Chaise)	7 YDS	Weight Capacity	650 lbs.
Reclined Depth	76	Seat Depth (kick-out)	40	Distance from Wall	20

KM1118 ORTHOPEDIC MOBILE HEALTHCARE RECLINER INFINITE POSITION LOCKING BACK - UPH ARMS {LOCKING FOOTREST}

COM	4	5	6	7	8	9	10	11	
	4309	4379	4459	4669	4909	5149	5429	5779	7169

KMC1118 ORTHOPEDIC MOBILE HEALTHCARE CHAISE RECLINER INFINITE POSITION LOCKING BACK - UPH ARMS {LOCKING FOOTREST}

COM	4	5	6	7	8	9	10	11	
	4549	4659	4799	5059	5379	5679	6059	6509	8189

Options	List Price	Options	List Price
F Upholstered Arms	Standard	AHP Adjustable Head Rest Pillow (Requires 1 yd of fabric)	\$339
U Urethane Arm Caps*	\$169	ABP Adjustable Back Pad (COM-Grade 6) 1.75yd COM	\$459
W Wood Arm Caps*	\$229	Adjustable Back Pad (Grade 7-11)	\$569
J Solid Surface Arm Caps* - Group 1	\$619 (Group 2 add \$200)	DP Dual IV Poles	\$498
Z Multi Cover	Use Highest Grade	IV IV Pole and Bracket	\$249
H Heat (Certified to UL 60601-1)	\$849	LFSTR Lg Right Side (facing) Folding Side Tray	\$249
HM Heat & Massage (Certified to UL 60601-1)	\$1119	*Contact Customer Service for Solid Surface Pricing	
HW Heat Wand (Certified to UL 60601-1)	\$1139	LFSTRCH Lg Right Side (facing) Folding Cup Holder Tray	\$319
HMW Heat & Massage Wand (Certified to UL 60601-1)	\$1369	PLFSTR Padded Lg Right Side (facing) Folding Side Tray	\$379
S4 4" 2-Caster Lock & Steer	\$569	(Requires 1 yd of fabric.)	
O3 3" Dual Wheel Central Locking Caster (Non-Directional)	\$1019	USB Hospital Grade Power	\$459
O4 4" Central Caster Lock & Steer	\$1019	QR Additional Quick Release Accessory Bracket	\$69
O5 5" Central Caster Lock & Steer	\$1139	SFSTR Sm Right Side (facing) Folding Side Tray	\$249
EG Edge Guard	Standard	*Contact Customer Service for Solid Surface Pricing	
CAL CAL TB133	See page 12	TD3 Dual Side Tray (Dual TSL1/TSR1)**	\$798
MBB Moisture Barrier Back	\$59	TE Trendelenburg	\$339
MBS Moisture Barrier Seat	\$59	TSL1 Left Side (facing) Tray**	\$399
4S4 All 4" Swivel Locking Caster	\$39	TSR1 Right Side (facing) Tray**	\$399
MR/L Right/Left Side (facing) Monitor Arm	\$629	WR Wrist Restraint (per pair)	\$229
MTR/L Right/Left Side (facing) Monitor Arm with Tray	\$629	PR1 Paper Roll Holder (takes place of push bar)	\$229
FBH Foley Bag Holder	\$89	LC LiquiCell	\$229
FT Foot Tray	\$279	(Standard on Heat or Heat & Massage option)	

*Please refer to page 14 for finishes.

*Please refer to pages 134/135 for Options descriptions & images and page 132 for recliner ordering guide.

**Over the lap tray function recommended in seating position.



Harmony | Orthopedic Mobile Healthcare Recliners - Locking Footrest - 24" Seat - 650 lb Rating

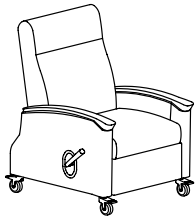

H5118
34" Overall Width

DIMENSIONS | H5118 | HC5118

Width	34	Seat Width	24	Back Height	26
Depth	38	Seat Depth	21	Arm Height	28
Height	47	Seat Height	21.5	Weight	168
COM	6 YDS	Seat Depth (kick-out)	40	Weight Capacity	650 lbs.
Reclined Depth	76	Distance from Wall	20		

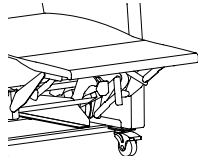

Chaise Model*
HC5118

H5118 ORTHOPEDIC MOBILE HEALTHCARE RECLINER INFINITE POSITION LOCKING BACK - URETHANE ARM CAPS {LOCKING FOOTREST}

COM	4	5	6	7	8	9	10	11
4669	4739	4839	5029	5259	5469	5759	6069	7639

HC5118 ORTHOPEDIC MOBILE HEALTHCARE CHAISE RECLINER INFINITE POSITION LOCKING BACK - URETHANE ARM CAPS {LOCKING FOOTREST}

COM	4	5	6	7	8	9	10	11
4899	5009	5129	5399	5719	5999	6369	6809	8499

DURABLE® 650 SERIES

ORTHOPEDIC HEALTHCARE RECLINER

Options	List Price	Options	List Price
U Urethane Arm Caps*	Standard	DP Dual IV Poles	\$498
W Wood Arm Caps*	\$229	FBH Foley Bag Holder	\$89
Z Multi Cover	Use Highest Grade	FT Foot Tray	\$279
H Heat (Certified to UL 60601-1)	\$849	IV IV Pole and Bracket	\$249
HM Heat & Massage (Certified to UL 60601-1)	\$1119	LFSTR Lg Right Side (facing) Folding Side Tray	\$249
HW Heat Wand (Certified to UL 60601-1)	\$1139	<i>*Contact Customer Service for Solid Surface Pricing</i>	
HMW Heat & Massage Wand	\$1369	LFSTRCH Lg Right Side (facing) Folding Cup Holder Tray	\$319
S4 4" 2-Caster Lock & Steer	\$569	PLFSTR Padded Lg Right Side (facing) Folding Side Tray	\$379
EG Edge Guard	Standard	(Requires 1 yard of fabric)	
CAL CAL TB133	See page 12	QR Additional Quick Release Accessory Bracket	\$69
MBB Moisture Barrier Back	\$59	SFSTR Sm Right Side (facing) Folding Side Tray	\$249
MBS Moisture Barrier Seat	\$59	<i>*Contact Customer Service for Solid Surface Pricing</i>	
4S4 All 4" Swivel Locking Caster	\$39	TD3 Dual Side Tray (Dual TSL1/TSR1)**	\$798
AHP Adjustable Head Rest Pillow	\$339	TSL1 Left Side (facing) Tray**	\$399
(Requires 1 yard of fabric)		TSR1 Right Side (facing) Tray**	\$399
USB Hospital Grade Power	\$459	TE Trendelenburg	\$339
LC LiquiCell	\$229	WR Wrist Restraint (per pair)	\$229
(Standard on Heat or Heat & Massage option)		MR/L Right/Left (facing) Side Monitor Arm	\$629
		MTR/L Right/Left Side (facing) Monitor Arm with Tray	\$629
		PR1 Paper Roll Holder (takes place of push bar)	\$229
		ABP Adjustable Back Pad (COM-Grade 6) 1.75yd COM	\$459
		Adjustable Back Pad (Grade 7-11)	\$569

*Please refer to page 14 for finishes.

**Over the lap tray function recommended in seating position.

Please refer to pages 134/135 for Option descriptions & images.

Please refer to page 132 for the recliner ordering guide.



EV | Compact Mobile Healthcare Recliners - Fold Down Arm - 22" Seat - 650 lb Rating

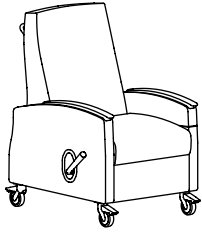

E3067 | E3167
30" Overall Width

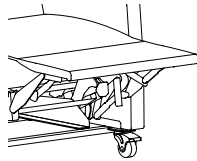

Chaise Model*
EC3067 | EC3167

DIMENSIONS | E3067 | E3167 | EC3067 | EC3167

Width	30	Seat Width	22	Back Height	25
Depth	35.5	Seat Depth	21	Arm Height	27
Height	47	Seat Height	21.5	Weight (3067)	147
COM (Standard)	7 YDS	COM (Chaise)	8 YDS	Weight (3167)	155
Reclined Depth	76	Seat Depth (kick-out)	39	Distance from Wall	19
Weight Capacity	650 lbs.				

E3067 MOBILE HEALTHCARE RECLINER - RIGHT (FACING) FOLD DOWN ARM INFINITE POSITION NON-LOCKING BACK

COM	4	5	6	7	8	9	10	11
4509	4569	4659	4839	5089	5279	5549	5879	7219

E3167 MOBILE HEALTHCARE RECLINER - RIGHT (FACING) FOLD DOWN ARM INFINITE POSITION LOCKING BACK

COM	4	5	6	7	8	9	10	11
4789	4849	4909	5119	5359	5569	5859	5959	7289

EC3067 MOBILE HEALTHCARE CHAISE RECLINER RIGHT (FACING) FOLD DOWN ARM INFINITE POSITION NON-LOCKING BACK

COM	4	5	6	7	8	9	10	11
4689	4809	4919	5159	5489	5739	6089	6529	8139

EC3167 MOBILE HEALTHCARE CHAISE RECLINER RIGHT (FACING) FOLD DOWN ARM INFINITE POSITION LOCKING BACK

COM	4	5	6	7	8	9	10	11
4969	5069	5199	5449	5769	6039	6419	6599	8209

*If patient transfer arm is specified on left side (facing), then handle will be placed on right side (facing) and vice versa.

Options	List Price	Options	List Price
U Urethane Arm Caps*	Standard	Q3 3" Dual Wheel Central Locking Caster (Non-Directional)	\$1019
W Wood Arm Caps*	\$229	Q4 4" Central Caster Lock & Steer	\$1019
J Solid Surface Arm Caps* - Group 1	\$619 (Group 2 add \$200)	Q5 5" Central Caster Lock & Steer	\$1139
Z Multi Cover	Use Highest Grade	CAL CAL TB133	See page 12
H Heat (Certified to UL 60601-1)	\$849	MBB Moisture Barrier Back	\$59
HM Heat & Massage (Certified to UL 60601-1)	\$1119	MBS Moisture Barrier Seat	\$59
HW Heat Wand (Certified to UL 60601-1)	\$1139	4S4 All 4" Swivel Locking Caster	\$39
HMW Heat & Massage Wand (Certified to UL 60601-1)	\$1369	AHP Adjustable Head Rest Pillow (Requires 1 yd of fabric)	\$339
S4 4" 2-Caster Lock & Steer	\$569	ABP Adjustable Back Pad (COM-Grade 6) 1.75yd COM	\$459
MR/L Right/Left Side (facing) Monitor Arm (non-fold down arm only)	\$629	Adjustable Back Pad (Grade 7-11)	\$569
MTR/L Right/Left Side (facing) Monitor Arm with Tray (non-fold down arm only)	\$629	FBH Foley Bag Holder	\$89
LC LiquiCell (Standard on Heat or Heat & Massage option)	\$229	FT Foot Tray	\$279
EG Edge Guard	Standard	IV IV Pole and Bracket	\$249
HC Hinge Cover	Standard	DP Dual IV Poles	\$498
		TE Trendelenburg	\$339
		USB Hospital Grade Power	\$459
		QR Additional Quick Release Accessory Bracket	\$69
		PR1 Paper Roll Holder (takes place of push bar)	\$229

*Please refer to page 14 for finishes.

Please refer to pages 134/135 for Option descriptions & images.

Please refer to page 132 for the recliner ordering guide.

Rêma | Compact Mobile Healthcare Recliners - Fold Down Arm - 22" Seat - 650 lb Rating

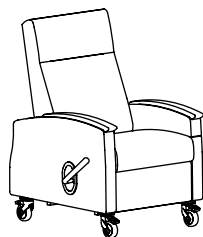

R3067 | R3167
31" Overall Width

DIMENSIONS | R3067 | R3167 | RC3067 | RC3167

Width	31	Seat Width	22	Back Height	26
Depth	35.5	Seat Depth	21	Arm Height	28
Height	47	Seat Height	21.5	Weight (3067)	158
COM (Standard)	7 YDS	COM (Chaise)	8 YDS	Weight (3167)	166
Reclined Depth	76	Seat Depth (kick-out)	40	Distance from Wall	20
Weight Capacity	650 lbs.				

R3067 MOBILE HEALTHCARE RECLINER - RIGHT (FACING) FOLD DOWN ARM INFINITE POSITION NON-LOCKING BACK

COM	4	5	6	7	8	9	10	11
4509	4569	4659	4839	5089	5279	5549	5879	7219

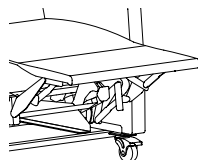

Chaise Model*
RC3067 | RC3167

R3167 MOBILE HEALTHCARE RECLINER - RIGHT (FACING) FOLD DOWN ARM INFINITE POSITION LOCKING BACK

COM	4	5	6	7	8	9	10	11
4789	4849	4909	5119	5359	5569	5859	5959	7289

RC3067 MOBILE HEALTHCARE CHAISE RECLINER RIGHT (FACING) FOLD DOWN ARM INFINITE POSITION NON-LOCKING BACK

COM	4	5	6	7	8	9	10	11
4689	4809	4919	5159	5489	5739	6089	6529	8139

RC3167 MOBILE HEALTHCARE CHAISE RECLINER RIGHT (FACING) FOLD DOWN ARM INFINITE POSITION LOCKING BACK

COM	4	5	6	7	8	9	10	11
4969	5069	5199	5449	5769	6039	6419	6599	8209

*If patient transfer arm is specified on left side (facing), then handle will be placed on right side (facing) and vice versa.

Options	List Price	Options	List Price
U Urethane Arm Caps*	Standard	MR/L Right/Left Side (facing) Monitor Arm (non-fold down arm only)	\$629
W Wood Arm Caps*	\$229	MTR/L Right/Left Side (facing) Monitor Arm with Tray (non-fold down arm only)	\$629
J Solid Surface Arm Caps* - Group 1	\$619 (Group 2 add \$200)	EG Edge Guard	Standard
Z Multi Cover	Use Highest Grade	HC Hinge Cover	Standard
H Heat (Certified to UL 60601-1)	\$849	CAL CAL TB133	See page 12
HM Heat & Massage (Certified to UL 60601-1)	\$1119	MBB Moisture Barrier Back	\$59
HW Heat Wand (Certified to UL 60601-1)	\$1139	MBS Moisture Barrier Seat	\$59
HMW Heat & Massage Wand (Certified to UL 60601-1)	\$1369	4S4 All 4" Swivel Locking Caster	\$39
S4 4" 2-Caster Lock & Steer	\$569	AHP Adjustable Head Rest Pillow (Requires 1 yd of fabric)	\$339
Q3 3" Dual Wheel Central Locking Caster (Non-Directional)	\$1019	ABP Adjustable Back Pad (COM-Grade 6) 1.75yd COM	\$459
Q4 4" Central Caster Lock & Steer	\$1019	Adjustable Back Pad (Grade 7-11)	\$569
Q5 5" Central Caster Lock & Steer	\$1139	FBH Foley Bag Holder	\$89
LC LiquiCell (Standard on Heat or Heat & Massage option)	\$229	FT Foot Tray	\$279
		IV IV Pole and Bracket	\$249
		DP Dual IV Poles	\$498
		TE Trendelenburg	\$339
		USB Hospital Grade Power	\$459
		QR Additional Quick Release Accessory Bracket	\$69
		PR1 Paper Roll Holder (takes place of push bar)	\$229

*Please refer to page 14 for finishes.

Please refer to pages 134/135 for Option descriptions & images.

Please refer to page 132 for the recliner ordering guide.



DURABLE® 650 SERIES

SINGLE FOLD DOWN ARM RECLINER

Koncert | Compact Mobile Healthcare Recliners - Fold Down Arm - 22" Seat - 650 lb Rating

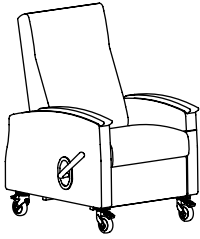

K3067 | K3167
31" Overall Width

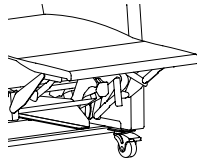

Chaise Model*
KC3067 | KC3167

DIMENSIONS | K3067 | K3167 | KC3067 | KC3167

Width	31	Seat Width	22	Back Height	26
Depth	35.5	Seat Depth	21	Arm Height	28
Height	47	Seat Height	21.5	Weight (3067)	158
COM (Standard)	7 YDS	COM (Chaise)	8 YDS	Weight (3167)	166
Reclined Depth	76	Seat Depth (kick-out)	39	Distance from Wall	19
Weight Capacity	650 lbs.				

K3067 MOBILE HEALTHCARE RECLINER - RIGHT (FACING) FOLD DOWN ARM INFINITE POSITION NON-LOCKING BACK

COM	4	5	6	7	8	9	10	11
4509	4569	4659	4839	5089	5279	5549	5879	7219

K3167 MOBILE HEALTHCARE RECLINER - RIGHT (FACING) FOLD DOWN ARM INFINITE POSITION LOCKING BACK

COM	4	5	6	7	8	9	10	11
4789	4849	4909	5119	5359	5569	5859	5959	7289

KC3067 MOBILE HEALTHCARE CHAISE RECLINER RIGHT (FACING) FOLD DOWN ARM INFINITE POSITION NON-LOCKING BACK

COM	4	5	6	7	8	9	10	11
4689	4809	4919	5159	5489	5739	6089	6529	8139

KC3167 MOBILE HEALTHCARE CHAISE RECLINER RIGHT (FACING) FOLD DOWN ARM INFINITE POSITION LOCKING BACK

COM	4	5	6	7	8	9	10	11
4969	5069	5199	5449	5769	6039	6419	6599	8209

*If patient transfer arm is specified on left side (facing), then handle will be placed on right side (facing) and vice versa.

Options	List Price	Options	List Price
U Urethane Arm Caps*	Standard	Q3 3" Dual Wheel Central Locking Caster (Non-Directional)	\$1019
W Wood Arm Caps*	\$229	Q4 4" Central Caster Lock & Steer	\$1019
J Solid Surface Arm Caps* - Group 1	\$619 (Group 2 add \$200)	Q5 5" Central Caster Lock & Steer	\$1139
Z Multi Cover	Use Highest Grade	CAL CAL TB133	See page 12
H Heat (Certified to UL 60601-1)	\$849	MBB Moisture Barrier Back	\$59
HM Heat & Massage (Certified to UL 60601-1)	\$1119	MBS Moisture Barrier Seat	\$59
HW Heat Wand (Certified to UL 60601-1)	\$1139	4S4 All 4" Swivel Locking Caster	\$39
HMW Heat & Massage Wand (Certified to UL 60601-1)	\$1369	AHP Adjustable Head Rest Pillow (Requires 1 yd of fabric)	\$339
S4 4" 2-Caster Lock & Steer	\$569	ABP Adjustable Back Pad (COM-Grade 6) 1.75yd COM	\$459
MR/L Right/Left Side (facing) Monitor Arm (non-fold down arm only)	\$629	Adjustable Back Pad (Grade 7-11)	\$569
MTR/L Right/Left Side (facing) Monitor Arm with Tray (non-fold down arm only)	\$629	FBH Foley Bag Holder	\$89
LC LiquiCell (Standard on Heat or Heat & Massage option)	\$229	FT Foot Tray	\$279
EG Edge Guard	Standard	IV IV Pole and Bracket	\$249
HC Hinge Cover	Standard	DP Dual IV Poles	\$498
		TE Trendelenburg	\$339
		USB Hospital Grade Power	\$459
		QR Additional Quick Release Accessory Bracket	\$69
		PR1 Paper Roll Holder (takes place of push bar)	\$229

*Please refer to page 14 for finishes.

Please refer to pages 134/135 for Option descriptions & images.

Please refer to page 132 for the recliner ordering guide.



Kadia Mod | Compact Mobile Healthcare Recliners - Fold Down Arm - 22" Seat - 650 lb Rating

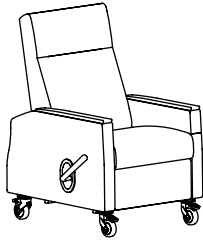

KM3067 | KM3167
31" Overall Width

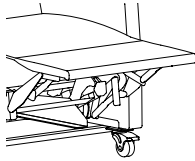

Chaise Model*
KMC3067 | KMC3167

DIMENSIONS | KM3067 | KM3167 | KMC3067 | KMC3167

Width	31	Seat Width	22	Back Height	26
Depth	35.5	Seat Depth	21	Arm Height	26.5
Height	47	Seat Height	21.5	Weight (3067)	158
COM (Standard)	7 YDS	COM (Chaise)	8 YDS	Weight (3167)	166
Reclined Depth	76	Seat Depth (kick-out)	40	Distance from Wall	20
Weight Capacity	650 lbs.				

KM3067 MOBILE HEALTHCARE RECLINER - RIGHT (FACING) FOLD DOWN ARM INFINITE POSITION NON-LOCKING BACK

COM	4	5	6	7	8	9	10	11
4509	4569	4659	4839	5089	5279	5549	5879	7219

KM3167 MOBILE HEALTHCARE RECLINER - RIGHT (FACING) FOLD DOWN ARM INFINITE POSITION LOCKING BACK

COM	4	5	6	7	8	9	10	11
4789	4849	4909	5119	5359	5569	5859	5959	7289

KMC3067 MOBILE HEALTHCARE CHAISE RECLINER RIGHT (FACING) FOLD DOWN ARM INFINITE POSITION NON-LOCKING BACK

COM	4	5	6	7	8	9	10	11
4689	4809	4919	5159	5489	5739	6089	6529	8139

KMC3167 MOBILE HEALTHCARE CHAISE RECLINER RIGHT (FACING) FOLD DOWN ARM INFINITE POSITION LOCKING BACK

COM	4	5	6	7	8	9	10	11
4969	5069	5199	5449	5769	6039	6419	6599	8209

If patient transfer arm is specified on left side (facing), then handle will be placed on right side (facing) and vice versa.

Options	List Price	Options	List Price
U Urethane Arm Caps*	Standard	MR/L Right/Left Side (facing) Monitor Arm (non-fold down arm only)	\$629
W Wood Arm Caps*	\$229	MTR/L Right/Left Side (facing) Monitor Arm with Tray (non-fold down arm only)	\$629
J Solid Surface Arm Caps* - Group 1	\$619 (Group 2 add \$200)	EG Edge Guard	Standard
Z Multi Cover	Use Highest Grade	HC Hinge Cover	Standard
H Heat (Certified to UL 60601-1)	\$849	CAL CAL TB133	See page 12
HM Heat & Massage (Certified to UL 60601-1)	\$1119	MBB Moisture Barrier Back	\$59
HW Heat Wand (Certified to UL 60601-1)	\$1139	MBS Moisture Barrier Seat	\$59
HMW Heat & Massage Wand (Certified to UL 60601-1)	\$1369	4S4 All 4" Swivel Locking Caster	\$39
S4 4" 2-Caster Lock & Steer	\$569	AHP Adjustable Head Rest Pillow (Requires 1 yd of fabric)	\$339
Q3 3" Dual Wheel Central Locking Caster (Non-Directional)	\$1019	ABP Adjustable Back Pad (COM-Grade 6) 1.75yd COM	\$459
Q4 4" Central Caster Lock & Steer	\$1019	Adjustable Back Pad (Grade 7-11)	\$569
Q5 5" Central Caster Lock & Steer	\$1139	FBH Foley Bag Holder	\$89
LC LiquiCell (Standard on Heat or Heat & Massage option)	\$229	FT Foot Tray	\$279
		IV IV Pole and Bracket	\$249
		DP Dual IV Poles	\$498
		TE Trendelenburg	\$339
		USB Hospital Grade Power	\$459
		QR Additional Quick Release Accessory Bracket	\$69
		PR1 Paper Roll Holder (takes place of push bar)	\$229

*Please refer to page 14 for finishes.

Please refer to pages 134/135 for Option descriptions & images.

Please refer to page 132 for the recliner ordering guide.



EV | Mobile Healthcare Recliners - Fold Down Arm - 24" Seat - 650 lb Rating

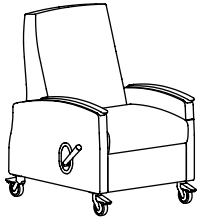

E4067 | E4167
32.5" Overall Width

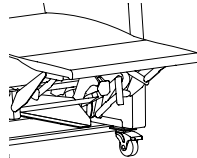

Chaise Model*
EC4067 | EC4167

DIMENSIONS | E4067 | E4167 | EC4067 | EC4167

Width	32.5	Seat Width	24	Back Height	25
Depth	35.5	Seat Depth	21	Arm Height	27
Height	47	Seat Height	21.5	Weight (4067)	147
COM (Standard)	7 YDS	COM (Chaise)	8 YDS	Weight (4167)	155
Reclined Depth	76	Seat Depth (kick-out)	39	Distance from Wall	20
Weight Capacity	650 lbs.				

E4067 MOBILE HEALTHCARE RECLINER - RIGHT (FACING) FOLD DOWN ARM INFINITE POSITION NON-LOCKING BACK

COM	4	5	6	7	8	9	10	11
4509	4569	4659	4839	5089	5279	5549	5879	7219

E4167 MOBILE HEALTHCARE RECLINER - RIGHT (FACING) FOLD DOWN ARM INFINITE POSITION LOCKING BACK

COM	4	5	6	7	8	9	10	11
4789	4849	4909	5119	5359	5569	5859	5959	7289

EC4067 MOBILE HEALTHCARE CHAISE RECLINER RIGHT (FACING) FOLD DOWN ARM INFINITE POSITION NON-LOCKING BACK

COM	4	5	6	7	8	9	10	11
4689	4809	4919	5159	5489	5739	6089	6529	8139

EC4167 MOBILE HEALTHCARE CHAISE RECLINER RIGHT (FACING) FOLD DOWN ARM INFINITE POSITION LOCKING BACK

COM	4	5	6	7	8	9	10	11
4969	5069	5199	5449	5769	6039	6419	6599	8209

If patient transfer arm is specified on left side (facing), then handle will be placed on right side (facing) and vice versa.

Options	List Price	Options	List Price
U Urethane Arm Caps*	Standard	Q3 3" Dual Wheel Central Locking Caster (Non-Directional)	\$1019
W Wood Arm Caps*	\$229	Q4 4" Central Caster Lock & Steer	\$1019
J Solid Surface Arm Caps* - Group 1	\$619 (Group 2 add \$200)	Q5 5" Central Caster Lock & Steer	\$1139
Z Multi Cover	Use Highest Grade	CAL CAL TB133	See page 12
H Heat (Certified to UL 60601-1)	\$849	MBB Moisture Barrier Back	\$59
HM Heat & Massage (Certified to UL 60601-1)	\$1119	MBS Moisture Barrier Seat	\$59
HW Heat Wand (Certified to UL 60601-1)	\$1139	4S4 All 4" Swivel Locking Caster	\$39
HMW Heat & Massage Wand (Certified to UL 60601-1)	\$1369	AHP Adjustable Head Rest Pillow (Requires 1 yd of fabric)	\$339
S4 4" 2-Caster Lock & Steer	\$569	ABP Adjustable Back Pad (COM-Grade 6) 1.75yd COM	\$459
MR/L Right/Left Side (facing) Monitor Arm (non-fold down arm only)	\$629	Adjustable Back Pad (Grade 7-11)	\$569
MTR/L Right/Left Side (facing) Monitor Arm with Tray (non-fold down arm only)	\$629	FBH Foley Bag Holder	\$89
LC LiquiCell (Standard on Heat or Heat & Massage option)	\$229	FT Foot Tray	\$279
EG Edge Guard	Standard	IV IV Pole and Bracket	\$249
HC Hinge Cover	Standard	DP Dual IV Poles	\$498
		TE Trendelenburg	\$339
		USB Hospital Grade Power	\$459
		QR Additional Quick Release Accessory Bracket	\$69
		PR1 Paper Roll Holder (takes place of push bar)	\$229

*Please refer to page 14 for finishes.

Please refer to pages 134/135 for Option descriptions & images.

Please refer to page 132 for the recliner ordering guide.



EV | Mobile Healthcare Recliners - Fold Down Arm - 24" Seat - 650 lb Rating

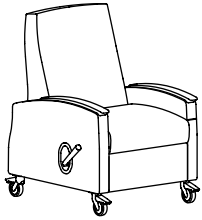

E1067 | E1167
33.5" Overall Width

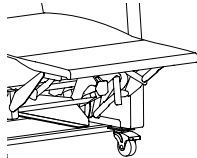

Chaise Model*
EC1067 | EC1167

DIMENSIONS | E1067 | E1167 | EC1067 | EC1167

Width	33.5	Seat Width	24	Back Height	26
Depth	38	Seat Depth	21	Arm Height	28
Height	47	Seat Height	21.5	Weight (1067)	158
COM (Standard)	7 YDS	COM (Chaise)	8 YDS	Weight (1167)	166
Reclined Depth	76	Seat Depth (kick-out)	40	Distance from Wall	20
Weight Capacity	650 lbs.				

E1067 MOBILE HEALTHCARE RECLINER - RIGHT (FACING) FOLD DOWN ARM INFINITE POSITION NON-LOCKING BACK

COM	4	5	6	7	8	9	10	11	
	4569	4609	4709	4879	5129	5319	5599	5929	7269

E1167 MOBILE HEALTHCARE RECLINER - RIGHT (FACING) FOLD DOWN ARM INFINITE POSITION LOCKING BACK

COM	4	5	6	7	8	9	10	11	
	4829	4889	4979	5159	5419	5619	5909	6239	7579

EC1067 MOBILE HEALTHCARE CHAISE RECLINER RIGHT (FACING) FOLD DOWN ARM INFINITE POSITION NON-LOCKING BACK

COM	4	5	6	7	8	9	10	11	
	4739	4849	4999	5219	5539	5789	6199	6579	8189

EC1167 MOBILE HEALTHCARE CHAISE RECLINER RIGHT (FACING) FOLD DOWN ARM INFINITE POSITION LOCKING BACK

COM	4	5	6	7	8	9	10	11	
	5029	5119	5249	5509	5809	6079	6459	6889	8499

If patient transfer arm is specified on left side (facing), then handle will be placed on right side (facing) and vice versa.

Options	List Price	Options	List Price
U Urethane Arm Caps*	Standard	MR/L Right/Left Side (facing) Monitor Arm (non-fold down arm only)	\$629
W Wood Arm Caps*	\$229	MTR/L Right/Left Side (facing) Monitor Arm with Tray (non-fold down arm only)	\$629
J Solid Surface Arm Caps* - Group 1	\$619 (Group 2 add \$200)	EG Edge Guard	Standard
Z Multi Cover	Use Highest Grade	HC Hinge Cover	Standard
H Heat (Certified to UL 60601-1)	\$849	CAL CAL TB133	See page 12
HM Heat & Massage (Certified to UL 60601-1)	\$1119	MBB Moisture Barrier Back	\$59
HW Heat Wand (Certified to UL 60601-1)	\$1139	MBS Moisture Barrier Seat	\$59
HMW Heat & Massage Wand (Certified to UL 60601-1)	\$1369	4S4 All 4" Swivel Locking Caster	\$39
S4 4" 2-Caster Lock & Steer	\$569	AHP Adjustable Head Rest Pillow (Requires 1 yd of fabric)	\$339
Q3 3" Dual Wheel Central Locking Caster (Non-Directional)	\$1019	ABP Adjustable Back Pad (COM-Grade 6) 1.75yd COM	\$459
Q4 4" Central Caster Lock & Steer	\$1019	Adjustable Back Pad (Grade 7-11)	\$569
Q5 5" Central Caster Lock & Steer	\$1139	FBH Foley Bag Holder	\$89
LC LiquiCell (Standard on Heat or Heat & Massage option)	\$229	FT Foot Tray	\$279
		IV IV Pole and Bracket	\$249
		DP Dual IV Poles	\$498
		TE Trendelenburg	\$339
		USB Hospital Grade Power	\$459
		QR Additional Quick Release Accessory Bracket	\$69
		PR1 Paper Roll Holder (takes place of push bar)	\$229

*Please refer to page 14 for finishes.

Please refer to pages 134/135 for Option descriptions & images.

Please refer to page 132 for the recliner ordering guide.



EV | Mobile Healthcare Wingback Recliners - Fold Down Arm - 24" Seat - 650 lb Rating

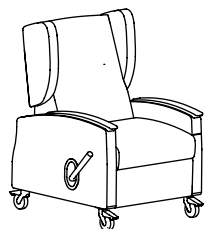

E2067 | E2167
33.5" Overall Width

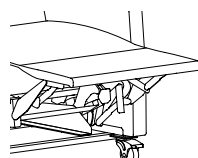

Chaise Model*
EC2067 | EC2167

DIMENSIONS | E2067 | E2167 | EC2067 | EC2167

Width	33.5	Seat Width	24	Back Height	26
Depth	38	Seat Depth	21	Arm Height	28
Height	47	Seat Height	21.5	Weight (2067)	188
COM (Standard)	7 YDS	COM (Chaise)	8 YDS	Weight (2167)	176
Reclined Depth	76	Seat Depth (kick-out)	39	Distance from Wall	20
Weight Capacity	650 lbs.				

E2067 MOBILE HEALTHCARE RECLINER - RIGHT (FACING) FOLD DOWN ARM INFINITE POSITION NON-LOCKING BACK

COM	4	5	6	7	8	9	10	11
5429	5449	5549	5739	5959	6119	6419	6699	8019

E2167 MOBILE HEALTHCARE RECLINER - RIGHT (FACING) FOLD DOWN ARM INFINITE POSITION LOCKING BACK

COM	4	5	6	7	8	9	10	11
5679	5739	5809	5979	6219	6429	6709	7039	8329

EC2067 MOBILE HEALTHCARE CHAISE RECLINER RIGHT (FACING) FOLD DOWN ARM INFINITE POSITION NON-LOCKING BACK

COM	4	5	6	7	8	9	10	11
5619	5679	5809	6049	6359	6599	6959	7359	8929

EC2167 MOBILE HEALTHCARE CHAISE RECLINER RIGHT (FACING) FOLD DOWN ARM INFINITE POSITION LOCKING BACK

COM	4	5	6	7	8	9	10	11
5879	5959	6069	6299	6629	6889	7249	7679	9249

If patient transfer arm is specified on left side (facing), then handle will be placed on right side (facing) and vice versa.

Options	List Price	Options	List Price
U Urethane Arm Caps*	Standard	Q3 3" Dual Wheel Central Locking Caster (Non-Directional)	\$1019
W Wood Arm Caps*	\$229	Q4 4" Central Caster Lock & Steer	\$1019
J Solid Surface Arm Caps* - Group 1	\$619 (Group 2 add \$200)	Q5 5" Central Caster Lock & Steer	\$1139
Z Multi Cover	Use Highest Grade	CAL CAL TB133	See page 12
H Heat (Certified to UL 60601-1)	\$849	MBB Moisture Barrier Back	\$59
HM Heat & Massage (Certified to UL 60601-1)	\$1119	MBS Moisture Barrier Seat	\$59
HW Heat Wand (Certified to UL 60601-1)	\$1139	4S4 All 4" Swivel Locking Caster	\$39
HMW Heat & Massage Wand (Certified to UL 60601-1)	\$1369	AHP Adjustable Head Rest Pillow (Requires 1 yd of fabric)	\$339
S4 4" 2-Caster Lock & Steer	\$569	ABP Adjustable Back Pad (COM-Grade 6) 1.75yd COM	\$459
MR/L Right/Left Side (facing) Monitor Arm (non-fold down arm only)	\$629	Adjustable Back Pad (Grade 7-11)	\$569
MTR/L Right/Left Side (facing) Monitor Arm with Tray (non-fold down arm only)	\$629	FBH Foley Bag Holder	\$89
LC LiquiCell (Standard on Heat or Heat & Massage option)	\$229	FT Foot Tray	\$279
EG Edge Guard	Standard	IV IV Pole and Bracket	\$249
HC Hinge Cover	Standard	DP Dual IV Poles	\$498
		TE Trendelenburg	\$339
		USB Hospital Grade Power	\$459
		QR Additional Quick Release Accessory Bracket	\$69
		PR1 Paper Roll Holder (takes place of push bar)	\$229

*Please refer to page 14 for finishes.

Please refer to pages 134/135 for Option descriptions & images.

Please refer to page 132 for the recliner ordering guide.



Rêma | Mobile Healthcare Recliners - Fold Down Arm - 24" Seat - 650 lb Rating



R1067 | R1167
33.5" Overall Width

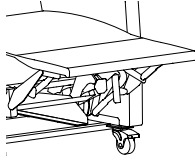

Chaise Model*
RC1067 | RC1167

DIMENSIONS | R1067 | R1167 | RC1067 | RC1167

Width	33.5	Seat Width	24	Back Height	26
Depth	38	Seat Depth	21	Arm Height	28
Height	47	Seat Height	21.5	Weight (1067)	158
COM (Standard)	7 YDS	COM (Chaise)	8 YDS	Weight (1167)	166
Reclined Depth	76	Seat Depth (kick-out)	40	Distance from Wall	20
Weight Capacity	650 lbs.				

R1067 MOBILE HEALTHCARE RECLINER - RIGHT (FACING) FOLD DOWN ARM INFINITE POSITION NON-LOCKING BACK

COM	4	5	6	7	8	9	10	11	
	4569	4609	4709	4879	5129	5319	5599	5929	7269

R1167 MOBILE HEALTHCARE RECLINER - RIGHT (FACING) FOLD DOWN ARM INFINITE POSITION LOCKING BACK

COM	4	5	6	7	8	9	10	11	
	4829	4889	4979	5159	5419	5619	5909	6239	7579

RC1067 MOBILE HEALTHCARE CHAISE RECLINER RIGHT (FACING) FOLD DOWN ARM INFINITE POSITION NON-LOCKING BACK

COM	4	5	6	7	8	9	10	11	
	4739	4849	4999	5219	5539	5789	6199	6579	8189

RC1167 MOBILE HEALTHCARE CHAISE RECLINER RIGHT (FACING) FOLD DOWN ARM INFINITE POSITION LOCKING BACK

COM	4	5	6	7	8	9	10	11	
	5029	5119	5249	5509	5809	6079	6459	6889	8499

If patient transfer arm is specified on left side (facing), then handle will be placed on right side (facing) and vice versa.

Options	List Price	Options	List Price
U Urethane Arm Caps*	Standard	MR/L Right/Left Side (facing) Monitor Arm (non-fold down arm only)	\$629
W Wood Arm Caps*	\$229	MTR/L Right/Left Side (facing) Monitor Arm with Tray (non-fold down arm only)	\$629
J Solid Surface Arm Caps* - Group 1	\$619 (Group 2 add \$200)	EG Edge Guard	Standard
Z Multi Cover	Use Highest Grade	HC Hinge Cover	Standard
H Heat (Certified to UL 60601-1)	\$849	CAL CAL TB133	See page 12
HM Heat & Massage (Certified to UL 60601-1)	\$1119	MBB Moisture Barrier Back	\$59
HW Heat Wand (Certified to UL 60601-1)	\$1139	MBS Moisture Barrier Seat	\$59
HMW Heat & Massage Wand (Certified to UL 60601-1)	\$1369	4S4 All 4" Swivel Locking Caster	\$39
S4 4" 2-Caster Lock & Steer	\$569	AHP Adjustable Head Rest Pillow (Requires 1 yd of fabric)	\$339
Q3 3" Dual Wheel Central Locking Caster (Non-Directional)	\$1019	ABP Adjustable Back Pad (COM-Grade 6) 1.75yd COM	\$459
Q4 4" Central Caster Lock & Steer	\$1019	Adjustable Back Pad (Grade 7-11)	\$569
Q5 5" Central Caster Lock & Steer	\$1139	FBH Foley Bag Holder	\$89
LC LiquiCell (Standard on Heat or Heat & Massage option)	\$229	FT Foot Tray	\$279
		IV IV Pole and Bracket	\$249
		DP Dual IV Poles	\$498
		TE Trendelenburg	\$339
		USB Hospital Grade Power	\$459
		QR Additional Quick Release Accessory Bracket	\$69
		PR1 Paper Roll Holder (takes place of push bar)	\$229

*Please refer to page 14 for finishes.

Please refer to pages 134/135 for Option descriptions & images.

Please refer to page 132 for the recliner ordering guide.



Koncert | Mobile Healthcare Recliners - Fold Down Arm - 24" Seat - 650 lb Rating

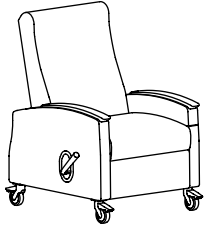

K1067 | K1167
33.5" Overall Width

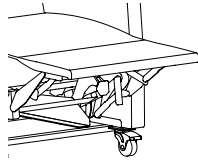

Chaise Model*
KC1067 | KC1167

DIMENSIONS | K1067 | K1167 | KC1067 | KC1167

Width	33.5	Seat Width	24	Back Height	26
Depth	38	Seat Depth	21	Arm Height	28
Height	47	Seat Height	21.5	Weight (1067)	158
COM (Standard)	7 YDS	COM (Chaise)	8 YDS	Weight (1167)	166
Reclined Depth	76	Seat Depth (kick-out)	40	Distance from Wall	20
Weight Capacity	650 lbs.				

K1067 MOBILE HEALTHCARE RECLINER - RIGHT (FACING) FOLD DOWN ARM INFINITE POSITION NON-LOCKING BACK

COM	4	5	6	7	8	9	10	11	
	4569	4609	4709	4879	5129	5319	5599	5929	7269

K1167 MOBILE HEALTHCARE RECLINER - RIGHT (FACING) FOLD DOWN ARM INFINITE POSITION LOCKING BACK

COM	4	5	6	7	8	9	10	11	
	4829	4889	4979	5159	5419	5619	5909	6239	7579

KC1067 MOBILE HEALTHCARE CHAISE RECLINER RIGHT (FACING) FOLD DOWN ARM INFINITE POSITION NON-LOCKING BACK

COM	4	5	6	7	8	9	10	11	
	4739	4849	4999	5219	5539	5789	6199	6579	8189

KC1167 MOBILE HEALTHCARE CHAISE RECLINER RIGHT (FACING) FOLD DOWN ARM INFINITE POSITION LOCKING BACK

COM	4	5	6	7	8	9	10	11	
	5029	5119	5249	5509	5809	6079	6459	6889	8499

If patient transfer arm is specified on left side (facing), then handle will be placed on right side (facing) and vice versa.

Options	List Price	Options	List Price
U Urethane Arm Caps*	Standard	Q3 3" Dual Wheel Central Locking Caster (Non-Directional)	\$1019
W Wood Arm Caps*	\$229	Q4 4" Central Caster Lock & Steer	\$1019
J Solid Surface Arm Caps* - Group 1	\$619 (Group 2 add \$200)	Q5 5" Central Caster Lock & Steer	\$1139
Z Multi Cover	Use Highest Grade	CAL CAL TB133	See page 12
H Heat (Certified to UL 60601-1)	\$849	MBB Moisture Barrier Back	\$59
HM Heat & Massage (Certified to UL 60601-1)	\$1119	MBS Moisture Barrier Seat	\$59
HW Heat Wand (Certified to UL 60601-1)	\$1139	4S4 All 4" Swivel Locking Caster	\$39
HMW Heat & Massage Wand (Certified to UL 60601-1)	\$1369	AHP Adjustable Head Rest Pillow (Requires 1 yd of fabric)	\$339
S4 4" 2-Caster Lock & Steer	\$569	ABP Adjustable Back Pad (COM-Grade 6) 1.75yd COM	\$459
MR/L Right/Left Side (facing) Monitor Arm (non-fold down arm only)	\$629	Adjustable Back Pad (Grade 7-11)	\$569
MTR/L Right/Left Side (facing) Monitor Arm with Tray (non-fold down arm only)	\$629	FBH Foley Bag Holder	\$89
LC LiquiCell (Standard on Heat or Heat & Massage option)	\$229	FT Foot Tray	\$279
EG Edge Guard	Standard	IV IV Pole and Bracket	\$249
HC Hinge Cover	Standard	DP Dual IV Poles	\$498
		TE Trendelenburg	\$339
		USB Hospital Grade Power	\$459
		QR Additional Quick Release Accessory Bracket	\$69
		PR1 Paper Roll Holder (takes place of push bar)	\$229

*Please refer to page 14 for finishes.

Please refer to pages 134/135 for Option descriptions & images.

Please refer to page 132 for the recliner ordering guide.



Kadia Mod | Mobile Healthcare Recliners - Fold Down Arm - 24" Seat - 650 lb Rating

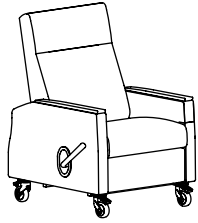

KM1067 | KM1167
33" Overall Width

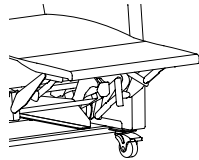

Chaise Model*
KMC1067 | KMC1167

DIMENSIONS | KM1067 | KM1167 | KMC1067 | KMC1167

Width	33	Seat Width	24	Back Height	27
Depth	39	Seat Depth	22	Arm Height	26.5
Height	46	Seat Height	22	Weight	166
COM (Standard)	7 YDS	COM (Chaise)	8 YDS	Distance from Wall	17.5
Reclined Depth	76	Seat Depth (kick-out)	40	Weight Capacity	650 lbs.

KM1067 MOBILE HEALTHCARE RECLINER - RIGHT (FACING) FOLD DOWN ARM INFINITE POSITION NON-LOCKING BACK

COM	4	5	6	7	8	9	10	11	
	4569	4609	4709	4879	5129	5319	5599	5929	7269

KM1167 MOBILE HEALTHCARE RECLINER - RIGHT (FACING) FOLD DOWN ARM INFINITE POSITION LOCKING BACK

COM	4	5	6	7	8	9	10	11	
	4829	4889	4979	5159	5419	5619	5909	6239	7579

KMC1067 MOBILE HEALTHCARE CHAISE RECLINER RIGHT (FACING) FOLD DOWN ARM INFINITE POSITION NON-LOCKING BACK

COM	4	5	6	7	8	9	10	11	
	4739	4849	4999	5219	5539	5789	6199	6579	8189

KMC1167 MOBILE HEALTHCARE CHAISE RECLINER RIGHT (FACING) FOLD DOWN ARM INFINITE POSITION LOCKING BACK

COM	4	5	6	7	8	9	10	11	
	5029	5119	5249	5509	5809	6079	6459	6889	8499

If patient transfer arm is specified on left side (facing), then handle will be placed on right side (facing) and vice versa.

Options	List Price	Options	List Price
U Urethane Arm Caps*	Standard	MR/L Right/Left Side (facing) Monitor Arm (non-fold down arm only)	\$629
W Wood Arm Caps*	\$229	MTR/L Right/Left Side (facing) Monitor Arm with Tray (non-fold down arm only)	\$629
J Solid Surface Arm Caps* - Group 1	\$619 (Group 2 add \$200)	EG Edge Guard	Standard
Z Multi Cover	Use Highest Grade	HC Hinge Cover	Standard
H Heat (Certified to UL 60601-1)	\$849	CAL CAL TB133	See page 12
HM Heat & Massage (Certified to UL 60601-1)	\$1119	MBB Moisture Barrier Back	\$59
HW Heat Wand (Certified to UL 60601-1)	\$1139	MBS Moisture Barrier Seat	\$59
HMW Heat & Massage Wand (Certified to UL 60601-1)	\$1369	4S4 All 4" Swivel Locking Caster	\$39
S4 4" 2-Caster Lock & Steer	\$569	AHP Adjustable Head Rest Pillow (Requires 1 yd of fabric)	\$339
Q3 3" Dual Wheel Central Locking Caster (Non-Directional)	\$1019	ABP Adjustable Back Pad (COM-Grade 6) 1.75yd COM	\$459
Q4 4" Central Caster Lock & Steer	\$1019	Adjustable Back Pad (Grade 7-11)	\$569
Q5 5" Central Caster Lock & Steer	\$1139	FBH Foley Bag Holder	\$89
LC LiquiCell (Standard on Heat or Heat & Massage option)	\$229	FT Foot Tray	\$279
		IV IV Pole and Bracket	\$249
		DP Dual IV Poles	\$498
		TE Trendelenburg	\$339
		USB Hospital Grade Power	\$459
		QR Additional Quick Release Accessory Bracket	\$69
		PR1 Paper Roll Holder (takes place of push bar)	\$229

*Please refer to page 14 for finishes.

Please refer to pages 134/135 for Option descriptions & images.

Please refer to page 132 for the recliner ordering guide.



EV | Compact Mobile Healthcare Recliners - Dual Fold Down Arm - 22" Seat - 650 lb Rating

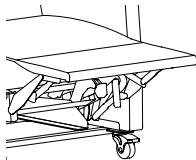
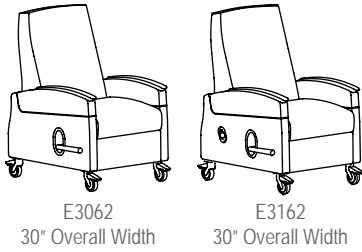

Chaise Model*
EC3062 | EC3162

DIMENSIONS | E3062 | E3162 | EC3062 | EC3162

Width	30	Seat Width	22	Back Height	25
Depth	35.5	Seat Depth	21	Arm Height	27
Height	47	Seat Height	21.5	Weight (3062)	147
COM (Standard)	7 YDS	COM (Chaise)	8 YDS	Weight (3162)	155
Reclined Depth	76	Seat Depth (kick-out)	39	Distance from Wall	20
Weight Capacity	650 lbs.				

E3062 MOBILE HEALTHCARE RECLINER DUAL FOLD DOWN ARM INFINITE POSITION NON-LOCKING BACK

COM	4	5	6	7	8	9	10	11
	5149	5209	5289	5469	5709	5889	6159	6479
	7809							

E3162 MOBILE HEALTHCARE RECLINER DUAL FOLD DOWN ARM INFINITE POSITION LOCKING BACK

COM	4	5	6	7	8	9	10	11
	5809	5829	5909	6069	6329	6489	6759	7089
	8369							

EC3062 MOBILE HEALTHCARE CHAISE RECLINER DUAL FOLD DOWN ARM INFINITE POSITION NON-LOCKING BACK

COM	4	5	6	7	8	9	10	11
	5349	5429	5569	5789	6109	6349	6709	7139
	8569							

EC3162 MOBILE HEALTHCARE CHAISE RECLINER DUAL FOLD DOWN ARM INFINITE POSITION LOCKING BACK

COM	4	5	6	7	8	9	10	11
	6009	6069	6199	6419	6729	6959	7309	7739
	9289							

Options	List Price	Options	List Price
U Urethane Arm Caps*	Standard	EG Edge Guard	Standard
W Wood Arm Caps*	\$229	HC Hinge Cover	Standard
J Solid Surface Arm Caps* - Group 1	\$619 (Group 2 add \$200)	CAL CAL TB133	See page 12
Z Multi Cover	Use Highest Grade	MBB Moisture Barrier Back	\$59
HW Heat Wand (Certified to UL 60601-1)	\$1139	MBS Moisture Barrier Seat	\$59
HMW Heat & Massage Wand	\$1369	4S4 All 4" Swivel Locking Caster	\$39
S4 4" 2-Caster Lock & Steer	\$569	AHP Adjustable Head Rest Pillow	\$339
Q3 3" Dual Wheel Central Locking Caster	\$1019	(Requires 1 yd of fabric)	
(Non-Directional)		ABP Adjustable Back Pad (COM-Grade 6) 1.75yd COM	\$459
Q4 4" Central Caster Lock & Steer	\$1019	Adjustable Back Pad (Grade 7-11)	\$569
Q5 5" Central Caster Lock & Steer	\$1139	FBH Foley Bag Holder	\$89
LC LiquiCell	\$229	FT Foot Tray	\$279
(Standard on Heat or Heat & Massage option)		IV IV Pole and Bracket	\$249
		DP Dual IV Poles	\$498
		TE Trendelenburg	\$339
		USB Hospital Grade Power	\$459
		PR1 Paper Roll Holder (takes place of push bar)	\$229

*Please refer to page 14 for finishes.
Please refer to pages 134/135 for Option descriptions & images.
Please refer to page 132 for the recliner ordering guide.

Rêma | Compact Mobile Healthcare Recliners - Dual Fold Down Arm - 22" Seat - 650 lb Rating

DURABLE® 650 SERIES

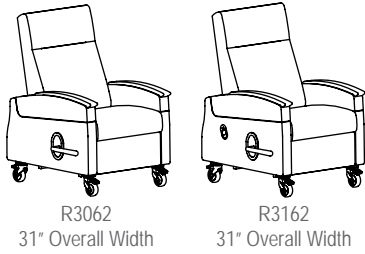

DIMENSIONS | R3062 | R3162 | RC3062 | RC3162

Width	31	Seat Width	22	Back Height	26
Depth	35.5	Seat Depth	21	Arm Height	28
Height	47	Seat Height	21.5	Weight (3062)	158
COM (Standard)	7 YDS	COM (Chaise)	8 YDS	Weight (3162)	166
Reclined Depth	76	Seat Depth (kick-out)	40	Distance from Wall	20
Weight Capacity	650 lbs.				

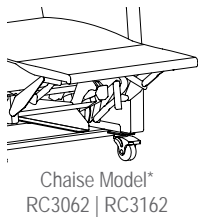

R3062 MOBILE HEALTHCARE RECLINER DUAL FOLD DOWN ARM INFINITE POSITION NON-LOCKING BACK

COM	4	5	6	7	8	9	10	11	
	5149	5209	5289	5469	5709	5889	6159	6479	7809

R3162 MOBILE HEALTHCARE RECLINER DUAL FOLD DOWN ARM INFINITE POSITION LOCKING BACK

COM	4	5	6	7	8	9	10	11	
	5809	5829	5909	6069	6329	6489	6759	7089	8369

RC3062 MOBILE HEALTHCARE CHAISE RECLINER DUAL FOLD DOWN ARM INFINITE POSITION NON-LOCKING BACK

COM	4	5	6	7	8	9	10	11	
	5349	5429	5569	5789	6109	6349	6709	7139	8569

RC3162 MOBILE HEALTHCARE CHAISE RECLINER DUAL FOLD DOWN ARM INFINITE POSITION LOCKING BACK

COM	4	5	6	7	8	9	10	11	
	6009	6069	6199	6419	6729	6959	7309	7739	9289

DUAL FOLD DOWN ARM RECLINER

Options	List Price	Options	List Price
U Urethane Arm Caps*	Standard	EG Edge Guard	Standard
W Wood Arm Caps*	\$229	HC Hinge Cover	Standard
J Solid Surface Arm Caps* - Group 1	\$619 (Group 2 add \$200)	CAL CAL TB133	See page 12
Z Multi Cover	Use Highest Grade	MBB Moisture Barrier Back	\$59
HW Heat Wand (Certified to UL 60601-1)	\$1139	MBS Moisture Barrier Seat	\$59
HMW Heat & Massage Wand (Certified to UL 60601-1)	\$1369	4S4 All 4" Swivel Locking Caster	\$39
S4 4" 2-Caster Lock & Steer	\$569	AHP Adjustable Head Rest Pillow (Requires 1 yd of fabric)	\$339
Q3 3" Dual Wheel Central Locking Caster (Non-Directional)	\$1019	ABP Adjustable Back Pad (COM-Grade 6) 1.75yd COM	\$459
Q4 4" Central Caster Lock & Steer	\$1019	Adjustable Back Pad (Grade 7-11)	\$569
Q5 5" Central Caster Lock & Steer	\$1139	FBH Foley Bag Holder	\$89
LC LiquiCell (Standard on Heat or Heat & Massage option)	\$229	FT Foot Tray	\$279
		IV IV Pole and Bracket	\$249
		DP Dual IV Poles	\$498
		TE Trendelenburg	\$339
		USB Hospital Grade Power	\$459
		PR1 Paper Roll Holder (takes place of push bar)	\$229

*Please refer to page 14 for finishes.
 Please refer to pages 134/135 for Option descriptions & images.
 Please refer to page 132 for the recliner ordering guide.



Koncert | Compact Mobile Healthcare Recliners - Dual Fold Down Arm - 22" Seat - 650 lb Rating

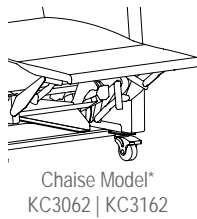
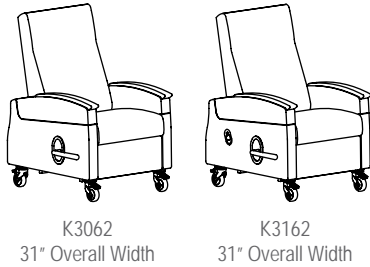

DIMENSIONS | K3062 | K3162 | KC3062 | KC3162

Width	31	Seat Width	22	Back Height	26
Depth	35.5	Seat Depth	21	Arm Height	28
Height	47	Seat Height	21.5	Weight (3062)	158
COM (Standard)	7 YDS	COM (Chaise)	8 YDS	Weight (3162)	166
Reclined Depth	76	Seat Depth (kick-out)	40	Distance from Wall	20
Weight Capacity	650 lbs.				

K3062 MOBILE HEALTHCARE RECLINER DUAL FOLD DOWN ARM INFINITE POSITION NON-LOCKING BACK

COM	4	5	6	7	8	9	10	11
5149	5209	5289	5469	5709	5889	6159	6479	7809

K3162 MOBILE HEALTHCARE RECLINER DUAL FOLD DOWN ARM INFINITE POSITION LOCKING BACK

COM	4	5	6	7	8	9	10	11
5809	5829	5909	6069	6329	6489	6759	7089	8369

KC3062 MOBILE HEALTHCARE CHAISE RECLINER DUAL FOLD DOWN ARM INFINITE POSITION NON-LOCKING BACK

COM	4	5	6	7	8	9	10	11
5349	5429	5569	5789	6109	6349	6709	7139	8569

KC3162 MOBILE HEALTHCARE CHAISE RECLINER DUAL FOLD DOWN ARM INFINITE POSITION LOCKING BACK

COM	4	5	6	7	8	9	10	11
6009	6069	6199	6419	6729	6959	7309	7739	9289

Options	List Price	Options	List Price
U Urethane Arm Caps*	Standard	EG Edge Guard	Standard
W Wood Arm Caps*	\$229	HC Hinge Cover	Standard
J Solid Surface Arm Caps* - Group 1	\$619 (Group 2 add \$200)	CAL CAL TB133	See page 12
Z Multi Cover	Use Highest Grade	MBB Moisture Barrier Back	\$59
HW Heat Wand (Certified to UL 60601-1)	\$1139	MBS Moisture Barrier Seat	\$59
HMW Heat & Massage Wand (Certified to UL 60601-1)	\$1369	4S4 All 4" Swivel Locking Caster	\$39
S4 4" 2-Caster Lock & Steer	\$569	AHP Adjustable Head Rest Pillow (Requires 1 yd of fabric)	\$339
Q3 3" Dual Wheel Central Locking Caster (Non-Directional)	\$1019	ABP Adjustable Back Pad (COM-Grade 6) 1.75yd COM	\$459
Q4 4" Central Caster Lock & Steer	\$1019	Adjustable Back Pad (Grade 7-11)	\$569
Q5 5" Central Caster Lock & Steer	\$1139	FBH Foley Bag Holder	\$89
LC LiquiCell (Standard on Heat or Heat & Massage option)	\$229	FT Foot Tray	\$279
		IV IV Pole and Bracket	\$249
		DP Dual IV Poles	\$498
		TE Trendelenburg	\$339
		USB Hospital Grade Power	\$459
		PR1 Paper Roll Holder (takes place of push bar)	\$229

*Please refer to page 14 for finishes.
 Please refer to pages 134/135 for Option descriptions & images.
 Please refer to page 132 for the recliner ordering guide.



Kadia Mod | Compact Mobile Healthcare Recliners - Dual Fold Down Arm - 22" Seat - 650 lb Rating

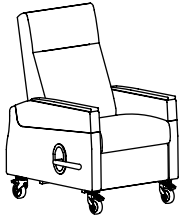

KM3062
31" Overall Width

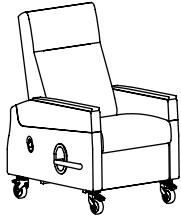

KM3162
31" Overall Width

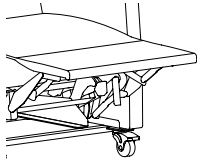

Chaise Model*
KMC3062 | KMC3162

DIMENSIONS | KM3062 | KM3162 | KMC3062 | KMC3162

Width	31	Seat Width	22	Back Height	26
Depth	35.5	Seat Depth	21	Arm Height	26.5
Height	47	Seat Height	21.5	Weight (3062)	158
COM (Standard)	7 YDS	COM (Chaise)	8 YDS	Weight (3162)	166
Reclined Depth	76	Seat Depth (kick-out)	40	Distance from Wall	20
Weight Capacity	650 lbs.				

KM3062 MOBILE HEALTHCARE RECLINER DUAL FOLD DOWN ARM INFINITE POSITION NON-LOCKING BACK

COM	4	5	6	7	8	9	10	11	
	5149	5209	5289	5469	5709	5889	6159	6479	7809

KM3162 MOBILE HEALTHCARE RECLINER DUAL FOLD DOWN ARM INFINITE POSITION LOCKING BACK

COM	4	5	6	7	8	9	10	11	
	5809	5829	5909	6069	6329	6489	6759	7089	8369

KMC3062 MOBILE HEALTHCARE CHAISE RECLINER DUAL FOLD DOWN ARM INFINITE POSITION NON-LOCKING BACK

COM	4	5	6	7	8	9	10	11	
	5349	5429	5569	5789	6109	6349	6709	7139	8569

KMC3162 MOBILE HEALTHCARE CHAISE RECLINER DUAL FOLD DOWN ARM INFINITE POSITION LOCKING BACK

COM	4	5	6	7	8	9	10	11	
	6009	6069	6199	6419	6729	6959	7309	7739	9289

Options

U	Urethane Arm Caps*	Standard
W	Wood Arm Caps*	\$229
J	Solid Surface Arm Caps* - Group 1	\$619 (Group 2 add \$200)
Z	Multi Cover	Use Highest Grade
HW	Heat Wand (Certified to UL 60601-1)	\$1139
HMW	Heat & Massage Wand (Certified to UL 60601-1)	\$1369
S4	4" 2-Caster Lock & Steer	\$569
Q3	3" Dual Wheel Central Locking Caster (Non-Directional)	\$1019
Q4	4" Central Caster Lock & Steer	\$1019
Q5	5" Central Caster Lock & Steer	\$1139
LC	LiquiCell (Standard on Heat or Heat & Massage option)	\$229

Options

EG	Edge Guard	Standard
HC	Hinge Cover	Standard
CAL	CAL TB133	See page 12
MBB	Moisture Barrier Back	\$59
MBS	Moisture Barrier Seat	\$59
4S4	All 4" Swivel Locking Caster	\$39
AHP	Adjustable Head Rest Pillow (Requires 1 yd of fabric)	\$339
ABP	Adjustable Back Pad (COM-Grade 6) 1.75yd COM	\$459
	Adjustable Back Pad (Grade 7-11)	\$569
FBH	Foley Bag Holder	\$89
FT	Foot Tray	\$279
IV	IV Pole and Bracket	\$249
DP	Dual IV Poles	\$498
TE	Trendelenburg	\$339
USB	Hospital Grade Power	\$459
PR1	Paper Roll Holder (takes place of push bar)	\$229

*Please refer to page 14 for finishes.

Please refer to pages 134/135 for Option descriptions & images.

Please refer to page 132 for the recliner ordering guide.



EV | Mobile Healthcare Recliners - Dual Fold Down Arm - 24" Seat - 650 lb Rating

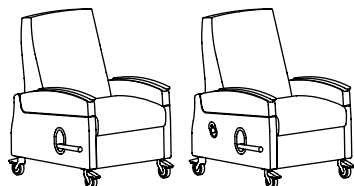

E4062
32.5" Overall Width

E4162
32.5" Overall Width

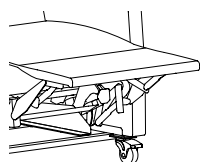

Chaise Model*
EC4062 | EC4162

DIMENSIONS | E4062 | E4162 | EC4062 | EC4162

Width	32.5	Seat Width	24	Back Height	25
Depth	35.5	Seat Depth	21	Arm Height	27
Height	47	Seat Height	21.5	Weight (4062)	147
COM (Standard)	7 YDS	COM (Chaise)	8 YDS	Weight (4162)	155
Reclined Depth	76	Seat Depth (kick-out)	39	Distance from Wall	20
Weight Capacity	650 lbs.				

E4062 MOBILE HEALTHCARE RECLINER DUAL FOLD DOWN ARM INFINITE POSITION NON-LOCKING BACK

COM	4	5	6	7	8	9	10	11
5149	5209	5289	5469	5709	5889	6159	6479	7809

E4162 MOBILE HEALTHCARE RECLINER DUAL FOLD DOWN ARM INFINITE POSITION LOCKING BACK

COM	4	5	6	7	8	9	10	11
5809	5829	5909	6069	6329	6489	6759	7089	8369

EC4062 MOBILE HEALTHCARE CHAISE RECLINER DUAL FOLD DOWN ARM INFINITE POSITION NON-LOCKING BACK

COM	4	5	6	7	8	9	10	11
5349	5429	5569	5789	6109	6349	6709	7139	8569

EC4162 MOBILE HEALTHCARE CHAISE RECLINER DUAL FOLD DOWN ARM INFINITE POSITION LOCKING BACK

COM	4	5	6	7	8	9	10	11
6009	6069	6199	6419	6729	6959	7309	7739	9289

Options	List Price	Options	List Price
U Urethane Arm Caps*	Standard	EG Edge Guard	Standard
W Wood Arm Caps*	\$229	HC Hinge Cover	Standard
J Solid Surface Arm Caps* - Group 1	\$619 (Group 2 add \$200)	CAL CAL TB133	See page 12
Z Multi Cover	Use Highest Grade	MBB Moisture Barrier Back	\$59
HW Heat Wand (Certified to UL 60601-1)	\$1139	MBS Moisture Barrier Seat	\$59
HMW Heat & Massage Wand	\$1369	4S4 All 4" Swivel Locking Caster	\$39
S4 4" 2-Caster Lock & Steer	\$569	AHP Adjustable Head Rest Pillow	\$339
Q3 3" Dual Wheel Central Locking Caster	\$1019	(Requires 1 yd of fabric)	
(Non-Directional)		ABP Adjustable Back Pad (COM-Grade 6) 1.75yd COM	\$459
Q4 4" Central Caster Lock & Steer	\$1019	Adjustable Back Pad (Grade 7-11)	\$569
Q5 5" Central Caster Lock & Steer	\$1139	FBH Foley Bag Holder	\$89
LC LiquiCell	\$229	FT Foot Tray	\$279
(Standard on Heat or Heat & Massage option)		IV IV Pole and Bracket	\$249
		DP Dual IV Poles	\$498
		TE Trendelenburg	\$339
		USB Hospital Grade Power	\$459
		PR1 Paper Roll Holder (takes place of push bar)	\$229

*Please refer to page 14 for finishes.

Please refer to pages 134/135 for Option descriptions & images.

Please refer to page 132 for the recliner ordering guide.

EV | Mobile Healthcare Recliners - Dual Fold Down Arm - 24" Seat - 650 lb Rating

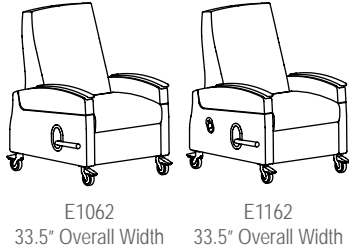

DIMENSIONS | E1062 | E1162 | EC1062 | EC1162

Width	33.5	Seat Width	24	Back Height	26
Depth	38	Seat Depth	21	Arm Height	28
Height	47	Seat Height	21.5	Weight (1062)	158
COM (Standard)	7 YDS	COM (Chaise)	8 YDS	Weight (1162)	166
Reclined Depth	76	Seat Depth (kick-out)	40	Distance from Wall	20
Weight Capacity	650 lbs.				

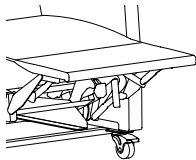

Chaise Model*
EC1062 | EC1162

E1062 MOBILE HEALTHCARE RECLINER DUAL FOLD DOWN ARM INFINITE POSITION NON-LOCKING BACK

COM	4	5	6	7	8	9	10	11
5209	5269	5339	5519	5759	5939	6229	6529	7849

E1162 MOBILE HEALTHCARE RECLINER DUAL FOLD DOWN ARM INFINITE POSITION LOCKING BACK

COM	4	5	6	7	8	9	10	11
5859	5899	5979	6139	6379	6529	6829	7139	8419

EC1062 MOBILE HEALTHCARE CHAISE RECLINER DUAL FOLD DOWN ARM INFINITE POSITION NON-LOCKING BACK

COM	4	5	6	7	8	9	10	11
5399	5489	5609	5829	6169	6409	6759	7179	8609

EC1162 MOBILE HEALTHCARE CHAISE RECLINER DUAL FOLD DOWN ARM INFINITE POSITION LOCKING BACK

COM	4	5	6	7	8	9	10	11
6049	6119	6239	6459	6769	7009	7389	7789	9189

Options	List Price	Options	List Price
U Urethane Arm Caps*	Standard	EG Edge Guard	Standard
W Wood Arm Caps*	\$229	HC Hinge Cover	Standard
J Solid Surface Arm Caps* - Group 1	\$619 (Group 2 add \$200)	CAL CAL TB133	See page 12
Z Multi Cover	Use Highest Grade	MBB Moisture Barrier Back	\$59
HW Heat Wand (Certified to UL 60601-1)	\$1139	MBS Moisture Barrier Seat	\$59
HMW Heat & Massage Wand (Certified to UL 60601-1)	\$1369	4S4 All 4" Swivel Locking Caster	\$39
S4 4" 2-Caster Lock & Steer	\$569	AHP Adjustable Head Rest Pillow (Requires 1 yd of fabric)	\$339
Q3 3" Dual Wheel Central Locking Caster (Non-Directional)	\$1019	ABP Adjustable Back Pad (COM-Grade 6) 1.75yd COM	\$459
Q4 4" Central Caster Lock & Steer	\$1019	Adjustable Back Pad (Grade 7-11)	\$569
Q5 5" Central Caster Lock & Steer	\$1139	FBH Foley Bag Holder	\$89
LC LiquiCell (Standard on Heat or Heat & Massage option)	\$229	FT Foot Tray	\$279
		IV IV Pole and Bracket	\$249
		DP Dual IV Poles	\$498
		TE Trendelenburg	\$339
		USB Hospital Grade Power	\$459
		PR1 Paper Roll Holder (takes place of push bar)	\$229

*Please refer to page 14 for finishes.
Please refer to pages 134/135 for Option descriptions & images.
Please refer to page 132 for the recliner ordering guide.



EV | Mobile Healthcare Wingback Recliners - Dual Fold Down Arm - 24" Seat - 650 lb Rating

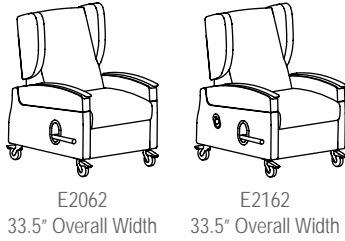

DIMENSIONS | E2062 | E2162 | EC2062 | EC2162

Width	33.5	Seat Width	24	Back Height	26
Depth	38	Seat Depth	21	Arm Height	28
Height	47	Seat Height	21.5	Weight (2062)	176
COM (Standard)	7 YDS	COM (Chaise)	8 YDS	Weight (2162)	188
Reclined Depth	76	Seat Depth (kick-out)	40	Distance from Wall	20
Weight Capacity	650 lbs.				

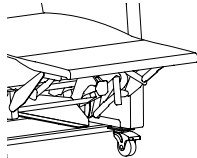

Chaise Model*
EC2062 | EC2162

E2062 MOBILE HEALTHCARE RECLINER DUAL FOLD DOWN ARM INFINITE POSITION NON-LOCKING BACK

COM	4	5	6	7	8	9	10	11
6069	6089	6179	6349	6579	6729	7019	7339	8609

E2162 MOBILE HEALTHCARE RECLINER DUAL FOLD DOWN ARM INFINITE POSITION LOCKING BACK

COM	4	5	6	7	8	9	10	11
6719	6729	6789	6969	7189	7349	7629	7929	9339

EC2062 MOBILE HEALTHCARE CHAISE RECLINER DUAL FOLD DOWN ARM INFINITE POSITION NON-LOCKING BACK

COM	4	5	6	7	8	9	10	11
6269	6309	6439	6669	6969	7199	7579	7979	9519

EC2162 MOBILE HEALTHCARE CHAISE RECLINER DUAL FOLD DOWN ARM INFINITE POSITION LOCKING BACK

COM	4	5	6	7	8	9	10	11
6909	6949	7059	7309	7599	7819	8189	8579	10109

Options	List Price	Options	List Price
U Urethane Arm Caps*	Standard	EG Edge Guard	Standard
W Wood Arm Caps*	\$229	HC Hinge Cover	Standard
J Solid Surface Arm Caps* - Group 1	\$619 (Group 2 add \$200)	CAL CAL TB133	See page 12
Z Multi Cover	Use Highest Grade	MBB Moisture Barrier Back	\$59
HW Heat Wand (Certified to UL 60601-1)	\$1139	MBS Moisture Barrier Seat	\$59
HMW Heat & Massage Wand	\$1369	4S4 All 4" Swivel Locking Caster	\$39
S4 4" 2-Caster Lock & Steer	\$569	AHP Adjustable Head Rest Pillow	\$339
Q3 3" Dual Wheel Central Locking Caster (Non-Directional)	\$1019	(Requires 1 yd of fabric)	
Q4 4" Central Caster Lock & Steer	\$1019	ABP Adjustable Back Pad (COM-Grade 6) 1.75yd COM	\$459
Q5 5" Central Caster Lock & Steer	\$1139	Adjustable Back Pad (Grade 7-11)	\$569
LC LiquiCell	\$229	FBH Foley Bag Holder	\$89
(Standard on Heat or Heat & Massage option)		FT Foot Tray	\$279
		IV IV Pole and Bracket	\$249
		DP Dual IV Poles	\$498
		TE Trendelenburg	\$339
		USB Hospital Grade Power	\$459
		PR1 Paper Roll Holder (takes place of push bar)	\$229

*Please refer to page 14 for finishes.
Please refer to pages 134/135 for Option descriptions & images.
Please refer to page 132 for the recliner ordering guide.

Rêma | Mobile Healthcare Recliners - Dual Fold Down Arm - 24" Seat - 650 lb Rating

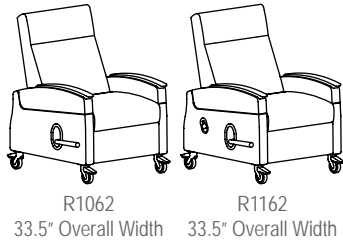

DIMENSIONS | R1062 | R1162 | RC1062 | RC1162

Width	33.5	Seat Width	24	Back Height	26
Depth	38	Seat Depth	21	Arm Height	28
Height	47	Seat Height	21.5	Weight (1062)	158
COM (Standard)	7 YDS	COM (Chaise)	8 YDS	Weight (1162)	166
Reclined Depth	76	Seat Depth (kick-out)	40	Distance from Wall	20
Weight Capacity	650 lbs.				

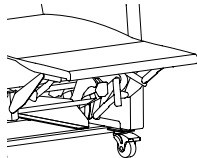

Chaise Model*
RC1062 | RC1162

R1062 MOBILE HEALTHCARE RECLINER DUAL FOLD DOWN ARM INFINITE POSITION NON-LOCKING BACK

COM	4	5	6	7	8	9	10	11
5209	5269	5339	5519	5759	5939	6229	6529	7849

R1162 MOBILE HEALTHCARE RECLINER DUAL FOLD DOWN ARM INFINITE POSITION LOCKING BACK

COM	4	5	6	7	8	9	10	11
5859	5899	5979	6139	6379	6529	6829	7139	8419

RC1062 MOBILE HEALTHCARE CHAISE RECLINER DUAL FOLD DOWN ARM INFINITE POSITION NON-LOCKING BACK

COM	4	5	6	7	8	9	10	11
5399	5489	5609	5829	6169	6409	6759	7179	8609

RC1162 MOBILE HEALTHCARE CHAISE RECLINER DUAL FOLD DOWN ARM INFINITE POSITION LOCKING BACK

COM	4	5	6	7	8	9	10	11
6049	6119	6239	6459	6769	7009	7389	7789	9189

Options	List Price	Options	List Price
U Urethane Arm Caps*	Standard	EG Edge Guard	Standard
W Wood Arm Caps*	\$229	HC Hinge Cover	Standard
J Solid Surface Arm Caps* - Group 1	\$619 (Group 2 add \$200)	CAL CAL TB133	See page 12
Z Multi Cover	Use Highest Grade	MBB Moisture Barrier Back	\$59
HW Heat Wand (Certified to UL 60601-1)	\$1139	MBS Moisture Barrier Seat	\$59
HMW Heat & Massage Wand (Certified to UL 60601-1)	\$1369	4S4 All 4" Swivel Locking Caster	\$39
S4 4" 2-Caster Lock & Steer	\$569	AHP Adjustable Head Rest Pillow (Requires 1 yd of fabric)	\$339
Q3 3" Dual Wheel Central Locking Caster (Non-Directional)	\$1019	ABP Adjustable Back Pad (COM-Grade 6) 1.75yd COM	\$459
Q4 4" Central Caster Lock & Steer	\$1019	Adjustable Back Pad (Grade 7-11)	\$569
Q5 5" Central Caster Lock & Steer	\$1139	FBH Foley Bag Holder	\$89
LC LiquiCell (Standard on Heat or Heat & Massage option)	\$229	FT Foot Tray	\$279
		IV IV Pole and Bracket	\$249
		DP Dual IV Poles	\$498
		TE Trendelenburg	\$339
		USB Hospital Grade Power	\$459
		PR1 Paper Roll Holder (takes place of push bar)	\$229

*Please refer to page 14 for finishes.

Please refer to pages 134/135 for Option descriptions & images.

Please refer to page 132 for the recliner ordering guide.



Koncert | Mobile Healthcare Recliners - Dual Fold Down Arm - 24" Seat - 650 lb Rating

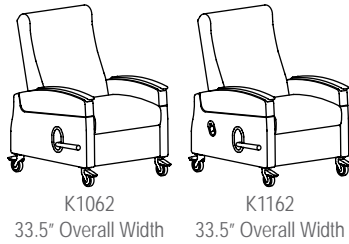

DIMENSIONS | K1062 | K1162 | KC1062 | KC1162

Width	33.5	Seat Width	24	Back Height	26
Depth	38	Seat Depth	21	Arm Height	28
Height	47	Seat Height	21.5	Weight (1062)	158
COM (Standard)	7 YDS	COM (Chaise)	8 YDS	Weight (1162)	166
Reclined Depth	76	Seat Depth (kick-out)	40	Distance from Wall	20
Weight Capacity	650 lbs.				

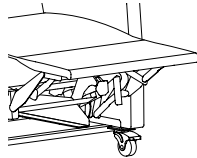

Chaise Model*
KC1062 | KC1162

K1062 MOBILE HEALTHCARE RECLINER DUAL FOLD DOWN ARM INFINITE POSITION NON-LOCKING BACK

COM	4	5	6	7	8	9	10	11
5209	5269	5339	5519	5759	5939	6229	6529	7849

K1162 MOBILE HEALTHCARE RECLINER DUAL FOLD DOWN ARM INFINITE POSITION LOCKING BACK

COM	4	5	6	7	8	9	10	11
5859	5899	5979	6139	6379	6529	6829	7139	8419

KC1062 MOBILE HEALTHCARE CHAISE RECLINER DUAL FOLD DOWN ARM INFINITE POSITION NON-LOCKING BACK

COM	4	5	6	7	8	9	10	11
5399	5489	5609	5829	6169	6409	6759	7179	8609

KC1162 MOBILE HEALTHCARE CHAISE RECLINER DUAL FOLD DOWN ARM INFINITE POSITION LOCKING BACK

COM	4	5	6	7	8	9	10	11
6049	6119	6239	6459	6769	7009	7389	7789	9189

Options	List Price	Options	List Price
U Urethane Arm Caps*	Standard	EG Edge Guard	Standard
W Wood Arm Caps*	\$229	HC Hinge Cover	Standard
J Solid Surface Arm Caps* - Group 1	\$619 (Group 2 add \$200)	CAL CAL TB133	See page 12
Z Multi Cover	Use Highest Grade	MBB Moisture Barrier Back	\$59
HW Heat Wand (Certified to UL 60601-1)	\$1139	MBS Moisture Barrier Seat	\$59
HMW Heat & Massage Wand (Certified to UL 60601-1)	\$1369	4S4 All 4" Swivel Locking Caster	\$39
S4 4" 2-Caster Lock & Steer	\$569	AHP Adjustable Head Rest Pillow (Requires 1 yd of fabric)	\$339
Q3 3" Dual Wheel Central Locking Caster (Non-Directional)	\$1019	ABP Adjustable Back Pad (COM-Grade 6) 1.75yd COM	\$459
Q4 4" Central Caster Lock & Steer	\$1019	Adjustable Back Pad (Grade 7-11)	\$569
Q5 5" Central Caster Lock & Steer	\$1139	FBH Foley Bag Holder	\$89
LC LiquiCell (Standard on Heat or Heat & Massage option)	\$229	FT Foot Tray	\$279
		IV IV Pole and Bracket	\$249
		DP Dual IV Poles	\$498
		TE Trendelenburg	\$339
		USB Hospital Grade Power	\$459
		PR1 Paper Roll Holder (takes place of push bar)	\$229

*Please refer to page 14 for finishes.

Please refer to pages 134/135 for Option descriptions & images.

Please refer to page 132 for the recliner ordering guide.

Kadia Mod | Mobile Healthcare Recliners - Dual Fold Down Arm - 24" Seat - 650 lb Rating

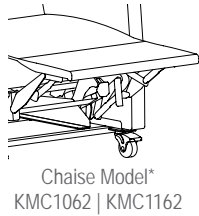
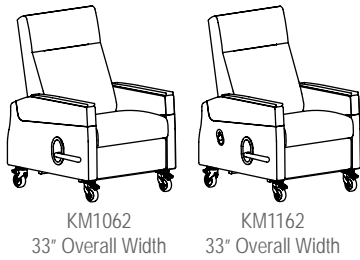

DIMENSIONS | KM1062 | KM1162 | KMC1062 | KMC1162

Width	33	Seat Width	24	Back Height	27
Depth	39	Seat Depth	21	Arm Height	26.5
Height	47	Seat Height	21.5	Weight (1062)	158
COM (Standard)	7 YDS	COM (Chaise)	8 YDS	Weight (1162)	166
Reclined Depth	75	Seat Depth (kick-out)	40	Distance from Wall	17.5
Weight Capacity	650 lbs				

KM1062 MOBILE HEALTHCARE RECLINER DUAL FOLD DOWN ARM INFINITE POSITION NON-LOCKING BACK

COM	4	5	6	7	8	9	10	11
5209	5269	5339	5519	5759	5939	6229	6529	7849

KM1162 MOBILE HEALTHCARE RECLINER DUAL FOLD DOWN ARM INFINITE POSITION LOCKING BACK

COM	4	5	6	7	8	9	10	11
5859	5899	5979	6139	6379	6529	6829	7139	8419

KMC1062 MOBILE HEALTHCARE CHAISE RECLINER DUAL FOLD DOWN ARM INFINITE POSITION NON-LOCKING BACK

COM	4	5	6	7	8	9	10	11
5399	5489	5609	5829	6169	6409	6759	7179	8609

KMC1162 MOBILE HEALTHCARE CHAISE RECLINER DUAL FOLD DOWN ARM INFINITE POSITION LOCKING BACK

COM	4	5	6	7	8	9	10	11
6049	6119	6239	6459	6769	7009	7389	7789	9189

Options	List Price	Options	List Price
U Urethane Arm Caps*	Standard	EG Edge Guard	Standard
W Wood Arm Caps*	\$229	HC Hinge Cover	Standard
J Solid Surface Arm Caps* - Group 1	\$619 (Group 2 add \$200)	CAL CAL TB133	See page 12
Z Multi Cover	Use Highest Grade	MBB Moisture Barrier Back	\$59
HW Heat Wand (Certified to UL 60601-1)	\$1139	MBS Moisture Barrier Seat	\$59
HMW Heat & Massage Wand (Certified to UL 60601-1)	\$1369	4S4 All 4" Swivel Locking Caster	\$39
S4 4" 2-Caster Lock & Steer	\$569	AHP Adjustable Head Rest Pillow (Requires 1 yd of fabric)	\$339
Q3 3" Dual Wheel Central Locking Caster (Non-Directional)	\$1019	ABP Adjustable Back Pad (COM-Grade 6) 1.75yd COM	\$459
Q4 4" Central Caster Lock & Steer	\$1019	Adjustable Back Pad (Grade 7-11)	\$569
Q5 5" Central Caster Lock & Steer	\$1139	FBH Foley Bag Holder	\$89
LC LiquiCell (Standard on Heat or Heat & Massage option)	\$229	FT Foot Tray	\$279
		IV IV Pole and Bracket	\$249
		DP Dual IV Poles	\$498
		TE Trendelenburg	\$339
		USB Hospital Grade Power	\$459
		PR1 Paper Roll Holder (takes place of push bar)	\$229

*Please refer to page 14 for finishes.
 Please refer to pages 134/135 for Option descriptions & images.
 Please refer to page 132 for the recliner ordering guide.



EV | Mobile Healthcare Recliners - Removable Arm - 24" Seat - 650 lb Rating

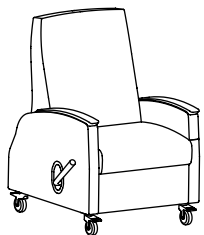

E1047 | E1147
33.5" Overall Width

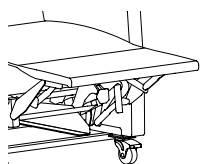

Chaise Model*
EC1047 | EC1147

DIMENSIONS | E1047 | E1147 | EC1047 | EC1147

Width	33.5	Seat Width	24	Back Height	26
Depth	38	Seat Depth	21	Arm Height	28
Height	47	Seat Height	21.5	Weight (1047)	158
COM (Standard)	7 YDS	COM (Chaise)	8 YDS	Weight (1147)	166
Reclined Depth	76	Seat Depth (kick-out)	40	Distance from Wall	20
Weight Capacity	650 lbs.				

E1047 MOBILE HEALTHCARE RECLINER W/ RIGHT (FACING) REMOVABLE ARM INFINITE POSITION NON-LOCKING BACK

COM	4	5	6	7	8	9	10	11
4569	4609	4709	4879	5129	5319	5599	5929	7269

E1147 MOBILE HEALTHCARE RECLINER W/ RIGHT (FACING) REMOVABLE ARM INFINITE POSITION LOCKING BACK

COM	4	5	6	7	8	9	10	11
4829	4889	4979	5159	5419	5619	5909	6239	7579

EC1047 MOBILE HEALTHCARE CHAISE RECLINER W/ RIGHT (FACING) REMOVABLE ARM INFINITE POSITION NON-LOCKING BACK

COM	4	5	6	7	8	9	10	11
4739	4849	4999	5219	5539	5789	6159	6579	8189

EC1147 MOBILE HEALTHCARE CHAISE RECLINER W/ RIGHT (FACING) REMOVABLE ARM INFINITE POSITION LOCKING BACK

COM	4	5	6	7	8	9	10	11
5029	5119	5249	5509	5809	6079	6459	6889	8499

If patient transfer arm is specified on left side (facing), then handle will be placed on right side (facing) and vice versa.

Options	List Price	Options	List Price
U Urethane Arm Caps*	Standard	Q3 3" Dual Wheel Central Locking Caster (Non-Directional)	\$1019
W Wood Arm Caps*	\$229	Q4 4" Central Caster Lock & Steer	\$1019
J Solid Surface Arm Caps* - Group 1	\$619 (Group 2 add \$200)	Q5 5" Central Caster Lock & Steer	\$1139
Z Multi Cover	Use Highest Grade	EG Edge Guard	Standard
H Heat (Certified to UL 60601-1)	\$849	CAL CAL TB133	See page 12
HM Heat & Massage (Certified to UL 60601-1)	\$1119	MBB Moisture Barrier Back	\$59
HW Heat Wand (Certified to UL 60601-1)	\$1139	MBS Moisture Barrier Seat	\$59
HMW Heat & Massage Wand	\$1369	4S4 All 4" Swivel Locking Caster	\$39
S4 4" 2-Caster Lock & Steer	\$569	AHP Adjustable Head Rest Pillow (Requires 1 yd of fabric)	\$339
MR/L Right/Left Side (facing) Monitor Arm (non-removable arm only)	\$629	ABP Adjustable Back Pad (COM-Grade 6) 1.75yd COM	\$459
MTR/L Right/Left Side (facing) Monitor Arm with Tray (non-removable arm only)	\$629	Adjustable Back Pad (Grade 7-11)	\$569
LC LiquiCell	\$229	FBH Foley Bag Holder	\$89
(Standard on Heat or Heat & Massage option)		FT Foot Tray	\$279
		TE Trendelenburg	\$339
		USB Hospital Grade Power	\$459
		QR Additional Quick Release Accessory Bracket	\$69
		PR1 Paper Roll Holder (takes place of push bar)	\$229

*Please refer to page 14 for finishes.

Please refer to pages 134/135 for Option descriptions & images.

Please refer to page 132 for the recliner ordering guide.

Rêma | Mobile Healthcare Recliners - Removable Arm - 24" Seat - 650 lb Rating

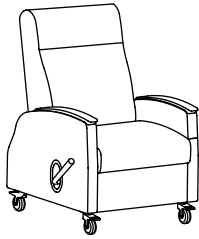

R1047 | R1147
33.5" Overall Width

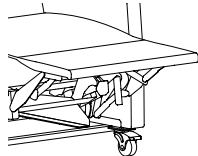

Chaise Model*
RC1047 | RC1147

DIMENSIONS | R1047 | R1147 | RC1047 | RC1147

Width	33.5	Seat Width	24	Back Height	26
Depth	38	Seat Depth	21	Arm Height	28
Height	47	Seat Height	21.5	Weight (1047)	158
COM (Standard)	7 YDS	COM (Chaise)	8 YDS	Weight (1147)	166
Reclined Depth	76	Seat Depth (kick-out)	40	Distance from Wall	20
Weight Capacity	650 lbs.				

R1047 MOBILE HEALTHCARE RECLINER W/ RIGHT (FACING) REMOVABLE ARM INFINITE POSITION NON-LOCKING BACK

COM	4	5	6	7	8	9	10	11	
	4569	4609	4709	4879	5129	5319	5599	5929	7269

R1147 MOBILE HEALTHCARE RECLINER W/ RIGHT (FACING) REMOVABLE ARM INFINITE POSITION LOCKING BACK

COM	4	5	6	7	8	9	10	11	
	4829	4889	4979	5159	5419	5619	5909	6239	7579

RC1047 MOBILE HEALTHCARE CHAISE RECLINER W/ RIGHT (FACING) REMOVABLE ARM INFINITE POSITION NON-LOCKING BACK

COM	4	5	6	7	8	9	10	11	
	4739	4849	4999	5219	5539	5789	6159	6579	8189

RC1147 MOBILE HEALTHCARE CHAISE RECLINER W/ RIGHT (FACING) REMOVABLE ARM INFINITE POSITION LOCKING BACK

COM	4	5	6	7	8	9	10	11	
	5029	5119	5249	5509	5809	6079	6459	6889	8499

If patient transfer arm is specified on left side (facing), then handle will be placed on right side (facing) and vice versa.

Options	List Price	Options	List Price
U Urethane Arm Caps*	Standard	Q3 3" Dual Wheel Central Locking Caster (Non-Directional)	\$1019
W Wood Arm Caps*	\$229	Q4 4" Central Caster Lock & Steer	\$1019
J Solid Surface Arm Caps* - Group 1	\$619 (Group 2 add \$200)	Q5 5" Central Caster Lock & Steer	\$1139
Z Multi Cover	Use Highest Grade	EG Edge Guard	Standard
H Heat (Certified to UL 60601-1)	\$849	CAL CAL TB133	See page 12
HM Heat & Massage (Certified to UL 60601-1)	\$1119	MBB Moisture Barrier Back	\$59
HW Heat Wand (Certified to UL 60601-1)	\$1139	MBS Moisture Barrier Seat	\$59
HMW Heat & Massage Wand (Certified to UL 60601-1)	\$1369	4S4 All 4" Swivel Locking Caster	\$39
S4 4" 2-Caster Lock & Steer	\$569	AHP Adjustable Head Rest Pillow (Requires 1 yd of fabric)	\$339
MR/L Right/Left Side (facing) Monitor Arm (non-removable arm only)	\$629	ABP Adjustable Back Pad (COM-Grade 6) 1.75yd COM	\$459
MTR/L Right/Left Side (facing) Monitor Arm with Tray (non-removable arm only)	\$629	Adjustable Back Pad (Grade 7-11)	\$569
LC LiquiCell (Standard on Heat or Heat & Massage option)	\$229	FBH Foley Bag Holder	\$89
		FT Foot Tray	\$279
		TE Trendelenburg	\$339
		USB Hospital Grade Power	\$459
		QR Additional Quick Release Accessory Bracket	\$69
		PR1 Paper Roll Holder (takes place of push bar)	\$229

*Please refer to page 14 for finishes.

Please refer to pages 134/135 for Option descriptions & images.

Please refer to page 132 for the recliner ordering guide.



Koncert | Mobile Healthcare Recliners - Removable Arm - 24" Seat - 650 lb Rating

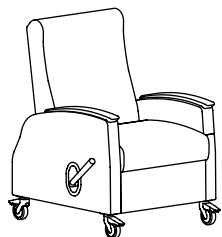

K1047 | K1147
33.5" Overall Width

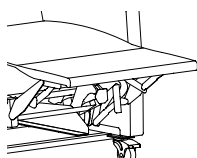

Chaise Model*
KC1047 | KC1147

DIMENSIONS | K1047 | K1147 | KC1047 | KC1147

Width	33.5	Seat Width	24	Back Height	26
Depth	38	Seat Depth	21	Arm Height	28
Height	47	Seat Height	21.5	Weight (1047)	158
COM (Standard)	7 YDS	COM (Chaise)	8 YDS	Weight (1147)	166
Reclined Depth	76	Seat Depth (kick-out)	40	Distance from Wall	20
Weight Capacity	650 lbs.				

K1047 MOBILE HEALTHCARE RECLINER W/ RIGHT (FACING) REMOVABLE ARM INFINITE POSITION NON-LOCKING BACK

COM	4	5	6	7	8	9	10	11	
	4569	4609	4709	4879	5129	5319	5599	5929	7269

K1147 MOBILE HEALTHCARE RECLINER W/ RIGHT (FACING) REMOVABLE ARM INFINITE POSITION LOCKING BACK

COM	4	5	6	7	8	9	10	11	
	4829	4889	4979	5159	5419	5619	5909	6239	7579

KC1047 MOBILE HEALTHCARE CHAISE RECLINER W/ RIGHT (FACING) REMOVABLE ARM INFINITE POSITION NON-LOCKING BACK

COM	4	5	6	7	8	9	10	11	
	4739	4849	4999	5219	5539	5789	6159	6579	8189

KC1147 MOBILE HEALTHCARE CHAISE RECLINER W/ RIGHT (FACING) REMOVABLE ARM INFINITE POSITION LOCKING BACK

COM	4	5	6	7	8	9	10	11	
	5029	5119	5249	5509	5809	6079	6459	6889	8499

If patient transfer arm is specified on left side (facing), then handle will be placed on right side (facing) and vice versa.

Options	List Price	Options	List Price
U Urethane Arm Caps*	Standard	Q3 3" Dual Wheel Central Locking Caster (Non-Directional)	\$1019
W Wood Arm Caps*	\$229	Q4 4" Central Caster Lock & Steer	\$1019
J Solid Surface Arm Caps* - Group 1	\$619 (Group 2 add \$200)	Q5 5" Central Caster Lock & Steer	\$1139
Z Multi Cover	Use Highest Grade	EG Edge Guard	Standard
H Heat (Certified to UL 60601-1)	\$849	CAL CAL TB133	See page 12
HM Heat & Massage (Certified to UL 60601-1)	\$1119	MBB Moisture Barrier Back	\$59
HW Heat Wand (Certified to UL 60601-1)	\$1139	MBS Moisture Barrier Seat	\$59
HMW Heat & Massage Wand	\$1369	4S4 All 4" Swivel Locking Caster	\$39
S4 4" 2-Caster Lock & Steer	\$569	AHP Adjustable Head Rest Pillow (Requires 1 yd of fabric)	\$339
MR/L Right/Left Side (facing) Monitor Arm (non-removable arm only)	\$629	ABP Adjustable Back Pad (COM-Grade 6) 1.75yd COM	\$459
MTR/L Right/Left Side (facing) Monitor Arm with Tray (non-removable arm only)	\$629	Adjustable Back Pad (Grade 7-11)	\$569
LC LiquiCell	\$229	FBH Foley Bag Holder	\$89
(Standard on Heat or Heat & Massage option)		FT Foot Tray	\$279
		TE Trendelenburg	\$339
		USB Hospital Grade Power	\$459
		QR Additional Quick Release Accessory Bracket	\$69
		PR1 Paper Roll Holder (takes place of push bar)	\$229

*Please refer to page 14 for finishes.

Please refer to pages 134/135 for Option descriptions & images.

Please refer to page 132 for the recliner ordering guide.

Harmony | Mobile Healthcare Recliners - Removable Arm - 24" Seat - 650 lb Rating

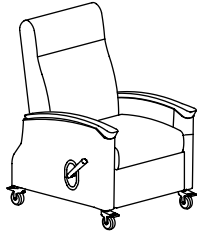

H5047 | H5147
34" Overall Width

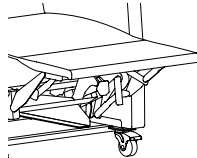

Chaise Model*
HC5047 | HC5147

DIMENSIONS | H5047 | H5147 | HC5047 | HC5147

Width	34	Seat Width	24	Back Height	26
Depth	38	Seat Depth	21	Arm Height	28
Height	47	Seat Height	21.5	Weight (1047)	167
COM	7 YDS	Seat Depth (kick-out)	40	Weight (1147)	175
Reclined Depth	76	Weight Capacity	650 lbs.	Distance from Wall	20

H5047 MOBILE HEALTHCARE RECLINER W/ RIGHT (FACING) REMOVABLE ARM INFINITE POSITION NON-LOCKING BACK

COM	4	5	6	7	8	9	10	11
4499	4579	4739	4969	5219	5489	5849	6229	7639

H5147 MOBILE HEALTHCARE RECLINER W/ RIGHT (FACING) REMOVABLE ARM INFINITE POSITION LOCKING BACK

COM	4	5	6	7	8	9	10	11
4819	4869	5019	5189	5469	5669	5989	6309	7749

HC5047 MOBILE HEALTHCARE CHAISE RECLINER W/ RIGHT (FACING) REMOVABLE ARM INFINITE POSITION NON-LOCKING BACK

COM	4	5	6	7	8	9	10	11
4729	4839	5039	5349	5679	6019	6469	6959	8499

HC5147 MOBILE HEALTHCARE CHAISE RECLINER W/ RIGHT (FACING) REMOVABLE ARM INFINITE POSITION LOCKING BACK

COM	4	5	6	7	8	9	10	11
5049	5129	5309	5569	5929	6209	6599	7049	8599

If patient transfer arm is specified on left side (facing), then handle will be placed on right side (facing) and vice versa.

DURABLE® 650 SERIES

SINGLE REMOVABLE ARM RECLINER

Options	List Price	Options	List Price
U Urethane Arm Caps*	Standard	MBB Moisture Barrier Back	\$59
W Wood Arm Caps*	\$229	MBS Moisture Barrier Seat	\$59
Z Multi Cover	Use Highest Grade	4S4 All 4" Swivel Locking Caster	\$39
S4 4" 2-Caster Lock & Steer	\$569	AHP Adjustable Head Rest Pillow	\$339
EG Edge Guard	Standard	(Requires 1 yd of fabric)	
CAL CAL TB133	See page 12	ABP Adjustable Back Pad (COM-Grade 6) 1.75yd COM	\$459
H Heat (Certified to UL 60601-1)	\$849	Adjustable Back Pad (Grade 7-11)	\$569
HM Heat & Massage (Certified to UL 60601-1)	\$1119	FBH Foley Bag Holder	\$89
HW Heat Wand (Certified to UL 60601-1)	\$1139	FT Foot Tray	\$279
HMW Heat & Massage Wand	\$1369	TE Trendelenburg	\$339
(Certified to UL 60601-1)		QR Additional Quick Release Accessory Bracket	\$69
LC LiquiCell	\$229	MR/L Right/Left Side (facing) Monitor Arm	\$629
(Standard on Heat or Heat & Massage option)		(non-removable arm only)	
		MTR/L Right/Left Side (facing) Monitor Arm with Tray	\$629
		(non-removable arm only)	
		PR1 Paper Roll Holder (takes place of push bar)	\$229

*Please refer to page 14 for finishes.

Please refer to pages 134/135 for Option descriptions & images.

Please refer to page 132 for the recliner ordering guide.



EV | Mobile Healthcare Recliners - Dual Removable Arms - 24" Seat - 650 lb Rating



E1042 | E1142*
33.5" Overall Width

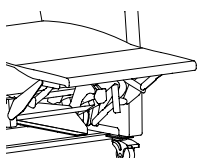

Chaise Model*
EC1042 | EC1142*

DIMENSIONS | E1042 | E1142 | EC1042 | EC1142

Width	33.5	Seat Width	24	Back Height	26
Depth	38	Seat Depth	21	Arm Height	28
Height	47	Seat Height	21.5	Weight (1042)	158
COM (Standard)	7 YDS	COM (Chaise)	8 YDS	Weight (1142)	166
Reclined Depth	76	Seat Depth (kick-out)	40	Distance from Wall	20
Weight Capacity	650 lbs.				

E1042 MOBILE HEALTHCARE RECLINER W/ DUAL REMOVABLE ARMS INFINITE POSITION NON-LOCKING BACK

COM	4	5	6	7	8	9	10	11
5209	5269	5339	5519	5759	5939	6229	6529	7849

E1142 MOBILE HEALTHCARE RECLINER W/ DUAL REMOVABLE ARMS INFINITE POSITION LOCKING BACK

COM	4	5	6	7	8	9	10	11
5859	5899	5979	6139	6379	6529	6829	7139	8419

EC1042 MOBILE HEALTHCARE CHAISE RECLINER W/ DUAL REMOVABLE ARMS INFINITE POSITION NON-LOCKING BACK

COM	4	5	6	7	8	9	10	11
5399	5489	5609	5829	6169	6409	6759	7179	8609

EC1142 MOBILE HEALTHCARE CHAISE RECLINER W/ DUAL REMOVABLE ARMS INFINITE POSITION LOCKING BACK

COM	4	5	6	7	8	9	10	11
6049	6119	6239	6459	6769	7009	7389	7789	9189

*1142 Infinite Position Locking Back Lever is located on the outside of the right (facing) arm of the recliner.

Options	List Price	Options	List Price
U Urethane Arm Caps*	Standard	CAL CAL TB133	See page 12
W Wood Arm Caps*	\$229	MBB Moisture Barrier Back	\$59
J Solid Surface Arm Caps* - Group 1	\$619 (Group 2 add \$200)	MBS Moisture Barrier Seat	\$59
Z Multi Cover	Use Highest Grade	4S4 All 4" Swivel Locking Caster	\$39
HW Heat Wand (Certified to UL 60601-1)	\$1139	AHP Adjustable Head Rest Pillow	\$339
HMW Heat & Massage Wand	\$1369	(Requires 1 yd of fabric)	
S4 4" 2-Caster Lock & Steer	\$569	ABP Adjustable Back Pad (COM-Grade 6) 1.75yd COM	\$459
Q3 3" Dual Wheel Central Locking Caster	\$1019	Adjustable Back Pad (Grade 7-11)	\$569
(Non-Directional)		FBH Foley Bag Holder	\$89
Q4 4" Central Caster Lock & Steer	\$1019	FT Foot Tray	\$279
Q5 5" Central Caster Lock & Steer	\$1139	TE Trendelenburg	\$339
EG Edge Guard	Standard	PR1 Paper Roll Holder (takes place of push bar)	\$229
		LC LiquiCell	\$229
		(Standard on Heat or Heat & Massage option)	

*Please refer to page 14 for finishes.

Please refer to pages 134/135 for Option descriptions & images.

Please refer to page 132 for the recliner ordering guide.

Rêma | Mobile Healthcare Recliners - Dual Removable Arms - 24" Seat - 650 lb Rating

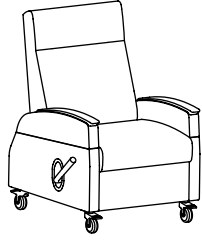

R1042 | R1142*
33.5" Overall Width

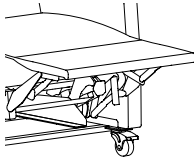

Chaise Model*
RC1042 | RC1142

DIMENSIONS | R1042 | R1142 | RC1042 | RC1142

Width	33.5	Seat Width	24	Back Height	26
Depth	38	Seat Depth	21	Arm Height	28
Height	47	Seat Height	21.5	Weight (1042)	158
COM (Standard)	7 YDS	COM (Chaise)	8 YDS	Weight (1142)	166
Reclined Depth	76	Seat Depth (kick-out)	40	Distance from Wall	20
Weight Capacity	650 lbs.				

R1042 MOBILE HEALTHCARE RECLINER W/ DUAL REMOVABLE ARMS INFINITE POSITION NON-LOCKING BACK

COM	4	5	6	7	8	9	10	11
5209	5269	5339	5519	5759	5939	6229	6529	7849

R1142 MOBILE HEALTHCARE RECLINER W/ DUAL REMOVABLE ARMS INFINITE POSITION LOCKING BACK

COM	4	5	6	7	8	9	10	11
5859	5899	5979	6139	6379	6529	6829	7139	8419

RC1042 MOBILE HEALTHCARE CHAISE RECLINER W/ DUAL REMOVABLE ARMS INFINITE POSITION NON-LOCKING BACK

COM	4	5	6	7	8	9	10	11
5399	5489	5609	5829	6169	6409	6759	7179	8609

RC1142 MOBILE HEALTHCARE CHAISE RECLINER W/ DUAL REMOVABLE ARMS INFINITE POSITION LOCKING BACK

COM	4	5	6	7	8	9	10	11
6049	6119	6239	6459	6769	7009	7389	7789	9189

*1142 Infinite Position Locking Back Lever is located on the outside of the right (facing) arm of the recliner.

Options	List Price	Options	List Price
U Urethane Arm Caps*	Standard	CAL CAL TB133	See page 12
W Wood Arm Caps*	\$229	MBB Moisture Barrier Back	\$59
J Solid Surface Arm Caps* - Group 1	\$619 (Group 2 add \$200)	MBS Moisture Barrier Seat	\$59
Z Multi Cover	Use Highest Grade	4S4 All 4" Swivel Locking Caster	\$39
HW Heat Wand (Certified to UL 60601-1)	\$1139	AHP Adjustable Head Rest Pillow	\$339
HMW Heat & Massage Wand	\$1369	(Requires 1 yd of fabric)	
		ABP Adjustable Back Pad (COM-Grade 6) 1.75yd COM	\$459
S4 4" 2-Caster Lock & Steer	\$569	Adjustable Back Pad (Grade 7-11)	\$569
Q3 3" Dual Wheel Central Locking Caster	\$1019	FBH Foley Bag Holder	\$89
(Non-Directional)		FT Foot Tray	\$279
Q4 4" Central Caster Lock & Steer	\$1019	TE Trendelenburg	\$339
Q5 5" Central Caster Lock & Steer	\$1139	PR1 Paper Roll Holder (takes place of push bar)	\$229
EG Edge Guard	Standard	LC LiquiCell	\$229
		(Standard on Heat or Heat & Massage option)	

*Please refer to page 14 for finishes.

Please refer to pages 134/135 for Option descriptions & images.

Please refer to page 132 for the recliner ordering guide.



Koncert | Mobile Healthcare Recliners - Dual Removable Arms - 24" Seat - 650 lb Rating

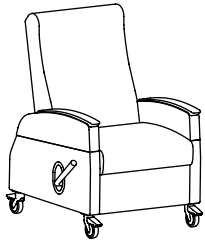

K1042 | K1142*
33.5" Overall Width

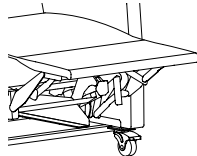

Chaise Model*
KC1042 | KC1142

DIMENSIONS | K1042 | K1142 | KC1042 | KC1142

Width	33.5	Seat Width	24	Back Height	26
Depth	38	Seat Depth	21	Arm Height	28
Height	47	Seat Height	21.5	Weight (1042)	158
COM (Standard)	7 YDS	COM (Chaise)	8 YDS	Weight (1142)	166
Reclined Depth	76	Seat Depth (kick-out)	40	Distance from Wall	20
Weight Capacity	650 lbs.				

K1042 MOBILE HEALTHCARE RECLINER W/ DUAL REMOVABLE ARMS INFINITE POSITION NON-LOCKING BACK

COM	4	5	6	7	8	9	10	11
5209	5269	5339	5519	5759	5939	6229	6529	7849

K1142 MOBILE HEALTHCARE RECLINER W/ DUAL REMOVABLE ARMS INFINITE POSITION LOCKING BACK

COM	4	5	6	7	8	9	10	11
5859	5899	5979	6139	6379	6529	6829	7139	8419

KC1042 MOBILE HEALTHCARE CHAISE RECLINER W/ DUAL REMOVABLE ARMS INFINITE POSITION NON-LOCKING BACK

COM	4	5	6	7	8	9	10	11
5399	5489	5609	5829	6169	6409	6759	7179	8609

KC1142 MOBILE HEALTHCARE CHAISE RECLINER W/ DUAL REMOVABLE ARMS INFINITE POSITION LOCKING BACK

COM	4	5	6	7	8	9	10	11
6049	6119	6239	6459	6769	7009	7389	7789	9189

*1142 Infinite Position Locking Back Lever is located on the outside of the right (facing) arm of the recliner.

Options	List Price	Options	List Price
U Urethane Arm Caps*	Standard	CAL CAL TB133	See page 12
W Wood Arm Caps*	\$229	MBB Moisture Barrier Back	\$59
J Solid Surface Arm Caps* - Group 1	\$619 (Group 2 add \$200)	MBS Moisture Barrier Seat	\$59
Z Multi Cover	Use Highest Grade	4S4 All 4" Swivel Locking Caster	\$39
HW Heat Wand (Certified to UL 60601-1)	\$1139	AHP Adjustable Head Rest Pillow	\$339
HMW Heat & Massage Wand	\$1369	(Requires 1 yd of fabric)	
(Certified to UL 60601-1)		ABP Adjustable Back Pad (COM-Grade 6) 1.75yd COM	\$459
S4 4" 2-Caster Lock & Steer	\$569	Adjustable Back Pad (Grade 7-11)	\$569
Q3 3" Dual Wheel Central Locking Caster	\$1019	FBH Foley Bag Holder	\$89
(Non-Directional)		FT Foot Tray	\$279
Q4 4" Central Caster Lock & Steer	\$1019	TE Trendelenburg	\$339
Q5 5" Central Caster Lock & Steer	\$1139	PR1 Paper Roll Holder (takes place of push bar)	\$229
EG Edge Guard	Standard	LC LiquiCell	\$229
		(Standard on Heat or Heat & Massage option)	

*Please refer to page 14 for finishes.

Please refer to pages 134/135 for Option descriptions & images.

Please refer to page 132 for the recliner ordering guide.

Durable® 750 Series

The Durable® 750 Series is the Bariatric version of our premier Durable® 650 Series of mobile healthcare recliners. Featuring a patented unitized mechanism (extending to a true flatbed position), 750 lb weight capacity, and near limitless option configurations to adapt to any environment, the Durable® 750 Series truly encapsulates our core product values of Comfort, Durability, and Performance to make it a recliner choice trusted by patients and caregivers alike. Engineered from the ground up with cleanability in mind, its removable back and lift up seat, along with the absence of entrapment areas make it a strong asset in infection control. Our legacy of Comfort combine with a passion for well-being in the Durable® 750 Series to prove beyond doubt- Comfort Heals®.



EV | Bariatric Mobile Healthcare Recliners - 29" Seat - 750 lb Weight Rating

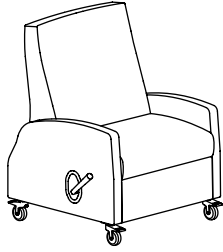

EB4037 | EB4137
36.5" Overall Width

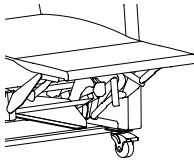

Chaise Model*
EBC4037 | EBC4137

DIMENSIONS | EB4037 | EB4137 | EBC4037 | EBC4137

Width	36.5	Seat Width	29	Back Height	26
Depth	38	Seat Depth	21	Arm Height	28
Height	47	Seat Height	21.5	Weight	162
COM (Standard)	7 YDS	COM (Chaise)	8 YDS	Weight Capacity	650 lbs.
Reclined Depth	73	Seat Depth (kick-out)	40	Distance from Wall	20

EB4037 BARIATRIC MOBILE HEALTHCARE RECLINER - INFINITE POSITION NON-LOCKING BACK - UPH ARMS

COM	4	5	6	7	8	9	10	11
4269	4369	4519	4769	5059	5349	5719	6129	7859

EB4137 BARIATRIC MOBILE HEALTHCARE RECLINER - INFINITE POSITION LOCKING BACK - UPH ARMS

COM	4	5	6	7	8	9	10	11
4669	4769	4899	5139	5449	5729	6089	6509	8219

EBC4037 BARIATRIC MOBILE HEALTHCARE CHAISE RECLINER - INFINITE POSITION NON-LOCKING BACK - UPH ARMS

COM	4	5	6	7	8	9	10	11
4469	4599	4809	5109	5489	5839	6289	6809	8809

EBC4137 BARIATRIC MOBILE HEALTHCARE CHAISE RECLINER - INFINITE POSITION LOCKING BACK - UPH ARMS

COM	4	5	6	7	8	9	10	11
4889	4999	5199	5499	5879	6219	6669	7189	9179

Options	List Price	Options	List Price
F Upholstered Arms	Standard	4S4 All 4" Swivel Locking Caster	\$39
U Urethane Arm Caps*	\$169	AHP Adjustable Head Rest Pillow (Requires 1 yd of fabric)	\$339
W Wood Arm Caps*	\$229	DP Dual IV Poles	\$498
J Solid Surface Arm Caps* - Group 1	\$619 (Group 2 add \$200)	FBH Foley Bag Holder	\$89
Z Multi Cover	Use Highest Grade	FT Foot Tray	\$279
H Heat (Certified to UL 60601-1)	\$849	IV IV Pole and Bracket	\$249
HM Heat & Massage (Certified to UL 60601-1)	\$1119	LFSTR Lg Right Side (facing) Folding Side Tray *Contact Customer Service for Solid Surface Pricing	\$249
HW Heat Wand (Certified to UL 60601-1)	\$1139	LFSTRCH Lg Right Side (facing) Folding Cup Holder Tray	\$319
HMW Heat & Massage Wand (Certified to UL 60601-1)	\$1369	PLFSTR Padded Lg Right Side (facing) Folding Side Tray (Requires 1 yd of fabric)	\$379
S4 4" 2-Caster Lock & Steer	\$569	USB Hospital Grade Power	\$459
Q3 3" Dual Wheel Central Locking Caster (Non-Directional)	\$1019	QR Additional Quick Release Accessory Bracket	\$69
Q4 4" Central Caster Lock & Steer	\$1019	SFSTR Sm Right Side (facing) Folding Side Tray *Contact Customer Service for Solid Surface Pricing	\$249
Q5 5" Central Caster Lock & Steer	\$1139	TD3 Dual Side Tray (Dual TSL1/TSR1)**	\$798
EG Edge Guard	Standard	TSL1 Left Side (facing) Tray**	\$399
CAL CAL TB133	See page 12	TSR1 Right Side (facing) Tray**	\$399
MB2B Moisture Barrier Bariatric Back	\$89	WR Wrist Restraint (per pair)	\$229
MB2S Moisture Barrier Bariatric Seat	\$89	TE-3 Trendelenburg (Bariatric)	\$459
MR/L Right/Left Side (facing) Monitor Arm	\$629	LC LiquiCell (Standard on Heat or Heat & Massage option)	\$229
MTR/L Right/Left Side (facing) Monitor Arm with Tray	\$629		
PR1 Paper Roll Holder (takes place of push bar)	\$229		

*Please refer to page 14 for finishes.

**Over the lap tray function recommended in seating position.

Please refer to pages 134/135 for Option descriptions & images.

Please refer to page 132 for the recliner ordering guide.



EV | Bariatric Mobile Healthcare Recliners - 29" Seat - 750 lb Weight Rating

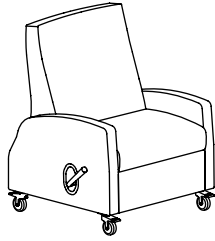

EB1037 | EB1137
38.5" Overall Width

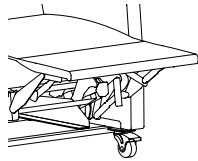

Chaise Model*
EBC1037 | EBC1137

DIMENSIONS | EB1037 | EB1137 | EBC1037 | EBC1137

Width	38.5	Seat Width	29	Back Height	26
Depth	38	Seat Depth	21	Arm Height	28
Height	47	Seat Height	21.5	Weight	162
COM (Standard)	7 YDS	COM (Chaise)	8 YDS	Weight Capacity	750 lbs.
Reclined Depth	73	Seat Depth (kick-out)	40	Distance from Wall	19

EB1037 BARIATRIC MOBILE HEALTHCARE RECLINER - INFINITE POSITION NON-LOCKING BACK - UPH ARMS

COM	4	5	6	7	8	9	10	11
4359	4419	4599	4819	5119	5399	5779	6199	7909

EB1137 BARIATRIC MOBILE HEALTHCARE RECLINER - INFINITE POSITION LOCKING BACK - UPH ARMS

COM	4	5	6	7	8	9	10	11
4739	4829	4999	5209	5509	5789	6159	6559	8279

EBC1037 BARIATRIC MOBILE HEALTHCARE CHAISE RECLINER - INFINITE POSITION NON-LOCKING BACK - UPH ARMS

COM	4	5	6	7	8	9	10	11
4549	4669	4859	5159	5539	5899	6349	6879	8879

EBC1137 BARIATRIC MOBILE HEALTHCARE CHAISE RECLINER - INFINITE POSITION LOCKING BACK - UPH ARMS

COM	4	5	6	7	8	9	10	11
4939	5069	5259	5549	5939	6279	6729	7239	9239

Options	List Price	Options	List Price
F Upholstered Arms	Standard	PR1 Paper Roll Holder (<i>takes place of push bar</i>)	\$229
U Urethane Arm Caps*	\$169	4S4 All 4" Swivel Locking Caster	\$39
W Wood Arm Caps*	\$229	AHP Adjustable Head Rest Pillow	\$339
J Solid Surface Arm Caps* - Group 1	\$619 (Group 2 add \$200)	(Requires 1 yd of fabric)	
Z Multi Cover	Use Highest Grade	DP Dual IV Poles	\$498
H Heat (Certified to UL 60601-1)	\$849	FBH Foley Bag Holder	\$89
HM Heat & Massage (Certified to UL 60601-1)	\$1119	FT Foot Tray	\$279
HW Heat Wand (Certified to UL 60601-1)	\$1139	IV IV Pole and Bracket	\$249
HMW Heat & Massage Wand	\$1369	LFSTR Lg Right Side (facing) Folding Side Tray	\$249
		<i>*Contact Customer Service for Solid Surface Pricing</i>	
S4 4" 2-Caster Lock & Steer	\$569	LFSTRCH Lg Right Side (facing) Folding Cup Holder Tray	\$319
Q3 3" Dual Wheel Central Locking Caster	\$1019	PLFSTR Padded Lg Right Side (facing) Folding Side Tray	\$379
		(Requires 1 yd of fabric)	
Q4 4" Central Caster Lock & Steer	\$1019	USB Hospital Grade Power	\$459
Q5 5" Central Caster Lock & Steer	\$1139	QR Additional Quick Release Accessory Bracket	\$69
EG Edge Guard	Standard	SFSTR Sm Right Side (facing) Folding Side Tray	\$249
CAL CAL TB133	See page 12	<i>*Contact Customer Service for Solid Surface Pricing</i>	
MB2B Moisture Barrier Bariatric Back	\$89	TD3 Dual Side Tray (Dual TSL1/TSR1)**	\$798
MB2S Moisture Barrier Bariatric Seat	\$89	TSL1 Left Side (facing) Tray**	\$399
MR/L Right/Left Side (facing) Monitor Arm	\$629	TSR1 Right Side (facing) Tray**	\$399
MTR/L Right/Left Side (facing) Monitor Arm with Tray	\$629	WR Wrist Restraint (per pair)	\$229
		TE-3 Trendelenburg (Bariatric)	\$459
		LC LiquiCell	\$229
		(Standard on Heat or Heat & Massage option)	

*Please refer to page 14 for finishes.

**Over the lap tray function recommended in seating position.

Please refer to pages 134/135 for Option descriptions & images.

Please refer to page 132 for the recliner ordering guide.



Rêma | Bariatric Mobile Healthcare Recliners - 29" Seat - 750 lb Weight Rating

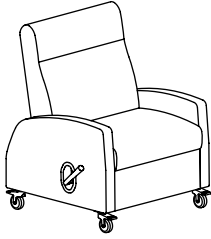

RB1037 | RB1137
38.5" Overall Width

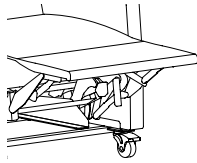

Chaise Model*
RBC1037 | RBC1137

DIMENSIONS | RB1037 | RB1137 | RBC1037 | RBC1137

Width	38.5	Seat Width	29	Back Height	26
Depth	38	Seat Depth	21	Arm Height	28
Height	47	Seat Height	21.5	Weight	162
COM (Standard)	7 YDS	COM (Chaise)	8 YDS	Weight Capacity	750 lbs.
Reclined Depth	73	Seat Depth (kick-out)	40	Distance from Wall	19

RB1037 BARIATRIC MOBILE HEALTHCARE RECLINER - INFINITE POSITION NON-LOCKING BACK - UPH ARMS

COM	4	5	6	7	8	9	10	11
4359	4419	4599	4819	5119	5399	5779	6199	7909

RB1137 BARIATRIC MOBILE HEALTHCARE RECLINER - INFINITE POSITION LOCKING BACK - UPH ARMS

COM	4	5	6	7	8	9	10	11
4739	4829	4999	5209	5509	5789	6159	6559	8279

RBC1037 BARIATRIC MOBILE HEALTHCARE CHAISE RECLINER - INFINITE POSITION NON-LOCKING BACK - UPH ARMS

COM	4	5	6	7	8	9	10	11
4549	4669	4859	5159	5539	5899	6349	6879	8879

RBC1137 BARIATRIC MOBILE HEALTHCARE CHAISE RECLINER - INFINITE POSITION LOCKING BACK - UPH ARMS

COM	4	5	6	7	8	9	10	11
4939	5069	5259	5549	5939	6279	6729	7239	9239

Options	List Price	Options	List Price
F Upholstered Arms	Standard	4S4 All 4" Swivel Locking Caster	\$39
U Urethane Arm Caps*	\$169	AHP Adjustable Head Rest Pillow (Requires 1 yd of fabric)	\$339
W Wood Arm Caps*	\$229	DP Dual IV Poles	\$498
J Solid Surface Arm Caps* - Group 1	\$619 (Group 2 add \$200)	FBH Foley Bag Holder	\$89
Z Multi Cover	Use Highest Grade	FT Foot Tray	\$279
H Heat (Certified to UL 60601-1)	\$849	IV IV Pole and Bracket	\$249
HM Heat & Massage (Certified to UL 60601-1)	\$1119	LFSTR Lg Right Side (facing) Folding Side Tray *Contact Customer Service for Solid Surface Pricing	\$249
HW Heat Wand (Certified to UL 60601-1)	\$1139	LFSTRCH Lg Right Side (facing) Folding Cup Holder Tray	\$319
HMW Heat & Massage Wand (Certified to UL 60601-1)	\$1369	PLFSTR Padded Lg Right Side (facing) Folding Side Tray (Requires 1 yd of fabric)	\$379
S4 4" 2-Caster Lock & Steer	\$569	USB Hospital Grade Power	\$459
Q3 3" Dual Wheel Central Locking Caster (Non-Directional)	\$1019	QR Additional Quick Release Accessory Bracket	\$69
Q4 4" Central Caster Lock & Steer	\$1019	SFSTR Sm Right Side (facing) Folding Side Tray *Contact Customer Service for Solid Surface Pricing	\$249
Q5 5" Central Caster Lock & Steer	\$1139	TD3 Dual Side Tray (Dual TSL1/TSR1)**	\$798
EG Edge Guard	Standard	TSL1 Left Side (facing) Tray**	\$399
CAL CAL TB133	See page 12	TSR1 Right Side (facing) Tray**	\$399
MB2B Moisture Barrier Bariatric Back	\$89	WR Wrist Restraint (per pair)	\$229
MB2S Moisture Barrier Bariatric Seat	\$89	TE-3 Trendelenburg (Bariatric)	\$459
MR/L Right/Left Side (facing) Monitor Arm	\$629	LC LiquiCell	\$229
MTR/L Right/Left Side (facing) Monitor Arm with Tray	\$629		
PR1 Paper Roll Holder (takes place of push bar)	\$229		

*Please refer to page 14 for finishes.

**Over the lap tray function recommended in seating position.

Please refer to pages 134/135 for Option descriptions & images.

Please refer to page 132 for the recliner ordering guide.



Koncert | Bariatric Mobile Healthcare Recliners - 29" Seat - 750 lb Weight Rating

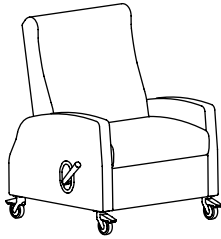

KB1037 | KB1137
38.5" Overall Width

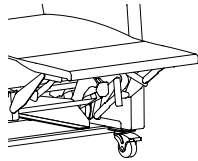

Chaise Model*
KBC1037 | KBC1137

DIMENSIONS | KB1037 | KB1137 | KBC1037 | KBC1137

Width	38.5	Seat Width	29	Back Height	26
Depth	38	Seat Depth	21	Arm Height	28
Height	47	Seat Height	21.5	Weight	162
COM (Standard)	7 YDS	COM (Chaise)	8 YDS	Weight Capacity	750 lbs.
Reclined Depth	73	Seat Depth (kick-out)	40	Distance from Wall	19

KB1037 BARIATRIC MOBILE HEALTHCARE RECLINER - INFINITE POSITION NON-LOCKING BACK - UPH ARMS

COM	4	5	6	7	8	9	10	11
4359	4419	4599	4819	5119	5399	5779	6199	7909

KB1137 BARIATRIC MOBILE HEALTHCARE RECLINER - INFINITE POSITION LOCKING BACK - UPH ARMS

COM	4	5	6	7	8	9	10	11
4739	4829	4999	5209	5509	5789	6159	6559	8279

KBC1037 BARIATRIC MOBILE HEALTHCARE CHAISE RECLINER - INFINITE POSITION NON-LOCKING BACK - UPH ARMS

COM	4	5	6	7	8	9	10	11
4549	4669	4859	5159	5539	5899	6349	6879	8879

KBC1137 BARIATRIC MOBILE HEALTHCARE CHAISE RECLINER - INFINITE POSITION LOCKING BACK - UPH ARMS

COM	4	5	6	7	8	9	10	11
4939	5069	5259	5549	5939	6279	6729	7239	9239

Options	List Price	Options	List Price
F Upholstered Arms	Standard	PR1 Paper Roll Holder (takes place of push bar)	\$229
U Urethane Arm Caps*	\$169	4S4 All 4" Swivel Locking Caster	\$39
W Wood Arm Caps*	\$229	AHP Adjustable Head Rest Pillow (Requires 1 yd of fabric)	\$339
J Solid Surface Arm Caps* - Group 1	\$619 (Group 2 add \$200)	DP Dual IV Poles	\$498
Z Multi Cover	Use Highest Grade	FBH Foley Bag Holder	\$89
H Heat (Certified to UL 60601-1)	\$849	FT Foot Tray	\$279
HM Heat & Massage (Certified to UL 60601-1)	\$1119	IV IV Pole and Bracket	\$249
HW Heat Wand (Certified to UL 60601-1)	\$1139	LFSTR Lg Right Side (facing) Folding Side Tray	\$249
HMW Heat & Massage Wand (Certified to UL 60601-1)	\$1369	*Contact Customer Service for Solid Surface Pricing	
S4 4" 2-Caster Lock & Steer	\$569	LFSTRCH Lg Right Side (facing) Folding Cup Holder Tray	\$319
Q3 3" Dual Wheel Central Locking Caster (Non-Directional)	\$1019	PLFSTR Padded Lg Right Side (facing) Folding Side Tray (Requires 1 yd of fabric)	\$379
Q4 4" Central Caster Lock & Steer	\$1019	USB Hospital Grade Power	\$459
Q5 5" Central Caster Lock & Steer	\$1139	QR Additional Quick Release Accessory Bracket	\$69
EG Edge Guard	Standard	SFSTR Sm Right Side (facing) Folding Side Tray	\$249
CAL CAL TB133	See page 12	*Contact Customer Service for Solid Surface Pricing	
MB2B Moisture Barrier Bariatric Back	\$89	TD3 Dual Side Tray (Dual TSL1/TSR1)**	\$798
MB2S Moisture Barrier Bariatric Seat	\$89	TSL1 Left Side (facing) Tray**	\$399
MR/L Right/Left Side (facing) Monitor Arm	\$629	TSR1 Right Side (facing) Tray**	\$399
MTR/L Right/Left Side (facing) Monitor Arm with Tray	\$629	WR Wrist Restraint (per pair)	\$229
*Please refer to page 14 for finishes.		TE-3 Trendelenburg (Bariatric)	\$459
**Over the lap tray function recommended in seating position.		LC LiquiCell	\$229
Please refer to pages 134/135 for Option descriptions & images.		(Standard on Heat or Heat & Massage option)	
Please refer to page 132 for the recliner ordering guide.			



Kadia Mod | Bariatric Mobile Healthcare Recliners - 29" Seat - 750 lb Weight Rating

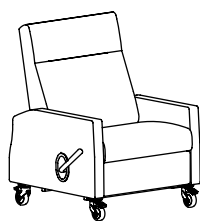

KMB1037 | KMB1137
38.5" Overall Width

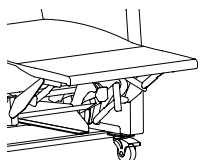

Chaise Model*
KMBC1037 | KMBC1137

DIMENSIONS | KMB1037 | KMB1137 | KMBC1037 | KMBC1137

Width	38.5	Seat Width	29	Back Height	26
Depth	38	Seat Depth	21	Arm Height	28
Height	47	Seat Height	21.5	Weight (1037)	162
COM (Standard)	7 YDS	COM (Chaise)	8 YDS	Weight (1137)	170
Reclined Depth	73	Seat Depth (kick-out)	40	Distance from Wall	19
Weight Capacity	750 lbs.				

KMB1037 BARIATRIC MOBILE HEALTHCARE RECLINER - INFINITE POSITION NON-LOCKING BACK - UPH ARMS

COM	4	5	6	7	8	9	10	11
4359	4419	4599	4819	5119	5399	5779	6199	7909

KMB1137 BARIATRIC MOBILE HEALTHCARE RECLINER - INFINITE POSITION LOCKING BACK - UPH ARMS

COM	4	5	6	7	8	9	10	11
4739	4829	4999	5209	5509	5789	6159	6559	8279

KMBC1037 BARIATRIC MOBILE HEALTHCARE CHAISE RECLINER - INFINITE POSITION NON-LOCKING BACK - UPH ARMS

COM	4	5	6	7	8	9	10	11
4549	4669	4859	5159	5539	5899	6349	6879	8879

KMBC1137 BARIATRIC MOBILE HEALTHCARE CHAISE RECLINER - INFINITE POSITION LOCKING BACK - UPH ARMS

COM	4	5	6	7	8	9	10	11
4939	5069	5259	5549	5939	6279	6729	7239	9239

Options	List Price	Options	List Price
F Upholstered Arms	Standard	4S4 All 4" Swivel Locking Caster	\$39
U Urethane Arm Caps*	\$169	AHP Adjustable Head Rest Pillow (Requires 1 yd of fabric)	\$339
W Wood Arm Caps*	\$229	DP Dual IV Poles	\$498
J Solid Surface Arm Caps* - Group 1	\$619 (Group 2 add \$200)	FBH Foley Bag Holder	\$89
Z Multi Cover	Use Highest Grade	FT Foot Tray	\$279
H Heat (Certified to UL 60601-1)	\$849	IV IV Pole and Bracket	\$249
HM Heat & Massage (Certified to UL 60601-1)	\$1119	LFSTR Lg Right Side (facing) Folding Side Tray *Contact Customer Service for Solid Surface Pricing	\$249
HW Heat Wand (Certified to UL 60601-1)	\$1139	LFSTRCH Lg Right Side (facing) Folding Cup Holder Tray	\$319
HMW Heat & Massage Wand (Certified to UL 60601-1)	\$1369	PLFSTR Padded Lg Right Side (facing) Folding Side Tray (Requires 1 yd of fabric)	\$379
S4 4" 2-Caster Lock & Steer	\$569	USB Hospital Grade Power	\$459
Q3 3" Dual Wheel Central Locking Caster (Non-Directional)	\$1019	QR Additional Quick Release Accessory Bracket	\$69
Q4 4" Central Caster Lock & Steer	\$1019	SFSTR Sm Right Side (facing) Folding Side Tray *Contact Customer Service for Solid Surface Pricing	\$249
Q5 5" Central Caster Lock & Steer	\$1139	TD3 Dual Side Tray (Dual TSL1/TSR1)**	\$798
EG Edge Guard	Standard	TSL1 Left Side (facing) Tray**	\$399
CAL CAL TB133	See page 12	TSR1 Right Side (facing) Tray**	\$399
MB2B Moisture Barrier Bariatric Back	\$89	WR Wrist Restraint (per pair)	\$229
MB2S Moisture Barrier Bariatric Seat	\$89	TE-3 Trendelenburg (Bariatric)	\$459
MR/L Right/Left Side (facing) Monitor Arm	\$629	LC LiquiCell (Standard on Heat or Heat & Massage option)	\$229
MTR/L Right/Left Side (facing) Monitor Arm with Tray	\$629		
PR1 Paper Roll Holder (takes place of push bar)	\$229		

*Please refer to page 14 for finishes.

**Over the lap tray function recommended in seating position.

Please refer to pages 134/135 for Option descriptions & images.

Please refer to page 132 for the recliner ordering guide.



Harmony | Bariatric Mobile Healthcare Recliners - 29" Seat - 750 lb Weight Rating

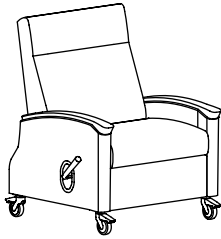

H5037 | H5137
39" Overall Width

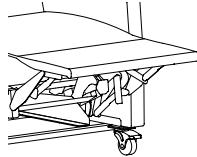

Chaise Model*
HC5037 | HC5137

DIMENSIONS | H5037 | H5137 | HC5037 | HC5137

Width	39	Seat Width	29	Back Height	26
Depth	38	Seat Depth	21	Arm Height	28
Height	47	Seat Height	21.5	Weight	162
COM	7 YDS	Seat Depth (kick-out)	40	Weight Capacity	750 lbs.
Reclined Depth	73	Distance from Wall	19		

H5037 BARIATRIC MOBILE HEALTHCARE RECLINER - INFINITE POSITION NON-LOCKING BACK - URETHANE ARM CAPS

COM	4	5	6	7	8	9	10	11
4549	4619	4799	5029	5309	5589	5969	6369	8099

H5137 BARIATRIC MOBILE HEALTHCARE RECLINER - INFINITE POSITION LOCKING BACK - URETHANE ARM CAPS

COM	4	5	6	7	8	9	10	11
4939	5019	5189	5419	5709	5969	6349	6749	8449

HC5037 BARIATRIC MOBILE HEALTHCARE CHAISE RECLINER - INFINITE POSITION NON-LOCKING BACK - URETHANE ARM CAPS

COM	4	5	6	7	8	9	10	11
4779	4879	5089	5399	5769	6129	6579	7109	8959

HC5137 BARIATRIC MOBILE HEALTHCARE CHAISE RECLINER - INFINITE POSITION LOCKING BACK - URETHANE ARM CAPS

COM	4	5	6	7	8	9	10	11
5169	5279	5489	5799	6169	6499	6959	7479	9299

Options	List Price	Options	List Price
U Urethane Arm Caps*	Standard	DP Dual IV Poles	\$498
W Wood Arm Caps*	\$229	FBH Foley Bag Holder	\$89
Z Multi Cover	Use Highest Grade	FT Foot Tray	\$279
H Heat (Certified to UL 60601-1)	\$849	IV IV Pole and Bracket	\$249
HM Heat & Massage (Certified to UL 60601-1)	\$1119	LFSTR Lg Right Side (facing) Folding Side Tray	\$249
HW Heat Wand (Certified to UL 60601-1)	\$1139	<i>*Contact Customer Service for Solid Surface Pricing</i>	
HMW Heat & Massage Wand	\$1369	LFSTRCH Lg Right Side (facing) Folding Cup Holder Tray	\$319
S4 4" 2-Caster Lock & Steer	\$569	PLFSTR Padded Lg Right Side (facing) Folding Side Tray	\$379
EG Edge Guard	Standard	(Requires 1 yd of fabric)	
CAL CAL TB133	See page 12	USB Hospital Grade Power	\$459
MB2B Moisture Barrier Bariatric Back	\$89	QR Additional Quick Release Accessory Bracket	\$69
MB2S Moisture Barrier Bariatric Seat	\$89	SFSTR Sm Right Side (facing) Folding Side Tray	\$249
4S4 All 4" Swivel Locking Caster	\$39	<i>*Contact Customer Service for Solid Surface Pricing</i>	
AHP Adjustable Head Rest Pillow	\$339	TD3 Dual Side Tray (Dual TSL1/TSR1)**	\$798
LC LiquiCell	\$229	TSL1 Left Side (facing) Tray**	\$399
		TSR1 Right Side (facing) Tray**	\$399
(Standard on Heat or Heat & Massage option)		WR Wrist Restraint (per pair)	\$229
		TE-3 Trendelenburg (Bariatric)	\$459
		MR/L Right/Left Side (facing) Monitor Arm	\$629
		MTR/L Right/Left Side (facing) Monitor Arm with Tray	\$629
		PR1 Paper Roll Holder (takes place of push bar)	\$229

*Please refer to page 14 for finishes.

**Over the lap tray function recommended in seating position.

Please refer to pages 134/135 for Option descriptions & images.

Please refer to page 132 for the recliner ordering guide.



EV | Bariatric Mobile Healthcare Recliners - Patient Transfer Arm - 29" Seat - 750 lb Rating

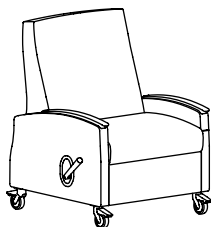

EB4067 | EB4167
36.5" Overall Width

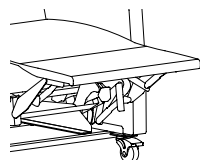

Chaise Model*
EBC4067 | EBC4167

DIMENSIONS | EB4067 | EB4167 | EBC4067 | EBC4167

Width	36.5	Seat Width	29	Back Height	26
Depth	38	Seat Depth	21	Arm Height	28
Height	47	Seat Height	21.5	Weight	162
COM (Standard)	8 YDS	COM (Chaise)	9 YDS	Weight Capacity	750 lbs.
Reclined Depth	73	Seat Depth (kick-out)	40	Distance from Wall	19

EB4067 BARIATRIC MOBILE HEALTHCARE RECLINER - RIGHT (FACING) FOLD DOWN ARM INFINITE POSITION NON-LOCKING BACK

COM	4	5	6	7	8	9	10	11
5369	5429	5579	5799	6109	6359	6739	7159	8819

EB4167 BARIATRIC MOBILE HEALTHCARE RECLINER - RIGHT (FACING) FOLD DOWN ARM INFINITE POSITION LOCKING BACK

COM	4	5	6	7	8	9	10	11
5769	5819	5979	6189	6479	6739	7119	7519	9189

EBC4067 BARIATRIC MOBILE HEALTHCARE CHAISE RECLINER - RIGHT (FACING) FOLD DOWN ARM INFINITE POSITION NON-LOCKING BACK

COM	4	5	6	7	8	9	10	11
5549	5669	5859	6159	6519	6859	7309	7829	9779

EBC4167 BARIATRIC MOBILE HEALTHCARE CHAISE RECLINER - RIGHT (FACING) FOLD DOWN ARM INFINITE POSITION LOCKING BACK

COM	4	5	6	7	8	9	10	11
5959	6069	6259	6519	6919	7229	7689	8209	10149

If patient transfer arm is specified on left side (facing), then handle will be placed on right side (facing) and vice versa.

Options	List Price	Options	List Price
U Urethane Arm Caps*	Standard	HC Hinge Cover	Standard
W Wood Arm Caps*	\$229	CAL CAL TB133	See page 12
J Solid Surface Arm Caps* - Group 1	\$619 (Group 2 add \$200)	MB2B Moisture Barrier Bariatric Back	\$89
Z Multi Cover	Use Highest Grade	MB2S Moisture Barrier Bariatric Seat	\$89
H Heat (Certified to UL 60601-1)	\$849	4S4 All 4" Swivel Locking Caster	\$39
HM Heat & Massage (Certified to UL 60601-1)	\$1119	AHP Adjustable Head Rest Pillow	\$339
HW Heat Wand (Certified to UL 60601-1)	\$1139	(Requires 1 yd of fabric)	
HMW Heat & Massage Wand	\$1369	FBH Foley Bag Holder	\$89
(Certified to UL 60601-1)		FT Foot Tray	\$279
S4 4" 2-Caster Lock & Steer	\$569	IV IV Pole and Bracket	\$249
Q3 3" Dual Wheel Central Locking Caster	\$1019	WR Wrist Restraint (per pair)	\$229
(Non-Directional)		USB Hospital Grade Power	\$459
Q4 4" Central Caster Lock & Steer	\$1019	QR Additional Quick Release Accessory Bracket	\$69
Q5 5" Central Caster Lock & Steer	\$1139	MR/L Right/Left Side (facing) Monitor Arm	\$629
EG Edge Guard	Standard	(non-fold down arm only)	
PR1 Paper Roll Holder (takes place of push bar)	\$229	MTR/L Right/Left Side (facing) Monitor Arm with Tray	\$629
		(non-fold down arm only)	
		TE-3 Trendelenburg (Bariatric)	\$459
		LC LiquiCell	\$229
		(Standard on Heat or Heat & Massage option)	

*Please refer to page 14 for finishes.

Please refer to pages 134/135 for Option descriptions & images.

Please refer to page 132 for the recliner ordering guide.

EV | Bariatric Mobile Healthcare Recliners - Patient Transfer Arm - 29" Seat - 750 lb Rating

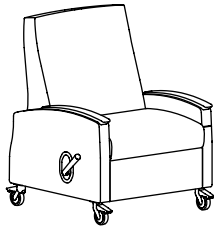

EB1067 | EB1167
38.5" Overall Width

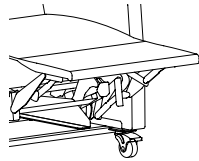

Chaise Model*
EBC1067 | EBC1167

DIMENSIONS | EB1067 | EB1167 | EBC1067 | EBC1167

Width	38.5	Seat Width	29	Back Height	26
Depth	38	Seat Depth	21	Arm Height	28
Height	47	Seat Height	21.5	Weight	162
COM (Standard)	8 YDS	COM (Chaise)	9 YDS	Weight Capacity	750 lbs.
Reclined Depth	73	Seat Depth (kick-out)	40	Distance from Wall	19

EB1067 BARIATRIC MOBILE HEALTHCARE RECLINER - RIGHT (FACING) FOLD DOWN ARM INFINITE POSITION NON-LOCKING BACK

COM	4	5	6	7	8	9	10	11
5239	5299	5469	5669	5979	6249	6629	7009	8699

EB1167 BARIATRIC MOBILE HEALTHCARE RECLINER - RIGHT (FACING) FOLD DOWN ARM INFINITE POSITION LOCKING BACK

COM	4	5	6	7	8	9	10	11
5649	5679	5839	6039	6369	6629	6999	7389	9049

EBC1067 BARIATRIC MOBILE HEALTHCARE CHAISE RECLINER - RIGHT(FACING) FOLD DOWN ARM INFINITE POSITION NON-LOCKING BACK

COM	4	5	6	7	8	9	10	11
5429	5539	5729	6009	6409	6729	7189	7699	9669

EBC1167 BARIATRIC MOBILE HEALTHCARE CHAISE RECLINER - RIGHT (FACING) FOLD DOWN ARM INFINITE POSITION LOCKING BACK

COM	4	5	6	7	8	9	10	11
5819	5939	6109	6409	6769	7109	7579	8059	10009

If patient transfer arm is specified on left side (facing), then handle will be placed on right side (facing) and vice versa.

Options	List Price	Options	List Price
U Urethane Arm Caps*	Standard	HC Hinge Cover	Standard
W Wood Arm Caps*	\$229	CAL CAL TB133	See page 12
J Solid Surface Arm Caps* - Group 1	\$619 (Group 2 add \$200)	MB2B Moisture Barrier Bariatric Back	\$89
Z Multi Cover	Use Highest Grade	MB2S Moisture Barrier Bariatric Seat	\$89
H Heat (Certified to UL 60601-1)	\$849	4S4 All 4" Swivel Locking Caster	\$39
HM Heat & Massage (Certified to UL 60601-1)	\$1119	AHP Adjustable Head Rest Pillow	\$339
HW Heat Wand (Certified to UL 60601-1)	\$1139	(Requires 1 yd of fabric)	
HMW Heat & Massage Wand	\$1369	FBH Foley Bag Holder	\$89
(Certified to UL 60601-1)		FT Foot Tray	\$279
S4 4" 2-Caster Lock & Steer	\$569	IV IV Pole and Bracket	\$249
Q3 3" Dual Wheel Central Locking Caster	\$1019	WR Wrist Restraint (per pair)	\$229
(Non-Directional)		USB Hospital Grade Power	\$459
Q4 4" Central Caster Lock & Steer	\$1019	QR Additional Quick Release Accessory Bracket	\$69
Q5 5" Central Caster Lock & Steer	\$1139	MR/L Right/Left Side (facing) Monitor Arm	\$629
EG Edge Guard	Standard	(non-fold down arm only)	
PR1 Paper Roll Holder (takes place of push bar)	\$229	MTR/L Right/Left Side (facing) Monitor Arm with Tray	\$629
		(non-fold down arm only)	
		TE-3 Trendelenburg (Bariatric)	\$459
		LC LiquiCell	\$229
		(Standard on Heat or Heat & Massage option)	

*Please refer to page 14 for finishes.

Please refer to pages 134/135 for Option descriptions & images.

Please refer to page 132 for the recliner ordering guide.



Rêma | Bariatric Mobile Healthcare Recliners - Patient Transfer Arm - 29" Seat - 750 lb Rating

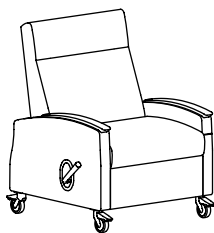

RB1067 | RB1167
38.5" Overall Width

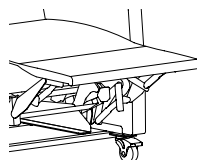

Chaise Model*
RBC1067 | RBC1167

DIMENSIONS | RB1067 | RB1167 | RBC1067 | RBC1167

Width	38.5	Seat Width	29	Back Height	26
Depth	38	Seat Depth	21	Arm Height	28
Height	47	Seat Height	21.5	Weight	162
COM (Standard)	8 YDS	COM (Chaise)	9 YDS	Weight Capacity	750 lbs.
Reclined Depth	73	Seat Depth (kick-out)	40	Distance from Wall	19

RB1067 BARIATRIC MOBILE HEALTHCARE RECLINER - RIGHT (FACING) FOLD DOWN ARM INFINITE POSITION NON-LOCKING BACK

COM	4	5	6	7	8	9	10	11
5239	5299	5469	5669	5979	6249	6629	7009	8699

RB1167 BARIATRIC MOBILE HEALTHCARE RECLINER - RIGHT (FACING) FOLD DOWN ARM INFINITE POSITION LOCKING BACK

COM	4	5	6	7	8	9	10	11
5649	5679	5839	6039	6369	6629	6999	7389	9049

RBC1067 BARIATRIC MOBILE HEALTHCARE CHAISE RECLINER - RIGHT FOLD DOWN ARM INFINITE POSITION NON-LOCKING BACK

COM	4	5	6	7	8	9	10	11
5429	5539	5729	6009	6409	6729	7189	7699	9669

RBC1167 BARIATRIC MOBILE HEALTHCARE CHAISE RECLINER - RIGHT (FACING) FOLD DOWN ARM INFINITE POSITION LOCKING BACK

COM	4	5	6	7	8	9	10	11
5819	5939	6109	6409	6769	7109	7579	8059	10009

If patient transfer arm is specified on left side (facing), then handle will be placed on right side (facing) and vice versa.

Options	List Price	Options	List Price
U Urethane Arm Caps*	Standard	HC Hinge Cover	Standard
W Wood Arm Caps*	\$229	CAL CAL TB133	See page 12
J Solid Surface Arm Caps* - Group 1	\$619 (Group 2 add \$200)	MB2B Moisture Barrier Bariatric Back	\$89
Z Multi Cover	Use Highest Grade	MB2S Moisture Barrier Bariatric Seat	\$89
H Heat (Certified to UL 60601-1)	\$849	4S4 All 4" Swivel Locking Caster	\$39
HM Heat & Massage (Certified to UL 60601-1)	\$1119	AHP Adjustable Head Rest Pillow	\$339
HW Heat Wand (Certified to UL 60601-1)	\$1139	(Requires 1 yd of fabric)	
HMW Heat & Massage Wand	\$1369	FBH Foley Bag Holder	\$89
(Certified to UL 60601-1)		FT Foot Tray	\$279
S4 4" 2-Caster Lock & Steer	\$569	IV IV Pole and Bracket	\$249
Q3 3" Dual Wheel Central Locking Caster	\$1019	WR Wrist Restraint (per pair)	\$229
(Non-Directional)		USB Hospital Grade Power	\$459
Q4 4" Central Caster Lock & Steer	\$1019	QR Additional Quick Release Accessory Bracket	\$69
Q5 5" Central Caster Lock & Steer	\$1139	MR/L Right/Left Side (facing) Monitor Arm	\$629
EG Edge Guard	Standard	(non-fold down arm only)	
PR1 Paper Roll Holder (takes place of push bar)	\$229	MTR/L Right/Left Side (facing) Monitor Arm with Tray	\$629
		(non-fold down arm only)	
		TE-3 Trendelenburg (Bariatric)	\$459
		LC LiquiCell	\$229
		(Standard on Heat or Heat & Massage option)	

*Please refer to page 14 for finishes.

Please refer to pages 134/135 for Option descriptions & images.

Please refer to page 132 for the recliner ordering guide.

Koncert | Bariatric Mobile Healthcare Recliners - Patient Transfer Arm - 29" Seat - 750 lb Rating

DURABLE® 750 SERIES

BARIATRIC MOBILE HEALTHCARE RECLINER

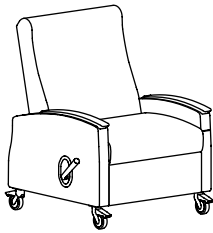

KB1067 | KB1167
38.5" Overall Width

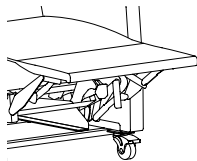

Chaise Model*
KBC1067 | KBC1167

DIMENSIONS | KB1067 | KB1167 | KBC1067 | KBC1167

Width	38.5	Seat Width	29	Back Height	26
Depth	38	Seat Depth	21	Arm Height	28
Height	47	Seat Height	21.5	Weight	162
COM (Standard)	8 YDS	COM (Chaise)	9 YDS	Weight Capacity	750 lbs.
Reclined Depth	73	Seat Depth (kick-out)	40	Distance from Wall	19

KB1067 BARIATRIC MOBILE HEALTHCARE RECLINER - RIGHT (FACING) FOLD DOWN ARM INFINITE POSITION NON-LOCKING BACK

COM	4	5	6	7	8	9	10	11
5239	5299	5469	5669	5979	6249	6629	7009	8699

KB1167 BARIATRIC MOBILE HEALTHCARE RECLINER - RIGHT (FACING) FOLD DOWN ARM INFINITE POSITION LOCKING BACK

COM	4	5	6	7	8	9	10	11
5649	5679	5839	6039	6369	6629	6999	7389	9049

KBC1067 BARIATRIC MOBILE HEALTHCARE CHAISE RECLINER - RIGHT (FACING) FOLD DOWN ARM INFINITE POSITION NON-LOCKING BACK

COM	4	5	6	7	8	9	10	11
5429	5539	5729	6009	6409	6729	7189	7699	9669

KBC1167 BARIATRIC MOBILE HEALTHCARE CHAISE RECLINER - RIGHT (FACING) FOLD DOWN ARM INFINITE POSITION LOCKING BACK

COM	4	5	6	7	8	9	10	11
5819	5939	6109	6409	6769	7109	7579	8059	10009

If patient transfer arm is specified on left side (facing), then handle will be placed on right side (facing) and vice versa.

Options	List Price	Options	List Price
U Urethane Arm Caps*	Standard	HC Hinge Cover	Standard
W Wood Arm Caps*	\$229	CAL CAL TB133	See page 12
J Solid Surface Arm Caps* - Group 1	\$619 (Group 2 add \$200)	MB2B Moisture Barrier Bariatric Back	\$89
Z Multi Cover	Use Highest Grade	MB2S Moisture Barrier Bariatric Seat	\$89
H Heat (Certified to UL 60601-1)	\$849	4S4 All 4" Swivel Locking Caster	\$39
HM Heat & Massage (Certified to UL 60601-1)	\$1119	AHP Adjustable Head Rest Pillow	\$339
HW Heat Wand (Certified to UL 60601-1)	\$1139	(Requires 1 yd of fabric)	
HMW Heat & Massage Wand	\$1369	FBH Foley Bag Holder	\$89
(Certified to UL 60601-1)		FT Foot Tray	\$279
S4 4" 2-Caster Lock & Steer	\$569	IV IV Pole and Bracket	\$249
Q3 3" Dual Wheel Central Locking Caster	\$1019	WR Wrist Restraint (per pair)	\$229
(Non-Directional)		USB Hospital Grade Power	\$459
Q4 4" Central Caster Lock & Steer	\$1019	QR Additional Quick Release Accessory Bracket	\$69
Q5 5" Central Caster Lock & Steer	\$1139	MR/L Right/Left Side (facing) Monitor Arm	\$629
EG Edge Guard	Standard	(non-fold down arm only)	
PR1 Paper Roll Holder (takes place of push bar)	\$229	MTR/L Right/Left Side (facing) Monitor Arm with Tray	\$629
		(non-fold down arm only)	
		TE-3 Trendelenburg (Bariatric)	\$459
		LC LiquiCell	\$229
		(Standard on Heat or Heat & Massage option)	

*Please refer to page 14 for finishes.

Please refer to pages 134/132 for Option descriptions & images.

Please refer to page 132 for the recliner ordering guide.



Kadia Mod | Bariatric Mobile Healthcare Recliners - Patient Transfer Arm - 29" Seat - 750 lb Rating

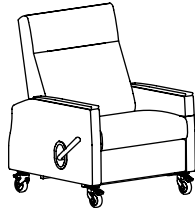

KMB1067 | KMB1167
38.5" Overall Width

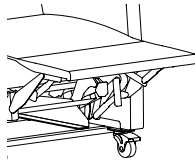

Chaise Model*
KMBC1067 | KMBC1167

DIMENSIONS | KMB1067 | KMB1167 | KMBC1067 | KMBC1167

Width	38.5	Seat Width	29	Back Height	26
Depth	38	Seat Depth	21	Arm Height	28
Height	47	Seat Height	21.5	Weight	162
COM (Standard)	8 YDS	COM (Chaise)	9 YDS	Weight Capacity	750 lbs.

KMB1067 BARIATRIC MOBILE HEALTHCARE RECLINER - RIGHT (FACING) FOLD DOWN ARM INFINITE POSITION NON-LOCKING BACK

COM	4	5	6	7	8	9	10	11
5239	5299	5469	5669	5979	6249	6629	7009	8699

KMB1167 BARIATRIC MOBILE HEALTHCARE RECLINER - RIGHT (FACING) FOLD DOWN ARM INFINITE POSITION LOCKING BACK

COM	4	5	6	7	8	9	10	11
5649	5679	5839	6039	6369	6629	6999	7389	9049

KMBC1067 BARIATRIC MOBILE HEALTHCARE CHAISE RECLINER - RIGHT (FACING) FOLD DOWN ARM INFINITE POSITION NON-LOCKING BACK

COM	4	5	6	7	8	9	10	11
5429	5539	5729	6009	6409	6729	7189	7699	9669

KMBC1167 BARIATRIC MOBILE HEALTHCARE CHAISE RECLINER - RIGHT (FACING) FOLD DOWN ARM INFINITE POSITION LOCKING BACK

COM	4	5	6	7	8	9	10	11
5819	5939	6109	6409	6769	7109	7579	8059	10009

If patient transfer arm is specified on left side (facing), then handle will be placed on right side (facing) and vice versa.

Options	List Price	Options	List Price
U Urethane Arm Caps*	Standard	HC Hinge Cover	Standard
W Wood Arm Caps*	\$229	CAL CAL TB133	See page 12
J Solid Surface Arm Caps* - Group 1	\$619 (Group 2 add \$200)	MB2B Moisture Barrier Bariatric Back	\$89
Z Multi Cover	Use Highest Grade	MB2S Moisture Barrier Bariatric Seat	\$89
H Heat (Certified to UL 60601-1)	\$849	4S4 All 4" Swivel Locking Caster	\$39
HM Heat & Massage (Certified to UL 60601-1)	\$1119	AHP Adjustable Head Rest Pillow	\$339
HW Heat Wand (Certified to UL 60601-1)	\$1139	(Requires 1 yd of fabric)	
HMW Heat & Massage Wand	\$1369	FBH Foley Bag Holder	\$89
(Certified to UL 60601-1)		FT Foot Tray	\$279
S4 4" 2-Caster Lock & Steer	\$569	IV IV Pole and Bracket	\$249
Q3 3" Dual Wheel Central Locking Caster	\$1019	WR Wrist Restraint (per pair)	\$229
(Non-Directional)		USB Hospital Grade Power	\$459
Q4 4" Central Caster Lock & Steer	\$1019	QR Additional Quick Release Accessory Bracket	\$69
Q5 5" Central Caster Lock & Steer	\$1139	MR/L Right/Left Side (facing) Monitor Arm	\$629
EG Edge Guard	Standard	(non-fold down arm only)	
PR1 Paper Roll Holder (takes place of push bar)	\$229	MTR/L Right/Left Side (facing) Monitor Arm with Tray	\$629
		(non-fold down arm only)	
		TE-3 Trendelenburg (Bariatric)	\$459
		LC LiquiCell	\$229
		(Standard on Heat or Heat & Massage option)	

*Please refer to page 14 for finishes.

Please refer to pages 134/135 for Option descriptions & images.

Please refer to page 132 for the recliner ordering guide.



Harmony | Bariatric Mobile Healthcare Recliners - Removable Arm - 29" Seat - 750 lb Rating

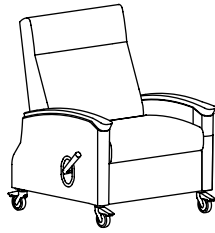

H5057 | H5157
39" Overall Width

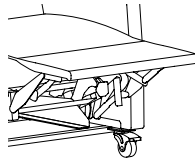

Chaise Model
HC5057 | HC5157

DIMENSIONS | H5057 | H5157 | HC5057 | HC5157

Width	39	Seat Width	29	Back Height	26
Depth	38	Seat Depth	21	Arm Height	28
Height	47	Seat Height	21.5	Weight	169
COM (Standard)	8 YDS	Seat Depth (kick-out)	40	Weight Capacity	750 lbs.
Reclined Depth	73	Distance from Wall	19		

H5057 BARIATRIC MOBILE HEALTHCARE RECLINER - REMOVABLE RIGHT (FACING) ARM INFINITE POSITION NON-LOCKING BACK

COM	4	5	6	7	8	9	10	11
4979	5129	5299	5609	6009	6359	6819	7379	9039

H5157 BARIATRIC MOBILE HEALTHCARE RECLINER - REMOVABLE RIGHT (FACING) ARM INFINITE POSITION LOCKING BACK

COM	4	5	6	7	8	9	10	11
5389	5529	5699	5999	6409	6739	7189	7749	9399

HC5057 BARIATRIC MOBILE HEALTHCARE CHAISE RECLINER - REMOVABLE RIGHT (FACING) ARM INFINITE POSITION NON-LOCKING BACK

COM	4	5	6	7	8	9	10	11
5209	5389	5589	5999	6469	6899	7429	8109	9899

HC5157 BARIATRIC MOBILE HEALTHCARE CHAISE RECLINER - REMOVABLE RIGHT (FACING) ARM INFINITE POSITION LOCKING BACK

COM	4	5	6	7	8	9	10	11
5619	5789	5989	6379	6869	7279	7809	8489	10259

If patient transfer arm is specified on left side (facing), then handle will be placed on right side (facing) and vice versa.

Options	List Price	Options	List Price
U Urethane Arm Caps*	Standard	CAL CAL TB133	See page 12
W Wood Arm Caps*	\$229	MB2B Moisture Barrier Bariatric Back	\$89
Z Multi Cover	Use Highest Grade	MB2S Moisture Barrier Bariatric Seat	\$89
H Heat (Certified to UL 60601-1)	\$849	4S4 All 4" Swivel Locking Caster	\$39
HM Heat & Massage (Certified to UL 60601-1)	\$1119	AHP Adjustable Head Rest Pillow	\$339
HW Heat Wand (Certified to UL 60601-1)	\$1139	(Requires 1 yd of fabric)	
HMW Heat & Massage Wand	\$1369	USB Hospital Grade Power	\$459
(Certified to UL 60601-1)		FBH Foley Bag Holder	\$89
S4 4" 2-Caster Lock & Steer	\$569	FT Foot Tray	\$279
EG Edge Guard	Standard	WR Wrist Restraint (per pair)	\$229
MR/L Right/Left Side (facing) Monitor Arm	\$629	QR Additional Quick Release Accessory Bracket	\$69
(non-removable arm only)		TE-3 Trendelenburg (Bariatric)	\$459
MTR/L Right/Left Side (facing) Monitor Arm with Tray	\$629	PR1 Paper Roll Holder (takes place of push bar)	\$229
(non-removable arm only)		LC LiquiCell	\$229
		(Standard on Heat or Heat & Massage option)	

*Please refer to page 14 for finishes.

Please refer to pages 134/135 for Option descriptions & images.

Please refer to page 132 for the recliner ordering guide.



Lift Recliner Series

The Lift Recliner Series includes our Hydraulic and Power Exam Lift Recliners, engineered with threefold functionality as a recliner, exam surface, and sleep space with true flatbed position. Both styles of Exam Lift Recliner raise to a 36" exam height in all positions, while providing trusted comfort, performance, and durability.

The Lift Recliner Series also offers our "controlled environment" Power & Lift Recliners, which are operated with a hand wand, and allow patients or caregivers to help patients go from a seated to a standing position, as well as operating the recliner functionality with the wand vs a manual lever.



Rêma | Manual Hydraulic Lift Exam Treatment Recliner - 24" Seat - 650 lb. Weight Rating

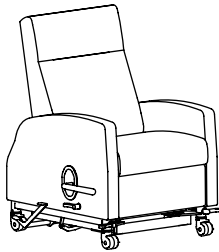

R7M18
35.5" Overall Width

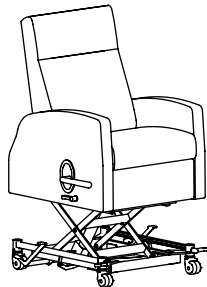

R7M18
Lifted View**

DIMENSIONS | R7M18 | RC7M18

Width	35.5	Seat Width	24	Back Height	26
Depth	38	Seat Depth	21	Arm Height	28
Height	48	Seat Height	23	Weight	259
COM (Standard)	6 YDS	COM (Chaise)	7 YDS	Weight Capacity	650 lbs.
Reclined Depth	73	Seat Depth (kick-out)	40	Lift Weight Capacity	450 lbs.
Distance from Wall	19				

R7M18 MANUAL HYDRAULIC LIFT EXAM TREATMENT RECLINER - ORTHOPEDIC LOCKING FOOTREST- INFINITE POSITION LOCKING BACK

COM	4	5	6	7	8	9	10	11
9799	9849	9939	10069	10229	10489	10659	10939	11379

RC7M18 MANUAL HYDRAULIC LIFT EXAM TREATMENT RECLINER WITH CHAISE - ORTHOPEDIC LOCKING FOOTREST - INFINITE POSITION LOCKING BACK

COM	4	5	6	7	8	9	10	11
10069	10129	10209	10349	10509	10759	10929	11219	11659

**Lifted View (Note: 11" is added to the seat height when the chair is fully lifted.)
Lift pedals standard on both sides, but available on only one side if specified.

Options	List Price	Options	List Price
F Fully Upholsterd Arms	Standard	CAL CAL TB133	See page 12
TE Trendelenburg	Standard	MBB Moisture Barrier Back	\$59
Q3 3" Dual Wheel Central Locking Caster	Standard	MBS Moisture Barrier Seat	\$59
U Urethane Arm Caps*	\$169	AHP Adjustable Head Rest Pillow	\$339
W Wood Arm Caps*	\$229	(Requires 1 yd of fabric)	
J Solid Surface Arm Caps* - Group 1	\$619 (Group 2 add \$200)	FBH Foley Bag Holder	\$89
Z Multi Cover	Use Highest Grade	IV IV Pole and Bracket	\$249
H Heat (Certified to UL 60601-1)	\$849	DP Dual IV Poles	\$498
HM Heat & Massage (Certified to UL 60601-1)	\$1119	OR Additional Quick Release Accessory Bracket	\$69
HW Heat Wand (Certified to UL 60601-1)	\$1139	USB Hospital Grade Power	\$459
HMW Heat & Massage Wand	\$1369	Q4 4" Central Caster Lock (no steer)	\$1019
		(Increases Seat Height 1")	
EG Edge Guard	Standard	Q5 5" Central Caster Lock (no steer)	\$1139
MR/L Right/Left Side (facing) Monitor Arm	\$629	(Increases Seat Height 2")	
MTR/L Right/Left Side (facing) Monitor Arm with Tray	\$629	PR1 Paper Roll Holder (takes place of push bar)	\$229
		LC LiquiCell	\$229
		(Standard on Heat or Heat & Massage option)	

*Please refer to page 14 for finishes.

Please refer to pages 134/135 for Option descriptions & images.

Please refer to page 132 for the recliner ordering guide.



Rêma | Manual Hydraulic Lift Exam Treatment Recliner - 24" Seat - 650 lb Weight Rating

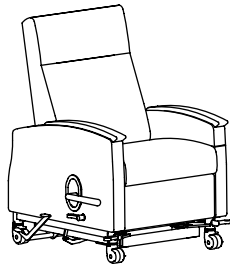

R7M67
35.5" Overall Width

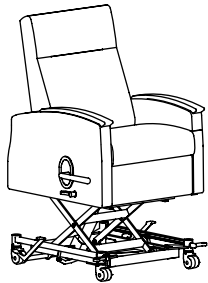

R7M67
Lifted View**

DIMENSIONS | R7M67 | RC7M67

Width	35.5	Seat Width	24	Back Height	26
Depth	38	Seat Depth	21	Arm Height	28
Height	48	Seat Height	23	Weight	259
COM (Standard)	7 YDS	COM (Chaise)	8 YDS	Weight Capacity	650 lbs.
Reclined Depth	73	Seat Depth (kick-out)	40	Lift Weight Capacity	450 lbs.
Distance from Wall	19				

R7M67 MANUAL HYDRAULIC LIFT EXAM TREATMENT RECLINER - FOLD DOWN ARM (RIGHT FACING) - ORTHOPEDIC LOCKING FOOTREST - INFINITE POSITION LOCKING BACK

COM	4	5	6	7	8	9	10	11
10379	10429	10519	10659	10889	10999	11239	11529	12369

RC7M67 MANUAL HYDRAULIC LIFT EXAM TREATMENT RECLINER WITH CHAISE - FOLD DOWN ARM (RIGHT FACING) - ORTHOPEDIC LOCKING FOOTREST - INFINITE POSITION LOCKING BACK

COM	4	5	6	7	8	9	10	11
10649	10699	10789	10929	11159	11279	11519	11799	12369

**Lifted View (Note: 11" is added to the seat height when the chair is fully lifted.)

If patient transfer arm is specified on left side (facing), then handle will be placed on right side (facing) and vice versa.

Lift pedals standard on both sides, but available on only one side if specified.

Options	List Price	Options	List Price
U Urethane Arm Caps*	Standard	CAL CAL TB133	See page 12
TE Trendelenburg	Standard	MBB Moisture Barrier Back	\$59
Q3 3" Dual Wheel Central Locking Caster	Standard	MBS Moisture Barrier Seat	\$59
W Wood Arm Caps*	\$229	AHP Adjustable Head Rest Pillow	\$339
J Solid Surface Arm Caps* - Group 1	\$619 (Group 2 add \$200)	(Requires 1 yd of fabric)	
Z Multi Cover	Use Highest Grade	FBH Foley Bag Holder	\$89
H Heat (Certified to UL 60601-1)	\$849	IV IV Pole and Bracket	\$249
HM Heat & Massage (Certified to UL 60601-1)	\$1119	DP Dual IV Poles	\$498
HW Heat Wand (Certified to UL 60601-1)	\$1139	QR Additional Quick Release Accessory Bracket	\$69
HMW Heat & Massage Wand	\$1369	USB Hospital Grade Power	\$459
(Certified to UL 60601-1)		Q4 4" Central Caster Lock (no steer)	\$1019
EG Edge Guard	Standard	(Increases Seat Height 1")	
HC Hinge Cover	Standard	Q5 5" Central Caster Lock (no steer)	\$1139
MR/L Right/Left Side (facing) Monitor Arm	\$629	(Increases Seat Height 2")	
(non-fold down arm only)		PR1 Paper Roll Holder (takes place of push bar)	\$229
MTR/L Right/Left Side (facing) Monitor Arm with Tray	\$629	LC LiquiCell	\$229
(non-fold down arm only)		(Standard on Heat or Heat & Massage option)	

*Please refer to page 14 for finishes.

Please refer to pages 134/135 for Option descriptions & images.

Please refer to page 132 for the recliner ordering guide.

Rêma | Manual Hydraulic Lift Exam Treatment Recliner - 24" Seat - 650 lb Weight Rating

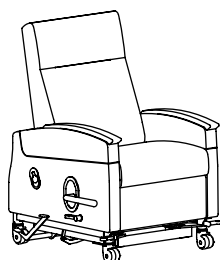

R7M62
35.5" Overall Width

DIMENSIONS | R7M62 | RC7M62

Width	35.5	Seat Width	24	Back Height	26
Depth	38	Seat Depth	21	Arm Height	28
Height	48	Seat Height	23	Weight	259
COM	7 YDS	COM (Chaise)	8 YDS	Weight Capacity	650 lbs.
Reclined Depth	73	Seat Depth (kick-out)	40	Lift Weight Capacity	450 lbs.
Distance from Wall	19				

R7M62 MANUAL HYDRAULIC LIFT EXAM TREATMENT RECLINER - DUAL FOLD DOWN ARMS - ORTHOPEDIC LOCKING FOOTREST - INFINITE POSITION LOCKING BACK

COM	4	5	6	7	8	9	10	11
10889	10939	11039	11119	11239	11529	11809	12089	12529

RC7M62 MANUAL HYDRAULIC LIFT EXAM TREATMENT RECLINER WITH CHAISE - DUAL FOLD DOWN ARMS - ORTHOPEDIC LOCKING FOOTREST - INFINITE POSITION LOCKING BACK

COM	4	5	6	7	8	9	10	11
11159	11219	11309	11389	11519	11799	12079	12369	12809

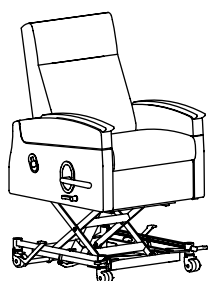

R7M62
Lifted View**

**Lifted View (Note: 11" is added to the seat height when the chair is fully lifted.)
Lift pedals standard on both sides, but available on only one side if specified.

Options	List Price	Options	List Price
U Urethane Arm Caps*	Standard	CAL CAL TB133	See page 12
TE Trendelenburg	Standard	MBB Moisture Barrier Back	\$59
Q3 3" Dual Wheel Central Locking Caster	Standard	MBS Moisture Barrier Seat	\$59
W Wood Arm Caps*	\$229	AHP Adjustable Head Rest Pillow	\$339
J Solid Surface Arm Caps* - Group 1	\$619 (Group 2 add \$200)	(Requires 1 yd of fabric)	
Z Multi Cover	Use Highest Grade	FBH Foley Bag Holder	\$89
HW Heat Wand (Certified to UL 60601-1)	\$1139	DP Dual IV Poles	\$498
HMW Heat & Massage Wand	\$1369	IV IV Pole and Bracket	\$249
(Certified to UL 60601-1)		QR Additional Quick Release Accessory Bracket	\$69
EG Edge Guard	Standard	Q4 4" Central Caster Lock (no steer)	\$1019
HC Hinge Cover	Standard	(Increases Seat Height 1")	
USB Hospital Grade Power	\$459	Q5 5" Central Caster Lock (no steer)	\$1139
		(Increases Seat Height 2")	
		PR1 Paper Roll Holder (takes place of push bar)	\$229
		LC LiquiCell	\$229
		(Standard on Heat or Heat & Massage option)	

*Please refer to page 14 for finishes.

Please refer to pages 134/135 for Option descriptions & images.

Please refer to page 132 for the recliner ordering guide.



Rêma | Power Lift Exam Treatment Recliner - 24" Seat - 650 lb Weight Rating

LIFT RECLINER SERIES

POWER LIFT EXAM RECLINER

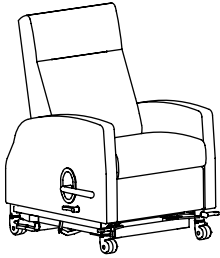

R7P18
34.5" Overall Width

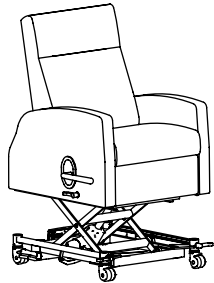

R7P18
Lifted View**

DIMENSIONS | R7P18 | RC7P18

Width	34.5	Seat Width	24	Back Height	26
Depth	38	Seat Depth	21	Arm Height	28
Height	48	Seat Height	23	Weight	259
COM (Standard)	7 YDS	COM (Chaise)	8 YDS	Weight Capacity	650 lbs.
Reclined Depth	73	Seat Depth (kick-out)	40	Lift Weight Capacity	450 lbs.
Distance from Wall	19				

R7P18 POWER LIFT EXAM TREATMENT RECLINER - ORTHOPEDIC LOCKING FOOTREST- INFINITE POSITION LOCKING BACK

COM	4	5	6	7	8	9	10	11
9799	9849	9939	10069	10229	10489	10659	10939	11379

RC7P18 POWER LIFT EXAM TREATMENT RECLINER WITH CHAISE - ORTHOPEDIC LOCKING FOOTREST - INFINITE POSITION LOCKING BACK

COM	4	5	6	7	8	9	10	11
10069	10129	10209	10349	10509	10759	10929	11219	11659

**Lifted View (Note: 11" is added to the seat height when the chair is fully lifted.)
Lift pedals standard on both sides.

Options	List Price	Options	List Price
F Upholstered Arms	Standard	CAL CAL TB133	See page 12
TE Trendelenburg	Standard	MBB Moisture Barrier Back	\$59
Q3 3" Dual Wheel Central Locking Caster	Standard	MBS Moisture Barrier Seat	\$59
U Urethane Arm Caps*	\$169	AHP Adjustable Head Rest Pillow	\$339
W Wood Arm Caps*	\$229	(Requires 1 yd of fabric)	
J Solid Surface Arm Caps* - Group 1	\$619 (Group 2 add \$200)	FBH Foley Bag Holder	\$89
Z Multi Cover	Use Highest Grade	IV IV Pole and Bracket	\$249
H Heat (Certified to UL 60601-1)	\$849	DP Dual IV Poles	\$498
HM Heat & Massage (Certified to UL 60601-1)	\$1119	QR Additional Quick Release Accessory Bracket	\$69
HW Heat Wand (Certified to UL 60601-1)	\$1139	USB Hospital Grade Power	\$459
HMW Heat & Massage Wand	\$1369	Q4 4" Central Caster Lock (no steer)	\$1019
(Certified to UL 60601-1)		(Increases Seat Height 1")	
EG Edge Guard	Standard	Q5 5" Central Caster Lock (no steer)	\$1139
HC Hinge Cover	Standard	(Increases Seat Height 2")	
MR/L Right/Left Side (facing) Monitor Arm	\$629	PR1 Paper Roll Holder (takes place of push bar)	\$229
MTR/L Right/Left Side (facing) Monitor Arm with Tray	\$629	LC LiquiCell	\$229
		(Standard on Heat or Heat & Massage option)	
		BBU Battery Backup	\$649

*Please refer to page 14 for finishes.

Please refer to pages 134/135 for Option descriptions & images.

Please refer to page 132 for the recliner ordering guide.



Rêma | Power Lift Exam Treatment Recliner - 24" Seat - 650 lb Weight Rating

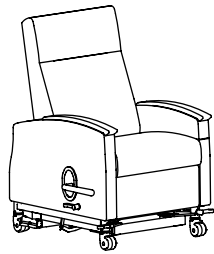

R7P67
34.5" Overall Width

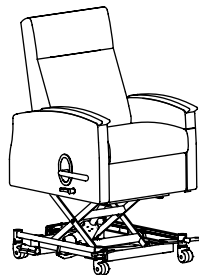

R7P67
Lifted View**

DIMENSIONS | R7P67 | RC7P67

Width	34.5	Seat Width	24	Back Height	26
Depth	38	Seat Depth	21	Arm Height	28
Height	48	Seat Height	23	Weight	259
COM	7 YDS	COM (Chaise)	8YDS	Weight Capacity	650 lbs.
Reclined Depth	73	Seat Depth (kick-out)	40	Lift Weight Capacity	450 lbs.
Distance from Wall	19				

R7P67 POWER LIFT EXAM TREATMENT RECLINER - FOLD DOWN ARM (RIGHT FACING) - ORTHOPEDIC LOCKING FOOTREST - INFINITE POSITION LOCKING BACK

COM	4	5	6	7	8	9	10	11
10379	10429	10519	10659	10889	10999	11239	11529	12369

RC7P67 POWER LIFT EXAM TREATMENT RECLINER WITH CHAISE - FOLD DOWN ARM (RIGHT FACING) - ORTHOPEDIC LOCKING FOOTREST - INFINITE POSITION LOCKING BACK

COM	4	5	6	7	8	9	10	11
10649	10699	10789	10929	11159	11279	11519	11799	12369

**Lifted View (Note: 11" is added to the seat height when the chair is fully lifted.)

If patient transfer arm is specified on left side (facing), then handle will be placed on right side (facing) and vice versa.
Lift pedals standard on both sides.

Options		List Price	Options		List Price
U	Urethane Arm Caps*	Standard	CAL	CAL TB133	See page 12
TE	Trendelenburg	Standard	MBB	Moisture Barrier Back	\$59
Q3	3" Dual Wheel Central Locking Caster	Standard	MBS	Moisture Barrier Seat	\$59
W	Wood Arm Caps*	\$229	AHP	Adjustable Head Rest Pillow	\$339
J	Solid Surface Arm Caps* - Group 1	\$619 (Group 2 add \$200)		(Requires 1 yd of fabric)	
Z	Multi Cover	Use Highest Grade	FBH	Foley Bag Holder	\$89
H	Heat (Certified to UL 60601-1)	\$849	DP	Dual IV Poles	\$498
HM	Heat & Massage (Certified to UL 60601-1)	\$1119	QR	Additional Quick Release Accessory Bracket	\$69
HW	Heat Wand (Certified to UL 60601-1)	\$1139	Q4	4" Central Caster Lock (<i>no steer</i>)	\$1019
HMW	Heat & Massage Wand (Certified to UL 60601-1)	\$1369		(Increases Seat Height 1")	
EG	Edge Guard	Standard	Q5	5" Central Caster Lock (<i>no steer</i>)	\$1139
HC	Hinge Cover	Standard		(Increases Seat Height 2")	
USB	Hospital Grade Power	\$459	MR/L	Right/Left Side (facing) Monitor Arm	\$629
IV	IV Pole and Bracket	\$249		(non-fold down arm only)	
BBU	Battery Backup	\$649	MTR/L	Right/Left Side (facing) Monitor Arm with Tray	\$629
				(non-fold down arm only)	
			LC	LiquiCell	\$229
				(Standard on Heat or Heat & Massage option)	

*Please refer to page 14 for finishes.

Please refer to pages 134/135 for Option descriptions & images.

Please refer to page 132 for the recliner ordering guide.



Rêma | Power Lift Exam Treatment Recliner - 24" Seat - 650 lb Weight Rating

LIFT RECLINER SERIES

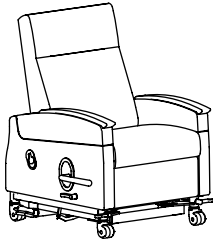

R7P62
34.5" Overall Width

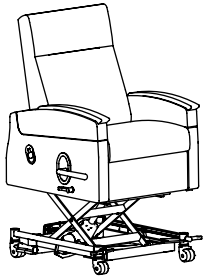

R7P62
Lifted View**

DIMENSIONS | R7P62 | RC7P62

Width	34.5	Seat Width	24	Back Height	26
Depth	38	Seat Depth	21	Arm Height	28
Height	48	Seat Height	23	Weight	259
COM (Standard)	7 YDS	COM (Chaise)	8 YDS	Weight Capacity	650 lbs.
Reclined Depth	73	Seat Depth (kick-out)	40	Lift Weight Capacity	450 lbs.
Distance from Wall	19				

R7P62 POWER LIFT EXAM TREATMENT RECLINER - DUAL FOLD DOWN ARMS - ORTHOPEDIC LOCKING FOOTREST - INFINITE POSITION LOCKING BACK

COM	4	5	6	7	8	9	10	11
10889	10939	11039	11119	11239	11529	11809	12089	12529

RC7P62 POWER LIFT EXAM TREATMENT RECLINER WITH CHAISE - DUAL FOLD DOWN ARMS - ORTHOPEDIC LOCKING FOOTREST - INFINITE POSITION LOCKING BACK

COM	4	5	6	7	8	9	10	11
11159	11219	11309	11389	11519	11799	12079	12369	12809

**Lifted View (Note: 11" is added to the seat height when the chair is fully lifted.)
Lift pedals standard on both sides.

POWER LIFT EXAM RECLINER

Options	List Price	Options	List Price
U Urethane Arm Caps*	Standard	CAL CAL TB133	See page 12
TE Trendelenburg	Standard	MBB Moisture Barrier Back	\$59
Q3 3" Dual Wheel Central Locking Caster	Standard	MBS Moisture Barrier Seat	\$59
W Wood Arm Caps*	\$229	AHP Adjustable Head Rest Pillow	\$339
J Solid Surface Arm Caps* - Group 1	\$619 (Group 2 add \$200)	(Requires 1 yd of fabric)	
Z Multi Cover	Use Highest Grade	FBH Foley Bag Holder	\$89
HW Heat Wand (Certified to UL 60601-1)	\$1139	IV IV Pole and Bracket	\$249
HMW Heat & Massage Wand	\$1369	DP Dual IV Poles	\$498
(Certified to UL 60601-1)		QR Additional Quick Release Accessory Bracket	\$69
EG Edge Guard	Standard	USB Hospital Grade Power	\$459
HC Hinge Cover	Standard	Q4 4" Central Caster Lock (no steer)	\$1019
MR/L Right/Left Side (facing) Monitor Arm	\$629	(Increases Seat Height 1")	
(non-fold down arm only)		Q5 5" Central Caster Lock (no steer)	\$1139
MTR/L Right/Left Side (facing) Monitor Arm with Tray	\$629	(Increases Seat Height 2")	
(non-fold down arm only)		PR1 Paper Roll Holder (takes place of push bar)	\$229
		LC LiquiCell	\$229
		(Standard on Heat or Heat & Massage option)	
		BBU Battery Backup	\$649

*Please refer to page 14 for finishes.

Please refer to pages 134/135 for Option descriptions & images.
Please refer to page 132 for the recliner ordering guide.



Koncert | Power & Lift Room Saver™ Recliners - 23" Seat - 350 lb Weight Rating



K1L04
30.75" Overall Width

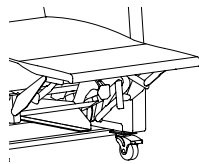

Chaise Model
KC1L04

DIMENSIONS | K1L04 | KC1L04

Width	30.75	Seat Width	22.5	Back Height	23.5
Depth	34.25	Seat Depth	20	Arm Height	23.75
Height	39.5	Seat Height	17.25	Weight	84
COM (Standard)	4 YDS	COM (Chaise)	5 YDS	Weight Capacity	350 lbs.
Reclined Depth	65.5	Seat Depth (kick-out)	38	Distance from Wall	5

K1L04 | POWER & LIFT ROOM SAVER™ RECLINER

COM	4	5	6	7	8	9	10	11
3209	3249	3349	3489	3689	3889	4129	4419	4619

KC1L04 | POWER & LIFT ROOM SAVER™ CHAISE RECLINER

COM	4	5	6	7	8	9	10	11
3469	3509	3619	3749	3949	4149	4379	4659	4869

Options

Options	List Price
F Upholstered Arms	Standard
U Urethane Arm Caps	\$169*
W Wood Arm Caps	\$229*
J Solid Surface Arm Caps* - Group 1	\$619 (Group 2 add \$200)
Z Multi-Cover	Use Highest Grade
CAL CALTB133	See Page 12
MBB Moisture Barrier Back	\$59
MBS Moisture Barrier Seat	\$59

*Please refer to page 14 for finishes.

Power Recliner Wand



Note: Electrical Cord is Approximately 11' Long

Please refer to page 132 for the recliner ordering guide.



K-Komfort | Power & Lift Room Saver™ Recliners - 23" Seat - 350 lb Weight Rating

LIFT RECLINER SERIES

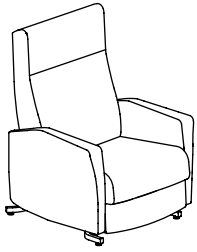

K8L04
30.5" Overall Width

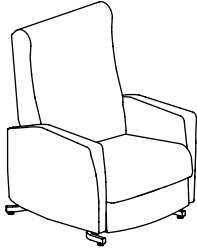

K8L14
30.5" Overall Width

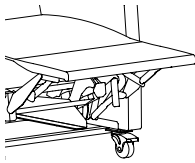

Chaise Models
KC8L04 | KC8L14

DIMENSIONS | K8L04 | K8L14 | KC8L04 | KC8L14

Width	30.5	Seat Width	22.25	Back Height	21
Depth	35	Seat Depth	21	Arm Height	24.5
Height	39.5	Seat Height	18.5	Weight	120
COM	4.5 YDS	Seat Depth (kick-out)	38	Weight Capacity	350 lbs.
Reclined Depth	65.5	Distance from Wall	5		

K8L04 ROOM SAVER™ POWER & LIFT RECLINER

COM	4	5	6	7	8	9	10	11
2999	3039	3099	3229	3409	3529	3749	3979	4159

KC8L04 ROOM SAVER™ POWER & LIFT CHAISE RECLINER

COM	4	5	6	7	8	9	10	11
3269	3299	3379	3489	3659	3789	3999	4239	4409

K8L14 ROOM SAVER™ POWER & LIFT RECLINER

COM	4	5	6	7	8	9	10	11
2919	2949	3009	3169	3309	3429	3629	3859	4079

KC8L14 ROOM SAVER™ POWER & LIFT CHAISE RECLINER

COM	4	5	6	7	8	9	10	11
3189	3209	3259	3429	3589	3689	3879	4109	4319

K8L14 Feature Only

Z Multi-Cover

List

Use Highest Grade

Options

Options		List Price
CAL	CALTB133	See page 12
MBB	Moisture Barrier Back	\$59
MBS	Moisture Barrier Seat	\$59

Power & Lift Recliner Wand



Note: Electrical Cord is Approximately 11' Long

Please refer to page 132 for the recliner ordering guide.

POWER & LIFT ROOM SAVER RECLINER

K-Komfort | Power Room Saver™ Recliners - 23" Seat - 350 lb Weight Rating

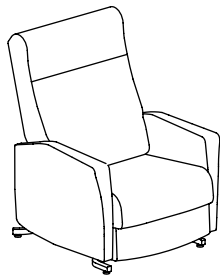

K8P04
30.5" Overall Width

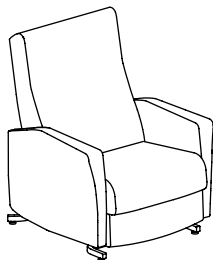

K8P14
30.5" Overall Width

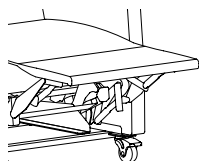

Chaise Models
KC8P04 | KC8P14

DIMENSIONS | K8P04 | K8P14 | KC8P04 | KC8P14

Width	30.5	Seat Width	22.25	Back Height	21
Depth	35	Seat Depth	21	Arm Height	24.5
Height	39.5	Seat Height	18.5	Weight	96
COM	4.5 YDS	Seat Depth (kick-out)	38	Weight Capacity	350 lbs.
Reclined Depth	65.5	Distance from Wall	5		

K8P04 ROOM SAVER™ POWER RECLINER

COM	4	5	6	7	8	9	10	11
2999	3039	3099	3229	3409	3529	3749	3979	4159

KC8P04 ROOM SAVER™ POWER CHAISE RECLINER

COM	4	5	6	7	8	9	10	11
3269	3299	3379	3489	3659	3789	3999	4239	4409

K8P14 ROOM SAVER™ POWER RECLINER

COM	4	5	6	7	8	9	10	11
2919	2949	3009	3169	3309	3429	3629	3859	4079

KC8P14 ROOM SAVER™ POWER CHAISE RECLINER

COM	4	5	6	7	8	9	10	11
3189	3209	3259	3429	3589	3689	3879	4109	4319

K8P14 Feature Only

Z Multi-Cover

List

Use Highest Grade

Options

Options	List Price
CAL CALTB133	See page 12
MBB Moisture Barrier Back	\$59
MBS Moisture Barrier Seat	\$59

Power Recliner Wand



Note: Electrical Cord is Approximately 11' Long

Please refer to page 132 for the recliner ordering guide.



Koncert | Power Room Saver™ Recliners - 23" Seat - 350 lb Weight Rating

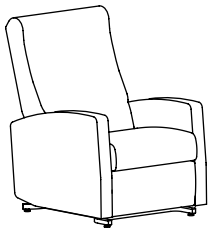

K1P04
30.75" Overall Width

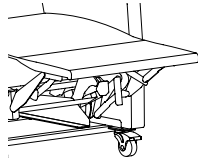

Chaise Model
KC1P04

DIMENSIONS | K1P04 | KC1P04

Width	30.75	Seat Width	22.25	Back Height	23.5
Depth	34.25	Seat Depth	20	Arm Height	23.75
Height	38	Seat Height	17.25	Weight	84
COM (Standard)	4 YDS	COM (Chaise)	5 YDS	Weight Capacity	350 lbs.
Reclined Depth	65.5	Seat Depth (kick-out)	37.75	Distance from Wall	5

K1P04 ROOM SAVER™ POWER RECLINER - UPH ARMS

COM	4	5	6	7	8	9	10	11	
	3209	3249	3349	3489	3689	3889	4129	4419	4619

KC1P04 ROOM SAVER™ CHAISE POWER RECLINER - UPH ARMS

COM	4	5	6	7	8	9	10	11	
	3469	3509	3619	3749	3949	4149	4379	4659	4869

Options

Options	List Price
F Upholstered Arms	Standard
U Urethane Arm Caps	\$169*
W Wood Arm Caps	\$229*
J Solid Surface Arm Caps* - Group 1	\$619 (Group 2 add \$200)
Z Multi-Cover	Use Highest Grade
CAL CALTB133	See page 12
MBB Moisture Barrier Back	\$59
MBS Moisture Barrier Seat	\$59
AHP Adjustable Headrest Pillow (Requires 1 yd of fabric)	\$339

*Please refer to page 14 for finishes.

Power Recliner Wand



Note: Electrical Cord is Approximately 11' Long

Please refer to page 132 for the recliner ordering guide.

SLEEPER COLLECTIONS

▪ Soft Luxe™ Coil Cushions.....	230
▪ Kadia Mod Sleep Chairs by Knú® Healthcare.....	232
▪ EV Sleep Chairs by Knú® Healthcare.....	233
▪ Rêma Sleep Chairs by Knú® Healthcare.....	234
▪ Harmony Sleep Chairs by Knú® Healthcare.....	235
▪ Oxley Sleep Sofas by Knú® Healthcare.....	236
▪ Max Sleep Sofas by Knú® Healthcare.....	238

SEAT CUSHION SYSTEM WITH BOLSA™ COILS

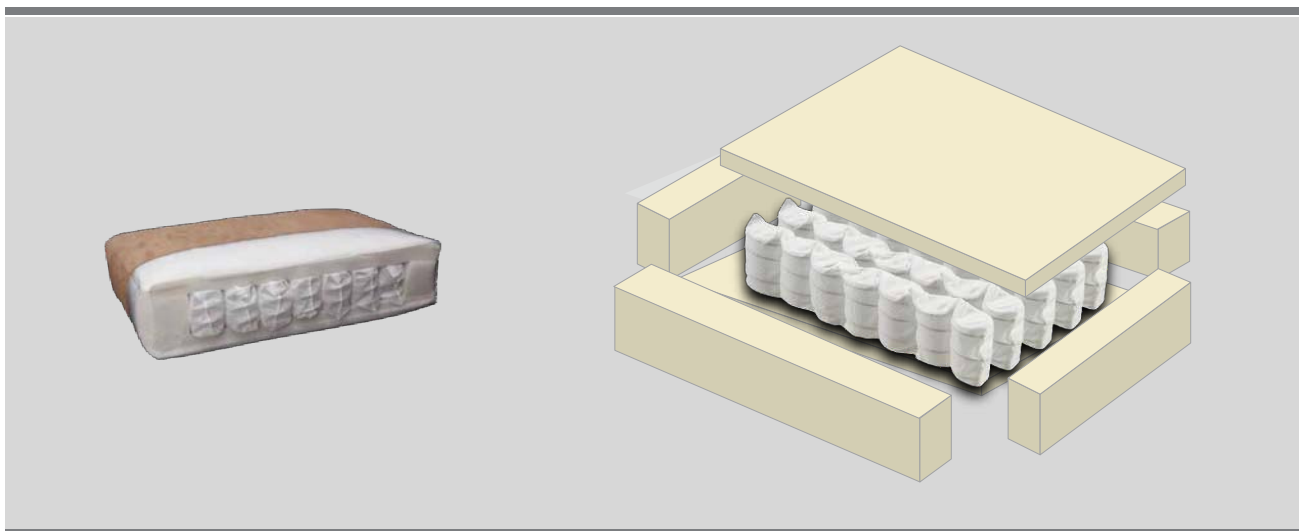

La-Z-Boy Healthcare presents a new addition to the Soft Luxe™ family, a unique design of quality comfort unlike any other furniture cushion fillers. It is constructed of high-density fortified steel springs encased in fabric. This provides a long-last cushion with maximum comfort.

When compared to normal seat foam:

- Up to 21% less seat cushion breakdown with pocketed coil seat cushions over the life of the product.
- Top sides are wrapped with 2.6 (HR) High Resiliency foam.

Engineered for Value

The Bolsa™ coils are specially designed springs which are stress-relieved to improve resiliency and performance and extend furniture life. As a result, this cushion design provides 21-percent less breakdown from use than traditional foam seat cushions.

Durability and Support You Can Feel

Each Bolsa™ coil flexes independently and adjusts instantly to optimize body contouring and support. The barrel-shaped coils offer initial luxurious softness, followed by firmer support that responds to applied weight. The design of our fabric-encased coils works to maintain structural integrity while offering the highest support and comfort available. Pocketed coil cushions are more resilient than foam, providing as much lift force when load is removed as when load is applied.

Only Available on the Following Models:

- EV Series Sleep Chairs: E0700, E0722, E0800
- Rêma Series Sleep Chairs: R1700, R1722, R1800
- Harmony Series Sleep Chairs: H1700, H1800
- Kadia Mod Series Sleep Chairs: KM1700, KM1722, KM1800

Sleep Chairs

Product Specifications

- Fully Upholstered Arms Standard (Kadia Mod, EV, Rêma)
- Black Urethane Arm Caps Standard (Harmony)
- 3" Dual Wheel Casters Standard
- 600 lb Weight Capacity | Bariatric Rated
- Heavy-Duty Steel Pull-Out Bed Mechanism
- Easy to Open and Close
- 3 Positions: Chair, Chaise, Bed
- Coil Spring Seat Cushions (KM1700, KM1722, KM1800, E0700, E0722, E0800, R1700, R1722, R1800, H1700, H1800)
 - 21% less seat cushion breakdown when compared to normal seat foam
 - Each Bolsa™ Coil flexes independently and adjusts instantly to optimize body contouring and support.
 - The barrel-shaped coils offer luxurious softness and firm support that responds to applied weight.



Urethane Arm Cap Finishes

Please refer to page 14.

Wood Leg Finish Options

Please refer to page 14.

CAL TB133

Please refer to page 12.

Moisture Barrier Options

Please refer to page 14.



Options

- U Urethane Arm Caps (Add \$169)
- W Wood Arm Caps (Add \$229)
- J Corian® Solid Surface Arm Caps (Group 1 - \$619
Group 2 - \$819)
- CAL CAL TB133 (Please refer to page 12.)
- WF Wood Legs (\$279)

TO ORDER, SPECIFY

- 1. Model Number
- 2. Textile
- 3. Finish
- 4. Options

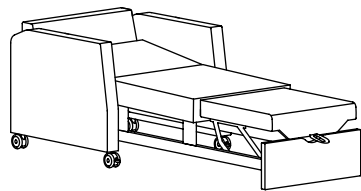

KM1700 | 33" SLEEP CHAIR - STANDARD WITH CASTERS AND FULLY UPHOLSTERED ARMS

DIMENSIONS - COM 7 YDS

Width	33	Seat Width	26.5	Back Height	18.25
Depth	32	Seat Depth	19.75	Arm Height	27
Height	34.25	Seat Height	19.75	Weight	160

<i>COM</i>	<i>4</i>	<i>5</i>	<i>6</i>	<i>7</i>	<i>8</i>	<i>9</i>	<i>10</i>	<i>11</i>
4279	4359	4589	4829	5129	5509	5849	6329	7619

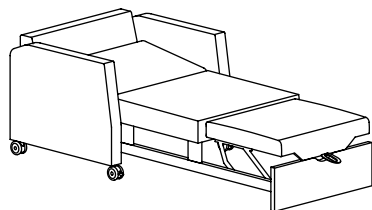

KM1800 | 37" SLEEP CHAIR - STANDARD WITH CASTERS AND FULLY UPHOLSTERED ARMS

DIMENSIONS - COM 9 YDS

Width	37	Seat Width	30.5	Back Height	18.25
Depth	32	Seat Depth	19.75	Arm Height	27
Height	34.25	Seat Height	19.75	Weight	189

<i>COM</i>	<i>4</i>	<i>5</i>	<i>6</i>	<i>7</i>	<i>8</i>	<i>9</i>	<i>10</i>	<i>11</i>
4419	4629	4909	5209	5639	6199	6749	7459	8329

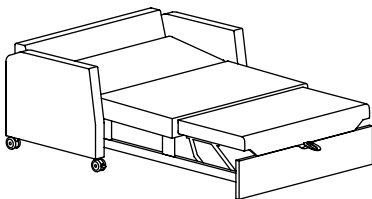

KM1900 | 53" SLEEP CHAIR - STANDARD WITH CASTERS AND FULLY UPHOLSTERED ARMS

DIMENSIONS - COM 10 YDS

Width	53	Seat Width	46.5	Back Height	18.25
Depth	32	Seat Depth	19.75	Arm Height	27
Height	34.25	Seat Height	19.75	Weight	229

<i>COM</i>	<i>4</i>	<i>5</i>	<i>6</i>	<i>7</i>	<i>8</i>	<i>9</i>	<i>10</i>	<i>11</i>
5429	5739	6049	6429	6739	7299	7849	8579	9529

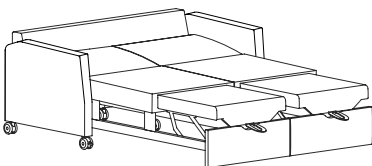

KM1722 | 60" DUAL SLEEP CHAIR - STANDARD WITH CASTERS AND FULLY UPHOLSTERED ARMS

DIMENSIONS - COM 12 YDS

Width	60	Seat Width	27.125	Back Height	18.25
Depth	32	Seat Depth	19.75	Arm Height	27
Height	34.25	Seat Height	19.75	Weight	264

<i>COM</i>	<i>4</i>	<i>5</i>	<i>6</i>	<i>7</i>	<i>8</i>	<i>9</i>	<i>10</i>	<i>11</i>
7089	7349	7749	8259	8649	9419	9989	10779	11319

Note: 48" in front of these units is needed to pull out the seat and the seat extension in order to convert into a sleeper.

Options

U	Urethane Arm Caps (Add \$169)
W	Wood Arm Caps (Add \$229)
J	Corian® Solid Surface Arm Caps (Group 1 - \$619 Group 2 - \$819)
CAL	CAL TB133 (Please refer to page 12.)
WF	Wood Legs (\$279)

TO ORDER, SPECIFY

1. Model Number	3. Finish
2. Textile	4. Options

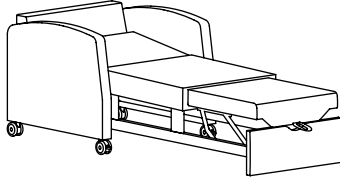

E0700 | 32" SLEEP CHAIR - STANDARD WITH CASTERS AND FULLY UPHOLSTERED ARMS

DIMENSIONS - COM 7 YDS

Width	32	Seat Width	26.5	Back Height	18.25				
Depth	34.25	Seat Depth	19.75	Arm Height	27.5				
Height	34.5	Seat Height	21	Weight	158				
COM	4	5	6	7	8	9	10	11	
	4279	4359	4589	4829	5129	5509	5849	6329	7619

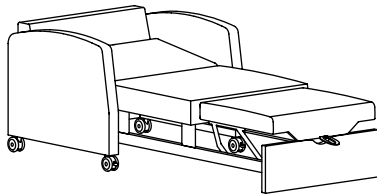

E0800 | 36" SLEEP CHAIR - STANDARD WITH CASTERS AND FULLY UPHOLSTERED ARMS

DIMENSIONS - COM 9 YDS

Width	36	Seat Width	30.5	Back Height	18.25				
Depth	34.25	Seat Depth	19.75	Arm Height	27.5				
Height	34.5	Seat Height	21	Weight	188				
COM	4	5	6	7	8	9	10	11	
	4419	4629	4909	5209	5639	6199	6749	7459	8329

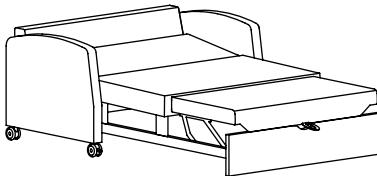

E0900 | 52" SLEEP CHAIR - STANDARD WITH CASTERS AND FULLY UPHOLSTERED ARMS

DIMENSIONS - COM 10 YDS

Width	52	Seat Width	46.5	Back Height	18.25				
Depth	34.25	Seat Depth	19.75	Arm Height	27.5				
Height	34.5	Seat Height	21	Weight	228				
COM	4	5	6	7	8	9	10	11	
	5579	5739	6049	6429	6739	7299	7849	8579	9529

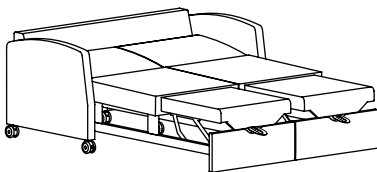

E0722 | 59" SLEEP CHAIR - STANDARD WITH CASTERS AND FULLY UPHOLSTERED ARMS

DIMENSIONS - COM 12 YDS

Width	59.125	Seat Width	27.125	Back Height	18.25				
Depth	32	Seat Depth	19	Arm Height	27.5				
Height	36.25	Seat Height	19.5	Weight	264				
COM	4	5	6	7	8	9	10	11	
	7089	7349	7749	8259	8649	9419	9989	10779	11319

Note: 48" in front of these units is needed to pull out the seat and the seat extension in order to convert into a sleeper.



Options

- U Urethane Arm Caps (Add \$169)
- W Wood Arm Caps (Add \$229)
- J Corian® Solid Surface Arm Caps (Group 1 - \$619
Group 2 - \$819)
- CAL CAL TB133 (Please refer to page 12.)
- WF Wood Legs (\$279)

TO ORDER, SPECIFY

- 1. Model Number
- 2. Textile
- 3. Finish
- 4. Options

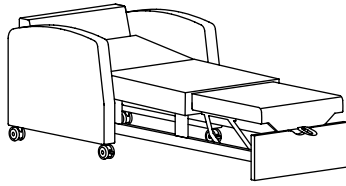

R1700 | 33" SLEEP CHAIR - STANDARD WITH CASTERS AND FULLY UPHOLSTERED ARMS

DIMENSIONS - COM 7 YDS

Width	33	Seat Width	26.5	Back Height	18.25				
Depth	34.25	Seat Depth	19.75	Arm Height	27.5				
Height	34.5	Seat Height	21	Weight	158				
<i>COM</i>	<i>4</i>	<i>5</i>	<i>6</i>	<i>7</i>	<i>8</i>	<i>9</i>	<i>10</i>	<i>11</i>	
	4279	4359	4589	4829	5129	5509	5849	6329	7619

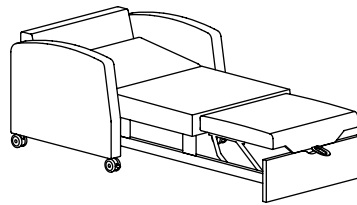

R1800 | 37" SLEEP CHAIR - STANDARD WITH CASTERS AND FULLY UPHOLSTERED ARMS

DIMENSIONS - COM 9 YDS

Width	37	Seat Width	30.5	Back Height	18.25				
Depth	34.25	Seat Depth	19.75	Arm Height	27.5				
Height	34.5	Seat Height	21	Weight	189				
<i>COM</i>	<i>4</i>	<i>5</i>	<i>6</i>	<i>7</i>	<i>8</i>	<i>9</i>	<i>10</i>	<i>11</i>	
	4419	4629	4909	5209	5639	6199	6749	7459	8329

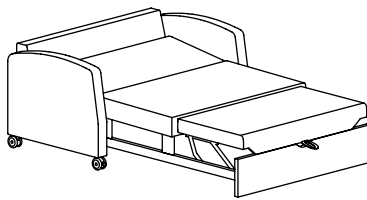

R1900 | 53" SLEEP CHAIR - STANDARD WITH CASTERS AND FULLY UPHOLSTERED ARMS

DIMENSIONS - COM 10 YDS

Width	53	Seat Width	46.5	Back Height	18.25				
Depth	34.25	Seat Depth	19.75	Arm Height	27.5				
Height	34.5	Seat Height	21	Weight	229				
<i>COM</i>	<i>4</i>	<i>5</i>	<i>6</i>	<i>7</i>	<i>8</i>	<i>9</i>	<i>10</i>	<i>11</i>	
	5429	5739	6049	6429	6739	7299	7849	8579	9529

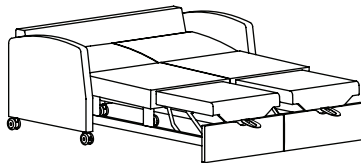

R1722 | 60" DUAL SLEEP CHAIR - STANDARD WITH CASTERS AND FULLY UPHOLSTERED ARMS

DIMENSIONS - COM 12 YDS

Width	60.125	Seat Width	27.125	Back Height	18.25				
Depth	32	Seat Depth	19	Arm Height	27.5				
Height	36.25	Seat Height	19.75	Weight	264				
<i>COM</i>	<i>4</i>	<i>5</i>	<i>6</i>	<i>7</i>	<i>8</i>	<i>9</i>	<i>10</i>	<i>11</i>	
	7089	7349	7749	8259	8649	9419	9989	10779	11319

Note: 48" in front of these units is needed to pull out the seat and the seat extension in order to convert into a sleeper.



Options*

- W Wood Arm Caps (Add \$229)
- CAL CAL TB133 (Please refer to page 12.)
- WF Wood Legs (\$279)

TO ORDER, SPECIFY

- 1. Model Number
- 2. Textile
- 3. Finish
- 4. Options

*Black Urethane Arm Caps Standard

H1700 | 34" SLEEP CHAIR - STANDARD WITH CASTERS - STANDARD WITH URETHANE ARM CAPS

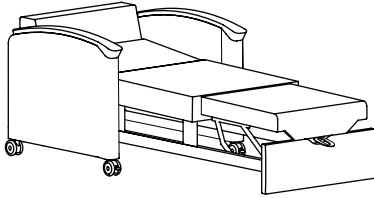

DIMENSIONS - COM 7 YDS

Width	34	Seat Width	26.5	Back Height	18.25
Depth	34.25	Seat Depth	21	Arm Height	27.25
Height	34.5	Seat Height	26.5	Weight	173

<i>COM</i>	4	5	6	7	8	9	10	11
4509	4719	4919	5099	5409	5819	6199	6699	7769

H1800 | 38" SLEEP CHAIR - STANDARD WITH CASTERS - STANDARD WITH URETHANE ARM CAPS

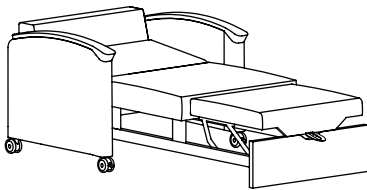

DIMENSIONS - COM 9 YDS

Width	38	Seat Width	30.5	Back Height	18.25
Depth	34.25	Seat Depth	19.75	Arm Height	27.25
Height	34.5	Seat Height	21	Weight	200

<i>COM</i>	4	5	6	7	8	9	10	11
4629	4859	5259	5569	6059	6489	7049	7819	8489

H1900 | 54" SLEEP CHAIR - STANDARD WITH CASTERS - STANDARD WITH URETHANE ARM CAPS

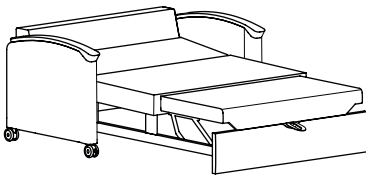

DIMENSIONS - COM 10 YDS

Width	54	Seat Width	46.5	Back Height	18.25
Depth	34.25	Seat Depth	19.75	Arm Height	27.25
Height	34.5	Seat Height	21	Weight	229

<i>COM</i>	4	5	6	7	8	9	10	11
5909	6079	6449	6869	7339	7939	8549	9339	9709



Oxley Sleep Sofa

Product Specifications

- Fully Upholstered Arms Standard (OO, OW)
- 1000 lb Weight Capacity | Bariatric Rated
- (7) 3" Dual Wheel Swivel Locking Casters
- Upholstered Front Option
- Back of Cushion is Blue Anti-Microbial, Bleach Cleanable, Moisture Resistant Material

Dimensions

- | | |
|--------------------------------|-------|
| ▪ Width | 76" |
| ▪ Width (OO2176UF) | 82" |
| ▪ Width (OW2176UF) | 85.5" |
| ▪ Depth | 31" |
| ▪ Depth (ON2076UF, ON2076HPUF) | 24" |
| ▪ Height | 36" |
| ▪ Height (ON2076UF) | 24.6" |
| ▪ Seat Width | 76" |



Urethane Arm Cap Finishes

Please refer to page 14.

Wood Leg Finish Options

Please refer to page 14.

CAL TB133

Please refer to page 12.

Moisture Barrier Options

Please refer to page 14.

Options

- U Urethane Arm Caps (Add \$169 OO/ \$229 OW)
- T Thermofoil Arm Caps (Add \$139 OO/ \$229 OW)
- J Solid Surface Arm Caps (Group 1 - \$619 OO / \$1139 OW
Group 1 - \$819 OO / \$1399 OW)
- CAL CAL TB133 (Please refer to page 12.)
- Power* Hospital Grade Power Outlet - \$459
(2) USB Ports, (1) 120 V Power Outlet
Color: Black / 7' Usable Cord Length

3" Swivel Locking Caster

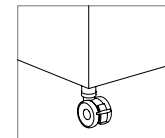

TO ORDER, SPECIFY

1. Model Number
2. Textile
3. Finish
4. Options

ON2076UF | PULLOUT SLEEP BENCH WITH UPHOLSTERED FRONT

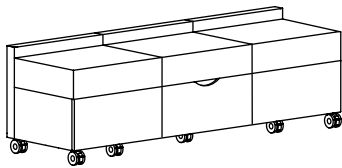

DIMENSIONS - COM 6 YDS

Width	76	Seat Width	76	Back Height	3				
Depth	24	Seat Depth	20	Arm Height	N/A				
Height	24.6	Seat Height	20.5	Weight	181				
COM	6 YDS								
COM	4	5	6	7	8	9	10	11	
	4619	4639	4739	4879	5049	5289	5519	5799	6269

ON2076HPUF | HIGH BACK PULLOUT SLEEP BENCH WITH UPH. FRONT & BACK PAD

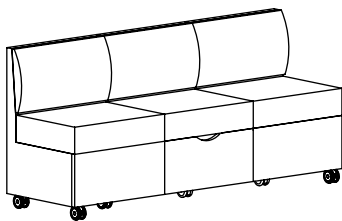

DIMENSIONS - COM 8.5 YDS

Width	76	Seat Width	76	Back Height	15.5				
Depth	24	Seat Depth	20	Arm Height	N/A				
Height	36	Seat Height	20.5	Weight	207				
COM	8.5 YDS								
COM	4	5	6	7	8	9	10	11	
	6169	6209	6289	6499	6729	6969	7209	7589	8029

ON2176UF | ARMLESS PULLOUT SLEEP SOFA WITH UPHOLSTERED FRONT

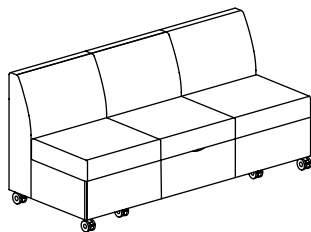

DIMENSIONS - COM 8 YDS

Width	76	Seat Width	76	Back Height	15.5				
Depth	31	Seat Depth	22	Arm Height	27.75				
Height	36	Seat Height	20.5	Weight	207				
COM	8 YDS								
COM	4	5	6	7	8	9	10	11	
	5929	5959	6419	6729	6879	7019	7609	8109	8859

OO2176UF | PULLOUT SLEEP SOFA WITH UPHOLSTERED FRONT - 3.5" SQUARE ARM

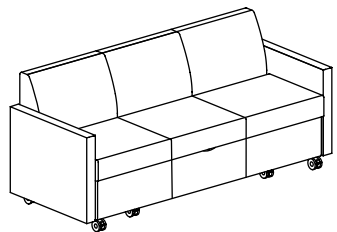

DIMENSIONS - COM 10.5 YDS

Width	82	Seat Width	76	Back Height	15.5				
Depth	31	Seat Depth	22	Arm Height	27.75				
Height	36	Seat Height	20.5	Weight	264				
COM	10.5 YDS								
COM	4	5	6	7	8	9	10	11	
	6539	6669	6879	7349	7639	8109	8559	9179	10079

OW2176UF | PULLOUT SLEEP SOFA WITH UPHOLSTERED FRONT - 5" SQUARE ARM

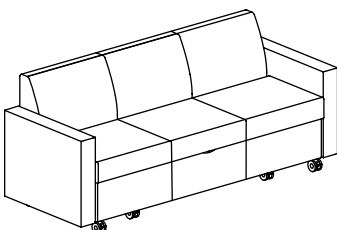

DIMENSIONS - COM 10.5 YDS

Width	85.5	Seat Width	76	Back Height	15.5				
Depth	31	Seat Depth	22	Arm Height	21.75				
Height	36	Seat Height	20.5	Weight	265				
COM	10.5 YDS								
COM	4	5	6	7	8	9	10	11	
	6539	6669	6879	7349	7639	8109	8559	9179	10079

Note: 24" in front of these units is needed to pull out the seat and the seat extension in order to convert into a sleeper.

Max Sleep Sofa

The Max Sleep Sofa earns its name with its ability to maximize valuable space in healthcare environments, with a back that folds out to form a full sleep surface for users, while keeping the same original footprint. Available with many different options to enhance performance and comfort, such as recliner leg rests, stationary and lifting tables, numerous width and arm sizes, among others, the Max Sleep Sofa has become one of our fastest growing series in popularity.



ARM CAP OPTIONS

(F) Fully Upholstered

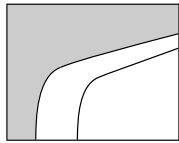

(T) Thermofoil

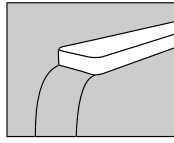

(J) Solid Surface
(U) Urethane

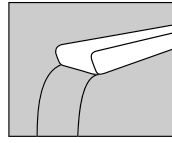

ARM OPTIONS

(N) No Arm
Shown in image on right

(M) Max Arm (3" Arm)

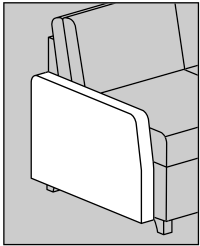

(W) Wide Arm (5" Arm)

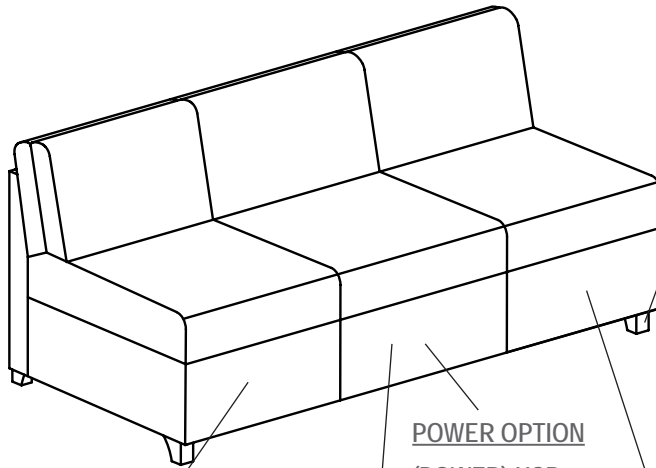
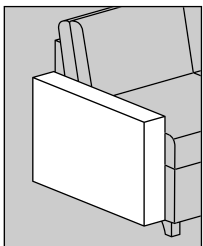

LEG OPTIONS

(WL) Wood Leg
Shown in image on left

(ML) Metal Legs

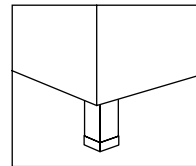

(Q3) 3" Dual Wheel Central Lock Caster

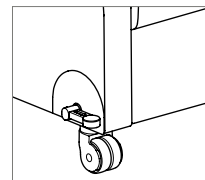

(CASTER) 3" Dual Locking Swivel Locking Casters

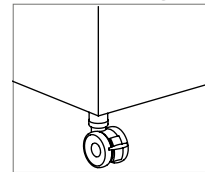

POWER OPTION

(POWER) USB
Hospital Grade Power

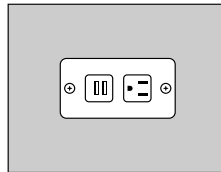

LEFT SIDE OPTIONS

(X) Fixed Front
Shown in image above

(R) Recliner

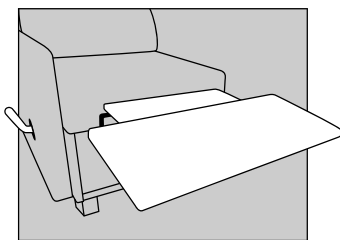

(D) Drawer

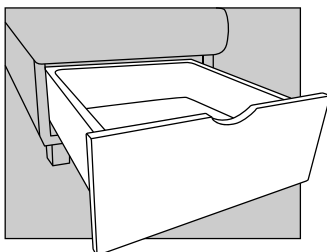

CENTER OPTIONS

(X) Fixed Front
Shown in image above

(C) Console Table

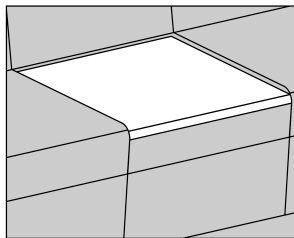

(L) Lift Table

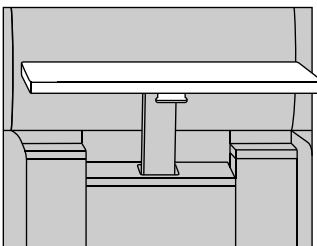

RIGHT SIDE OPTIONS

(X) Fixed Front
Shown in image above

(R) Recliner

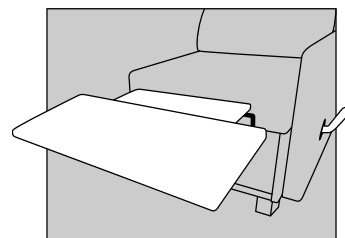

(D) Drawer

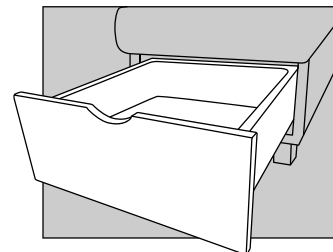

N78XXXUF - 78" SEAT WIDTH BASE MODEL PRICING

DIMENSIONS - COM 7.5 YDS (add 2.5 YDS to COM if Arms are selected)

Width	78	Seat Width	78	Back Height	15				
Depth	35	Seat Depth	22	Arm Height	N/A				
Height	36	Seat Height	20	Weight*	175				
COM	4	5	6	7	8	9	10	11	
	4849	4979	5239	5589	5889	6289	6689	6989	7559

N70XXXUF - 70" SEAT WIDTH BASE MODEL PRICING (options are limited with this model)

DIMENSIONS - COM 7.5 YDS (add 2.5 YDS to COM if Arms are selected)

Width	70	Seat Width	70	Back Height	15				
Depth	35	Seat Depth	22	Arm Height	N/A				
Height	36	Seat Height	20	Weight*	173				
COM	4	5	6	7	8	9	10	11	
	4699	4829	5079	5439	5719	6119	6489	6779	7339

*Weight will vary based on selected options

How to Order

The chart below is a guide to use when building the Max sleep sofa model number for your purchase order. Please select the model with seat width preferred, the arms, and then the options you would like your sleeper to have. If options are not desired, please leave space blank. List your textile, finish, and options below the model number. Price is determined by fabric grade choice. Options are in addition to the sleeper base price (listed above).

Example Below

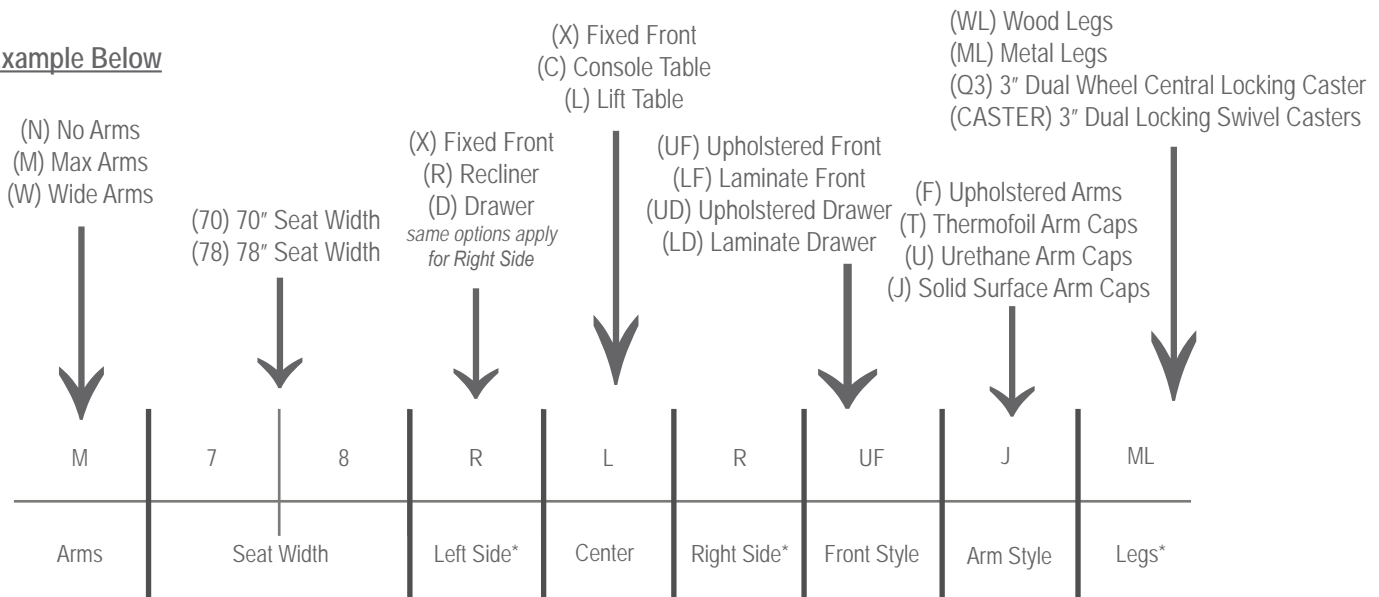

*Options are not available on all models. Please refer to individual product pages for availability.

MAX SLEEP SOFA BUILDER

1. Start with base model/seat width

N78XXXUF (78" Seat Width)
Refer above for pricing

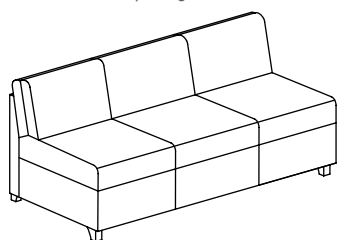

N70XXXUF (70" Seat Width)
Refer above for pricing

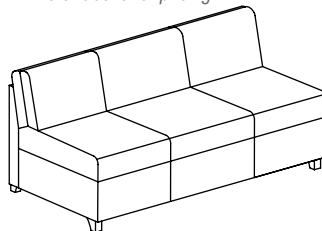

2. Select Arm

(N) No Arm
Standard on model

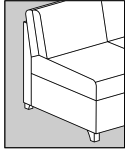

(M) Max Arm - 3" Arm
Refer to page 240 for pricing

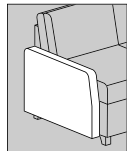

(W) Wide Arm - 5" Arm
Refer to page 240 for pricing

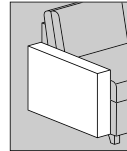

M	7	8					
---	---	---	--	--	--	--	--

3. Select Left and Right Side Options with Front Style (options are the same for both left and right sides)

Recliners and drawers not available on 70" models.

(X) Fixed Front

-Choose between upholstered (standard) or thermofoil front
-Refer to page 14 for thermofoil options
Full Laminate Front - \$339
Single Laminate Front - \$169

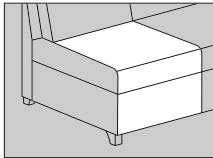

(R) Recliner - \$649
-Recliner fronts will always be upholstered*
-Models with recliners must have 3" arms

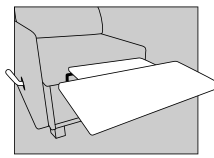

(D) Drawer
Choose between upholstered or laminate front
(UD) Upholstered** - \$1129
(LD) Laminate** - \$1299

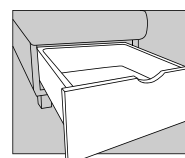

*If selecting recliner option (and NO DRAWER), place (UF) fully upholstered front in this box.

**If selecting drawer option, choose between upholstered drawer (UD) or laminate drawer (LD) and place in this box.

M	7	8	R		R	UF	
---	---	---	---	--	---	----	--

4. Select Center Options

(X) Fixed Front

-Choose between upholstered (standard) or thermofoil front
-Refer to page 14 for thermofoil options

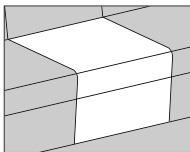

(C) Console Table

Refer to page 14 for thermofoil* or solid surface options
Thermofoil - \$819
Solid Surface - \$2249 (Group 2 finish add \$200)

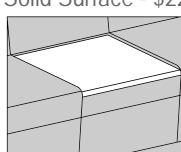

(L) Lift Table

Refer to page 14 for thermofoil or solid surface options
Thermofoil - \$2789
Solid Surface - \$4019 (Group 2 finish add \$200)

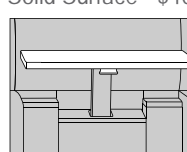

M	7	8	R	L	R	UF	
---	---	---	---	---	---	----	--

5. Select Arm Cap

(F) Upholstered Arms
Standard on model

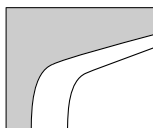

(T) Thermofoil Arm Caps
Refer to page 14 for thermofoil options

3" Arm - \$139
5" Arm - \$229

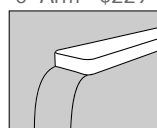

(U) Urethane Arm Caps
Refer to page 14 for urethane options

3" Arm - \$169
5" Arm - \$229

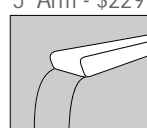

(J) Solid Surface Arm Caps
Refer to page 14 for solid surface options

3" Arm - \$619 (Group 2 finish add \$200)
5" Arm - \$1139 (Group 2 finish add \$200)



M	7	8	R	L	R	UF	J
---	---	---	---	---	---	----	---

6. Select Other Options

(ML) Metal Legs - \$279

(MB4B) Moisture Barrier Back \$179

(MB4S) Moisture Barrier Seat \$179

(CAL) CAL TB133 - \$150
(please refer to page 12)

(Z) Multi-Cover - Use Highest Grade

(Q3) 3" Dual Wheel Central Lock Caster
Not available on models with recliners or drawers
\$1019

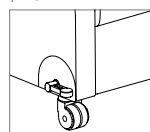

(CASTER) 3" Dual Swivel Locking Casters
\$199

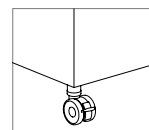

(POWER) USB Hospital Grade Power - \$569

-If lift table option is selected, power will be placed left side inner console. If no lift table option is selected, power will be placed on wide arm. If neither lift table or wide arm option is selected default position is front center of fixed front.

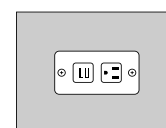



LA Z BOY[®]
HEALTHCARE



Mailing Address

P.O. Box 9
Ferdinand, IN 47532

getknu.com

Contact Us

812.367.2068
customerservice@getknu.com

7.01.22

Follow @GetKnu



La-Z-Boy[®] Healthcare | Knú Comfort[®] Copyright 2022. All Rights Reserved.

"La-Z-Boy" is a trademark of La-Z-Boy Incorporated. It is licensed to Knú, LLC and is used in accordance with the standards, specifications, and express permission of La-Z-Boy Incorporated.

