

MODUFORM

flexibility in furniture



2022 PRICE LIST

2022v08.17NYS

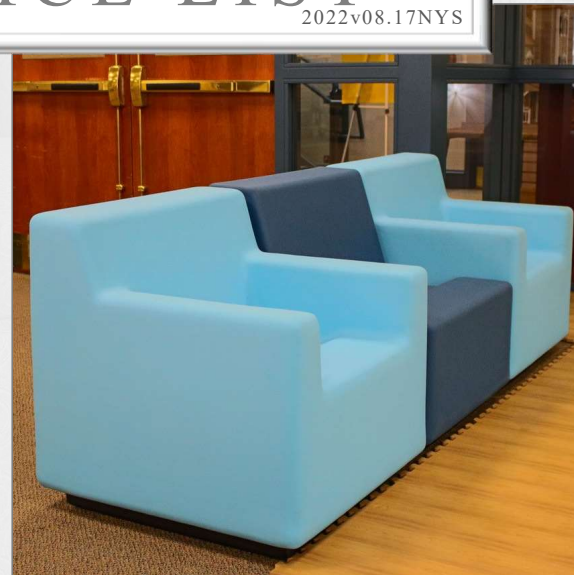
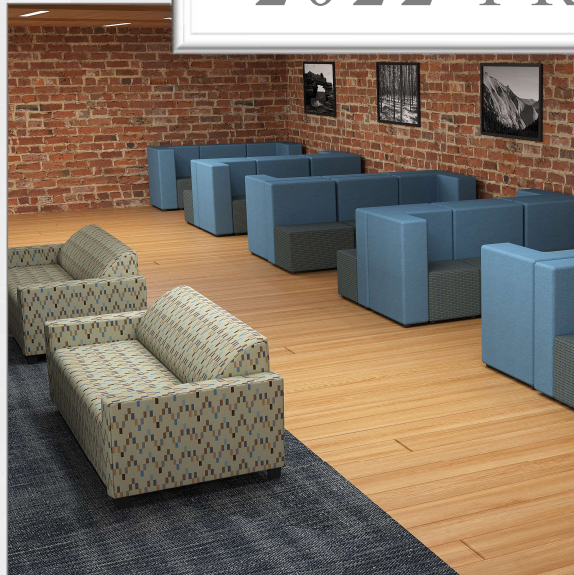

MOLDED | UPHOLSTERED | WOOD

A. General Information

Terms & Conditions	
COM (Customer Own Materials)	
Multiple Fabric	
COM Data Sheet	
Custom Finish	
Delivery Instructions	
Process Overview	

B. Molded Beds & Bedroom Furniture

Seclusion Bed	B1
Secure Seclusion Bed	B1
Moxie Molded Bedroom	B3

C. Bedroom Furniture & Mattresses

FIT	C4
Everest	C9
Roommate	C17
Lowell	C25
Transitions	C34
Fortress	C40
Zeal	C46

Mattresses | Box Springs | Sets

Boxsprings Foundations	C51
Mattresses	C51

D. Chairs: Plastic Stacking | Wood & Metal

Plastic Stacking

5000 ModuMaxx Stacking Chair	D2
5000 ModuMaxx Armless Chair	D3
5000 ModuMaxx Armchair	D3

Wood Multipurpose, Study & Dining

LS	D4
Two Position	D4
Mission	D5

E. Tables: Wood | Metal & Molded

Wood Tables

Acton	E3
Acton Carrels	E4
1150	E5
1160	E5
Eleven	E6
Trestle	E7
Mission	E7
MB ModuBlock Occasional	E8
HDT Heavy Duty Tables	E9

Metal & Molded Tables

ModuMaxx X-Base Tables	E12
ModuMaxx 4" Steel Leg Tables	E13
ModuMaxx Cluster 4 Attached Seats	E14
ModuMaxx Cluster 6 Attached Seats	E15
ModuMaxx Cluster 8 Attached Seats	E16

F. Lounge Seating: Molded | Wood Sided

Molded

520 ModuForm Lounge Seating	F6
528 ModuForm Lounge Seating	F7
3000 ModuSeat Beam Seating	F8
Aura Chair & Table	F13
5000-250 ModuMaxx Lounge Seating	F14

Wood Sided

RS Rounder	F18
800 ModuBlock	F20
810 ModuEsque	F22
MIS Mission	F24
SF Marco	F25
MM Marco Public Area Seating	F26
ROC Olive's Chair Rocker	F27

G. Seating | Fully Upholstered

Bristol	G6
Bristol Flex Cover	G7
Bounce	G8
Burke Recliner	G8
Chelsea	G9
Chelsea Flex Cover	G10
Chelsea Tables	G12
Chelsea Jr.	G13
Climb	G14
Collegetown	G15
Collegetown Flex Cover	G16
Collegetown Tight Seat	G18
Connect	G19
Dalton	G21
Emma	G29
Joanna	G30
Julia	G31
Julia Low Back	G38
Kensington	G40
Newman	G41
Peabody	G42
Salem	G43
Salem Flex Cover	G44
Sunday	G46
University	G47
Westminster	G49
William	G50
Wilmington	G51

H. Wood Shelving

Wood Library Shelving	H1
-----------------------	----

I. Replacement Components

Components	I1
------------	----

Customer Name:	Date:
Purchase Order #:	Item:
Project Name:	Date Needed:
	Quantity:

- Attach a fabric swatch indicating application on the listed seating.
- Each Fabric must have a separate COM form.

RAILROAD REPEAT

Fabric Width	Plain Fabric	1-5"	6-9"	10-13"	14-20"	21-27"	28-34"
54"	0%	+10%	+15%	+20%	+25%	+30%	+35%
50"	+15%	+15%	+20%	+25%	+30%	+35%	+40%
48"	+20%	+20%	+25%	+30%	+35%	+40%	+45%



UP THE ROLL REPEAT

Fabric Width	Plain Fabric	1-5"	6-9"	10-13"	14-20"	21-27"	28-34"
54"	0%	+15%	+20%	+25%	+30%	+35%	+40%
50"	+15%	+20%	+25%	+30%	+35%	+40%	+45%
48"	+20%	+25%	+30%	+35%	+40%	+45%	+50%



MULTIPLE FABRIC:

Should you request multiple fabrics on a single item, a Multiple Fabric Diagram must be supplied to Customer Service prior to the order being entered for production. Please contact Customer Service for the appropriate form.

GRADED IN:

ModuForm offers a “graded in” fabric program to simplify the textile selection process. Fabric mills and suppliers can change specifications without notice. When “graded-in” textiles are purchased by ModuForm and are found to need additional steps to ensure that the fabric will cut, stitch and upholster to ModuForm’s specifications (such as the need for backing or seam tape), additional charges may apply.

CUSTOMER’S OWN MATERIAL (COM):

Upholstered products may be ordered using customer’s own fabric or vinyl (COM). Fees are found in the most recent Price List under the column labeled “COM”. These amounts contain only the product and labor for the application of the fabric. Upholstery grade textiles only will be considered for use. COM yardage estimates are based on 54” wide textiles without pattern repeat.

ModuForm requires the submittal of a “COM Data Sheet” (attached) to accompany a fabric memo sample and associated data and specifications for each selected fabric. This is to be submitted with your purchase order. Since some fabrics are considered “reversible”, please ensure that the exposed side is clearly marked. Upon receipt of the memo sample, ModuForm will determine if the fabric can be upholstered on selected furniture. Customer Service will notify you upon the approval of the fabric with an order acknowledgment.

Please submit purchase orders to: orders@moduform.com

Please send fabric memo samples, COM Data Sheet and, once approved, fabric to:

ModuForm, Inc.

C/O Upholstery Department COM

7626 Cavalier Way

Connelly Springs, NC 28612

Once approved, all fabric should ship to ModuForm (see address above), freight pre-paid, in continuous yards and must be backed upon arrival at the factory. Fabric should be from the same dye lot. ModuForm is not responsible for delivery delays or for inspecting the COM. ModuForm cannot begin the manufacturing process until the COM is received. If it is determined by the ModuForm upholstery department that additional steps are required, such as backing or taping, added charges will need to be approved before any additional manufacturing will resume.

ModuForm will not warrant or determine the actual performance of COM fabric, nor will ModuForm determine compliance against any local life-safety or building codes. ModuForm assumes no responsibility for tailoring issues, seam slippage, appearance, durability, fading, match or overall fabric performance. Due to the variety of cleaning agents and environmental conditions, ModuForm suggests each fabric be tested with the preferred cleaning agents.

Company Name:		Point of Contact:		
Address:		Email:		
City:	State:	Zip:	Phone:	
Phone:				
Supplier/Mill:		Phone Number:		
Material Pattern:		Material Color/Number:		
Repeats (Horizontal or Vertical):		Backing:	Type:	
Fabric In Stock:		Ship Complete:		
Ship Date:		Yards on Backorder:		
Backorder Ship Date:				

**Send Sample &
Data Sheet to:**
 ModuForm, Inc
 7626 Cavalier Way.
 Connelly Springs, NC
 28612
 Attn: Upholstery Manager

ATTACH FABRIC SAMPLE, FACE SIDE UP IN THE DIRECTION IT IS TO BE APPLIED

Model:				
Qty:				
Note: Fabric must be TAGGED with PO# and Customer Name Fabric will be applied according to supplier recommendations unless otherwise instructed COM must be shipped in continuous yardage from the fabric supplier				
FOR OFFICE USE ONLY:				
Yards Required:			Request Date	
Requested By:				
Approved By:				
Approved Date:				

COMPANY INFORMATION:

Send Sample & Data Sheet to:
 ModuForm, Inc
 172 Industrial Road
 Fitchburg, MA 01420
 Attn: Customer Service

Company Name:	Point of Contact:		
Address:	Email:		
City:	State:	Zip:	Phone:
Phone:			

FINISH REQUESTED:

Laminate Color Part Number:	Manufacturer:
Edge Band Color Part Number:	Manufacturer:
Wood (solid/veneer):	Species:

SHIP TO FOR MATCH APPROVAL:

Company Name:	Point of Contact:		
Address:	Email:		
City:	State:	Zip:	Phone:

FOR OFFICE USE ONLY:

Request Date:	Date:	
Requested By:		
Approved By:	Order Quote #	
Approved Date:		

IMPORTANT SHIPPING NOTICE

Thank you for ordering ModuForm furniture! We appreciate your business and are intent on making your buying experience positive. To ensure a smooth delivery of your furniture please read the information below carefully and call us at **(800) 221-6638** with any questions; we are here to help!

Your furniture will be shipped via common carrier. If your delivery requirements change during the process, an amended quote and/or PO Change Order will be required *prior to* shipment.

STEPS TO ENSURE A SUCCESSFUL DELIVERY

1. An authorized representative of your organization must be available to receive and sign for the product.
2. Please examine each carton for damage while the driver is present.
3. If damage is visible, do not reject the delivery. Accept the goods by signing the Bill of Lading and write “Visible Damage”.
4. If hidden damage is suspected (concealed damage), please sign the Bill of Lading noting “possible concealed damage.”
5. Please open and inspect the furniture within 24 hours.
6. If you find damage, you must keep all packing material until advised by ModuForm.
7. Take photos of the packaging before uncrating. Also take photos of the damaged product.
8. Contact ModuForm Customer Service immediately at **(800) 221-6638** to report the details.

SHORTAGES

1. If the shipment delivered to you is not in accordance with the quantity of cartons shown on your Bill of Lading or Acknowledgment, BE SURE TO NOTE ALL SHORTAGES ON THE BILL OF LADING.
2. Contact ModuForm Customer Service immediately at **(800) 221-6638** to report the shortage.

REMEMBER

ModuForm holds no responsibility of goods damaged in transit. Damages must not be deducted from the ModuForm invoice, nor payment withheld awaiting resolution of such claims or receipt of replacement material.

**IF YOUR SHIPMENT IS TO BE MADE DIRECTLY TO ANOTHER ADDRESS
PLEASE FORWARD THIS NOTICE TO THE RECEIVING PARTY.**

THE MOST...durable and environmentally friendly wood finish available

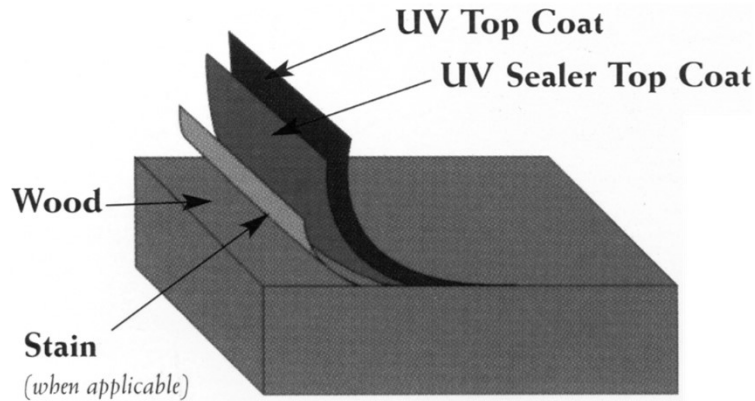

ModuForm has been a pioneer in preserving the balance between technology and a healthy, thriving environment. In fact, we've received awards for our work in reducing emissions of solvents and volatile organic compounds (VOC's).

Our specially formulated ModuV is a perfect example of our dedication to protecting the environment while providing our customers with the most durable and highest quality products. Here are several reasons why ModuForm's finishing technology is the best available:

✓ Our Flat Line System

- Our conveyor fed system is continuously moving parts under roll coat applicators where specially formulated sealer and top-coat resin finish material is pressure transferred from an applicator on to the wood surface. This ensures that 100% of the part face receives 100% solids-based finish. This is the most durable and environmentally friendly process available.
- Once parts are coated with resin, they are instantly "dried" under unique UV lamps. This hardens the finish so that it is impervious to discoloration, most food and beverage stains, abrasions from paper, books and writing instruments and is tough enough to withstand harsh cleaning solvents and even nail polish remover.

✓ The ModuV Difference

- Conventional wood finishes such as urethanes, varnishes and lacquers are about 90% solvent based and require air drying. Therefore, approximately 90% of the finish evaporates into the atmosphere meaning only about 10% stays on the part. This makes it far less durable for you and much more harmful to the environment!
- ModuV finish is instantly "dried" by unique Ultra-Violet light so there is no evaporation and nothing is released into the environment.
- ModuV is 100% solids based and is applied using a pressure process with a roll coat applicator. This means that nothing evaporates and we transfer 100% of the resin-based material to the part. Anything left over is reclaimed and applied to the next piece in line. This can make ModuForm's finish more than 250% more durable than others.

Parts are Staged



Parts are Conveyed Down the Line



Finish is Rolled onto the Part



Parts are 100% Ready for Use



ROTATIONAL MOLDING...what is it?

- ✓ ModuForm has been rotationally molding furniture since 1976. Our Rotomolded products have a hollow core such that they can either be filled with foam or left empty. These products provide flexible, seamless, uniform, comfortable and fluid resistant furniture. We have a variety of different size molds that are secured to large rotating arm-plates.
- ✓ The process involves molds being “charged” or “shot” with a pre-measured amount of material so that they can be cured at high temperature in a heating chamber where arm-plates rotate and tumble upon a fixed axis point. This allows the material to evenly distribute and fuse against the inner surface of the mold. Once the curing process is complete, the arm-plates are cooled and the parts are demolded.
- ✓ ModuForm items containing rotationally molded parts can be found in 450, 520, 528, 800, 810, 3000, 5000, and MX
- ✓ ModuForm items containing molded foam parts can be found in 450, 520, 528, 800, 810, MX

ROTATIONAL MOLDING



MOLDED FOAM



ModuForm 520 series rotationally molded, flexible and molded foam filled vinyl lounge furniture.



ModuForm's ModuMaxx 5000 series rotationally molded rigid polyethylene lounge furniture.

ROTATIONALLY MOLDED AND FOAM CUSHIONS

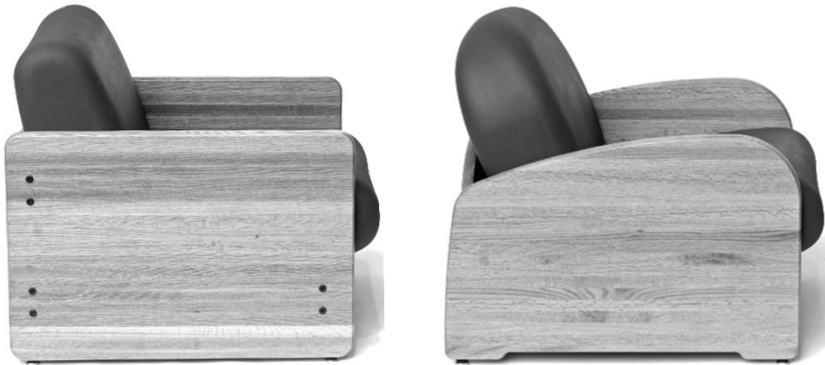

Rotationally Molded Vinyl Skin with Mold Foam Core



Molded Foam Core for Textiles

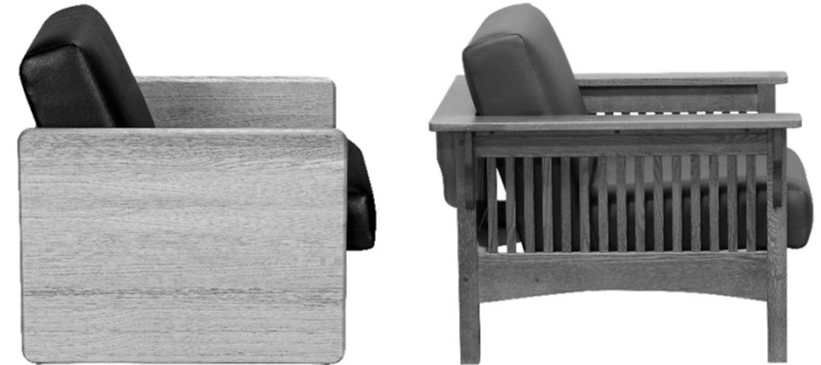

Puzzle Cut Plywood Frame with Cut Foam Core for Textiles

ModuForm Manufactures Three Different Cushion Types:

1. Rotationally molded vinyl cushions are either 200 mils or 250 mils thick. They are seamless, sealed, homogenous in color, easy to wipe clean and feature concealed steel infrastructure for secure metal-to-metal bolt on attachment. A high-density, flexible Polyurethane liquid foam is dispensed into the core of the cushion skin which bonds to the inside surface of the cushion creating the most secure, safe and durable cushion available. The cushions are found on:
 - 800 ModuBlock, 810 ModuEsque, 3000 ModuSeat Beam
2. "Skinless" molded foam is produced for use with fabric covers. This high-density, flexible Polyurethane cushion is molded to shape and will meet the demands of intensive use environments. A steel structure is concealed within the cushion for secure metal-to-metal bolt on attachment. Available on:
 - 800 ModuBlock, 810 ModuEsque
3. High quality puzzle cut plywood frames feature heavy gauge arched springs and commercial grade foam. Cushion sets are fastened to the frame with high grade mechanical fasteners. Available on:
 - Rounder, Mission, Marco, Mini Marco

ROTATIONALLY MOLDED BEAM SEATING



3000 Series ModuSeat
(Molded Foam Filled Core)

5000 Series ModuMaxx



Beam seating features two (2) different rotationally molded seat options:

1. 3000 series ModuSeat beam features rotationally molded flexible vinyl cushions. Cushions are seamless, sealed, homogenous in color, easy to wipe clean and feature concealed steel frame for secure metal-to-metal bolt on attachment. Cushions are pressure foam filled bonded to the inner skin of the piece.
2. 5000 series ModuMaxx beam seats feature rotationally molded rigid plastic seats. These seats are seamless, sealed, homogenous in color, easy to wipe clean and feature concealed steel inserts for secure metal-to-metal bolt on attachment.

INJECTION MOLDED STACKING CHAIR

ModuForm has been injection molding high-use stacking armchairs for more than 25 years. Our process is designed to produce chairs in large volume to very accurate and exacting specifications. The high-impact copolymer Polypropylene material contains UV light stabilizers, anti-static additives and homogeneous color. The molding process only takes seconds and packs molten plastic into a sophisticated mold that has been methodically designed and engineered. The buildup of pressure holds the material in shape while cooling to solidify the chair.



STATEMENT OF LINE

Molded Polyvinyl Seclusion | Flexible Foam Filled



450-10 | Non-Secure | Seclusion Bed



450-11 | Secure Seclusion Bed | Restraint Rings

****PLEASE NOTE:**

Restraint rings cannot be added to the 450-10 bed after manufacturing.

If restraint rings are needed (when restraint straps are necessary) the 450-11 model should be ordered.

Restraint straps not included.





SECLUSION | 450

Standard Features:

- Grade 7 vinyl is 200 mil thick
- Rotationally molded vinyl skin is seamless for ease of cleaning, safety and security
- Pigmented color is homogeneous throughout rather than just the skin surface
- Vinyl can be cleaned with mild detergents, steam and can be sanitized with bleach-based agents
- Flame retardant and self extinguishing | Passes CAL TB 133
- High-Impact molded base (standard black color) | fully gasketed and secured
- Rotationally molded mattress is 14"h | High-impact base is 4"h

Standard Rotomolded Vinyl Colors:

- 210 | Sky
- 215 | Plum
- 220 | Leaf
- 225 | Splash
- 230 | Canyon
- 318 | Burgundy
- 403 | Huckleberry
- 426 | Slate Blue
- 700 | Sandstream
- 845 | Flannel Grey
- 901 | Black



450-10

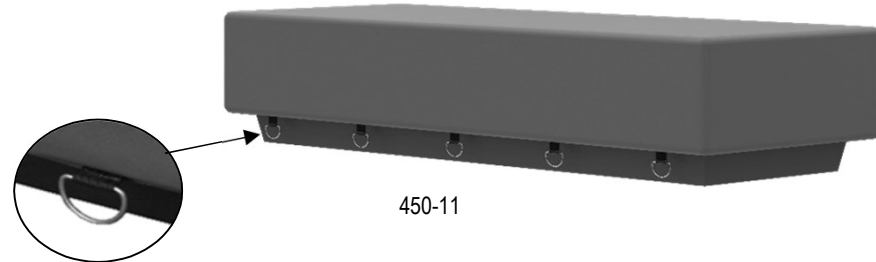

450-11

MODEL	COVER	DESCRIPTION	DIMENSION	BASE HEIGHT	WT	LIST
450-10	PVC	Bed	30"d x 80"w x 18"h	4"h	200 lbs	\$5,783
450-11	PVC	Restraint Bed	30"d x 80"w x 18"h	4"h	205 lbs	\$6,029
Restraint rings are zinc plated steel held in place by continuous woven polypropylene webbing 5 rings per side The webbing shall be fastened between the rotomolded bed and base, rendering it secure and non-accessible Restraint straps not included						

OPTIONS:



450-AN-KT1 Floor Anchoring Kit | Set of Four - Lock Not Included \$702
 *Hardware to secure floor anchoring kit to the floor not included.



STRAP-36-BK Additional Restraint Rings - Factory Installed. Two Rings per Bed - One Ring Each Side. \$44
 *Rings are secured to a full length concealed nylon strap (see image) - one ring per end

****PLEASE NOTE:**

Restraint rings cannot be added to the 450-10 bed after manufacturing.
 If restraint rings are needed (when restraint straps are necessary) the 450-11 model should be ordered.

STATEMENT OF LINE



MX9 | Molded Platform Bed



MX9-COT | Molded Stacking Cot



MX6WU-40 | Slope Top Wall Unit



MX4A-30 | Dresser/Storage



MX3YNP | Writing Desk



MX3WD | Wall Mount Desk



MX2-10 | Wall Shelf



MX5-20 | Molded Nightstand



MXST | Molded Stool





MOXIE | MX

Standard Features:

- One-piece rotationally molded construction without steel or wood components of any kind
- Pigmented color is homogeneous throughout rather than just the skin surface
- Foam filled for strength, weight and noise dampening
- Clean with mild detergents or steam and can be sanitized with bleach-based agents
- Flame retardant and self extinguishing | Passes CAL TB 133

MX9 Standard Colors:

- 318 | Burgundy
- 426 | Slate Blue
- 902 | Shade



MODEL	DESCRIPTION	DIMENSION	WT	LIST
MX5-20	Nightstand - 1 Shelf, 2 Openings	18"d x 24"w x 24"h	31 lbs	\$898
MX4A-30	Dresser - Storage - 3 Openings	18"d x 30"w x 42"h	59 lbs	\$1,347
MX6WU-40	Wall Unit - Slope Top - 4 Openings	14"d x 27"w x 68.25"h	76 lbs	\$1,574
MX2-10	Shelf - 1 Opening	13"d x 31"w x 21"h	22 lbs	\$770
MX3YNP	Writing Desk - Full Modesty Panel	24"d x 36"w x 30"h	49 lbs	\$1,406
MX3WD	Desk - Wall Mount	23"d x 37.5"w x 26"h	-	\$1,138

MXST	Stool	15"d x 18"w x 18"h	9 lbs	\$453
------	-------	--------------------	-------	-------

**NOTE: MXST Available in 318 Burgundy, 360 Grape, 426 Slate Blue, 445 Surf, 525 Celtic, 901 Black and 902 Shade*

OPTIONS	DESCRIPTION	LIST
16N	Mounting Kit: Nightstand (MX5) & Writing Desk (MX3YNP) Floor Mounting Brackets and Compression Limiters Only	\$59
16N	Mounting Kit: Dresser (MX4), Wall Unit (MX6), Wall Desk (MX3WD) Floor & Wall Mounting Compression Limiters Only	\$59
16N	Mounting Kit: Stool (MXST), Wall Shelf (MX2) Compression Limiters Only	\$59



MOXIE | MX

Standard Features:

- One-piece rotationally molded construction without steel or wood components of any kind
- Pigmented color is homogeneous throughout rather than just the skin surface
- Foam filled for strength, weight and noise dampening
- Clean with mild detergents or steam and can be sanitized with bleach-based agents
- Flame retardant and self extinguishing | Passes CAL TB 133
- Will fit 36" x 80" Mattress | Sold Separately

MX9 Standard Colors:

- 318 | Burgundy
- 426 | Slate Blue
- 902 | Shade

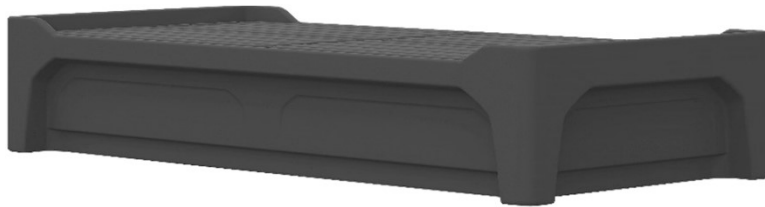

MODEL	DESCRIPTION	DIMENSION	DECK HT	WT	LIST
MX9	Platform Bed	40"d x 84"w x 17.5"h	15.5"h	118 lbs	\$2,927

OPTIONS	DESCRIPTION	LIST
16N	Mounting Kit: Bed (MX9) Floor Mounting Brackets and Compression Limiters Only	\$134
35	Headboard (standard ModuForm Laminates - Black Edge) Mounts to Wall (hardware not included)	\$291

Standard Features:

- One-piece rotationally molded construction without steel or wood components of any kind
- Clean with mild detergents or steam and can be sanitized with bleach-based agents
- Flame retardant and self extinguishing | Passes CAL TB 133
- Will fit 25" x 75" Mattress | Sold Separately
- Stack 20 High

MX9-COT Standard Color:

- 426 | Slate Blue



MODEL	DESCRIPTION	DIMENSION	DECK HT	WT	LIST
MX9-COT-426	Stacking Cot	30.75"d x 82.25"w x 8.25"h	8.25"h	35 lbs	\$809

STATEMENT OF LINE



FIT
Oak Veneer and Laminate



EVEREST
Oak Veneer, Solid Oak and Laminate



LOWELL
Post and Panel, Solid Oak and Laminate



FORTRESS
Solid Oak and Oak Veneer
No Drawers



TRANSITIONS
Oak Veneer and Laminate
No Drawers



ZEAL
Oak Veneer and Laminate



ROOMMATE BEDS
Solid Oak & Oak Veneer

STATEMENT OF LINE | HANDLES & PULLS

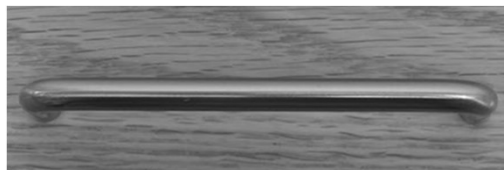

HANDLE P7
WIRE PULL | NICKEL



HANDLE P7B
WIRE PULL | BLACK

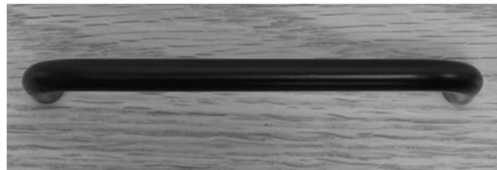

HANDLE P15
ROUTED CRESCENT
STANDARD ON LOWELL

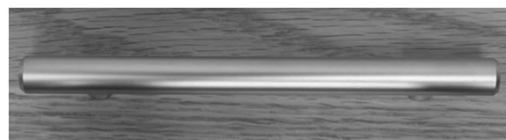

HANDLE P1
BAR PULL | NICKEL

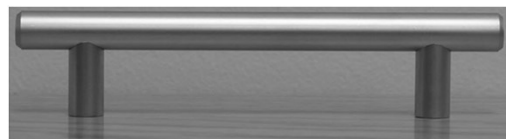

HANDLE P1B
BAR PULL | BLACK

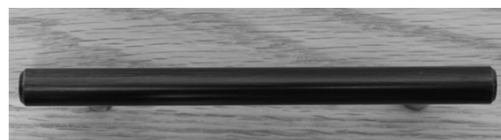

HANDLE P3
BOW PULL | NICKEL



HANDLE P3B
BOW PULL | BLACK

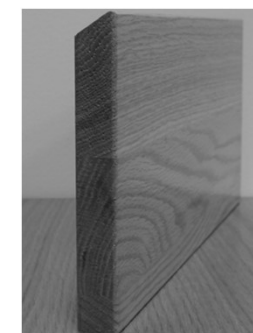
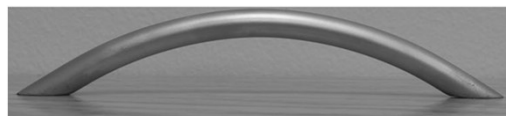
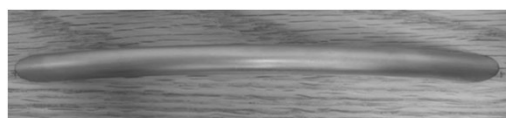

FINGER BEVEL
STANDARD ON
ROOMMATE | PASSAGES

*Handles and pulls are subject to availability and may change with out notice.
Additional styles and colors offered. Please call to confirm.*

Casegoods Tops

Standard laminate and Edges:

Top	Manufacturer	Model	Name	Edge
Natural Oak	Formica	7152-58	Northern Oak	Natural Oak
Light Cherry on Oak	Formica	6208-58	Glamour Cherry	Oiled Cherry
Cherry on Oak	Formica	7759-58	Select Cherry	Select Cherry
Stone on Oak	Formica	6413-58	Silver Riftwood	Silver Riftwood
Dark Mocha on Oak	Formica	8848-58	Blackened Legno	Blackened Legno
Walnut on Oak	Formica	6402-42	Thermo Walnut	Thermo Walnut
Natural Maple	Formica	86992-58	Hard Rock Maple	Hard Rock Maple
Light Cherry on Maple	Formica	5904-43	Wild Cherry	Wild Cherry
Cherry on Maple	Formica	7759-58	Select Cherry	Select Cherry
Stone on Maple	Formica	6413-58	Silver Riftwood	Silver Riftwood
Dark Mocha on Maple	Formica	8848-58	Blackened Legno	Blackened Legno
Walnut on Maple	Formica	6402-42	Thermo Walnut	Thermo Walnut
White - Writable	Formica	949-90	Gloss White	White
Black	Formica	909-58	Matte Black	Black

Standard laminates are available on all tops.

Series	Model	Top & Edge
FIT	All	HPL & PVC
Everest	All	HPL & PVC
Lowell	All	HPL & PVC
Transitions	All	HPL & PVC
Fortress	All	Solid Wood

FIT | DESK | MOBILE PEDESTAL

Standard Features:

Standard Finish is Natural Oak
 Cabinet: Red Oak Veneer Sides and Drawer Fronts
 Top: Oak grain HPL with Matching External Thermoplastic Edge
 Drawer Front Drilled for Standard ModuForm Bar Pull | 96MM
 All Exterior Wood Components & Drawer Parts Sealed with ModuV
 ModuV is Our Specially formulated 100% Resin Top-Coat for Ease of Cleaning and Durability

ModuForm Finishes:

Standard wood finish is Natural Oak
 Available wood finishes: Light Cherry, Cherry, Stone, Dark Mocha, Walnut
 *Please add stain upcharge for all standard finishes detailed above to list price
 Option: For custom wood finish, please add \$600 NET plus listed stain upcharge



FIT3A-1D20



FIT3A-3D



FIT3YNP



FIT3MP-2D

MODEL	DESCRIPTION	DRAWERS	OPENINGS	DIMENSION	WT	LIST	*STAIN
FIT3A-1D20	Desk Pedestal	1	2	24"d x 42.5"w x 30"h	92 lbs	\$1,126	+\$99
FIT3A-3D	Desk Pedestal	3	-	24"d x 42.5"w x 30"h	110 lbs	\$1,309	+\$99
FIT3YNP	Desk Writing	-	-	24"d x 36.5"w x 30"h	65 lbs	\$708	+\$99
FIT3MP-2D	Mobile Pedestal	2	-	18"d x 16.25"w x 22.25"h	82 lbs	\$874	+\$56

Casters are ready to attach on-site

OPTIONS	DESCRIPTION	LIST
6	Lock Drawer Lock (cylinder style with strike plate) - per drawer*	\$114
37	Lock Lock Hasp Kit for Drawers - per drawer	\$51
11	Kneespace Pencil Tray Pedestal Desk Only	\$210
11NP	Kneespace Pencil Tray YNP & ANP Models Only	\$228
34	Kneespace Sculptured Keyboard Tray - Pedestal Desk Only	\$213
34NP	Kneespace Sculptured Keyboard Tray YNP & ANP Models Only	\$243
47	Drawer Restriction Prevents removal Kneespace Drawer Only	\$46
10	Drawer Restriction Prevents removal Per drawer	\$27

*If "keyed alike" locks or "master keys" are required, additional charges may apply.

FIT | DRESSER

Standard Features:

Standard Finish is Natural Oak
 Cabinet: Red Oak Veneer Sides and Drawer Fronts
 Top: Oak grain HPL with Matching External Thermoplastic Edge
 Drawer Front Drilled for Standard ModuForm Bar Pull | 96MM
 All Exterior Wood Components & Drawer Parts Sealed with ModuV
 ModuV is Our Specially formulated 100% Resin Top-Coat for Ease of Cleaning and Durability

ModuForm Finishes:

Standard wood finish is Natural Oak
 Available wood finishes: Light Cherry, Cherry, Stone, Dark Mocha, Walnut
 *Please add stain upcharge for all standard finishes detailed above to list price
 Option: For custom wood finish, please add \$600 NET plus listed stain upcharge



FIT4Y-24



FIT4A-18
FIT4A-24



FIT4B-18
FIT4B-24



FIT4C-18
FIT4C-24

MODEL	DESCRIPTION	DRAWERS	OPENINGS	DIMENSION	WT	LIST	*STAIN
FIT4Y-24	Dresser	2	-	24"d x 30.5"w x 20.5"h	95 lbs	\$984	+\$99
FIT4A-18	Dresser	3	-	18"d x 30.5"w x 30"h	105 lbs	\$1,203	+\$99
FIT4A-24	Dresser	3	-	24"d x 30.5"w x 30"h	115 lbs	\$1,237	+\$99
FIT4B-18	Dresser	4	-	18"d x 30.5"w x 39.5"h	120 lbs	\$1,528	+\$99
FIT4B-24	Dresser	4	-	24"d x 30.5"w x 39.5"h	125 lbs	\$1,580	+\$99
FIT4C-18	Dresser	5	-	18"d x 30.5"w x 49"h	130 lbs	\$1,737	+\$99
FIT4C-24	Dresser	5	-	24"d x 30.5"w x 49"h	135 lbs	\$1,796	+\$99

OPTIONS	DESCRIPTION	LIST
6	Lock Drawer Lock (cylinder style with strike plate) - per drawer*	\$114
37	Lock Lock Hasp Kit for Drawers - per drawer	\$51
10	Drawer Restriction Prevents removal Per drawer	\$27

*If "keyed alike" locks or "master keys" are required, additional charges may apply.

FIT | NIGHTSTAND

Standard Features:

Standard Finish is Natural Oak
 Cabinet: Red Oak Veneer Sides and Drawer Fronts
 Top: Oak grain HPL with Matching External Thermoplastic Edge
 Drawer Front Drilled for Standard ModuForm Bar Pull | 96MM
 All Exterior Wood Components & Drawer Parts Sealed with ModuV
 ModuV is Our Specially formulated 100% Resin Top-Coat for Ease of Cleaning and Durability

ModuForm Finishes:

Standard wood finish is Natural Oak
 Available wood finishes: Light Cherry, Cherry, Stone, Dark Mocha, Walnut
 *Please add stain upcharge for all standard finishes detailed above to list price
 Option: For custom wood finish, please add \$600 NET plus listed stain upcharge



FIT5A-1D



FIT5A-2D



FIT5B-1D



FIT5B-3D

MODEL	DESCRIPTION	DRAWERS	OPENINGS	DIMENSION	WT	LIST	*STAIN
FIT5A-1D	Nightstand	1	1	18"d x 16.25"w x 20.5"h	30 lbs	\$713	+\$56
FIT5A-2D	Nightstand	2	-	18"d x 16.25"w x 20.5"h	35 lbs	\$821	+\$56
FIT5B-1D	Nightstand	1	1	18"d x 16.25"w x 30"h	42 lbs	\$779	+\$56
FIT5B-3D	Nightstand	3	-	18"d x 16.25"w x 30"h	45 lbs	\$978	+\$56

OPTIONS	DESCRIPTION	LIST
6	Lock Drawer Lock (cylinder style with strike plate) - per drawer*	\$114
37	Lock Lock Hasp Kit for Drawers - per drawer	\$51
10	Drawer Restriction Prevents removal Per drawer	\$27

*If "keyed alike" locks or "master keys" are required, additional charges may apply.

FIT | WARDROBE

Standard Features:

Standard Finish is Natural Oak
 Cabinet: Red Oak Veneer Sides, Drawer Fronts and Doors
 Top: Oak Grain with Matching External Thermoplastic Edge
 Hardware: Hinge is 270° 5-Knuckle | Doors and Drawers Drilled for Standard ModuForm Bar Pull | 96MM
 Single Door Wardrobe Doors Open Left
 All Exterior Wood Components & Drawer Parts Sealed with ModuV
 ModuV is Our Specially formulated 100% Resin Top-Coat for Ease of Cleaning and Durability

ModuForm Finishes:

Standard wood finish is Natural Oak
 Available wood finishes: Light Cherry, Cherry, Stone, Dark Mocha, Walnut
 *Please add stain upcharge for all standard finishes detailed above to list price
 Option: For custom wood finish, please add \$600 NET plus listed stain upcharge



FIT6B20-1D



FIT6B



FIT6C120-1D



FIT6C1



FIT6C220-1D



FIT6C2

MODEL	DESCRIPTION	DRAWERS	DIMENSION	WT	LIST	*STAIN
FIT6A	with Clothes Pole	-	24"d x 30.5"w x 59.25"h	160 lbs	\$1,926	+\$220
FIT6B20-1D	with Clothes Pole Hat Shelf	-	24"d x 20.5"w x 75"h	150 lbs	\$1,688	+\$220
FIT6B	with Clothes Pole Hat Shelf	-	24"d x 30.5"w x 75"h	175 lbs	\$2,197	+\$220
FIT6C120-1D	with Clothes Pole Drawer Shoe Shelf	1	24"d x 20.5"w x 75"h	150 lbs	\$2,067	+\$220
FIT6C1	with Clothes Pole 1 Drawer Shoe Shelf	1	24"d x 30.5"w x 75"h	190 lbs	\$2,536	+\$220
FIT6C220-1D	with Clothes Pole 2 Drawers	2	24"d x 20.5"w x 75"h	160 lbs	\$2,101	+\$220
FIT6C2	with Clothes Pole 2 Drawers	2	24"d x 30.5"w x 75"h	200 lbs	\$2,724	+\$220

FIT | WARDROBE | OPTIONS

OPTIONS	DESCRIPTION	LIST
5	Lock Wardrobe Door Lock Kit (cylinder style with and without slide bolt)*	\$157
6	Lock Drawer Lock (cylinder style with strike plate) - per drawer*	\$114
37	Lock Lock Hasp Kit for Drawers - per drawer	\$51
10	Drawer Restriction Prevents removal Per drawer	\$27
25	Center Divider Wardrobe	\$483
26	Mirror Unframed glass mirror, 12 x 22, clipped to inside wardrobe door	\$106
V	Shelf Fixed Per shelf	\$192

*If "keyed alike" locks or "master keys" are required, additional charges may apply.

EVEREST | DESK | MOBILE PEDESTAL

Standard Features:

Standard Finish is Natural Oak
 Cabinet: Red Oak Veneer, Hardwood Plycore Sides
 Drawer Front: Solid Planked Red Oak with Full Length Finger Bevel on Top Edge
 Top: Oak grain HPL with Matching External Thermoplastic Edge
 All Exterior Wood Components & Drawer Parts Sealed with ModuV
 ModuV is Our Specially formulated 100% Resin Top-Coat for Ease of Cleaning and Durability

ModuForm Finishes:

Standard wood finish is Natural Oak
 Available wood finishes: Light Cherry, Cherry, Stone, Dark Mocha, Walnut
 *Please add stain upcharge for all standard finishes detailed above to list price
 Option: For custom wood finish, please add \$600 NET plus listed stain upcharge



EV3A-1D20



EV3A
EV3B



EV3YNP



EV3MP



EV3MP-1D-20

MODEL	DESCRIPTION	DRAWERS	OPENINGS	DIMENSION	WT	LIST	*STAIN
EV3A-1D20	Desk Pedestal	1	2	24"d x 42"w x 30"h	85 lbs	\$1,273	+\$99
EV3A	Desk Pedestal	3	-	24"d x 42"w x 30"h	100 lbs	\$1,449	+\$99
EV3B	Desk Pedestal	3	-	24"d x 48"w x 30"h	110 lbs	\$1,474	+\$99
EV3YNP	Desk Writing	-	-	24"d x 36"w x 30"h	65 lbs	\$714	+\$99
EV3MP	Mobile Pedestal	2	-	18"d x 15.75"w x 21.5"	82 lbs	\$901	+\$56
	<i>Casters are ready to attach on-site</i>						
EV3MP-1D-20	Mobile Pedestal	1	2	18"d x 15.75"w x 31.5"	82 lbs	\$968	+\$56



EVEREST | BOOKCASE

Standard Features:

Standard Finish is Natural Oak

Cabinet: Red Oak Veneer, Hardwood Plycore Sides and Fixed Oak Veneer Shelves

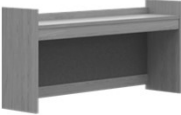
All Exterior Wood Components & Drawer Parts Sealed with ModuV

	MODEL	DESCRIPTION	OPENINGS	DIMENSION	WT	LIST	*STAIN
	EV3ADB1	Desktop Bookcase	1	10"d x 42"w x 22"	30 lbs	\$510	+\$56
	EV3BDB1	Desktop Bookcase	1	10"d x 48"w x 22"	50 lbs	\$664	+\$56
	EV3ADB2	Desktop Bookcase	2	10"d x 42"w x 34"	30 lbs	\$740	+\$56
	EV3BDB2	Desktop Bookcase	2	10"d x 48"w x 34"	50 lbs	\$814	+\$56
	EV2A-10	Bookcase	2	10"d x 30"w x 30"h	60 lbs	\$694	+\$66
	EV2B	Bookcase	3	12"d x 36"w x 48"h	83 lbs	\$893	+\$66
	EV2D	Bookcase	5	12"d x 36"w x 72.25"h	120 lbs	\$1,641	+\$66

EVEREST | DESK & BOOKCASE OPTIONS

OPTIONS	DESCRIPTION	LIST
6	Lock Drawer Lock (cylinder style with strike plate) - per drawer*	\$114
37	Lock Lock Hasp Kit for Drawers - per drawer	\$51
11	Kneespace Pencil Tray Pedestal Desk Only	\$210
11NP	Kneespace Pencil Tray YNP & ANP Models Only	\$228
34	Kneespace Sculptured Keyboard Tray - Pedestal Desk Only	\$213
34NP	Kneespace Sculptured Keyboard Tray YNP & ANP Models Only	\$243
47	Drawer Restriction Prevents removal Kneespace Drawer Only	\$46
29	Plywood Package Cabinet Backs Drawer Bottoms - per cabinet	\$66
31R	Light Rapid start fluorescent fixture with outlet Attach underside of bottom shelf desktop bookcase	\$175
31L	Light LED fixture Attach underside of bottom shelf desktop bookcase	\$127
32	Tackboard Frameless Cork for back of desktop bookcase	\$113

*If "keyed alike" locks or "master keys" are required, additional charges may apply.

EVEREST | DRESSER

Standard Features:

Standard Finish is Natural Oak
 Cabinet: Red Oak Veneer, Hardwood Plycore Sides
 Drawer Front: Solid Planked Red Oak with Full Length Finger Bevel on Top Edge
 Top: Oak grain HPL with Matching External Thermoplastic Edge (Toasted Hardboard EV4UB)
 All Exterior Wood Components & Drawer Parts Sealed with ModuV
 ModuV is Our Specially formulated 100% Resin Top-Coat for Ease of Cleaning and Durability

ModuForm Finishes:

Standard wood finish is Natural Oak
 Available wood finishes: Light Cherry, Cherry, Stone, Dark Mocha, Walnut
 *Please add stain upcharge for all standard finishes detailed above to list price
 Option: For custom wood finish, please add \$600 NET plus listed stain upcharge

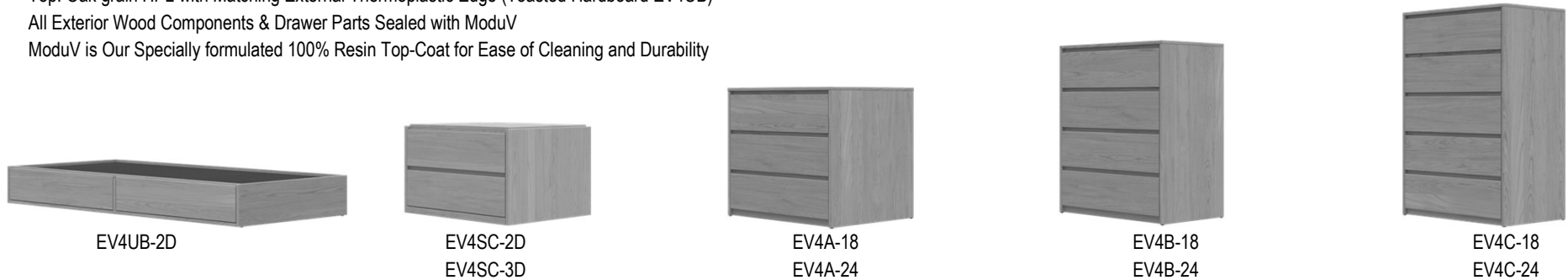

MODEL	DESCRIPTION	DRAWERS	DIMENSION	WT	LIST	*STAIN
EV4UB-2D	Underbed Chest	2	24"d x 73.75"w x 9.5"h	90 lbs	\$1,600	+\$99
EV4SC-2D	Stack Chest	2	24"d x 30"w x 20.25"h	80 lbs	\$1,133	+\$99
EV4SC-3D	Stack Chest	3	24"d x 30"w x 29.5"h	80 lbs	\$1,302	+\$99
EV4A-18	Dresser	3	18"d x 30"w x 30"h	105 lbs	\$1,196	+\$99
EV4A-24	Dresser	3	24"d x 30"w x 30"h	115 lbs	\$1,284	+\$99
EV4B-18	Dresser	4	18"d x 30"w x 39"h	110 lbs	\$1,506	+\$99
EV4B-24	Dresser	4	24"d x 30"w x 39"h	115 lbs	\$1,556	+\$99
EV4C-18	Dresser	5	18"d x 30"w x 48"h	140 lbs	\$1,695	+\$99
EV4C-24	Dresser	5	24"d x 30"w x 48"h	145 lbs	\$1,753	+\$99

OPTIONS	DESCRIPTION	LIST
6	Lock Drawer Lock (cylinder style with strike plate) - per drawer*	\$114
37	Lock Lock Hasp Kit for Drawers - per drawer	\$51
PL	Surface Mounted Pull Subject to Availability - per pull See Handles & Pulls	\$27
29	Plywood Package Cabinet Backs Drawer Bottoms - per cabinet	\$66
10	Drawer Restriction Prevents removal Per drawer	\$27

*If "keyed alike" locks or "master keys" are required, additional charges may apply.

EVEREST | NIGHTSTAND

Standard Features:

Standard Finish is Natural Oak
 Cabinet: Red Oak Veneer, Hardwood Plycore Sides
 Drawer Front: Solid Planked Red Oak with Full Length Finger Bevel on Top Edge
 Top: Oak grain HPL with Matching External Thermoplastic Edge
 All Exterior Wood Components & Drawer Parts Sealed with ModuV
 ModuV is Our Specially formulated 100% Resin Top-Coat for Ease of Cleaning and Durability

ModuForm Finishes:

Standard wood finish is Natural Oak
 Available wood finishes: Light Cherry, Cherry, Stone, Dark Mocha, Walnut
 *Please add stain upcharge for all standard finishes detailed above to list price
 Option: For custom wood finish, please add \$600 NET plus listed stain upcharge



EV5A-1D



EV5A-2D



EV5B-1D



EV5B-3D

MODEL	DESCRIPTION	DRAWERS	DIMENSION	WT	LIST	*STAIN
EV5A-1D	Nightstand	1	18"d x 15.75"w x 20.5"h	50 lbs	\$762	+\$56
EV5A-2D	Nightstand	2	18"d x 15.75"w x 20.5"	45 lbs	\$828	+\$56
EV5B-1D	Nightstand	1	18"d x 15.75"w x 30"	42 lbs	\$808	+\$56
EV5B-3D	Nightstand	3	18"d x 15.75"w x 30"	51 lbs	\$1,004	+\$56

OPTIONS	DESCRIPTION	LIST
6	Lock Drawer Lock (cylinder style with strike plate) - per drawer*	\$114
37	Lock Lock Hasp Kit for Drawers - per drawer	\$51
PL	Surface Mounted Pull Subject to Availability - per pull See Handles & Pulls	\$27
29	Plywood Package Cabinet Backs Drawer Bottoms - per cabinet	\$66
10	Drawer Restriction Prevents removal Per drawer	\$27

*If "keyed alike" locks or "master keys" are required, additional charges may apply.

EVEREST | WARDROBE

Standard Features:

Standard Finish is Natural Oak
 Cabinet: Red Oak Veneer, Hardwood Plycore Sides | Doors are Oak Veneer
 Drawer Front: Solid Planked Red Oak with Full Length Finger Bevel on Top Edge
 Top: Oak grain HPL with Matching External Thermoplastic Edge
 Hardware: Wire Nickel Pull on Door (s) and 270° 5-Knuckle Hinges
 Adjustable Floor Leveling Glides Standard
 Single Door Wardrobe Doors Open Left
 All Exterior Wood Components & Drawer Parts Sealed with ModuV
 ModuV is Our Specially formulated 100% Resin Top-Coat for Ease of Cleaning and Durability

ModuForm Finishes:

Standard wood finish is Natural Oak
 Available wood finishes: Light Cherry, Cherry, Stone, Dark Mocha, Walnut
 *Please add stain upcharge for all standard finishes detailed above to list price
 Option: For custom wood finish, please add \$600 NET plus listed stain upcharge



MODEL	DESCRIPTION	DRAWERS	DIMENSION	WT	LIST	*STAIN
EV6A29	with Clothes Pole	-	24"d x 29"w x 59"h	150 lbs	\$2,087	+\$220
EV6B20-1D	with Clothes Pole Hat Shelf	-	24"d x 20"w x 75"h	150 lbs	\$2,020	+\$220
EV6B29	with Clothes Pole Hat Shelf	-	24"d x 29"w x 75"h	165 lbs	\$2,312	+\$220
EV6C120-1D	with Clothes Pole Shoe Shelf	1	24"d x 20"w x 75"h	150 lbs	\$2,318	+\$220
EV6C129	with Clothes Pole Shoe Shelf	1	24"d x 29"w x 75"h	205 lbs	\$2,637	+\$220
EV6C220-1D	with Clothes Pole	2	24"d x 20"w x 75"h	155 lbs	\$2,369	+\$220
EV6C229	with Clothes Pole	2	24"d x 29"w x 75"h	210 lbs	\$2,799	+\$220

EVEREST | WARDROBE OPTIONS

OPTIONS	DESCRIPTION	LIST
5	Lock Wardrobe Door Lock Kit (cylinder style with and without slide bolt)*	\$157
6	Lock Drawer Lock (cylinder style with strike plate) - per drawer*	\$114
37	Lock Lock Hasp Kit for Drawers - per drawer	\$51
PL	Surface Mounted Pull Subject to Availability - per pull See Handles & Pulls	\$27
64	Cut Out Oval Pull Wardrobe Doors - per pull	\$23
29	Plywood Package Cabinet Backs Drawer Bottoms - per cabinet	\$141
29B	Plywood Package Cabinet Backs Only	\$121
10	Drawer Restriction Prevents removal Per drawer	\$27
25	Center Divider Wardrobe	\$483
26	Mirror Unframed glass mirror, 12 x 22, clipped to inside wardrobe door	\$106
28	Towel Bar Wood surface mounted outside wardrobe door - select door	\$110
V	Shelf Fixed Per shelf	\$192

*If "keyed alike" locks or "master keys" are required, additional charges may apply.

EVEREST | PLATFORM BEDS

Standard Features:

Standard Finish is Natural Oak
 Cabinet: Red Oak Veneer, Hardwood Plycore
 Solid Red Oak Drawer Fronts with Full Length Finger Bevel Pull Top Edge
 Bed Deck: Particle Board | Deck Height: 14" high
 Fits 36" x 80 Mattress which are Available and Sold Separately*
 All Exterior Wood Components Sealed with ModuV
 ModuV is Our Specially formulated 100% Resin Top-Coat for Ease of Cleaning and Durability

ModuForm Finishes:

Standard wood finish is Natural Oak
 Available wood finishes: Light Cherry, Cherry, Stone, Dark Mocha, Walnut
 *Please add stain upcharge for all standard finishes detailed above to list price
 Option: For custom wood finish, please add \$600 NET plus listed stain upcharge



EV9C-ES



EV9-2D



EV9-3D

MODEL	DESCRIPTION	DRAWERS	DIMENSION	WT	LIST	*STAIN
EV9C-ES	Platform Bed with Elevated Sides	-	37.5"d x 81.5"w x 16.25"h	140 lbs	\$1,350	+\$98
EV9-2D	Platform Bed Full Length Drawers *Mattress will be captured by head and foot boards	2	37.5"d x 81.5"w x 16.25"h	145 lbs	\$2,232	+\$98
EV9-3D	Platform Bed Full Length Drawers *Mattress will be captured by head and foot boards	3	37.5"d x 81.5"w x 16.25"h	150 lbs	\$2,519	+\$98

OPTIONS	DESCRIPTION	LIST	*STAIN
6	Lock Drawer Lock (cylinder style with strike plate) - per drawer*	\$114	
10	Drawer Restriction Prevents removal Per drawer	\$27	
37	Lock Lock Hasp Kit for Drawers - per drawer	\$51	
35	Oak Veneer Headboard Extension (15" High) Platform beds - Twin	\$563	+\$45
63	Plywood deck Twin Platform beds	\$194	
63WD	Plywood deck Twin Bed Laminated white Includes perimeter caulking sealant	\$321	
SS	Caulking Perimeter sealant Platform bed deck Factory applied	\$53	

*If "keyed alike" locks or "master keys" are required, additional charges may apply.

EVEREST | PLATFORM BEDS

Standard Features:

Standard Finish is Natural Oak
 Cabinet: Red Oak Veneer, Hardwood Plycore
 Solid Red Oak Drawer Fronts with Full Length Finger Bevel Pull Top Edge
 Bed Deck: Particle Board | Deck Height: 14"h on EV9-2D | 21"h on EV9-4D
 Fits 36" x 80 Mattress which are Available and Sold Separately*
 All Exterior Wood Components Sealed with ModuV
 ModuV is Our Specially formulated 100% Resin Top-Coat for Ease of Cleaning and Durability

ModuForm Finishes:

Standard wood finish is Natural Oak
 Available wood finishes: Light Cherry, Cherry, Stone, Dark Mocha, Walnut
 *Please add stain upcharge for all standard finishes detailed above to list price
 Option: For custom wood finish, please add \$600 NET plus listed stain upcharge



EV9-2DR



EV9-2DL



EV9-4DR



EV9-4DL

MODEL	DESCRIPTION	DRAWERS	DIMENSION	WT	LIST	*STAIN
EV9-2DR	2 Offset Drawers Right Facing *Mattress will be captured on 4 sides	2	37.5"d x 81.5"w x 16.25"h	150 lbs	\$2,372	+\$98
EV9-2DL	2 Offset Drawers Left Facing *Mattress will be captured on 4 sides	2	37.5"d x 81.5"w x 16.25"h	150 lbs	\$2,372	+\$98
EV9-4DR	4 Offset Drawers Right Facing * 4DR beds fits 38" x 80" mattress which are available and sold separately *Mattress will be captured on 4 sides	4	39.5"d x 81.5"w x 21.5"h	185 lbs	\$3,055	+\$98
EV9-4DL	4 Offset Drawers Left Facing * 4DR beds fits 38" x 80" mattress which are available and sold separately *Mattress will be captured on 4 sides	4	39.5"d x 81.5"w x 21.5"h	185 lbs	\$3,055	+\$98

ROOMMATE BEDS - STATEMENT OF LINE*

Standard Features: All Loft and Bunk Beds

Frame: Solid Red Oak Posts and Rails
 Sleep Surface: Sinuous Wire Spring | 36" x 80"
 All Posts and Rails Finished with ModuV
 ModuV is Our Specially Formulated 100% Resin Top-Coat for Ease of Cleaning and Durability

ModuForm Finishes:

Standard wood finish is Natural Oak
 Available wood finishes: Light Cherry, Cherry, Stone, Dark Mocha, Walnut
 *Please add stain upcharge for all standard finishes detailed above to list price
 Option: For custom wood finish, please add \$600 NET plus listed stain upcharge

Standard Features: Bolt-On

See Standard Features, plus:
 Bunking Pins are 1/2" x 4" Solid Birch Dowels
 Springs are Bolted to Bed Frame and Require Tools for Assembly
 Posts are Bored Top and Bottom to Accept a 1/2" Removable Wooden Bunking Pin

Standard Features: Hook Lock

See Standard Features, plus:
 Top and Bottom of Posts Bored for 3/8" dia x 3.5" Steel Bunking Pin for Stacking
 10 Pins Per End | 9 Adjustments Per End
 Springs Hook Over Embedded 3/8" Steel Pins Laminated Between the Posts for Tool-Less Assembly



*Bed Rail, ladder and mattresses sold separately | please see bed accessories and components for model numbers and pricing

*ModuForm recommends the use of Bed Rails (RM9R) on all loft and bunk beds | Ladders are recommended for all bunk and high loft beds

ROOMMATE BOLT ON BEDS



DESCRIPTION	SLEEP SURFACE	DIMENSION	WT	LIST	*STAIN
959BTRM1-A3680-WP Twin Bed Bolt-On Spring One (1) Sleep Surface (1) Tall Headboard (1) Short Foot board Posts are bored top and bottom to accept a 1/2" removable wood bunking pin	Sinusuous Spring	36"d x 84.75"w x 36":21"h	63 lbs	\$1,093	+\$60



959BTRM1-BB-A3680-WP Bunk Bed Bolt-On Springs Two (2) Sleep Surfaces (2) Tall Bed Ends on Bottom (2) Short Bed Ends on Top Posts are bored top and bottom to accept a 1/2" removable wood bunking pin ModuForm recommends the use of Bed Rails (RM9R) on all bunk beds Ladders are recommended for all bunk beds	Sinusuous Spring	36"d x 84.75"w x 59"h	127 lbs	\$2,185	+\$120
--	------------------	-----------------------	---------	---------	--------



959BTRM1-L-SS80-WP Low Loft Bolt-On Spring One (1) Sleep Surface (2) Tall Headboards Posts are bored top and bottom to accept a 1/2" removable wood bunking pin ModuForm recommends the use of Bed Rails (RM9R) on all loft beds	Sinusuous Spring	36"d x 84.75"w x 36"h	70 lbs	\$1,133	+\$60
--	------------------	-----------------------	--------	---------	-------







RMBTFB-WP Single Bed End Bolt On Footboard Wood Pin *Bunking pins not included	-	2.25"d x 37.5"w x 21"h	9 lbs	\$382	+\$45
--	---	------------------------	-------	-------	-------



RMBTHB-WP Single Bed End Bolt On Headboard Wood Pin *Bunking pins not included	Sinusuous Spring	2.25"d x 37.5"w x 36"h	16 lbs	\$431	+\$45
--	------------------	------------------------	--------	-------	-------

RMPIN-WD Wood Bunking Pin for RMBT (lot of 40) Replacements		.5"dia x 4"h	-	\$112	-
--	--	--------------	---	-------	---

ROOMMATE HOOK LOCK BEDS - REMOVABLE STEEL BUNKING PIN

DESCRIPTION	SLEEP SURFACE	DIMENSION	WT	LIST	*STAIN
 <p>959HL-L-A3680-SP Low Loft Hook Lock Spring One (1) Sleep Surface ModuForm recommends the use of Bed Rails (RM9R) on all loft beds</p>	Sinuous Spring	37.75"d x 84.75"w x 36"h	67 lbs	\$1,061	+\$60
	-	37.75"d x 84.75"w x 36"h	58 lbs	\$954	+\$60
 <p>959HL-KIT-SP High Loft Kit High Loft Kit Includes 2 Bed Ends and 2 Stabilizer Bars ModuForm recommends the use of Bed Rails (RM9R) on all loft beds Ladders are recommended for all loft beds</p>	-	37.75"d x 84.75"w x 36"h	58 lbs	\$954	+\$60
	-	37.75"d x 84.75"w x 36"h	58 lbs	\$954	+\$60
 <p>959HL-BB-A3680-SP Bunk Bed Hook Lock Spring Two (2) Sleep Surfaces ModuForm recommends the use of Bed Rails (RM9R) on all loft beds Ladders are recommended for all loft beds</p>	Sinuous Spring	37.75"d x 84.75"w x 72"h	134 lbs	\$2,120	+\$120
	-	37.75"d x 84.75"w x 72"h	125 lbs	\$1,993	+\$120
 <p>959HL-H-A3680-SP High Loft Hook Lock Spring One (1) Sleep Surface ModuForm recommends the use of Bed Rails (RM9R) on all loft beds Ladders are recommended for all loft beds</p>	Sinuous Spring	37.75"d x 84.75"w x 72"h	125 lbs	\$1,993	+\$120
	-	37.75"d x 84.75"w x 72"h	125 lbs	\$1,993	+\$120
 <p>RMHLHB-SP Single Bed End Hook Lock Steel Pin *Bunking pins not included</p>	Sinuous Spring	2.25"d x 37.5"w x 36"h	16 lbs	\$534	+\$49
	-	2.25"d x 37.5"w x 36"h	16 lbs	\$534	+\$49
<p>RMPIN-SP Steel Bunking Pin for 959HL-SP (lot of 40) Replacements</p>		.375"dia x 3.5"h	-	\$112	-

ROOMMATE GSA BEDS - STATEMENT OF LINE*

Standard Features: All Loft and Bunk Beds

Frame: Solid Red Oak Posts and Rails
Sleep Surface: Sinuous Wire Spring | 38" x 80"
All Posts and Rails Finished with ModuV
ModuV is Our Specially Formulated 100% Resin Top-Coat for Ease of Cleaning and Durability

ModuForm Finishes:

Standard wood finish is Natural Oak
Available wood finishes: Light Cherry, Cherry, Stone, Dark Mocha, Walnut
*Please add stain upcharge for all standard finishes detailed above to list price
Option: For custom wood finish, please add \$600 NET plus listed stain upcharge

Standard Features: Bolt-On

See Standard Features, plus:
Bunking Pins are 1/2" x 4" Solid Birch Dowels
Wedge Plate are Bolted to Bed Frame and Require Tools for Assembly
Posts are Bored Top and Bottom to Accept a 1/2" Removable Wooden Bunking Pin



Standard Features: Hook Lock

See Standard Features, plus:
Top and Bottom of Posts Bored for 3/8"dia x 3.5" Steel Bunking Pin for Stacking
10 Pins Per End | 9 Adjustments Per End
Springs Hook Over Embedded 3/8" Steel Pins Laminated Between the Posts for Tool-Less Assembly



*Bed Rail, ladder and mattresses sold separately | please see bed accessories and components for model numbers and pricing

*ModuForm recommends the use of Bed Rails (RM9R) on all loft and bunk beds | Ladders are recommended for all bunk and high loft beds

ROOMMATE | GSA APPROVED BUNKING | LOFTING BEDS - Tool-Less



DESCRIPTION	SLEEP SURFACE	DIMENSION	WT	LIST	*STAIN
-------------	---------------	-----------	----	------	--------

HOOK LOCK | LOFTING

G959HL-L-3880-WP GSA Low Loft Hook Lock Spring One (1) Sleep Surface ModuForm recommends the use of Bed Rails (RM9R) on all loft beds	Sinusous Spring	40"d x 85"w x 36"h	67 lbs	\$1,367	+\$60
---	-----------------	--------------------	--------	---------	-------













G959HL-BB-3880-WP GSA Bunk Bed Hook Lock Springs Two (2) Sleep Surfaces ModuForm recommends the use of Bed Rails (RM9R) on all bunk beds Ladders are recommended for all bunk beds	Sinusous Spring	40"d x 85"w x 72"h	134 lbs	\$2,733	+\$60
--	-----------------	--------------------	---------	---------	-------



G959HL-H-S1-WP GSA High Loft Hook Lock Spring One (1) Sleep Surface ModuForm recommends the use of Bed Rails (RM9R) on all loft beds Ladders are recommended for all high loft beds	Frame	40"d x 85"w x 72"h	125 lbs	\$2,357	+\$120
---	-------	--------------------	---------	---------	--------

OPTION	DESCRIPTION	LIST	*STAIN
A	Set of Fascia Rails	\$216	+\$49

BED | ACCESSORIES | COMPONENTS

	MODEL	DESCRIPTION	DIMENSION	WT	LIST	*STAIN
	RM98BT-BK	Bunk Bed Metal Frame Powder Coat	36.25"d x 83"w x 72"h	-	\$1,988	
	959BT-SPRING	Spring Bolt On	36"d x 81"w x 2.5"h	35 lbs	\$559	
	959HL75-SPRING	Spring Hook Lock	36"d x 75"w x 2.5"h	33 lbs	\$540	
	959HL-SPRING	Spring Hook Lock	36"d x 80"w x 2.5"h	35 lbs	\$540	
	959HL84-SPRING	Spring Hook Lock	36"d x 84"w x 2.5"h	37 lbs	\$679	
	959BT-STABILIZER	Stabilizer Bar Bolt On	80"w x 2.5"h	13 lbs	\$180	
	959HL-STABILIZER	Stabilizer Bar Hook Lock	80"w x 2.5"h	14 lbs	\$180	
	RM9R	Bed Rail Powder Coated Metal No Fascia Rail	.75"d x 51" x 16"	15 lbs	\$230	
	RMLD3	Ladder 3 Step <i>*For 959BTRM1 & 959TPRM1 (when bunked)</i>	3"d x 14.5"w x 49.25"h	14 lbs	\$638	+\$60
	RMLD5	Ladder 5 Step <i>*For 959HL (when stacked or high loft)</i>	3"d x 14.5"w x 66.25"h	17 lbs	#REF!	+\$60
	RM9LD	Ladder Metal Powder Coat	.75"d x 52" - 67"	-	\$925	

ROOMMATE | TWIN | FULL | QUEEN BEDS

Standard Features:

Standard Finish is Natural Oak

Mattresses and Box Springs Available and Sold Separately

ModuForm Finishes:

Available wood finishes: Light Cherry, Cherry, Stone, Dark Mocha, Walnut

*Please add stain upcharge for all standard finishes detailed above to list price

Option: For custom wood finish, please add \$600 NET plus listed stain upcharge



RMB39*



RMB54*
RMB60*



RM18-3680
RM18-3880



RM18-54

MODEL	DESCRIPTION	SLEEP SURFACE	DIMENSION	WT	LIST	*STAIN
RMB39*	Twin Headboard with Frame *RMB39 require 38"w Mattress and Box Spring	Sinuous Spring	40"d x 76"w x 36.25"h	50 lbs	\$962	+\$45
RMB54*	Double Headboard with Frame *RMB54 require 54"w Mattress and Box Spring	Sinuous Spring	55"d x 76"w x 36.25"h	65 lbs	\$1,124	+\$45
RMB60*	Queen Headboard with Frame *RMB60 require 60"w Mattress and Box Spring	Sinuous Spring	62"d x 81"w x 36.25"h	80 lbs	\$1,148	+\$45
RM18-3680	Twin Bed	-	36"d x 83.5"w x 29.5"/17"h	76 lbs	\$1,275	+\$89
RM18-3880	Twin Bed	-	38"d x 83.5"w x 29.5"/17"h	85 lbs	\$1,497	+\$89
RM18-54	Double Bed	-	54"d x 83.5"w x 29.5"/17"h	95 lbs	\$2,276	+\$89

ROOMMATE | HEADBOARDS | FRAMES

Standard Features:

Standard Finish is Natural Oak





Mattresses and Box Springs Available and Sold Separately

ModuForm Finishes:

Available wood finishes: Light Cherry, Cherry, Stone, Dark Mocha, Walnut

*Please add stain upcharge for all standard finishes detailed above to list price

Option: For custom wood finish, please add \$600 NET plus listed stain upcharge

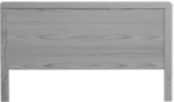
	MODEL	DESCRIPTION	SLEEP SURFACE	DIMENSION	WT	LIST	*STAIN
	RM26-BK	Bed Frame Steel	Frame	36"d x 80"w x 12"h	30 lbs	\$812	-
	RM28	Twin Headboard with Frame	Frame	36"d x 82"w x 29.5"h	60 lbs	\$1,602	+\$45
	RM-FRAME-TD	Frame Adjustable Twin & Double	-	38": 53"d x 70"w x 8"h	-	\$250	-
	RM-FRAME-QN	Frame Queen Center Support	-	60"d x 70"w x 8"h	-	\$271	-
	RM18HB	Twin Headboard Post Panel	-	1.75"d x 36"w x 29.5"h	22 lbs	\$456	+\$45
	RMB39HB	Headboard Twin	-	1.25"d x 40"w x 36"h	30 lbs	\$811	+\$45
	RMB54HB	Headboard Double	-	1.25"d x 55"w x 36"h	35 lbs	\$965	+\$45
	RMB60HB	Headboard Queen	-	1.25"d x 62"w x 36"h	40 lbs	\$991	+\$45
	*Hardware not included						

LOWELL | DESK | MOBILE PEDESTAL

Standard Features:

Standard Finish is Natural Oak
 Cabinet: Solid Red Oak Posts with Oak Veneer Inset Panel
 Drawer Front: Solid Red Oak with Routed Crescent Shape Finger Pull
 Top: Oak grain HPL with Matching External Thermoplastic Edge
 Drawer Bottoms and Cabinet Backs are Sealed with ModuV
 ModuV is Our Specially formulated 100% Resin Top-Coat for Ease of Cleaning and Durability

ModuForm Finishes:

Standard wood finish is Natural Oak
 Available wood finishes: Light Cherry, Cherry, Stone, Dark Mocha, Walnut
 *Please add stain upcharge for all standard finishes detailed above to list price
 Option: For custom wood finish, please add \$600 NET plus listed stain upcharge



GL3A



GL3A-2D



GL3YNP



GL3MP-20



GL3MP-2D

MODEL	DESCRIPTION	DRAWERS	OPENINGS	DIMENSION	WT	LIST	*STAIN
GL3A	Desk Pedestal	3	-	24"d x 42.75"w x 30.5"h	94 lbs	\$1,890	+\$99
GL3A-2D	Desk Pedestal	2	1	24"d x 42.75"w x 30.5"h	87 lbs	\$1,894	+\$99
GL3YNP	Desk Writing	-	-	24"d x 36.75"w x 30.5"h	59 lbs	\$943	+\$99
*Knee space Keyboard or Pencil Trays Not Available for Lowell Writing Desks							
GL3MP-20	Mobile Pedestal	-	2	18"d x 16.75"w x 22.5"h	50 lbs	\$1,008	+\$56
<i>Casters are ready to attach on-site</i>							
GL3MP-2D	Mobile Pedestal	2	-	18"d x 16.75"w x 22.5"h	58 lbs	\$1,268	+\$56
<i>Casters are ready to attach on-site</i>							

LOWELL | DESK & MOBILE PEDESTAL OPTIONS

OPTIONS	DESCRIPTION	LIST
6	Lock Drawer Lock (cylinder style with strike plate) - per drawer*	\$114
37	Lock Lock Hasp Kit for Drawers - per drawer	\$51
PL	Surface Mounted Pull Subject to Availability - per pull See Handles & Pulls	\$27
11	Kneespace Pencil Tray Pedestal Desk Only	\$210
34	Kneespace Sculptured Keyboard Tray - Pedestal Desk Only	\$213
47	Drawer Restriction Prevents removal Kneespace Drawer Only	\$46
29	Plywood Package Cabinet Backs Drawer Bottoms - per cabinet	\$66
29B	Plywood Package Cabinet Backs Only	\$57
10	Drawer Restriction Prevents removal Per drawer	\$27

*If "keyed alike" locks or "master keys" are required, additional charges may apply.

LOWELL | DRESSERS

Standard Features:

Standard Finish is Natural Oak
 Cabinet: Solid Red Oak Posts with Oak Veneer Inset Panel
 Drawer Front: Solid Red Oak with Routed Crescent Shape Finger Pull
 Top: Oak grain HPL with Matching External Thermoplastic Edge
 Drawer Bottoms and Cabinet Backs are Sealed with ModuV
 ModuV is Our Specially formulated 100% Resin Top-Coat for Ease of Cleaning and Durability

ModuForm Finishes:

Standard wood finish is Natural Oak
 Available wood finishes: Light Cherry, Cherry, Stone, Dark Mocha, Walnut
 *Please add stain upcharge for all standard finishes detailed above to list price
 Option: For custom wood finish, please add \$600 NET plus listed stain upcharge



MODEL	DESCRIPTION	DRAWERS	DIMENSION	WT	LIST	*STAIN
GL4SC-2D	Dresser <i>2 Drawer stacking are sold individually Stacking chests feature veneer side panels and interlocking tops</i>	2	24"d x 30.75"w x 20.5"	63 lbs	\$1,204	+\$99
GL4A-24	Dresser <i>Lowell 3 drawer dresser is designed for traditional room configurations. Not intended to fit under a low lofted bed.</i>	3	24"d x 30.75"w x 30.5"h	95 lbs	\$1,653	+\$99
GL4B-18	Dresser	4	18"d x 30.75"w x 38.5"h	102 lbs	\$1,808	+\$99
GL4C-18	Dresser	5	18"d x 30.75"w x 46.5"h	125 lbs	\$2,005	+\$99
GL4D-18	Dresser	6	18"d x 60"w x 30.5"h	155 lbs	\$2,734	+\$99

OPTIONS	DESCRIPTION	LIST
6	Lock Drawer Lock (cylinder style with strike plate) - per drawer*	\$114
37	Lock Lock Hasp Kit for Drawers - per drawer	\$51
PL	Surface Mounted Pull Subject to Availability - per pull See Handles & Pulls	\$27
29	Plywood Package Cabinet Backs Drawer Bottoms - per cabinet	\$66
29B	Plywood Package Cabinet Backs Only	\$57
10	Drawer Restriction Prevents removal Per drawer	\$27

LOWELL | NIGHTSTANDS

Standard Features:

Standard Finish is Natural Oak
 Cabinet: Solid Red Oak Posts with Oak Veneer Inset Panel
 Drawer Front: Solid Red Oak with Routed Crescent Shape Finger Pull
 Top: Oak grain HPL with Matching External Thermoplastic Edge
 Drawer Bottoms and Cabinet Backs are Sealed with ModuV
 ModuV is Our Specially formulated 100% Resin Top-Coat for Ease of Cleaning and Durability

ModuForm Finishes:

Standard wood finish is Natural Oak
 Available wood finishes: Light Cherry, Cherry, Stone, Dark Mocha, Walnut
 *Please add stain upcharge for all standard finishes detailed above to list price
 Option: For custom wood finish, please add \$600 NET plus listed stain upcharge



GL5A-1D



GL5A-2D



GL5B-3D

MODEL	DESCRIPTION	DRAWERS	OPENINGS	DIMENSION	WT	LIST	*STAIN
GL5A-1D	Nightstand	1	1	18"d x 16.5"w x 22.5"h	42 lbs	\$1,142	+\$56
GL5A-2D	Nightstand	2	-	18"d x 16.5"w x 22.5"h	45 lbs	\$1,229	+\$56
GL5B-3D	Nightstand	3	-	18"d x 16.5"w x 30.5"h	48 lbs	\$1,368	+\$56

OPTIONS	DESCRIPTION	LIST
6	Lock Drawer Lock (cylinder style with strike plate) - per drawer*	\$114
37	Lock Lock Hasp Kit for Drawers - per drawer	\$51
PL	Surface Mounted Pull Subject to Availability - per pull See Handles & Pulls	\$27
29	Plywood Package Cabinet Backs Drawer Bottoms - per cabinet	\$66
29B	Plywood Package Cabinet Backs Only	\$38
10	Drawer Restriction Prevents removal Per drawer	\$27

*If "keyed alike" locks or "master keys" are required, additional charges may apply.

LOWELL | WARDROBES | TV STAND

Standard Features:

Standard Finish is Natural Oak
 Cabinet: Solid Red Oak Posts with Oak Veneer Inset Panel
 Drawer Front: Solid Red Oak with Routed Crescent Shape Finger Pull
 Top: Oak grain HPL with Matching External Thermoplastic Edge
 Drawer Bottoms, Cabinet Backs & Doors are Sealed with ModuV
 ModuV is Our Specially formulated 100% Resin Top-Coat for Ease of Cleaning and Durability
 Single Door Wardrobe Doors Open Left

ModuForm Finishes:

Standard wood finish is Natural Oak
 Available wood finishes: Light Cherry, Cherry, Stone, Dark Mocha, Walnut
 *Please add stain upcharge for all standard finishes detailed above to list price
 Option: For custom wood finish, please add \$600 NET plus listed stain upcharge



GL6B



GL6C2



GL6C220-1DL
GL6C220-1DR



GL10TV60

MODEL	DESCRIPTION	DRAWERS	DIMENSION	WT	LIST	*STAIN
GL6B	with 2 Doors Clothes Pole Hat Shelf	-	24"d x 37"w x 74.75"h	173 lbs	\$3,067	+\$220
GL6C2	with 2 Doors Clothes Pole 2 Drawers	2	24"d x 37"w x 74.75"h	195 lbs	\$3,341	+\$220
GL6C220-1DL	with 1 Door Clothes Pole 2 Drawers	2	24"d x 20.75"w x 74.75"h	147 lbs	\$2,999	+\$220
GL6C220-1DR	with 1 Door Clothes Pole 2 Drawers	2	24"d x 20.75"w x 74.75"h	147 lbs	\$2,999	+\$220
GL10TV60	TV Stand	-	18"d x 60"w x 30.5"h	70 lbs	\$1,751	+\$99

LOWELL | WARDROBES & TV STAND OPTIONS

OPTIONS	DESCRIPTION	LIST
5	Lock Wardrobe Door Lock Kit (cylinder style with and without slide bolt)*	\$157
6	Lock Drawer Lock (cylinder style with strike plate) - per drawer*	\$114
37	Lock Lock Hasp Kit for Drawers - per drawer	\$51
PL	Surface Mounted Pull Subject to Availability - per pull See Handles & Pulls	\$27
64	Cut Out Oval Pull Wardrobe Doors - per pull	\$23
29	Plywood Package Cabinet Backs Drawer Bottoms - per cabinet	\$141
29B	Plywood Package Cabinet Backs Only	\$121
10	Drawer Restriction Prevents removal Per drawer	\$27
25	Center Divider Wardrobe	\$483
26	Mirror Unframed glass mirror, 12 x 22, clipped to inside wardrobe door	\$106
28	Towel Bar Wood surface mounted outside wardrobe door - select door	\$110
V	Shelf Fixed Per shelf	\$192

*If "keyed alike" locks or "master keys" are required, additional charges may apply.

LOWELL | PLATFORM BEDS

Standard Features:

Standard Finish is Natural Oak
 Cabinet: Solid Red Oak Posts with Oak Veneer Inset Panel
 Drawer Front: Solid Red Oak with Routed Crescent Shape Finger Pull
 Drawer Bottoms and Cabinet Backs are Finished with ModuV Cured Resin for Ease of Cleaning and Durability
 Bed Deck: Particle Board | Deck Height: 14.25" high
 Fits 36" x 80 Mattress which are Available and Sold Separately

ModuForm Finishes:

Standard wood finish is Natural Oak
 Available wood finishes: Light Cherry, Cherry, Stone, Dark Mocha
 *Please add listed stain upcharge for Light Cherry, Cherry, Stone or Dark Mocha
 Option: For custom wood finish, please add \$600 NET plus listed stain upcharge



MODEL	DESCRIPTION	DRAWERS	SLEEP SURFACE	DIMENSION	WT	LIST	*STAIN
GL9ND	No Drawers *Mattress will be captured on 4 sides	-	Particle Board	37"d x 84"w x 17.5"h	116 lbs	\$2,029	+\$98
GL9-2D	2 Equal Full Length Drawers *Mattress will be captured on 4 sides	2	Particle Board	37"d x 84"w x 17.5"h	145 lbs	\$3,091	+\$98
GL9-2DR	Right Offset Drawers *Mattress will be captured on 4 sides	2	Particle Board	37"d x 84"w x 17.5"h	145 lbs	\$3,095	+\$98
GL9-2DL	Left Offset Drawers *Mattress will be captured on 4 sides	2	Particle Board	37"d x 84"w x 17.5"h	145 lbs	\$3,095	+\$98
GL9-3D	3 Equal Drawers *Mattress will be captured on 4 sides	3	Particle Board	37"d x 84"w x 17.5"h	140 lbs	\$3,210	+\$98

OPTIONS	DESCRIPTION	LIST
6	Lock Drawer Lock (cylinder style with strike plate) - per drawer*	\$114
37	Lock Lock Hasp Kit for Drawers - per drawer	\$51
PL	Surface Mounted Pull Subject to Availability - per pull See Handles & Pulls	\$27
29	Plywood Package Cabinet Backs Drawer Bottoms - per cabinet	\$66
10	Drawer Restriction Prevents removal Per drawer	\$27

LOWELL | TWIN | FULL | QUEEN BEDS

Standard Features:

Standard Finish is Natural Oak
 Post and Panel Headboards and Footboards where applicable
 Mattresses and Box Springs Available and Sold Separately

ModuForm Finishes:

Standard wood finish is Natural Oak
 Available wood finishes: Light Cherry, Cherry, Stone, Dark Mocha
 *Please add listed stain upcharge for Light Cherry, Cherry, Stone or Dark Mocha
 Option: For custom wood finish, please add \$600 NET plus listed stain upcharge



GLB39*



GLB54*
GLB60*



GL18



GL18-54
GL18-60

MODEL	DESCRIPTION	SLEEP SURFACE	DIMENSION	WT	LIST	*STAIN
GLB39*	Twin Headboard with Frame Top Cap *GLB39 require 38"w Mattress and Box Spring	Sinuous Wire	40.25"d x 78"w x 36"h	50 lbs	\$1,192	+\$45
GLB54*	Double Headboard with Frame Top Cap *GLB54 require 54"w Mattress and Box Spring	Sinuous Wire	56.25"d x 78"w x 36"h	65 lbs	\$1,507	+\$45
GLB60*	Queen Headboard with Frame Top Cap *GLB60 require 60"w Mattress and Box Spring	Sinuous Wire	62.25"d x 83"w x 36"h	80 lbs	\$1,568	+\$45
GL18	Twin Bed	Frame	36"d x 83.5"w x 36":.26"h	76 lbs	\$1,743	+\$89
GL18-54	Double Bed	Frame	54"d x 83.5"w x 36":.26"h	81 lbs	\$2,576	+\$89
GL18-60	Queen Bed	Frame	60"d x 83.5"w x 36":.26"h	86 lbs	\$2,608	+\$89

LOWELL | HEADBOARDS

Standard Features:

Standard Finish is Natural Oak
 Post and Panel Headboards and Footboards where applicable
 Mattresses and Box Springs Available and Sold Separately

ModuForm Finishes:

Standard wood finish is Natural Oak
 Available wood finishes: Light Cherry, Cherry, Stone, Dark Mocha
 *Please add listed stain upcharge for Light Cherry, Cherry, Stone or Dark Mocha
 Option: For custom wood finish, please add \$600 NET plus listed stain upcharge



GLB39HB



GLB54HB
GLB60HB



GL18HB



GL18-54HB
GL18-60HB

MODEL	DESCRIPTION	SLEEP SURFACE	DIMENSION	WT	LIST	*STAIN
GLB39HB	Headboard Twin Top Cap	-	1.25"d x 40.25"w x 37.5"h	35 lbs	\$1,124	+\$45
GLB54HB	Headboard Double Top Cap	-	1.25"d x 55.25"w x 37.5"h	65 lbs	\$1,415	+\$45
GLB60HB	Headboard Queen Top Cap	-	1.25"d x 61.25"w x 37.5"h	80 lbs	\$1,470	+\$45
*Hardware not included						
GL18HB	Headboard Twin	-	1.25"d x 36"w x 36"h	35 lbs	\$869	+\$45
GL18-54HB	Headboard Double	-	1.25"d x 54"w x 36"h	40 lbs	\$1,251	+\$45
GL18-60HB	Headboard Queen	-	1.25"d x 60"w x 36"h	45 lbs	\$1,299	+\$45
*Hardware not included						

TRANSITIONS | DRESSERS

Standard Features:

Standard Finish is Natural Oak
 Cabinet: Red Oak Veneer with Hardwood Plycore Sides
 Top: Oak grain HPL with Matching High-Impact External Thermoplastic Edge
 Tamper Resistant Hardware
 All Exterior Wood Components Sealed with ModuV
 ModuV is Our Specially formulated 100% Resin Top-Coat for Ease of Cleaning and Durability

ModuForm Finishes:

Standard wood finish is Natural Oak
 Available wood finishes: Light Cherry, Cherry, Stone, Dark Mocha, Walnut
 *Please add stain upcharge for all standard finishes detailed above to list price
 Option: For custom wood finish, please add \$600 NET plus listed stain upcharge



TR4A



TR4B

MODEL	DESCRIPTION	OPENINGS	DIMENSION	WT	LIST	*STAIN
TR4A	Dresser	3	18"d x 30"w x 30.5"h	105 lbs	\$996	+\$99
TR4B	Dresser	4	18"d x 30"w x 40"h	115 lbs	\$1,186	#REF!

OPTIONS	DESCRIPTION	LIST
16	Mounting System (with Floor Leveling Glides) Nightstand, Dresser, Slope Tops Floor & Wall - Includes Alignment Template	\$164
16N	Mounting System (No Floor Leveling Glides) Nightstand, Dresser, Slope Tops Floor & Wall - Includes Alignment Template	\$164
*Mounting kit includes components to attach to the floor/wall but not the bolts or screws for wall or floor anchoring		
29B	Plywood Package Cabinet Backs Only	\$57
18	Wall Mounting Hardware Package	\$92
TP	Tamper Proof Screws	\$104

TRANSITIONS | WRITING DESKS

Standard Features:

- Standard Finish is Natural Oak
- Cabinet: Red Oak Veneer with Hardwood Plycore Sides | Full Length Modesty Panel
- Top: Oak grain HPL with Matching High-Impact External Thermoplastic Edge
- Tamper Resistant Hardware
- All Exterior Wood Components Sealed with ModuV
- ModuV is Our Specially formulated 100% Resin Top-Coat for Ease of Cleaning and Durability

ModuForm Finishes:

- Standard wood finish is Natural Oak
- Available wood finishes: Light Cherry, Cherry, Stone, Dark Mocha, Walnut
- *Please add stain upcharge for all standard finishes detailed above to list price
- Option: For custom wood finish, please add \$600 NET plus listed stain upcharge



TR3YNP-FMP

MODEL	DESCRIPTION	OPENINGS	DIMENSION	WT	LIST	*STAIN
TR3YNP-FMP	Desk Writing	-	24"d x 36"w x 30"h	65 lbs	\$828	+\$99

OPTIONS	DESCRIPTION	LIST
16	Mounting System (with Floor Leviling Glides Writing Desk Floor & Wall - Includes Alignment Template	\$164
16N	Mounting System (No Floor Levelling Glides) Writing Desk Floor & Wall - Includes Alignment Template	\$164
*Mounting kit includes components to attach to the floor/wall but not the bolts or screws for wall or floor anchoring		
TP	Tamper Proof Screws	\$104

TRANSITIONS | SLOPE TOP WARDROBE UNITS

Standard Features:

Standard Finish is Natural Oak
 Cabinet: Red Oak Veneer with Hardwood Plycore Sides
 Top: Oak grain HPL with Matching High-Impact External Thermoplastic Edge
 Shelves: Oak Veneer for Stability with Dowels and Toe Bore
 Tamper Resistant Hardware
 All Exterior Wood Components Sealed with ModuV
 ModuV is Our Specially formulated 100% Resin Top-Coat for Ease of Cleaning and Durability

ModuForm Finishes:

Standard wood finish is Natural Oak
 Available wood finishes: Light Cherry, Cherry, Stone, Dark Mocha, Walnut
 *Please add stain upcharge for all standard finishes detailed above to list price
 Option: For custom wood finish, please add \$600 NET plus listed stain upcharge



TR6ST2-80



TR6ST1-40-30



TR6ST1-40-24

MODEL	DESCRIPTION	OPENINGS	DIMENSION	WT	LIST	*STAIN
TR6ST2-80	Wardrobe	8	23.5"d x 36"w x 70.5"h	210 lbs	\$2,202	+\$220
TR6ST1-40-30	Wardrobe	4	23.5"d x 30"w x 70.5"h	210 lbs	\$1,798	+\$220
TR6ST1-40-24	Wardrobe	4	23.5"d x 24"w x 70.5"h	200 lbs	\$1,716	+\$220

OPTIONS	DESCRIPTION	LIST
16	Mounting System (with Floor Leveling Glides) Nightstand, Dresser, Slope Tops Floor & Wall - Includes Alignment Template	\$164
16N	Mounting System (No Floor Leveling Glides) Nightstand, Dresser, Slope Tops Floor & Wall - Includes Alignment Template	\$164
*Mounting kit includes components to attach to the floor/wall but not the bolts or screws for wall or floor anchoring		
29B	Plywood Package Cabinet Backs Only	\$121
18	Wall Mounting Hardware Package	\$92
TP	Tamper Proof Screws	\$134

TRANSITIONS | NIGHTSTAND

Standard Features:

Standard Finish is Natural Oak
 Cabinet: Red Oak Veneer with Hardwood Plycore Sides
 Top: Oak grain HPL with Matching High-Impact External Thermoplastic Edge
 Tamper Resistant Hardware
 All Exterior Wood Components Sealed with ModuV
 ModuV is Our Specially formulated 100% Resin Top-Coat for Ease of Cleaning and Durability

ModuForm Finishes:

Standard wood finish is Natural Oak
 Available wood finishes: Light Cherry, Cherry, Stone, Dark Mocha, Walnut
 *Please add stain upcharge for all standard finishes detailed above to list price
 Option: For custom wood finish, please add \$600 NET plus listed stain upcharge



TR5-20

MODEL	DESCRIPTION	OPENINGS	DIMENSION	WT	LIST	*STAIN
TR5-20	Nightstand	2	18"d x 15.75"w x 21"h	40 lbs	\$691	+\$56

OPTIONS	DESCRIPTION	LIST
16	Mounting System (with Floor Leveling Glides) Nightstand, Dresser, Slope Tops Floor & Wall - Includes Alignment Template	\$164
16N	Mounting System (No Floor Leveling Glides) Nightstand, Dresser, Slope Tops Floor & Wall - Includes Alignment Template	\$164
*Mounting kit includes components to attach to the floor/wall but not the bolts or screws for wall or floor anchoring		
18	Wall Mounting Hardware Package	\$92

TRANSITIONS | PLATFORM BEDS

Standard Features:

Standard Finish is Natural Oak
 Cabinet: Red Oak Veneer with Hardwood Plycore Sides, Headboard and Footboard
 Joinery: Internal Steel Frame (TR9SF) | Dowel & Glue (TR9C, TR9C-CUB, TR9C-54)
 Tamper Resistant Hardware
 Bed Deck: 14" High | Standard 45lb Particleboard
 36" x 80" or 54" x 80" Mattresses Available and Sold Separately*
 All Exterior Wood Components Sealed with ModuV
 ModuV is Our Specially formulated 100% Resin Top-Coat for Ease of Cleaning and Durability

ModuForm Finishes:

Standard wood finish is Natural Oak
 Available wood finishes: Light Cherry, Cherry, Stone, Dark Mocha, Walnut
 *Please add stain upcharge for all standard finishes detailed above to list price
 Option: For custom wood finish, please add \$600 NET plus listed stain upcharge



TR9SF



TR9C



TR9C-54



TR9C-CUB

MODEL	DESCRIPTION	SLEEP SURFACE	DIMENSION	WT	LIST	*STAIN
TR9SF	Platform Bed with Concealed Steel Framing *Mattress will be captured on 4 sides	Particle Board	37.5"d x 81.5"w x 16.25"h	177 lbs	\$2,307	+\$98
TR9C	Platform Bed *Mattress will be captured on 4 sides	Particle Board	37.5"d x 81.5"w x 16.25"h	140 lbs	\$1,598	+\$98
TR9C-54	Double/Full Platform Bed *Mattress will be captured on 4 sides	Particle Board	55.5"d x 81.5"w x 16.25"h	175 lbs	\$2,021	+\$98
TR9C-CUB	Platform Bed with 2 Cubbies *Mattress will be captured on 4 sides	Particle Board	37.5"d x 81.5"w x 16.25"h	145 lbs	\$2,521	+\$98

See Transitions Bed Options on Next Page

TRANSITIONS | PLATFORM BED | OPTIONS

OPTIONS	DESCRIPTION	LIST	*STAIN
16	Mounting System (with Floor Levling Glides Platform Bed Floor Mount	\$130	
16N	Mounting System (No Floor Leveling Glides) Platform Bed Floor Mount	\$130	
35	Oak Veneer Headboard Extension (15" High) Platform beds - Twin	\$563	+\$45
35D	Oak Veneer Headboard Extension (15" High) Platform beds - Double	\$584	+\$45
63	Plywood deck Twin Platform beds	\$194	
63D	Plywood deck Double Platform beds	\$237	
63WD	Plywood deck Twin Bed Laminated white Includes perimeter caulking sealant	\$321	
SS	Caulking Perimeter sealant Platform bed deck Factory applied	\$53	
TP	Tamper Proof Screws	\$134	
RK3	Removable Restraint Rail Kit - 3" On Center from Floor	\$492	+\$49

FORTRESS | DRESSERS

Standard Features:

Standard Finish is Natural Oak
 Cabinet: Solid Planked Red Oak Sides
 Top: Solid Red Oak on Dresser | Oak Veneer for Wardrobe
 Shelves: Oak Veneer for Stability with Dowels and Toe Bore
 Tamper Resistant Hardware
 All Exterior Wood Components Sealed with ModuV
 ModuV is Our Specially formulated 100% Resin Top-Coat for Ease of Cleaning and Durability

ModuForm Finishes:

Standard wood finish is Natural Oak
 Available wood finishes: Light Cherry, Cherry, Stone, Dark Mocha, Walnut
 *Please add stain upcharge for all standard finishes detailed above to list price
 Option: For custom wood finish, please add \$600 NET plus listed stain upcharge



FR4A

MODEL	DESC	DRAWERS	OPENINGS	DIMENSION	WT	LIST	*STAIN
FR4A	Dresser	-	3	24"d x 30"w x 30"h	105 lbs	\$1,430	+\$99

OPTIONS	DESCRIPTION	LIST
16	Mounting System (with Floor Leveling Glides) Nightstand, Dresser, Slope Tops Floor & Wall - Includes Alignment Template	\$164
16N	Mounting System (No Floor Leveling Glides) Nightstand, Dresser, Slope Tops Floor & Wall - Includes Alignment Template	\$164
*Mounting kit includes components to attach to the floor/wall but not the bolts or screws for wall or floor anchoring		
29B	Plywood Package Cabinet Backs Only	\$57
18	Wall Mounting Hardware Package	\$92
TP	Tamper Proof Screws	\$104

FORTRESS | DESKS

Standard Features:

Standard Finish is Natural Oak
 Cabinet: Solid Planked Red Oak Sides
 Top: Solid Planked Red Oak
 Shelves: Oak Veneer for Stability with Dowels and Toe Bore
 Tamper Resistant Hardware
 All Exterior Wood Components Sealed with ModuV
 ModuV is Our Specially formulated 100% Resin Top-Coat for Ease of Cleaning and Durability

ModuForm Finishes:

Standard wood finish is Natural Oak
 Available wood finishes: Light Cherry, Cherry, Stone, Dark Mocha, Walnut
 *Please add stain upcharge for all standard finishes detailed above to list price
 Option: For custom wood finish, please add \$600 NET plus listed stain upcharge



FR3YNP-FMP

MODEL	DESC	DRAWERS	OPENINGS	DIMENSION	WT	LIST	*STAIN
FR3YNP-FMP	Desk Writing	-	-	24"d x 36"w x 30"h	46 lbs	\$1,031	+\$99

OPTIONS	DESCRIPTION	LIST
16	Mounting System (with Floor Leviling Glides Writing Desk Floor & Wall - Includes Alignment Template	\$164
16N	Mounting System (No Floor Levelling Glides) Writing Desk Floor & Wall - Includes Alignment Template	\$164
*Mounting kit includes components to attach to the floor/wall but not the bolts or screws for wall or floor anchoring		
TP	Tamper Proof Screws	\$104

FORTRESS | SLOPE TOP WARDROBE UNITS

Standard Features:

Standard Finish is Natural Oak
 Cabinet: Solid Planked Red Oak Sides
 Top: Oak Veneer with Oak Binder
 Shelves: Oak Veneer for Stability with Dowels and Toe Bore
 Tamper Resistant Hardware
 All Exterior Wood Components Sealed with ModuV
 ModuV is Our Specially formulated 100% Resin Top-Coat for Ease of Cleaning and Durability

ModuForm Finishes:

Standard wood finish is Natural Oak
 Available wood finishes: Light Cherry, Cherry, Stone, Dark Mocha, Walnut
 *Please add stain upcharge for all standard finishes detailed above to list price
 Option: For custom wood finish, please add \$600 NET plus listed stain upcharge



FR6STD-80



FR6ST-40



FR6STS-40

MODEL	DESC	DRAWERS	OPENINGS	DIMENSION	WT	LIST	*STAIN
FR6STD-80	Wardrobe	-	8	24"d x 36"w x 70"h	210 lbs	\$2,856	+\$220
FR6ST-40	Wardrobe	-	4	24"d x 30"w x 70"h	200 lbs	\$2,459	+\$220
FR6STS-40	Wardrobe	-	4	24"d x 18"w x 70"h	185 lbs	\$2,174	+\$220

OPTIONS	DESCRIPTION	LIST
16	Mounting System (with Floor Leveling Glides) Nightstand, Dresser, Slope Tops Floor & Wall - Includes Alignment Template	\$164
16N	Mounting System (No Floor Leveling Glides) Nightstand, Dresser, Slope Tops Floor & Wall - Includes Alignment Template	\$164
*Mounting kit includes components to attach to the floor/wall but not the bolts or screws for wall or floor anchoring		
29	Plywood Package Cabinet Backs Drawer Bottoms - per cabinet	\$141
18	Wall Mounting Hardware Package	\$92
TP	Tamper Proof Screws	\$134

FORTRESS | NIGHTSTANDS

Standard Features:

Standard Finish is Natural Oak
 Cabinet: Solid Planked Red Oak Sides
 Top: Solid Planked Red Oak
 Shelves: Oak Veneer for Stability with Dowels and Toe Bore
 Tamper Resistant Hardware
 All Exterior Wood Components Sealed with ModuV
 ModuV is Our Specially formulated 100% Resin Top-Coat for Ease of Cleaning and Durability

ModuForm Finishes:

Standard wood finish is Natural Oak
 Available wood finishes: Light Cherry, Cherry, Stone, Dark Mocha, Walnut
 *Please add stain upcharge for all standard finishes detailed above to list price
 Option: For custom wood finish, please add \$600 NET plus listed stain upcharge



FR5-20



FR5-30

MODEL	DESC	DRAWERS	OPENINGS	DIMENSION	WT	LIST	*STAIN
FR5-20	Nightstand	-	2	18"d x 15.75"w x 21"h	40 lbs	\$797	+\$56
FR5-30	Nightstand	-	3	18"d x 15.75"w x 30"h	45 lbs	\$884	+\$56

OPTIONS	DESCRIPTION	LIST
16	Mounting System (with Floor Leveling Glides) Nightstand, Dresser, Slope Tops Floor & Wall - Includes Alignment Template	\$164
16N	Mounting System (No Floor Leveling Glides) Nightstand, Dresser, Slope Tops Floor & Wall - Includes Alignment Template	\$164
*Mounting kit includes components to attach to the floor/wall but not the bolts or screws for wall or floor anchoring		
29B	Plywood Package Cabinet Backs Only	\$38
18	Wall Mounting Hardware Package	\$92
TP	Tamper Proof Screws	\$88

FORTRESS | PLATFORM BEDS

Standard Features:

Standard Finish is Natural Oak
 Cabinet: Solid Planked Red Oak Sides
 Joinery: Internal Steel Frame (FR9SF, FR9SF-R, FR9SF-CUB) | Tamper Resistant Hardware
 Bed Deck: Particle Board | Deck Height: FR9SF: 18" | FR9C: 14"
 36" x 80" Mattress Available and Sold Separately*
 All Exterior Wood Components Sealed with ModuV
 ModuV is Our Specially formulated 100% Resin Top-Coat for Ease of Cleaning and Durability

ModuForm Finishes:

Standard wood finish is Natural Oak
 Available wood finishes: Light Cherry, Cherry, Stone, Dark Mocha, Walnut
 *Please add stain upcharge for all standard finishes detailed above to list price
 Option: For custom wood finish, please add \$600 NET plus listed stain upcharge



FR9SF

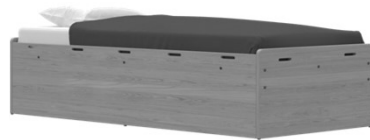

FR9SF-R



FR9SF-CUB



FR9C

MODEL	DECSRIPTION	SLEEP SURFACE	DIMENSION	WT	LIST	*STAIN
FR9SF	Internal Steel Frame *Mattress will be captured on 4 sides	Particle Board	37.5"d x 82"w x 20.75"h	170 lbs	\$3,000	+\$98
FR9SF-R	Internal Steel Frame with Restraint Portals Restraint straps not included *Mattress will be captured on 4 sides	Particle Board	37.5"d x 82"w x 20.75"h	177 lbs	\$3,094	+\$98
FR9SF-CUB	Internal Steel Frame with Cubbies *Mattress will be captured on 4 sides	Particle Board	37.5"d x 82"w x 20.75"h	185 lbs	\$4,036	+\$98
FR9C	Platform Bed *Mattress will be captured on 4 sides	Particle Board	37.5"d x 81.5"w x 15.5"h	130 lbs	\$1,890	+\$98

FORTRESS | PLATFORM BED | OPTIONS

OPTIONS	DESCRIPTION	LIST	*STAIN
16	Mounting System (with Floor Levling Glides Platform Bed Floor Mount	\$130	
16N	Mounting System (No Floor Leveling Glides) Platform Bed Floor Mount	\$130	
*Mounting kit includes components to attach to the floor/wall but not the bolts or screws for wall or floor anchoring			
35	Oak Veneer Headboard Extension (15" High) Platform beds - Twin	\$563	+\$45
63	Plywood deck Twin Platform beds	\$194	
63WD	Plywood deck Twin Bed Laminated white Includes perimeter caulking sealant	\$321	
SS	Caulking Perimeter sealant Platform bed deck Factory applied	\$53	
TP	Tamper Proof Screws	\$134	
RK3	Removable Restraint Rail Kit - 3" On Center from Floor	\$492	+\$49

ZEAL | DESK

Standard Features:

Cabinet: Red Oak Veneer, Hardwood Plycore Sides
 Top: Oak grain HPL with Matching External Thermoplastic Edge
 All Exterior Wood Components & Drawer Parts Sealed with ModuV
 ModuV is Our Specially formulated 100% Resin Top-Coat for Ease of Cleaning and Durability

ModuForm Finishes:

Standard wood finish is Natural Oak
 Available wood finishes: Light Cherry, Cherry, Stone, Dark Mocha, Walnut
 *Please add stain upcharge for all standard finishes detailed above to list price
 Option: For custom wood finish, please add \$600 NET plus listed stain upcharge



ZE3ZNP-FMP

MODEL	DESCRIPTION	DRAWERS	OPENINGS	DIMENSION	WT	LIST	*STAIN
ZE3ZNP-FMP	Desk Writing	-	-	18"d x 30"w x 30"h	40 lbs	\$834	+\$99

ZEAL | DRESSER

Standard Features:

- Cabinet: Red Oak Veneer, Hardwood Plycore Sides
- Drawer Front: Solid Planked Red Oak with Routed Crescent Finger Pull
- Drawer: Restrictor Clips to Discourage Removal
- Top: Oak grain HPL with Matching External Thermoplastic Edge (Toasted Hardboard EV4UB)
- All Exterior Wood Components & Drawer Parts Sealed with ModuV
- ModuV is Our Specially formulated 100% Resin Top-Coat for Ease of Cleaning and Durability

ModuForm Finishes:

- Standard wood finish is Natural Oak
- Available wood finishes: Light Cherry, Cherry, Stone, Dark Mocha, Walnut
- *Please add stain upcharge for all standard finishes detailed above to list price
- Option: For custom wood finish, please add \$600 NET plus listed stain upcharge



ZE4A-18



ZE4B-18

MODEL	DESCRIPTION	DRAWERS	DIMENSION	WT	LIST	*STAIN
ZE4A-18	Dresser	3	18"d x 30"w x 30"h	105 lbs	\$1,344	+\$99
ZE4B-18	Dresser	4	18"d x 30"w x 39"h	110 lbs	\$1,637	+\$99

OPTIONS	DESCRIPTION	LIST
6	Lock Drawer Lock (cylinder style with strike plate) - per drawer*	\$114
37	Lock Lock Hasp Kit for Drawers - per drawer	\$51
PL	Surface Mounted Pull Subject to Availability - per pull See Handles & Pulls	\$27
29	Plywood Package Cabinet Backs Drawer Bottoms - per cabinet	\$66

*If "keyed alike" locks or "master keys" are required, additional charges may apply.

ZEAL | NIGHTSTAND

Standard Features:

Cabinet: Red Oak Veneer, Hardwood Plycore Sides
 Drawer Front: Solid Planked Red Oak with Routed Crescent Finger Pull
 Drawer: Restrictor Clips to Discourage Removal
 Top: Oak grain HPL with Matching External Thermoplastic Edge (Toasted Hardboard EV4UB)
 All Exterior Wood Components & Drawer Parts Sealed with ModuV
 ModuV is Our Specially formulated 100% Resin Top-Coat for Ease of Cleaning and Durability

ModuForm Finishes:

Standard wood finish is Natural Oak
 Available wood finishes: Light Cherry, Cherry, Stone, Dark Mocha, Walnut
 *Please add stain upcharge for all standard finishes detailed above to list price
 Option: For custom wood finish, please add \$600 NET plus listed stain upcharge



ZE5A-1D



ZE5A-2D



ZE5B-3D



ZE5B-DD

MODEL	DESCRIPTION	DRAWERS	OPENINGS	DIMENSION	WT	LIST	*STAIN
ZE5A-1D	Nightstand	1	1	18"d x 15.75"w x 20.5"h	50 lbs	\$906	+\$56
ZE5A-2D	Nightstand	2	-	18"d x 15.75"w x 20/5"h	45 lbs	\$978	+\$56
ZE5B-3D	Nightstand	3	-	18"d x 15.75"w x 30"h	51 lbs	\$1,176	+\$56
ZE5B-DD	Nightstand	1	1	18"d x 15.75"w x 30"h	47 lbs	\$1,201	+\$56

OPTIONS	DESCRIPTION	LIST
6	Lock Drawer Lock (cylinder style with strike plate) - per drawer*	\$114
37	Lock Lock Hasp Kit for Drawers - per drawer	\$51
PL	Surface Mounted Pull Subject to Availability - per pull See Handles & Pulls	\$27
29B	Plywood Package Cabinet Backs Only	\$38

*If "keyed alike" locks or "master keys" are required, additional charges may apply.

ZEAL | WARDROBE

Standard Features:

Cabinet: Red Oak Veneer, Hardwood Plycore Sides | Doors are Oak Veneer
 Drawer Front: Solid Planked Red Oak with Routed Crescent Finger Pull
 Drawer: Restrictor Clips to Discourage Removal
 Top: Oak grain HPL with Matching External Thermoplastic Edge
 Hardware: Full Length Piano Hinge & Brushed Nickel Curved Pull
 Adjustable Floor Leveling Glides Standard
 Single Door Wardrobe Doors Open Left
 All Exterior Wood Components & Drawer Parts Sealed with ModuV
 ModuV is Our Specially formulated 100% Resin Top-Coat for Ease of Cleaning and Durability

ModuForm Finishes:

Standard wood finish is Natural Oak
 Available wood finishes: Light Cherry, Cherry, Stone, Dark Mocha, Walnut
 *Please add stain upcharge for all standard finishes detailed above to list price
 Option: For custom wood finish, please add \$600 NET plus listed stain upcharge



ZE6B30



ZE6B20-1DL



ZE6C2

MODEL	DESCRIPTION	DRAWERS	DOORS	DIMENSION	WT	LIST	*STAIN
ZE6B30	with Clothing Suspension	-	2	23"d x 30"w x 78"h	165 lbs	\$2,516	+\$220
ZE6B30-3V	with 4 Openings	-	2	23"d x 30"w x 78"h	180 lbs	\$2,616	+\$220
ZE6B20-1DL	with Clothing Suspension	-	1	23"d x 30"w x 78"h	150 lbs	\$2,312	+\$220
ZE6B20-1DL-3V	with 4 Openings	-	1	23"d x 30"w x 78"h	165 lbs	\$2,550	+\$220
ZE6C2	with Clothing Suspension	2	2	23"d x 30"w x 78"h	210 lbs	\$3,233	+\$220
ZE6C2-3V	with 4 Openings	2	2	23"d x 30"w x 78"h	225 lbs	\$3,278	+\$220

ZEAL | WARDROBE OPTIONS

OPTIONS	DESCRIPTION	LIST
5	Lock Wardrobe Door Lock Kit (cylinder style with and without slide bolt)*	\$157
6	Lock Drawer Lock (cylinder style with strike plate) - per drawer*	\$114
37	Lock Lock Hasp Kit for Drawers - per drawer	\$51
PL	Surface Mounted Pull Subject to Availability - per pull See Handles & Pulls	\$27
29B	Plywood Package Cabinet Backs Only	\$121
25	Center Divider Wardrobe	\$483
V	Shelf Fixed Per shelf	\$192

*If "keyed alike" locks or "master keys" are required, additional charges may apply.

EVEREST | PLATFORM BEDS

Standard Features:

Standard Finish is Natural Oak
 Cabinet: Red Oak Veneer, Hardwood Plycore
 Solid Red Oak Drawer Fronts with Full Length Finger Bevel Pull Top Edge
 Bed Deck: Particle Board | Deck Height: 14" high
 Fits 36" x 80 Mattress which are Available and Sold Separately*
 All Exterior Wood Components Sealed with ModuV
 ModuV is Our Specially formulated 100% Resin Top-Coat for Ease of Cleaning and Durability

ModuForm Finishes:

Standard wood finish is Natural Oak
 Available wood finishes: Light Cherry, Cherry, Stone, Dark Mocha, Walnut
 *Please add stain upcharge for all standard finishes detailed above to list price
 Option: For custom wood finish, please add \$600 NET plus listed stain upcharge



EV9C-ES



EV9-2D



EV9-3D

MODEL	DESCRIPTION	DRAWERS	DIMENSION	WT	LIST	*STAIN
EV9C-ES	Platform Bed with Elevated Sides	-	37.5"d x 81.5"w x 16.25"h	140 lbs	\$1,350	+\$98
EV9-2D	Platform Bed Full Length Drawers *Mattress will be captured by head and foot boards	2	37.5"d x 81.5"w x 16.25"h	145 lbs	\$2,232	+\$98
EV9-3D	Platform Bed Full Length Drawers *Mattress will be captured by head and foot boards	3	37.5"d x 81.5"w x 16.25"h	150 lbs	\$2,519	+\$98

OPTIONS	DESCRIPTION	LIST	*STAIN
6	Lock Drawer Lock (cylinder style with strike plate) - per drawer*	\$114	
10	Drawer Restriction Prevents removal Per drawer	\$27	
37	Lock Lock Hasp Kit for Drawers - per drawer	\$51	
35	Oak Veneer Headboard Extension (15" High) Platform beds - Twin	\$563	+\$45
63	Plywood deck Twin Platform beds	\$194	
63WD	Plywood deck Twin Bed Laminated white Includes perimeter caulking sealant	\$321	
SS	Caulking Perimeter sealant Platform bed deck Factory applied	\$53	

*If "keyed alike" locks or "master keys" are required, additional charges may apply.

EVEREST | PLATFORM BEDS

Standard Features:

Standard Finish is Natural Oak
 Cabinet: Red Oak Veneer, Hardwood Plycore
 Solid Red Oak Drawer Fronts with Full Length Finger Bevel Pull Top Edge
 Bed Deck: Particle Board | Deck Height: 14"h on EV9-2D | 21"h on EV9-4D
 Fits 36" x 80 Mattress which are Available and Sold Separately*
 All Exterior Wood Components Sealed with ModuV
 ModuV is Our Specially formulated 100% Resin Top-Coat for Ease of Cleaning and Durability

ModuForm Finishes:

Standard wood finish is Natural Oak
 Available wood finishes: Light Cherry, Cherry, Stone, Dark Mocha, Walnut
 *Please add stain upcharge for all standard finishes detailed above to list price
 Option: For custom wood finish, please add \$600 NET plus listed stain upcharge



EV9-2DR



EV9-2DL



EV9-4DR



EV9-4DL

MODEL	DESCRIPTION	DRAWERS	DIMENSION	WT	LIST	*STAIN
EV9-2DR	2 Offset Drawers Right Facing *Mattress will be captured on 4 sides	2	37.5"d x 81.5"w x 16.25"h	150 lbs	\$2,372	+\$98
EV9-2DL	2 Offset Drawers Left Facing *Mattress will be captured on 4 sides	2	37.5"d x 81.5"w x 16.25"h	150 lbs	\$2,372	+\$98
EV9-4DR	4 Offset Drawers Right Facing * 4DR beds fits 38" x 80" mattress which are available and sold separately *Mattress will be captured on 4 sides	4	39.5"d x 81.5"w x 21.5"h	185 lbs	\$3,055	+\$98
EV9-4DL	4 Offset Drawers Left Facing * 4DR beds fits 38" x 80" mattress which are available and sold separately *Mattress will be captured on 4 sides	4	39.5"d x 81.5"w x 21.5"h	185 lbs	\$3,055	+\$98

STATEMENT OF LINE - INVERTED SEAM



IVSBS Style: Nylon Ticking
Edge: Inverted Seam
Core: Innerspring



IVSH Style: Hexcel Nylon Ticking with Greater Abrasion Resistance
Edge: Inverted Seam
Core: Innerspring



IVSV Style: Vinyl Ticking
Edge: Inverted Seam
Core: Innerspring

STATEMENT OF LINE - TAPE SEAM



BS Style: Nylon Ticking
Edge: Stitched Taped Seam
Core: Innerspring



H Style: Hexcel Nylon Ticking with Greater Abrasion Resistance
Edge: Stitched Taped Seam
Core: Innerspring



V Style: Vinyl Ticking
Edge: Stitched Taped Seam
Core: Innerspring



QT Style: Polyester Ticking
Edge: Stitched Taped Seam
Core: Innerspring
Quilted Top

STATEMENT OF LINE - MODUMATTRESS INVERTED SEAM FOAM CORE



ModuMattress

VMX Style: Vinyl Ticking

Edge: Inverted RF Welded Seams - No Stitching

Core: Dual Density Polyurethane Foam



ModuMattress

MX Style: Polyurethane Ticking

Edge: Inverted RF Welded Seams - No Stitching

Core: Dual Density Polyurethane Foam



ModuMattress

SAMX: Ripstop Ticking

Edge: Inverted RF Welded Seams - No Stitching

Core: Dual Density Polyurethane Foam

ModuMattresses available with or without Integrated Pillows:



Without Integrated Pillow



With One (1) Integrated Pillow



With Two (2) Integrated Pillows

BOX SPRING/FOUNDATION - POLYESTER | NYLON | HEX | VINYL | QUILTED

MODEL	TYPE	CORE	TICKING	SEAM	DIMENSION	WT	LIST
BSF3675BS	Foundation	-	Blue Nylon	Tape Edge Sewn	36"w x 75"d x 8"h	45 lbs	\$600
BSFIVS3675BS	Foundation	-	Blue Nylon	Inverted Seam Sewn	36"w x 75"d x 8"h	45 lbs	\$651
BSF3675H	Foundation	-	Blue Hexcel Nylon	Tape Edge Sewn	36"w x 75"d x 8"h	45 lbs	\$626
BSFIVS3675H	Foundation	-	Blue Hexcel Nylon	Inverted Seam Sewn	36"w x 75"d x 8"h	45 lbs	\$679
BSF3675V	Foundation	-	Green Vinyl	Tape Edge Sewn	36"w x 75"d x 8"h	45 lbs	\$600
BSFIVS3675V	Foundation	-	Green Vinyl	Inverted Seam Sewn	36"w x 75"d x 8"h	45 lbs	\$651
BSF3675QT	Foundation	-	Polyester Quilted	Tape Edge Sewn	36"w x 75"d x 8"h	45 lbs	\$653
BSF3680BS	Foundation	-	Blue Nylon	Tape Edge Sewn	36"w x 80"d x 8"h	45 lbs	\$600
BSFIVS3680BS	Foundation	-	Blue Nylon	Inverted Seam Sewn	36"w x 80"d x 8"h	45 lbs	\$651
BSF3680H	Foundation	-	Blue Hexcel Nylon	Tape Edge Sewn	36"w x 80"d x 8"h	45 lbs	\$626
BSFIVS3680H	Foundation	-	Blue Hexcel Nylon	Inverted Seam Sewn	36"w x 80"d x 8"h	45 lbs	\$679
BSF3680V	Foundation	-	Green Vinyl	Tape Edge Sewn	36"w x 80"d x 8"h	45 lbs	\$600
BSFIVS3680V	Foundation	-	Green Vinyl	Inverted Seam Sewn	36"w x 80"d x 8"h	45 lbs	\$651
BSF3680QT	Foundation	-	Polyester Quilted	Tape Edge Sewn	36"w x 80"d x 8"h	45 lbs	\$653
BSF3875BS	Foundation	-	Blue Nylon	Tape Edge Sewn	38"w x 75"d x 8"h	45 lbs	\$600
BSFIVS3875BS	Foundation	-	Blue Nylon	Inverted Seam Sewn	38"w x 75"d x 8"h	45 lbs	\$651
BSF3875H	Foundation	-	Blue Hexcel Nylon	Tape Edge Sewn	38"w x 75"d x 8"h	45 lbs	\$626
BSFIVS3875H	Foundation	-	Blue Hexcel Nylon	Inverted Seam Sewn	38"w x 75"d x 8"h	45 lbs	\$679
BSF3875V	Foundation	-	Green Vinyl	Tape Edge Sewn	38"w x 75"d x 8"h	45 lbs	\$600
BSFIVS3875V	Foundation	-	Green Vinyl	Inverted Seam Sewn	38"w x 75"d x 8"h	45 lbs	\$651
BSF3875QT	Foundation	-	Polyester Quilted	Tape Edge Sewn	38"w x 75"d x 8"h	45 lbs	\$653
BSF3880BS	Foundation	-	Blue Nylon	Tape Edge Sewn	38"w x 80"d x 8"h	50 lbs	\$621
BSFIVS3880BS	Foundation	-	Blue Nylon	Inverted Seam Sewn	38"w x 80"d x 8"h	50 lbs	\$673
BSF3880H	Foundation	-	Blue Hexcel Nylon	Tape Edge Sewn	38"w x 80"d x 8"h	50 lbs	\$647
BSFIVS3880H	Foundation	-	Blue Hexcel Nylon	Inverted Seam Sewn	38"w x 80"d x 8"h	50 lbs	\$701
BSF3880V	Foundation	-	Green Vinyl	Tape Edge Sewn	38"w x 80"d x 8"h	50 lbs	\$621
BSFIVS3880V	Foundation	-	Green Vinyl	Inverted Seam Sewn	38"w x 80"d x 8"h	50 lbs	\$673
BSF3880QT	Foundation	-	Polyester Quilted	Tape Edge Sewn	38"w x 80"d x 8"h	50 lbs	\$673

BOX SPRING/FOUNDATION - POLYESTER | NYLON | HEX | VINYL | QUILTED

MODEL	TYPE	CORE	TICKING	SEAM	DIMENSION	WT	LIST
BSF5475BS	Foundation	-	Blue Nylon	Tape Edge Sewn	54"w x 75"d x 8"h	60 lbs	\$731
BSFIVS5475BS	Foundation	-	Blue Nylon	Inverted Seam Sewn	54"w x 75"d x 8"h	60 lbs	\$791
BSF5475H	Foundation	-	Blue Hexcel Nylon	Tape Edge Sewn	54"w x 75"d x 8"h	60 lbs	\$783
BSFIVS5475H	Foundation	-	Blue Hexcel Nylon	Inverted Seam Sewn	54"w x 75"d x 8"h	60 lbs	\$849
BSF5475V	Foundation	-	Green Vinyl	Tape Edge Sewn	54"w x 75"d x 8"h	60 lbs	\$731
BSFIVS5475V	Foundation	-	Green Vinyl	Inverted Seam Sewn	54"w x 75"d x 8"h	60 lbs	\$791
BSF5475QT	Foundation	-	Polyester Quilted	Tape Edge Sewn	54"w x 75"d x 8"h	60 lbs	\$783
BSF5480BS	Foundation	-	Blue Nylon	Tape Edge Sewn	54"w x 80"d x 8"h	70 lbs	\$758
BSFIVS5480BS	Foundation	-	Blue Nylon	Inverted Seam Sewn	54"w x 80"d x 8"h	70 lbs	\$821
BSF5480H	Foundation	-	Blue Hexcel Nylon	Tape Edge Sewn	54"w x 80"d x 8"h	70 lbs	\$809
BSFIVS5480H	Foundation	-	Blue Hexcel Nylon	Inverted Seam Sewn	54"w x 80"d x 8"h	70 lbs	\$877
BSF5480V	Foundation	-	Green Vinyl	Tape Edge Sewn	54"w x 80"d x 8"h	70 lbs	\$758
BSFIVS5480V	Foundation	-	Green Vinyl	Inverted Seam Sewn	54"w x 80"d x 8"h	70 lbs	\$821
BSF5480QT	Foundation	-	Polyester Quilted	Tape Edge Sewn	54"w x 80"d x 8"h	70 lbs	\$809
BSF6080BS	Foundation	-	Blue Nylon	Tape Edge Sewn	60"w x 80"d x 8"h	80 lbs	\$809
BSFIVS6080BS	Foundation	-	Blue Nylon	Inverted Seam Sewn	60"w x 80"d x 8"h	80 lbs	\$877
BSF6080H	Foundation	-	Blue Hexcel Nylon	Tape Edge Sewn	60"w x 80"d x 8"h	80 lbs	\$862
BSFIVS6080H	Foundation	-	Blue Hexcel Nylon	Inverted Seam Sewn	60"w x 80"d x 8"h	80 lbs	\$933
BSF6080V	Foundation	-	Green Vinyl	Tape Edge Sewn	60"w x 80"d x 8"h	80 lbs	\$809
BSFIVS6080V	Foundation	-	Green Vinyl	Inverted Seam Sewn	60"w x 80"d x 8"h	80 lbs	\$877
BSF6080QT	Foundation	-	Polyester Quilted	Tape Edge Sewn	60"w x 80"d x 8"h	80 lbs	\$862

MATTRESSES - POLYESTER | NYLON | HEX | VINYL | QUILTED

MODEL	TYPE	CORE	TICKING	SEAM	DIMENSION	WT	LIST
MTF3675BS	Mattress	Innerspring	Blue Nylon	Tape Edge Sewn	36"w x 75"d x 8"h	35 lbs	\$682
MTFIVS3675BS	Mattress	Innerspring	Blue Nylon	Inverted Seam Sewn	36"w x 75"d x 8"h	35 lbs	\$740
MTF3675H	Mattress	Innerspring	Blue Hexcel Nylon	Tape Edge Sewn	36"w x 75"d x 8"h	35 lbs	\$709
MTFIVS3675H	Mattress	Innerspring	Blue Hexcel Nylon	Inverted Seam Sewn	36"w x 75"d x 8"h	35 lbs	\$768
MTF3675V	Mattress	Innerspring	Green Vinyl	Tape Edge Sewn	36"w x 75"d x 8"h	35 lbs	\$682
MTFIVS3675V	Mattress	Innerspring	Green Vinyl	Inverted Seam Sewn	36"w x 75"d x 8"h	35 lbs	\$740
MTF3675QT	Mattress	Innerspring	Polyester Quilted	Tape Edge Sewn	36"w x 75"d x 8"h	35 lbs	\$841
MTF3680BS	Mattress	Innerspring	Blue Nylon	Tape Edge Sewn	36"w x 80"d x 8"h	35 lbs	\$707
MTFIVS3680BS	Mattress	Innerspring	Blue Nylon	Inverted Seam Sewn	36"w x 80"d x 8"h	35 lbs	\$767
MTF3680H	Mattress	Innerspring	Blue Hexcel Nylon	Tape Edge Sewn	36"w x 80"d x 8"h	35 lbs	\$734
MTFIVS3680H	Mattress	Innerspring	Blue Hexcel Nylon	Inverted Seam Sewn	36"w x 80"d x 8"h	35 lbs	\$795
MTF3680V	Mattress	Innerspring	Green Vinyl	Tape Edge Sewn	36"w x 80"d x 8"h	35 lbs	\$707
MTFIVS3680V	Mattress	Innerspring	Green Vinyl	Inverted Seam Sewn	36"w x 80"d x 8"h	35 lbs	\$767
MTF3680QT	Mattress	Innerspring	Polyester Quilted	Tape Edge Sewn	36"w x 80"d x 8"h	35 lbs	\$866
MTF3875BS	Mattress	Innerspring	Blue Nylon	Tape Edge Sewn	38"w x 75"d x 8"h	40 lbs	\$688
MTFIVS3875BS	Mattress	Innerspring	Blue Nylon	Inverted Seam Sewn	38"w x 75"d x 8"h	40 lbs	\$745
MTF3875H	Mattress	Innerspring	Blue Hexcel Nylon	Tape Edge Sewn	38"w x 75"d x 8"h	40 lbs	\$714
MTFIVS3875H	Mattress	Innerspring	Blue Hexcel Nylon	Inverted Seam Sewn	38"w x 75"d x 8"h	40 lbs	\$773
MTF3875V	Mattress	Innerspring	Green Vinyl	Tape Edge Sewn	38"w x 75"d x 8"h	40 lbs	\$688
MTFIVS3875V	Mattress	Innerspring	Green Vinyl	Inverted Seam Sewn	38"w x 75"d x 8"h	40 lbs	\$745
MTF3875QT	Mattress	Innerspring	Polyester Quilted	Tape Edge Sewn	38"w x 75"d x 8"h	40 lbs	\$841
MTF3880BS	Mattress	Innerspring	Blue Nylon	Tape Edge Sewn	38"w x 80"d x 8"h	40 lbs	\$744
MTFIVS3880BS	Mattress	Innerspring	Blue Nylon	Inverted Seam Sewn	38"w x 80"d x 8"h	40 lbs	\$711
MTF3880H	Mattress	Innerspring	Blue Hexcel Nylon	Tape Edge Sewn	38"w x 80"d x 8"h	40 lbs	\$776
MTFIVS3880H	Mattress	Innerspring	Blue Hexcel Nylon	Inverted Seam Sewn	38"w x 80"d x 8"h	40 lbs	\$841
MTF3880V	Mattress	Innerspring	Green Vinyl	Tape Edge Sewn	38"w x 80"d x 8"h	40 lbs	\$744
MTFIVS3880V	Mattress	Innerspring	Green Vinyl	Inverted Seam Sewn	38"w x 80"d x 8"h	40 lbs	\$806
MTF3880QT	Mattress	Innerspring	Polyester Quilted	Tape Edge Sewn	38"w x 80"d x 8"h	40 lbs	\$893

MATTRESSES - POLYESTER | NYLON | HEX | VINYL | QUILTED

MODEL	TYPE	CORE	TICKING	SEAM	DIMENSION	WT	LIST
MTF5475BS	Mattress	Innerspring	Blue Nylon	Tape Edge Sewn	54"w x 75"d x 8"h	75 lbs	\$867
MTFIVS5475BS	Mattress	Innerspring	Blue Nylon	Inverted Seam Sewn	54"w x 75"d x 8"h	75 lbs	\$939
MTF5475H	Mattress	Innerspring	Blue Hexcel Nylon	Tape Edge Sewn	54"w x 75"d x 8"h	75 lbs	\$920
MTFIVS5475H	Mattress	Innerspring	Blue Hexcel Nylon	Inverted Seam Sewn	54"w x 75"d x 8"h	75 lbs	\$996
MTF5475V	Mattress	Innerspring	Green Vinyl	Tape Edge Sewn	54"w x 75"d x 8"h	75 lbs	\$867
MTFIVS5475V	Mattress	Innerspring	Green Vinyl	Inverted Seam Sewn	54"w x 75"d x 8"h	75 lbs	\$939
MTF5475QT	Mattress	Innerspring	Polyester Quilted	Tape Edge Sewn	54"w x 75"d x 8"h	75 lbs	\$1,078
MTF5480BS	Mattress	Innerspring	Blue Nylon	Tape Edge Sewn	54"w x 80"d x 8"h	75 lbs	\$918
MTFIVS5480BS	Mattress	Innerspring	Blue Nylon	Inverted Seam Sewn	54"w x 80"d x 8"h	75 lbs	\$995
MTF5480H	Mattress	Innerspring	Blue Hexcel Nylon	Tape Edge Sewn	54"w x 80"d x 8"h	75 lbs	\$971
MTFIVS5480H	Mattress	Innerspring	Blue Hexcel Nylon	Inverted Seam Sewn	54"w x 80"d x 8"h	75 lbs	\$1,052
MTF5480V	Mattress	Innerspring	Green Vinyl	Tape Edge Sewn	54"w x 80"d x 8"h	75 lbs	\$918
MTFIVS5480V	Mattress	Innerspring	Green Vinyl	Inverted Seam Sewn	54"w x 80"d x 8"h	75 lbs	\$995
MTF5480QT	Mattress	Innerspring	Polyester Quilted	Tape Edge Sewn	54"w x 80"d x 8"h	75 lbs	\$1,156
MTF6080BS	Mattress	Innerspring	Blue Nylon	Tape Edge Sewn	60"w x 80"d x 8"h	75 lbs	\$1,024
MTFIVS6080BS	Mattress	Innerspring	Blue Nylon	Inverted Seam Sewn	60"w x 80"d x 8"h	75 lbs	\$1,110
MTF6080H	Mattress	Innerspring	Blue Hexcel Nylon	Tape Edge Sewn	60"w x 80"d x 8"h	75 lbs	\$1,077
MTFIVS6080H	Mattress	Innerspring	Blue Hexcel Nylon	Inverted Seam Sewn	60"w x 80"d x 8"h	75 lbs	\$1,167
MTF6080V	Mattress	Innerspring	Green Vinyl	Tape Edge Sewn	60"w x 80"d x 8"h	75 lbs	\$1,024
MTFIVS6080V	Mattress	Innerspring	Green Vinyl	Inverted Seam Sewn	60"w x 80"d x 8"h	75 lbs	\$1,110
MTF6080QT	Mattress	Innerspring	Polyester Quilted	Tape Edge Sewn	60"w x 80"d x 8"h	75 lbs	\$1,289

MODUMATTRESS - BEHAVIORAL HEALTH MATTRESSES

MODEL	TYPE	CORE	TICKING	SEAM	PILLOW	DIMENSION	WT	LIST
MTF3680VMX-DD	Mattress	Foam	Green Vinyl	RF Welded	-	36"w x 80"d x 6"h	22 lbs	\$1,201
MTF3680VMX-DD1P	Mattress	Foam	Green Vinyl	RF Welded	1	36"w x 80"d x 6"h	22 lbs	\$1,212
MTF3680VMX-DD2P	Mattress	Foam	Green Vinyl	RF Welded	2	36"w x 80"d x 6"h	22 lbs	\$1,354
MTF2575VMX-DD	Mattress	Foam	Green Vinyl	RF Welded	-	25"w x 75"d x 6"h	20 lbs	\$958
MTF3680MX-DD	Mattress	Foam	Blue Polyurethane	RF Welded	-	36"w x 80"d x 6"h	22 lbs	\$1,385
MTF3680MX-DD1P	Mattress	Foam	Blue Polyurethane	RF Welded	1	36"w x 80"d x 6"h	22 lbs	\$1,398
MTF3680MX-DD2P	Mattress	Foam	Blue Polyurethane	RF Welded	2	36"w x 80"d x 6"h	22 lbs	\$1,561
MTF2575MX-DD	Mattress	Foam	Blue Polyurethane	RF Welded	-	25"w x 75"d x 6"h	20 lbs	\$1,079
MTF3680SAMX-DD	Mattress	Foam	Blue Ripstop	RF Welded	-	36"w x 80"d x 6"h	22 lbs	\$1,524
MTF3680SAMX-DD1P	Mattress	Foam	Blue Ripstop	RF Welded	1	36"w x 80"d x 6"h	22 lbs	\$1,537
MTF3680SAMX-DD2P	Mattress	Foam	Blue Ripstop	RF Welded	2	36"w x 80"d x 6"h	22 lbs	\$1,717
MTF2575SAMX-DD	Mattress	Foam	Blue Ripstop	RF Welded	-	25"w x 75"d x 6"h	20 lbs	\$1,187

STATEMENT OF LINE - WOOD



LS701UBS



LS701AW



LS716UBS



LS716AW



MS283



MS284

STATEMENT OF LINE - MOLDED

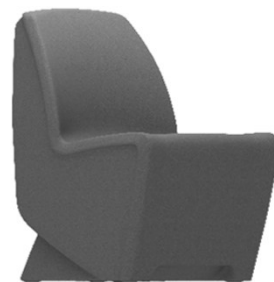

50-701



50-702



5000-20

5000 | MODUMAXX STACKING ARM CHAIR

Standard Features:

- One-piece injection molded construction without steel or wood components of any kind
- Pigmented color is homogeneous throughout rather than just the chair surface
- Chair feet are at double angles to reduce stress and maintain stability when in a rock-back position
- Clean with mild detergents or steam and can be sanitized with bleach-based agents
- Contains UV light stabilizers to prevent fading and anti-static additives to reduce dust attraction
- Chairs stack Up To 20 high, hold a static load of 400 lbs and meets CAL133 flammability requirements

Standard Stack Chair Colors:

- 225 | Splash
- 318 | Burgundy
- 426 | Slate Blue
- 700 | Sandstream
- 845 | Flannel Grey



5000-20



MODEL	DESCRIPTION	SEAT & BACK	DIMENSION	AH	AW	SH	SW	SD	WT
5000-20	Armchair Stacking	Polypropylene	24"d x 24"w x 33"h	26"	3"	18"	17.5"	18"	11 lbs

MODEL	225 Splash	318 Burgundy	426 Slate Blue	700 Sandstream	845 Flannel Grey
5000-20	\$184	\$184	\$184	\$184	\$184

5000 | MODUMAXX ACTIVITY/DINING CHAIR

Standard Features:

- One-piece rotationally molded construction without steel or wood components of any kind
- Pigmented color is homogeneous throughout rather than just the chair surface
- Clean with mild detergents or steam and can be sanitized with bleach-based agents
- Contains UV light stabilizers to prevent fading and anti-static additives to reduce dust attraction
- Optional secure ballasting access cover to add weight if needed
- Flame retardant and self extinguishing | Passes CAL TB 133

Standard Activity Chair Colors:

- 318 | Burgundy
- 360 | Grape
- 426 | Slate Blue
- 445 | Surf
- 525 | Celtic
- 901 | Black
- 902 | Shade

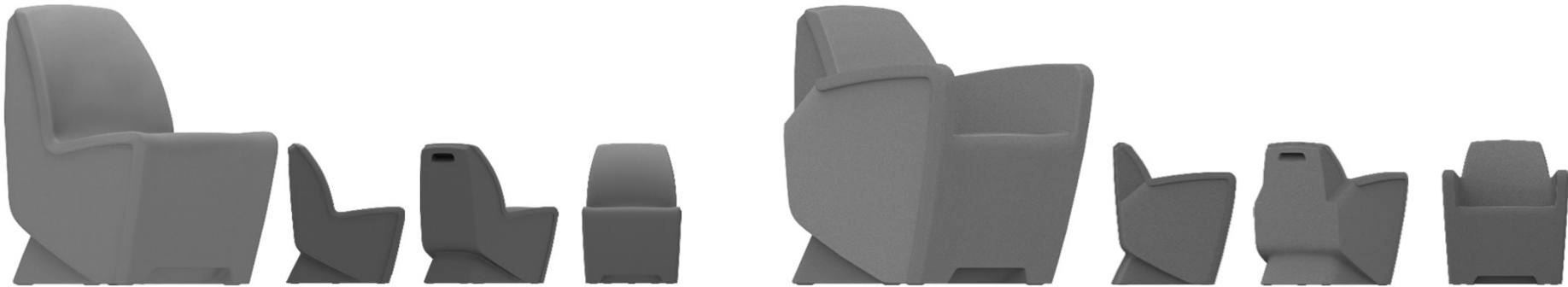

MODEL	DESCRIPTION	SEAT & BACK	DIMENSION	AH	AW	SH	SW	SD	WT	LIST
50-701	Chair Armless	Polyethylene	25"d x 21"w x 33"h	-	-	17.5"	17.5"	18"	20 lbs	\$686
50-702	Chair Arm	Polyethylene	25"d x 24"w x 33"h	26"	2"	17.5"	17.5"	18"	25 lbs	\$789
BAC	Ballast Access Cover	-	-	-	-	-	-	-	-	\$246



NOTE: Heavy-strength, industrial plastic bags should be used to contain ballasting material when adding weight to chairs (not included). Once filled, end should be securely tied off.

LS SERIES SIDE | 2 POSITION CHAIRS

Standard Features:

- Frame: 1" Thick Solid Red Oak | Chamfer Edges
- Hardwood Corner Blocks with 3 Steel Screws
- Chair Back is 7" Wide Curved for Comfort
- Back Leg to Top Seat Rail Joined with Mortise and Tenon and Reinforced with Bolt to Barrel Mechanical Fastening
- AW = All Wood | US = Upholstered Seat | UBS = Upholstered Back & Seat

ModuForm Finishes:

- Standard wood finish is Natural Oak
- Available wood finishes: Light Cherry, Cherry, Stone, Dark Mocha
- *Please add listed stain upcharge for Light Cherry, Cherry, Stone or Dark Mocha
- Option: For custom wood finish, please add \$600 NET plus listed stain upcharge



LS701AW



LS701UBS



LS716AW



LS716UBS

MODEL	DESCRIPTION	SEAT	BACK	DIMENSION	AH	AW	SH	SW	SD	WT	YDS	STAIN
LS701AW	Side Chair	Wood	Wood	20.25"d x 20"w x 31.25"h	-	1"	17.5"	20"	18"	16 lbs	-	+\$52
LS701US	Side Chair	Fabric	Wood	20.25"d x 20"w x 31.25"h	-	1"	17.5"	20"	18"	16 lbs	0.4	+\$52
LS701UBS	Side Chair	Fabric	Fabric	20.25"d x 20"w x 31.25"h	-	1"	17.5"	20"	18"	16 lbs	0.75	+\$52
LS716AW	2 Position Chair	Wood	Wood	29.5"d x 20"w x 31.25"h	-	1"	17.5"	20"	18"	21 lbs	-	+\$52
LS716US	2 Position Chair	Fabric	Wood	29.5"d x 20"w x 31.25"h	-	1"	17.25"	20"	18"	21 lbs	0.4	+\$52
LS716UBS	2 Position Chair	Fabric	Fabric	29.5"d x 20"w x 31.25"h	-	1"	17.25"	20"	18"	21 lbs	0.75	+\$52

MODEL	WOOD	COM	A	B	C	D	E	F	G	H	I	J	K	L	M	N	CAL133	MB
LS701AW	\$786	-	-	-	-	-	-	-	-	-	-	-	-	-	-	-	-	-
LS701US	-	\$748	\$756	\$763	\$772	\$779	\$786	\$795	\$806	\$840	\$834	\$848	\$862	\$878	\$893	\$908	+\$90/yd	+\$31/yd
LS701UBS	-	\$914	\$909	\$922	\$939	\$952	\$965	\$982	\$1,003	\$1,029	\$1,054	\$1,080	\$1,105	\$1,131	\$1,158	\$1,185	+\$90/yd	+\$31/yd

LS716AW	\$862	-	-	-	-	-	-	-	-	-	-	-	-	-	-	-	-	-
LS716US	-	\$838	\$830	\$837	\$846	\$853	\$860	\$869	\$881	\$894	\$908	\$922	\$935	\$949	\$963	\$976	+\$90/yd	+\$31/yd
LS716UBS	-	\$924	\$928	\$941	\$958	\$971	\$983	\$1,000	\$1,022	\$1,047	\$1,073	\$1,098	\$1,125	\$1,150	\$1,176	\$1,201	+\$90/yd	+\$31/yd

MISSION

Standard Features:

Solid Red Oak | Saddle Seat | Hardwood corner blocks

ModuForm Finishes:

Available in Natural, Light Cherry, Cherry, Mission, Stone or Dark Mocha Standard

Option: For custom wood finish, please add \$600 NET plus listed stain upcharge



MS283



MS284

MODEL	DESCRIPTION	SEAT	BACK	DIMENSION	AH	AW	SH	SW	SD	WT	YDS
MS283	Side Chair	Wood	Wood	22.25"d x 18.5"w x 42.5"h	-	-	17.5"	18.5"	17"	19 lbs	-
MS283US	Side Chair	Fabric	Wood	22.25"d x 18.5"w x 42.5"h	-	-	17.5"	18.5"	17"	19 lbs	0.33
MS284	Arm Chair	Wood	Wood	22.25"d x 25.5"w x 42.5"h	24.75"	3"	17.5"	18.5"	17"	22 lbs	-
MS284US	Arm Chair	Fabric	Wood	22.25"d x 25.5"w x 42.5"h	24.75"	3"	17.5"	18.5"	17"	22 lbs	0.33

MODEL	WOOD	COM	A	B	C	D	E	F	G	H	I	J	K	L	M	N	CAL133	MB
MS283	\$874	-	-	-	-	-	-	-	-	-	-	-	-	-	-	-	-	-
MS283US	-	\$838	\$843	\$849	\$855	\$860	\$866	\$873	\$882	\$893	\$908	\$919	\$931	\$942	\$954	\$964	+\$90/yd	+\$31/yd
MS284	\$1,063	-	-	-	-	-	-	-	-	-	-	-	-	-	-	-	-	-
MS284US	-	\$1,034	\$1,036	\$1,041	\$1,048	\$1,054	\$1,058	\$1,066	\$1,074	\$1,086	\$1,101	\$1,112	\$1,123	\$1,135	\$1,146	\$1,158	+\$90/yd	+\$31/yd

STATEMENT OF LINE - WOOD TABLES



MB



MISSION



ELEVEN



1150



1160



HDT



TRESTLE

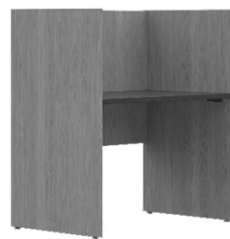

ACTON

Table Tops

Standard laminate and Edges:

Top	Manufacturer	Model	Name	3MM Edge	T-Mold Edge	HD Bumper Edge
Natural Oak	Formica	7152-58	Northern Oak	Natural Oak	Natural Oak	Black
Light Cherry on Oak	Formica	6208-58	Glamour Cherry	Oiled Cherry	Wild Cherry	Black
Cherry on Oak	Formica	7759-58	Select Cherry	Selet Cherry	Black	Black
Stone on Oak	Formica	6413-58	Silver Riftwood	Silver Riftwood	Black	Black
Dark Mocha on Oak	Formica	8848-58	Blackened Legno	Blackened Legno	Black	Black
Walnut	Formica	6402-42	Thermo Walnut	Thermo Walnut	Black	Black
Natural Maple	Formica	86992-58	Hard Rock Maple	Hard Rock Maple	Hard Rock Maple	Black
Light Cherry on Maple	Formica	5904-43	Wild Cherry	Wild Cherry	Wild Cherry	Black
Cherry on Maple	Formica	7759-58	Select Cherry	Selet Cherry	Black	Black
Stone on Maple	Formica	6413-58	Silver Riftwood	Silver Riftwood	Black	Black
Dark Mocha on Maple	Formica	8848-58	Blackened Legno	Blackened Legno	Black	Black
Walnut	Formica	6402-42	Thermo Walnut	Thermo Walnut	Black	Black
White - Writable	Formica	949-90	Gloss White	White	White	Black
Black	Formica	909-58	Matte Black	Black	Black	Black

Standard laminates are available on all tops. 700 and 800 series offer solid oak butcher block options. Edge band is determined by top shape

Series	Name	Model	Edge
ACT	Acton	All	3MM
1150	1150	All	3MM
1160	1160	Square	3MM
EL	Eleven	Square	3MM
EL	Eleven	Round	T-Mold
750	Trestle	All	3MM
MIST	Mission	All	3MM
MB	ModuBlock	All	HD Bumper
HDT	Heavy Duty Tables	All	HD Bumper

ACTON TABLES

Standard Features:

All Tops: 1-1/8" HPL with Matching Thermoplastic Edge

End & Lamp Tables:

End Panels: 3/4" HPL with Matching Thermoplastic Edge
 Legs: 2" x 2" x 4" Steel with Adjustable Glide
 Interior Laminate Standard Black
 Ships Assembled

Activity/Dining Tables

End Panels Activity/Dining Tables: 1-1/8" HPL with Matching Thermoplastic Edge
 Modesty Panel (Activity/Dining): Black HPL with Matching Thermoplastic Edge
 Glides: Nickel Plated, Adjustable
 Tables Ship Knocked Down Ready for Assembly On-Site | TV Stand Requires Legs Attached

ModuForm Finishes:

Standard Laminates:
 Light Cherry, Cherry, Stone, Dark Mocha, Walnut, Black, White Writable

*Please add \$100 List for Multiple Laminates
 When Multiple Laminates are Used, Edge Will Match Outside Face



MODEL	DESCRIPTION	TOP	EDGE STYLE	CORNER	DIMENSION	WT	LIST
ACT01	End Table	Laminate	Square	Square	24"d x 24"w x 15"h	-	\$860
ACT01L	Lamp Table	Laminate	Square	Square	24"d x 24"w x 20"h	-	\$892
ACT04	Coffee Table	Laminate	Square	Square	48"d x 24"w x 15"h	-	\$984
ACT04L	Coffee Table	Laminate	Square	Square	48"d x 24"w x 20"h	-	\$1,048
ACT05	Activity/Dining	Laminate	Square	Square	60"d x 30"w x 30"h	-	\$1,073
ACT05C	Activity/Dining	Laminate	Square	Square	60"d x 30"w x 36"h	-	\$1,137
ACT07	Activity/Dining	Laminate	Square	Square	60"d x 36"w x 30"h	-	\$1,219
ACT07C	Activity/Dining	Laminate	Square	Square	60"d x 36"w x 36"h	-	\$1,339
ACT08	Activity/Dining	Laminate	Square	Square	72"d x 36"w x 30"h	-	\$1,469
ACT08C	Activity/Dining	Laminate	Square	Square	72"d x 36"w x 36"h	-	\$1,614
ACTL10TV48	Media Stand	Laminate	Square	Square	20"d x 48"w x 20"h	-	\$1,408

ACTON CARRELS

Standard Features:

All Tops: 1-1/8" HPL with Matching Thermoplastic Edge
 End Panels: 1-1/8" HPL with Matching Thermoplastic Edge
 Modesty Panel: 3/4" HPL with Matching Thermoplastic Edge
 Glides: Nickel Plated, Adjustable
 On-Site Assembly Required

ModuForm Finishes:

Standard Laminates:
 Light Cherry, Cherry, Stone, Dark Mocha, Walnut, Black, White Writable

*Please add \$100 List for Multiple Laminates
 When Multiple Laminates are Used, Edge Will Match Outside Face



ACTCSS



ACTCSA

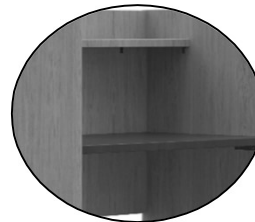

V



ACTCDS

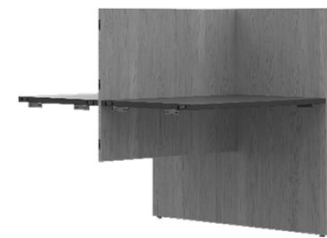

ACTCDA

MODEL	DESCRIPTION	TOP	EDGE STYLE	CORNER	DIMENSION	WT	LIST
ACTCSS	Carrel - Single Face	Laminate	Square	Square	24"d x 38"w x 48.5"h	-	\$1,070
ACTCSA	Adder Carrel - Single Face	Laminate	Square	Square	24"d x 37"w x 48.5"h	-	\$814
ACTCDS	Carrel - Double Face	Laminate	Square	Square	48"d x 38"w x 48.5"h	-	\$1,539
ACTCDA	Adder Carrel - Double Face	Laminate	Square	Square	48"d x 37"w x 48.5"h	-	\$1,160

OPTIONS	DESCRIPTION	LIST
V	Shelf - each	+\$104

1150 | 1160 WOOD

Standard Features:

Tops: 3/4" HPL with Matching Thermoplastic Edge
 Apron: 3/4" Solid Red Oak
 Legs: Solid Red Oak with Kerf Bracket and Bolt
 1150: Square Leg | 1160: Taper Leg
 Metal to Metal Construction
 Legs To Be Attached On-Site

ModuForm Finishes:

Standard wood finish is Natural Oak
 Available wood finishes: Light Cherry, Cherry, Stone, Dark Mocha, Walnut
 *Please add listed stain upcharge for available wood finishes

Option: For custom wood finish, please add \$600 NET plus listed stain upcharge



MODEL	DESCRIPTION	TOP	EDGE STYLE	CORNER	DIMENSION	WT	LIST	*STAIN
1150-01	End Table	Laminate	Square	Square	24"d x 24"w x 15"h	29 lbs	\$834	+\$87
1150-01L	Lamp Table	Laminate	Square	Square	24"d x 24"w x 20"h	29 lbs	\$871	+\$87
1150-04	Coffee Table	Laminate	Square	Square	48"d x 24"w x 15"h	46 lbs	\$1,030	+\$87
1150-06	Activity/Dining	Laminate	Square	Square	36"d x 36"w x 30"h	65 lbs	\$1,282	+\$87
1150-05	Activity/Dining	Laminate	Square	Square	60"d x 30"w x 30"h	75 lbs	\$1,658	+\$87
1150-07	Activity/Dining	Laminate	Square	Square	60"d x 36"w x 30"h	85 lbs	\$1,772	+\$87



MODEL	DESCRIPTION	TOP	EDGE STYLE	CORNER	DIMENSION	WT	LIST	*STAIN
1160-01	End Table	Laminate	Square	Square	24"d x 24"w x 15"h	29 lbs	\$859	+\$87
1160-01L	Lamp Table	Laminate	Square	Square	24"d x 24"w x 20"h	29 lbs	\$919	+\$87
1160-04	Coffee Table	Laminate	Square	Square	48"d x 24"w x 15"h	46 lbs	\$1,060	+\$87
1160-06	Activity/Dining	Laminate	Square	Square	36"d x 36"w x 30"h	65 lbs	\$1,509	+\$87
1160-05	Activity/Dining	Laminate	Square	Square	60"d x 30"w x 30"h	75 lbs	\$1,747	+\$87
1160-07	Activity/Dining	Laminate	Square	Square	60"d x 36"w x 30"h	85 lbs	\$1,795	+\$87

ELEVEN WOOD

Standard Features:

Tops: 1-1/8" Thick High Pressure Laminate with Matching Thermoplastic Edge
 Aprons and Legs: Solid Red Oak with Bullnose edges
 End Frame Assembly: Glued and Doweled Reinforced with Metal to Metal Connectors
 Unit Ships Knocked Down. Leg Assemblies, Rails and Brackets to be Assembled On-Site

Option: for factory assembly add \$220 List

ModuForm Finishes:

Standard wood finish is Natural Oak
 Available wood finishes: Light Cherry, Cherry, Stone, Dark Mocha, Walnut
 *Please add listed stain upcharge for available wood finishes

Option: For custom wood finish, please add \$600 NET plus listed stain upcharge



MODEL	DESCRIPTION	TOP	EDGE STYLE	CORNER	DIMENSION	WT	LIST*	*STAIN
EL01	End Table	Laminate	Square	Square	24"d x 24"w x 15"h	29 lbs	\$1,182	+\$87
EL01L	Lamp Table	Laminate	Square	Square	24"d x 24"w x 20"h	31 lbs	\$1,368	+\$87
EL04	Coffee Table	Laminate	Square	Square	48"d x 24"w x 15"h	46 lbs	\$1,462	+\$87
EL06	Everywhere Table	Laminate	Square	Square	36"d x 36"w x 30"h	70 lbs	\$1,752	+\$87
EL05	Everywhere Table	Laminate	Square	Square	60"d x 30"w x 30"h	81 lbs	\$1,869	+\$87
EL07	Everywhere Table	Laminate	Square	Square	60"d x 36"w x 30"h	74 lbs	\$1,981	+\$87
EL08	Everywhere Table	Laminate	Square	Square	72"d x 36"w x 30"h	81 lbs	\$2,273	+\$87
EL22	Everywhere Table	Laminate	Square	Square	42"dia x 30"h	64 lbs	\$1,903	+\$87

TRESTLE

Standard Features:

Tops: 1-1/8" Thick High Pressure Laminate with Matching Thermoplastic Edge
 Bases: Solid Red Oak Reinforced with Metal to Metal Connectors
 Metal to Metal Through Bolt Construction
 Tables Ship Knocked Down Ready for Assembly On-Site

Option: for factory assembly add \$220 List

ModuForm Finishes:

Standard wood finish is Natural Oak
 Available wood finishes: Light Cherry, Cherry, Stone, Dark Mocha, Walnut
 *Please add listed stain upcharge for available wood finishes

Option: For custom wood finish, please add \$600 NET plus listed stain upcharge



750-3660-SNG



750-3690-DBL

MODEL	DESCRIPTION	TOP	EDGE STYLE	CORNER	DIMENSION	WT	LIST	*STAIN
750-3060-SNG	Everywhere Table	Laminate	Square	Square	60"d x 30"w x 30"h	94 lbs	\$2,796	+\$87
750-3660-SNG	Everywhere Table	Laminate	Square	Square	60"d x 36"w x 30"h	108 lbs	\$2,919	+\$87
750-3072-SNG	Everywhere Table	Laminate	Square	Square	72"d x 30"w x 30"h	109 lbs	\$2,795	+\$87
750-3672-SNG	Everywhere Table	Laminate	Square	Square	72"d x 36"w x 30"h	127 lbs	\$2,990	+\$87
750-3690-DBL	Everywhere Table	Laminate	Square	Square	90"d x 36"w x 30"h	140 lbs	\$4,278	+\$87

MISSION | MIST

Standard Features:

Tops: 3/4" Thick High Pressure Laminate with Thermoplastic Edge
 Aprons and Legs: Solid Red Oak with Chamfers | Finished to Match
 Unit Ships Assembled

ModuForm Finishes:

Available in Light Cherry, Cherry, Mission, Stone Dark Mocha or Walnut Standard

Option: For custom wood finish, please add \$600 NET plus listed stain upcharge



MIST01L



MIST04

MODEL	DESCRIPTION	TOP	EDGE STYLE	CORNER	DIMENSION	WT	LIST
MIST01L	Lamp Table	Laminate	Square	Square	24"d x 24"w x 20"h	26 lbs	\$1,469
MIST04	Coffee Table	Laminate	Square	Square	48"d x 24"w x 16"h	51 lbs	\$1,547

MODUBLOCK | OCCASIONAL

Standard Features:



- Tops: 1-1/8" HPL with Heavy Duty Bumper Edge
- Base: 1-9/16" Thick Solid Red Oak Butcher Block with Bullnose Edge
- Metal to Metal Construction | Tamper Resistant Hardware
- Hardware Includes Epoxy Treated Precoat Patch for Security
- Tables Ship Knocked Down Ready for Assembly On-Site

ModuForm Finishes:

- Standard wood finish is Natural Oak
- Available wood finishes: Light Cherry, Cherry, Stone, Dark Mocha, Walnut
- *Please add listed stain upcharge for available wood finishes

Option: For custom wood finish, please add \$600 NET plus listed stain upcharge

Option: for factory assembly add \$220 List

	MODEL	DESCRIPTION	TOP	EDGE STYLE	CORNER	DIMENSION	WT	LIST	*STAIN
	MB01	End Table	Laminate	Bullnose	Rounded	24"d x 24"w x 16"h	45 lbs	\$1,374	+\$87
	MB04	Coffee Table	Laminate	Bullnose	Rounded	36"d x 24"w x 16"h	55 lbs	\$1,480	+\$87

HEAVY DUTY TABLES for BEHAVIORAL HEALTH

Standard Features:

- Tops: 1-1/8" HPL with Heavy Duty Bumper Edge
- Pedestal Bases: 3" X 3" Solid Red Oak
- Legs Bases: 1-9/16" Thick Solid Red Oak 4-Way
- All: Metal To Metal Bolt Through Construction | Tamper Resistant Square Drive**
- Tables Ship Knocked Down Ready for Assembly On-Site

Option: For Factory Assembly Add \$220 List

**Option: for Tamper Proof Hardware Please Add \$95 List

ModuForm Finishes:

- Standard wood finish is Natural Oak
- Available wood finishes: Light Cherry, Cherry, Stone, Dark Mocha, Walnut
- ***Please add listed stain upcharge for available wood finishes

Option: For custom wood finish, please add \$600 NET plus listed stain upcharge
Butcher Block table tops available upon request, call for availability and pricing
(minimum quantities may apply)

*Heavy duty bumper edge available in black.



HDT22-M-HPL
HDT22-32-M-HPL



HDT06-M-HPL
HDT06-32-M-HPL
HDT06-M-GHPL
HDT06-32-M-GHPL
HDT42S-M-HPL
HDT42S-32-M-HPL



HDT08-M-HPL
HDT08-32-M-HPL

MODEL	DESCRIPTION	TOP	EDGE STYLE	CORNER	DIMENSION	WT	LIST	*STAIN
HDT22-M-HPL	Everywhere Table	Laminate	Bullnose	-	42"dia x 30"h	76 lbs	\$1,949	+\$87
HDT22-32-M-HPL	Everywhere Table	Laminate	Bullnose	-	42"dia x 32"h	77 lbs	\$2,029	+\$87
HDT06-M-HPL	Everywhere Table	Laminate	Bullnose	Rounded	36"d x 36"w x 30"h	72 lbs	\$1,887	+\$87
HDT06-32-M-HPL	Everywhere Table ADA	Laminate	Bullnose	Rounded	36"d x 36"w x 32"h	73 lbs	\$1,959	+\$87
HDT06-M-GHPL	Everywhere Table	Game Laminate	Bullnose	Rounded	36"d x 36"w x 30"h	72 lbs	\$2,342	+\$87
HDT06-32-M-GHPL	Everywhere Table ADA	Game Laminate	Bullnose	Rounded	36"d x 36"w x 32"h	73 lbs	\$2,506	+\$87
HDT42S-M-HPL	Everywhere Table	Laminate	Bullnose	Rounded	42"d x 42"w x 30"h	86 lbs	\$1,968	+\$87
HDT42S-32-M-HPL	Everywhere Table ADA	Laminate	Bullnose	Rounded	42"d x 42"w x 32"h	87 lbs	\$2,050	+\$87
HDT08-M-HPL	Everywhere Table	Laminate	Bullnose	Rounded	72"d x 36"w x 30"h	129 lbs	\$2,918	+\$87
HDT08-32-M-HPL	Everywhere Table ADA	Laminate	Bullnose	Rounded	72"d x 36"w x 32"h	132 lbs	\$2,957	+\$87

STATEMENT OF LINE - METAL | MOLDED TABLES



ModuMaxx Table
Steel 4" Diameter Legs
Plain or Game HPL Available



ModuMaxx X-Base
Rotatorially Molded High-Impact & Sealed Base
Plain or Game HPL Available



ModuMaxx 4 Seat
Steel 3" Diameter Legs
Plain or Game HPL Available



ModuMaxx 6 Seat
Steel 3" Diameter Legs



ModuMaxx 8 Seat
Steel 3" Diameter Legs

Table Tops

Standard laminate and Edge:

Top	Manufacturer	Model	Name	HD Bumper Edge	Resin Edge
Standard*	Pionite	AW785	White Spektrum	Black	Black
Game	Pionite	AG785	White Spektrum Game	Black	Black
Natural Oak	Formica	7152-58	Northern Oak	Black	Black
Light Cherry	Formica	6208-58	Glamour Cherry	Black	Black
Cherry	Formica	9241-43	Select Cherry	Black	Black
Stone	Formica	6413-58	Silver Riftwood	Black	Black
Dark Mocha	Formica	8848-58	Blackened Legno	Black	Black
Walnut	Formica	6402-42	Thermo Walnut	Black	Black
Natural Maple	Formica	86992-58	Hard Rock Maple	Black	Black
Light Cherry on Maple	Formica	5904-43	Wild Cherry	Black	Black
Cherry on Maple	Formica	9241-43	Select Cherry	Black	Black
Stone on Maple	Formica	6413-58	Silver Riftwood	Black	Black
Dark Mocha on Maple	Formica	8848-58	Blackened Legno	Black	Black
Walnut	Formica	6402-42	Thermo Walnut	Black	Black
White - writable	Formica	949-90	Gloss White	Black	Black
Black	Formica	909-58	Matte Black	Black	Black

Standard laminates are available on all tops.

Series	Name	Model	Edge
5000	ModuMaxx	All	HD Bumper Resin

*ModuMaxx table tops come standard with AW785 White Spektrum with black, heavy duty bumper edge

MODUMAXX | MOLDED X BASE

Standard Features:

Top is White Spektrum Laminate | Embedded Inserts for Metal-to-Metal Connections
 Base is Seamless | One-Piece High Impact Polyethylene | Rotationally Molding | Black
 Assembled with Metal to Metal Connections | Tamper Resistant
 Table Base and Top Ship Ready for Assembly

Option: for factory assembly add \$100 list



5005-42R-M-HPL



5005-42R-M-GHPL



5005-36S-M-HPL



5005-42S-M-HPL



5005-36S-M-GHPL

MODEL	DESCRIPTION	TOP	EDGE STYLE	CORNER	DIMENSION	WT	LIST
5005-42R-M-HPL	X Base Table	Laminate	Bullnose/Bumper	-	42"dia x 29.5"h	84 lbs	\$1,541
5005-42R-M-GHPL	X Base Table	Game Laminate	Bullnose/Bumper	-	42"dia x 29.5"h	84 lbs	\$1,778
5005-42R-R-HPL	X Base Table	Laminate	Bullnose/Resin	-	42"dia x 29.5"h	84 lbs	\$1,842
5005-42R-R-GHPL	X Base Table	Game Laminate	Bullnose/Resin	-	42"dia x 29.5"h	84 lbs	\$2,236
5005-36S-M-HPL	X Base Table	Laminate	Bullnose/Bumper	Rounded	36"d x 36"w x 29.5"h	80 lbs	\$1,395
5005-36S-M-GHPL	X Base Table	Game Laminate	Bullnose/Bumper	Rounded	36"d x 36"w x 29.5"h	80 lbs	\$1,842
5005-36S-R-HPL	X Base Table	Laminate	Bullnose/Resin	Rounded	36"d x 36"w x 29.5"h	80 lbs	\$1,791
5005-36S-R-GHPL	X Base Table	Game Laminate	Bullnose/Resin	Rounded	36"d x 36"w x 29.5"h	80 lbs	\$2,228
5005-42S-M-HPL	X Base Table	Laminate	Bullnose/Bumper	Rounded	42"d x 42"w x 29.5"h	94 lbs	\$1,459
5005-42S-M-GHPL	X Base Table	Game Laminate	Bullnose/Bumper	Rounded	42"d x 42"w x 29.5"h	94 lbs	\$1,897
5005-42S-R-HPL	X Base Table	Laminate	Bullnose/Resin	Rounded	42"d x 42"w x 29.5"h	94 lbs	\$1,910
5005-42S-R-GHPL	X Base Table	Game Laminate	Bullnose/Resin	Rounded	42"d x 42"w x 29.5"h	94 lbs	\$2,287

MODUMAXX | 4" STEEL POST

Standard Features:

Top is White Spektrum Laminate | Embedded T-Nuts for Metal-to-Metal Connections
 Legs are 4" Dia Black Epoxy Powder Coated with Tamper Resistant Adjustable Glides
 Tables Ship Knocked Down Ready for Assembly On-Site

Option: for factory assembly add \$200 List



5004-42R-M-HPL-G



5004-42R-M-GHPL-G



5004-48R-M-HPL-G



5004-42S-M-HPL-G



5004-42S-M-GHPL-G

MODEL	DESCRIPTION	TOP	EDGE STYLE	CORNER	DIMENSION	WT	LIST
5004-42R-M-HPL-G	Legs Glides	Laminate	Bullnose/Bumper	-	42"dia x 30"h	92 lbs	\$1,877
5004-42R-M-GHPL-G	Legs Glides	Game Laminate	Bullnose/Bumper	-	42"dia x 30"h	92 lbs	\$2,330
5004-42R-R-HPL-G	Legs Glides	Laminate	Bullnose/Resin	-	42"dia x 30"h	92 lbs	\$2,405
5004-42R-R-GHPL-G	Legs Glides	Game Laminate	Bullnose/Resin	-	42"dia x 30"h	92 lbs	\$2,834
5004-48R-M-HPL-G	Legs Glides	Laminate	Bullnose/Bumper	-	48"dia x 30"h	107 lbs	\$1,895
5004-42S-M-HPL-G	Legs Glides	Laminate	Bullnose/Bumper	Rounded	42"d x 42"w x 30"h	115 lbs	\$2,011
5004-42S-M-GHPL-G	Legs Glides	Game Laminate	Bullnose/Bumper	Rounded	42"d x 42"w x 30"h	115 lbs	\$2,460
5004-42S-R-HPL-G	Legs Glides	Laminate	Bullnose/Resin	Rounded	42"d x 42"w x 30"h	115 lbs	\$2,468
5004-42S-R-GHPL-G	Legs Glides	Game Laminate	Bullnose/Resin	Rounded	42"d x 42"w x 30"h	115 lbs	\$2,899

MODUMAXX | CLUSTER | 4 SEATS

Standard Features:

Top is White Spektrum Laminate | Embedded T-Nuts for Metal-to-Metal Connections
 Legs are 3" Dia Black Epoxy Powder Coated with Tamper Resistant Glides or Fixed to Floor Tabs
 Standard Seat is Grey Melamine
 Tables Ship Knocked Down Ready for Assembly On-Site



Legs | Fixed



Legs | Glides



5003-40C-M-HPL-MGR-G



5003-40C-M-GHPL-MGR-G



5003-42R-M-HPL-MGR-G



5003-42R-M-GHPL-MGR-G

MODEL	DESCRIPTION	TOP	EDGE STYLE	CORNER	DIMENSION	WT	LIST
FOOTPRINT: 71"d x 71"w x 32"h							
5003-40C-M-HPL-MGR-F	Legs Fixed	Laminate	Bullnose	Rounded	40"oct x 32"h	135 lbs	\$2,991
5003-40C-M-HPL-MGR-G	Legs Glides	Laminate	Bullnose	Rounded	40"oct x 32"h	135 lbs	\$2,844
5003-40C-M-GHPL-MGR-F	Legs Fixed	Game Laminate	Bullnose	Rounded	40"oct x 32"h	135 lbs	\$3,475
5003-40C-M-GHPL-MGR-G	Legs Glides	Game Laminate	Bullnose	Rounded	40"oct x 32"h	135 lbs	\$3,324
5003-40C-R-HPL-MGR-F	Legs Fixed	Laminate	Bullnose/Resin	Rounded	40"oct x 32"h	135 lbs	\$3,397
5003-40C-R-HPL-MGR-G	Legs Glides	Laminate	Bullnose/Resin	Rounded	40"oct x 32"h	135 lbs	\$3,247
5003-40C-R-GHPL-MGR-F	Legs Fixed	Game Laminate	Bullnose	Rounded	40"oct x 32"h	135 lbs	\$3,864
5003-40C-R-GHPL-MGR-G	Legs Glides	Game Laminate	Bullnose	Rounded	40"oct x 32"h	135 lbs	\$3,711
FOOTPRINT: 71"d x 71"w x 32"h							
5003-42R-M-HPL-MGR-F	Legs Fixed	Laminate	Bullnose	Rounded	42"dia x 32"h	135 lbs	\$2,924
5003-42R-M-HPL-MGR-G	Legs Glides	Laminate	Bullnose	Rounded	42"dia x 32"h	135 lbs	\$2,777
5003-42R-M-GHPL-MGR-F	Legs Fixed	Game Laminate	Bullnose	Rounded	42"dia x 32"h	135 lbs	\$3,395
5003-42R-M-GHPL-MGR-G	Legs Glides	Game Laminate	Bullnose	Rounded	42"dia x 32"h	135 lbs	\$3,245
5003-42R-R-HPL-MGR-F	Legs Fixed	Laminate	Bullnose/Resin	Rounded	42"dia x 32"h	135 lbs	\$3,499
5003-42R-R-HPL-MGR-G	Legs Glides	Laminate	Bullnose/Resin	Rounded	42"dia x 32"h	135 lbs	\$3,348
5003-42R-R-GHPL-MGR-F	Legs Fixed	Game Laminate	Bullnose	Rounded	42"dia x 32"h	135 lbs	\$3,956
5003-42R-R-GHPL-MGR-G	Legs Glides	Game Laminate	Bullnose	Rounded	42"dia x 32"h	135 lbs	\$3,804

MODUMAXX | CLUSTER | 6 SEATS

Standard Features:

Top is White Spektrum Laminate | Embedded T-Nuts for Metal-to-Metal Connections
 Legs are 3" Dia Black Epoxy Powder Coated with Tamper Resistant Glides or Fixed to Floor Tabs
 Standard Seat is Grey Melamine
 Tables Ship Knocked Down Ready for Assembly On-Site



Legs | Fixed



Legs | Glides



5003-66R-M-HPL-MGR-G



5003-72E-M-HPL-MGR-G

MODEL	DESCRIPTION	TOP	EDGE STYLE	CORNER	DIMENSION	WT	LIST
FOOTPRINT: 91"d x 32"h							
5003-66R-M-HPL-MGR-F	Legs Fixed	Laminate	Bullnose	-	60"dia x 32"h	205 lbs	\$4,599
5003-66R-M-HPL-MGR-G	Legs Glides	Laminate	Bullnose	-	60"dia x 32"h	205 lbs	\$4,377
5003-66R-R-HPL-MGR-F	Legs Fixed	Laminate	Bullnose/Resin	-	60"dia x 32"h	205 lbs	\$5,406
5003-66R-R-HPL-MGR-G	Legs Glides	Laminate	Bullnose/Resin	-	60"dia x 32"h	205 lbs	\$5,267
FOOTPRINT: 61"d x 72"w x 32"h							
5003-72E-M-HPL-MGR-F	Legs Fixed	Laminate	Bullnose	Rounded	30"d x 72"w x 32"h	193 lbs	\$4,205
5003-72E-M-HPL-MGR-G	Legs Glides	Laminate	Bullnose	Rounded	30"d x 72"w x 32"h	193 lbs	\$3,984
5003-72E-R-HPL-MGR-F	Legs Fixed	Laminate	Bullnose/Resin	Rounded	30"d x 72"w x 32"h	193 lbs	\$5,069
5003-72E-R-HPL-MGR-G	Legs Glides	Laminate	Bullnose/Resin	Rounded	30"d x 72"w x 32"h	193 lbs	\$4,845

MODUMAXX | CLUSTER | 8 SEATS

Standard Features:

Top is White Spektrum Laminate | Embedded T-Nuts for Metal-to-Metal Connections
 Legs are 3" Dia Black Epoxy Powder Coated with Tamper Resistant Glides or Fixed to Floor Tabs
 Standard Seat is Grey Melamine
 Tables Ship Knocked Down Ready for Assembly On-Site



Legs | Fixed



Legs | Glides



5003-86R-M-HPL-MGR-G



5003-96E-M-HPL-MGR-G

MODEL	DESCRIPTION	TOP	EDGE STYLE	CORNER	DIMENSION	WT	LIST
FOOTPRINT: 91"d x 32"h							
5003-86R-M-HPL-MGR-F	Legs Fixed	Laminate	Bullnose	-	60"dia x 32"h	241 lbs	\$5,767
5003-86R-M-HPL-MGR-G	Legs Glides	Laminate	Bullnose	-	60"dia x 32"h	241 lbs	\$5,474
5003-86R-R-HPL-MGR-F	Legs Fixed	Laminate	Bullnose	-	60"dia x 32"h	241 lbs	\$6,686
5003-86R-R-HPL-MGR-G	Legs Glides	Laminate	Bullnose/Resin	-	60"dia x 32"h	241 lbs	\$6,386
FOOTPRINT: 61"d x 96"w x 32"h							
5003-96E-M-HPL-MGR-F	Legs Fixed	Laminate	Bullnose	Rounded	30"d x 96"w x 32"h	258 lbs	\$5,401
5003-96E-M-HPL-MGR-G	Legs Glides	Laminate	Bullnose	Rounded	30"d x 96"w x 32"h	258 lbs	\$5,108
5003-96E-R-HPL-MGR-F	Legs Fixed	Laminate	Bullnose/Resin	Rounded	30"d x 96"w x 32"h	258 lbs	\$6,304
5003-96E-R-HPL-MGR-G	Legs Glides	Laminate	Bullnose/Resin	Rounded	30"d x 96"w x 32"h	258 lbs	\$6,006

STATEMENT OF LINE - 520 MODUFORM

Rotationally molded vinyl is up to 20X thicker than fabrics.
 Rotationally molded vinyl is seamless and sealed for ease of cleaning, safety and security.
 Vinyl is homogeneous throughout - strong cleaners will not degrade the furniture.
 Vinyl can be cleaned with mild detergents, steam and can be sanitized with bleach-based agents.
 Vinyl is available in two thicknesses - 200mils (Grade 7) or 250mils (Grade 9).
 Foam core is molded under pressure into cavity of cushion and fully bonds to the internal wall of the skin while it solidifies.
 Foam core is high-density, flexible polyurethane & flame retardant.
 520 Rigid base (standard black color) is high-impact and secured.
 Flame retardant and self extinguishing | Passes CAL TB 133.
 Ships fully assembled.



520-20

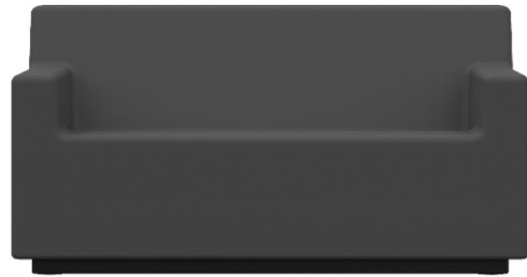

520-10



520-50



520-55



520-60



520-80



520-70

***Standard Rotomolded Vinyl Colors:**

- | | |
|----------------|--------------------|
| 210 Sky | 403 Huckleberry |
| 215 Plum | 426 Slate Blue |
| 220 Leaf | 700 Sandstream |
| 225 Splash | 845 Flannel Grey |
| 230 Canyon | 901 Black |
| 318 Burgundy | |

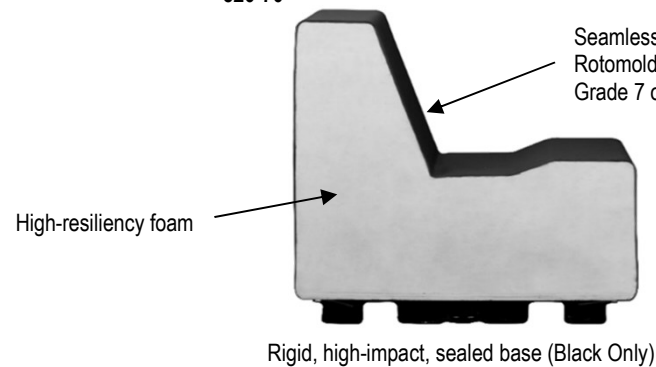

Cross-section of rotationally molded vinyl lounge chair
 Seamless construction, foam filled, impervious to liquids.
 Safe, secure and durable.



STATEMENT OF LINE - 528 MODUFORM

Rotationally molded vinyl is up to 20X thicker than fabrics.
 Rotationally molded vinyl is seamless and sealed for ease of cleaning, safety and security.
 Vinyl is homogeneous throughout - strong cleaners will not degrade the furniture.
 Vinyl can be cleaned with mild detergents, steam and can be sanitized with bleach-based agents.
 Vinyl is available in two thicknesses - 200mils (Grade 7) or 250mils (Grade 9).
 Foam core is molded under pressure into cavity of cushion and fully bonds to the internal wall of the skin while it solidifies.
 Foam core is high-density, flexible polyurethane & flame retardant.
 528 Rigid base (standard polyethylene colors) is high-impact and secured.
 Flame retardant and self extinguishing | Passes CAL TB 133.
 Ships fully assembled.



528-20



528-50



528-52



528-60



528-70

***Standard Rotomolded Vinyl Colors:**

- | | |
|----------------|--------------------|
| 210 Sky | 403 Huckleberry |
| 215 Plum | 426 Slate Blue |
| 220 Leaf | 700 Sandstream |
| 225 Splash | 845 Flannel Grey |
| 230 Canyon | 901 Black |
| 318 Burgundy | |

Seamless vinyl skin - See Standard Rotomolded Vinyl Colors*
 Choose Grade 7 or Grade 9 Thickness

Cross-section of rotationally molded vinyl lounge chair
 Seamless construction, foam filled, impervious to liquids.
 Safe, secure and durable.

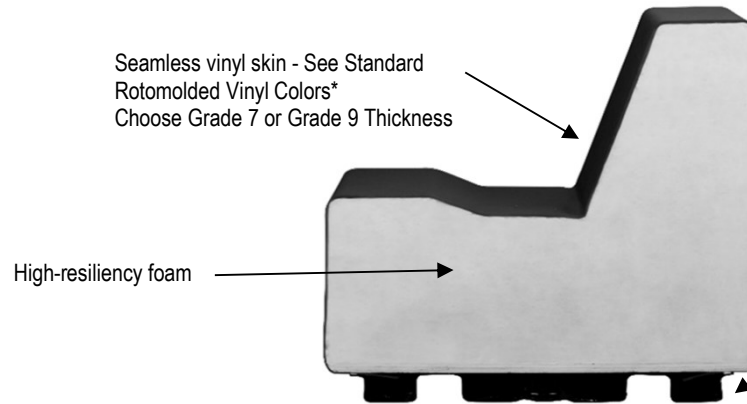

High-resiliency foam

Rigid, high-impact, Polyethylene sealed base

Optional Polyethylene Colors (Base Only):

- | | |
|------------------------------------|--------------|
| 318 Burgundy | 445 Surf |
| 360 Grape | 525 Celtic |
| 426 Slate Blue | 902 Shade |
| Standard Base Color is 901 Black | |

3000 MODUSEAT BEAM SEATING:

Rotationally molded vinyl is up to 20X thicker than fabrics.
 Rotationally molded vinyl is seamless and sealed for ease of cleaning, safety and security.
 Vinyl is homogeneous throughout - strong cleaners will not degrade the furniture.
 Vinyl can be cleaned with mild detergents, steam and can be sanitized with bleach-based agents.
 Foam core is molded under pressure into cavity of cushion and fully bonds to the internal wall of the skin while it solidifies.
 Foam core is high-density, flexible polyurethane & flame retardant.
 Tubular steel frame is concealed in cushion allowing for secure, metal-to-metal connection to beam.
 Steel beam is powder coated black and assembled with steel on steel connectors - tamper resistant.
 A table may be substituted for a seat at any place along the beam for no additional charge | Table will be HPL with thermoplastic edge
 Glides are heavy-duty, adjustable and restricted from removal | Available to be fixed to the floor with steel plates.
 Flame retardant and self extinguishing | Passes CAL TB 133.
 Ships knocked down.



Standard Rotomolded Vinyl Colors:

- | | |
|----------------|--------------------|
| 210 Sky | 403 Huckleberry |
| 215 Plum | 426 Slate Blue |
| 220 Leaf | 700 Sandstream |
| 225 Splash | 845 Flannel Grey |
| 230 Canyon | 901 Black |
| 318 Burgundy | |

Standard Beam Color

Black Powder Coat



3000-2002



3000-2000



3000-2001



3000-2330



3000-2300



3000-2400



3000-2440



3000-2302



3000-2402

WHY US? What is Rotationally Molded Vinyl?

- Skin** Flexible Polyvinyl Chloride covering is rotationally molded for uniform thickness and strength. No frames, no springs, no seams, no exposed edges and no hard surfaces. Choose from two vinyl grades, 200 mils or 250 mils thickness. Leather texture offers a pleasing appearance and greater comfort. Vinyl covering is seamless, impervious to liquids, stain-resistant, and easily cleaned. Pigmented color is homogeneous throughout the covering thickness making it easy to repair and maintain.
- Core** Two part, high-resiliency polyurethane foam offers maximum seating comfort. Pressure molded into one-piece, the foam is dispensed into the interior of the seamless vinyl covering bonding to the vinyl as it cures. Furniture is flame retardant, self-extinguishing and meet State of California Technical Bulletin 133 flammability test requirements.
- Where used** 520 Series ModuForm, 800 Series ModuBlock, 810 Series ModuEsque, 3000 Series ModuSeat Beam
- Springs** None
- Seams** None
- Base** Rigid pedestal base is fully molded and sealed to the underside to prevent intrusion of liquids. 3/16" corner risers implanted in base to avoid fluid entrapment. Base shall be gasketed and/or inset into underside to form a leak-proof seal, which prevents passage of liquids to the core area.
- Chemical Resistance** Chlorine solution, acetone, blood, urine, feces, wine, whiskey, beer, vinegar, salt solution
- Cleaning** Vinyl is easily cleaned with damp cloth and mild detergent. Steam cleaning does not harm the product. Can be sanitized with bleach-based cleaners to aid in the control of infections and blood borne pathogens.



Mold
Platform
Arm

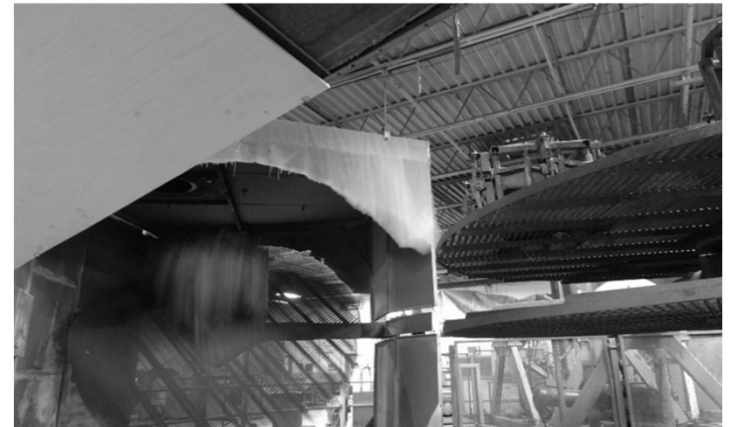

This calculated program creates seamless furniture and cushion "skins" that are uniform in thickness for durability and comfort. Once the skin is removed from its mold, our unique two-part foam material is dispensed into the skin creating a durable, long-lasting and comfortable seating solution.

MODULAR CONFIGURATIONS

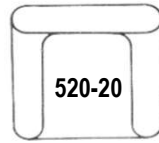
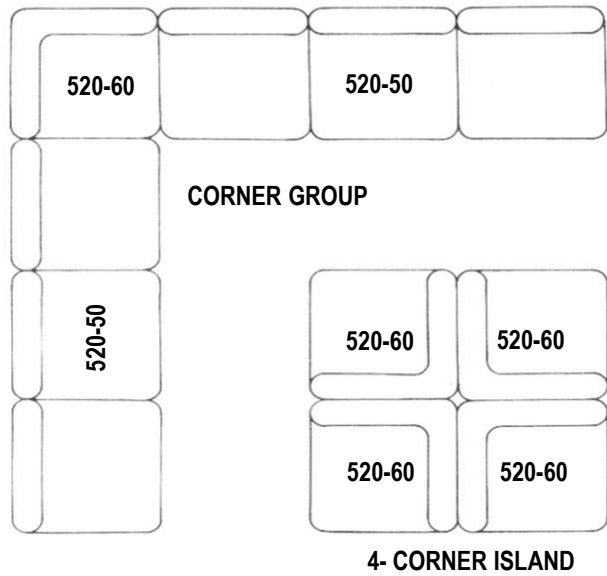

GAME GROUP

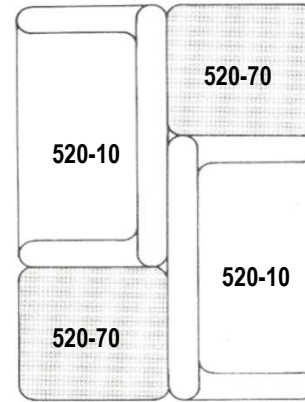
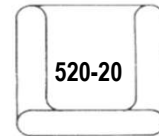

SETTEE ISLAND



BANQUETTE GROUP

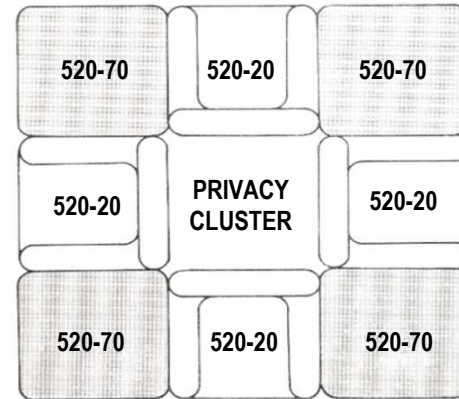
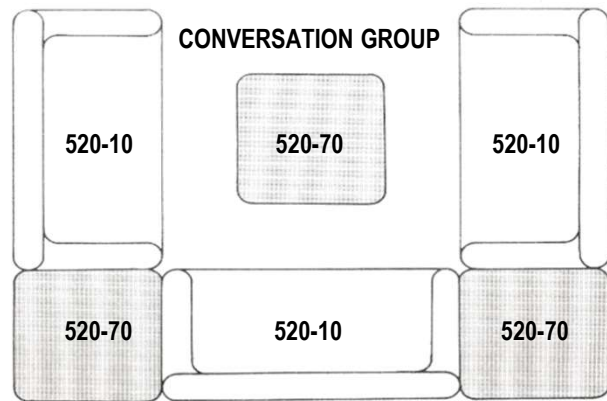

520-50
Armless Chair



520-20
Armchair



520-60
Corner Chair



520-10
Settee



520-80
Bench | Table



520-70
Ottoman

MODUFORM | 520 COLLECTION

For Standard Features, See 520 Statement of Line



Standard Rotomolded Vinyl Colors:

- 210 | Sky
- 215 | Plum
- 220 | Leaf
- 225 | Splash
- 230 | Canyon
- 318 | Burgundy

520 Base Color:

- 901 | Black



520-20



520-10



520-50



520-55



520-60



520-70



520-80

MODEL	COVER	DESCRIPTION	DIMENSION	AH	SH	SD	SW	WEIGHT	LIST	WEIGHT	LIST
									Grade 7		Grade 9
520-10	Flexible PVC	LG Chair	30"d x 54"w x 30"h	22.5"	16"	18"	45"	170 lbs	\$3,703	180 lbs	\$3,820
520-20	Flexible PVC	Chair	30"d x 30"w x 30"h	22.5"	16"	18"	21"	95 lbs	\$2,368	105 lbs	\$2,530
520-50	Flexible PVC	Chair	30"d x 30"w x 30"h	-	16"	18"	30"	90 lbs	\$1,986	100 lbs	\$2,050
520-55	Flexible PVC	Chair Small Scale	26"d x 25"w x 29.5"h	-	16.5"	18"	25"	70 lbs	\$1,783	80 lbs	\$2,006
520-60	Flexible PVC	Corner	30"d x 30"w x 30"h	-	16.5"	25"	18"	115 lbs	\$2,224	120 lbs	\$2,506
520-70	Flexible PVC	End Table Ottoman	30"d x 30"w x 16"h	-	16"	18"	-	80 lbs	\$1,793	90 lbs	\$1,849
520-80	Flexible PVC	Coffee Table Bench	30"d x 54"w x 16"h	-	16"	18"	-	135 lbs	\$2,660	140 lbs	\$2,747

520 MODUFORM OPTIONS - Grade 7 or Grade 9:

OPTION #	DESCRIPTION	LIST
520-H-100	Floor Anchoring Kit (Includes Straps & Hardware)	\$113
520-H-200	Ganging Straps (Includes Straps & Hardware)	\$58

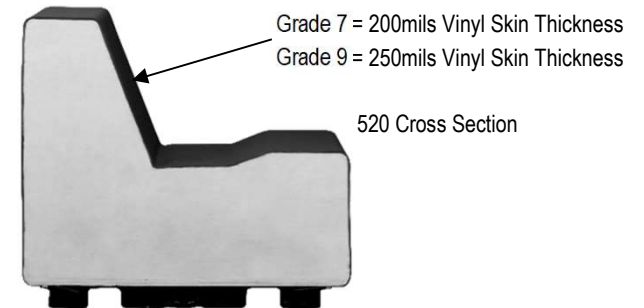

MODUFORM | 528 COLLECTION

For Standard Features, See 528 Statement of Line



Standard Rotomolded Vinyl Colors:

- 210 | Sky
- 215 | Plum
- 220 | Leaf
- 225 | Splash
- 230 | Canyon
- 318 | Burgundy

528 Base Color:

- 901 | Black



528-20



528-50



528-52



528-60



528-70

MODEL	COVER	DESCRIPTION	DIMENSION	AH	SH	SD	SW	WEIGHT	LIST	WEIGHT	LIST
									Grade 7		Grade 9
528-20	Flexible PVC	Armchair	30"d x 30"w x 32"h	22.5"	18"	18"	21"	95 lbs	\$2,477	105 lbs	\$2,645
528-50	Flexible PVC	Chair	30"d x 30"w x 32"h	-	18"	18"	30"	90 lbs	\$2,107	100 lbs	\$2,426
528-52	Flexible PVC	Chair	30"d x 24"w x 32"h	-	18"	24"	18"	74 lbs	\$1,913	80 lbs	\$1,973
528-60	Flexible PVC	Corner	30"d x 30"w x 32"h	-	18"	30"	18"	115 lbs	\$2,287	120 lbs	\$2,359
528-70	Flexible PVC	End Table Ottoman	30"d x 30"w x 18"h	-	18"	18"	-	80 lbs	\$1,851	90 lbs	\$1,909

520 MODUFORM OPTIONS - Grade 7 or Grade 9:

OPTION #	DESCRIPTION	LIST
520-H-100	Floor Anchoring Kit (Includes Straps & Hardware)	\$113
520-H-200	Ganging Straps (Includes Straps & Hardware)	\$58

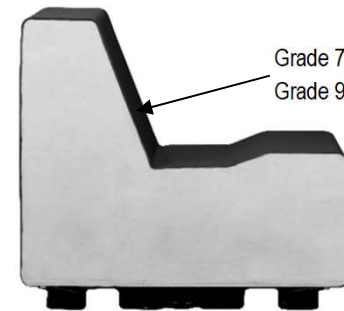



Grade 7 = 200mils Vinyl Skin Thickness
Grade 9 = 250mils Vinyl Skin Thickness

528 Cross Section

MODUSEAT | 3000 BEAM SEATING COLLECTION

For Standard Features, See 3000 ModuSeat Beam Seating Statement of Line

MODEL	COVER	DESCRIPTION	#SEATS	DIMENSION	AH	AW	SH	SD	SW	WEIGHT	LIST
ARMLESS BEAM											
	3000-2002F	Flexible PVC	Beam Fixed	2	22"d x 43.5"w x 31.5"h	-	-	19"	17"	16.75"	86 lbs \$2,247
	3000-2002G	Flexible PVC	Beam Glides	2	22"d x 43.5"w x 31.5"h	-	-	19"	17"	16.75"	86 lbs \$2,083
	3000-2330F	Flexible PVC	Beam Fixed	3	22"d x 64.25"w x 31.5"h	-	-	19"	17"	16.75"	118 lbs \$2,816
	3000-2330G	Flexible PVC	Beam Glides	3	22"d x 64.25"w x 31.5"h	-	-	19"	17"	16.75"	118 lbs \$2,652
	3000-2440F	Flexible PVC	Beam Fixed	4	22"d x 85"w x 31.5"h	-	-	19"	17"	16.75"	150 lbs \$3,698
	3000-2440G	Flexible PVC	Beam Glides	4	22"d x 85"w x 31.5"h	-	-	19"	17"	16.75"	150 lbs \$3,543
BEAM WITH ARMS ON ENDS											
	3000-2000F	Flexible PVC	Beam Fixed	2	22"d x 43.5"w x 31.5"h	25"	3"dia	19"	17"	16.75"	93 lbs \$2,226
	3000-2000G	Flexible PVC	Beam Glides	2	22"d x 43.5"w x 31.5"h	25"	3"dia	19"	17"	16.75"	93 lbs \$2,070
	3000-2300F	Flexible PVC	Beam Fixed	3	22"d x 64.25"w x 31.5"h	25"	3"dia	19"	17"	16.75"	125 lbs \$2,799
	3000-2300G	Flexible PVC	Beam Glides	3	22"d x 64.25"w x 31.5"h	25"	3"dia	19"	17"	16.75"	125 lbs \$2,642
	3000-2302F	Flexible PVC	Beam Fixed	4	22"d x 85"w x 31.5"h	25"	3"dia	19"	17"	16.75"	165 lbs \$3,650
	3000-2302G	Flexible PVC	Beam Glides	4	22"d x 85"w x 31.5"h	25"	3"dia	19"	17"	16.75"	165 lbs \$3,495
BEAM WITH INTERVENING ARMS											
	3000-2001F	Flexible PVC	Beam Fixed	2	22"d x 43.5"w x 31.5"h	25"	3"dia	19"	17"	16.75"	101 lbs \$2,549
	3000-2001G	Flexible PVC	Beam Glides	2	22"d x 43.5"w x 31.5"h	25"	3"dia	19"	17"	16.75"	101 lbs \$2,392
	3000-2400F	Flexible PVC	Beam Fixed	3	22"d x 64.25"w x 31.5"h	25"	3"dia	19"	17"	16.75"	134 lbs \$3,445
	3000-2400G	Flexible PVC	Beam Glides	3	22"d x 64.25"w x 31.5"h	25"	3"dia	19"	17"	16.75"	134 lbs \$3,291
	3000-2402F	Flexible PVC	Beam Fixed	4	22"d x 85"w x 31.5"h	25"	3"dia	19"	17"	16.75"	191 lbs \$4,495
	3000-2402G	Flexible PVC	Beam Glides	4	22"d x 85"w x 31.5"h	25"	3"dia	19"	17"	16.75"	191 lbs \$4,341

Standard Beam Color
Black Powder Coat



Standard ModuSeat Vinyl Colors:

- 210 | Sky
- 215 | Plum
- 220 | Leaf
- 225 | Splash
- 230 | Canyon
- 318 | Burgundy
- 403 | Huckleberry
- 426 | Slate Blue
- 700 | Sandstream
- 845 | Flannel Grey
- 901 | Black

STATEMENT OF LINE - AURA LOUNGE

Flame retardant and self extinguishing | Passes CAL TB 133
 Individual units can be ballasted if additional weight is needed
 No seams, springs, or other components that can break down or become detached
 Rotationally molded linear, low density polyethylene with UV light stabilizers to prevent fading
 Pigmented color is homogeneous throughout rather than just the skin surface
 Chair & Table are one-piece molded and rigid plastic
 Plastic can be cleaned with mild detergents, steam and can be sanitized with bleach-based agents
 Ships fully assembled.



AU101



AU01

- *Standard Polyethylene Colors:**
- | | |
|------------------|--------------|
| 318 Burgundy | 525 Celtic |
| 360 Grape | 901 Black |
| 426 Slate Blue | 902 Shade |
| 445 Surf | |

One-piece construction, no added components

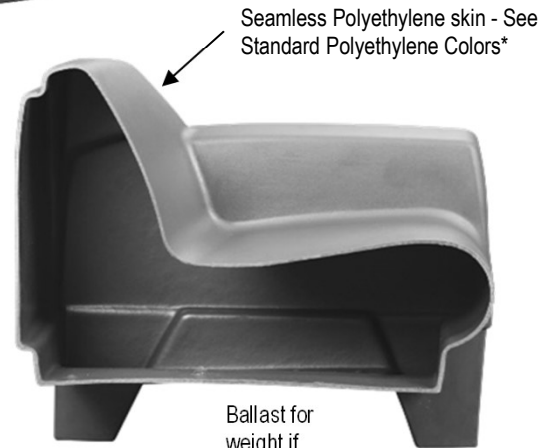

Cross-section of rotationally molded plastic lounge chair

STATEMENT OF LINE - MODUMAXX LOUNGE

Flame retardant and self extinguishing | Passes CAL TB 133
 Individual units can be ballasted if additional weight is needed
 No seams, springs, or other components that can break down or become detached
 Rotationally molded linear, low density polyethylene with UV light stabilizers to prevent fading
 Pigmented color is homogeneous throughout rather than just the skin surface
 Chair is one-piece molded and rigid plastic with embedded inserts for ganging when requested
 Plastic can be cleaned with mild detergents, steam and can be sanitized with bleach-based agents
 Ships fully assembled.



5000-250

***Standard Polyethylene Colors:**

- | | |
|------------------|--------------|
| 318 Burgundy | 525 Celtic |
| 360 Grape | 901 Black |
| 426 Slate Blue | 902 Shade |
| 445 Surf | |

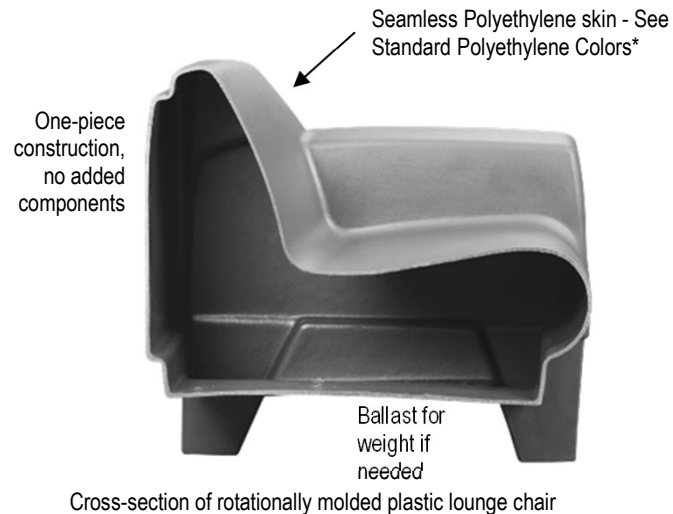

STATEMENT OF LINE - 5000 MODUMAXX

Rotationally molded, linear, low density polyethylene with UV light stabilizers to prevent fading

Pigmented color is homogeneous throughout rather than just the skin surface

Seats are one-piece molded and rigid plastic | Beam is 2" diameter powder coated steel

Plastic can be cleaned with mild detergents, steam and can be sanitized with bleach-based agents

Flame retardant and self extinguishing | Passes CAL TB 133

Tamper resistant bolts are fastened through the beam and secured into inserts that have been molded into the seat | Ships knocked down

A table may be substituted for a seat at any place along the beam for no additional charge | Table will be HPL with thermoplastic edge

Ships knocked down. Assembly on-site.



Standard Polyethylene Colors:

- 318 | Burgundy 525 | Celtic
- 360 | Grape 901 | Black
- 426 | Slate Blue 902 | Shade
- 445 | Surf

Standard Beam Color

Black Powder Coat



5000-2002



5000-2000



5000-2001



5000-2330



5000-2300



5000-2400



5000-2440



5000-2302



5000-2402

WHY US? What is Rotationally Molded Polyethylene?

- Skin** Linear, low density polyethylene is rotationally molded for uniform thickness and strength. No frames, no springs, no seams, no exposed edges. Leather texture offers a pleasing appearance and greater comfort. Plastic shell is seamless, impervious to liquids, stain-resistant, and easily cleaned. Pigmented color is homogeneous throughout the covering thickness making it easy to maintain.
- Core** Modumaxx lounge seating and chairs can be ballasted if needed. Beam seating is connected to frame with bolts and threaded inserts for safety and security.
- Where used** 5000 Series ModuMaxx Multipurpose Chairs, 5000 Series ModuMaxx Lounge Seating, 5000 ModuMaxx Beam Seating, 5000 Series ModuMaxx X Base Table Base, Moxie
- Springs** None
- Seams** None
- Chemical Resistance** Chlorine solution, acetone, blood, urine, feces, wine, whiskey, beer, vinegar, salt solution
- Cleaning** Vinyl is easily cleaned with damp cloth and mild detergent. Steam cleaning does not harm the product. Can be sanitized with bleach-based cleaners to aid in the control of infections and blood borne pathogens.



Mold
Platform
Arm

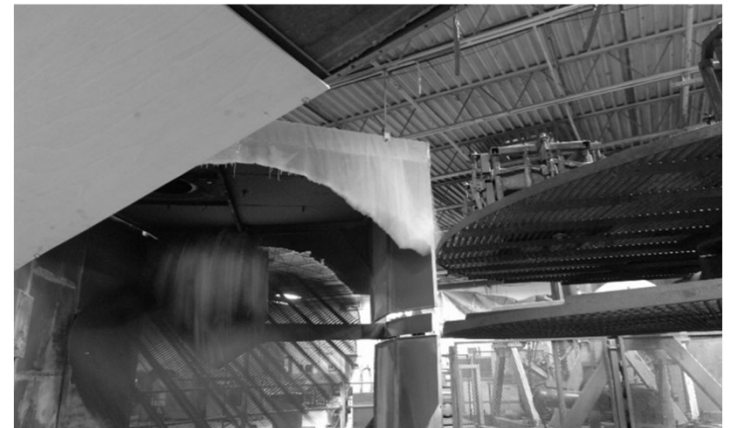

This calculated program creates seamless furniture and cushion "skins" that are uniform in thickness for durability and comfort.

ModuForm's rotational molding process uses molds that are secured to "platforms" that are connected to "arms". Large ovens are utilized to cure a specially formulated pigmented Linear Low Density Polyethylene material that is dispensed into a mold. The "arm" performs a constant rotational & tumbling motion so that the Polyethylene compound evenly coats the mold's inner walls.

AURA | LOUNGE



Standard Features:

- Flame retardant and self extinguishing | Passes CAL TB 133
- Individual units can be ballasted if additional weight is needed
- No seams, springs, or other components that can break down or become detached
- Rotationally molded linear, low density polyethylene with UV light stabilizers to prevent fading
- Pigmented color is homogeneous throughout rather than just the skin surface
- Chair is one-piece molded and rigid plastic with embedded inserts for ganging when requested
- Plastic can be cleaned with mild detergents, steam and can be sanitized with bleach-based agents
- Ships fully assembled.

Standard Aura Colors:

- 318 | Burgundy
- 360 | Grape
- 426 | Slate Blue
- 445 | Surf
- 525 | Celtic
- 901 | Black
- 902 | Shade



AU101



AU01

MODEL	COVER	DESCRIPTION	#SEATS	DIMENSION	AH	AW	SH	SD	SW	WEIGHT	LIST
AU101	Polyethylene	Barrel Chair	1	28"d x 29.5"w x 31.5"h	28"	-	18"	-	-	36 lbs	\$1,185
AU01	Polyethylene	Drum Table	-	28"dia x 18"h	-	-	18"	-	-	23 lbs	\$1,015

NOTE: Heavy-strength, industrial plastic bags should be used to contain ballasting material when adding weight to chairs (not included). Once filled, end should be securely tied off.

AURA LOUNGE OPTIONS:

OPTION #	DESCRIPTION	LIST
BAC	Ballast Access Cover	\$240

MODUMAXX | 5000 LOUNGE



Standard Features:

- Flame retardant and self extinguishing | Passes CAL TB 133
- Individual units can be ballasted if additional weight is needed
- No seams, springs, or other components that can break down or become detached
- Rotationally molded linear, low density polyethylene with UV light stabilizers to prevent fading
- Pigmented color is homogeneous throughout rather than just the skin surface
- Chair is one-piece molded and rigid plastic with embedded inserts for ganging when requested
- Plastic can be cleaned with mild detergents, steam and can be sanitized with bleach-based agents
- Ships fully assembled.

Standard ModuMaxx Lounge Colors:

- 318 | Burgundy
- 360 | Grape
- 426 | Slate Blue
- 445 | Surf
- 525 | Celtic
- 901 | Black
- 902 | Shade



5000-250
5000-251



MODEL	COVER	DESCRIPTION	#SEATS	DIMENSION	AH	AW	SH	SD	SW	WEIGHT	LIST
5000-250	Polyethylene	Chair	1	29.5"d x 29"w x 29"h	23.5"	3"	17.5"	20"	20"	39 lbs	\$933
5000-251	Polyethylene	Chair Tandem Ready	1	29.5"d x 29"w x 29"h	23.5"	3"	17.5"	20"	20"	39 lbs	\$949

NOTE: Heavy-strength, industrial plastic bags should be used to contain ballasting material when adding weight to chairs (not included). Once filled, end should be securely tied off.

5000 MODUMAXX LOUNGE OPTIONS:

OPTION #	DESCRIPTION	LIST
50-H-FIXED	Floor Anchoring Kit	\$182
50-H-251	Ganging Hardware Kit	\$58
BAC	Ballast Access Cover	\$240

STATEMENT OF LINE

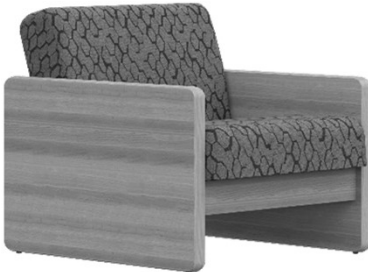

RS | ROUNDER

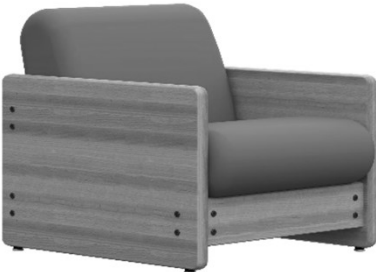

800 | MODUBLOCK



810 | MODUESQUE



MS | MISSION



SF8101 | MARCO



MM | MINI MARCO PUBLIC AREA



ROC01 | OLIVE'S ROCKER

800 | MODUBLOCK | CUSHION GUIDE

-1 = Square Back Cushion



-3 = Fully Rounded Back Cushion



Standard Rotomolded Vinyl Colors for Cushions in Grade 7 or Grade 9

- 210 | Sky
- 215 | Plum
- 220 | Leaf
- 225 | Splash
- 230 | Canyon
- 318 | Burgundy
- 403 | Huckleberry
- 426 | Slate Blue
- 700 | Sandstream
- 845 | Flannel Grey
- 901 | Black

Standard ModuForm Finishes for Butcher Block Components:

Standard Wood Finish: Natural/Light Oak (LO)
 Option: Available Standard Wood Finishes Include:
 Light Cherry (LC), Cherry (CO), Stone (ST), Dark Mocha (DM), Walnut (WL)
 For optional wood finish, please add to list:
 Custom Finish is Available (see one time fee & upcharge per model in pricing pages)

810 | MODUESQUE | CUSHION GUIDE

-1 = Square Back Cushion



-3 = Fully Rounded Back Cushion



Standard Rotomolded Vinyl Colors for Cushions in Grade 7 or Grade 9

- | | |
|----------------|--------------------|
| 210 Sky | 403 Huckleberry |
| 215 Plum | 426 Slate Blue |
| 220 Leaf | 700 Sandstream |
| 225 Splash | 845 Flannel Grey |
| 230 Canyon | 901 Black |
| 318 Burgundy | |

Standard ModuForm Finishes for Butcher Block Components:

Standard Wood Finish: Natural/Light Oak (LO)
 Option: Available Standard Wood Finishes Include:
 Light Cherry (LC), Cherry (CO), Stone (ST), Dark Mocha (DM), Walnut (WL)
 For optional wood finish, please add to list:
 Custom Finish is Available (see one time fee & upcharge per model in pricing pages)

ROUNDER HIGHLIGHTS & OVERVIEW



Frame: 1-9/16" Thick Solid Red Oak Butcher Block Sides
 1.25" Thick Solid Red Oak Butcher Block Seat Rail | 1" Thick Back
 Frame "Carcass" is Assembled with "Wet" Dowel and Glue Construction Reinforced with Toe Boring
 Sealer & Top-Coat: Specially Formulated ModuV
 ModuV is Our Unique Resin Top-Coat that Can be Cleaned Easily with Commercial Detergents and Bleach
 ModuV is the Most Environmentally Friendly Finish Available as it is Applied with Our Unique Roll-Coating Process
 Glides: Adjustable, Heavy Duty Stainless Steel.
 Ships Fully Assembled



PR01CUSH Cross Section

Conventional Cushion Set is Field Replaceable with PR01CUSH
 Flex Cover Offers Replaceable Covers that are Field Replaceable
 Flex Cover Cushion Set Upholstery is Attached via Hook & Loop Fastening - No Tools Required
 Seat Cushion is 6.5" Thick Laminated, Commercial Grade Polyurethane Foam for Comfort & Durability
 Cushions Feature 8-Gauge Sinuous Springs & Tie-Rods
 Cushion Frame is Puzzle Cut and Interlocked for Added Strength

ROUNDER | RS COLLECTION

ModuForm Finishes:

Standard Wood Finish: Natural/Light Oak (LO)

Option: Available Standard Wood Finishes Include (Upcharge in STAIN Column Below):

Light Cherry (LC), Cherry (CO), Stone (ST), Dark Mocha (DM), Walnut (WL)

Option: For custom wood finish, please add \$600 NET plus listed stain upcharge

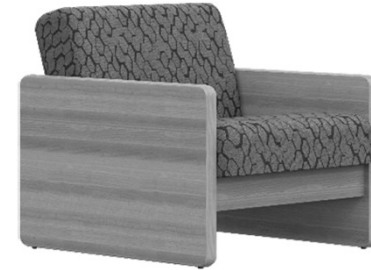

RS01

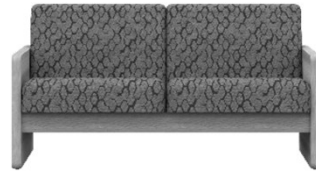

RS02

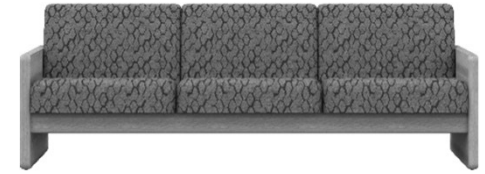

RS03

MODEL	COVER	DESCRIPTION	DIMENSION	AH	AW	SH	SD	SW	FABRIC	YDS	CAL 133	MB	STAIN
RS01	Standard	Chair	33"d x 27"w x 28.5"h	21.5"	1.75"	16"	23.5"	21"	100 lbs	2.00	+\$90/yd	+\$31/yd	+\$251
RS02	Standard	Settee	33"d x 50.5"w x 28.5"h	21.5"	1.75"	16"	23.5"	21"	140 lbs	4.00	+\$90/yd	+\$31/yd	+\$251
RS03	Standard	Sofa	33"d x 74"w x 28.5"h	21.5"	1.75"	16"	23.5"	21"	170 lbs	6.00	+\$90/yd	+\$31/yd	+\$251
RS01V	Flex	Chair	33"d x 27"w x 28.5"h	21.5"	1.75"	16"	23.5"	21"	100 lbs	2.00	+\$90/yd	+\$31/yd	+\$251
RS02V	Flex	Settee	33"d x 50.5"w x 28.5"h	21.5"	1.75"	16"	23.5"	21"	140 lbs	4.00	+\$90/yd	+\$31/yd	+\$251
RS03V	Flex	Sofa	33"d x 74"w x 28.5"h	21.5"	1.75"	16"	23.5"	21"	170 lbs	6.00	+\$90/yd	+\$31/yd	+\$251

MODEL

MODEL	COM	A	B	C	D	E	F	G	H	I	J	K	L	M	N
RS01	\$2,137	\$2,204	\$2,228	\$2,265	\$2,292	\$2,319	\$2,353	\$2,398	\$2,452	\$2,505	\$2,559	\$2,610	\$2,664	\$2,717	\$2,771
RS02	\$2,742	\$2,885	\$2,935	\$3,003	\$3,053	\$3,103	\$3,171	\$3,255	\$3,355	\$3,500	\$3,607	\$3,713	\$3,821	\$3,928	\$4,034
RS03	\$3,594	\$3,816	\$3,891	\$3,992	\$4,068	\$4,143	\$4,244	\$4,418	\$4,578	\$4,809	\$4,979	\$5,148	\$5,317	\$5,487	\$5,657
RS01V	\$2,278	\$2,336	\$2,360	\$2,394	\$2,419	\$2,445	\$2,478	\$2,520	\$2,570	\$2,642	\$2,696	\$2,749	\$2,802	\$2,855	\$2,909
RS02V	\$2,738	\$3,072	\$3,123	\$3,190	\$3,239	\$3,291	\$3,357	\$3,473	\$3,579	\$3,733	\$3,846	\$3,959	\$4,072	\$4,184	\$4,297
RS03V	\$3,847	\$4,065	\$4,141	\$4,242	\$4,317	\$4,393	\$4,535	\$4,668	\$4,828	\$5,059	\$5,229	\$5,397	\$5,567	\$5,737	\$5,906

MODUBLOCK HIGHLIGHTS & OVERVIEW

Frame: 1-9/16" Thick Solid Red Oak Butcher Block Sides and Front Rail. 1" Thick Solid Red Oak Butcher Block Back.
 Frame: Steel Support System & Seat Cushion Frame | Punched & Welded Construction.
 Cushions: Field Replaceable & Bolted to Steel Support System
 Cushion Covers: Available in Either Flex Upholstery or Rotationally Molded Seamless Vinyl.
 Cushion Core: Pressure Molded, High-Density, Flexible Polyurethane | Flame Retardant.
 Assembly: Metal to Metal Through Bolt Construction with Tamper Resistant Hardware.
 Sealer & Top-Coat: Specially Formulated ModuV
 ModuV is Our Unique Resin Top-Coat that Can be Cleaned Easily with Commercial Detergents and Bleach
 ModuV is the Most Environmentally Friendly Finish Available as it is Applied with Our Unique Roll-Coating Process
 Glides: Adjustable, Heavy Duty Stainless Steel.

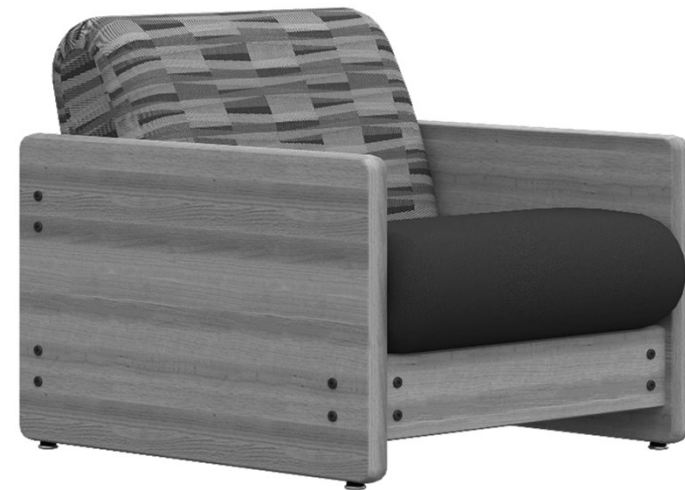

MODUBLOCK WITH SEAMLESS MOLDED CUSHIONS

Up to 20X Thicker Than Upholstery | Homogeneous Pigmented Color
 Grade 7 is 200 mil thick | Grade 9 is 250 mil thick
 Seamless, Easily Cleaned, Safe & Secure
 Use Mild Detergents, Steam or Bleach-Based Agents

MODUBLOCK WITH FABRIC & COATED MATERIALS

Flex Upholstery Covers: Removable in Field and Replaceable.
 Cushions are Fully Reversible
 Follow Cleaning Instructions of Particular Textile

Standard Rotomolded Vinyl Colors for Cushions in Grade 7 or Grade 9

- | | |
|----------------|--------------------|
| 210 Sky | 403 Huckleberry |
| 215 Plum | 426 Slate Blue |
| 220 Leaf | 700 Sandstream |
| 225 Splash | 845 Flannel Grey |
| 230 Canyon | 901 Black |
| 318 Burgundy | |

MODUBLOCK | 800 SERIES - SQUARE BACKS

See cushion guide on F10 for complete description of back cushion options

ModuForm Finishes:

Standard Wood Finish: Natural/Light Oak (LO)

Option: Available Standard Wood Finishes Include (Upcharge in STAIN Column Below):

Light Cherry (LC), Cherry (CO), Stone (ST), Dark Mocha (DM), Walnut (WL)

Option: For custom wood finish, please add \$600 NET plus listed stain upcharge

Option: 18" Seat Height Available | Call for Pricing & Availability (minimums may apply)

Option: Factory Assembly, Add to LIST | Standard Units Ship Knocked-Down Ready for Assembly.

Chair +\$172

Settee +\$258

Sofa +\$344



800-01-1

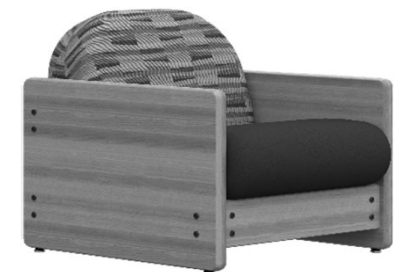

800-01-3

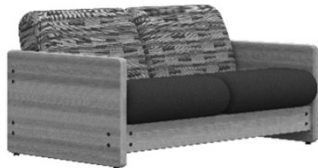

800-02-1



800-02-3

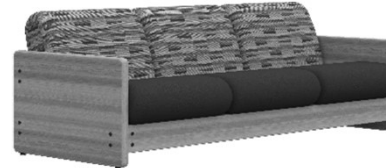

800-03-1

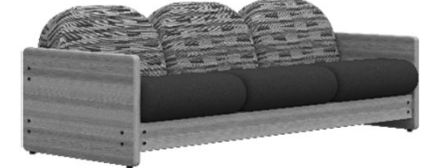

800-03-3

MODEL	COVER	DESCRIPTION	DIMENSION	AH	AW	SH	SD	SW	FABRIC	VINYL	YDS	CAL 133	MB	STAIN
800-01-1	Flex	Chair	34"d x 27.5"w x 32"h	20.5"	1.5"	16"	24"	20"	110 lbs	115 lbs	2.75	+\$136/yd	+\$31/yd	+\$251
800-01-3	Flex	Chair	34"d x 27.5"w x 32"h	20.5"	1.5"	16"	24"	20"	110 lbs	115 lbs	2.75	+\$136/yd	+\$31/yd	+\$251
800-02-1	Flex	Settee	34"d x 53.5"w x 32"h	20.5"	1.5"	16"	24"	20"	175 lbs	185 lbs	5.00	+\$136/yd	+\$31/yd	+\$251
800-02-3	Flex	Settee	34"d x 53.5"w x 32"h	20.5"	1.5"	16"	24"	20"	175 lbs	185 lbs	5.00	+\$136/yd	+\$31/yd	+\$251
800-03-1	Flex	Sofa	34"d x 77"w x 32"h	20.5"	1.5"	16"	24"	20"	185 lbs	245 lbs	7.50	+\$136/yd	+\$31/yd	+\$251
800-03-3	Flex	Sofa	34"d x 77"w x 32"h	20.5"	1.5"	16"	24"	20"	185 lbs	245 lbs	7.50	+\$136/yd	+\$31/yd	+\$251

MODEL	COM	A	B	C	D	E	F	G	H	I	J	K	L	M	N	7	9
800-01-1	\$2,358	\$2,448	\$2,481	\$2,527	\$2,561	\$2,595	\$2,640	\$2,697	\$2,764	\$2,862	\$2,934	\$3,006	\$3,079	\$3,150	\$3,222	\$3,061	\$3,362
800-01-3	\$2,358	\$2,448	\$2,481	\$2,527	\$2,561	\$2,595	\$2,640	\$2,697	\$2,764	\$2,862	\$2,934	\$3,006	\$3,079	\$3,150	\$3,222	\$3,061	\$3,362
800-02-1	\$3,630	\$3,800	\$3,862	\$3,944	\$4,006	\$4,068	\$4,151	\$4,253	\$4,376	\$4,555	\$4,686	\$4,816	\$4,947	\$5,078	\$5,209	\$4,781	\$5,255
800-02-3	\$3,630	\$3,800	\$3,862	\$3,944	\$4,006	\$4,068	\$4,151	\$4,253	\$4,376	\$4,555	\$4,686	\$4,816	\$4,947	\$5,078	\$5,209	\$4,781	\$5,255
800-03-1	\$4,947	\$5,210	\$5,303	\$5,426	\$5,518	\$5,612	\$5,735	\$5,889	\$6,074	\$6,341	\$6,537	\$6,734	\$6,929	\$7,126	\$7,322	\$6,271	\$6,830
800-03-3	\$4,947	\$5,210	\$5,303	\$5,426	\$5,518	\$5,612	\$5,735	\$5,889	\$6,074	\$6,341	\$6,537	\$6,734	\$6,929	\$7,126	\$7,322	\$6,271	\$6,952

MODUESQUE HIGHLIGHTS & OVERVIEW

Frame: 1-9/16" Thick Solid Red Oak Butcher Block Sides and Front Rail. 1" Thick Solid Red Oak Butcher Block Back.
 Frame: Steel Support System & Seat Cushion Frame | Punched & Welded Construction.
 Cushions: Field Replaceable & Bolted to Steel Support System
 Cushion Covers: Available in Either Flex Upholstery or Rotationally Molded Seamless Vinyl.
 Cushion Core: Pressure Molded, High-Density, Flexible Polyurethane | Flame Retardant.
 Assembly: Metal to Metal Through Bolt Construction with Tamper Resistant Hardware.
 Sealer & Top-Coat: Specially Formulated ModuV
 ModuV is Our Unique Resin Top-Coat that Can be Cleaned Easily with Commercial Detergents and Bleach
 ModuV is the Most Environmentally Friendly Finish Available as it is Applied with Our Unique Roll-Coating Process
 Glides: Adjustable, Heavy Duty Stainless Steel.



MODUESQUE WITH SEAMLESS MOLDED CUSHIONS (Grades 7 or 9)

Up to 20X Thicker Than Upholstery | Homogeneous Pigmented Color
 Grade 7 is 200 mil thick | Grade 9 is 250 mil thick
 Seamless, Easily Cleaned, Safe & Secure
 Use Mild Detergents, Steam or Bleach-Based Agents

MODUESQUE WITH FABRIC & COATED MATERIALS (Grades A-N)

Flex Upholstery Covers: Removable in Field and Replaceable.
 Cushions are Fully Reversible
 Follow Cleaning Instructions of Particular Textile

Standard Rotomolded Vinyl Colors for Cushions in Grade 7 or Grade 9

- | | |
|----------------|--------------------|
| 210 Sky | 403 Huckleberry |
| 215 Plum | 426 Slate Blue |
| 220 Leaf | 700 Sandstream |
| 225 Splash | 845 Flannel Grey |
| 230 Canyon | 901 Black |
| 318 Burgundy | |

MODUESQUE | 810 SERIES - SQUARE BACKS

See cushion guide on F10 for complete description of back cushion options

ModuForm Finishes:

Standard Wood Finish: Natural/Light Oak (LO)

Option: Available Standard Wood Finishes Include (Upcharge in STAIN Column Below):

Light Cherry (LC), Cherry (CO), Stone (ST), Dark Mocha (DM), Walnut (WL)

Option: For custom wood finish, please add \$600 NET plus listed stain upcharge

Option: 18" Seat Height Available | Call for Pricing & Availability (minimums may apply)

Option: Factory Assembly, Add to LIST | Standard Units Ship Knocked-Down Ready for Assembly.

- Chair +\$172
- Settee +\$258
- Sofa +\$344



810-02-1



810-02-3

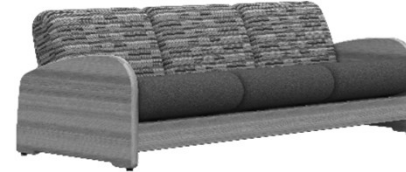

810-03-1

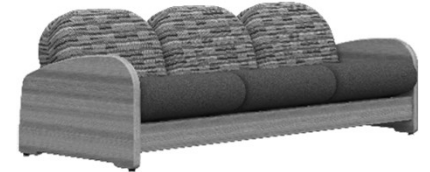

810-03-3

MODEL	COVER	DESCRIPTION	DIMENSION	AH	AW	SH	SD	SW	FABRIC	VINYL	YDS	CAL 133	MB	STAIN
810-01-1	Flex	Chair	34"d x 27.5"w x 32"h	20.5"	1.5"	16"	24"	20"	110 lbs	115 lbs	2.50	+\$136/yd	+\$31/yd	+\$251
810-01-3	Flex	Chair	34"d x 27.5"w x 32"h	20.5"	1.5"	16"	24"	20"	110 lbs	115 lbs	2.50	+\$136/yd	+\$31/yd	+\$251
810-02-1	Flex	Settee	34"d x 53.5"w x 32"h	20.5"	1.5"	16"	24"	20"	175 lbs	185 lbs	5.00	+\$136/yd	+\$31/yd	+\$251
810-02-3	Flex	Settee	34"d x 53.5"w x 32"h	20.5"	1.5"	16"	24"	20"	175 lbs	185 lbs	5.00	+\$136/yd	+\$31/yd	+\$251
810-03-1	Flex	Sofa	34"d x 77"w x 32"h	20.5"	1.5"	16"	24"	20"	245 lbs	260 lbs	7.50	+\$136/yd	+\$31/yd	+\$251
810-03-3	Flex	Sofa	34"d x 77"w x 32"h	20.5"	1.5"	16"	24"	20"	245 lbs	260 lbs	7.50	+\$136/yd	+\$31/yd	+\$251

MODEL	COM	A	B	C	D	E	F	G	H	I	J	K	L	M	N	7	9
810-01-1	\$2,357	\$2,437	\$2,470	\$2,515	\$2,548	\$2,582	\$2,627	\$2,681	\$2,749	\$2,844	\$2,915	\$2,986	\$3,056	\$3,127	\$3,198	\$3,074	\$3,377
810-01-3	\$2,357	\$2,437	\$2,470	\$2,515	\$2,548	\$2,582	\$2,627	\$2,681	\$2,749	\$2,844	\$2,915	\$2,986	\$3,056	\$3,127	\$3,198	\$3,074	\$3,377
810-02-1	\$3,636	\$3,833	\$3,901	\$3,990	\$4,056	\$4,123	\$4,213	\$4,323	\$4,456	\$4,649	\$4,790	\$4,930	\$5,072	\$5,213	\$5,355	\$4,809	\$5,285
810-02-3	\$3,636	\$3,833	\$3,901	\$3,990	\$4,056	\$4,123	\$4,213	\$4,323	\$4,456	\$4,649	\$4,790	\$4,930	\$5,072	\$5,213	\$5,355	\$4,809	\$5,285
810-03-1	\$4,984	\$5,247	\$5,341	\$5,464	\$5,556	\$5,649	\$5,772	\$5,927	\$6,112	\$6,379	\$6,575	\$6,771	\$6,967	\$7,163	\$7,371	\$6,540	\$7,190
810-03-3	\$4,984	\$5,247	\$5,341	\$5,464	\$5,556	\$5,649	\$5,772	\$5,927	\$6,112	\$6,379	\$6,575	\$6,771	\$6,967	\$7,163	\$7,371	\$6,540	\$7,190

MISSION

Standard Features:

- Solid Red Oak Posts, Rails & Stiles
- Frame "Carcass" is Assembled with "Wet" Dowel and Glue Construction Reinforced with Toe Boring
- Conventional Cushion Set is Field Replaceable with PR01CUSH
- Flex Covers are Field Replaceable
- Flex Cover Cushion Set Upholstery is Attached via Hook & Loop Fastening - No Tools Required
- Seat Cushion is 6.5" Thick Laminated, Commercial Grade Polyurethane Foam for Comfort & Durability
- Cushions Feature 8-Gauge Sinuous Springs & Tie-Rods
- Cushion Frame is Puzzle Cut and Interlocked for Added Strength
- Ships Fully Assembled



MIS101
MIS101V

Moduform Finishes:

- Available standard finishes:
- Light Cherry (LC), Cherry (CO), Stone (ST), Dark Mocha (DM), Walnut (WL)

Option: For custom wood finish, please add \$500 NET plus listed stain upcharge

Note: custom wood finish is one-time charge per order



MIS102
MIS102V



MIS103
MIS103V

MODEL	COVER	DESCRIPTION	DIMENSION	AH	AW	SH	SD	SW	FABRIC	YDS	CAL 133	MB	STAIN
MIS101	Standard	Chair	33.5"d x 31.25"w x 29.5"h	22.5"	4"	15.5"	23.5"	21"	61 lbs	2.00	+\$90/yd	+\$31/yd	-
MIS102	Standard	Settee	33.5"d x 54.75"w x 29.5"h	22.5"	4"	15.5"	23.5"	21"	82 lbs	4.00	+\$90/yd	+\$31/yd	-
MIS103	Standard	Sofa	33.5"d x 78.25"w x 29.5"h	22.5"	4"	15.5"	23.5"	21"	110 lbs	6.00	+\$90/yd	+\$31/yd	-
MIS101V	Flex	Chair	33.5"d x 31.25"w x 29.5"h	22.5"	4"	15.5"	23.5"	21"	61 lbs	2.00	+\$90/yd	+\$31/yd	-
MIS102V	Flex	Settee	33.5"d x 54.75"w x 29.5"h	22.5"	4"	15.5"	23.5"	21"	82 lbs	4.00	+\$90/yd	+\$31/yd	-
MIS103V	Flex	Sofa	33.5"d x 78.25"w x 29.5"h	22.5"	4"	15.5"	23.5"	21"	110 lbs	6.00	+\$90/yd	+\$31/yd	-

MODEL

	COM	A	B	C	D	E	F	G	H	I	J	K	L	M	N
MIS101	\$3,506	\$3,796	\$3,820	\$3,853	\$3,878	\$3,902	\$3,935	\$3,977	\$4,026	\$4,098	\$4,150	\$4,202	\$4,254	\$4,306	\$4,358
MIS102	\$4,714	\$4,822	\$4,871	\$4,937	\$4,987	\$5,035	\$5,102	\$5,184	\$5,283	\$5,425	\$5,529	\$5,635	\$5,739	\$5,844	\$5,948
MIS103	\$5,582	\$5,767	\$5,841	\$5,940	\$6,014	\$6,088	\$6,187	\$6,311	\$6,458	\$6,672	\$6,829	\$6,986	\$7,142	\$7,300	\$7,456
MIS101V	\$3,762	\$4,065	\$4,090	\$4,123	\$4,147	\$4,172	\$4,205	\$4,246	\$4,296	\$4,367	\$4,419	\$4,472	\$4,524	\$4,576	\$4,628
MIS102V	\$5,051	\$5,155	\$5,204	\$5,270	\$5,320	\$5,368	\$5,435	\$5,517	\$5,616	\$5,758	\$5,862	\$5,968	\$6,072	\$6,177	\$6,281
MIS103V	\$5,985	\$6,164	\$6,239	\$6,337	\$6,412	\$6,485	\$6,584	\$6,708	\$6,856	\$7,069	\$7,227	\$7,383	\$7,540	\$7,697	\$7,854

MARCO

Standard Features:

- Solid Maple leg assembly | 1-1/4" Thick
- Solid Arm Cap | 3" Wide | 5/8" Bullnose Radius Front Edge
- Seat Frame Bolts to Leg Assembly
- 8 Gauge Seat and 11 Gauge Back | Sinuous Wire & Tied Together
- Commercial Grade Contour Foam with Double Needle Stitching
- Back Leg Set at 105° for "Wall Saving" Functionality
- Ships Fully Assembled



ModuForm Finishes:

- Standard Wood Finish: Natural/Light Oak (LO)
- Option: Available Standard Wood Finishes Include (Upcharge in STAIN Column Below):
Light Cherry (LC), Cherry (CO), Stone (ST), Dark Mocha (DM), Walnut (WL)
- Option: For Custom Finish, Please add \$500 NET per Order Plus Listed STAIN Upcharge
- Option: Custom Wood Finish (per order):
Option: For custom wood finish, please add \$600 NET plus listed stain upcharge



SF8101



SF8102



SF8103

MODEL	COVER	DESC	#SEATS	DIMENSION	AH	AW	SH	SD	SW	FABRIC	YDS	CAL 133	MB	STAIN
SF8101	Standard	Chair	1	32.25"d x 27"w x 35.5"h	24.5"	3"	18.5"	21.5"	20"	55 lbs	2.75	+\$90/yd	+\$31/yd	+\$213
SF8102	Standard	Settee	2	32.25"d x 48"w x 35.5"h	24.5"	3"	18.5"	42"	20"	80 lbs	4.50	+\$90/yd	+\$31/yd	+\$213
SF8103	Standard	Sofa	3	32.25"d x 69"w x 35.5"h	24.5"	3"	18.5"	63"	20"	80 lbs	6.25	+\$90/yd	+\$31/yd	+\$213

MODEL

	COM	A	B	C	D	E	F	G	H	I	J	K	L	M	N
SF8101	\$1,922	\$2,024	\$2,058	\$2,106	\$2,142	\$2,176	\$2,224	\$2,283	\$2,354	\$2,455	\$2,530	\$2,606	\$2,681	\$2,754	\$2,830
SF8102	\$2,901	\$3,333	\$3,390	\$3,468	\$3,526	\$3,584	\$3,661	\$3,758	\$3,873	\$4,040	\$4,162	\$4,352	\$4,482	\$4,611	\$4,740
SF8103	\$3,186	\$4,126	\$4,223	\$4,355	\$4,454	\$4,551	\$4,682	\$4,847	\$5,043	\$5,326	\$5,534	\$5,741	\$5,949	\$6,159	\$6,366

MINI MARCO | PUBLIC AREA SEATING

Standard Features:

- Solid Maple Leg Assembly & Arm Cap with Bullnose Front Edge
- Seat Frame Bolts to Leg Assembly
- 8 Gauge Seat and 11 Gauge Back | Sinuous Wire & Tied Together
- Commercial Grade Contour Foam with Double Needle Stitching
- Back Leg Set at 105° for "Wall Saving" Functionality
- Ships Fully Assembled



ModuForm Finishes:

- Standard Wood Finish: Natural/Light Oak (LO)
- Option: Available Standard Wood Finishes Include (Upcharge in STAIN Column Below):
Light Cherry (LC), Cherry (CO), Stone (ST), Dark Mocha (DM), Walnut (WL)
- Option: For Custom Finish, Please add \$500 NET per Order Plus Listed STAIN Upcharge
- Option: Custom Wood Finish (per order):
Option: For custom wood finish, please add \$600 NET plus listed stain upcharge



MM101



MM102



MM103



MM301

MODEL	COVER	DESC	#SEATS	DIMENSION	AH	AW	SH	SD	SW	FABRIC	YDS	CAL 133	MB	STAIN
MM101	Standard	Chair	1	28"d x 25.25"w x 33.25"h	25.25"	2.87":1.25"	19.5"	18"	-	35 lbs	2.00	+\$90/yd	+\$31/yd	+\$213
MM102	Standard	Tandem	2	28"d x 47.5"w x 33.25"h	25.25"	2.87":1.25"	19.5"	18"	-	65 lbs	4.50	+\$90/yd	+\$31/yd	+\$213
MM103	Standard	Tandem	3	28"d x 69.75"w x 33.25"h	25.25"	2.87":1.25"	19.5"	18"	-	85 lbs	6.75	+\$90/yd	+\$31/yd	+\$213
MM301	Standard	Bariatric Ch	1	28"d x 35"w x 33.25"h	25.25"	2.87":1.25"	19.5"	18"	-	60 lbs	2.50	+\$90/yd	+\$31/yd	+\$213

MODEL

	COM	A	B	C	D	E	F	G	H	I	J	K	L	M	N
MM101	\$1,780	\$1,869	\$1,899	\$1,939	\$1,966	\$1,996	\$2,035	\$2,085	\$2,146	\$2,229	\$2,292	\$2,354	\$2,417	\$2,480	\$2,542
MM102	\$2,843	\$3,059	\$3,124	\$3,212	\$3,278	\$3,345	\$3,434	\$3,544	\$3,677	\$3,868	\$4,010	\$4,150	\$4,291	\$4,431	\$4,573
MM103	\$3,817	\$4,139	\$4,238	\$4,371	\$4,470	\$4,570	\$4,702	\$4,869	\$5,068	\$5,355	\$5,566	\$5,776	\$5,988	\$6,199	\$6,411
MM301	\$2,302	\$2,383	\$2,415	\$2,457	\$2,489	\$2,521	\$2,563	\$2,617	\$2,681	\$2,773	\$2,841	\$2,908	\$2,975	\$3,043	\$3,111

ROCKERS | OLIVE'S CHAIR - HIGHLIGHTS & OVERVIEW

Solid Beech and Beech Ply from Sustainable Forests



2" Thick Optional Back Cushion (1.33 yds COM) for Added Comfort

Back Consists of (8) Contoured Supports with Reverse "S" Lumbar Support

3" Thick Optional Seat Cushion (.66 yds COM) for Added Comfort

Mechanism Produces True Rocking Motion with a Stable Base and Sealed Ball Bearing Bushings



Closed Cell PVC Foam Bumper/Stop



Optional Locking Mechanism Available - See *LOCK



Shown with Side Panels

ROCKERS | OLIVE'S CHAIR

ModuForm Finishes:

Standard Wood Finish: Natural Beech (NB)

Option: Available Standard Wood Finishes Include (Upcharge in STAIN Column Below):

Light Cherry (LC), Cherry (CO), Stone (ST), Dark Mocha (DM), Walnut (WL)

Option: For Custom Finish, Please add \$500 NET per Order Plus Listed **STAIN Upcharge

Option: Custom Wood Finish (per order):

Option: For custom wood finish, please add \$600 NET plus listed stain upcharge



Ships Fully Assembled



ROC01



ROC01SP



ROC01BCU

ROC01SCU

MODEL	DESCRIPTION	DIMENSION	AH	AW	SH	SD	SW	WOOD	MB
ROC01	Chair	29.25"d x 26"w x 45"h	27"	-	17"	20.25"	18"	48 lbs	-
ROC01SP	Chair Side Panels	29.25"d x 26"w x 45"h	27"	-	17"	20.25"	18"	51 lbs	-
ROC01BCU	Rocker Cushion Back	2"d x 25"w x 31"h	-	-	-	-	-	-	+\$31/yd
ROC01SCU	Rocker Cushion Seat	3"d x 20"w x 20"h	-	-	-	-	-	-	+\$31/yd

MODEL

	WOOD	*LOCK	CAL 133	**STAIN
ROC01	\$1,622	+\$146	+\$90/yd	+\$251
ROC01SP	\$1,836	+\$146	+\$90/yd	+\$251

ROC01BCU

ROC01SCU

	YDS	COM	A	B	C	D	E	F	G	H	I	J	K	L	M	N
ROC01BCU	1.33	\$242	\$272	\$289	\$315	\$333	\$375	\$401	\$437	\$478	\$540	\$582	\$625	\$674	\$728	\$786
ROC01SCU	0.66	\$175	\$189	\$197	\$208	\$219	\$241	\$254	\$270	\$289	\$322	\$343	\$365	\$391	\$418	\$447

STATEMENT OF LINE



Bristol



Bristol Flex



Bounce



Burke



Chelsea | Chelsea Flex



Chelsea Table



Chelsea Jr.



Climb



Collegetown



Collegetown | Tight Seat



Collegetown Flex



Connect



Dalton



Emma



Joanna



Julia



Kensington



Newman



Peabody



Salem



Salem Flex



Sunday



University



Westminster



William



Wilmington

WHY US?

Frame Premium contract, commercial and furniture grade laminated engineered hardwood machined into "puzzle cut" components using a heavy-duty computer controlled router manufacturing to +/- 1/32". Assembled with interlocking components and reinforced utilizing high-grade commercial quality adhesive and galvanized 16 gauge x 1-1/2" coated framing fasteners.

Foam High-grade commercial and contract either laminated or cut depending on size, shape and overall design.

Springs 8 gauge seat and 11 gauge back "S" shaped continuous coils where appropriate reinforced with 16 gauge paper covered tie rods for "no sag" construction. Fixed to engineered hardwood rails using tape lined clips to prevent squeaking. Concealed and softened using cover and densified batting.

Stretch Web Where necessary, 3-1/2" heavy duty nylon attached with interwoven assembly and high-grade furniture fastening system.

Stitching Finest quality bonded, low profile nylon thread. Superior strength and abrasion resistance. Top stitch, single need and double needle available.



Single Needle Stitch

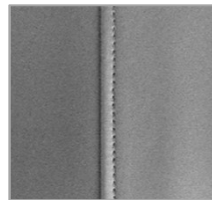

Top Stitch

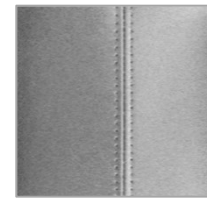

Double Needle Stitch

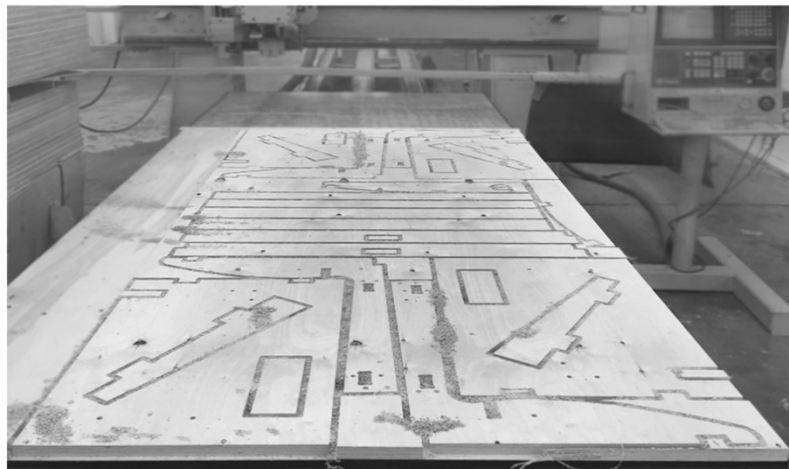

4' x 8' sheets of engineered hardwood are loaded on to a nested base CNC router to cut out frame components in "puzzle" shapes that will lock together during assembly.

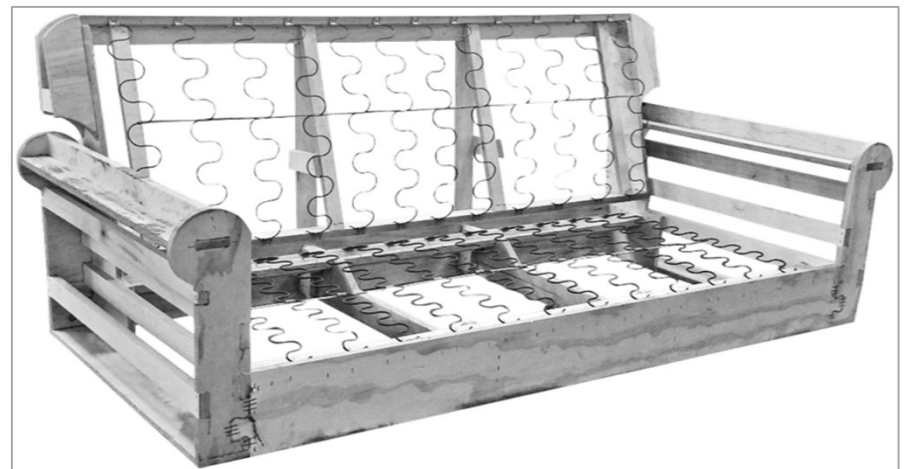

After frame parts are machined and removed from the "nest" (pictured left), components are glue joined, locked and mechanically fastened together to create a high-quality durable foundation.

OPTIONAL ACCESSORIES

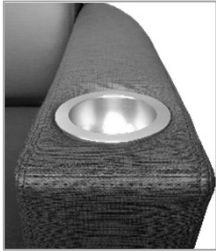

Cup Holder

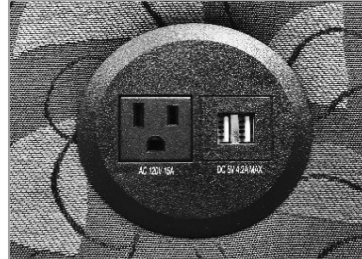

Power



Handle for Motion Package



Casters

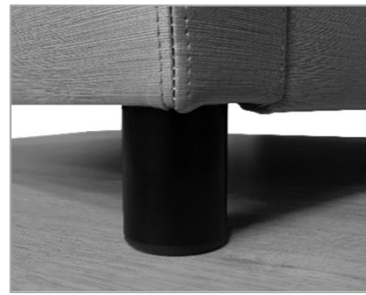

Metal Leg - Black
Adjustable



Metal Leg - Silver
Adjustable



Wood Leg | Standard
Choose from Finish Options
Natural, Light Cherry, Cherry
Dark Mocha, Stone



Tablet Arm for Armless Chairs
Top is 12" dia black HPL with matching T-mold edge
Arm is grey metal bolted to underside of chair



Tablet Arm for Arm Chairs
Top is 12" dia black HPL with matching T-mold edge



"D" ring elastic ties and spring clips
Standard for "loose" cushions

FLEX COVER - What is it?

Flex Cover provides customers with the option to replace the fabrics that were originally upholstered to the chair, settee or sofa. We utilize the same style of puzzle cut frames across all our products to ensure the foundation of the unit is of the highest quality and comfort. Arched springs and commercial grade foam are used so that the same level of comfort in a Flex Cover model is experienced in a traditional single piece frame. The process to change out fabric is done without any tools or special training. Simply turn the unit over, loosen and remove the large hand knobs and pull the components apart. The fabric is "fastened" to the frame with heavy-duty hook and loop fastening that can be pulled apart to remove the cover. To complete the re-upholstering, simply take the new covers, slip them over the components in the reverse order from the removal steps.

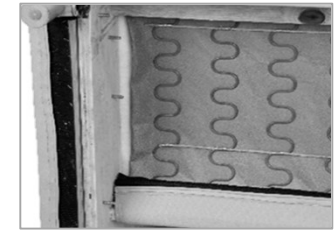
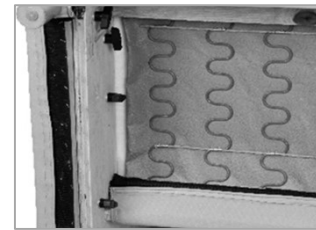
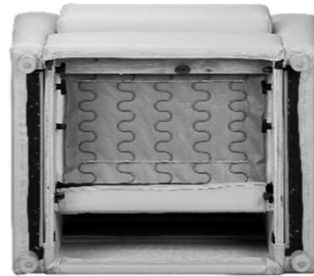

Turn the unit over to access the removable feet and hand knobs. Unscrew the hand knobs to expose the threaded studs from the arms.



Unscrew the (4) feet



Slide the arms away from the frame of the piece

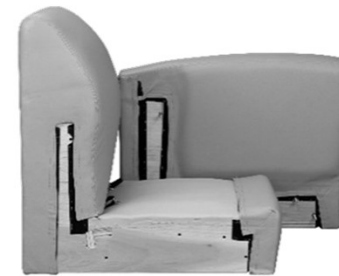

Detach the Velcro and slide the fabric covers off



All hardware and fabric has been removed and the unit is now ready for new covers.

Table Tops

Standard laminate and Edges:

Top	Manufacturer	Model	Name	3MM Edge	T-Mold Edge
Natural Oak	Formica	7152-58	Northern Oak	Natural Oak	Natural Oak
Light Cherry on Oak	Formica	6208-58	Glamour Cherry	Oiled Cherry	Wild Cherry
Cherry on Oak	Formica	7759-58	Select Cherry	Select Cherry	Black
Stone on Oak	Formica	6413-58	Silver Riftwood	Silver Riftwood	Black
Dark Mocha on Oak	Formica	8848-58	Blackened Legno	Blackened Legno	Black
Walnut on Oak	Formica	6402-42	Thermo Walnut	Thermo Walnut	Black
Natural Maple	Formica	86992-58	Hard Rock Maple	Hard Rock Maple	Hard Rock Maple
Light Cherry on Maple	Formica	5904-43	Wild Cherry	Wild Cherry	Wild Cherry
Cherry on Maple	Formica	7759-58	Select Cherry	Select Cherry	Black
Stone on Maple	Formica	6413-58	Silver Riftwood	Silver Riftwood	Black
Dark Mocha on Maple	Formica	8848-58	Blackened Legno	Blackened Legno	Black
Walnut on Maple	Formica	6402-42	Thermo Walnut	Thermo Walnut	Black
White - writable	Formica	949-90	Gloss White	White	White
Black	Formica	909-58	Matte Black	Black	Black

Standard laminates are available on all tops. Edge band is determined by top shape

Series	Model	Description	Edge	Series	Model	Description	Edge
Chelsea	SF6200ET	End Table HPL Top	3MM	Dalton	BG8506HT	Drum HPL Top	T-Mold
Chelsea	SF6200TET	End Table Tall HPL Top	3MM	Dalton	BG8507HT	Drum HPL Top	T-Mold
Chelsea	SF6245BNH	45° Table HPL Top	T-Mold	Dalton	BG8508HT	Curve HPL Top	T-Mold
Chelsea	SF6290	90° Table HPL Top	T-Mold	Dalton	BGCRNRHT	Corner 90° Wedge HPL Top	T-Mold
Chelsea	SF6236RD	Table HPL Top	T-Mold	Dalton	BGCRNSHT	Corner 90° Square HPL Top	3MM
Dalton	BG8501HT	90° Wedge HPL Top	T-Mold	Dalton	BGTBL48	Table Pedstal HPL Top	T-Mold
Dalton	BG8502HT	Cube HPL Top	3MM	Julia	JULARMT	Arm HPL	3MM
Dalton	BG8503HT	Cube HPL Top	3MM	Julia	JULARMT-POW	Arm HPL Power	3MM
Dalton	BG8504HT	Cube HPL Top	3MM	Julia	JUL18DHT	Ottoman with HPL Top	T-Mold
Dalton	BG8516DHT	Drum HPL Top	T-Mold	Julia	JUL36DHT	Table with HPL Top	T-Mold
Dalton	BG8505HT	Drum HPL Top	T-Mold				

BRISTOL Chair | Settee | Sofa



Standard Features:

- Double Needle Stitching
- 7" Thick Laminated Foam Seat Cushion with Polyester Fiber Wrap for Comfort
- Seat Cushion Clipped to Chair Using "D" Ring Elastic Ties and Spring Clips
- Feet: Block Leg Tapered 3 Sides | Choose Finish - Natural, Light Cherry, Cherry, Dark Mocha, Stone

Option | Contrast Stitching: +\$79

***NOTE:**

When specifying multiple fabrics please:

- Clearly identify which fabric is to be upholstered to the seat, back and arms.
- Use highest grade pricing of all fabric selected (i.e. if you choose E and J, use J grade for all).
- Please call customer service for yardage requirements.



SF5101



SF5102



SF5103

MODEL	COVER	DESCRIPTION	DIMENSION	AH	SH	SW	SD	WT	YDS	CAL 133	MB
SF5101	Standard	Chair	30.5"d x 33"w x 32.5"h	25.5"	17.5"	24"	21"	70 lbs	5.50	+\$90/yd	+\$31/yd
SF5102	Standard	Settee	30.5"d x 56.5"w x 32.5"h	25.5"	17.5"	48"	21"	100 lbs	7.50	+\$90/yd	+\$31/yd
SF5103	Standard	Sofa	30.5"d x 79.5"w x 32.5"h	25.5"	17.5"	69"	21"	183 lbs	10.00	+\$90/yd	+\$31/yd

MODEL

	COM	A	B	C	D	E	F	G	H	I	J	K	L	M	N
SF5101	\$2,412	\$2,618	\$2,685	\$2,776	\$2,861	\$2,931	\$3,025	\$3,142	\$3,283	\$3,545	\$3,701	\$3,857	\$4,013	\$4,169	\$4,326
SF5102	\$2,752	\$3,050	\$3,142	\$3,265	\$3,382	\$3,477	\$3,605	\$3,765	\$3,956	\$4,314	\$4,526	\$4,739	\$4,953	\$5,166	\$5,378
SF5103	\$3,276	\$3,686	\$3,809	\$3,973	\$4,128	\$4,256	\$4,427	\$4,639	\$4,895	\$5,371	\$5,655	\$5,939	\$6,223	\$6,506	\$6,790

BRISTOL | FLEX COVER

Chair | Settee | Sofa

Standard Features:

- Double Needle Stitching
- Replaceable Fabric Covers | No Tools Needed
- Bolt Together Assembly | Velcro Upholstery
- 7" Thick Laminated Foam Seat Cushion with Polyester Fiber Wrap for Comfort
- Seat Cushion Clipped to Chair Using "D" Ring Elastic Ties and Spring Clips
- Feet: Wood Cylinder Leg | Choose Finish - Natural, Light Cherry, Cherry, Dark Mocha, Stone

- Option | Metal Leg (Choose Black or Grey): +\$193
- Option | Contrast Stitching: +\$79

SF5101V



SF5102V



SF5103V



MODEL	COVER	DESCRIPTION	DIMENSION	AH	SH	SW	SD	WT	YDS	CAL 133	MB
SF5101V	Flex	Chair	30.5"d x 33"w x 32.5"h	25.5"	17.5"	24"	21"	70 lbs	5.50	+\$90/yd	+\$31/yd
SF5102V	Flex	Settee	30.5"d x 56.5" x 32.5"h	25.5"	17.5"	48"	21"	100 lbs	7.50	+\$90/yd	+\$31/yd
SF5103V	Flex	Sofa	30.5"d x 79.5" x 32.5"h	25.5"	17.5"	69"	21"	183 lbs	10.00	+\$90/yd	+\$31/yd
SF5101VREPCOV	Flex	Chair Replacement Cover		-	-	-	-	-	5.50	+\$90/yd	+\$31/yd
SF5102VREPCOV	Flex	Settee Replacement Cover		-	-	-	-	-	7.50	+\$90/yd	+\$31/yd
SF5103VREPCOV	Flex	Sofa Replacement Cover		-	-	-	-	-	10.00	+\$90/yd	+\$31/yd
SF5100VLAFCOV	Flex	Left Arm Replacement Cover		-	-	-	-	-	1.33	+\$90/yd	+\$31/yd
SF5100VRAFCOV	Flex	Right Arm Replacement Cover		-	-	-	-	-	1.33	+\$90/yd	+\$31/yd
SF5100VRSTCOV	Flex	Seat Replacement Cover		-	-	-	-	-	1.25	+\$90/yd	+\$31/yd
SF5100VRECUSH	Flex	Seat Cushion Replacement with Cover		-	-	-	-	-	1.25	+\$90/yd	+\$31/yd

MODEL

SF5101V
SF5102V
SF5103V

COM	A	B	C	D	E	F	G	H	I	J	K	L	M	N
\$2,750	\$2,945	\$3,012	\$3,104	\$3,188	\$3,259	\$3,352	\$3,470	\$3,610	\$3,872	\$4,028	\$4,184	\$4,340	\$4,497	\$4,653
\$3,137	\$3,423	\$3,515	\$3,638	\$3,755	\$3,850	\$3,978	\$4,138	\$4,329	\$4,687	\$4,899	\$5,112	\$5,325	\$5,539	\$5,751
\$3,734	\$4,130	\$4,253	\$4,417	\$4,572	\$4,700	\$4,871	\$5,083	\$5,338	\$5,814	\$6,098	\$6,382	\$6,666	\$6,950	\$7,234

SF5101VREPCOV
SF5102VREPCOV
SF5103VREPCOV
SF5100VLAFCOV
SF5100VRAFCOV
SF5100VRSTCOV
SF5100VRECUSH

\$547	\$745	\$814	\$910	\$999	\$1,072	\$1,170	\$1,293	\$1,441	\$1,713	\$1,877	\$2,040	\$2,203	\$2,367	\$2,531
\$697	\$1,008	\$1,101	\$1,224	\$1,340	\$1,436	\$1,563	\$1,723	\$1,915	\$2,285	\$2,508	\$2,733	\$2,955	\$3,179	\$3,403
\$862	\$1,257	\$1,380	\$1,544	\$1,699	\$1,827	\$2,002	\$2,225	\$2,494	\$2,986	\$3,285	\$3,582	\$3,881	\$4,179	\$4,476
\$248	\$297	\$315	\$338	\$358	\$377	\$401	\$429	\$466	\$532	\$570	\$610	\$650	\$689	\$729
\$248	\$297	\$315	\$338	\$358	\$377	\$401	\$429	\$466	\$532	\$570	\$610	\$650	\$689	\$729
\$162	\$221	\$236	\$258	\$278	\$295	\$317	\$345	\$378	\$441	\$477	\$515	\$551	\$589	\$627
\$248	\$304	\$321	\$342	\$362	\$378	\$401	\$428	\$462	\$524	\$561	\$598	\$635	\$673	\$711

***NOTE:** When specifying multiple fabrics please:

Clearly identify which fabric is to be upholstered to the seat, back and arms.

Use highest grade pricing of all fabric selected (i.e. if you choose E and J, use J grade for all).

Please call customer service for yardage requirements.



BOUNCE Cube

Standard Features:

- Double Needle Stitching
- Velcro Enclosed Bottom | High Resiliency, Pressure Molded Foam Core

Option | Contrast Stitching: +\$79



MODEL	COVER	DESCRIPTION	DIMENSION	AH	SH	SW	SD	WT	YDS	CAL 133	MB
BCE3X15V	Flex	Ottoman	15"d x 15"w x 15"h	-	15"	-	-	7 lbs	1.25	+\$90/yd	+\$31/yd

MODEL

BCE3X15V

COM	A	B	C	D	E	F	G	H	I	J	K	L	M	N
\$617	\$675	\$692	\$714	\$735	\$751	\$773	\$802	\$836	\$883	\$918	\$954	\$989	\$1,024	\$1,060

***NOTE:** When specifying multiple fabrics please:

Clearly identify which fabric is to be upholstered to which panel.

Use highest grade pricing of all fabric selected (i.e. if you choose E and J, use J grade for all).

Please call customer service for yardage requirements.

BURKE Recliner

Standard Features:

- GSA Approved | Heavy Duty Mechanism
- Single Needle Stitching
- 4" Thick Cushion with Polyester Fiber Wrap for Comfort



MODEL	COVER	DESCRIPTION	DIMENSION	AH	SH	SW	SD	WT	YDS	CAL 133	MB
SF50	Standard	Chair	39"d x 35"w x 42"h <i>66"d when fully extended</i>	23.5"	19.5"	20"	20"	105 lbs	6.50	+\$90/yd	+\$31/yd

MODEL

SF50

COM	A	B	C	D	E	F	G	H	I	J	K	L	M	N
\$3,154	\$3,365	\$3,436	\$3,534	\$3,648	\$3,727	\$3,833	\$3,965	\$4,124	\$4,403	\$4,580	\$4,757	\$4,932	\$5,108	\$5,283



CHELSEA STATEMENT OF LINE



SF6201



SF6201A



SF6201LM



SF6201RM



SF6222IA



SF6222OA



SF6245IA



SF6236RD



SF6290



SF6245



SF6200ET



SF6200TET



SF6201J



SF6201JA

CHELSEA Modular Chair | Wedge



Standard Features:

- Single Needle Stitching
- Seat and Back Cushions Includes Polyester Fiber Wrap for Added Comfort
- Feet: Wood Cylinder Legs (Choose finish - Natural, Light Cherry, Cherry, Dark Mocha, Stone)



Option | Double Needle Stitching:

- Chair: +\$95
- Chair with 1 Arm: +\$142
- Armchair: +\$184

- Option | Contrast Stitching (with Double Needle Only): +\$79
- Option | Motion Package (Handle, 2 Casters*, 2 Metal Legs): +\$208
- Option | Motion Package (Handle, 2 Casters*, 2 Wood Legs): +\$114
- Option | 4 Casters (2 Locking): +\$60
- Option | Feet | 4 Metal Cylinder Legs (Choose Black or Silver): +\$193
- Option | Tablet Arm (Bolted to Underside of Chair): +\$524
- Option | Ganging Clip: +\$47
- Option | Power (2 - USB & 1 - 110V) | Side Mounted: +\$250

***NOTE:**

Casters in the motion package are non-locking. For 2 locking, please add \$10.00
 When specifying multiple fabrics please:
 Clearly identify which fabric is to be upholstered to the seat, back and arms.
 Use highest grade pricing of all fabric selected (i.e. if you choose E and J, use J grade for all).
 Please call customer service for yardage requirements.



SF6201
SF6201V



SF6201A



SF6201RM



SF6201LM

MODEL	COVER	DESCRIPTION	DIMENSION	AH	SH	SW	SD	WT	YDS	CAL 133	MB
SF6201	Standard	Chair	29"d x 24.5"w x 32"h	20"	18"	-	21"	40 lbs	3.00	+\$90/yd	+\$31/yd
SF6201A	Standard	Armchair	29"d x 30.5"w x 32"h	26"	18"	24.5"	21"	70 lbs	6.00	+\$90/yd	+\$31/yd
SF6201V	Flex	Chair	29"d x 24.5"w x 32"h	20"	18"	-	21"	40 lbs	3.00	+\$90/yd	+\$31/yd
SF6201RM	Standard	Right Arm Module	29"d x 27.5"w x 32"h	26"	18"	24.5"	21"	55 lbs	4.50	+\$90/yd	+\$31/yd
SF6201LM	Standard	Left Arm Module	29"d x 27.5"w x 32"h	26"	18"	24.5"	21"	55 lbs	4.50	+\$90/yd	+\$31/yd

MODEL

MODEL	COM	A	B	C	D	E	F	G	H	I	J	K	L	M	N
SF6201	\$1,383	\$1,495	\$1,533	\$1,585	\$1,632	\$1,672	\$1,726	\$1,798	\$1,884	\$2,041	\$2,137	\$2,231	\$2,328	\$2,422	\$2,518
SF6201A	\$2,409	\$2,643	\$2,717	\$2,816	\$2,909	\$2,986	\$3,088	\$3,215	\$3,369	\$3,654	\$3,825	\$3,995	\$4,165	\$4,336	\$4,506
SF6201V	\$1,530	\$1,638	\$1,674	\$1,724	\$1,771	\$1,810	\$1,862	\$1,926	\$2,003	\$2,147	\$2,234	\$2,320	\$2,405	\$2,491	\$2,578
SF6201RM	\$1,856	\$2,030	\$2,084	\$2,159	\$2,228	\$2,286	\$2,363	\$2,458	\$2,573	\$2,788	\$2,915	\$3,043	\$3,171	\$3,299	\$3,426
SF6201LM	\$1,856	\$2,030	\$2,084	\$2,159	\$2,228	\$2,286	\$2,363	\$2,458	\$2,573	\$2,788	\$2,915	\$3,043	\$3,171	\$3,299	\$3,426

CHELSEA Modular Chair | Wedge



Standard Features:

- Single Needle Stitching
- Seat and Back Cushions Includes Polyester Fiber Wrap for Added Comfort
- Feet: Wood Cylinder Legs (Choose finish - Natural, Light Cherry, Cherry, Dark Mocha, Stone)

- Option | Double Needle Stitching:
 - Chair: +\$95
- Option | Contrast Stitching (with Double Needle Only): +\$79
- Option | Motion Package (Handle, 2 Casters*, 2 Metal Legs): +\$208
- Option | Motion Package (Handle, 2 Casters*, 2 Wood Legs): +\$114
- Option | 4 Casters (2 Locking): +\$60
- Option | Feet | 4 Metal Cylinder Legs (Choose Black or Silver): +\$193
- Option | Tablet Arm (Bolted to Underside of Chair): +\$524
- Option | Ganging Clip: +\$47
- Option | Power (2 - USB & 1 - 110V) | Side Mounted: +\$250

***NOTE:**

Casters in the motion package are non-locking. For 2 locking, please add \$10.00
 When specifying multiple fabrics please:
 Clearly identify which fabric is to be upholstered to the seat, back and arms.
 Use highest grade pricing of all fabric selected (i.e. if you choose E and J, use J grade for all).
 Please call customer service for yardage requirements.



SF6245IA



SF6222IA



SF6222OA

MODEL	COVER	DESCRIPTION	DIMENSION	AH	SH	SW	SD	WT	YDS	CAL 133	MB
SF6245IA	Standard	Chair 45° Inside	29"d x 26.5"w x 32"h	20"	18"	-	21"	-	3.50	+\$90/yd	+\$31/yd
SF6222IA	Standard	Chair 22° Inside	29"d x 27"w x 32"h	20"	18"	-	21"	-	3.00	+\$90/yd	+\$31/yd
SF6222OA	Standard	Chair 22° Outside	29"d x 28"w x 32"h	20"	18"	-	21"	-	3.00	+\$90/yd	+\$31/yd

MODEL

MODEL	COM	A	B	C	D	E	F	G	H	I	J	K	L	M	N
SF6245IA	\$1,667	\$1,794	\$1,837	\$1,895	\$1,949	\$1,994	\$2,054	\$2,128	\$2,218	\$2,384	\$2,483	\$2,583	\$2,682	\$2,781	\$2,881
SF6222IA	\$1,490	\$1,598	\$1,634	\$1,684	\$1,730	\$1,769	\$1,820	\$1,884	\$1,960	\$2,103	\$2,188	\$2,274	\$2,358	\$2,444	\$2,529
SF6222OA	\$1,463	\$1,570	\$1,607	\$1,657	\$1,703	\$1,741	\$1,793	\$1,856	\$1,933	\$2,075	\$2,161	\$2,246	\$2,331	\$2,416	\$2,502

CHELSEA TABLES Modular Tables



Standard Features:

- Single Needle Stitching
- Tops: 3/4" HPL (Choose finish - Natural, Light Cherry, Cherry, Dark Mocha, Stone)
- PVC/T-Mold Edge to Match | See Table Tops Standard Laminate and Edges in Statement of Line
- Feet: Wood Cylinder Legs (Choose finish - Natural, Light Cherry, Cherry, Dark Mocha, Stone)

- Option | Feet | 4 Metal Cylinder Legs (Choose Black or Silver): +\$193
- Option | Ganging Clip: +\$47
- Option | Power (2 - USB & 1 - 110V) | Side Mounted: +\$250



MODEL	COVER	DESCRIPTION	DIMENSION	WT	YDS	CAL 133	MB
SF6200ET	Standard	End Table HPL Top	24"d x 12"w x 16"h	30 lbs	1.25	+\$90/yd	+\$31/yd
SF6200TET	Standard	End Table Tall HPL Top	24"d x 12"w x 21"h	35 lbs	1.50	+\$90/yd	+\$31/yd
SF6245BNH	Standard	45° Table HPL Top	26"d x 32"w x 16"h	0	1.75	+\$90/yd	+\$31/yd
SF6290	Standard	90° Table HPL Top	27.25"d x 46"w x 16"h	44 lbs	1.75	+\$90/yd	+\$31/yd
SF6236RD	Standard	Table HPL Top	36"dia x 16"h	-	1.75	+\$90/yd	+\$31/yd

MODEL	COM	A	B	C	D	E	F	G	H	I	J	K	L	M	N
SF6200ET	\$992	\$1,028	\$1,045	\$1,069	\$1,088	\$1,107	\$1,130	\$1,160	\$1,195	\$1,262	\$1,301	\$1,341	\$1,381	\$1,420	\$1,461
SF6200TET	\$1,025	\$1,072	\$1,091	\$1,120	\$1,146	\$1,167	\$1,195	\$1,232	\$1,274	\$1,353	\$1,400	\$1,448	\$1,496	\$1,543	\$1,591
SF6245BNH	\$1,122	\$1,180	\$1,203	\$1,235	\$1,266	\$1,290	\$1,322	\$1,365	\$1,415	\$1,524	\$1,563	\$1,617	\$1,674	\$1,729	\$1,783
SF6290	\$1,309	\$1,359	\$1,382	\$1,413	\$1,440	\$1,463	\$1,494	\$1,533	\$1,578	\$1,665	\$1,716	\$1,767	\$1,819	\$1,869	\$1,921
SF6236RD	\$1,343	\$1,415	\$1,439	\$1,470	\$1,501	\$1,547	\$1,579	\$1,623	\$1,673	\$1,764	\$1,820	\$1,875	\$1,931	\$1,986	\$2,041

CHELSEA JR. Chair | Small Scale

Standard Features:

- Single Needle Stitching
- Seat and Back Cushions Includes Polyester Fiber Wrap for Added Comfort
- Feet: Wood Cylinder Legs (Choose finish - Natural, Light Cherry, Cherry, Dark Mocha, Stone)



- Option | Double Needle Stitching:
Chair: +\$95
- Option | Contrast Stitching (with Double Needle Only): +\$79
- Option | Motion Package (Handle, 2 Casters*, 2 Metal Legs): +\$208
- Option | Motion Package (Handle, 2 Casters*, 2 Wood Legs): +\$114
- Option | 4 Casters (2 Locking): +\$60
- Option | Feet | 4 Metal Cylinder Legs (Choose Black or Silver): +\$193

***NOTE:**

Casters in the motion package are non-locking. For 2 locking, please add \$10.00
 When specifying multiple fabrics please:
 Clearly identify which fabric is to be upholstered to the seat, back and arms.
 Use highest grade pricing of all fabric selected (i.e. if you choose E and J, use J grade for all).
 Please call customer service for yardage requirements.



SF6201J



SF6201JA

MODEL	COVER	DESCRIPTION	DIMENSION	AH	SH	SW	WT	YDS	CAL 133	MB
SF6201J	Standard	Chair Small Scale	25"d x 18"w x 27"h	-	15"	-	25 lbs	2.50	+\$90/yd	+\$31/yd
SF6201JA	Standard	Armchair Small Scale	25"d x 24.5"w x 27"h	20"	15"	18	-	5.50	+\$90/yd	+\$31/yd

MODEL

MODEL	COM	A	B	C	D	E	F	G	H	I	J	K	L	M	N
SF6201J	\$1,243	\$1,343	\$1,378	\$1,423	\$1,465	\$1,501	\$1,550	\$1,608	\$1,680	\$1,811	\$1,892	\$1,970	\$2,049	\$2,129	\$2,210
SF6201JA	\$1,673	\$1,932	\$1,999	\$2,090	\$2,174	\$2,245	\$2,339	\$2,456	\$2,596	\$2,858	\$3,015	\$3,171	\$3,327	\$3,483	\$3,639

CLIMB Tiered Seating

Standard Features:

- Double Needle Stitching
- Feet: 1" Hard Plastic

- Option | Contrast Stitching (with Double Needle Only): +\$79
- Option | Ganging Clip (suggested two per unit): +\$93
- Option | Power (2 - USB & 1 - 110V) | Side Mounted: +\$250



***NOTE:**

When specifying multiple fabrics please:

- Clearly identify which fabric is to be upholstered to the seat, back and arms.
- Use highest grade pricing of all fabric selected (i.e. if you choose E and J, use J grade for all).
- Please call customer service for yardage requirements.



CL02



CL3TS



CLCRSIN



CLCRSOUT

MODEL	COVER	DESCRIPTION	DIMENSION	AH	SH	SW	SD	WT	YDS	CAL 133	MB
CL02	Standard	2 Tier Unit	40"d x 36"w x 34.5"h	-	-	-	-	106 lbs	6.50	+\$90/yd	+\$31/yd
CL3TS	Standard	3 Tier Unit	40"d x 36"w x 34.5"h	-	-	-	-	118 lbs	6.00	+\$90/yd	+\$31/yd
CLCRSIN	Standard	Inside Corner	40"d x 40"w x 34.5"h	-	-	-	-	130 lbs	8.00	+\$90/yd	+\$31/yd
CLCRSOUT	Standard	Outside Corner	40"d x 40"w x 34.5"h	-	-	-	-	125 lbs	6.00	+\$90/yd	+\$31/yd

MODEL

MODEL	COM	A	B	C	D	E	F	G	H	I	J	K	L	M	N
CL02	\$1,648	\$1,956	\$2,035	\$2,143	\$2,243	\$2,326	\$2,437	\$2,576	\$2,741	\$3,051	\$3,236	\$3,419	\$3,604	\$3,789	\$3,973
CL3TS	\$1,920	\$2,197	\$2,271	\$2,371	\$2,463	\$2,540	\$2,642	\$2,770	\$2,923	\$3,208	\$3,379	\$3,549	\$3,719	\$3,890	\$4,060
CLCRSIN	\$2,237	\$2,611	\$2,710	\$2,843	\$2,966	\$3,068	\$3,204	\$3,375	\$3,579	\$3,960	\$4,187	\$4,415	\$4,641	\$4,868	\$5,095
CLCRSOUT	\$2,063	\$2,337	\$2,412	\$2,511	\$2,603	\$2,681	\$2,782	\$2,910	\$3,064	\$3,349	\$3,520	\$3,690	\$3,859	\$4,030	\$4,200

COLLEGETOWN Chair | Settee | Sofa



Standard Features:

- Single Needle Stitching
- 5" Thick Foam Seat Cushion with Polyester Fiber Wrap for Comfort
- Seat Cushion Clipped to Chair Using "D" Ring Elastic Ties and Spring Clips
- Feet: Block Leg Tapered 4 Sides | Choose Finish - Natural, Light Cherry, Cherry, Dark Mocha, Stone



Option | Double Needle Stitching:

- Chair: +\$142
- Settee: +\$184
- Sofa: +\$282

Option | Contrast Stitching (with double needle only): +\$79

Option | Tablet Arm: +\$377

***NOTE:**

When specifying multiple fabrics please:

- Clearly identify which fabric is to be upholstered to the seat, back and arms.
- Use highest grade pricing of all fabric selected (i.e. if you choose E and J, use J grade for all).
- Please call customer service for yardage requirements.



SFCT01



SFCT02



SFCT03

MODEL	COVER	DESCRIPTION	DIMENSION	AH	SH	SW	SD	WT	YDS	CAL 133	MB
SFCT01	Standard	Chair	36"d x 37"w x 32"h	24"	17.5"	23"	22.25"	96 lbs	5.50	+\$90/yd	+\$31/yd
SFCT02	Standard	Settee	36"d x 59"w x 32"h	24"	17.5"	46.5"	22.25"	-	7.50	+\$90/yd	+\$31/yd
SFCT03	Standard	Sofa	36"d x 82"w x 32"h	24"	17.5"	70"	22.25"	145 lbs	9.50	+\$90/yd	+\$31/yd

MODEL

	COM	A	B	C	D	E	F	G	H	I	J	K	L	M	N
SFCT01	\$1,923	\$2,174	\$2,242	\$2,333	\$2,417	\$2,488	\$2,581	\$2,699	\$2,839	\$3,101	\$3,257	\$3,414	\$3,570	\$3,726	\$3,882
SFCT02	\$2,364	\$2,711	\$2,804	\$2,927	\$3,043	\$3,139	\$3,267	\$3,426	\$3,618	\$3,976	\$4,188	\$4,401	\$4,614	\$4,827	\$5,039
SFCT03	\$2,823	\$3,265	\$3,383	\$3,539	\$3,686	\$3,808	\$3,970	\$4,172	\$4,415	\$4,867	\$5,136	\$5,406	\$5,675	\$5,946	\$6,215

COLLEGETOWN | FLEX



Standard Features:

- Single Needle Stitching
- Replaceable Fabric Covers | No Tools Needed
- Bolt Together Assembly | Velcro Upholstery
- 5" Thick Foam Seat Cushion with Polyester Fiber Wrap for Comfort
- Seat Cushion Clipped to Chair Using "D" Ring Elastic Ties and Spring Clips
- Feet: Wood Cylinder Legs (Choose finish - Natural, Light Cherry, Cherry, Dark Mocha, Stone)

Option | Double Needle Stitching:

- Chair: +\$142
- Settee: +\$184
- Sofa: +\$282

Option | Contrast Stitching (with double needle only): +\$79

Option | Feet | 4 Metal Cylinder Legs (Choose Black or Silver): +\$193

***NOTE:**

When specifying multiple fabrics please:

- Clearly identify which fabric is to be upholstered to the seat, back and arms.
- Use highest grade pricing of all fabric selected (i.e. if you choose E and J, use J grade for all).
- Please call customer service for yardage requirements.



SFCT01V



SFCT02V



SFCT03V

MODEL	COVER	DESCRIPTION	DIMENSION	AH	SH	SW	SD	WT	YDS	CAL 133	MB
SFCT01V	Flex	Chair	36"d x 37"w x 32"h	24"	17.5"	23"	22.25"	96 lbs	5.50	+\$90/yd	+\$31/yd
SFCT02V	Flex	Settee	36"d x 59"w x 32"h	24"	17.5"	46.5"	22.25"	-	7.50	+\$90/yd	+\$31/yd
SFCT03V	Flex	Sofa	36"d x 82"w x 32"h	24"	17.5"	70"	22.25"	143 lbs	9.50	+\$90/yd	+\$31/yd

MODEL

MODEL	COM	A	B	C	D	E	F	G	H	I	J	K	L	M	N
SFCT01V	\$2,188	\$2,436	\$2,503	\$2,594	\$2,678	\$2,749	\$2,843	\$2,960	\$3,100	\$3,362	\$3,519	\$3,675	\$3,831	\$3,987	\$4,143
SFCT02V	\$2,691	\$3,033	\$3,125	\$3,248	\$3,365	\$3,460	\$3,588	\$3,748	\$3,939	\$4,297	\$4,509	\$4,722	\$4,936	\$5,149	\$5,361
SFCT03V	\$3,213	\$3,650	\$3,767	\$3,923	\$4,070	\$4,192	\$4,354	\$4,556	\$4,799	\$5,251	\$5,520	\$5,791	\$6,060	\$6,330	\$6,599

COLLEGETOWN | FLEX - REPLACEMENT COVERS AND PARTS

Standard Features:

- Single Needle Stitching
- Replaceable Fabric Covers | No Tools Needed
- Bolt Together Assembly | Velcro Upholstery
- 5" Thick Foam Seat Cushion with Polyester Fiber Wrap for Comfort
- Seat Cushion Clipped to Chair Using "D" Ring Elastic Ties and Spring Clips
- Feet: Wood Cylinder Legs (Choose finish - Natural, Light Cherry, Cherry, Dark Mocha, Stone)

Option | Double Needle Stitching:

- Chair: +\$142
- Settee: +\$184
- Sofa: +\$282

Option | Contrast Stitching (with double needle only): +\$79

***NOTE:**

When specifying multiple fabrics please:

- Clearly identify which fabric is to be upholstered to the seat, back and arms.
- Use highest grade pricing of all fabric selected (i.e. if you choose E and J, use J grade for all).
- Please call customer service for yardage requirements.



MODEL	COVER	DESCRIPTION	DIMENSION	AH	SH	SW	SD	WT	YDS	CAL 133	MB
SFCT01VREPCOV	Flex	Chair Replacement Cover		-	-	-	-	-	5.50	+\$90/yd	+\$31/yd
SFCT02VREPCOV	Flex	Settee Replacement Cover		-	-	-	-	-	7.50	+\$90/yd	+\$31/yd
SFCT03VREPCOV	Flex	Sofa Replacement Cover		-	-	-	-	-	9.50	+\$90/yd	+\$31/yd
SFCT00VLAFCOV	Flex	Left Arm Replacement Cover		-	-	-	-	-	1.75	+\$90/yd	+\$31/yd
SFCT00VRAFCOV	Flex	Right Arm Replacement Cover		-	-	-	-	-	1.75	+\$90/yd	+\$31/yd
SFCT00VRSTCOV	Flex	Seat Replacement Cover		-	-	-	-	-	1.50	+\$90/yd	+\$31/yd
SFCT00VRECUSH	Flex	Seat Cushion Replacement with Cover		-	-	-	-	-	1.50	+\$90/yd	+\$31/yd

MODEL

- SFCT01VREPCOV
- SFCT02VREPCOV
- SFCT03VREPCOV
- SFCT00VLAFCOV
- SFCT00VRAFCOV
- SFCT00VRSTCOV
- SFCT00VRECUSH

MODEL	COM	A	B	C	D	E	F	G	H	I	J	K	L	M	N
SFCT01VREPCOV	\$553	\$745	\$814	\$910	\$999	\$1,072	\$1,170	\$1,293	\$1,441	\$1,713	\$1,877	\$2,040	\$2,203	\$2,367	\$2,531
SFCT02VREPCOV	\$697	\$965	\$1,063	\$1,192	\$1,311	\$1,412	\$1,546	\$1,714	\$1,915	\$2,285	\$2,508	\$2,733	\$2,955	\$3,179	\$3,403
SFCT03VREPCOV	\$868	\$1,242	\$1,359	\$1,516	\$1,663	\$1,785	\$1,946	\$2,159	\$2,412	\$2,881	\$3,164	\$3,447	\$3,729	\$4,013	\$4,296
SFCT00VLAFCOV	\$248	\$317	\$340	\$370	\$398	\$421	\$452	\$492	\$539	\$625	\$678	\$729	\$781	\$834	\$885
SFCT00VRAFCOV	\$248	\$317	\$340	\$370	\$398	\$421	\$452	\$492	\$539	\$625	\$678	\$729	\$781	\$834	\$885
SFCT00VRSTCOV	\$162	\$232	\$251	\$278	\$301	\$322	\$348	\$381	\$422	\$496	\$541	\$585	\$631	\$675	\$719
SFCT00VRECUSH	\$248	\$316	\$335	\$362	\$386	\$405	\$431	\$466	\$507	\$581	\$625	\$669	\$714	\$759	\$803

COLLEGETOWN | INTEGRATED SEAT Chair | Settee | Sofa

Standard Features:

- Single Needle Stitching
- Integrated Foam seat and back cushions with polyester fiber wrap for comfort
- Feet: Block Leg Tapered 4 Sides | Choose Finish - Natural, Light Cherry, Cherry, Dark Mocha, Stone



Option | Double Needle Stitching:

- Chair: +\$142
- Settee: +\$184
- Sofa: +\$282

Option | Contrast stitching (with double needle only): +\$79

Option | Tablet arm: +\$377

***NOTE:**

When specifying multiple fabrics please:

- Clearly identify which fabric is to be upholstered to the seat, back and arms.
- Use highest grade pricing of all fabric selected (i.e. if you choose E and J, use J grade for all).
- Please call customer service for yardage requirements.



SFCT01TS

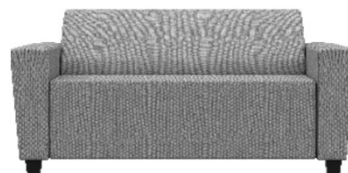

SFCT02TS



SFCT03TS

MODEL	COVER	DESCRIPTION	DIMENSION	AH	SH	SW	SD	WT	YDS	CAL 133	MB
SFCT01TS	Standard	Chair	35"d x 37"w x 32"h	24"	16.5"	23"	21"	96 lbs	5.75	+\$90/yd	+\$31/yd
SFCT02TS	Standard	Settee	35"d x 59"w x 32"h	24"	16.5"	46.5"	21"	-	7.75	+\$90/yd	+\$31/yd
SFCT03TS	Standard	Sofa	35"d x 82"w x 32"h	24"	16.5"	70"	21"	143 lbs	9.75	+\$90/yd	+\$31/yd

MODEL

	COM	A	B	C	D	E	F	G	H	I	J	K	L	M	N
SFCT01TS	\$1,959	\$2,223	\$2,294	\$2,389	\$2,478	\$2,552	\$2,650	\$2,772	\$2,919	\$3,192	\$3,356	\$3,519	\$3,683	\$3,846	\$4,009
SFCT02TS	\$2,387	\$2,747	\$2,843	\$2,970	\$3,090	\$3,189	\$3,321	\$3,487	\$3,684	\$4,053	\$4,273	\$4,493	\$4,713	\$4,933	\$5,153
SFCT03TS	\$2,681	\$3,105	\$3,226	\$3,386	\$3,537	\$3,662	\$3,827	\$4,035	\$4,283	\$4,749	\$5,026	\$5,301	\$5,579	\$5,856	\$6,133

CONNECT Banquette | 36" Back Height

Standard Features:

- Double Needle Stitching
- 3" Thick Foam Seat Cushion with Polyester Fiber Wrap for Comfort
- Feet: 1" Hard Plastic

- Option | Contrast Stitching (with double needle only): +\$79
- Option | Power (2 - USB & 1 - 110V) | Front Mounted: +\$250



***NOTE:** When specifying multiple fabrics please:

- Clearly identify which fabric is to be upholstered to the seat, back and arms.
- Use highest grade pricing of all fabric selected (i.e. if you choose E and J, use J grade for all).
- Please call customer service for yardage requirements.



CT4836



CT6036



CT7236



CT4842



CT6042



CT7242

MODEL	COVER	DESCRIPTION	DIMENSION	SH	SD	WT	YDS	CAL 133	MB
CT4836	Standard	Banquette	28"d x 48"w x 36"h	19"	20"	125 lbs	6.75	+\$90/yd	+\$31/yd
CT6036	Standard	Banquette	28"d x 60"w x 36"h	19"	20"	125 lbs	8.50	+\$90/yd	+\$31/yd
CT7236	Standard	Banquette	28"d x 72"w x 36"h	19"	20"	125 lbs	8.75	+\$90/yd	+\$31/yd
CT4842	Standard	Banquette Tall	28"d x 48"w x 42"h	19"	20"	125 lbs	7.75	+\$90/yd	+\$31/yd
CT6042	Standard	Banquette Tall	28"d x 60"w x 42"h	19"	20"	120 lbs	9.50	+\$90/yd	+\$31/yd
CT7242	Standard	Banquette Tall	28"d x 72"w x 42"h	19"	20"	125 lbs	9.75	+\$90/yd	+\$31/yd

MODEL	COM	A	B	C	D	E	F	G	H	I	J	K	L	M	N
CT4836	\$2,082	\$2,333	\$2,416	\$2,528	\$2,632	\$2,718	\$2,833	\$2,977	\$3,149	\$3,471	\$3,662	\$3,854	\$4,045	\$4,237	\$4,428
CT6036	\$2,543	\$2,862	\$2,967	\$3,107	\$3,238	\$3,348	\$3,491	\$3,672	\$3,889	\$4,295	\$4,535	\$4,777	\$5,019	\$5,259	\$5,501
CT7236	\$2,984	\$3,338	\$3,447	\$3,590	\$3,726	\$3,838	\$3,987	\$4,173	\$4,396	\$4,814	\$5,062	\$5,311	\$5,559	\$5,807	\$6,055
CT4842	\$2,314	\$2,605	\$2,701	\$2,829	\$2,949	\$3,048	\$3,180	\$3,345	\$3,542	\$3,912	\$4,132	\$4,352	\$4,572	\$4,792	\$5,012
CT6042	\$2,886	\$3,240	\$3,358	\$3,514	\$3,661	\$3,783	\$3,945	\$4,147	\$4,389	\$4,842	\$5,111	\$5,381	\$5,650	\$5,921	\$6,190
CT7242	\$3,011	\$3,373	\$3,493	\$3,654	\$3,805	\$3,930	\$4,095	\$4,303	\$4,551	\$5,016	\$5,294	\$5,569	\$5,846	\$6,123	\$6,400

CONNECT Banquette | 42" Back Height

Standard Features:

- Double Needle Stitching
- 3" Thick Foam Seat Cushion with Polyester Fiber Wrap for Comfort
- Feet: 1" Hard Plastic

- Option | Contrast Stitching (with double needle only): +\$79
- Option | Power (2 - USB & 1 - 110V) | Front Mounted: +\$250

***NOTE:** When specifying multiple fabrics please:

- Clearly identify which fabric is to be upholstered to the seat, back and arms.
- Use highest grade pricing of all fabric selected (i.e. if you choose E and J, use J grade for all).
- Please call customer service for yardage requirements.



CTPS4836



CTPS6036



CTPS7236



CTPS4842



CTPS6042



CTPS7242

MODEL	COVER	DESCRIPTION	DIMENSION	SH	SD	WT	YDS	CAL 133	MB
CTPS4836	Standard	Banquette Privacy Screen	28"d x 48"w x 60"h	19"	20"	-	11.25	+\$90/yd	+\$31/yd
CTPS6036	Standard	Banquette Privacy Screen	28"d x 60"w x 60"h	19"	20"	-	14.75	+\$90/yd	+\$31/yd
CTPS7236	Standard	Banquette Privacy Screen	28"d x 72"w x 60"h	19"	20"	-	15.00	+\$90/yd	+\$31/yd
CTPS4842	Standard	Banquette Tall Privacy Screen	28"d x 48"w x 60"h	19"	20"	-	12.25	+\$90/yd	+\$31/yd
CTPS6042	Standard	Banquette Tall Privacy Screen	28"d x 60"w x 60"h	19"	20"	-	15.75	+\$90/yd	+\$31/yd
CTPS7242	Standard	Banquette Tall Privacy Screen	28"d x 72"w x 60"h	19"	20"	-	16.00	+\$90/yd	+\$31/yd

MODEL	COM	A	B	C	D	E	F	G	H	I	J	K	L	M	N
CTPS4836	\$2,978	\$3,418	\$3,557	\$3,742	\$3,916	\$4,060	\$4,252	\$4,491	\$4,778	\$5,314	\$5,633	\$5,954	\$6,273	\$6,592	\$6,911
CTPS6036	\$3,440	\$4,040	\$4,222	\$4,465	\$4,693	\$4,881	\$5,133	\$5,446	\$5,822	\$6,526	\$6,944	\$7,363	\$7,782	\$8,201	\$8,619
CTPS7236	\$3,840	\$4,434	\$4,620	\$4,866	\$5,099	\$5,290	\$5,545	\$5,865	\$6,248	\$6,962	\$7,388	\$7,814	\$8,239	\$8,666	\$9,091
CTPS4842	\$3,206	\$3,688	\$3,840	\$4,042	\$4,231	\$4,387	\$4,596	\$4,857	\$5,169	\$5,753	\$6,101	\$6,448	\$6,796	\$7,144	\$7,491
CTPS6042	\$3,783	\$4,418	\$4,613	\$4,872	\$5,116	\$5,317	\$5,585	\$5,921	\$6,322	\$7,073	\$7,520	\$7,967	\$8,414	\$8,861	\$9,307
CTPS7242	\$3,940	\$4,610	\$4,808	\$5,071	\$5,319	\$5,523	\$5,795	\$6,136	\$6,544	\$7,307	\$7,760	\$8,215	\$8,669	\$9,123	\$9,578

DALTON STATEMENT OF LINE

Wedges



BG8501 | BG8501HT

Cubes



BG8502 | BG8502HT



BG8503 | BG8503HT



BG8504 | BG8504HT

Benches & Curves



BG8509



BG8510



BG90C-36D



BGARW



BGBEAN



BG8508 | BG8508HT

Chairs & Corners



BG8520BB



BG8530BB



BG90RCB



BG45CB

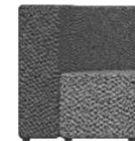

BGCRNR

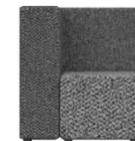

BGCRNS

Hubs



BGHUBTRI



BGHUBSQ

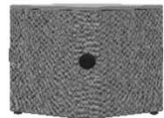

BGHUBSQT

Drums



BG8516DHT



BG8505 | BG8505HT



BG8506 | BG8506HT



BG8507 | BG8507HT

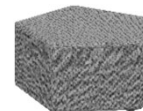

BGPEN20



BGHEX20

DALTON Ottoman | Wedge | Cubes | Benches



Standard Features:

- Double Needle Stitching
- Feet: 1" Hard Plastic
- HT Tops: 3/4" HPL (Choose finish - Natural, Light Cherry, Cherry, Dark Mocha, Stone, Walnut)
- PVC/T-Mold Edge to Match HT Top | See Table Tops Standard Laminate and Edges in Statement of Line



- Option | Contrast Stitching (with Double Needle Only): +\$79
 - Option | (4) 1" Low Profile Casters: +\$69
 - Option | Ganging Clip: +\$47
 - Option | Power (2 - USB & 1 - 110V)*: +\$250
- *End Mounted Cubes & Benches*

***NOTE:**

When specifying multiple fabrics please:
 Clearly identify which fabric is to be upholstered to the seat, back and arms.
 Use highest grade pricing of all fabric selected (i.e. if you choose E and J, use J grade for all).
 Please call customer service for yardage requirements.



BG8502



BG8502HT



BG8503



BG8503HT



BG8504



BG8504HT

MODEL	DESCRIPTION	DIMENSION	SH	SW	SD	WT	YDS	CAL 133	MB
BG8502	Cube Fabric Top	20"d x 20"w x 18.5"h	18.5"	-	-	25 lbs	2.00	+\$90/yd	+\$31/yd
BG8502HT	Cube HPL Top	20"d x 20"w x 17"h	17"	-	-	28 lbs	1.25	+\$90/yd	+\$31/yd
BG8503	Cube Fabric Top	28"d x 28"w x 18.5"h	18.5"	-	-	-	3.50	+\$90/yd	+\$31/yd
BG8503HT	Cube HPL Top	28"d x 28"w x 17"h	17"	-	-	-	2.50	+\$90/yd	+\$31/yd
BG8504	Cube Fabric Top	36"d x 36"w x 18.5"h	18.5"	-	-	52 lbs	3.50	+\$90/yd	+\$31/yd
BG8504HT	Cube HPL Top	36"d x 36"w x 17"h	17"	-	-	60 lbs	2.50	+\$90/yd	+\$31/yd

MODEL	COM	A	B	C	D	E	F	G	H	I	J	K	L	M	N
BG8502	\$836	\$926	\$950	\$983	\$1,014	\$1,040	\$1,074	\$1,117	\$1,168	\$1,262	\$1,319	\$1,376	\$1,433	\$1,490	\$1,546
BG8502HT	\$1,023	\$1,061	\$1,080	\$1,103	\$1,122	\$1,140	\$1,164	\$1,194	\$1,231	\$1,297	\$1,337	\$1,375	\$1,415	\$1,454	\$1,495
BG8503	\$878	\$1,045	\$1,088	\$1,146	\$1,200	\$1,245	\$1,305	\$1,379	\$1,469	\$1,635	\$1,734	\$1,834	\$1,933	\$2,032	\$2,132
BG8503HT	\$1,143	\$1,241	\$1,275	\$1,321	\$1,364	\$1,399	\$1,448	\$1,505	\$1,577	\$1,708	\$1,790	\$1,869	\$1,948	\$2,027	\$2,107
BG8504	\$1,199	\$1,359	\$1,403	\$1,461	\$1,514	\$1,560	\$1,619	\$1,693	\$1,783	\$1,950	\$2,049	\$2,148	\$2,247	\$2,347	\$2,447
BG8504HT	\$1,382	\$1,488	\$1,519	\$1,560	\$1,599	\$1,631	\$1,674	\$1,726	\$1,790	\$1,910	\$1,981	\$2,051	\$2,123	\$2,194	\$2,265

DALTON Ottoman | Wedge | Cubes | Benches

Standard Features:

- Double Needle Stitching
- Feet: 1" Hard Plastic
- HT Tops: 3/4" HPL (Choose finish - Natural, Light Cherry, Cherry, Dark Mocha, Stone, Walnut)
- PVC/T-Mold Edge to Match HT Top | See Table Tops Standard Laminate and Edges in Statement of Line

- Option | Contrast Stitching (with Double Needle Only): +\$79
- Option | (4) 1" Low Profile Casters: +\$69
- Option | Ganging Clip: +\$47
- Option | Power (2 - USB & 1 - 110V)*: +\$250
- *End Mounted Cubes & Benches*

***NOTE:**

When specifying multiple fabrics please:
 Clearly identify which fabric is to be upholstered to the seat, back and arms.
 Use highest grade pricing of all fabric selected (i.e. if you choose E and J, use J grade for all).
 Please call customer service for yardage requirements.

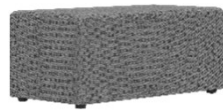

BG8509

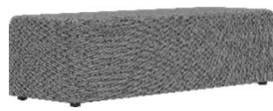

BG8510



BG8508



BG8508HT



BG8501



BG8501HT

MODEL	DESCRIPTION	DIMENSION	SH	SW	SD	WT	YDS	CAL 133	MB
BG8509	Bench Fabric Top	40"d x 20"w x 18.5"h	18.5"	-	-	-	2.50	+\$90/yd	+\$31/yd
BG8510	Bench Fabric Top	60"d x 20"w x 18.5"h	18.5"	-	-	-	3.50	+\$90/yd	+\$31/yd
BG8501	90° Wedge Fabric Top	20"d x 28"w x 18.5"h	18.5"	-	-	-	2.00	+\$90/yd	+\$31/yd
BG8501HT	90° Wedge HPL Top	20"d x 28"w x 17"h	17"	-	-	-	1.25	+\$90/yd	+\$31/yd
BG8508	Curve Fabric Top	42"d x 20"w x 18.5"h	18.5"	-	-	-	3.50	+\$90/yd	+\$31/yd
BG8508HT	Curve HPL Top	42"d x 20"w x 17"h	17"	-	-	-	2.00	+\$90/yd	+\$31/yd

MODEL	COM	A	B	C	D	E	F	G	H	I	J	K	L	M	N
BG8509	\$1,411	\$1,517	\$1,547	\$1,589	\$1,627	\$1,659	\$1,703	\$1,755	\$1,819	\$1,938	\$2,009	\$2,080	\$2,152	\$2,222	\$2,293
BG8510	\$1,655	\$1,807	\$1,851	\$1,909	\$1,962	\$2,008	\$2,067	\$2,141	\$2,231	\$2,398	\$2,497	\$2,596	\$2,695	\$2,795	\$2,895
BG8501	\$857	\$949	\$974	\$1,008	\$1,040	\$1,066	\$1,103	\$1,150	\$1,207	\$1,311	\$1,375	\$1,439	\$1,501	\$1,566	\$1,628
BG8501HT	\$1,086	\$1,130	\$1,146	\$1,167	\$1,187	\$1,203	\$1,226	\$1,257	\$1,291	\$1,357	\$1,396	\$1,437	\$1,476	\$1,516	\$1,555
BG8508	\$1,397	\$1,565	\$1,612	\$1,677	\$1,738	\$1,787	\$1,853	\$1,936	\$2,037	\$2,220	\$2,332	\$2,442	\$2,555	\$2,666	\$2,776
BG8508HT	\$1,677	\$1,738	\$1,765	\$1,801	\$1,835	\$1,866	\$1,903	\$1,951	\$2,007	\$2,112	\$2,177	\$2,238	\$2,302	\$2,366	\$2,430

DALTON Ottoman | Drum Tables

Standard Features:

- Double Needle Stitching
- Feet: 1" Hard Plastic
- HT Tops: 3/4" HPL (Choose finish - Natural, Light Cherry, Cherry, Dark Mocha, Stone, Walnut)
- PVC/T-Mold Edge to Match HT Top | See Table Tops Standard Laminate and Edges in Statement of Line



- Option | Contrast Stitching (with Double Needle Only): +\$79
- Option | (4) 1" Low Profile Casters: +\$69

***NOTE:**

When specifying multiple fabrics please:
 Clearly identify which fabric is to be upholstered to the seat, back and arms.
 Use highest grade pricing of all fabric selected (i.e. if you choose E and J, use J grade for all).
 Please call customer service for yardage requirements.



BG8516DHT



BG8505



BG8505HT



BG8506



BG8506HT



BG8507



BG8507HT

MODEL	DESCRIPTION	DIMENSION	SH	SW	SD	WT	YDS	CAL 133	MB
BG8516DHT	Drum HPL Top	16" dia x 16"h	16"	-	-	18 lbs	1.25	+\$90/yd	+\$31/yd
BG8505	Drum Fabric Top	20"dia x 18.5"h	18.5"	-	-	23 lbs	2.00	+\$90/yd	+\$31/yd
BG8505HT	Drum HPL Top	20"dia x 17"h	17"	-	-	-	1.25	+\$90/yd	+\$31/yd
BG8506	Drum Fabric Top	28"dia x 18.5"h	18.5"	-	-	40 lbs	2.25	+\$90/yd	+\$31/yd
BG8506HT	Drum HPL Top	28"dia x 17"h	17"	-	-	-	1.50	+\$90/yd	+\$31/yd
BG8507	Drum Fabric Top	36"dia x 18.5"h	18.5"	-	-	-	3.00	+\$90/yd	+\$31/yd
BG8507HT	Drum HPL Top	36"dia x 17"h	17"	-	-	55 lbs	1.75	+\$90/yd	+\$31/yd

MODEL

- BG8516DHT
- BG8505
- BG8505HT
- BG8506
- BG8506HT
- BG8507
- BG8507HT

MODEL	COM	A	B	C	D	E	F	G	H	I	J	K	L	M	N
BG8516DHT	\$992	\$1,039	\$1,054	\$1,076	\$1,095	\$1,112	\$1,135	\$1,164	\$1,200	\$1,267	\$1,307	\$1,346	\$1,386	\$1,424	\$1,465
BG8505	\$840	\$930	\$954	\$987	\$1,017	\$1,044	\$1,078	\$1,120	\$1,171	\$1,266	\$1,323	\$1,380	\$1,437	\$1,494	\$1,550
BG8505HT	\$1,038	\$1,088	\$1,103	\$1,125	\$1,145	\$1,161	\$1,184	\$1,210	\$1,243	\$1,309	\$1,348	\$1,388	\$1,427	\$1,467	\$1,508
BG8506	\$901	\$1,003	\$1,030	\$1,068	\$1,102	\$1,131	\$1,169	\$1,217	\$1,275	\$1,382	\$1,446	\$1,510	\$1,574	\$1,638	\$1,701
BG8506HT	\$1,120	\$1,179	\$1,197	\$1,223	\$1,245	\$1,265	\$1,291	\$1,323	\$1,361	\$1,432	\$1,475	\$1,518	\$1,560	\$1,602	\$1,646
BG8507	\$1,037	\$1,163	\$1,204	\$1,260	\$1,311	\$1,353	\$1,412	\$1,484	\$1,568	\$1,725	\$1,820	\$1,917	\$2,010	\$2,107	\$2,201
BG8507HT	\$1,231	\$1,334	\$1,356	\$1,387	\$1,414	\$1,438	\$1,468	\$1,506	\$1,553	\$1,639	\$1,690	\$1,741	\$1,793	\$1,844	\$1,895

DALTON Modular | Hubs & Benching

Standard Features:

- Double Needle Stitching
- Feet: 1" Hard Plastic
- HT Tops: 3/4" HPL (Choose finish - Natural, Light Cherry, Cherry, Dark Mocha, Stone)
- PVC/T-Mold Edge to Match HT Top | See Table Tops Standard Laminate and Edges in Statement of Line



- Option | Contrast Stitching (with Double Needle Only): +\$79
- Option | (4) 1" Low Profile Casters: +\$69
- Option | Ganging Clip: +\$47
- Option | Power (2 - USB & 1 - 110V)*: +\$250
- *End Mounted Cubes & Benches

***NOTE:**
 When specifying multiple fabrics please:
 Clearly identify which fabric is to be upholstered to the seat, back and arms.
 Use highest grade pricing of all fabric selected (i.e. if you choose E and J, use J grade for all).
 Please call customer service for yardage requirements.



BG20BB



BG30BB



BGCRNS
BGCRNSHT



BGCRNR
BGCRNRHT

MODEL	DESCRIPTION	DIMENSION	SH	SW	SD	WT	YDS	CAL 133	MB
BG20BB	Chair Armless	30"d x 20"w x 37"h	18.5"	20"	20"	50 lbs	4.50	+\$90/yd	+\$31/yd
BG30BB	Chair Armless Wide	30"d x 30"w x 37"h	18.5"	30"	20"	65 lbs	5.00	+\$90/yd	+\$31/yd
BGCRNS	Corner 90° Square	30"d x 30"w x 37"h	18.5"	20"	20"	85 lbs	5.25	+\$90/yd	+\$31/yd
BGCRNSHT	Corner 90° Square HPL Top	30"d x 30"w x 37"h	17"	20"	20"	-	5.25	+\$90/yd	+\$31/yd
BGCRNR	Corner 90° Wedge	30"d x 42"w x 37"h	18.5"	28"	20"	-	5.50	+\$90/yd	+\$31/yd
BGCRNRHT	Corner 90° Wedge HPL Top	30"d x 42"w x 37"h	17"	28"	20"	-	5.50	+\$90/yd	+\$31/yd

MODEL	COM	A	B	C	D	E	F	G	H	I	J	K	L	M	N
BG20BB	\$1,511	\$1,720	\$1,774	\$1,848	\$1,918	\$1,976	\$2,052	\$2,148	\$2,263	\$2,478	\$2,605	\$2,733	\$2,861	\$2,988	\$3,116
BG30BB	\$1,591	\$1,822	\$1,884	\$1,966	\$2,043	\$2,107	\$2,193	\$2,299	\$2,426	\$2,665	\$2,807	\$2,949	\$3,091	\$3,232	\$3,375
BGCRNS	\$1,742	\$1,984	\$2,057	\$2,154	\$2,243	\$2,319	\$2,417	\$2,543	\$2,693	\$2,969	\$3,135	\$3,301	\$3,468	\$3,635	\$3,801
BGCRNSHT	\$2,409	\$2,642	\$2,715	\$2,813	\$2,901	\$2,976	\$3,075	\$3,202	\$3,352	\$3,627	\$3,793	\$3,960	\$4,126	\$4,294	\$4,459
BGCRNR	\$1,190	\$1,462	\$1,532	\$1,626	\$1,713	\$1,789	\$1,893	\$2,025	\$2,181	\$2,471	\$2,644	\$2,819	\$2,993	\$3,169	\$3,342
BGCRNRHT	\$1,519	\$1,778	\$1,853	\$1,956	\$2,049	\$2,128	\$2,231	\$2,364	\$2,520	\$2,809	\$2,984	\$3,157	\$3,332	\$3,507	\$3,682

DALTON Modular | Curves & Table



Standard Features:

- Double Needle Stitching
- Feet: 1" Hard Plastic
- HT Tops: 3/4" HPL (Choose finish - Natural, Light Cherry, Cherry, Dark Mocha, Stone)
- PVC/T-Mold Edge to Match HT Top | See Table Tops Standard Laminate and Edges in Statement of Line

- Option | Contrast Stitching (with Double Needle Only): +\$79
- Option | (4) 1" Low Profile Casters: +\$69
- Option | Ganging Clip: +\$47

***NOTE:**

When specifying multiple fabrics please:
 Clearly identify which fabric is to be upholstered to the seat, back and arms.
 Use highest grade pricing of all fabric selected (i.e. if you choose E and J, use J grade for all).
 Please call customer service for yardage requirements.



BG45CB



BG90C-36D



BG90RCB

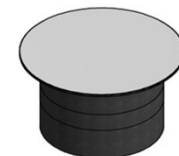

BGTBL48

MODEL	DESCRIPTION	DIMENSION	SH	SW	SD	WT	YDS	CAL 133	MB
BG45CB	Curve 45° Inside	32"d x 45.5"w x 37"h	18.5"	38"	20"	70 lbs	7.00	+\$90/yd	+\$31/yd
BG90C-36D	Curve 90° Inside	25.5 x 54.5"w x 18.5"h	18.5"	54.5"	20"	-	6.00	+\$90/yd	+\$31/yd
BG90RCB	Curve 90° Outside	35.5"d x 70.5"w x 37"h	18.5"	70.5"	20"	-	8.00	+\$90/yd	+\$31/yd
BGTBL48	Table Pedstal HPL Top	48"dia x 30"h	-	-	-	-	3.25	+\$90/yd	+\$31/yd

MODEL

MODEL	COM	A	B	C	D	E	F	G	H	I	J	K	L	M	N
BG45CB	\$1,809	\$2,139	\$2,235	\$2,365	\$2,485	\$2,586	\$2,717	\$2,885	\$3,084	\$3,451	\$3,672	\$3,895	\$4,118	\$4,342	\$4,563
BG90C-36D	\$1,620	\$1,902	\$1,984	\$2,095	\$2,197	\$2,284	\$2,398	\$2,540	\$2,711	\$3,026	\$3,216	\$3,407	\$3,596	\$3,788	\$3,978
BG90RCB	\$2,132	\$2,510	\$2,619	\$2,766	\$2,903	\$3,018	\$3,171	\$3,360	\$3,588	\$4,008	\$4,263	\$4,516	\$4,769	\$5,023	\$5,276
BGTBL48	\$1,316	\$1,462	\$1,502	\$1,555	\$1,606	\$1,648	\$1,703	\$1,772	\$1,855	\$2,010	\$2,103	\$2,194	\$2,286	\$2,379	\$2,471

DALTON Modular | Hubs

Standard Features:

- Double Needle Stitching
- Feet: 1" Hard Plastic
- HT Tops: 3/4" HPL (Choose finish - Natural, Light Cherry, Cherry, Dark Mocha, Stone)
- PVC/T-Mold Edge to Match HT Top | See Table Tops Standard Laminate and Edges in Statement of Line

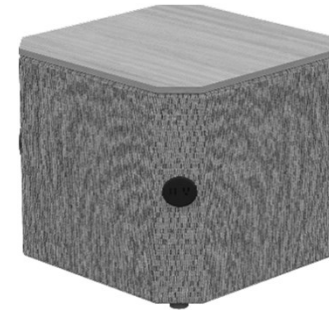

- Option | Contrast Stitching (with Double Needle Only): +\$79
- Option | (4) 1" Low Profile Casters: +\$69
- Option | Ganging Clip: +\$47
- Option | Power (2 - USB & 1 - 110V) ea*: +\$250

**Power Units Placed on Beveled Edges as Pictured*



BGHUBTRI

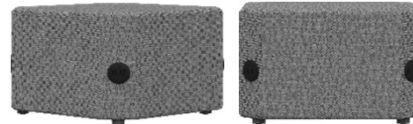

BGHUBSQ



BGHUBSQT

MODEL	DESCRIPTION	DIMENSION	SH	SW	SD	WT	YDS	CAL 133	MB
BGHUBTRI	Hub Triangle HPL Top	21.5"d x 25"w x 18.5"h	18.5"h	-	-	-	3.00	+\$90/yd	+\$31/yd
BGHUBSQ	Hub Square HPL Top	27"d x 27"w x 18.5"h	18.5"h	-	-	-	3.00	+\$90/yd	+\$31/yd
BGHUBSQT	Tall Hub Square HPL Top	27"d x 27"w x 26.5"h	26.5"h	-	-	-	3.50	+\$90/yd	+\$31/yd

MODEL

MODEL	COM	A	B	C	D	E	F	G	H	I	J	K	L	M	N
BGHUBTRI	\$1,180	\$1,301	\$1,338	\$1,388	\$1,433	\$1,472	\$1,524	\$1,587	\$1,664	\$1,806	\$1,892	\$1,977	\$2,062	\$2,147	\$2,233
BGHUBSQ	\$1,290	\$1,425	\$1,467	\$1,522	\$1,574	\$1,616	\$1,674	\$1,745	\$1,830	\$1,989	\$2,082	\$2,179	\$2,274	\$2,369	\$2,463
BGHUBSQT	\$1,495	\$1,651	\$1,700	\$1,765	\$1,826	\$1,875	\$1,942	\$2,026	\$2,124	\$2,308	\$2,418	\$2,530	\$2,642	\$2,752	\$2,864

DALTON Modular | Arrow | Pentagon | Hexagon

Standard Features:

- Double Needle Stitching
- Feet: 1" Hard Plastic

- Option | Contrast Stitching (with Double Needle Only): +\$79
- Option | (4) 1" Low Profile Casters: +\$69
- Option | Ganging Clip: +\$47
- Option | Power (2 - USB & 1 - 110V) ea: +\$250



BGARW



BGPEN20



BGHEX20

MODEL	DESCRIPTION	DIMENSION	SH	SW	SD	WT	YDS	CAL 133	MB
BGARW	Bench 45° Arrow	49.5"d x 20"d x 18.5"h	18.5"h	-	20"	-	3.00	+\$90/yd	+\$31/yd
BGBEAN	Bench Curved	68.5"d x 23"w x 18.5"h	18.5"h	-	23"d	48 lbs	4.50	+\$90/yd	+\$31/yd
BGPEN20	Ottoman Pentagon	29"d x 34"w x 18.5"h	18.5"h	-	-	-	3.00	+\$90/yd	+\$31/yd
BGHEX20	Ottoman Hexagon	17.75"d x 20"w x 18.5"h	18.5"h	-	-	-	2.25	+\$90/yd	+\$31/yd

MODEL

MODEL	COM	A	B	C	D	E	F	G	H	I	J	K	L	M	N
BGARW	\$1,355	\$1,488	\$1,525	\$1,575	\$1,620	\$1,659	\$1,710	\$1,774	\$1,851	\$1,993	\$2,079	\$2,164	\$2,249	\$2,334	\$2,420
BGBEAN	\$1,763	\$1,967	\$2,022	\$2,096	\$2,165	\$2,223	\$2,300	\$2,396	\$2,511	\$2,725	\$2,853	\$2,980	\$3,108	\$3,236	\$3,363
BGPEN20	\$1,118	\$1,254	\$1,291	\$1,341	\$1,387	\$1,425	\$1,477	\$1,541	\$1,617	\$1,760	\$1,845	\$1,931	\$2,015	\$2,100	\$2,186
BGHEX20	\$895	\$997	\$1,024	\$1,062	\$1,096	\$1,126	\$1,163	\$1,211	\$1,269	\$1,376	\$1,440	\$1,504	\$1,568	\$1,632	\$1,696

EMMA Chair | Settee | Sofa



Standard Features:

- Single Needle Stitching
- 5" Thick Foam Seat Cushion with Polyester Fiber Wrap for Comfort
- Seat Cushion Clipped to Chair Using "D" Ring Elastic Ties and Spring Clips
- Feet: Block Leg Tapered 4 Sides | Choose Finish - Natural, Light Cherry, Cherry, Dark Mocha, Stone

Option | Double Needle Stitching:

- Chair: +\$184
- Settee: +\$220
- Sofa: +\$282

Option | Contrast stitching (with double needle only): +\$79

***NOTE:**

When specifying multiple fabrics please:

- Clearly identify which fabric is to be upholstered to the seat, back and arms.
- Use highest grade pricing of all fabric selected (i.e. if you choose E and J, use J grade for all).
- Please call customer service for yardage requirements.



SF7511

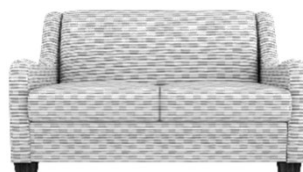

SF7512

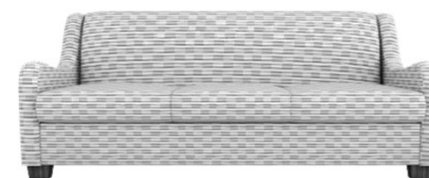

SF7513

MODEL	COVER	DESCRIPTION	DIMENSION	AH	SH	SW	SD	WT	YDS	CAL 133	MB
SF7511	Standard	Chair	33"d x 32.5"w x 38"h	24.5"	18.5"	24.25"	22.25"	114 lbs	7.00	+\$90/yd	+\$31/yd
SF7512	Standard	Settee	33"d x 57.5"w x 38"h	24.5"	18.5"	49.5"	22.25"	130 lbs	10.00	+\$90/yd	+\$31/yd
SF7513	Standard	Sofa	33"d x 83.5"w x 38"h	24.5"	18.5"	74.25"	22.25"	165 lbs	13.00	+\$90/yd	+\$31/yd

MODEL

	COM	A	B	C	D	E	F	G	H	I	J	K	L	M	N
SF7511	\$2,478	\$2,800	\$2,887	\$3,002	\$3,110	\$3,200	\$3,319	\$3,468	\$3,647	\$3,980	\$4,180	\$4,378	\$4,576	\$4,775	\$4,974
SF7512	\$3,023	\$3,491	\$3,614	\$3,778	\$3,933	\$4,061	\$4,232	\$4,444	\$4,700	\$5,176	\$5,460	\$5,744	\$6,028	\$6,312	\$6,595
SF7513	\$3,439	\$4,054	\$4,215	\$4,429	\$4,630	\$4,796	\$5,018	\$5,295	\$5,626	\$6,245	\$6,615	\$6,983	\$7,352	\$7,722	\$8,090

JOANNA Chair | Settee | Sofa



Standard Features:

- Double Needle Stitching or Welt Cord
- 6" Thick Foam Seat Cushion with Polyester Fiber Wrap for Comfort
- Seat Cushion Clipped to Chair Using "D" Ring Elastic Ties and Spring Clips
- Feet: Block Leg Tapered 4 Sides | Choose Finish - Natural, Light Cherry, Cherry, Dark Mocha, Stone

***NOTE:**

When specifying multiple fabrics please:
 Clearly identify which fabric is to be upholstered to the seat, back and arms.
 Use highest grade pricing of all fabric selected (i.e. if you choose E and J, use J grade for all).
 Please call customer service for yardage requirements.

Option | Contrast stitching (with double needle only): +\$79
 Not available on SF7501W, SF7502W or SF7503W



SF7501



SF7502



SF7503

MODEL	COVER	DESCRIPTION	DIMENSION	AH	SH	SW	SD	WT	YDS	CAL 133	MB
SF7501	Standard	Chair	33"d x 33"w x 31"h	21"	19"	22.5"	20.5"	105 lbs	6.25	+\$90/yd	+\$31/yd
SF7501W	Standard	Chair Welt Cord	33"d x 33"w x 31"h	21"	19"	22.5"	20.5"	-	6.25	+\$90/yd	+\$31/yd
SF7502	Standard	Settee	33"d x 55"w x 31"h	21"	19"	45"	20.5"	119 lbs	8.50	+\$90/yd	+\$31/yd
SF7502W	Standard	Settee Welt Cord	33"d x 55"w x 31"h	21"	19"	45"	20.5"	120 lbs	8.50	+\$90/yd	+\$31/yd
SF7503	Standard	Sofa	33"d x 78"w x 31"h	21"	19"	65.5"	20.5"	-	11.00	+\$90/yd	+\$31/yd
SF7503W	Standard	Sofa Welt Cord	33"d x 78"w x 31"h	21"	19"	65.5"	20.5"	-	11.00	+\$90/yd	+\$31/yd

MODEL

MODEL	COM	A	B	C	D	E	F	G	H	I	J	K	L	M	N
SF7501	\$2,464	\$2,758	\$2,837	\$2,943	\$3,042	\$3,125	\$3,235	\$3,371	\$3,536	\$3,843	\$4,025	\$4,208	\$4,391	\$4,573	\$4,757
SF7501W	\$2,384	\$2,679	\$2,758	\$2,864	\$2,963	\$3,047	\$3,156	\$3,297	\$3,475	\$3,804	\$4,001	\$4,199	\$4,395	\$4,592	\$4,791
SF7502	\$3,000	\$3,406	\$3,513	\$3,658	\$3,792	\$3,905	\$4,053	\$4,240	\$4,462	\$4,881	\$5,128	\$5,378	\$5,626	\$5,874	\$6,122
SF7502W	\$2,923	\$3,329	\$3,436	\$3,581	\$3,717	\$3,829	\$3,977	\$4,164	\$4,386	\$4,804	\$5,052	\$5,301	\$5,550	\$5,809	\$6,079
SF7503	\$3,405	\$3,919	\$4,054	\$4,236	\$4,405	\$4,547	\$4,734	\$4,967	\$5,248	\$5,772	\$6,085	\$6,397	\$6,709	\$7,022	\$7,334
SF7503W	\$3,333	\$3,734	\$3,863	\$4,035	\$4,222	\$4,360	\$4,543	\$4,773	\$5,048	\$5,598	\$5,910	\$6,223	\$6,534	\$6,846	\$7,159

JULIA STATEMENT OF LINE



Tables | Ottoman

Table | Arm Module

JULIA LOW BACK STATEMENT OF LINE



JULIA CHAIRS | CORNER | MODULES



Standard Features:

- Single Needle Stitching
- Seat and Back Cushions Includes Polyester Fiber Wrap for Added Comfort
- Feet: Wood or Metal Cylinder
 - Wood finish - Natural, Light Cherry, Cherry, Dark Mocha, Stone, Walnut | Metal Cylinder Leg silver or black
- Ganging clip

- Option | Double needle stitching: +\$95
- Option | Contrast stitching (with double needle only): +\$79
- Option | Plinth base (black): +\$315
 - Chair, settee, sofa and benches only:*
- Option | Tablet arm (bolted to underside of chair): +\$524
- Option | Power (2 - USB & 1 - 110V) | Front mounted: +\$250

***NOTE:**

When specifying multiple fabrics please:
 Clearly identify which fabric is to be upholstered to the seat, back and arms.
 Use highest grade pricing of all fabric selected (i.e. if you choose E and J, use J grade for all).
 Please call customer service for yardage requirements.

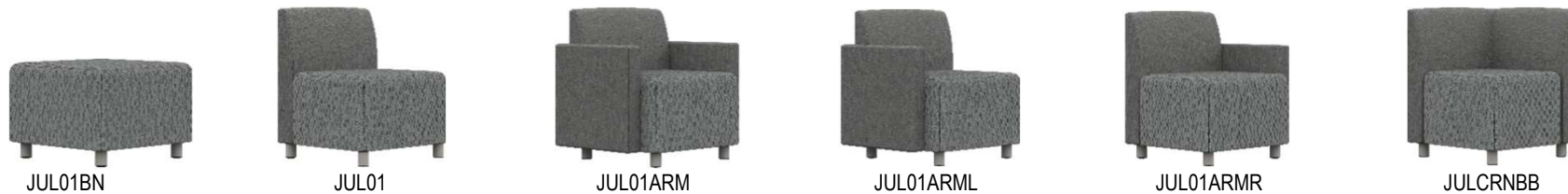

MODEL	COVER	DESCRIPTION	DIMENSION	SH	SW	SD	YDS	CAL 133	MB
JUL01BN	Standard	1 Seat Bench	24"d x 23.5"w x 18"h	18"	23.5"	24"	2.00	+\$90/yd	+\$31/yd
JUL01	Standard	Chair Armless	24"d x 23.5"w x 32"h	18"	23.5"	19"	4.00	+\$90/yd	+\$31/yd
JUL01ARM	Standard	Armchair	24"d x 30.5"w x 32"h	18"	23.5"	19"	7.00	+\$90/yd	+\$31/yd
JUL01ARML	Standard	Chair Left Arm Module	24"d x 27"w x 32"h	18"	23.5"	19"	5.50	+\$90/yd	+\$31/yd
JUL01ARMR	Standard	Chair Right Arm Module	24"d x 27"w x 32"h	18"	23.5"	19"	5.50	+\$90/yd	+\$31/yd
JULCRNBB	Standard	Corner Chair	24"d x 23.5"w x 32"h	18"	23.5"	19"	6.50	+\$90/yd	+\$31/yd

MODEL	COM	A	B	C	D	E	F	G	H	I	J	K	L	M	N
JUL01BN	\$1,349	\$1,432	\$1,456	\$1,489	\$1,520	\$1,546	\$1,581	\$1,623	\$1,674	\$1,769	\$1,826	\$1,883	\$1,940	\$1,997	\$2,052
JUL01	\$1,569	\$1,750	\$1,799	\$1,866	\$1,927	\$1,978	\$2,047	\$2,132	\$2,234	\$2,424	\$2,538	\$2,652	\$2,765	\$2,879	\$2,992
JUL01ARM	\$2,625	\$2,952	\$3,041	\$3,158	\$3,269	\$3,361	\$3,482	\$3,635	\$3,818	\$4,158	\$4,370	\$4,588	\$4,807	\$5,023	\$5,241
JUL01ARML	\$2,081	\$2,333	\$2,400	\$2,491	\$2,576	\$2,646	\$2,740	\$2,857	\$2,998	\$3,260	\$3,416	\$3,572	\$3,728	\$3,884	\$4,041
JUL01ARMR	\$2,081	\$2,333	\$2,400	\$2,491	\$2,576	\$2,646	\$2,740	\$2,857	\$2,998	\$3,260	\$3,416	\$3,572	\$3,728	\$3,884	\$4,041
JULCRNBB	\$2,011	\$2,315	\$2,394	\$2,502	\$2,602	\$2,685	\$2,796	\$2,935	\$3,100	\$3,410	\$3,595	\$3,778	\$3,963	\$4,148	\$4,332

JULIA 2 SEAT SOFA | BENCHES | MODULES

Standard Features:

- Single Needle Stitching
- Seat and Back Cushions Includes Polyester Fiber Wrap for Added Comfort
- Feet: Wood or Metal Cylinder
 - Wood finish - Natural, Light Cherry, Cherry, Dark Mocha, Stone, Walnut | Metal Cylinder Leg silver or black
- Ganging clip



- Option | Double needle stitching | JUL02 Units: +\$142
- Option | Contrast stitching (with double needle only): +\$79
- Option | Plinth base (black): +\$315
- Chair, settee, sofa and benches only:*
- Option | Tablet arm (bolted to underside of chair): +\$524
- Option | Power (2 - USB & 1 - 110V) | Front mounted: +\$250

***NOTE:**
 When specifying multiple fabrics please:
 Clearly identify which fabric is to be upholstered to the seat, back and arms.
 Use highest grade pricing of all fabric selected (i.e. if you choose E and J, use J grade for all).
 Please call customer service for yardage requirements.



MODEL	COVER	DESCRIPTION	DIMENSION	SH	SW	SD	YDS	CAL 133	MB
JUL02BN	Standard	2 Seat Bench	24"d x 47"w x 18"h	18"	47"	24"	4.00	+\$90/yd	+\$31/yd
JUL02	Standard	Settee Armless	24"d x 47"w x 32"h	18"	47"	19"	6.00	+\$90/yd	+\$31/yd
JUL02ARM	Standard	Settee with Arms	24"d x 54"w x 32"h	18"	47"	19"	9.00	+\$90/yd	+\$31/yd
JUL02ARML	Standard	Settee Left Arm Module	24"d x 50.5" x 32"h	18"	47"	19"	7.50	+\$90/yd	+\$31/yd
JUL02ARMR	Standard	Settee Right Arm Module	24"d x 50.5" x 32"h	18"	47"	19"	7.50	+\$90/yd	+\$31/yd

MODEL	COM	A	B	C	D	E	F	G	H	I	J	K	L	M	N
JUL02BN	\$1,535	\$1,718	\$1,767	\$1,834	\$1,895	\$1,946	\$2,015	\$2,100	\$2,202	\$2,392	\$2,506	\$2,620	\$2,733	\$2,847	\$2,960
JUL02	\$2,038	\$2,316	\$2,390	\$2,489	\$2,581	\$2,659	\$2,760	\$2,888	\$3,042	\$3,327	\$3,498	\$3,668	\$3,838	\$4,009	\$4,179
JUL02ARM	\$3,049	\$3,466	\$3,577	\$3,725	\$3,864	\$3,979	\$4,133	\$4,323	\$4,554	\$4,982	\$5,238	\$5,493	\$5,748	\$6,005	\$6,260
JUL02ARML	\$2,562	\$2,910	\$3,002	\$3,125	\$3,242	\$3,337	\$3,465	\$3,625	\$3,816	\$4,174	\$4,386	\$4,599	\$4,812	\$5,026	\$5,238
JUL02ARMR	\$2,562	\$2,910	\$3,002	\$3,125	\$3,242	\$3,337	\$3,465	\$3,625	\$3,816	\$4,174	\$4,386	\$4,599	\$4,812	\$5,026	\$5,238

JULIA 3 SEAT SOFA | BENCHES | MODULES

Standard Features:

- Single Needle Stitching
- Seat and Back Cushions Includes Polyester Fiber Wrap for Added Comfort
- Feet: Wood or Metal Cylinder
 - Wood finish - Natural, Light Cherry, Cherry, Dark Mocha, Stone, Walnut | Metal Cylinder Leg silver or black
- Ganging clip



- Option | Double needle stitching | JUL03 Units: +\$184
- Option | Contrast stitching (with double needle only): +\$79
- Option | Plinth base (black): +\$315
 - Chair, settee, sofa and benches only:*
- Option | Tablet arm (bolted to underside of chair): +\$524
- Option | Power (2 - USB & 1 - 110V) | Front mounted: +\$250

***NOTE:**

When specifying multiple fabrics please:
 Clearly identify which fabric is to be upholstered to the seat, back and arms.
 Use highest grade pricing of all fabric selected (i.e. if you choose E and J, use J grade for all).
 Please call customer service for yardage requirements.



MODEL	COVER	DESCRIPTION	DIMENSION	SH	SW	SD	YDS	CAL 133	MB
JUL03BN	Standard	3 Seat Bench	24"d x 70.5"w x 18"h	18"	74"	24"	5.00	+\$90/yd	+\$31/yd
JUL03	Standard	Sofa Armless	24"d x 70.5"w x 32"h	18"	74"	19"	8.00	+\$90/yd	+\$31/yd
JUL03ARM	Standard	Sofa with Arms	24"d x 77.5"w x 32"h	18"	74"	19"	11.00	+\$90/yd	+\$31/yd
JUL03ARML	Standard	Sofa Left Arm Module	24"d x 74"w x 32"h	18"	74"	19"	9.50	+\$90/yd	+\$31/yd
JUL03ARMR	Standard	Sofa Right Arm Module	24"d x 74"w x 32"h	18"	74"	19"	9.50	+\$90/yd	+\$31/yd

MODEL

MODEL	COM	A	B	C	D	E	F	G	H	I	J	K	L	M	N
JUL03BN	\$1,867	\$2,096	\$2,157	\$2,239	\$2,317	\$2,381	\$2,466	\$2,572	\$2,700	\$2,938	\$3,081	\$3,222	\$3,365	\$3,506	\$3,648
JUL03	\$2,536	\$2,909	\$3,008	\$3,140	\$3,263	\$3,366	\$3,501	\$3,672	\$3,876	\$4,257	\$4,484	\$4,712	\$4,939	\$5,166	\$5,393
JUL03ARM	\$3,550	\$4,062	\$4,198	\$4,379	\$4,549	\$4,690	\$4,877	\$5,111	\$5,392	\$5,916	\$6,228	\$6,541	\$6,853	\$7,165	\$7,478
JUL03ARML	\$2,742	\$3,186	\$3,319	\$3,491	\$3,655	\$3,791	\$3,970	\$4,198	\$4,468	\$4,967	\$5,268	\$5,571	\$5,871	\$6,174	\$6,475
JUL03ARMR	\$2,742	\$3,186	\$3,319	\$3,491	\$3,655	\$3,791	\$3,970	\$4,198	\$4,468	\$4,967	\$5,268	\$5,571	\$5,871	\$6,174	\$6,475

JULIA 30° WEDGES | 38° CURVES

Standard Features:

- Single Needle Stitching
- Seat and Back Cushions Includes Polyester Fiber Wrap for Added Comfort
- Feet: Wood or Metal Cylinder
- Wood finish - Natural, Light Cherry, Cherry, Dark Mocha, Stone, Walnut | Metal Cylinder Leg silver or black
- Ganging clip



- Option | Double needle stitching | 30° or 38° Units: +\$95
- Option | Contrast stitching (with double needle only): +\$79
- Option | Tablet arm (bolted to underside of chair): +\$524
- Option | Power (2 - USB & 1 - 110V) | Front mounted: +\$250

***NOTE:**

When specifying multiple fabrics please:
 Clearly identify which fabric is to be upholstered to the seat, back and arms.
 Use highest grade pricing of all fabric selected (i.e. if you choose E and J, use J grade for all).
 Please call customer service for yardage requirements.



MODEL	COVER	DESCRIPTION	DIMENSION	SH	SW	SD	YDS	CAL 133	MB
JUL30W	Standard	30° Wedge Bench	24"d x 29"w x 18"	18"	29"	24"	3.00	+\$90/yd	+\$31/yd
JUL30WB	Standard	30° Wedge with Back	24"d x 29"w x 32"h	18"	29"	19"	4.50	+\$90/yd	+\$31/yd
JUL38WB	Standard	38° Wedge with Back	24"d x 32.5"w x 32"h	18"	32.5"	19"	4.50	+\$90/yd	+\$31/yd
JUL38C	Standard	38° Curve Bench	24"d x 32.5"w x 18"h	18"	32.5"	24"	2.00	+\$90/yd	+\$31/yd
JUL38CB	Standard	38° Inside Curve with Back	24"d x 32.5"w x 32"h	18"	32.5"	19"	4.00	+\$90/yd	+\$31/yd
JUL38RCB	Standard	38° Outside Curve with Back	24"d x 37.75"w x 32"h	18"	37.75"	19"	4.00	+\$90/yd	+\$31/yd

MODEL	COM	A	B	C	D	E	F	G	H	I	J	K	L	M	N
JUL30W	\$1,160	\$1,298	\$1,334	\$1,384	\$1,430	\$1,469	\$1,520	\$1,584	\$1,660	\$1,803	\$1,888	\$1,974	\$2,058	\$2,144	\$2,229
JUL30WB	\$1,606	\$1,813	\$1,868	\$1,942	\$2,011	\$2,070	\$2,146	\$2,242	\$2,357	\$2,571	\$2,699	\$2,827	\$2,954	\$3,082	\$3,337
JUL38WB	\$1,720	\$1,926	\$1,981	\$2,055	\$2,124	\$2,182	\$2,259	\$2,355	\$2,470	\$2,684	\$2,812	\$2,939	\$3,067	\$3,195	\$3,322
JUL38C	\$1,264	\$1,351	\$1,375	\$1,410	\$1,441	\$1,468	\$1,503	\$1,546	\$1,599	\$1,695	\$1,754	\$1,812	\$1,870	\$1,933	\$1,994
JUL38CB	\$1,826	\$1,999	\$2,055	\$2,127	\$2,194	\$2,250	\$2,324	\$2,417	\$2,530	\$2,735	\$2,860	\$2,986	\$3,109	\$3,235	\$3,358
JUL38RCB	\$1,842	\$2,017	\$2,072	\$2,143	\$2,210	\$2,266	\$2,342	\$2,433	\$2,546	\$2,750	\$2,877	\$3,001	\$3,124	\$3,249	\$3,374

JULIA 60° CURVES

Standard Features:

- Single Needle Stitching
- Seat and Back Cushions Includes Polyester Fiber Wrap for Added Comfort
- Feet: Wood or Metal Cylinder
 - Wood finish - Natural, Light Cherry, Cherry, Dark Mocha, Stone, Walnut
 - Metal finish - Silver or Black
- Ganging clip



- Option | Double needle stitching | 60° Units: +\$142
- Option | Contrast stitching (with double needle only): +\$79
- Option | Tablet arm (bolted to underside of chair): +\$524

***NOTE:**

When specifying multiple fabrics please:
 Clearly identify which fabric is to be upholstered to the seat, back and arms.
 Use highest grade pricing of all fabric selected (i.e. if you choose E and J, use J grade for all).
 Please call customer service for yardage requirements.



MODEL	COVER	DESCRIPTION	DIMENSION	SH	SW	SD	YDS	CAL 133	MB
JUL45C	Standard	45° Curve Bench	24"d x 42"w x 32"h	18"	42"	19"	2.75	+\$90/yd	+\$31/yd
JUL45CB	Standard	45° Inside Curve with Back	24"d x 42"w x 32"h	18"	42"	19"	5.50	+\$90/yd	+\$31/yd
JUL60C	Standard	60° Curve Bench	24"d x 56.5"w x 18"h	18"	56.5"	24"	4.00	+\$90/yd	+\$31/yd
JUL60CB	Standard	60° Inside Curve with Back	24"d x 56" x 32"h	18"	56"	19"	6.50	+\$90/yd	+\$31/yd
JUL60RCB	Standard	60° Outside Curve with Back	24"d x 56" x 32"h	18"	56"	19"	6.50	+\$90/yd	+\$31/yd

MODEL	COM	A	B	C	D	E	F	G	H	I	J	K	L	M	N
JUL45C	\$1,622	\$1,739	\$1,772	\$1,818	\$1,860	\$1,895	\$1,942	\$2,001	\$2,071	\$2,202	\$2,280	\$2,358	\$2,437	\$2,514	\$2,593
JUL45CB	\$2,109	\$2,361	\$2,429	\$2,520	\$2,604	\$2,675	\$2,768	\$2,886	\$3,026	\$3,288	\$3,444	\$3,601	\$3,757	\$3,913	\$4,069
JUL60C	\$1,791	\$1,970	\$2,019	\$2,086	\$2,147	\$2,198	\$2,267	\$2,352	\$2,454	\$2,644	\$2,758	\$2,872	\$2,985	\$3,099	\$3,212
JUL60CB	\$2,152	\$2,454	\$2,534	\$2,641	\$2,741	\$2,824	\$2,935	\$3,074	\$3,239	\$3,549	\$3,734	\$3,918	\$4,102	\$4,287	\$4,472
JUL60RCB	\$2,270	\$2,570	\$2,650	\$2,757	\$2,857	\$2,941	\$3,051	\$3,190	\$3,356	\$3,666	\$3,850	\$4,034	\$4,218	\$4,403	\$4,588

JULIA TABLES | OTTOMAN

Standard Features:

- Single Needle Stitching
- Tops when Laminate: 3/4" HPL (Choose finish - Natural, Light Cherry, Cherry, Dark Mocha, Stone)
- PVC/T-Mold edge to match | See Table Tops Standard Laminate and Edges in Statement of Line
- Feet: JULDFT, DHT & PEDFT to be 1"H High-Impact Plastic
- Feet: JUL36DHT & JULARMT to be 3"H Wood or Metal Cylinder
- Wood Finish - Natural, Light Cherry, Cherry, Dark Mocha, Stone, Walnut | Metal Finish Black or Silver)
- Ganging Clip



- Option | Double Needle Stitching: +\$142
- Option | Contrast Stitching (with Double Needle Only): +\$79
- Option | Power (2 - USB & 1 - 110V)*: +\$250
- *Top mounted in HPL



JULARMT



JULARMT-POW



JUL18DFT



JUL18DHT



JUL18PEDFT

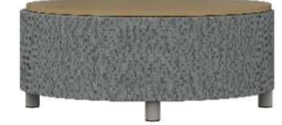

JUL36DHT

MODEL	COVER	DESCRIPTION	DIMENSION	SH	SW	SD	YDS	CAL 133	MB
JULARMT	Standard	Arm HPL	21.5"d x 10"w x 23.75"h	23.75"	10"	18"	1.50	+\$90/yd	+\$31/yd
JULARMT-POW	Standard	Arm HPL Power	21.5"d x 10"w x 23.75"h	23.75"	10"	18"	1.50	+\$90/yd	+\$31/yd
JUL18DFT	Standard	Ottoman with Fabric Top	18" dia x 18"h	18"	-	-	2.00	+\$90/yd	+\$31/yd
JUL18DHT	Standard	Ottoman with HPL Top	18" dia x 18"h	18"	-	-	1.25	+\$90/yd	+\$31/yd
JUL18PEDFT	Standard	Ottoman Nesting	18" dia x 18"h	18"	-	-	2.00	+\$90/yd	+\$31/yd
JUL36DHT	Standard	Table with HPL Top	36" dia x 16"h	18"	-	-	1.75	+\$90/yd	+\$31/yd

MODEL

MODEL	COM	A	B	C	D	E	F	G	H	I	J	K	L	M	N
JULARMT	\$1,063	\$1,126	\$1,145	\$1,171	\$1,197	\$1,220	\$1,247	\$1,283	\$1,326	\$1,407	\$1,453	\$1,500	\$1,549	\$1,596	\$1,643
JULARMT-POW	\$1,323	\$1,383	\$1,403	\$1,431	\$1,457	\$1,478	\$1,505	\$1,542	\$1,586	\$1,665	\$1,713	\$1,758	\$1,807	\$1,854	\$1,902
JUL18DFT	\$723	\$816	\$840	\$873	\$903	\$930	\$964	\$1,006	\$1,057	\$1,152	\$1,209	\$1,266	\$1,323	\$1,380	\$1,436
JUL18DHT	\$903	\$955	\$973	\$996	\$1,015	\$1,034	\$1,057	\$1,087	\$1,122	\$1,190	\$1,229	\$1,268	\$1,308	\$1,347	\$1,388
JUL18PEDFT	\$661	\$756	\$781	\$814	\$845	\$873	\$907	\$949	\$1,001	\$1,097	\$1,154	\$1,212	\$1,270	\$1,327	\$1,388
JUL36DHT	\$1,534	\$1,601	\$1,623	\$1,652	\$1,679	\$1,701	\$1,731	\$1,769	\$1,813	\$1,896	\$1,946	\$1,995	\$2,046	\$2,095	\$2,145

JULIA - LOW BACK

Standard Features:

- Single Needle Stitching
- Seat and Back Cushions Includes Polyester Fiber Wrap for Added Comfort
- Feet: Wood or Metal Cylinder
 - Wood finish - Natural, Light Cherry, Cherry, Dark Mocha, Stone, Walnut
 - Metal finish - Silver or Black
- Ganging clip



Option | Double needle stitching:

- JUL01L +\$95
- JUL02L +\$142
- JUL03L +\$184

Option | Contrast stitching (with double needle only): +\$79

***NOTE:**

When specifying multiple fabrics please:

- Clearly identify which fabric is to be upholstered to the seat, back and arms.
- Use highest grade pricing of all fabric selected (i.e. if you choose E and J, use J grade for all).
- Please call customer service for yardage requirements.



JUL01L



JUL01AL



JUL02L



JUL03L

MODEL	COVER	DESCRIPTION	DIMENSION	SH	SW	SD	WT	YDS	CAL 133	MB
JUL01L	Standard	Chair Armless Low Back	24"d x 23.5"w x 26"h	18"	23.5"	19"	30 lbs	4.00	+\$90/yd	+\$31/yd
JUL01AL	Standard	Armchair Low Back	24"d x 30.5"w x 26"h	18"	23.5"	19"	-	7.00	+\$90/yd	+\$31/yd
JUL02L	Standard	Settee Armless Low Back	24"d x 47"w x 26"h	18"	47"	19"	50 lbs	6.00	+\$90/yd	+\$31/yd
JUL03L	Standard	Sofa Armless Low Back	24"d x 70.5"w x 26"h	18"	74"	19"	70 lbs	8.00	+\$90/yd	+\$31/yd

MODEL

MODEL	COM	A	B	C	D	E	F	G	H	I	J	K	L	M	N
JUL01L	\$1,569	\$1,750	\$1,799	\$1,866	\$1,927	\$1,978	\$2,047	\$2,132	\$2,234	\$2,424	\$2,538	\$2,652	\$2,765	\$2,879	\$2,992
JUL01AL	\$2,625	\$2,952	\$3,041	\$3,158	\$3,269	\$3,361	\$3,482	\$3,635	\$3,818	\$4,158	\$4,370	\$4,588	\$4,807	\$5,023	\$5,241
JUL02L	\$2,038	\$2,316	\$2,390	\$2,489	\$2,581	\$2,659	\$2,760	\$2,888	\$3,042	\$3,327	\$3,498	\$3,668	\$3,838	\$4,009	\$4,179
JUL03L	\$2,536	\$2,909	\$3,008	\$3,140	\$3,263	\$3,366	\$3,501	\$3,672	\$3,876	\$4,257	\$4,484	\$4,712	\$4,939	\$5,166	\$5,393

JULIA - LOW BACK CORNER | CURVES | WEDGES

Standard Features:

- Single Needle Stitching
- Seat and Back Cushions Includes Polyester Fiber Wrap for Added Comfort
- Feet: Wood or Metal Cylinder
 - Wood finish - Natural, Light Cherry, Cherry, Dark Mocha, Stone, Walnut
 - Metal finish - Silver or Black
- Ganging clip



Option | Double needle stitching:

- JULCRNBBL +\$95
- JUL30L, JUL38L, JUL60L +\$142

Option | Contrast stitching (with double needle only): +\$79

***NOTE:**

When specifying multiple fabrics please:

- Clearly identify which fabric is to be upholstered to the seat, back and arms.
- Use highest grade pricing of all fabric selected (i.e. if you choose E and J, use J grade for all).
- Please call customer service for yardage requirements.



JULCRNBBL



JUL38CBL



JUL60CBL



JUL30WBL

MODEL	COVER	DESCRIPTION	DIMENSION	SH	SW	SD	WT	YDS	CAL 133	MB
JULCRNBBL	Standard	Corner Chair Low Back	24"d x 23.5"w x 26"h	18"	24"	19"	40 lbs	6.50	+\$90/yd	+\$31/yd
JUL38CBL	Standard	38° Inside Curve Low Back	24"d x 32.5"w x 26"h	18"	32.5"	19"	35 lbs	4.00	+\$90/yd	+\$31/yd
JUL60CBL	Standard	60° Inside Curve Low Back	24"d x 56" x 26"h	18"	56"	19"	-	6.50	+\$90/yd	+\$31/yd
JUL30WBL	Standard	30° Wedge Low Back	24"d x 29"w x 26"h	18"	29"	19"	-	4.50	+\$90/yd	+\$31/yd

MODEL

MODEL	COM	A	B	C	D	E	F	G	H	I	J	K	L	M	N
JULCRNBBL	\$2,011	\$2,315	\$2,394	\$2,502	\$2,602	\$2,685	\$2,796	\$2,935	\$3,100	\$3,410	\$3,595	\$3,778	\$3,963	\$4,148	\$4,332
JUL38CBL	\$1,826	\$1,999	\$2,055	\$2,127	\$2,194	\$2,250	\$2,324	\$2,417	\$2,530	\$2,735	\$2,860	\$2,986	\$3,109	\$3,235	\$3,358
JUL60CBL	\$2,152	\$2,454	\$2,534	\$2,641	\$2,741	\$2,824	\$2,935	\$3,074	\$3,239	\$3,549	\$3,734	\$3,918	\$4,102	\$4,287	\$4,472
JUL30WBL	\$1,606	\$1,813	\$1,868	\$1,942	\$2,011	\$2,070	\$2,146	\$2,242	\$2,357	\$2,571	\$2,699	\$2,827	\$2,954	\$3,082	\$3,337

KENSINGTON

Chair | Settee | Sofa | ottoman



Standard Features:

Single Needle Stitching | Welt Cord

5" Thick Foam Seat Cushion with Polyester Fiber Wrap for Comfort

Seat Cushion Clipped to Chair Using "D" Ring Elastic Ties and Spring Clips

Feet: Double Curve Wood Block | Choose finish - Natural, Light Cherry, Cherry, Dark Mocha, Stone, Walnut



SF801



SF802



SF803



SF805

MODEL	COVER	DESCRIPTION	DIMENSION	AH	SH	SW	SD	WT	YDS	CAL 133	MB
SF801	Standard	Chair	35"d x 39"w x 34"h	24.5"	17"	21.5"	20"	88 lbs	7.00	+\$90/yd	+\$31/yd
SF802	Standard	Settee	35"d x 60"w x 34"h	24.5"	17"	43"	20"	95 lbs	9.50	+\$90/yd	+\$31/yd
SF803	Standard	Sofa	35"d x 80"w x 34"h	24.5"	17"	64.5"	20"	120 lbs	11.75	+\$90/yd	+\$31/yd
SF805	Standard	Ottoman	16.5"d x 24.5"w x 17"h	-	17"	-	-	23 lbs	2.00	+\$90/yd	+\$31/yd

MODEL

	COM	A	B	C	D	E	F	G	H	I	J	K	L	M	N
SF801	\$2,257	\$2,581	\$2,668	\$2,783	\$2,892	\$2,982	\$3,100	\$3,249	\$3,428	\$3,761	\$3,961	\$4,159	\$4,358	\$4,556	\$4,755
SF802	\$2,857	\$3,303	\$3,420	\$3,577	\$3,724	\$3,846	\$4,008	\$4,209	\$4,452	\$4,905	\$5,174	\$5,444	\$5,713	\$5,983	\$6,252
SF803	\$3,276	\$3,830	\$3,975	\$4,168	\$4,350	\$4,500	\$4,700	\$4,950	\$5,250	\$5,810	\$6,143	\$6,477	\$6,811	\$7,144	\$7,478
SF805	\$1,566	\$1,623	\$1,650	\$1,687	\$1,721	\$1,750	\$1,789	\$1,835	\$1,893	\$1,998	\$2,062	\$2,124	\$2,187	\$2,252	\$2,314

NEWMAN Chair | Settee | Sofa

Standard Features:

- Welt Cord and Double Needle Stitching
- 7" Thick Laminated Foam Seat Cushion with Polyester Fiber Wrap for Comfort
- Seat Cushion Clipped to Chair Using "D" Ring Elastic Ties and Spring Clips
- Feet: Bolted Sled | Choose finish - Natural, Light Cherry, Cherry, Dark Mocha, Stone

Option | Contrast stitching: +\$79



SF7101-35

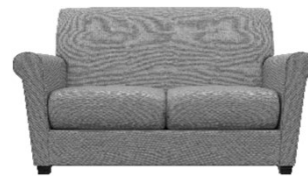

SF7102-35

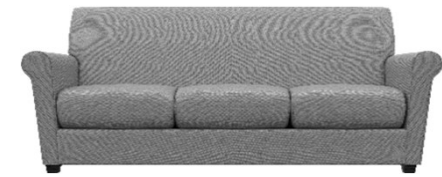

SF7103-35

MODEL	COVER	DESCRIPTION	DIMENSION	AH	SH	SW	SD	WT	YDS	CAL 133	MB
SF7101-35	Standard	Chair	30"d x 34.5"w x 35"h	25.5"	18.5"	21.5"	19"	80 lbs	6.50	+\$90/yd	+\$31/yd
SF7102-35	Standard	Settee	30"d x 56.5"w x 35"h	25.5"	18.5"	43"	19"	105 lbs	8.75	+\$90/yd	+\$31/yd
SF7103-35	Standard	Sofa	30"d x 78"w x 35"h	25.5"	18.5"	64.5"	19"	130 lbs	10.25	+\$90/yd	+\$31/yd

MODEL

MODEL	COM	A	B	C	D	E	F	G	H	I	J	K	L	M	N
SF7101-35	\$2,396	\$2,693	\$2,773	\$2,880	\$2,980	\$3,064	\$3,174	\$3,313	\$3,479	\$3,789	\$3,973	\$4,157	\$4,342	\$4,526	\$4,711
SF7102-35	\$2,832	\$3,238	\$3,346	\$3,490	\$3,626	\$3,737	\$3,887	\$4,073	\$4,296	\$4,713	\$4,962	\$5,210	\$5,459	\$5,706	\$5,955
SF7103-35	\$3,263	\$3,741	\$3,867	\$4,036	\$4,195	\$4,326	\$4,500	\$4,718	\$4,980	\$5,468	\$5,760	\$6,050	\$6,341	\$6,632	\$6,923

PEABODY Chair



Standard Features:

- Welt Cord and Single Needle Stitching Standard
- 4.5" Thick Foam Seat Cushion with Polyester Fiber Wrap for Comfort | Non-Removable
- Feet: | Choose finish - Natural, Light Cherry, Cherry, Dark Mocha, Stone

Option | Contrast stitching: +\$79

***NOTE:**

When specifying multiple fabrics please:

- Clearly identify which fabric is to be upholstered to the seat, back and arms.
- Use highest grade pricing of all fabric selected (i.e. if you choose E and J, use J grade for all).
- Please call customer service for yardage requirements.



PE113W



MODEL	COVER	DESCRIPTION	DIMENSION	AH	SH	SW	SD	WT	YDS	CAL 133	MB
PE113W	Standard	Chair	30.5"d x 30.5"w x 30.5"h	25"	17.5"	21.5"	21.5"	55 lbs	5.50	+\$90/yd	+\$31/yd

MODEL

MODEL	COM	A	B	C	D	E	F	G	H	I	J	K	L	M	N
PE113W	\$2,334	\$2,583	\$2,650	\$2,741	\$2,825	\$2,896	\$2,990	\$3,107	\$3,247	\$3,509	\$3,666	\$3,822	\$3,978	\$4,134	\$4,290

SALEM Chair | Settee | Sofa

Standard Features:

- Double Needle Stitching
- 5" Thick Foam Seat Cushion with Polyester Fiber Wrap for Comfort
- Seat Cushion Clipped to Chair Using "D" Ring Elastic Ties and Spring Clips
- Pillow Back | Polyester Fiber Fill Material for Comfort
- Feet: Block Leg Tapered 4 Sides | Choose Finish - Natural, Light Cherry, Cherry, Dark Mocha, Stone



Option | Contrast Stitching: +\$79



SF3001



SF3002



SF3003

MODEL	COVER	DESCRIPTION	DIMENSION	AH	SH	SW	SD	WT	YDS	CAL 133	MB
SF3001	Standard	Chair	37"d x 31"w x 35"h	25"	19"	22"	24.75"	75 lbs	5.75	+\$90/yd	+\$31/yd
SF3002	Standard	Settee	37"d x 53.5"w x 35"h	25"	19"	44"	24.75"	100 lbs	8.50	+\$90/yd	+\$31/yd
SF3003	Standard	Sofa	37"d x 74.5"w x 35"h	25"	19"	66"	24.75"	125 lbs	12.00	+\$90/yd	+\$31/yd

MODEL

MODEL	COM	A	B	C	D	E	F	G	H	I	J	K	L	M	N
SF3001	\$2,194	\$2,457	\$2,528	\$2,622	\$2,711	\$2,786	\$2,884	\$3,006	\$3,153	\$3,426	\$3,589	\$3,752	\$3,916	\$4,079	\$4,242
SF3002	\$2,767	\$3,162	\$3,267	\$3,407	\$3,538	\$3,647	\$3,791	\$3,972	\$4,189	\$4,595	\$4,835	\$5,077	\$5,319	\$5,559	\$5,801
SF3003	\$3,170	\$3,753	\$3,906	\$4,108	\$4,298	\$4,457	\$4,665	\$4,933	\$5,271	\$5,892	\$6,269	\$6,644	\$7,021	\$7,397	\$7,772

SALEM | FLEX - REPLACEMENT C Chair | Settee | Sofa



Standard Features:

- Double Needle Stitching
- Replaceable Fabric Covers | No Tools Needed
- Bolt Together Assembly | Velcro Upholstery
- 5" Thick Foam Seat Cushion with Polyester Fiber Wrap for Comfort
- Seat Cushion Clipped to Chair Using "D" Ring Elastic Ties and Spring Clips
- Pillow Back | Polyester Fiber Fill Material for Comfort
- Feet: Wood Cylinder Legs | Choose Finish - Natural, Light Cherry, Cherry, Dark Mocha, Stone, Walnut



MODEL	COVER	DESCRIPTION	DIMENSION	AH	SH	SW	SD	WT	YDS	CAL 133	MB
SF3001REPCOV	Flex	Chair Replacement Cover		-	-	-	-	-	5.75	+\$90/yd	+\$31/yd
SF3002REPCOV	Flex	Settee Replacement Cover		-	-	-	-	-	8.50	+\$90/yd	+\$31/yd
SF3003REPCOV	Flex	Sofa Replacement Cover		-	-	-	-	-	12.00	+\$90/yd	+\$31/yd
SF3000LAFCOV	Flex	Left Arm Replacement Cover		-	-	-	-	-	1.30	+\$90/yd	+\$31/yd
SF3000LARCOV	Flex	Right Arm Replacement Cover		-	-	-	-	-	1.30	+\$90/yd	+\$31/yd
3000VRSTCOV	Flex	Seat Replacement Cover		-	-	-	-	-	1.25	+\$90/yd	+\$31/yd
3000VRECUSH	Flex	Seat Cushion Replacement with Cover		-	-	-	-	-	1.25	+\$90/yd	+\$31/yd

MODEL

MODEL	COM	A	B	C	D	E	F	G	H	I	J	K	L	M	N
SF3001REPCOV	\$580	\$777	\$851	\$950	\$1,042	\$1,120	\$1,221	\$1,351	\$1,505	\$1,788	\$1,959	\$2,131	\$2,303	\$2,474	\$2,645
SF3002REPCOV	\$826	\$1,123	\$1,234	\$1,381	\$1,518	\$1,632	\$1,783	\$1,974	\$2,201	\$2,620	\$2,872	\$3,126	\$3,381	\$3,633	\$3,887
SF3003REPCOV	\$1,140	\$1,560	\$1,715	\$1,923	\$2,115	\$2,275	\$2,490	\$2,759	\$3,080	\$3,671	\$4,029	\$4,387	\$4,745	\$5,103	\$5,459
SF3000LAFCOV	\$248	\$296	\$312	\$335	\$355	\$373	\$396	\$426	\$461	\$524	\$564	\$602	\$640	\$680	\$718
SF3000LARCOV	\$248	\$296	\$312	\$335	\$355	\$373	\$396	\$426	\$461	\$524	\$564	\$602	\$640	\$680	\$718
3000VRSTCOV	\$162	\$221	\$236	\$258	\$278	\$295	\$317	\$345	\$378	\$441	\$477	\$515	\$551	\$589	\$627
3000VRECUSH	\$248	\$304	\$321	\$342	\$362	\$378	\$401	\$428	\$462	\$524	\$561	\$598	\$635	\$673	\$711

SUNDAY Chair | Settee | Sofa



Standard Features:

- Single Needle Stitching
- 7.5" Thick Foam Seat Cushion with Polyester Fiber Wrap for Comfort
- Seat Cushion SUN01, SUN02, SUN03 Clipped to Chair Using "D" Ring Elastic Ties and Spring Clips
- Seat Cushion SUN01TS Integrated Foam polyester fiber wrap for comfort - Non-Removable
- Feet: Block Leg Tapered 4 Sides | Choose Finish - Natural, Light Cherry, Cherry, Dark Mocha, Stone



Option | Double Needle Stitching:

- Chair: +\$184
- Settee: +\$220
- Sofa: +\$282

Option | Contrast Stitching (with double needle only): +\$79

***NOTE:**

When specifying multiple fabrics please:

- Clearly identify which fabric is to be upholstered to the seat, back and arms.
- Use highest grade pricing of all fabric selected (i.e. if you choose E and J, use J grade for all).
- Please call customer service for yardage requirements.



SUN01TS



SUN01

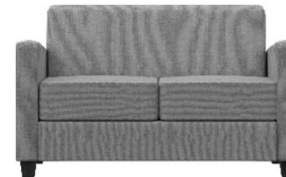

SUN02



SUN03

MODEL	COVER	DESCRIPTION	DIMENSION	AH	SH	SW	SD	WT	YDS	CAL 133	MB
SUN01TS	Standard	Tight Seat Lounge Chair	31"d x 29"w x 34.25"h	25.75"	18"	21"	22"	84 lbs	5.5	+\$90/yd	+\$31/yd
SUN01	Standard	Lounge Chair	31"d x 29"w x 34.25"h	25.75"	18"	21"	22"	-	5.5	+\$90/yd	+\$31/yd
SUN02	Standard	Settee	31"d x 50"w x 34.25"h	25.75"	18"	42"	22"	-	9.0	+\$90/yd	+\$31/yd
SUN03	Standard	Sofa	31"d x 71"w x 34.25"h	25.75"	18"	63"	22"	-	11.3	+\$90/yd	+\$31/yd

MODEL	COM	A	B	C	D	E	F	G	H	I	J	K	L	M	N
SUN01TS	\$1,948	\$2,200	\$2,267	\$2,358	\$2,442	\$2,513	\$2,607	\$2,724	\$2,864	\$3,126	\$3,283	\$3,439	\$3,595	\$3,751	\$3,907
SUN01	\$1,953	\$2,205	\$2,273	\$2,364	\$2,448	\$2,519	\$2,612	\$2,730	\$2,870	\$3,132	\$3,288	\$3,444	\$3,601	\$3,757	\$3,913
SUN02	\$2,526	\$2,947	\$3,058	\$3,206	\$3,345	\$3,460	\$3,614	\$3,805	\$4,035	\$4,464	\$4,719	\$4,974	\$5,230	\$5,486	\$5,742
SUN03	\$2,999	\$3,529	\$3,668	\$3,853	\$4,027	\$4,171	\$4,362	\$4,602	\$4,889	\$5,425	\$5,744	\$6,064	\$6,383	\$6,703	\$7,022

UNIVERSITY Chair | Settee | Sofa

Standard Features:

- Double Needle Stitching
- 3" Thick Foam Seat Cushion with Polyester Fiber Wrap for Comfort | Non-Removable
- Shelf (Chair only) | 3/4" Black HPL with Matching 3MM Edge
- Feet: Wood Cylinder Legs | Choose Finish - Natural, Light Cherry, Cherry, Dark Mocha, Stone



- Option | Contrast Stitching: +\$79
- Option | Motion Package (Handle, 2 Casters*, 2 Metal Legs): +\$208
- Option | Motion Package (Handle, 2 Casters*, 2 Wood Legs): +\$114
- Option | 4 Casters (2 Locking): +\$60
- Option | Feet | 4 Metal Cylinder Legs (Choose Black or Silver): +\$193
- Option | Cup Holder: +\$320
- Option | Tablet Arm (12"dia): +\$377

***NOTE:**

Castors in the motion package are non-locking. For 2 locking, please add \$10.00

When specifying multiple fabrics please:

Clearly identify which fabric is to be upholstered to the seat, back and arms.

Use highest grade pricing of all fabric selected (i.e. if you choose E and J, use J grade for all).

Please call customer service for yardage requirements.



SF8301

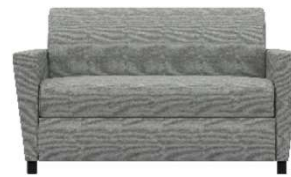

SF8302



SF8303

MODEL	COVER	DESCRIPTION	DIMENSION	AH	SH	SW	SD	WT	YDS	CAL 133	MB
SF8301	Standard	Chair	27"d x 31"w x 33.5"h	24.5"	19"	20.75"	19.5"	75 lbs	4.50	+\$90/yd	+\$31/yd
SF8302	Standard	Settee	27"d x 52"w x 33.5"h	24.5"	19"	41.5"	19.5"	-	6.50	+\$90/yd	+\$31/yd
SF8303	Standard	Sofa	27"d x 81"w x 33.5"h	24.5"	19"	62.5"	19.5"	-	8.50	+\$90/yd	+\$31/yd

MODEL	COM	A	B	C	D	E	F	G	H	I	J	K	L	M	N
SF8301	\$2,314	\$2,510	\$2,564	\$2,638	\$2,708	\$2,766	\$2,843	\$2,938	\$3,053	\$3,268	\$3,395	\$3,523	\$3,651	\$3,778	\$3,906
SF8302	\$2,821	\$3,113	\$3,192	\$3,300	\$3,400	\$3,483	\$3,594	\$3,733	\$3,898	\$4,208	\$4,393	\$4,576	\$4,761	\$4,946	\$5,130
SF8303	\$3,188	\$3,577	\$3,682	\$3,822	\$3,953	\$4,062	\$4,206	\$4,387	\$4,604	\$5,010	\$5,250	\$5,492	\$5,734	\$5,974	\$6,216

UNIVERSITY Open Chair | Settee

Standard Features:

- Double Needle Stitching
- 3" Thick Foam Seat Cushion with Polyester Fiber Wrap for Comfort | Non-Removable
- Shelf (Chair only) | 3/4" Black HPL with Matching 3MM Edge
- Feet: Wood Cylinder Legs | Choose Finish - Natural, Light Cherry, Cherry, Dark Mocha, Stone



- Option | Contrast Stitching: +\$79
- Option | Motion Package (Handle, 2 Casters*, 2 Metal Legs): +\$208
- Option | Motion Package (Handle, 2 Casters*, 2 Wood Legs): +\$114
- Option | 4 Casters (2 Locking): +\$60
- Option | Feet | 4 Metal Cylinder Legs (Choose Black or Silver): +\$193
- Option | Cup Holder: +\$320
- Option | Tablet Arm (12"dia): +\$377

***NOTE:**

Casters in the motion package are non-locking. For 2 locking, please add \$10.00

When specifying multiple fabrics please:

Clearly identify which fabric is to be upholstered to the seat, back and arms.

Use highest grade pricing of all fabric selected (i.e. if you choose E and J, use J grade for all).

Please call customer service for yardage requirements.



SF8001



SF8201



SF8202

MODEL	COVER	DESCRIPTION	DIMENSION	AH	SH	SW	SD	WT	YDS	CAL 133	MB
SF8001	Standard	Chair Shelf	27"d x 31"w x 33.5"h	24.5"	19"	20.75"	19.5"	73 lbs	4.00	+\$90/yd	+\$31/yd
SF8201	Standard	Chair Open Front	27"d x 31"w x 33.5"h	24.5"	19"	20.75"	19.5"	60 lbs	4.00	+\$90/yd	+\$31/yd
SF8202	Standard	Settee Open Front	27"d x 52"w x 33.5"h	24.5"	19"	41.5"	19.5"	-	6.00	+\$90/yd	+\$31/yd

MODEL

MODEL	COM	A	B	C	D	E	F	G	H	I	J	K	L	M	N
SF8001	\$2,292	\$2,464	\$2,513	\$2,579	\$2,641	\$2,692	\$2,760	\$2,846	\$2,947	\$3,138	\$3,252	\$3,366	\$3,479	\$3,593	\$3,705
SF8201	\$2,168	\$2,341	\$2,390	\$2,456	\$2,518	\$2,569	\$2,637	\$2,723	\$2,824	\$3,015	\$3,129	\$3,243	\$3,356	\$3,470	\$3,582
SF8202	\$2,809	\$3,075	\$3,149	\$3,248	\$3,341	\$3,418	\$3,520	\$3,647	\$3,801	\$4,086	\$4,257	\$4,427	\$4,597	\$4,768	\$4,938

WESTMINSTER Chair | Settee | Sofa



Standard Features:

- Welt Cord and Double Needle Stitching
- 7" Thick Laminated Foam Seat Cushion with Polyester Fiber Wrap for Comfort
- Seat Cushion Clipped to Chair Using "D" Ring Elastic Ties and Spring Clips
- Feet: Bolted Sled Leg | Choose Finish - Natural, Light Cherry, Cherry, Dark Mocha, Stone

Option | Contrast Stitching : +\$79



SF7101



SF7102



SF7103

MODEL	COVER	DESCRIPTION	DIMENSION	AH	SH	SW	SD	WT	YDS	CAL 133	MB
SF7101	Standard	Chair	31"d x 41"w x 32.5"h	25.5"	18"	25.5"	20.5"	75 lbs	6.00	+\$90/yd	+\$31/yd
SF7102	Standard	Settee	31"d x 64.5"w x 32.5"h	25.5"	18"	51"	20.5"	100 lbs	8.00	+\$90/yd	+\$31/yd
SF7103	Standard	Sofa	31"d x 86.5"w x 32.5"h	25.5"	18"	76.5"	20.5"	125 lbs	10.00	+\$90/yd	+\$31/yd

MODEL

MODEL	COM	A	B	C	D	E	F	G	H	I	J	K	L	M	N
SF7101	\$2,314	\$2,587	\$2,661	\$2,760	\$2,853	\$2,930	\$3,032	\$3,159	\$3,313	\$3,598	\$3,769	\$3,939	\$4,109	\$4,280	\$4,450
SF7102	\$2,821	\$3,189	\$3,288	\$3,420	\$3,544	\$3,646	\$3,782	\$3,953	\$4,157	\$4,538	\$4,765	\$4,993	\$5,219	\$5,446	\$5,673
SF7103	\$3,251	\$3,716	\$3,839	\$4,003	\$4,158	\$4,286	\$4,457	\$4,669	\$4,924	\$5,401	\$5,685	\$5,968	\$6,252	\$6,536	\$6,820

WILLIAM Chair | Settee | Sofa

Standard Features:

- Single Needle Stitching
- 5" Thick Foam Seat Cushion with Polyester Fiber Wrap for Comfort
- 4" Arm Width at Top | 11" From Top of Seat to Top of Back
- Seat Cushion Clipped to Chair Using "D" Ring Elastic Ties and Spring Clips
- Feet: Square Brushed Nickel Legs



Option | Double Needle Stitching:

- Chair +\$95
- Settee +\$142
- Sofa +\$184

Option | Contrast Stitching (with Double Needle Only) : +\$79



SF2101

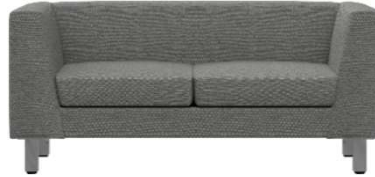

SF2102



SF2103

MODEL	COVER	DESCRIPTION	DIMENSION	AH	SH	SW	SD	WT	YDS	CAL 133	MB
SF2101	Standard	Chair	28"d x 33.5"w x 27.5"h	27.5"	17.5"	20"	20"	75 lbs	4.50	+\$90/yd	+\$31/yd
SF2102	Standard	Settee	28"d x 57.25"w x 27.5"h	27.5"	17.5"	43"	20"	100 lbs	7.00	+\$90/yd	+\$31/yd
SF2103	Standard	Sofa	28"d x 80.75"w x 27.5"h	27.5"	17.5"	66.5"	20"	125 lbs	11.00	+\$90/yd	+\$31/yd

MODEL

MODEL	COM	A	B	C	D	E	F	G	H	I	J	K	L	M	N
SF2101	\$2,161	\$2,283	\$2,345	\$2,426	\$2,502	\$2,565	\$2,651	\$2,756	\$2,884	\$3,116	\$3,257	\$3,398	\$3,539	\$3,680	\$3,821
SF2102	\$2,858	\$3,135	\$3,224	\$3,343	\$3,454	\$3,546	\$3,668	\$3,821	\$4,004	\$4,345	\$4,550	\$4,753	\$4,973	\$5,192	\$5,410
SF2103	\$3,273	\$3,734	\$3,870	\$4,051	\$4,221	\$4,362	\$4,549	\$4,783	\$5,063	\$5,588	\$5,900	\$6,212	\$6,525	\$6,837	\$7,149

WILMINGTON Chair | Settee | Sofa



Standard Features:

- Single needle stitching standard
- 5" Foam Seat Cushion with Polyester Fiber Wrap for Comfort
- Seat Cushion Clipped to Chair Using "D" Ring Elastic Ties and Spring Clips
- Pillow Back | Polyester Fiber Fill Material for Comfort
- Feet: Block Leg Tapered 4 Sides | Choose finish - Natural, Light Cherry, Cherry, Dark Mocha, Stone

Option | Double Needle Stitching:

- Chair +\$95
- Settee +\$142
- Sofa +\$184

Option | Contrast Stitching (with Double Needle Only): +\$79



SF1001



SF1002



SF1003

MODEL	COVER	DESCRIPTION	DIMENSION	AH	SH	SW	SD	WT	YDS	CAL 133	MB
SF1001	Standard	Chair	37"d x 39"w x 35"h	25"	19.5"	22"	25"	75 lbs	7.00	+\$90/yd	+\$31/yd
SF1002	Standard	Settee	37"d x 60.5"w x 35"h	25"	19.5"	44"	25"	100 lbs	10.50	+\$90/yd	+\$31/yd
SF1003	Standard	Sofa	37"d x 82.5"w x 35"h	25"	19.5"	66"	25"	125 lbs	13.00	+\$90/yd	+\$31/yd

MODEL

MODEL	COM	A	B	C	D	E	F	G	H	I	J	K	L	M	N
SF1001	\$1,993	\$2,322	\$2,408	\$2,523	\$2,632	\$2,722	\$2,840	\$2,990	\$3,169	\$3,501	\$3,701	\$3,899	\$4,098	\$4,296	\$4,496
SF1002	\$2,528	\$3,028	\$3,158	\$3,332	\$3,493	\$3,628	\$3,807	\$4,030	\$4,298	\$4,799	\$5,096	\$5,395	\$5,693	\$5,990	\$6,289
SF1003	\$3,138	\$3,758	\$3,919	\$4,133	\$4,334	\$4,500	\$4,721	\$4,998	\$5,330	\$5,949	\$6,318	\$6,687	\$7,056	\$7,425	\$7,794

STATEMENT OF LINE - SINGLE FACE



42"H | SHS
Single Face
Starter | Adder



48"H | SHS
Single Face
Starter | Adder



60"H | SHS
Single Face
Starter | Adder



82"H | SHS
Single Face
Starter | Adder



90"H | SHS
Single Face
Starter | Adder

STATEMENT OF LINE - DOUBLE FACE



42"H | SHD
Double Face
Starter | Adder



48"H | SHD
Double Face
Starter | Adder



60"H | SHD
Double Face
Starter | Adder



82"H | SHD
Double Face
Starter | Adder



90"H | SHD
Double Face
Starter | Adder

OAK SHELVING | SINGLE FACE

Standard Features:

Uprights: 1" | Oak Veneer 5-Ply Hardwood Core
 Top: Oak veneer with fascia and assembly blocks
 Base: Solid Oak Toe Kick | Assembly Blocks
 Shelves: 3/4" Solid Northern Grown Red Oak
 Back: Solid Hardboard
 Construction: 32mm | Wall Anchors Provided

Adder: Contains (1) Top | (1) Base | (1) Intermediate Panel | Adjustable Shelves | Base Shelf

ModuForm Finishes:

Standard wood finish is Natural Oak
 Available wood finishes: Light Cherry, Cherry, Stone, Dark Mocha, Walnut
 *Please add listed stain upcharge for available wood finishes

Option: For custom wood finish, please add \$600 NET plus listed stain upcharge

*Single face shelving taller than 42" should be wall mounted for safety



SHSS-4212

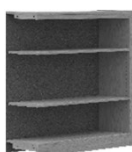

SHSA-4212



SHSS-4812

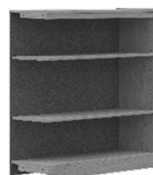

SHSA-4812



SHSS-6012

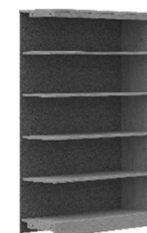

SHSA-6012

MODEL	DESCRIPTION	DIMENSION	WT	LIST	*STAIN
42" HIGH SHELVING					
SHSS-4212	Single Face Shelving Unit, 3 Openings with Back	12"d x 37-1/8"w x 42"h	72 lbs	\$1,352	+\$78
SHSA-4212	Single Face Shelving Unit, 3 Openings with Back - Adder	12"d x 36-1/8" x 42"h	52 lbs	\$1,100	+\$52
48" HIGH SHELVING					
SHSS-4812	Single Face Shelving Unit, 3 Openings with Back	12"d x 37-1/8"w x 48"h	85 lbs	\$1,352	+\$78
SHSA-4812	Single Face Shelving Unit, 3 Openings with Back - Adder	12"d x 36-1/8" x 48"h	60 lbs	\$1,103	+\$52
60" HIGH SHELVING					
SHSS-6012	Single Face Shelving Unit, 5 Openings with Back	12"d x 37-1/8"w x 60"h	104 lbs	\$1,860	+\$78
SHSA-6012	Single Face Shelving Unit, 5 Openings with Back - Adder	12"d x 36-1/8" x 60"h	75 lbs	\$1,442	+\$52

OPTION #	DESCRIPTION	LIST
2942	Oak Back - Rotary Cut for 42"h	\$163
2948	Oak Back - Rotary Cut for 48"h	\$163
2960	Oak Back - Rotary Cut for 60"h	\$197

OAK SHELVING | SINGLE FACE

Standard Features:

Uprights: 1" | Oak Veneer 5-Ply Hardwood Core
 Top: Oak veneer with fascia and assembly blocks
 Base: Solid Oak Toe Kick | Assembly Blocks
 Shelves: 3/4" Solid Northern Grown Red Oak
 Back: Solid Hardboard
 Construction: 32mm | Wall Anchors Provided

Adder: Contains (1) Top | (1) Base | (1) Intermediate Panel | Adjustable Shelves | Base Shelf

ModuForm Finishes:

Standard wood finish is Natural Oak
 Available wood finishes: Light Cherry, Cherry, Stone, Dark Mocha, Walnut
 *Please add listed stain upcharge for available wood finishes

Option: For custom wood finish, please add \$600 NET plus listed stain upcharge

*Single face shelving taller than 42" should be wall mounted for safety



SHSS-8212

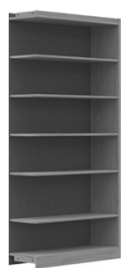

SHSA-8212



SHSS-9012

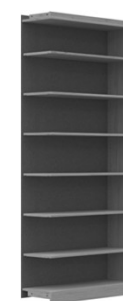

SHSA-9012

MODEL	DESCRIPTION	DIMENSION	WT	LIST	*STAIN
82" HIGH SHELVING					
SHSS-8212	Single Face Shelving Unit, 6 Openings with Back	12"d x 37-1/8"w x 82"h	139 lbs	\$2,011	+\$78
SHSA-8212	Single Face Shelving Unit, 6 Openings with Back - Adder	12"d x 36-1/8" x 82"h	99 lbs	\$1,562	+\$52
90" HIGH SHELVING					
SHSS-9012	Single Face Shelving Unit, 7 Openings with Back	12"d x 37-1/8"w x 90"h	146 lbs	\$2,122	+\$78
SHSA-9012	Single Face Shelving Unit, 7 Openings with Back - Adder	12"d x 36-1/8" x 90"h	103 lbs	\$1,669	+\$52

OPTION #	DESCRIPTION	LIST
2982	Oak Back - Rotary Cut for 82"h	\$301
2990	Oak Back - Rotary Cut for 90"h	\$359

OAK SHELVING | DOUBLE FACE

Standard Features:

Uprights: 1" | Oak Veneer 5-Ply Hardwood Core
 Top: Oak veneer with fascia and assembly blocks
 Base: Solid Oak Toe Kick | Assembly Blocks
 Shelves: 3/4" Solid Northern Grown Red Oak
 Back: Solid Hardboard
 Construction: 32mm | Wall Anchors Provided

Adder: Contains (1) Top | (1) Base | (1) Intermediate Panel | Adjustable Shelves | Base Shelf

ModuForm Finishes:

Standard wood finish is Natural Oak
 Available wood finishes: Light Cherry, Cherry, Stone, Dark Mocha, Walnut
 *Please add listed stain upcharge for available wood finishes

Option: For custom wood finish, please add \$600 NET plus listed stain upcharge

*Single face shelving taller than 42" should be wall mounted for safety



SHDS-4224



SHDA-4224



SHDS-4824



SHDA-4824



SHDS-6024

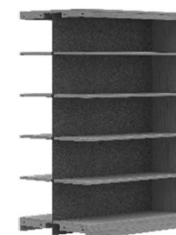

SHDA-6024

MODEL	DESCRIPTION	DIMENSION	WT	LIST	*STAIN
42" HIGH SHELVING					
SHDS-4224	Double Face Shelving Unit, 6 Openings with Back	24"d x 37-1/8"w x 42"h	140 lbs	\$1,849	+\$78
SHDA-4224	Double Face Shelving Unit, 6 Openings with Back - Adder	24"d x 36-1/8" x 42"h	100 lbs	\$1,566	+\$52
48" HIGH SHELVING					
SHDS-4824	Double Face Shelving Unit, 6 Openings with Back	24"d x 37-1/8"w x 48"h	160 lbs	\$1,850	+\$78
SHDA-4824	Double Face Shelving Unit, 6 Openings with Back - Adder	24"d x 36-1/8" x 48"h	98 lbs	\$1,569	+\$52
60" HIGH SHELVING					
SHDS-6024	Double Face Shelving Unit, 10 Openings with Back	24"d x 37-1/8"w x 60"h	232 lbs	\$2,682	+\$78
SHDA-6024	Double Face Shelving Unit, 10 Openings with Back - Adder	24"d x 36-1/8" x 60"h	174 lbs	\$2,193	+\$52

OPTION #	DESCRIPTION	LIST
2942	Oak Back - Rotary Cut for 42"h	\$163
2948	Oak Back - Rotary Cut for 48"h	\$163
2960	Oak Back - Rotary Cut for 60"h	\$197

OAK SHELVING | DOUBLE FACE

Standard Features:

Uprights: 1" | Oak Veneer 5-Ply Hardwood Core
 Top: Oak veneer with fascia and assembly blocks
 Base: Solid Oak Toe Kick | Assembly Blocks
 Shelves: 3/4" Solid Northern Grown Red Oak
 Back: Solid Hardboard
 Construction: 32mm | Wall Anchors Provided

Adder: Contains (1) Top | (1) Base | (1) Intermediate Panel | Adjustable Shelves | Base Shelf

ModuForm Finishes:

Standard wood finish is Natural Oak
 Available wood finishes: Light Cherry, Cherry, Stone, Dark Mocha, Walnut
 *Please add listed stain upcharge for available wood finishes

Option: For custom wood finish, please add \$600 NET plus listed stain upcharge

*Single face shelving taller than 42" should be wall mounted for safety



SHDS-8224

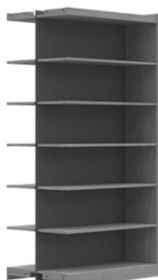

SHDA-8224



SHDS-9024

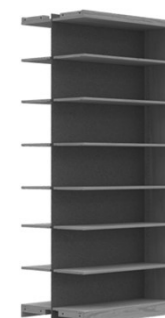



SHDA-9024

MODEL	DESCRIPTION	DIMENSION	WT	LIST	*STAIN
82" HIGH SHELVING					
SHDS-8224	Double Face Shelving Unit, 12 Openings with Back	24"d x 37-1/8"w x 82"h	220 lbs	\$2,982	+\$78
SHDA-8224	Double Face Shelving Unit, 12 Openings with Back - Adder	24"d x 36-1/8" x 82"h	99 lbs	\$2,468	+\$52
90" HIGH SHELVING					
SHDS-9024	Double Face Shelving Unit, 14 Openings with Back	24"d x 37-1/8"w x 90"h	266 lbs	\$3,195	+\$78
SHDA-9024	Double Face Shelving Unit, 14 Openings with Back - Adder	24"d x 36-1/8" x 90"h	131 lbs	\$2,677	+\$52

OPTION #	DESCRIPTION	LIST
2982	Oak Back - Rotary Cut for 82"h	\$301
2990	Oak Back - Rotary Cut for 90"h	\$359

Replacement Cushions for 3000 | 5000

	MODEL	DESCRIPTION	DIMENSION	WT	7*	9*	LIST
	30-C-982	Replacement Button Cushion Molded Vinyl Only	14"dia x 4"h	7 lbs	\$726	\$811	
	30-C-973	Replacement Seat/Back Cushion Molded Vinyl Only	18.5"d x 17.75"w x 18.5"h	22 lbs	\$1,152	\$1,219	
	30-C-974	Replacement Seat/Back Cushion Molded Plastic Only <i>*includes mounting plate</i>	18.5"d x 17.75"w x 18.5"h	19 lbs			\$912
	5-H-M-980	Replacement Melamine Seat & Hardware Grey	12.75"dia x 1"h				\$365

*Upcharges for molded vinyl grades 7 and 9 for CAL TB133 or Moisture Barrier are not required.

Replacement Cushions and Covers for Mission | Profile Rounder | Rounder Collections

	MODEL	DESCRIPTION	DIMENSION	WT	YDS	CAL133	MB
	PR01CUSHJ	Replacement Cushion with Standard Cover	28"d x 23"w x 21.5"h	18 lbs	2	+\$90/yd	+\$31/yd
	PR01CUSHJV	Replacement Cushion with Velcro Cover	28"d x 23"w x 21.5"h	18 lbs	2	+\$90/yd	+\$31/yd
	PRRSCOVV	Replacement Cushion Cover Only			2	+\$90/yd	+\$31/yd

PR01CUSH will fit Profile Rounder, Rounder and Mission seating

MODEL	COM	A	B	C	D	E	F	G	H	I	J	K	L	M	N
PR01CUSHJ	\$614	\$677	\$705	\$743	\$771	\$800	\$837	\$885	\$942	\$998	\$1,055	\$1,112	\$1,169	\$1,226	\$1,282
PR01CUSHJV	\$705	\$760	\$788	\$826	\$854	\$883	\$920	\$968	\$1,025	\$1,081	\$1,138	\$1,195	\$1,252	\$1,309	\$1,365
PRRSCOVV	\$443	\$524	\$557	\$601	\$633	\$666	\$710	\$763	\$829	\$894	\$960	\$1,025	\$1,090	\$1,155	\$1,221



Profile Rounder



Mission



Rounder

PR01CUSHJ - Cushion with Standard Cover fits Profile, Mission and Rounder
 PR01CUSHJV - Cushion with Velcro Cover fits Profile, Mission and Rounder

Replacement Cushions and Covers for 800 | 810 | 820 Series

MODEL	DESCRIPTION	DIMENSION	WT	YDS	CAL133	MB
80-C-95	Replacement Seat/Back with Cover	20"d x 24"w x 8.5"h	21 lbs	1.5	+\$136/yd	+\$31/yd
80-C-85	Replacement Back Fully Rounded with Cover	20"d x 24"w x 8.5"h	21 lbs	1.5	+\$136/yd	+\$31/yd
80-C-86	Replacement Back Center Only Square with Cover	20"d x 24"w x 8.5"h	21 lbs	1	+\$136/yd	+\$31/yd
COVER-95	Replacement Cover for Seat/Back			1.5	-	+\$31/yd
COVER-83	Replacement Cover for Left Round Back Cushion			1.5	-	+\$31/yd
COVER-84	Replacement Cover for Right Round Back Cushion			1.5	-	+\$31/yd
COVER-85	Replacement Cover for Fully Round Back Cushion			1.5	-	+\$31/yd

MODEL	COM	A	B	C	D	E	F	G	H	I	J	K	L	M	N	7*	9*
80-C-95	\$612	\$618	\$645	\$678	\$700	\$726	\$759	\$798	\$848	\$897	\$946	\$995	\$1,044	\$1,093	\$1,140	\$852	\$966
80-C-85	\$612	\$618	\$645	\$678	\$700	\$726	\$759	\$798	\$848	\$897	\$946	\$995	\$1,044	\$1,093	\$1,140	\$852	\$966
80-C-86	\$612	\$589	\$606	\$627	\$645	\$661	\$682	\$708	\$741	\$775	\$808	\$840	\$873	\$906	\$939	-	-
COVER-95	\$437	\$433	\$456	\$490	\$513	\$537	\$570	\$612	\$661	\$710	\$759	\$808	\$857	\$906	\$954	-	-
COVER-83	\$437	\$433	\$456	\$490	\$513	\$537	\$570	\$612	\$661	\$710	\$759	\$808	\$857	\$906	\$954	-	-
COVER-84	\$437	\$433	\$456	\$490	\$513	\$537	\$570	\$612	\$661	\$710	\$759	\$808	\$857	\$906	\$954	-	-
COVER-85	\$437	\$455	\$480	\$513	\$529	\$553	\$586	\$612	\$661	\$710	\$759	\$808	\$857	\$906	\$954	-	-

*Upcharges for molded vinyl grades 7 and 9 for CAL TB133 or Moisture Barrier are not required.



80-C-95 Seat/Back Cushion - square



80-C-85 Back Cushion - Fully Rounded

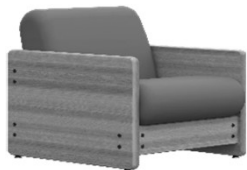

80-C-95 Seat/Back Cushion - square



80-C-95 Seat/Back Cushion - square