

# T R I N I T Y



PRICE LIST  
**2022**

AUGUST 1, 2022

## SEATING & TABLES

Workplace | Education | Government | Healthcare

**Date:**

**Page:**

**Modification:**

**Description:**

---

---

Table Of Contents.....	1
Conditions Of Sale.....	2
General Information.....	3
Order Information .....	4-9
GSA Multiple Award Contract Guidelines .....	10
15 Day Quickship Program ( <i>Item #: QS1501, QS1502, QS1801, QS1802, QS1822, QS1922</i> ) .....	11-17
Facelift Evolve Behavioral Health ( <i>Item #: BH1822, BH1832</i> ) .....	18-31
Radcliffe Square ( <i>Item #: 251 - 299; 2516D18 - 254818</i> ) .....	32-44
Cilo <sup>2</sup> ( <i>Item #: 307 - 312</i> ) .....	45-51
Ziggy ( <i>Item #: 330-A - 331-E</i> ).....	52-55
Vroom ( <i>Item #: 332-B - 332-D; 324D22-B-L - 3303017-D-L</i> ) .....	56-63
Swerve ( <i>Item #: 341-A - 341-D</i> ) .....	64-68
Wingding ( <i>Item #: 344-A - 346-B</i> ) .....	69-73
Crest ( <i>Item #: 347-A - 347-D</i> ).....	74-78
Steel ( <i>Item #: 350 - 365</i> ) .....	79-86
Edge ( <i>Item #: 371 - 384; 322D23 - 336D16</i> ).....	87-93
Traditional ( <i>Item #: 400 - 495</i> ).....	94-110
Conrad ( <i>Item #: 500 - 577</i> ).....	111-123
Classic ( <i>Item #: 700 - 772; 7020 - 7048</i> ).....	124-137
Langton ( <i>Item #: 811 - 826</i> ).....	138-144
Luci Guci ( <i>Item #: 831 - 859</i> ).....	145-154
Quads ( <i>Item #: 861 - 896</i> ) .....	155-167
Savoie ( <i>Item #: 1001 - 1048; 102020 - 102242</i> ) .....	168-179
Ace ( <i>Item #: 1055-A - 1055-D</i> ) .....	180-183
Austen ( <i>Item #: 1922 - 1951; 19C1022-L - 194220-L</i> ) .....	184-197
Serene ( <i>Item #: 61-128 - 61-803; 61-4828</i> ).....	198-207
Facelift General Information .....	208-209
Facelift Replay ( <i>Item #: 1501 - 1535</i> ) .....	210-218
Facelift Replay Healthcare Motion ( <i>Item #: 1504 - 1513</i> ).....	219-230
Facelift Polliwogs ( <i>Item #: 1540-I/O - 1545-30T</i> ) .....	231-237
Facelift Fair & Square ( <i>Item #: 1550 - 1564</i> ) .....	238-245
Facelift Serpentine ( <i>Item #: 1571 - 1595; 152230 - 15180DG16</i> ).....	246-260
Facelift Tuxedo ( <i>Item #: 1603</i> ).....	261-264
Facelift Prime Lounge ( <i>Item #: 1701 - 1713</i> ) .....	265-270
Facelift Prime Guest / Tandem / Benches / Tables ( <i>Item #: 1720 - 1773; 1716D23 - 1722DC</i> ).....	271-281
Facelift Revival Lounge / Benches ( <i>Item #: 1801 - 1819</i> ) .....	282-286
Facelift Revival Healthcare Motion ( <i>Item #: 1804 - 1813</i> ).....	287-297
Facelift Evolve Guest / Tandem / Tables ( <i>Item #: 1820 - 1851; 18C2020 - 1834D16</i> ) .....	298-320
Facelift Evolve Healthcare Motion ( <i>Item #: 1820-H - 1857</i> ) .....	321-334
Facelift Evolve Healthcare Motion (Weight-Activated Medical Recliners) ( <i>Item #: 1858 - 1860</i> ).....	335-343
Facelift Evolve Lounge / Tandem ( <i>Item #: 1841 - 1874</i> ) .....	344-356
Facelift Evolve Fully Upholstered Guest / Tandem ( <i>Item #: 1880 - 1885</i> ).....	357-365

---

**PRICES**

ALL PRICES ARE LIST, F.O.B. ORIGIN AT OUR PLANT IN TRINITY, NC. PRICES INCLUDE COMPLETE BOXING.

**CREDIT**

TRINITY FURNITURE, PO BOX 150, TRINITY, NC 27370 336-472-6660

CUSTOMERS WITH A SATISFACTORY CREDIT RATING WITH A RECOGNIZED CREDIT AGENCY MAY OPEN AN ACCOUNT. CUSTOMERS WITHOUT SUCH RATING MAY SUBMIT BANK AND TRADE REFERENCES TO OUR FACTORY FOR CREDIT APPROVAL. PLEASE ALLOW EXTRA TIME FOR CREDIT PROCESSING. FOR THOSE WITHOUT SATISFACTORY CREDIT WANTING TO ESTABLISH AN ACCOUNT, TRINITY FURNITURE WILL PROCESS ORDERS WITH RECEIPT OF A 50% DEPOSIT, WITH THE BALANCE REQUIRED BEFORE SHIPMENT.

**ORDERS**

ORDERS ARE NOT CONSIDERED ACCEPTED UNTIL OUR RESPONSE WITH AN ACKNOWLEDGEMENT. PLEASE CHECK ALL FACTORY ACKNOWLEDGEMENTS TO CONFIRM YOUR ORIGINAL ORDER. ONCE AN ORDER IS ACKNOWLEDGED TO YOU, THE FACTORY WILL BE RESPONSIBLE FOR SHIPPING EXACTLY THE ITEMS AT THE PRICES ACKNOWLEDGED. CHANGES REQUESTED ON ACKNOWLEDGED ORDERS WILL BE CONSIDERED AND MADE ONLY IF POSSIBLE. NO ADJUSTMENTS CAN BE MADE TO AN ORDER ONCE IT IS PLACED INTO PRODUCTION WITHOUT PENALTY, SEE "CANCELLATIONS" BELOW. WE DO NOT ACKNOWLEDGE AN ORDER WITH SHIP DATE, UNTIL IT IS A COMPLETE ORDER, AND ABLE TO BE PUT INTO PRODUCTION.

**CANCELLATIONS**

CANCELLATIONS CANNOT BE ACCEPTED AFTER ORDERS ARE IN THE PROCESS OF PRODUCTION AND THE ORDER MUST BE SHIPPED UPON COMPLETION. IF YOU INSIST UPON A CANCELLATION, WE WILL BILL YOU FOR THE PORTION OF THE WORK THAT HAS BEEN DONE ON THE ORDER PLUS A 25% RESTOCKING/ADMINISTRATION CHARGE

**STORAGE**

IF A CUSTOMER IS UNABLE TO RECEIVE, OR IN THE CASE OF C.B.D. ORDERS FOR WHICH PAYMENT HAS NOT BEEN RECEIVED, FURNITURE WILL BE INVOICED AND WAREHOUSING / STORAGE CHARGES WILL BE INCURRED. ALL OTHER COSTS ASSOCIATED WITH STORAGE, INCLUDING TRANSPORTATION AND LABOR, WILL BE CHARGED TO THE CUSTOMER. THE CUSTOMER WILL BEAR ALL THE RISKS OF DAMAGE OR LOSS DURING STORAGE OF THE MERCHANDISE.

**SHIPPING**

TRINITY WILL SHIP IN ACCORDANCE WITH THE CUSTOMER INSTRUCTIONS WHENEVER POSSIBLE. WE WILL EXERCISE OUR BEST JUDGEMENT IN SELECTING AN APPROPRIATE CARRIER WHENEVER ONE HAS NOT BEEN SPECIFIED BY THE CUSTOMER. A GUARANTEED FREIGHT PROGRAM IS AVAILABLE AND DESCRIBED ON PAGE 3.

**DAMAGES / CLAIMS**

TRINITY IS NOT RESPONSIBLE FOR DAMAGE IN TRANSIT OR STORAGE. THE CONSIGNEE MUST INSPECT THE MERCHANDISE UPON RECEIPT AND NOTE ANY OBVIOUS DAMAGE ON CARRIER'S DELIVERY RECEIPT. DAMAGE WHICH BECOMES APPARENT WHEN THE MERCHANDISE IS UNPACKED, "CONCEALED DAMAGE," SHOULD BE REPORTED TO TRINITY WITHIN TWO (2) DAYS OF RECEIPT OF GOODS. FAILURE TO MAKE SUCH CLAIMS SHALL CONSTITUTE FULL ACCEPTANCE OF THE MERCHANDISE. NO CREDIT, REPAIRS OR ALLOWANCES WILL BE APPROVED WITHOUT OUR WRITTEN AUTHORITY TO DO SO.

**VISIBLE OR CONCEALED DAMAGE PROTOCOL:**

1. OPEN ALL CARTONS IN DRIVER'S PRESENCE.
2. IF DAMAGE IS APPARENT, TAKE DIGITAL PICTURES OF CARTON AND FURNITURE UPON DELIVERY TO DOCK.
3. NOTE ANY DAMAGE TO THE GOODS ON THE CARRIER'S FREIGHT BILL AS NUMBER OF PIECES DAMAGED.
4. DO NOT THROW PACKAGING AWAY OR MOVE THE FURNITURE TO A DIFFERENT LOCATION.
5. DAMAGE CLAIMS DO NOT COVER DELIVERY TO NON-DOCK LOCATIONS, CLAIMS MADE AFTER THE FURNITURE HAS BEEN INSTALLED AND/ OR REMOVED FROM THE ORIGINAL DELIVERY LOCATION OR CARTON AND PACKAGING HAS BEEN REMOVED.
6. IF DAMAGE IS APPARENT AFTER THE ALLOTTED TIME, COST OF THE REPAIR OR REPLACEMENT WILL NOT BE TRINITY'S RESPONSIBILITY.

**CONSTRUCTION**

OUR FURNITURE IS DESIGNED, ENGINEERED AND MANUFACTURED TO ACCEPT THE USE OF HIGH DENSITY PUBLIC INSTALLATIONS. WOOD FRAMES ARE CONSTRUCTED OF ONLY KILN DRIED SELECT HARDWOODS AND REINFORCED PLYWOOD MEMBERS WHICH UTILIZE DOUBLE DOWEL AND CORNER BLOCK JOINERY. SPRINGING SYSTEMS HAVE BEEN INDIVIDUALLY DESIGNED FOR EACH FURNITURE STYLE AND REPRESENT THE LATEST IN INDUSTRY TECHNOLOGY OF SHEET WEBBING, SINUOUS WIRE, OR HAND-TIED COILED SPRING CONSTRUCTION. EXPOSED WOOD FINISHED FRAME PARTS ARE SPRAYED WITH SAFE-T-GUARD® CATALYZED ACRYLIC LACQUER NOTED FOR ITS ANTIMICROBIAL FACTOR AND RESISTANCE TO NORMAL WEAR AND ITS ABILITY TO BE REFINISHED IF DAMAGED. GENERALLY, SOLID CHERRY OR MAPLE IS USED FOR ALL EXPOSED WOOD COMPONENTS. REFER TO SPECIFICATIONS FOR ANY EXCEPTIONS. **OUR FRAMES GO THROUGH OUR ON SITE TESTING LAB VERIFYING GSA HEAVY DUTY RATINGS.** EXACT CONSTRUCTION SPECIFICATIONS ARE AVAILABLE UPON REQUEST.

**NOTICE:**

1. THE FOLLOWING GUEST / SIDE CHAIRS ARE STANDARD WITH WALLSAVER LEGS: EDGE, EVOLVE, REPLAY, STEEL, AND ZEE
2. ALL SEATING AND TABLES ARE STANDARD WITH NAIL-IN OR ADJUSTABLE GLIDES.
3. ALL SEATING IS RATED FOR 350 LBS. UNLESS THEY ARE BARIATRIC, IN WHICH THEY WILL HAVE A MINIMUM OF 500 LB. TO 1000 LB. RATING.

**FLAMMABILITY**

UNLESS OTHERWISE SPECIFIED, FOAM USED IN ALL TRINITY FURNITURE INCORPORATED SEATING PRODUCTS COMPLIES WITH CALIFORNIA TECHNICAL BULLETIN 117-2013. PLEASE CONTACT CUSTOMER SUPPORT FOR PRICING IF COMPLIANCE OR CERTIFICATION IS REQUIRED FOR THE OTHER FIRE CODES. INCLUDING:

**BOSTON FIRE CODE****CALIFORNIA TECHNICAL BULLETIN 133****NEW YORK PORT AUTHORITY****SPECIFICATIONS**

ALL ITEMS ARE PRODUCED TO PRICE LIST SPECIFICATIONS. WE RESERVE THE RIGHT TO MAKE MODIFICATIONS AND IMPROVEMENTS WITHOUT PRIOR NOTICE. ALL DIMENSIONS SHOWN ARE APPROXIMATE AND MAY VARY DUE TO COVER BEING USED.

**WARRANTY**

TRINITY FURNITURE INCORPORATED WARRANTS ALL NON-FACELIFT PRODUCTS FOR TEN (10) YEARS AGAINST MANUFACTURING AND FACTORY DEFECTS, EXCLUDING COVERING MATERIALS, UNDER NORMAL SINGLE SHIFT SERVICE FOR ORIGINAL PURCHASER. DURING THIS PERIOD TRINITY FURNITURE, AT OUR OPTION, WILL REPLACE, REPAIR, OR RETURN THE PURCHASE PRICE OF ANY MERCHANDISE THAT, UPON OUR INSPECTION, IS DEEMED TO BE DEFECTIVE. THIS CONSTITUTES THE SOLE AND EXCLUSIVE REMEDY TO THE CUSTOMER. DAMAGES RESULTING FROM FREIGHT, CLAIMED OR UNCLAIMED, FROM ACCIDENT, ALTERATION, TAMPERING, MISUSE, NEGLIGENCE OR ABUSE VOIDS THIS WARRANTY. IN THE EVENT ANY PRODUCT HAS TO BE RETURNED TO THE FACTORY FOR VERIFICATION OF A COMPLAINT, IT MUST BE SHIPPED PREPAID AND INCLUDE WRITTEN INFORMATION CONTAINING THE NAME OF THE ORIGINAL PURCHASER, ORIGINAL INVOICE NUMBER, AND A COPY OF THE ORIGINAL PURCHASE ORDER MUST BE PROVIDED. BECAUSE OF NATURAL VARIATIONS ON MATERIALS OVER WHICH TRINITY FURNITURE INC. HAS NO CONTROL. THIS WARRANTY DOES NOT EXTEND TO COLOR, GRAIN OR TEXTURE OF WOOD, LEATHER OR UPHOLSTERY COVER. THIS WARRANTY IS APPLICABLE ONLY TO THOSE PARTS ACTUALLY MANUFACTURED BY TRINITY FURNITURE INCORPORATED. FOR PURCHASED COMPONENT PARTS, WE WILL APPLY EXACTLY THE SAME WARRANTY THAT IS EXTENDED TO US BY OUR SUPPLIER. TRINITY FURNITURE INCORPORATED SHALL NOT BE LIABLE FOR CONSEQUENTIAL OR INCIDENTAL DAMAGES ARISING FROM ANY PRODUCT DEFECT.

**MADE IN AMERICA**

ALL FURNITURE IS PROUDLY MADE IN THE UNITED STATES OF AMERICA.

**ENVIRONMENTAL SUSTAINABILITY****ALL TRINITY FURNITURE PRODUCTS HAVE LEVEL 1 CERTIFICATION**

THE BUSINESS INSTITUTIONAL FURNITURE MANUFACTURERS ASSOCIATES (BIFMA) LEVEL STANDARD IS TO PROVIDE MEASURABLE MARKET-BASED DEFINITIONS OF PROGRESSIVELY MORE SUSTAINABLE FURNITURE BY ESTABLISHING PERFORMANCE CRITERIA THAT ADDRESS ENVIRONMENTAL AND SOCIAL ASPECTS THROUGHOUT THE SUPPLY CHAIN.

THIS STANDARD PROVIDES A PATHWAY TOWARDS SUSTAINABILITY BY ESTABLISHING MEASURABLE CRITERIA FOR MULTIPLE LEVELS OF ACHIEVEMENT AND/OR PERFORMANCE. IT ADDRESSES PRODUCT BASED CHARACTERISTICS IN THE GENERAL AREA OF MATERIALS, USE OF ENERGY, HUMAN AND ECOSYSTEM HEALTH, AND SOCIAL RESPONSIBILITY IMPACTS.



**ORDERS**

ORDERS MUST BE CONFIRMED IN WRITING, EITHER BY MAIL, E-MAIL OR FAX, TO OUR CORPORATE HEADQUARTERS:

**TRINITY FURNITURE INCORPORATED**

**ATTN: ORDER ENTRY**

**6089 KENNEDY ROAD**

**P.O. BOX 150**

**TRINITY, NC 27370**

**336-472-6660 - TOLL FREE 855-311-6660**

**336-475-0037, FAX**

**sales@trinityfurniture.com**

**FREIGHT PROGRAM**

ORDERS MUST BE CONFIRMED IN WRITING, EITHER BY MAIL, E-MAIL OR FAX, TO OUR CORPORATE HEADQUARTERS:

**TRINITY FURNITURE INCORPORATED**

**ATTN: ORDER ENTRY**

**6089 KENNEDY ROAD**

**P.O. BOX 150**

**TRINITY, NC 27370**

**336-472-6660 - TOLL FREE 855-311-6660**

**336-475-0037, FAX**

**sales@trinityfurniture.com**

**PLEASE CONTACT TRINITY CUSTOMER SERVICE FOR ALL FREIGHT QUOTES.**

**EXTRA CHARGES ARE AS FOLLOWS:**

1. A NEED FOR SPECIAL DELIVERY EQUIPMENT, INCLUDING LIFT GATES.
2. INSIDE DELIVERY.
3. THE ABSENCE OF A LOADING DOCK.
4. REDIRECTION OR RECONSIGNMENT OF PRODUCT.
5. DETENTION CHARGES.
6. STREET UNLOADS.
7. IMPROPER REFUSAL OF PRODUCT.
8. CALL BEFORE DELIVER, APPOINTMENT.

## WOOD FINISHES

ALL STANDARD WOOD FINISHES ARE ON SELECTED HARDWOOD. ALL WOOD SAMPLES ARE ON CHERRY WOOD. SAFE-T-GUARD® ANTIMICROBIAL ADDITIVE FINISH IS THE STANDARD TOP COAT.

FINISH: <b>CLEAR MAPLE</b>	FINISH: <b>FUSION MAPLE</b>
LAMINATE: WILSONART	LAMINATE: WILSONART
FINISH: <b>BILTMORE CHERRY</b>	FINISH: <b>WILLIAMSBURG CHERRY</b>
LAMINATE: WILSONART	LAMINATE: WILSONART
FINISH: <b>SKYLINE WALNUT</b>	FINISH: <b>PINNACLE WALNUT</b>
LAMINATE: WILSONART	LAMINATE: WILSONART
FINISH: <b>HAMPTON WALNUT</b>	FINISH: <b>COCOBALA WALNUT</b>
LAMINATE: WILSONART	LAMINATE: WILSONART
FINISH: <b>EMPIRE MAHOGANY</b>	FINISH: <b>EBONY</b>
LAMINATE: WILSONART	LAMINATE: WILSONART

CUSTOM WOOD FINISHES ARE AVAILABLE.

## CUSTOM WOOD FINISH

FOR ALL SEATING – UPCHARGE OF 5% OF THE COM LIST PRICE.

FOR ALL TABLES – UPCHARGE OF 10% OF THE PRICE.

MINIMUM OF \$100 LIST, AND A MAXIMUM \$800 LIST, PER FINISH COLOR, APPLIES PER ORDER.

THIS WILL APPLY TO ANY NON-STANDARD TRINITY FURNITURE WOOD FINISH. A 3" X 3" FINISH SAMPLE MUST BE SUBMITTED WITH YOUR ORDER. TRINITY WILL MAKE EVERY ATTEMPT TO DUPLICATE YOUR FINISH, BUT BECAUSE OF THE NATURAL AND VARIED CHARACTERISTICS OF WOOD, SLIGHT VARIATIONS WILL OCCUR. IF A STRIKE-OFF IS REQUESTED, THE ORDER WILL BE HELD FROM PRODUCTION UNTIL THE CUSTOM/SPECIAL FINISH APPROVAL HAS BEEN RECEIVED IN WRITING AT THE FACTORY. AT THAT TIME, YOU WILL BE NOTIFIED OF THE SHIP/PRODUCTION DATE.

## GENERAL UPHOLSTERY INFORMATION

**SEAMING** WE RESERVE THE RIGHT TO SEAM PATTERNS IF NECESSARY. OUR UPHOLSTERY PATTERNS ARE BASED ON RAILROADED FABRIC. IF UPHOLSTERY, EITHER TRINITY FABRIC OR COM, IS TO BE APPLIED 'UP THE GOODS', SEAMS MAY BE REQUIRED. IF USING TRINITY LEATHER OR COL, SOME LARGER PATTERN PIECES MAY NEED TO BE SEAMED.

## PILLOWS

		<i>Overall: 18"w 5"d 18"h</i>	<i>COM: 1 yd.</i>	<i>COL: 18 sq.ft.</i>											
		<i>Overall: 22"w 5"d 12"h</i>	<i>COM: 1 yd.</i>	<i>COL: 18 sq.ft.</i>											
		<b>COM</b>	<b>COL</b>	<b>1</b>	<b>2</b>	<b>3</b>	<b>4</b>	<b>5</b>	<b>6</b>	<b>7</b>	<b>8</b>	<b>9</b>	<b>10</b>	<b>L1</b>	<b>L2</b>
<b>18" X 18" PILLOW</b>	<b>TP1818</b>	120	129	174	201	228	255	281	309	336	363	389	416	444	537
		<i>Feather Down Fill / Down Proof Ticking / Welting Around Parimeter Of Cushion</i>													
<b>12" X 22" PILLOW</b>	<b>TP1222</b>	76	85	131	157	184	211	239	265	292	319	346	372	401	497
		<i>Polyester Fill Only / Welting Around Parimeter Of Cushion</i>													

## Standard Wood Finishes And Matching Wilsonart Laminates



Finish: Clear Maple



Finish: Fusion Maple  
Matching Laminate: Wilsonart



Finish: Biltmore Cherry  
Matching Laminate: Wilsonart

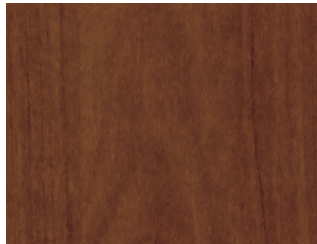

Finish: Williamsburg Cherry  
Matching Laminate: Wilsonart

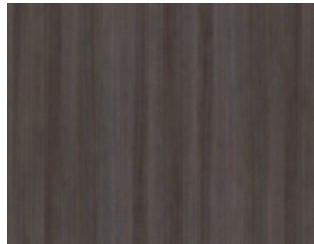

Finish: Skyline Walnut  
Matching Laminate: Wilsonart

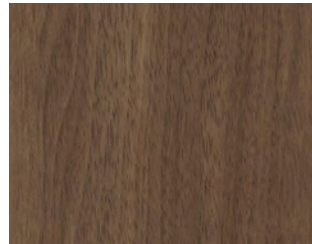

Finish: Pinnacle Walnut  
Matching Laminate: Wilsonart



Finish: Hampton Walnut  
Matching Laminate: Wilsonart

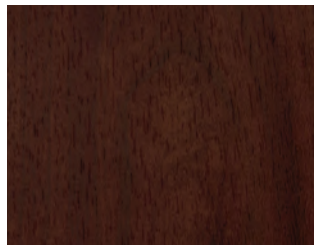

Finish: Cocobala Walnut  
Matching Laminate: Wilsonart

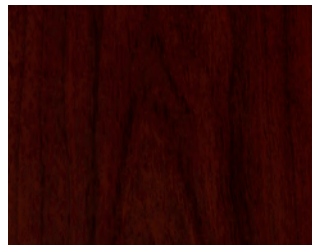

Finish: Empire Mahogany  
Matching Laminate: Wilsonart



Finish: Ebony  
Matching Laminate: Wilsonart



Laminate: White Nebula  
Wilsonart

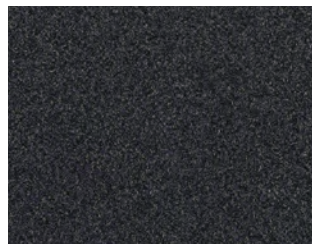

Laminate: Graphite Nebula  
Wilsonart

Due to variations in screen displays, finishes shown here may not match actual finishes exactly. These samples are a digital representation and are as accurate as technology will allow.

Wood color and grain characteristics will vary and exact matches are impossible.

These images are for color reference only. If you require an actual wood sample, please contact your representative or contact the factory.

### NOTE

When ordering a light to clear finish, the natural characteristics and variations in the grain of the wood will be more apparent. When ordering a dark or medium finish the natural characteristics and variations in the grain of the wood will be more subdued, providing a more uniform appearance. All colors shown are on solid cherry or maple, which are generally the standard wood species used for Trinity Furniture models. Certain models may use a different wood species with different grain characteristics. Please review the product specifications of each furniture item to be certain of the wood type used and available finishes. Special finish matches are also available. A finish sample is required and must be submitted to Trinity with the order.

*Note: Trinity will match finishes from DARRAN and Jasper Desk at no charge.*

### ANTIMICROBIAL PROPERTIES

All wood finishes are specially formulated with Safe-T-Guard antimicrobial additive to prevent the growth or expansion of mold, mildew, fungus, or bacteria on exposed wood surfaces.

### TABLES AVAILABLE WITH LAMINATE OR VENEER

Laminate Pairings are available for most wood finishes. Additional laminates are available.

Please contact customer service for more information.



Molded polyester resin arm caps are finished with a durable catalyzed acrylic polyurethane top coat yielding them highly resistant to hospital cleaners. A broad range of colors are available.

**POLYESTER ARM COLORS**  
(Durable Acrylic Polyurethane Finish)



53 Aqua



91 Ash



14 Bisque



99 Black

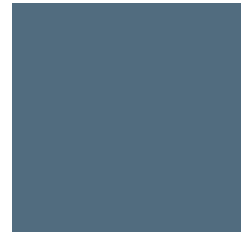

85 Blue

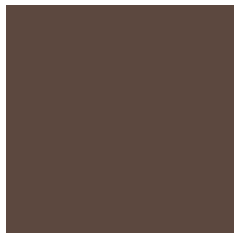

48 Brown



25 Burgundy



33 Camel



54 Cerulean

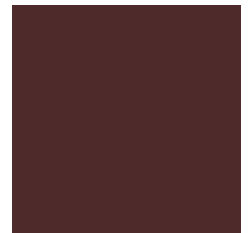

28 Cordovan



11 Cream



59 Deep Green



95 Grey



57 Hunter Green



10 Latte



75 Light Teal

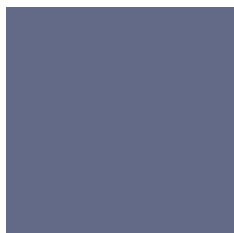

22 Lilac



89 Navy



88 Ocean



34 Paprika



44 Pebble

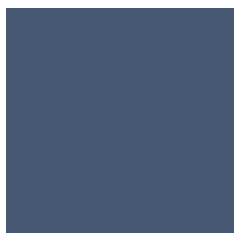

83 Periwinkle



27 Purple



13 Toast

## COM / COL INFORMATION

### CUSTOMERS OWN MATERIAL (COM) / CUSTOMERS OWN LEATHER (COL)

FABRIC, VINYL AND FAUX LEATHER, OR IF IT IS PURCHASED BY THE YARD, THEN USE THE COM COLUMN. IF IT IS PURCHASED BY THE SQUARE FOOT, THEN USE THE COL COLUMN.

#### GENERAL FURNITURE ORDERS MUST INCLUDE:

- 1- DESCRIPTION OF THE FABRIC(S) OR LEATHER(S),
- 2- SOURCE OF FABRIC(S) OR LEATHER(S)
- 3- PATTERN NUMBER AND COLOR
- 4- SWATCH OF THE FABRIC(S) OR LEATHER(S)

#### COM - ALL YARDAGE REQUIREMENTS ARE BASED ON 54" PLAIN NON-DIRECTIONAL MATERIAL.

VELVET OR NAPPED FABRICS WILL REQUIRE AN ADDITIONAL 15% OF OUR STANDARD COM YARDAGE REQUIREMENT.

COL - SQUARE FOOTAGE REQUIREMENTS ARE BASED ON LEATHER HIDES WHICH AVERAGE 45-50 SQ. FT.

**APPLICATION** ALL COM FABRICS WILL BE APPLIED AT FACTORY'S DISCRETION, (**ALL STRIPES WILL BE APPLIED VERTICAL**) UNLESS THE CUSTOMER SPECIFIES PATTERN AND FACE DIRECTION TO BE APPLIED, WITH SAMPLE ON THE PURCHASE ORDER. WE RESERVE THE RIGHT TO REJECT ANY MATERIAL THAT WE DEEM UNACCEPTABLE FOR UPHOLSTERY. UNDER NO CIRCUMSTANCES SHALL WE BE HELD RESPONSIBLE FOR UNSATISFACTORY RESULTS DUE TO USE OF MATERIAL UNSUITABLE FOR OUR MANUFACTURING METHODS. **TRINITY MUST APPROVE SPECIFIC FABRICS & LEATHERS USED FOR TUFTING. UPHOLSTERY PATTERNS ARE BASED ON RAILROADED FABRIC. IF COM IS TO BE APPLIED "UP THE GOODS", ADDITIONAL YARDAGE MAY BE REQUIRED. TUFTING AND STITCHED UNITS NEED PRE APPROVAL FOR STRIPED OR PATTERNED UPHOLSTERY.** CONTACT CUSTOMER SERVICE FOR SPECIFIC REQUIREMENTS.

**INSPECTION COM** – ALL COM IS INSPECTED UPON RECEIPT, FOR FLAWS, AND YARDAGE RECEIVED. WE DO NOT INSPECT YARDAGE RECEIVED FOR REPEATS OR PATTERN PLACEMENT UNTIL THE CUTTING PROCESS.

**COL** – ALL COL IS VERIFIED AT TIME OF RECEIPT, FOR FOOTAGE RECEIVED. DUE TO THE NATURE OF SOME COL, TRINITY FURNITURE DOES NOT INSPECT COL AT TIME OF RECEIPT FOR FLAWS, OR DEFECTS. THIS INSPECTION IS MADE DURING THE CUTTING PROCESS. TRINITY FURNITURE WILL NOT ASSUME RESPONSIBILITY FOR IMPERFECTIONS, INCLUDING RANGE MARKS, IN THE LEATHER, DYE-LOT VARIATIONS, OR WEARING QUALITIES.

**PRICING** USE THE COM OR COL PRICING LISTED UNDER EACH STYLE.

**ESTIMATED ADDITIONAL REQUIREMENTS BASED ON PATTERN REPEAT.**

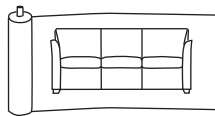

RAILROAD

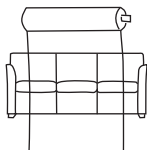

UP THE GOODS

WIDTH	REPEAT	RAILROAD 1-WAY REPEAT	UP THE GOODS 1-WAY REPEAT	NAP OR SUEDE
54"	LESS THAN 2"	0%	15%	15%
	2-10"	10%	20%	
	11-19"	15%	25%	
	20-25"	20%	30%	
	26-30"	25%	35%	
51-53"	LESS THAN 2"	10%	20%	25%
	2-10"	20%	30%	
	11-19"	25%	35%	
	20-25"	30%	40%	
	26-30"	35%	45%	

ACTUAL QUANTITY MAY VARY DUE TO THE DIFFERENCE OF THE INDIVIDUAL FURNITURE STYLE, YOUR UPHOLSTERY SELECTION, AND ITS CUTTING REQUIREMENT.

THE LINK BELOW PROVIDES MORE INFORMATION CONCERNING UPHOLSTERY OPTIONS:

[www.trinityfurniture.com/fabricsleather](http://www.trinityfurniture.com/fabricsleather)

**RETURN EXCESS**

UNUSED COM OR COL WILL BE RETURNED ONLY WHEN REQUESTED IN WRITING. THERE IS A MINIMUM \$15 HANDLING CHARGE PLUS ANY APPLICATION SHIPPING CHARGE.

**SHIP DATE**

ALL ORDERS ARE HELD FROM PRODUCTION UNTIL ALL THE COM/COL HAS ARRIVED AT THE FACTORY, UNLESS WRITTEN AUTHORIZATION FOR BACK ORDER IS GIVEN. AT THAT TIME, YOU WILL BE NOTIFIED OF THE SHIP/PRODUCTION DATE.

**SHIP TO ADDRESS**

COM / COL MUST BE SHIPPED PREPAID TO FACTORY AT:

**TRINITY FURNITURE INCORPORATED**

**TAG: YOUR COMPANY NAME AND PURCHASE ORDER NUMBER**  
**6089 KENNEDY ROAD**  
**TRINITY, NC 27370**

**TRINITY TEXTILE INFORMATION**

ALL OF OUR CARDED TEXTILES PASS CALIFORNIA CODE 117 FLAME RESISTANCE REQUIREMENTS. ALL UPHOLSTERY COVERS SHOWN IN OUR BINDER OR SPECIFIED VIA ONE OF OUR UPHOLSTERY CARDS, CAN BE PURCHASED BY THE YARD. SEE CHART BELOW FOR GRADE PRICE PER YARD. F.O.B. FACTORY, TRINITY, NC. FOR FIBER CONTENT, SEE SWATCH CARD. MINIMUM ORDER FOR FABRIC IS 1" YARD, THEN ¼ YARD INCREMENTS. MINIMUM ORDER FOR LEATHER IS ONE HALF HIDE, APPROXIMATELY 25 SQ. FT. WE WILL MAKE EVERY EFFORT TO SUPPLY YOU WITH THE EXACT SQUARE FOOTAGE ORDERED, BUT IF WE ARE UNABLE TO, YOU WILL BE INVOICED FOR SQUARE FOOTAGE OF LEATHER SHIPPED.

**GRADE-IN PROGRAM** ARC COM TEXTILES, MOMENTUM TEXTILES, CF STINSON AND MAYER FABRICS MAY BE SPECIFIED TO BE SUPPLIED, AND GRADED-IN BY TRINITY. ON PATTERN GRADES ( 11 - 25 ) NOT FALLING INTO THE PRICE LIST GRADES ( 1 - 10 ) USE THE CHART BELOW. MULTIPLY THE LIST PRICE PER YARD (LISTED BELOW), TO THE C.O.M. REQUIREMENTS LISTED WITH YOUR STYLE ON ITS PRICE PAGE, THEN ADD THAT AMOUNT TO YOUR STYLES C.O.M. LIST PRICE. THIS WILL BECOME YOUR GRADED-IN LIST PRICE. (FOR EXAMPLE USING GRADE 11 UPHOLSTERY: STYLE COM REQUIREMENT IS 2 YARDS, AND GRADE 11 LIST PRICE IS \$258 PER YARD. 2 (YARDS) X \$258 (PER YARD) = \$516. ADD THIS AMOUNT TO COM LIST PRICE, THEREFORE, GIVING YOU THE GRADE 11 LIST PRICE).

GRADE	1	2	3	4	5	6	7	8	9	10	11	12	13	14	15	16	17	18	19	20	21	22	23	24	25	L1	L2
LIST	43	64	86	107	129	150	172	193	215	236	258	279	301	322	344	365	386	408	429	451	472	494	515	537	558	15	19

**TRINITY TEXTILE LINKS**

THE LINK BELOW PROVIDES MORE INFORMATION CONCERNING UPHOLSTERY OPTIONS.

GRADE-IN FABRICS FROM EACH MANUFACTURER IS SORTED ALPHABETICAL OR BY GRADE, AND IS AVAILABLE ON OUR WEBSITE.

[www.trinityfurniture.com/fabricsleather](http://www.trinityfurniture.com/fabricsleather)



Memo Samples:  
[www.anzea.com](http://www.anzea.com)  
 817-336-2310



Memo Samples:  
[www.arc-com.com](http://www.arc-com.com)  
 800-223-5466



Memo Samples:  
[www.architex-ljh.com](http://www.architex-ljh.com)  
 800-621-0827



Memo Samples:  
[www.carnegiefabrics.com](http://www.carnegiefabrics.com)  
 1-800-727-6770



Memo Samples:  
[www.concertex.com](http://www.concertex.com)  
 201-784-8370



Memo Samples:  
[www.dougind.com](http://www.dougind.com)  
 800-950-3684



Memo Samples:  
[www.greenhides.com](http://www.greenhides.com)  
 336-315-9720



Memo Samples:  
[www.mayerfabrics.com](http://www.mayerfabrics.com)  
 800-428-4415



Memo Samples:  
[www.themomgroup.com](http://www.themomgroup.com)  
 800-366-6839



Memo Samples:  
[www.panaz.com](http://www.panaz.com)  
 919-747-2842



Memo Samples:  
[www.cfstinson.com](http://www.cfstinson.com)  
 800-841-6279



Memo Samples:  
[www.ultrafabricsllc.com](http://www.ultrafabricsllc.com)  
 877-309-6648

GS-27F-028DA

71, Part 1 – Office Furniture

Small, Minority Owned Business

May 17, 2021 - May 16, 2026

**1a. Special item numbers:**

NAICS 337211 Wood Office Furniture

**1b. Special item number's lowest unit price:**

NAICS 337211 Wood Office Furniture | Style # 855-P \$265.50

**2. Maximum order limitation:**

NAICS 337211 Wood Office Furniture | \$300,000

**3. Minimum order limitation:** \$50.00 (Net order value).

**4. Geographic coverage:** 48 Contiguous states and District of Columbia.

**5. Point of Production:** Trinity Furniture, Inc. Phone: (336) 472-6660  
6089 Kennedy Road  
Trinity NC 27370

**6. Discount:** Prices shown are commercial list, discount to be deducted, and includes cartoning. Fifty-five percent of list. (List x .45)

**7. Quantity discount, net:** \$25,001 - \$50,000 1% \$50,001 - \$100,000 2% \$100,001 - \$200,000 3%  
\$200,001 - \$300,000 4%

**8. Payment terms:** Net 30 Days.

**9a. & b. Government Commercial credit cards** are accepted above and below the micropurchase threshold.

**10. Foreign items:** None.

**11a. Time of delivery:** 49 – 90 days ARO.

**11b., c., and d. Expedited delivery, Overnight and second day delivery and urgent requirements:** Contact Customer Service

**12. FOB Point:** Origin, Trinity NC

**13a. Ordering address:** Trinity Furniture, Inc. Phone: (336) 472-6660 Federal ID # 56-1414163  
PO Box 150 Fax: (336) 475-0037 Duns # 11-598-8651  
Trinity NC 27370 E-Mail: [sales@trinityfurniture.com](mailto:sales@trinityfurniture.com) Cage code # 3Z744  
Internet: [www.trinityfurniture.com](http://www.trinityfurniture.com) CEC # 11699875J

**13b. Ordering Procedures:** For supplies and series sample BPA order visit [www.gsa.gov/portal/content/199353](http://www.gsa.gov/portal/content/199353) or [www.trinityfurniture.com/federal](http://www.trinityfurniture.com/federal)

**14. Payment Address:** Trinity Furniture, Inc.  
PO Box 150  
Trinity NC 27370

**15. Warranty:** Trinity Furniture warrants all products for ten (10) years, excluding covering materials, against manufacturing and factory defects, under normal service for the original purchaser. During this period Trinity Furniture, Inc., at our option, will replace, repair, or return the purchase price of any merchandise that, upon our inspection, is deemed to be defective. This constitutes the sole and exclusive remedy to the customer. Damages resulting from freight, claimed or un-claimed, from accident, alternation, tampering, misuse, negligence or abuse voids the warranty. In the event any product has to be returned to the factory for verification of a complaint, it must be shipped prepaid and include written information containing the name of the original purchaser, original invoice number and a copy of the original purchase order. Because of natural variations on materials over which Trinity Furniture has no control, this warranty is applicable only to those parts actually manufactured by Trinity Furniture, Inc. For purchased parts, we will apply exactly the same warranty that is extended to us by our suppliers. Trinity Furniture shall not be liable for consequential or incidental damages arising from any product defects.

**16. Export packaging charges:** Quoted upon request.

**17. Credit card terms and condition:** Government credit cards are accepted without any additional discounts.

**18. Terms and conditions of rental, maintenance and repair:** Not Applicable.

**19. Terms and conditions of installation:** Contact customer service.

**20a. & b Terms and conditions of repair parts or any other service:** See price list or contact customer service.

**21. List of service and distribution points:** Contact customer service.

**22. List of participating dealer:** Contact customer service.

**23. Preventative maintenance:** Not applicable.

**24a. Sustainable attributes:** All of Trinity Furniture's products are certified BIFMA Level 1.

**24b. Section 508 compliance for electronic and information technology (if applicable):** Not applicable

**25. DUNS:** #11-598-8651

**26. CCR:** Yes

**27. Uncompensated overtime (indicate if used):** Not used.

**28. Restocking terms:** All items are made to order. No returns are accepted.

**29. Cancellation terms:** Cancellations cannot be accepted after orders are in production. If the agency insists upon cancellation, we will bill for the portion of the work that has been done plus a 25% restocking/administration charge.

# 15 Day Quickship Program

---

GUEST / LOUNGE

Effective: August 1, 2022

T R I N I T Y

**Date:**

**Page:**

**Modification:**

**Description:**

---



Timelines change and projects are continually evolving. Here at Trinity Furniture, we believe all projects deserve quality furniture, even the ones with the most challenging timelines. Our Quickship offering includes essential pieces that ship within 15 business days...offering clients a smart solution for Healthcare, Workplace, and Institutional Markets.

### FINISHES (QS-1501, QS-1801, QS-1802, QS-1822 Units Only)

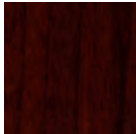

Empire Mahogany



Hampton Walnut



Ebony

### UPHOLSTERY

#### SUSTAINABILITY: Grade 1

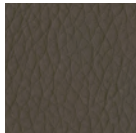

Java



Ocean

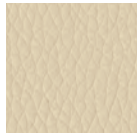

Buff



Thunder



Stratus

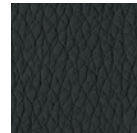

Black

#### ARGENT: Grade 2

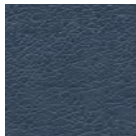

Batik

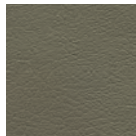

Quarry

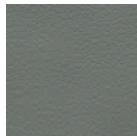

Metal

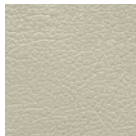

Cream

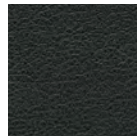

Black

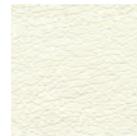

White

#### BEELINE EPU: Grade 3



Forge



Portobello

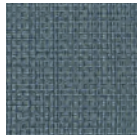

Lake



Eclipse



Nimbus



Oat

#### CANTER EPU: Grade 3

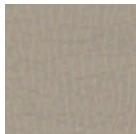

Quarry

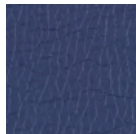

Ink

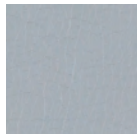

Lucid

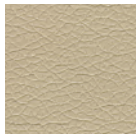

Sand Dollar

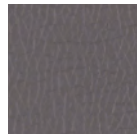

Storm

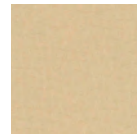

Sand

#### GROOVE EPU: Grade 4



Harbor



Khaki

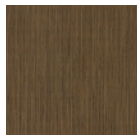

Guide

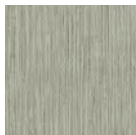

Stone



Glacier



Archive

### QUICKSHIP PROGRAM DETAILS

- The entire Quickship offering is showcased on this web page, detailing available product models, specifications and images.
- All Quickship items are indicated as such by the QS - prefix on all model numbers.
- All Quickship orders should be designated as such on the PO.
- Items will be shipped on or before 15 business days from receipt of a complete order.
- All Quickship orders are subject to inventory levels and credit approval.
- Official Holidays and Factory closings may add to the acknowledgement lead times of Quickship orders.
- All Quickship orders are limited to a maximum quantity of 15 pieces per order, per model number.
- Shipments are allowed only to a single destination with no split shipments.
- Purchase orders must include only Quickship items.
- Cancellations or changes to Quickship orders are not allowed under any circumstances.

**DESCRIPTION:**

- Upholstery Frames: Steel, Plywood & Hardwood
- Seat: High Density Polyurethane Foam Over Strap Webbing
- Back: High Density Polyurethane Foam Over Sinuous Wire Springs
- Upholstered Covers: Attached w/ Velcro / Removable For Maintenance
- Antimicrobial Moisture Barrier Fully Encapsulates All Foam Areas
- Double Needle Stitching Standard (Welting Optional - No Charge)
- Exposed Wood Legs: Solid Hardwood / Removable For Maintenance
- Leather Upholstery Not Available
- 1501: 500 lbs. Weight Rating
- Lifetime Warranty

**OPTIONS:**

Call For Availability

Specify Exposed Wood Finish & Upholstery  
(See 15 Day Quickship Program - Order Information)

**LOUNGE**

ITEM #:

SPECIFICATIONS | GRADES | LIST PRICES:

LOUNGE CHAIR /  
FULLY UPHOLSTERED

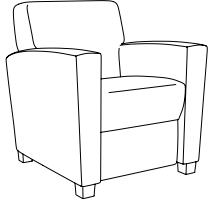

QS1501

**Overall:** 31.25"w 31"d 34.5"h      **Arm:** 25.5"h      **COM:** 5.25 yds.  
**Seat:** 21"w 20"d 18"h      **Weight:** 80 lbs.      **COL:** n/a

COM	COL	1	2	3	4	5	6	7	8	9	10	L1	L2
1569	N/A	1763	1901	2038	2176	2313	2451	2588	2726	2863	3001	N/A	N/A

*Tight Seat & Back / Removable Upholstery*



**DESCRIPTION:**

- Upholstery Frames: Steel, Plywood & Hardwood
- Seat: High Density Polyurethane Foam Over Strap Webbing
- Back: High Density Polyurethane Foam Over Sinuous Wire Springs
- Upholstered Covers: Attached w/ Velcro / Removable For Maintenance
- Antimicrobial Moisture Barrier Fully Encapsulates All Foam Areas
- Double Needle Stitching Standard (Welting Optional - No Charge)
- Exposed Wood Legs: Solid Hardwood / Removable For Maintenance
- Leather Upholstery Not Available
- 1801: 500 lbs. Weight Rating / 1802: 1000 lbs. Weight Rating
- Lifetime Warranty

**OPTIONS:**

Call For Availability

Specify Exposed Wood Finish & Upholstery  
(See 15 Day Quickship Program - Order Information)

**LOUNGE**

**ITEM #: SPECIFICATIONS | GRADES | LIST PRICES:**

**LOUNGE CHAIR / FULLY UPHOLSTERED**

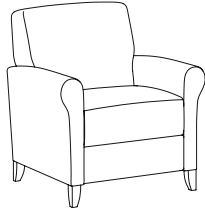

**QS1801**

**Overall:** 31"w 32"d 34"h      **Arm:** 24"h      **COM:** 4.75 yds.  
**Seat:** 21"w 20"d 18.5"h      **Weight:** 82 lbs.      **COL:** n/a

COM	COL	1	2	3	4	5	6	7	8	9	10	L1	L2
1588	N/A	1694	1840	1964	2087	2211	2335	2459	2582	2706	2830	N/A	N/A

*Tight Seat & Back / Removable Upholstery*

**TWO PLACE SOFA / FULLY UPHOLSTERED**

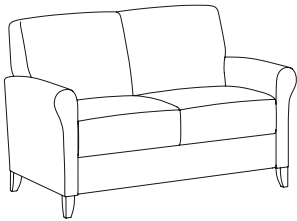

**QS1802**

**Overall:** 57"w 32"d 34"h      **Arm:** 24"h      **COM:** 6.75 yds.  
**Seat:** 47.5"w 20"d 18.5"h      **Weight:** 120 lbs.      **COL:** n/a

COM	COL	1	2	3	4	5	6	7	8	9	10	L1	L2
2418	N/A	2639	2799	2928	3107	3286	3464	3643	3822	4000	4179	N/A	N/A

*Tight Seat & Back / Removable Upholstery*



**DESCRIPTION:**

- Upholstery Frames: Steel, Plywood & Hardwood
- Seat: High Density Polyurethane Foam Over Strap Webbing
- Back: High Density Polyurethane Foam Over Plywood
- Upholstered Covers: Stapled On Seat & Back
- Urethane Arm Caps - Standard
- Exposed Metal Legs: 14 Gauge Steel Tubing / Powder Coated (Wallsaver Back Legs)
- Leather Upholstery Not Available
- Adjustable Height Leveling Glides Standard
- 10 Year Warranty

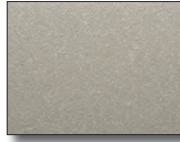

Leg Color: Champagne

**OPTIONS:**

Call For Availability

Specify Upholstery  
(See 15 Day Quickship Program - Order Information)

**GUEST**

ITEM #:

SPECIFICATIONS | GRADES | LIST PRICES:

ARM SIDE CHAIR / URETHANE ARMS

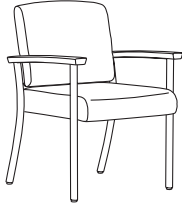

QS1922

**Overall:** 23.25"w 25.5"d 34"h      **Arm:** 25"h      **COM:** 1.75 yds.  
**Seat:** 20"w 18.25"d 18.5"h      **Weight:** 45 lbs.      **COL:** n/a

COM	COL	1	2	3	4	5	6	7	8	9	10	L1	L2
1354	N/A	1361	1382	1415	1447	1479	1511	1543	1575	1607	1639	N/A	N/A

*Open Back / Tight Seat & Back*

# Behavioral Health

---

GUEST / LOUNGE /  
BENCHES, OTTOMANS & TABLES

Effective: August 1, 2022

T R I N I T Y

**Date:**

**Page:**

**Modification:**

**Description:**

---

**DESCRIPTION:**

- Frames: Steel, Plywood & Hardwood
- Recycled Steel Inner-Frame 1-1/2" X 1-1/2" Angle Iron To Double 11 Gauge Square Tubing
- Metal To Metal Construction
- Upholstery: Tight Cushion (Stapled On Covers Standard)
- Seat: High Density Polyurethane Foam Over Sheet Webbing
- Back: High Density Polyurethane Foam Over Sinuous Springs & Hardwood Plywood
- Arms Caps: Held In Place By Non-Removable Helical Fasteners

- Legs: Exposed Wood, Metal Or Solid Hardwood / Removable For Maintenance
- Full Underbody Panel
- Tamperproof Screws On Seat Pan
- Full Clean-Out Between Seat & Back
- No Exposed Hardware Or "Pick Points"
- All Staples Are Concealed & Inaccessible
- Lifetime Warranty

**ENHANCEMENTS:**

- Vacuum Formed ABS Under Panel With Drain ..... Call For Pricing
  - Additional Weight Can Be Added To The Seat ..... Call For Pricing
  - Can Be Bolted To Floor ..... Call For Pricing
  - Velcro Replaceable Seat Cover w/ Antimicrobial Moisture Barrier ..... Call For Pricing
- Bariatric Sizes Available: 500 lbs. - 1000 lbs.  
Specify Exposed Wood Finish (See Page 6)

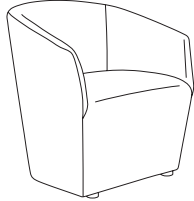
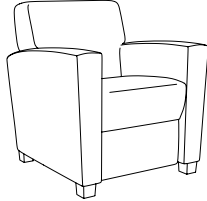
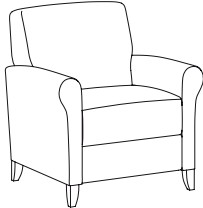
LOUNGE		ITEM #:	SPECIFICATIONS   GRADES   LIST PRICES:												
	LOUNGE CHAIR / FULLY UPHOLSTERED	BH341-A	Overall: 30"w 24.5"d 31.5"h			Arm: 25.5"h			COM: 3.25 yds.						
			Seat: 24"w 19"d 18.5"h			Weight: 58 lbs.			COL: 59 sq.ft.						
	COM		COL	1	2	3	4	5	6	7	8	9	10	L1	L2
			CALL FOR PRICING <i>Tight Seat &amp; Back / Round Black Plastic Legs</i>												
	LOUNGE CHAIR / FULLY UPHOLSTERED	BH1501	Overall: 31.25"w 31"d 34.5"h			Arm: 25.5"h			COM: 5.25 yds.						
			Seat: 21"w 20"d 18"h			Weight: 80 lbs.			COL: n/a						
	COM		COL	1	2	3	4	5	6	7	8	9	10	L1	L2
			CALL FOR PRICING <i>Tight Seat &amp; Back / Removable Upholstery</i>												
	LOUNGE CHAIR / FULLY UPHOLSTERED	BH1801	Overall: 31"w 32"d 34"h			Arm: 24"h			COM: 4.75 yds.						
			Seat: 21"w 20"d 18.5"h			Weight: 82 lbs.			COL: n/a						
	COM		COL	1	2	3	4	5	6	7	8	9	10	L1	L2
			CALL FOR PRICING <i>Tight Seat &amp; Back / Removable Upholstery</i>												

**DESCRIPTION:**

- Upholstery Frames: Hardwood Plywood
- Seat: High Density Polyurethane Foam Over Hardwood Plywood
- Round Black Plastic Feet / Non-Removable
- Full Underbody Panel (Tamper Proof Hardware)
- No Exposed Hardware Or "Pick Points"
- All Staples Are Concealed & Inaccessible
- Ganging Connectors (Optional - Call For Pricing)
- Leather Upholstery Is Available
- Lifetime Warranty

**ENHANCEMENTS:**

- Additional Weight Can Be Added To The Inside Of The Frame..... Call For Pricing
- Can Be Bolted To Floor ..... Call For Pricing
- Velcro Replaceable Seat Cover w/ Antimicrobial Moisture Barrier ..... Call For Pricing

See Facelift Behavioral Health Options For Applicable Options

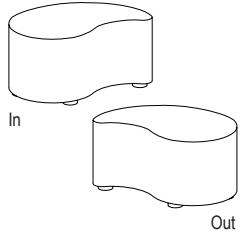
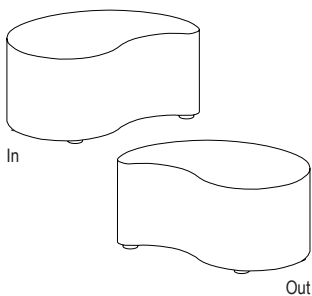
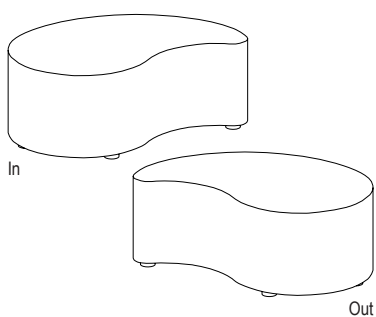
BENCHES		ITEM #:	SPECIFICATIONS   GRADES   LIST PRICES:													
<b>SMALL BENCH / FULLY UPHOLSTERED</b>			<i>Overall: 18"w 30"d 14"h</i>			<i>Arm: n/a</i>			<i>COM: 2.75 yds.</i>							
			<i>Seat: 14"h</i>			<i>Weight: TBD lbs.</i>			<i>COL: 50 sq.ft.</i>							
			COM	COL	1	2	3	4	5	6	7	8	9	10	L1	L2
		<b>BH1540-I</b>	CALL FOR PRICING <i>Small Size - In / Tight Seat / Removable Upholstery</i>													
		<b>BH1540-O</b>	CALL FOR PRICING <i>Small Size - Out / Tight Seat / Removable Upholstery</i>													
<b>MEDIUM BENCH / FULLY UPHOLSTERED</b>			<i>Overall: 24"w 40"d 18"h</i>			<i>Arm: n/a</i>			<i>COM: 3.00 yds.</i>							
			<i>Seat: 18"h</i>			<i>Weight: TBD lbs.</i>			<i>COL: 54 sq.ft.</i>							
			COM	COL	1	2	3	4	5	6	7	8	9	10	L1	L2
		<b>BH1541-I</b>	CALL FOR PRICING <i>Medium Size - In / Tight Seat / Removable Upholstery</i>													
		<b>BH1541-O</b>	CALL FOR PRICING <i>Medium Size - Out / Tight Seat / Removable Upholstery</i>													
<b>LARGE BENCH / FULLY UPHOLSTERED</b>			<i>Overall: 30"w 50"d 18"h</i>			<i>Arm: n/a</i>			<i>COM: 3.25 yds.</i>							
			<i>Seat: 18"h</i>			<i>Weight: TBD lbs.</i>			<i>COL: 59 sq.ft.</i>							
			COM	COL	1	2	3	4	5	6	7	8	9	10	L1	L2
		<b>BH1542-I</b>	CALL FOR PRICING <i>Large Size - In / Tight Seat / Removable Upholstery</i>													
		<b>BH1542-O</b>	CALL FOR PRICING <i>Large Size - Out / Tight Seat / Removable Upholstery</i>													

**DESCRIPTION:**

- Upholstery Frames: Hardwood Plywood
- Seat: High Density Polyurethane Foam Over Hardwood Plywood
- Round Black Plastic Feet / Non-Removable
- Full Underbody Panel (Tamper Proof Hardware)
- No Exposed Hardware Or "Pick Points"
- All Staples Are Concealed & Inaccessible
- Ganging Connectors (Optional - Call For Pricing)
- Leather Upholstery Is Available
- Lifetime Warranty

**ENHANCEMENTS:**

- Additional Weight Can Be Added To The Inside Of The Frame..... Call For Pricing
- Can Be Bolted To Floor ..... Call For Pricing
- Velcro Replaceable Seat Cover w/ Antimicrobial Moisture Barrier ..... Call For Pricing

See Facelift Behavioral Health Options For Applicable Options

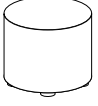
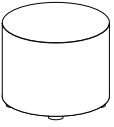
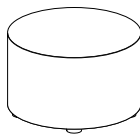
OTTOMANS		ITEM #:	SPECIFICATIONS   GRADES   LIST PRICES:															
<p>SMALL ROUND OTTOMAN / FULLY UPHOLSTERED</p> 	BH1543-18D	<p><b>Overall:</b> 18" Diameter 14"h</p> <p><b>Seat:</b> 14"h</p>	<p><b>Arm:</b> n/a</p> <p><b>Weight:</b> TBD lbs.</p>	<p><b>COM:</b> 2.00 yds.</p> <p><b>COL:</b> 36 sq.ft.</p>	COM	COL	1	2	3	4	5	6	7	8	9	10	L1	L2
		CALL FOR PRICING																
		<i>Small Size / Tight Seat / Removable Upholstery</i>																
<p>MEDIUM ROUND OTTOMAN / FULLY UPHOLSTERED</p> 	BH1543-24D	<p><b>Overall:</b> 24" Diameter 18"h</p> <p><b>Seat:</b> 18"h</p>	<p><b>Arm:</b> n/a</p> <p><b>Weight:</b> 46 lbs.</p>	<p><b>COM:</b> 2.25 yds.</p> <p><b>COL:</b> 41 sq.ft.</p>	COM	COL	1	2	3	4	5	6	7	8	9	10	L1	L2
		CALL FOR PRICING																
		<i>Medium Size / Tight Seat / Removable Upholstery</i>																
<p>LARGE ROUND OTTOMAN / FULLY UPHOLSTERED</p> 	BH1543-30D	<p><b>Overall:</b> 30" Diameter 18"h</p> <p><b>Seat:</b> 18"h</p>	<p><b>Arm:</b> n/a</p> <p><b>Weight:</b> TBD lbs.</p>	<p><b>COM:</b> 2.50 yds.</p> <p><b>COL:</b> 45 sq.ft.</p>	COM	COL	1	2	3	4	5	6	7	8	9	10	L1	L2
		CALL FOR PRICING																
		<i>Large Size / Tight Seat / Removable Upholstery</i>																



**DESCRIPTION:**

- Upholstery Frames: Hardwood Plywood
- Table Top: High Pressure Laminate Top Over Plywood Core
- Seat: High Density Polyurethane Foam Over Hardwood Plywood
- Round Black Plastic Feet / Non-Removable
- Full Underbody Panel (Tamper Proof Hardware)
- No Exposed Hardware Or "Pick Points"
- All Staples Are Concealed & Inaccessible
- Ganging Connectors (Optional - Call For Pricing)
- Leather Upholstery Is Available
- Lifetime Warranty

**ENHANCEMENTS:**

- Additional Weight Can Be Added To The Inside Of The Frame..... Call For Pricing
- Can Be Bolted To Floor ..... Call For Pricing
- Velcro Replaceable Seat Cover w/ Antimicrobial Moisture Barrier ..... Call For Pricing

See Facelift Behavioral Health Options For Applicable Options

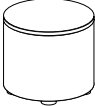
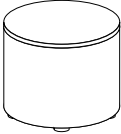
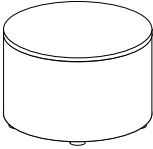
TABLES		ITEM #:	SPECIFICATIONS   GRADES   LIST PRICES:												
	<p><b>SMALL ROUND TABLE / UPHOLSTERED BASE</b></p>	<p><b>BH1544-18T</b></p>	<p><b>Overall:</b> 18" Diameter 14"h</p>			<p><b>Arm:</b> n/a</p>			<p><b>COM:</b> 1.25 yds.</p>						
			<p><b>Seat:</b> 14"h</p>			<p><b>Weight:</b> TBD lbs.</p>			<p><b>COL:</b> 23 sq.ft.</p>						
			COM	COL	1	2	3	4	5	6	7	8	9	10	L1
<p>CALL FOR PRICING</p> <p><i>Small Size / High Pressure Laminate Top / Removable Upholstery</i></p>															
	<p><b>MEDIUM ROUND TABLE / UPHOLSTERED BASE</b></p>	<p><b>BH1544-24T</b></p>	<p><b>Overall:</b> 24" Diameter 18"h</p>			<p><b>Arm:</b> n/a</p>			<p><b>COM:</b> 1.50 yds.</p>						
			<p><b>Seat:</b> 18"h</p>			<p><b>Weight:</b> TBD lbs.</p>			<p><b>COL:</b> 27 sq.ft.</p>						
			COM	COL	1	2	3	4	5	6	7	8	9	10	L1
<p>CALL FOR PRICING</p> <p><i>Medium Size / High Pressure Laminate Top / Removable Upholstery</i></p>															
	<p><b>LARGE ROUND TABLE / UPHOLSTERED BASE</b></p>	<p><b>BH1544-30T</b></p>	<p><b>Overall:</b> 30" Diameter 18"h</p>			<p><b>Arm:</b> n/a</p>			<p><b>COM:</b> 1.75 yds.</p>						
			<p><b>Seat:</b> 18"h</p>			<p><b>Weight:</b> TBD lbs.</p>			<p><b>COL:</b> 32 sq.ft.</p>						
			COM	COL	1	2	3	4	5	6	7	8	9	10	L1
<p>CALL FOR PRICING</p> <p><i>Large Size / High Pressure Laminate Top / Removable Upholstery</i></p>															

**DESCRIPTION:**

- Upholstery Frames: Hardwood Plywood
- Table Top: High Pressure Laminate Top Over Plywood Core
- Seat: High Density Polyurethane Foam Over Hardwood Plywood
- Round Black Plastic Feet / Non-Removable
- Full Underbody Panel (Tamper Proof Hardware)
- No Exposed Hardware Or "Pick Points"
- All Staples Are Concealed & Inaccessible
- Ganging Connectors (Optional - Call For Pricing)
- Leather Upholstery Is Available
- Lifetime Warranty

**ENHANCEMENTS:**

- Additional Weight Can Be Added To The Inside Of The Frame..... Call For Pricing
- Can Be Bolted To Floor ..... Call For Pricing
- Velcro Replaceable Seat Cover w/ Antimicrobial Moisture Barrier ..... Call For Pricing

See Facelift Behavioral Health Options For Applicable Options

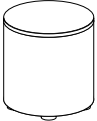
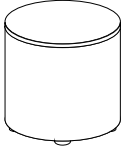
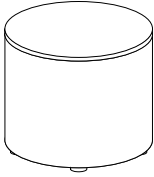
TABLES		ITEM #:	SPECIFICATIONS   GRADES   LIST PRICES:															
<p>TALL SMALL ROUND TABLE / UPHOLSTERED BASE</p> 	BH1545-18T	<p><b>Overall:</b> 18" Diameter 18"h</p> <p><b>Seat:</b> 18"h</p>	<p><b>Arm:</b> n/a</p> <p><b>Weight:</b> TBD lbs.</p>	<p><b>COM:</b> 1.25 yds.</p> <p><b>COL:</b> 23 sq.ft.</p>	COM	COL	1	2	3	4	5	6	7	8	9	10	L1	L2
		CALL FOR PRICING																
		Small Size / High Pressure Laminate Top / Removable Upholstery																
<p>TALL MEDIUM ROUND TABLE / UPHOLSTERED BASE</p> 	BH1545-24T	<p><b>Overall:</b> 24" Diameter 24"h</p> <p><b>Seat:</b> 24"h</p>	<p><b>Arm:</b> n/a</p> <p><b>Weight:</b> TBD lbs.</p>	<p><b>COM:</b> 1.50 yds.</p> <p><b>COL:</b> 27 sq.ft.</p>	COM	COL	1	2	3	4	5	6	7	8	9	10	L1	L2
		CALL FOR PRICING																
		Medium Size / High Pressure Laminate Top / Removable Upholstery																
<p>TALL LARGE ROUND TABLE / UPHOLSTERED BASE</p> 	BH1545-30T	<p><b>Overall:</b> 30" Diameter 24"h</p> <p><b>Seat:</b> 24"h</p>	<p><b>Arm:</b> n/a</p> <p><b>Weight:</b> TBD lbs.</p>	<p><b>COM:</b> 1.75 yds.</p> <p><b>COL:</b> 32 sq.ft.</p>	COM	COL	1	2	3	4	5	6	7	8	9	10	L1	L2
		CALL FOR PRICING																
		Large Size / High Pressure Laminate Top / Removable Upholstery																

**CONFIGURATION EXAMPLES:**

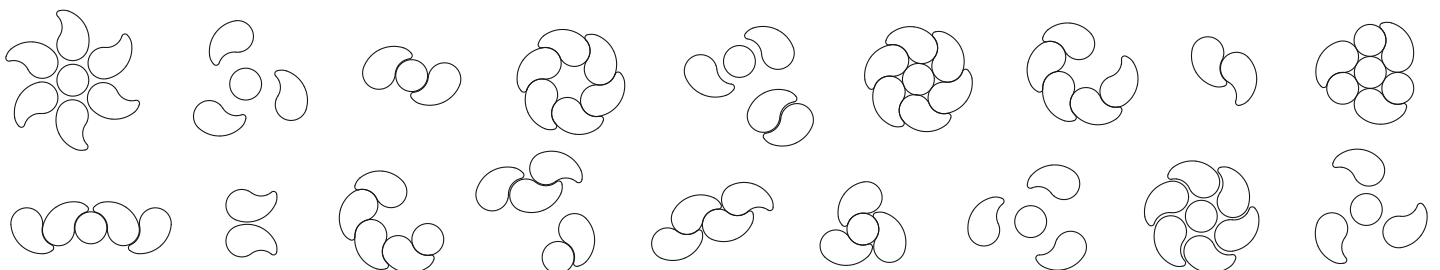

**DESCRIPTION:**

- Frames: Steel, Plywood & Hardwood
- Recycled Steel Inner-Frame 1-1/2" X 1-1/2" Angle Iron To Double 11 Gauge Square Tubing
- Metal To Metal Construction
- Upholstery: Tight Cushion (Stapled On Covers Standard)
- Seat: High Density Polyurethane Foam Over Sheet Webbing
- Back: High Density Polyurethane Foam Over Sinuous Springs & Hardwood Plywood
- Arms Caps: Held In Place By Non-Removable Helical Fasteners

- Legs: Exposed Wood, Solid Hardwood / Removable For Maintenance
- Full Underbody Panel
- Tamperproof Screws On Seat Pan
- Full Clean-Out Between Seat & Back
- No Exposed Hardware Or "Pick Points"
- All Staples Are Concealed & Inaccessible
- Lifetime Warranty

**ENHANCEMENTS:**

- Vacuum Formed ABS Under Panel With Drain ..... Call For Pricing
  - Additional Weight Can Be Added To The Seat ..... Call For Pricing
  - Can Be Bolted To Floor ..... Call For Pricing
  - Velcro Replaceable Seat Cover w/ Antimicrobial Moisture Barrier ..... Call For Pricing
- Bariatric Sizes Available: 500 lbs. - 1000 lbs.  
Specify Exposed Wood Finish (See Page 6)

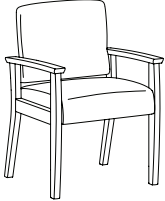
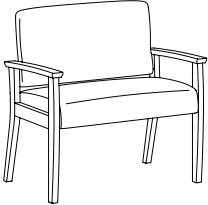
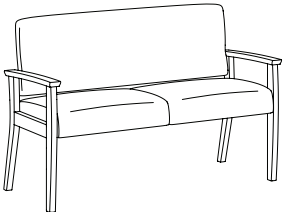
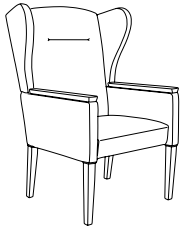
GUEST	ITEM #:	SPECIFICATIONS   GRADES   LIST PRICES:													
	BH1822	<b>Overall:</b> 23.5"w 24"d 34"h		<b>Arm:</b> 25"h		<b>COM:</b> 1.75 yds.									
		<b>Seat:</b> 20"w 19"d 18.5"h		<b>Weight:</b> 45 lbs.		<b>COL:</b> n/a									
		COM	COL	1	2	3	4	5	6	7	8	9	10	L1	L2
CALL FOR PRICING <i>Open Back / Tight Seat &amp; Back</i>															
	BH1832	<b>Overall:</b> 33.5"w 24"d 34"h		<b>Arm:</b> 25"h		<b>COM:</b> 2.25 yds.									
		<b>Seat:</b> 30"w 19"d 18.5"h		<b>Weight:</b> 55 lbs.		<b>COL:</b> n/a									
		COM	COL	1	2	3	4	5	6	7	8	9	10	L1	L2
CALL FOR PRICING <i>Open Back / Tight Seat &amp; Back / 500 lb. Weight Capacity</i>															
	BH1850	<b>Overall:</b> 51.5"w 24"d 34"h		<b>Arm:</b> 25"h		<b>COM:</b> 3.5 yds.									
		<b>Seat:</b> 48"w 19"d 18.5"h		<b>Weight:</b> 65 lbs.		<b>COL:</b> n/a									
		COM	COL	1	2	3	4	5	6	7	8	9	10	L1	L2
CALL FOR PRICING <i>Open Back / Tight Seat &amp; Back</i>															
	BH1722-WB	<b>Overall:</b> 26"w 28.5"d 46"h		<b>Arm:</b> 26.5"h		<b>COM:</b> 4 yds.									
		<b>Seat:</b> 21"w 20"d 19"h		<b>Weight:</b> 80 lbs.		<b>COL:</b> n/a									
		COM	COL	1	2	3	4	5	6	7	8	9	10	L1	L2
CALL FOR PRICING <i>Tight Seat &amp; Back</i>															

**DESCRIPTION:**

- Frames: Steel, Plywood & Hardwood
- Recycled Steel Inner-Frame 1-1/2" X 1-1/2" Angle Iron To Double 11 Gauge Square Tubing
- Metal To Metal Construction
- Upholstery: Tight Cushion (Stapled On Covers Standard)
- Seat: High Density Polyurethane Foam Over Sheet Webbing
- Back: High Density Polyurethane Foam Over Sinuous Springs & Hardwood Plywood
- Arms Caps: Held In Place By Non-Removable Helical Fasteners

- Legs: Exposed Wood, Metal Or Solid Hardwood / Removable For Maintenance
- Full Underbody Panel
- Tamperproof Screws On Seat Pan
- Full Clean-Out Between Seat & Back
- No Exposed Hardware Or "Pick Points"
- All Staples Are Concealed & Inaccessible
- Lifetime Warranty

**ENHANCEMENTS:**

- Vacuum Formed ABS Under Panel With Drain ..... Call For Pricing
  - Additional Weight Can Be Added To The Seat ..... Call For Pricing
  - Can Be Bolted To Floor ..... Call For Pricing
  - Velcro Replaceable Seat Cover w/ Antimicrobial Moisture Barrier ..... Call For Pricing
- Bariatric Sizes Available: 500 lbs. - 1000 lbs.  
Specify Exposed Wood Finish (See Page 6)

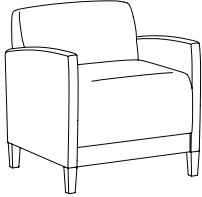
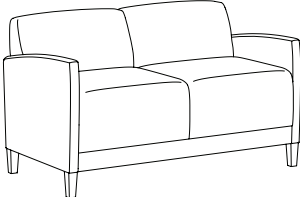
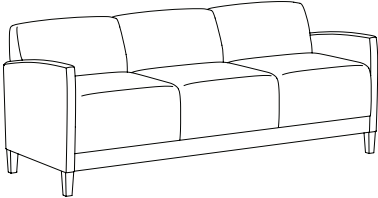
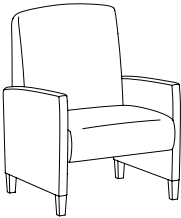
LOUNGE / PATIENT CHAIR		ITEM #:	SPECIFICATIONS   GRADES   LIST PRICES:													
	BH1841	<b>Overall:</b> 28"w 29"d 31.5"h <b>Seat:</b> 23.5"w 19"d 18.5"h	<b>Arm:</b> 24.5"h <b>Weight:</b> 85 lbs.	<b>COM:</b> 4.5 yds. <b>COL:</b> n/a											L1	L2
		COM	COL	1	2	3	4	5	6	7	8	9	10	L1	L2	
		CALL FOR PRICING <i>Tight Seat &amp; Back</i>														
	BH1842	<b>Overall:</b> 52"w 29"d 31.5"h <b>Seat:</b> 47.5"w 19"d 18.5"h	<b>Arm:</b> 24.5"h <b>Weight:</b> 135 lbs.	<b>COM:</b> 6.75 yds. <b>COL:</b> n/a											L1	L2
		COM	COL	1	2	3	4	5	6	7	8	9	10	L1	L2	
		CALL FOR PRICING <i>Tight Seat &amp; Back</i>														
	BH1843	<b>Overall:</b> 76"w 29"d 31.5"h <b>Seat:</b> 71.5"w 19"d 18.5"h	<b>Arm:</b> 24.5"h <b>Weight:</b> 180 lbs.	<b>COM:</b> 8.5 yds. <b>COL:</b> n/a											L1	L2
		COM	COL	1	2	3	4	5	6	7	8	9	10	L1	L2	
		CALL FOR PRICING <i>Tight Seat &amp; Back</i>														
	BH1852	<b>Overall:</b> 25"w 33.5"d 39.25"h <b>Seat:</b> 21"w 20"d 18.75"h	<b>Arm:</b> 24.25"h <b>Weight:</b> 63 lbs.	<b>COM:</b> 4.25 yds. <b>COL:</b> n/a											L1	L2
		COM	COL	1	2	3	4	5	6	7	8	9	10	L1	L2	
		CALL FOR PRICING <i>Tight Seat &amp; Back / Removable Upholstery</i>														

**DESCRIPTION:**

- Frames: Steel, Plywood & Hardwood
- Recycled Steel Inner-Frame 1-1/2" X 1-1/2" Angle Iron To Double 11 Gauge Square Tubing
- Metal To Metal Construction
- Upholstery: Tight Cushion (Stapled On Covers Standard)
- Seat: High Density Polyurethane Foam Over Sheet Webbing
- Back: High Density Polyurethane Foam Over Sinuous Springs & Hardwood Plywood
- Arms Caps: Held In Place By Non-Removable Helical Fasteners



- Legs: Exposed Wood, Polyester Or Solid Hardwood / Removable For Maintenance
- Full Underbody Panel
- Tamperproof Screws On Seat Pan
- Full Clean-Out Between Seat & Back
- No Exposed Hardware Or "Pick Points"
- All Staples Are Concealed & Inaccessible
- Lifetime Warranty

**ENHANCEMENTS:**

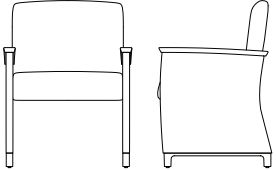
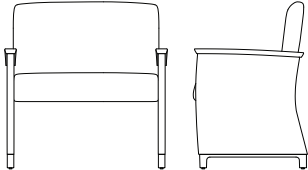
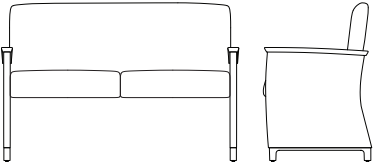
- Vacuum Formed ABS Under Panel With Drain ..... Call For Pricing
  - Additional Weight Can Be Added To The Seat ..... Call For Pricing
  - Can Be Bolted To Floor ..... Call For Pricing
  - Velcro Replaceable Seat Cover w/ Antimicrobial Moisture Barrier ..... Call For Pricing
- Bariatric Sizes Available: 500 lbs. - 1000 lbs.  
Specify Exposed Wood Finish (See Page 6)

GUEST	ITEM #:	SPECIFICATIONS   GRADES   LIST PRICES:												
	BH1880	<b>Overall:</b> 23.5"w 24"d 34"h		<b>Arm:</b> 25"h		<b>COM:</b> 3.75 yds.								
		<b>Seat:</b> 20"w 19"d 18.5"h		<b>Weight:</b> 55 lbs.		<b>COL:</b> n/a								
		COM	COL	1	2	3	4	5	6	7	8	9	10	L1
CALL FOR PRICING <i>Closed Back / Tight Seat &amp; Back</i>														
	BH1882	<b>Overall:</b> 33.5"w 24"d 34"h		<b>Arm:</b> 25"h		<b>COM:</b> 4.25 yds.								
		<b>Seat:</b> 30"w 19"d 18.5"h		<b>Weight:</b> 65 lbs.		<b>COL:</b> n/a								
		COM	COL	1	2	3	4	5	6	7	8	9	10	L1
CALL FOR PRICING <i>Closed Back / Tight Seat &amp; Back</i>														
	BH1884	<b>Overall:</b> 51.5"w 24"d 34"h		<b>Arm:</b> 25"h		<b>COM:</b> 5.5 yds.								
		<b>Seat:</b> 48"w 19"d 18.5"h		<b>Weight:</b> 75 lbs.		<b>COL:</b> n/a								
		COM	COL	1	2	3	4	5	6	7	8	9	10	L1
CALL FOR PRICING <i>Closed Back / Tight Seat &amp; Back</i>														

ARM CAPS	OPTION #:	SPECIFICATIONS   LIST PRICES   AVAILABILITY:
<p><b>SOLID WOOD ARM CAPS</b></p> 	<p><b>EWAC</b></p>	<p><b>Overall:</b> 2.75"w 29"d 1.125"h</p> <hr/> <p>\$219 (Set Of 2) <i>(Specify Finish)</i></p> <p><b>Available:</b> BH1841, BH1842, BH1843, BH1852</p>
<p><b>URETHANE / POLYESTER ARM CAPS</b></p> 	<p><b>EUAC</b></p> <p><b>EPAC-2</b></p>	<p><b>Overall:</b> 2.75"w 29"d 1.125"h</p> <hr/> <p>\$231 (Set Of 2) URETHANE <i>(1841-1844 Black Urethane)</i></p> <p>\$382 (Set Of 2) POLYESTER <i>(1841-1843)</i></p> <p><i>Black Polyester Arm Cap (Additional Colors Available)</i></p> <p><b>Available:</b> BH1841, BH1842, BH1843, BH1852</p>
<p><b>POLYESTER ARM CAPS</b></p> 	<p><b>EPAC-1</b></p>	<p><b>Overall:</b> 2.75"w 22.5"d 1.125"h</p> <hr/> <p>\$177 Each - POLYESTER <i>Polyester Arm Cap (Specify Exposed)</i></p> <p><b>Available:</b> BH1880's Group, BH1722-WB</p>
<p><b>WOOD / POLYESTER ARM CAPS</b></p>  <p>RWAC-1 Solid Wood Arm Cap</p>  <p>RPAC-1 Polyester Arm Cap</p>	<p><b>RWAC-1</b></p> <p><b>RPAC-1</b></p>	<p><b>Overall:</b> 3.625"w 30.25"d .5"h</p> <hr/> <p>\$374 (Set Of 2) <i>Solid Wood Arm Cap (Specify Finish)</i></p> <p>\$484 (Set Of 2) <i>Black Polyester Arm Cap (Additional Colors Available)</i></p> <p><b>Available:</b> BH1501</p>

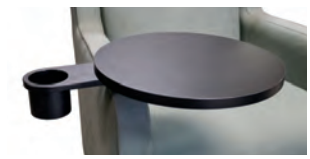
TABLETS	OPTION #:	SPECIFICATIONS   LIST PRICES   AVAILABILITY:
<p><b>TABLET ARMS / CUP HOLDER</b></p>  <p>Laminate Tablet Arm Shown w/ Cup Holder</p>  <p>Veneer Tablet Arm Shown w/ Cup Holder</p>  <p>Solid Surface Tablet Arm Shown w/ Cup Holder</p>	<p><b>Overall:</b> 14" Diameter .75"h</p> <hr/> <p><b>TA-L</b> \$440 <i>Tablet Arm With 360° Rotation - High Pressure Laminate. (Specify Laminate / Specify Left Or Right Facing Arm Location)</i></p> <p><b>TA-V</b> \$503 <i>Tablet Arm With 360° Rotation - Sunburst Cherry Veneer. (Specify Finish / Specify Left Or Right Facing Arm Location)</i></p> <p><b>TA-C</b> \$654 <i>Tablet Arm With 360° Rotation - White Solid Surface. (Available In White Only / Specify Left Or Right Facing Arm Location)</i></p> <p><b>CH-1</b> \$105 <i>Black Plastic Cup Holder (Only Available If Used With Tablet Arm)</i></p> <p><b>CH-2</b> \$157 <i>Spun Aluminum Cup Holder (Only Available If Used With Tablet Arm)</i></p> <p><b>Available:</b> BH1501, BH1841, BH1842, BH1843</p>	
<p><b>FOLD DOWN TABLET ARM</b></p>  	<p><b>Overall:</b> 14" Diameter .75"h</p> <hr/> <p><b>FDTA-L</b> \$1056 <i>Tablet Arm With 360° Rotation - High Pressure Laminate. (Specify Laminate / Specify Left Or Right Facing Arm Location)</i></p> <p><b>FDTA-V</b> \$1108 <i>Tablet Arm With 360° Rotation - Sunburst Cherry Veneer. (Specify Finish / Specify Left Or Right Facing Arm Location)</i></p> <p><b>FDTA-C</b> \$1259 <i>Tablet Arm With 360° Rotation - White Solid Surface. (Available In White Only / Specify Left Or Right Facing Arm Location)</i></p> <p><b>Available:</b> BH1501, BH1841, BH1842, BH1843</p>	
<p><b>DOUBLE ARTICULATING / SWIVEL TABLET ARM</b></p>  <p>ATA-L Double Articulating / Swivel Tablet Arm</p>  <p>ATA-L w/ CH-1 Black Plastic Cup Holder</p>	<p><b>Overall:</b> 14" Diameter .75"h</p> <hr/> <p><b>ATA-L</b> \$852 <i>Tablet Arm With 360° Rotation - High Pressure Laminate. (Specify Laminate / Specify Left Or Right Facing Arm Location)</i></p> <p><b>ATA-V</b> \$904 <i>Tablet Arm With 360° Rotation - Sunburst Cherry Veneer. (Specify Finish / Specify Left Or Right Facing Arm Location)</i></p> <p><b>ATA-C</b> \$1089 <i>Tablet Arm With 360° Rotation - White Solid Surface. (Available In White Only / Specify Left Or Right Facing Arm Location)</i></p> <p><b>CH-1</b> \$105 <i>Black Plastic Cup Holder (Only Available If Used With Tablet Arm)</i></p> <p><b>CH-2</b> \$157 <i>Spun Aluminum Cup Holder (Only Available If Used With Tablet Arm)</i></p> <p><b>Available:</b> BH1501, BH1841, BH1842, BH1843</p>	

POWER / LEGS / CASTERS / TOPS	OPTION #:	SPECIFICATIONS   LIST PRICES   AVAILABILITY:						
<p>POWER / DATA MODULE</p> 	<p>PM1</p>	<p><b>Overall:</b> 5.25"w 1.25"d 4.25"h</p> <hr/> <p>\$836 (1-Power / 1-USB 2 Port Simplex Charger Standard)  <i>Vertical / Horizontal Mount Power Module. Price Varies By Socket. Contact Customer Service For Quote. (Additional Colors Available)</i></p> <p><b>Available:</b> BH1501, BH1801, BH1841, BH1842, BH1843</p>						
<p>BRUSHED ALUMINUM ROUND LEGS</p> 	<p>ARL</p>	<p><b>Overall:</b> 2" Diameter 5"h</p> <hr/> <p>\$353 (Set Of 4)  <i>(Brushed Aluminum Finish)</i></p> <p><b>Available:</b> BH1841, BH1842, BH1843</p>						
<p>LOCKING / NON-LOCKING CASTERS</p>  <p>Locking Casters</p> <p>Non-Locking Casters</p>	<p>LC</p> <p>NLC</p>	<p><b>Overall:</b> 1.875"w 2.25"d 1.5"h (Locking) / 1.875"w 1.625"d 1.5"h (Non-Locking)</p> <hr/> <p>\$31 (Set Of Two)  <i>Locking Casters (Black Finish / Specify Location)</i></p> <p>\$26 (Set Of Two)  <i>Non-Locking Casters (Black Finish / Specify Location)</i></p> <p><b>Available:</b> BH1540 - BH1545</p>						
<p>SELF EDGE TABLE TOP</p> 	<p>SE18D</p> <p>SE24D</p> <p>SE30D</p>	<p><b>Overall:</b> 18" Diameter x 1"h / 24" Diameter x 1"h / 30" Diameter x 1"h</p> <hr/> <table border="0"> <tr> <td>Self Edge Table Top - 18" Diameter</td> <td>\$30</td> </tr> <tr> <td>Self Edge Table Top - 24" Diameter</td> <td>\$33</td> </tr> <tr> <td>Self Edge Table Top - 30" Diameter</td> <td>\$33</td> </tr> </table> <p><i>High Pressure Laminate Top w/ Self Edge</i></p> <p><b>Available:</b> BH1544's - BH1545's Tables</p>	Self Edge Table Top - 18" Diameter	\$30	Self Edge Table Top - 24" Diameter	\$33	Self Edge Table Top - 30" Diameter	\$33
Self Edge Table Top - 18" Diameter	\$30							
Self Edge Table Top - 24" Diameter	\$33							
Self Edge Table Top - 30" Diameter	\$33							



COVERS	OPTION #:	SPECIFICATIONS   LIST PRICES   AVAILABILITY:
<p>CONTRASTING COVERS - GUEST OPEN ARM</p> 	<p>CC</p>	<p><i>Overall: N/A</i></p> <hr/> <p>\$129  <i>NOTE: If Two Or More Upholsteries Or Leathers Are Used On Any Piece Of Furniture, Then A Contrast Charge Will Apply Per Order. When Using Trinity Upholstery, The Higher Priced Upholstery Grade Will Be Used In Pricing, Unless It's Trinity Leather With Fabric Contrast Welt, Or COM With Trinity Contrast Welt, Then Contact Customer Service For Pricing.</i></p> <p><i>Available: BH1822, BH1832, BH1850</i></p>
<p>CONTRASTING COVERS - LOUNGE</p> 	<p>CC</p>	<p><i>Overall: N/A</i></p> <hr/> <p>\$129  <i>NOTE: If Two Or More Upholsteries Or Leathers Are Used On Any Piece Of Furniture, Then A Contrast Charge Will Apply Per Order. When Using Trinity Upholstery, The Higher Priced Upholstery Grade Will Be Used In Pricing, Unless It's Trinity Leather With Fabric Contrast Welt, Or COM With Trinity Contrast Welt, Then Contact Customer Service For Pricing.</i></p> <p><i>Available: BH341-A, BH1841, BH1842, BH1843, BH1852</i></p>
<p>CONTRASTING COVERS - GUEST CLOSED ARM</p> 	<p>CC</p>	<p><i>Overall: N/A</i></p> <hr/> <p>\$129  <i>NOTE: If Two Or More Upholsteries Or Leathers Are Used On Any Piece Of Furniture, Then A Contrast Charge Will Apply Per Order. When Using Trinity Upholstery, The Higher Priced Upholstery Grade Will Be Used In Pricing, Unless It's Trinity Leather With Fabric Contrast Welt, Or COM With Trinity Contrast Welt, Then Contact Customer Service For Pricing.</i></p> <p><i>Available: BH1880's Group, BH1722-WB</i></p>
<p>CONTRASTING COVERS - POLLIWOGS</p> 	<p>CC</p>	<p><i>Overall: N/A</i></p> <hr/> <p>\$129  <i>NOTE: If Two Or More Upholsteries Or Leathers Are Used On Any Piece Of Furniture, Then A Contrast Charge Will Apply Per Order. When Using Trinity Upholstery, The Higher Priced Upholstery Grade Will Be Used In Pricing, Unless It's Trinity Leather With Fabric Contrast Welt, Or COM With Trinity Contrast Welt, Then Contact Customer Service For Pricing.</i></p> <p><i>Available: BH1540's Benches &amp; Ottomans</i></p>

# Radcliffe Square

---

LOUNGE / GUEST / BENCHES / TABLES

Effective: August 1, 2022

T R I N I T Y

**Date:**

**Page:**

**Modification:**

**Description:**

---

**DESCRIPTION:**

- Upholstery Frames: Hardwood & Plywood
- Seat: High Density Polyurethane Foam Over Sheet Webbing
- Back: High Density Polyurethane Foam Over Polypropylene Webbing
- Semi-Attached Cushions: High Density Polydacron (Not Reversible)
- Tight Seat: High Density Polyurethane Foam
- Exposed Wood Frame: Solid Cherry
- Arms: High Density Polyurethane Foam Over Hardwood
- Tablet Arm: Sunburst Patterned Cherry Veneer Over MDF (Cherry Veneer Edgeband)
- 10 Year Warranty

**OPTIONS:**

- Feather Down & Polyester Pillows Available (See Page 5)
- Specify Exposed Wood Finish (See Page 6)
- Veneer & Solid Surface Tablet Arms May Be Specified

**ORIEL LOUNGE**

**ITEM #: SPECIFICATIONS | GRADES | LIST PRICES:**

**ARMLESS LOUNGE CHAIR**

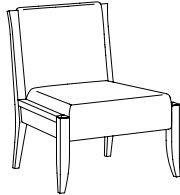

**Overall:** 28"w 29.25"d 35"h      **Arm:** n/a      **COM:** 3 yds. (251-P) / 3.25 yds. (251-C)  
**Seat:** 24"w 21.5"d 17.5"h      **Weight:** 50 lbs.      **COL:** 54 sq.ft. (251-P) / 58.5 sq.ft. (251-C)

COM	COL	1	2	3	4	5	6	7	8	9	10	L1	L2	
<b>251-P</b>	1594	1754	1658	1734	1810	1885	1961	2036	2112	2188	2263	2339	2426	2699
<i>Tight Seat / Tight Back</i>														
<b>251-C</b>	1666	1832	1740	1822	1905	1987	2070	2152	2235	2317	2400	2482	2588	2885
<i>Semi-Attached Cushion / Tight Back</i>														

**ARMLESS TWO PLACE SOFA**

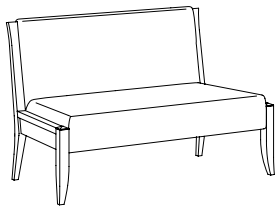

**Overall:** 52"w 29.25"d 35"h      **Arm:** n/a      **COM:** 4.75 yds. (252-P) / 5.25 yds. (252-C)  
**Seat:** 48"w 21.5"d 17.5"h      **Weight:** 65 lbs.      **COL:** 85.5 sq.ft. (252-P) / 94.5 sq.ft. (252-C)

COM	COL	1	2	3	4	5	6	7	8	9	10	L1	L2	
<b>252-P</b>	1982	2180	2080	2183	2286	2389	2492	2596	2699	2802	2905	3008	3124	3495
<i>Tight Seat / Tight Back</i>														
<b>252-C</b>	2132	2345	2249	2366	2483	2600	2717	2834	2950	3067	3184	3301	3450	3870
<i>Two Semi-Attached Cushions / Tight Back</i>														

**ARMLESS THREE PLACE SOFA**

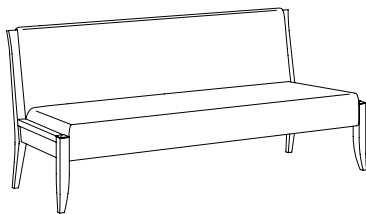

**Overall:** 77"w 29.25"d 35"h      **Arm:** n/a      **COM:** 5.25 yds. (253-P) / 6.75 yds. (253-C)  
**Seat:** 73"w 21.5"d 17.5"h      **Weight:** 80 lbs.      **COL:** 94.5 sq.ft. (252-P) / 121.5 sq.ft. (252-C)

COM	COL	1	2	3	4	5	6	7	8	9	10	L1	L2	
<b>253-P</b>	2381	2619	2526	2663	2801	2938	3076	3213	3351	3488	3625	3763	3912	4407
<i>Tight Seat / Tight Back</i>														
<b>253-C</b>	2594	2853	2810	2988	3167	3346	3524	3703	3882	4060	4239	4418	4630	5273
<i>Two Semi-Attached Cushions / Tight Back</i>														

**ARM / TABLET OPTIONS**

**Arm Height:** 25"h      **COM:** 1 yd. (Note: Yardage Is Sufficient For 1 or 2 Arms)      **Weight:** 5 lbs.  
**Tablet Arm Height:** 16"h      **COL:** 18 sq.ft.

**NOTE: USE THE FOLLOWING NUMBER SEQUENCE. USE '0' WHEN AN ARM IS NOT DESIRED.**



**252-P - 1 - 4**

**ABOVE EXAMPLE:**  
 AN ARMLESS TWO PLACE SOFA  
 WITH FLAIR LEFT FACING ARM  
 AND TABLET RIGHT FACING ARM

**EACH ARM**

COM	COL	1	2	3	4	5	6	7	8	9	10	L1	L2
190	209	217	237	257	277	298	318	338	358	379	399	428	501

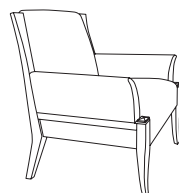

**1**  
FLAIR ARM

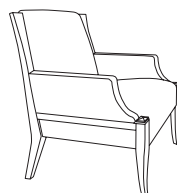

**2**  
NOTCH ARM

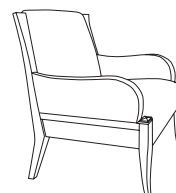

**3**  
SCROLL ARM

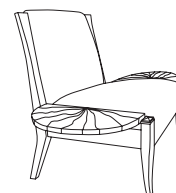

**4**  
TABLET ARM

- 250-4L \$441  
Laminate  
Tablet Arm
- 250-4V \$662  
Veneer  
Tablet Arm
- 250-4C \$586  
Solid Surface  
Tablet Arm

**DESCRIPTION:**

- Upholstery Frames: Hardwood & Plywood
- Seat: High Density Polyurethane Foam Over Sheet Webbing
- Back: High Density Polyurethane Foam Over Polypropylene Webbing
- Semi-Attached Cushions: High Density Polydacron (Not Reversible)
- Tight Seat: High Density Polyurethane Foam
- Exposed Wood Frame: Solid Cherry
- Arms: High Density Polyurethane Foam Over Hardwood
- Tablet Arm: Sunburst Patterned Cherry Veneer Over MDF (Cherry Veneer Edgeband)
- 10 Year Warranty

**OPTIONS:**

- Feather Down & Polyester Pillows Available (See Page 5)
- Specify Exposed Wood Finish (See Page 6)
- Veneer & Solid Surface Tablet Arms May Be Specified

**ORIEL LOUNGE**

ITEM #:

SPECIFICATIONS | GRADES | LIST PRICES:

**ARMLESS LOUNGE TUFTED CHAIR**

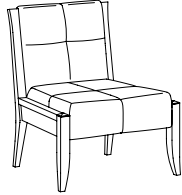

**Overall:** 28"w 29.25"d 35"h      **Arm:** n/a      **COM:** 3 yds. (254-P) / 3.5 yds. (254-C)  
**Seat:** 24"w 21.5"d 17.5"h      **Weight:** 50 lbs.      **COL:** 54 sq.ft. (254-P) / 63 sq.ft. (254-C)

COM	COL	1	2	3	4	5	6	7	8	9	10	L1	L2	
<b>254-P</b>	1627	1790	1689	1765	1841	1916	1992	2067	2143	2219	2294	2370	2464	2736
<i>Biscuit Tufted Tight Seat / Tight Back</i>														
<b>254-C</b>	1690	1859	1776	1866	1955	2044	2134	2223	2312	2402	2491	2580	2695	3017
<i>Biscuit Tufted Semi-Attached Cushion / Tight Back</i>														

**ARMLESS TWO PLACE TUFTED SOFA**

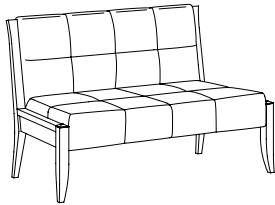

**Overall:** 52"w 29.25"d 35"h      **Arm:** n/a      **COM:** 4 yds. (255-P) / 4.5 yds. (255-C)  
**Seat:** 48"w 21.5"d 17.5"h      **Weight:** 65 lbs.      **COL:** 72 sq.ft. (255-P) / 81 sq.ft. (255-C)

COM	COL	1	2	3	4	5	6	7	8	9	10	L1	L2	
<b>255-P</b>	2047	2251	2141	2244	2348	2451	2554	2657	2760	2863	2966	3069	3197	3568
<i>Biscuit Tufted Tight Seat / Tight Back</i>														
<b>255-C</b>	2188	2407	2303	2419	2536	2653	2770	2887	3003	3120	3237	3354	3512	3933
<i>Two Biscuit Tufted Semi-Attached Cushions / Tight Back</i>														

**ARMLESS THREE PLACE TUFTED SOFA**

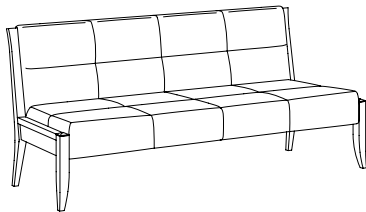

**Overall:** 77"w 29.25"d 35"h      **Arm:** n/a      **COM:** 5.25 yds. (256-P) / 6.75 yds. (256-C)  
**Seat:** 73"w 21.5"d 17.5"h      **Weight:** 80 lbs.      **COL:** 94.5 sq.ft. (256-P) / 121.5 sq.ft. (256-C)

COM	COL	1	2	3	4	5	6	7	8	9	10	L1	L2	
<b>256-P</b>	2493	2742	2632	2769	2907	3044	3182	3319	3456	3594	3731	3869	4036	4531
<i>Biscuit Tufted Tight Seat / Tight Back</i>														
<b>256-C</b>	2664	2931	2876	3055	3234	3412	3591	3770	3948	4127	4306	4484	4709	5353
<i>Two Biscuit Tufted Semi-Attached Cushions / Tight Back</i>														

**ARM / TABLET OPTIONS**

**Arm Height:** 25"h      **COM:** 1 yd. (Note: Yardage Is Sufficient For 1 or 2 Arms)      **Weight:** 5 lbs.  
**Tablet Arm Height:** 16"h      **COL:** 18 sq.ft.

NOTE: USE THE FOLLOWING NUMBER SEQUENCE. USE '0' WHEN AN ARM IS NOT DESIRED.



**252-P - 1 - 4**

ABOVE EXAMPLE:  
 AN ARMLESS TWO PLACE SOFA  
 WITH FLAIR LEFT FACING ARM  
 AND TABLET RIGHT FACING ARM

EACH ARM

COM	COL	1	2	3	4	5	6	7	8	9	10	L1	L2
190	209	217	237	257	277	298	318	338	358	379	399	428	501

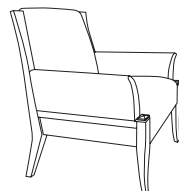

**1**  
FLAIR ARM

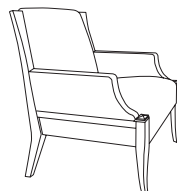

**2**  
NOTCH ARM

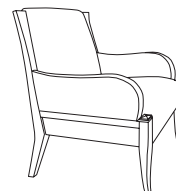

**3**  
SCROLL ARM

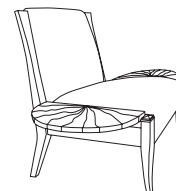

**4**  
TABLET ARM

- 250-4L \$441  
Laminate  
Tablet Arm
- 250-4V \$662  
Veneer  
Tablet Arm
- 250-4C \$586  
Solid Surface  
Tablet Arm

**DESCRIPTION:**

- Upholstery Frames: Hardwood & Plywood
- Seat: High Density Polyurethane Foam Over Sheet Webbing
- Back: High Density Polyurethane Foam Over Polypropylene Webbing
- Semi-Attached Cushions: High Density Polydacron (Not Reversible)
- Tight Seat: High Density Polyurethane Foam
- Exposed Wood Frame: Solid Cherry
- Arms: High Density Polyurethane Foam Over Hardwood
- Tablet Arm: Sunburst Patterned Cherry Veneer Over MDF (Cherry Veneer Edgeband)
- 10 Year Warranty

**OPTIONS:**

- Feather Down & Polyester Pillows Available (See Page 5)
- Specify Exposed Wood Finish (See Page 6)
- Veneer & Solid Surface Tablet Arms May Be Specified

**QUEEN'S LOUNGE**

ITEM #: SPECIFICATIONS | GRADES | LIST PRICES:

**ARMLESS LOUNGE CHAIR / CAMEL BACK**

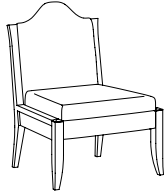

**Overall:** 28"w 31"d 38"h      **Arm:** n/a      **COM:** 3 yds. (261-P) / 3.25 yds. (261-C)  
**Seat:** 24"w 21.5"d 17.5"h      **Weight:** 50 lbs.      **COL:** 54 sq.ft. (261-P) / 58.5 sq.ft. (261-C)

COM	COL	1	2	3	4	5	6	7	8	9	10	L1	L2	
261-P	1637	1801	1699	1774	1850	1926	2001	2077	2152	2228	2304	2379	2470	2743
<i>Tight Seat / Tight Back</i>														
261-C	1727	1900	1798	1880	1963	2045	2128	2210	2293	2375	2457	2540	2653	2950
<i>Semi-Attached Cushion / Tight Back</i>														

**ARMLESS TWO PLACE SOFA / CAMEL BACK**

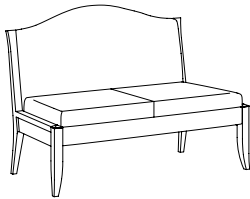

**Overall:** 52"w 31"d 38"h      **Arm:** n/a      **COM:** 5.25 yds. (262-P) / 5.75 yds. (262-C)  
**Seat:** 48"w 21.5"d 17.5"h      **Weight:** 65 lbs.      **COL:** 94.5 sq.ft. (262-P) / 103.5 sq.ft. (262-C)

COM	COL	1	2	3	4	5	6	7	8	9	10	L1	L2	
262-P	2086	2295	2247	2384	2522	2659	2797	2934	3072	3209	3347	3484	3633	4128
<i>Tight Seat / Tight Back</i>														
262-C	2241	2465	2421	2573	2724	2875	3026	3177	3328	3480	3631	3782	3964	4508
<i>Two Semi-Attached Cushions / Tight Back</i>														

**ARMLESS THREE PLACE SOFA / CAMEL BACK**

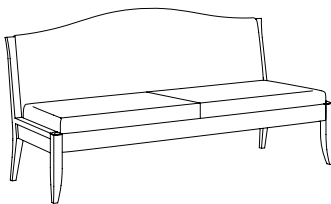

**Overall:** 77"w 31"d 38"h      **Arm:** n/a      **COM:** 7.25 yds. (263-P) / 8.75 yds. (263-C)  
**Seat:** 73"w 21.5"d 17.5"h      **Weight:** 80 lbs.      **COL:** 130.5 sq.ft. (263-P) / 157.5 sq.ft. (263-C)

COM	COL	1	2	3	4	5	6	7	8	9	10	L1	L2	
263-P	2506	2757	2754	2947	3139	3331	3524	3716	3909	4101	4294	4486	4681	5373
<i>Tight Seat / Tight Back</i>														
263-C	2714	2985	3033	3267	3500	3734	3968	4201	4435	4669	4902	5136	5393	6235
<i>Two Semi-Attached Cushions / Tight Back</i>														

**ARM / TABLET OPTIONS**

**Arm Height:** 25"h      **COM:** 1 yd. (Note: Yardage Is Sufficient For 1 or 2 Arms)      **Weight:** 5 lbs.  
**Tablet Arm Height:** 16"h      **COL:** 18 sq.ft.

NOTE: USE THE FOLLOWING NUMBER SEQUENCE. USE '0' WHEN AN ARM IS NOT DESIRED.



**252-P - 1 - 4**

ABOVE EXAMPLE:  
 AN ARMLESS TWO PLACE SOFA  
 WITH FLAIR LEFT FACING ARM  
 AND TABLET RIGHT FACING ARM

**EACH ARM**

COM	COL	1	2	3	4	5	6	7	8	9	10	L1	L2
190	209	217	237	257	277	298	318	338	358	379	399	428	501

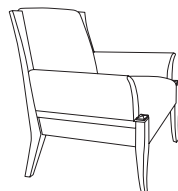

**1**  
FLAIR ARM

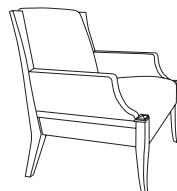

**2**  
NOTCH ARM

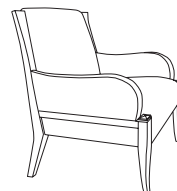

**3**  
SCROLL ARM

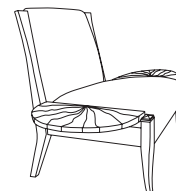

**4**  
TABLET ARM

- 250-4L \$441  
Laminate  
Tablet Arm
- 250-4V \$662  
Veneer  
Tablet Arm
- 250-4C \$586  
Solid Surface  
Tablet Arm

**DESCRIPTION:**

- Upholstery Frames: Hardwood & Plywood
- Seat: High Density Polyurethane Foam Over Sheet Webbing
- Back: High Density Polyurethane Foam Over Polypropylene Webbing
- Semi-Attached Cushions: High Density Polydacron (Not Reversible)
- Tight Seat: High Density Polyurethane Foam
- Exposed Wood Frame: Solid Cherry
- Arms: High Density Polyurethane Foam Over Hardwood
- Tablet Arm: Sunburst Patterned Cherry Veneer Over MDF (Cherry Veneer Edgeband)
- 10 Year Warranty

**OPTIONS:**

- Feather Down & Polyester Pillows Available (See Page 5)
- Specify Exposed Wood Finish (See Page 6)
- Veneer & Solid Surface Tablet Arms May Be Specified

**PEMBROKE LOUNGE**

ITEM #:

SPECIFICATIONS | GRADES | LIST PRICES:

**ARMLESS LOUNGE CHAIR / FULLY UPHOLSTERED BACK**

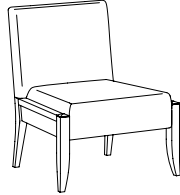

**Overall:** 28"w 29.25"d 35"h      **Arm:** n/a      **COM:** 3.25 yds. (271-P) / 3.5 yds. (271-C)  
**Seat:** 24"w 21.5"d 17.5"h      **Weight:** 50 lbs.      **COL:** 58.5 sq.ft. (271-P) / 63 sq.ft. (271-C)

COM	COL	1	2	3	4	5	6	7	8	9	10	L1	L2	
271-P	1638	1802	1714	1796	1879	1961	2044	2126	2209	2291	2373	2456	2556	2852
<i>Tight Seat / Tight Back</i>														
271-C	1716	1887	1801	1890	1979	2069	2158	2247	2337	2426	2515	2605	2722	3044
<i>Semi-Attached Cushion / Tight Back</i>														

**ARMLESS TWO PLACE SOFA / FULLY UPHOLSTERED BACK**

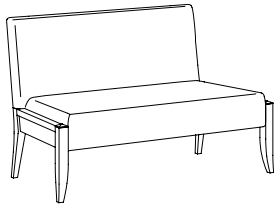

**Overall:** 52"w 29.25"d 35"h      **Arm:** n/a      **COM:** 4 yds. (272-P) / 4.5 yds. (272-C)  
**Seat:** 48"w 21.5"d 17.5"h      **Weight:** 65 lbs.      **COL:** 72 sq.ft. (272-P) / 81 sq.ft. (272-C)

COM	COL	1	2	3	4	5	6	7	8	9	10	L1	L2	
272-P	2026	2229	2122	2225	2328	2431	2534	2637	2740	2843	2946	3049	3170	3542
<i>Tight Seat / Tight Back</i>														
272-C	2168	2385	2284	2401	2517	2634	2751	2868	2985	3102	3218	3335	3488	3908
<i>Two Semi-Attached Cushions / Tight Back</i>														

**ARMLESS THREE PLACE SOFA / FULLY UPHOLSTERED BACK**

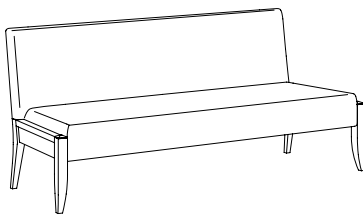

**Overall:** 77"w 29.25"d 35"h      **Arm:** n/a      **COM:** 5.25 yds. (273-P) / 6.75 yds. (273-C)  
**Seat:** 73"w 21.5"d 17.5"h      **Weight:** 80 lbs.      **COL:** 94.5 sq.ft. (273-P) / 121.5 sq.ft. (273-C)

COM	COL	1	2	3	4	5	6	7	8	9	10	L1	L2	
273-P	2400	2640	2544	2681	2818	2956	3093	3231	3368	3506	3643	3781	3933	4428
<i>Tight Seat / Tight Back</i>														
273-C	2616	2878	2831	3010	3188	3367	3546	3724	3903	4082	4260	4439	4654	5298
<i>Two Semi-Attached Cushions / Tight Back</i>														

**ARM / TABLET OPTIONS**

**Arm Height:** 25"h      **COM:** 1 yd. (Note: Yardage Is Sufficient For 1 or 2 Arms)      **Weight:** 5 lbs.  
**Tablet Arm Height:** 16"h      **COL:** 18 sq.ft.

NOTE: USE THE FOLLOWING NUMBER SEQUENCE. USE '0' WHEN AN ARM IS NOT DESIRED.

ITEM NUMBER — LEFT ARM FACING — RIGHT ARM FACING

252-P — 1 — 4

ABOVE EXAMPLE:  
 AN ARMLESS TWO PLACE SOFA WITH FLAIR LEFT FACING ARM AND TABLET RIGHT FACING ARM

EACH ARM

COM	COL	1	2	3	4	5	6	7	8	9	10	L1	L2
190	209	217	237	257	277	298	318	338	358	379	399	428	501

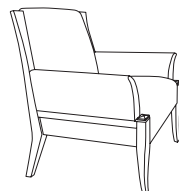

**1**  
FLAIR ARM

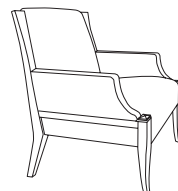

**2**  
NOTCH ARM

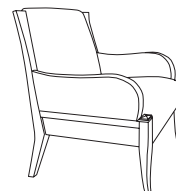

**3**  
SCROLL ARM

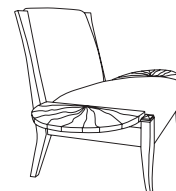

**4**  
TABLET ARM

- 250-4L \$441 Laminate Tablet Arm
- 250-4V \$662 Veneer Tablet Arm
- 250-4C \$586 Solid Surface Tablet Arm

**DESCRIPTION:**

- Upholstery Frames: Hardwood & Plywood
- Seat: High Density Polyurethane Foam Over Sheet Webbing
- Back: High Density Polyurethane Foam Over Polypropylene Webbing
- Semi-Attached Cushions: High Density Polydacron (Not Reversible)
- Tight Seat: High Density Polyurethane Foam
- Exposed Wood Frame: Solid Cherry
- Arms: High Density Polyurethane Foam Over Hardwood
- Tablet Arm: Sunburst Patterned Cherry Veneer Over MDF (Cherry Veneer Edgeband)
- 10 Year Warranty

**OPTIONS:**

- Feather Down & Polyester Pillows Available (See Page 5)
- Specify Exposed Wood Finish (See Page 6)
- Veneer & Solid Surface Tablet Arms May Be Specified

**PEMBROKE LOUNGE**

ITEM #: SPECIFICATIONS | GRADES | LIST PRICES:

**ARMLESS LOUNGE CHAIR / FULLY UPH. BACK / SEWN TUFTING**

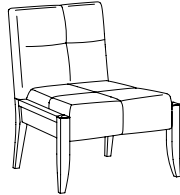

**Overall:** 28"w 29.25"d 35"h      **Arm:** n/a      **COM:** 3.25 yds. (274-P) / 3.5 yds. (274-C)  
**Seat:** 24"w 21.5"d 17.5"h      **Weight:** 50 lbs.      **COL:** 54 sq.ft. (274-P) / 63 sq.ft. (274-C)

COM	COL	1	2	3	4	5	6	7	8	9	10	L1	L2	
<b>274-P</b>	1671	1838	1731	1807	1882	1958	2033	2109	2185	2260	2336	2411	2512	2785
<i>Biscuit Tufted Tight Seat / Tight Back</i>														
<b>274-C</b>	1734	1907	1818	1907	1996	2086	2175	2264	2354	2443	2533	2622	2744	3066
<i>Biscuit Tufted Semi-Attached Cushion / Tight Back</i>														

**ARMLESS TWO PLACE SOFA / FULLY UPH. BACK / SEWN TUFTING**

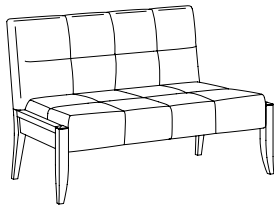

**Overall:** 52"w 29.25"d 35"h      **Arm:** n/a      **COM:** 4 yds. (275-P) / 4.5 yds. (275-C)  
**Seat:** 48"w 21.5"d 17.5"h      **Weight:** 65 lbs.      **COL:** 72 sq.ft. (275-P) / 81 sq.ft. (275-C)

COM	COL	1	2	3	4	5	6	7	8	9	10	L1	L2	
<b>275-P</b>	2087	2296	2179	2282	2385	2488	2592	2695	2798	2901	3004	3107	3239	3611
<i>Biscuit Tufted Tight Seat / Tight Back</i>														
<b>275-C</b>	2228	2451	2340	2457	2574	2691	2808	2925	3041	3158	3275	3392	3555	3975
<i>Two Biscuit Tufted Semi-Attached Cushions / Tight Back</i>														

**ARMLESS THREE PLACE SOFA / FULLY UPH. BACK / SEWN TUFTING**

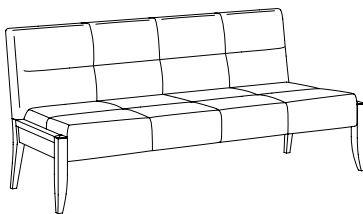

**Overall:** 77"w 29.25"d 35"h      **Arm:** n/a      **COM:** 5.25 yds. (276-P) / 6.75 yds. (276-C)  
**Seat:** 73"w 21.5"d 17.5"h      **Weight:** 80 lbs.      **COL:** 94.5 sq.ft. (276-P) / 121.5 sq.ft. (276-C)

COM	COL	1	2	3	4	5	6	7	8	9	10	L1	L2	
<b>276-P</b>	2491	2740	2630	2767	2905	3042	3180	3317	3455	3592	3730	3867	4035	4530
<i>Biscuit Tufted Tight Seat / Tight Back</i>														
<b>276-C</b>	2680	2948	2891	3070	3248	3427	3606	3784	3963	4142	4320	4499	4725	5368
<i>Two Biscuit Tufted Semi-Attached Cushions / Tight Back</i>														

**ARM / TABLET OPTIONS**

**Arm Height:** 25"h      **COM:** 1 yd. (Note: Yardage Is Sufficient For 1 or 2 Arms)      **Weight:** 5 lbs.  
**Tablet Arm Height:** 16"h      **COL:** 18 sq.ft.

NOTE: USE THE FOLLOWING NUMBER SEQUENCE. USE '0' WHEN AN ARM IS NOT DESIRED.



**252-P - 1 - 4**

ABOVE EXAMPLE:  
 AN ARMLESS TWO PLACE SOFA WITH FLAIR LEFT FACING ARM AND TABLET RIGHT FACING ARM

EACH ARM

COM	COL	1	2	3	4	5	6	7	8	9	10	L1	L2
190	209	217	237	257	277	298	318	338	358	379	399	428	501

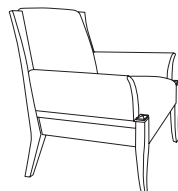

**1**  
FLAIR ARM

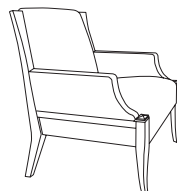

**2**  
NOTCH ARM

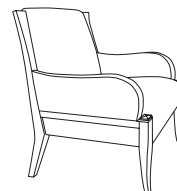

**3**  
SCROLL ARM

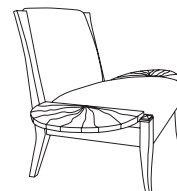

**4**  
TABLET ARM

- 250-4L \$441 Laminated Tablet Arm
- 250-4V \$662 Veneer Tablet Arm
- 250-4C \$586 Solid Surface Tablet Arm



**DESCRIPTION:**

- Upholstery Frames: Hardwood & Plywood
- Seat: High Density Polyurethane Foam Over Sheet Webbing
- Back: High Density Polyurethane Foam Over Polypropylene Webbing
- Semi-Attached Cushions: High Density Polydacron (Not Reversible)
- Tight Seat: High Density Polyurethane Foam
- Exposed Wood Frame: Solid Cherry
- Arms: High Density Polyurethane Foam Over Hardwood
- Tablet Arm: Sunburst Patterned Cherry Veneer Over MDF (Cherry Veneer Edgeband)
- 10 Year Warranty

**OPTIONS:**

Specify Exposed Wood Finish (See Page 6)  
 Veneer & Solid Surface Tablet Arms May Be Specified

**CATTE STREET CHAIRS**

**ARMLESS SIDE CHAIR / EXPOSED WOOD BACK POSTS**



		SPECIFICATIONS   GRADES   LIST PRICES:													
		Overall: 23"w 23.75"d 33"h				Arm: n/a				COM: 2 yds. (291-P) / 2.25 yds. (291-C)					
		Seat: 19.75"w 18"d 18.5"h				Weight: 25 lbs.				COL: 36 sq.ft. (291-P) / 40.5 sq.ft. (291-C)					
COM	COL	1	2	3	4	5	6	7	8	9	10	L1	L2		
291-P	938	1032	983	1031	1079	1127	1175	1223	1271	1320	1368	1416	1481	1654	
<i>Tight Seat / Tight Back</i>															
291-C	1029	1132	1083	1138	1193	1248	1303	1358	1413	1468	1523	1578	1663	1861	
<i>Semi-Attached Cushion / Tight Back</i>															

**ARMLESS SIDE CHAIR / CAMEL BACK / EXPOSED WOOD BACK POSTS**



		Overall: 23"w 23.75"d 35.5"h				Arm: n/a				COM: 2.25 yds. (292-P) / 2.25 yds. (292-C)					
		Seat: 19.75"w 18"d 18.5"h				Weight: 25 lbs.				COL: 40.5 sq.ft. (292-P) / 40.5 sq.ft. (292-C)					
COM	COL	1	2	3	4	5	6	7	8	9	10	L1	L2		
292-P	981	1080	1038	1093	1148	1203	1258	1313	1368	1423	1478	1533	1608	1806	
<i>Tight Seat / Tight Back</i>															
292-C	1073	1180	1124	1179	1234	1289	1344	1399	1454	1509	1564	1619	1709	1907	
<i>Semi-Attached Cushion / Tight Back</i>															

**ARMLESS SIDE CHAIR / UPH. LOWER BACK / EXPOSED WOOD TOP BACK**



		Overall: 23"w 23.75"d 33"h				Arm: n/a				COM: 1.75 yds. (293-P) / 2.25 yds. (293-C)					
		Seat: 19.75"w 18"d 18.5"h				Weight: 25 lbs.				COL: 31.5 sq.ft. (293-P) / 40.5 sq.ft. (293-C)					
COM	COL	1	2	3	4	5	6	7	8	9	10	L1	L2		
293-P	1072	1180	1096	1138	1179	1220	1261	1303	1344	1385	1426	1467	1539	1688	
<i>Tight Seat / Tight Back</i>															
293-C	1170	1287	1216	1271	1326	1381	1436	1491	1546	1601	1656	1711	1807	2005	
<i>Semi-Attached Cushion / Tight Back</i>															

**ARMLESS SIDE CHAIR / FULLY UPH. BACK / BISCUIT TUFTED**



		Overall: 23"w 23.75"d 33"h				Arm: n/a				COM: 2.25 yds. (294-P) / 2.25 yds. (294-C)					
		Seat: 19.75"w 18"d 18.5"h				Weight: 25 lbs.				COL: 40.5 sq.ft. (294-P) / 40.5 sq.ft. (294-C)					
COM	COL	1	2	3	4	5	6	7	8	9	10	L1	L2		
294-P	986	1084	1015	1056	1097	1138	1180	1221	1262	1303	1344	1386	1493	1641	
<i>Biscuit Tufted Tight Seat / Tight Back</i>															
294-C	1081	1189	1132	1187	1242	1297	1352	1407	1462	1517	1572	1627	1771	1969	
<i>Biscuit Tufted Semi-Attached Cushion / Tight Back</i>															

**ARM / TABLET OPTIONS**

Arm Height: 25"h      COM: 1 yd. (Note: Yardage Is Sufficient For 1 or 2 Arms)      Weight: 5 lbs.  
 Tablet Arm Height: 16"h      COL: 18 sq.ft.

NOTE: USE THE FOLLOWING NUMBER SEQUENCE. USE '0' WHEN AN ARM IS NOT DESIRED.

ITEM NUMBER	LEFT ARM FACING	RIGHT ARM FACING
292-P	1	4

**EACH ARM**

COM	COL	1	2	3	4	5	6	7	8	9	10	L1	L2
117	129	149	170	190	210	230	251	271	291	311	332	355	427
												290-4L \$404 Laminated Tablet Arm	
												290-4V \$470 Veneer Tablet Arm	
												290-4C \$491 Solid Surface Tablet Arm	

ABOVE EXAMPLE:  
 AN ARMLESS SIDE CHAIR WITH FLAIR LEFT FACING ARM AND TABLET RIGHT FACING ARM

**DESCRIPTION:**

- Upholstery Frames: Hardwood & Plywood
- Tight Seat: High Density Polyurethane Foam Over Sheet Webbing
- Semi-Attached Cushions: High Density Polydacron (Not Reversible)
- Exposed Wood Frame: Solid Cherry
- Tablet Arm: Sunburst Patterned Cherry Veneer Over MDF (Cherry Veneer Edgeband)
- 10 Year Warranty

**OPTIONS:**

Specify Exposed Wood Finish (See Page 6)  
 Veneer & Solid Surface Tablet Arms May Be Specified

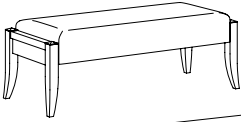
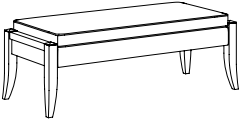
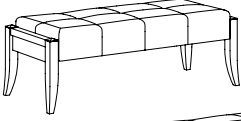
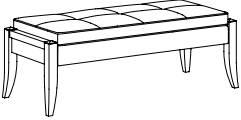
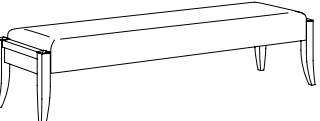
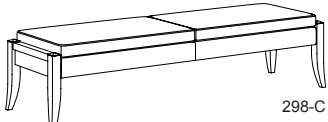
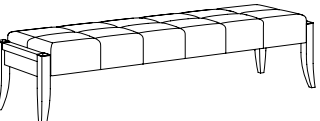
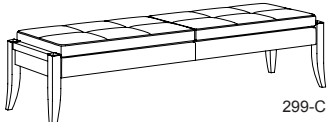
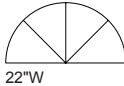
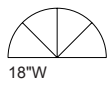
BENCHES / TABLET ARMS		ITEM #:	SPECIFICATIONS   GRADES   LIST PRICES:													
 296-P  296-C	<b>BENCH / PLAIN TAILORING</b>		<b>Overall:</b> 52"w 20.5"d 18"h <b>Seat:</b> 48"w 20.5"d 18"h			<b>Arm:</b> n/a <b>Weight:</b> 45 lbs.			<b>COM:</b> 2.25 yds. (296-P) / 3 yds. (296-C) <b>COL:</b> 40.5 sq.ft. (296-P) / 54 sq.ft. (296-C)							
	<b>296-P</b>		<b>COM</b>	<b>COL</b>	<b>1</b>	<b>2</b>	<b>3</b>	<b>4</b>	<b>5</b>	<b>6</b>	<b>7</b>	<b>8</b>	<b>9</b>	<b>10</b>	<b>L1</b>	<b>L2</b>
			1018	1120	1073	1128	1183	1238	1293	1348	1402	1457	1512	1567	1624	1822
		<i>Tight Seat</i>														
<b>296-C</b>		1102	1212	1193	1268	1344	1419	1495	1571	1646	1722	1797	1873	1958	2230	
		<i>Semi-Attached Cushion</i>														
 297-P  297-C	<b>BENCH / SEWN BISCUIT TUFTING</b>		<b>Overall:</b> 52"w 20.5"d 18"h <b>Seat:</b> 48"w 20.5"d 18"h			<b>Arm:</b> n/a <b>Weight:</b> 45 lbs.			<b>COM:</b> 2.25 yds. (297-P) / 3 yds. (297-C) <b>COL:</b> 40.5 sq.ft. (297-P) / 54 sq.ft. (297-C)							
	<b>297-P</b>		<b>COM</b>	<b>COL</b>	<b>1</b>	<b>2</b>	<b>3</b>	<b>4</b>	<b>5</b>	<b>6</b>	<b>7</b>	<b>8</b>	<b>9</b>	<b>10</b>	<b>L1</b>	<b>L2</b>
			1068	1175	1120	1175	1230	1285	1340	1395	1450	1505	1560	1615	1681	1879
		<i>Biscuit Tufted Tight Seat</i>														
<b>297-C</b>		1149	1264	1237	1313	1388	1464	1540	1615	1691	1766	1842	1918	2011	2283	
		<i>Biscuit Tufted Semi-Attached Cushion</i>														
 298-P  298-C	<b>BENCH / PLAIN TAILORING</b>		<b>Overall:</b> 72"w 20.5"d 18"h <b>Seat:</b> 68"w 20.5"d 18"h			<b>Arm:</b> n/a <b>Weight:</b> 55 lbs.			<b>COM:</b> 3 yds. (298-P) / 4 yds. (298-C) <b>COL:</b> 54 sq.ft. (298-P) / 72 sq.ft. (298-C)							
	<b>298-P</b>		<b>COM</b>	<b>COL</b>	<b>1</b>	<b>2</b>	<b>3</b>	<b>4</b>	<b>5</b>	<b>6</b>	<b>7</b>	<b>8</b>	<b>9</b>	<b>10</b>	<b>L1</b>	<b>L2</b>
			1356	1492	1434	1509	1585	1660	1736	1812	1887	1963	2038	2114	2194	2466
		<i>Tight Seat</i>														
<b>298-C</b>		1437	1581	1565	1668	1771	1874	1977	2080	2183	2286	2389	2492	2607	2978	
		<i>Two Semi-Attached Cushions</i>														
 299-P  299-C	<b>BENCH / SEWN BISCUIT TUFTING</b>		<b>Overall:</b> 72"w 20.5"d 18"h <b>Seat:</b> 68"w 20.5"d 18"h			<b>Arm:</b> n/a <b>Weight:</b> 55 lbs.			<b>COM:</b> 3 yds. (299-P) / 4 yds. (299-C) <b>COL:</b> 54 sq.ft. (299-P) / 72 sq.ft. (299-C)							
	<b>299-P</b>		<b>COM</b>	<b>COL</b>	<b>1</b>	<b>2</b>	<b>3</b>	<b>4</b>	<b>5</b>	<b>6</b>	<b>7</b>	<b>8</b>	<b>9</b>	<b>10</b>	<b>L1</b>	<b>L2</b>
			1398	1537	1473	1548	1624	1699	1775	1851	1926	2002	2077	2153	2309	2581
		<i>Biscuit Tufted Tight Seat</i>														
<b>299-C</b>		1484	1632	1609	1712	1815	1918	2022	2125	2228	2331	2434	2537	2753	3125	
		<i>Two Biscuit Tufted Semi-Attached Cushions</i>														
<b>TABLET ARMS</b>			<b>Overall:</b> 22"w 11"d 16"h (250-4L-4V-4C) / 18"w 9"d 16"h (290-4L-4V-4C) <b>Weight:</b> 10 lbs. (250-4L-4V-4C) / 5 lbs. (290-4L-4V-4C)													
 22"W  18"W	<b>250-4L</b>	\$441 Laminate Tablet Arm - 22"w (Lounge) <i>High Pressure Laminate Face / Self Edge</i>					<b>290-4L</b>	\$404 Laminate Tablet Arm - 18"w (Guest / Bench) <i>High Pressure Laminate Face / Self Edge</i>								
	<b>250-4V</b>	\$662 Veneer Tablet Arm - 22"w (Lounge) <i>Sunburst Veneer Face / Vertical Grain Edgeband</i>					<b>290-4V</b>	\$470 Veneer Tablet Arm - 18"w (Guest / Bench) <i>Sunburst Veneer Face / Vertical Grain Edgeband</i>								
	<b>250-4C</b>	\$586 Solid Surface Tablet Arm - 22"w (Lounge) <i>Solid Surface Face / Self Edge</i>					<b>290-4C</b>	\$491 Solid Surface Tablet Arm - 18"w (Guest / Bench) <i>Solid Surface Face / Self Edge</i>								
		<i>Tablet Arm Is Non-Handed / May Be Used On Left Or Right Side</i>														

**DESCRIPTION:**

- Solid Cherry Legs & Rails
- Cherry Veneer Top Banded With Cherry Veneer
- 10 Year Warranty

**OPTIONS:**

Specify Exposed Wood Finish (See Page 6)



Square Edge Profile Standard

CAMERA TABLES		ITEM #:	SPECIFICATIONS   GRADES   LIST PRICES:													
LOW TABLE			<b>Overall: 16"dia 18"h</b> <b>Weight: 20 lbs.</b>													
			COM	COL	1	2	3	4	5	6	7	8	9	10	L1	L2
		2516D18-L	812 <i>High Pressure Laminate Face / Self Edge</i>													
		2516D18-V	969 <i>Sunburst Veneer Face / Vertical Grain Edgeband</i>													
		2516D18-C	992 <i>Solid Surface Face / Self Edge</i>													
TABLE WITH SHELF			<b>Overall: 18"dia 22"h</b> <b>Weight: 25 lbs.</b>													
			COM	COL	1	2	3	4	5	6	7	8	9	10	L1	L2
		2518D22-L	1295 <i>High Pressure Laminate Face / Self Edge</i>													
		2518D22-V	1522 <i>Sunburst Veneer Face &amp; Shelf / Vertical Grain Edgeband</i>													
		2518D22-C	1446 <i>Solid Surface Face / Self Edge</i>													
COFFEE TABLE			<b>Overall: 22"dia 16"h</b> <b>Weight: 30 lbs.</b>													
			COM	COL	1	2	3	4	5	6	7	8	9	10	L1	L2
		2522D16-L	901 <i>High Pressure Laminate Face / Self Edge</i>													
		2522D16-V	1169 <i>Sunburst Veneer Face / Vertical Grain Edgeband</i>													
		2522D16-C	1215 <i>Solid Surface Face / Self Edge</i>													
COFFEE TABLE			<b>Overall: 36"dia 16"h</b> <b>Weight: 57 lbs.</b>													
			COM	COL	1	2	3	4	5	6	7	8	9	10	L1	L2
		2536D16-L	1334 <i>High Pressure Laminate Face / Self Edge</i>													
		2536D16-V	2265 <i>Sunburst Veneer Face / Vertical Grain Edgeband</i>													
		2536D16-C	2387 <i>Solid Surface Face / Self Edge</i>													

**DESCRIPTION:**

- Solid Cherry Legs & Rails
- Cherry Veneer Top Banded With Cherry Veneer
- 10 Year Warranty

**OPTIONS:**

Specify Exposed Wood Finish (See Page 6)



Square Edge Profile Standard

**TABLES**

ITEM #:

SPECIFICATIONS | GRADES | LIST PRICES:

**END TABLE**

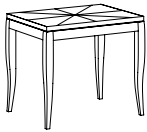
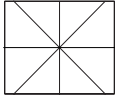

252420-L

252420-V

252420-C

**Overall:** 24"w 20"d 22"h  
**Weight:** 35 lbs.

COM	COL	1	2	3	4	5	6	7	8	9	10	L1	L2
-----	-----	---	---	---	---	---	---	---	---	---	----	----	----

925  
High Pressure Laminate Face / Self Edge

1146  
Sunburst Veneer Face / Vertical Grain Edgeband

1309  
Solid Surface Face / Self Edge

**END TABLE**

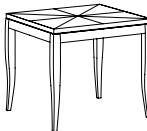
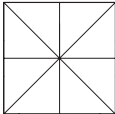

252424-L

252424-V

252424-C

**Overall:** 24"w 24"d 22"h  
**Weight:** 40 lbs.

COM	COL	1	2	3	4	5	6	7	8	9	10	L1	L2
-----	-----	---	---	---	---	---	---	---	---	---	----	----	----

962  
High Pressure Laminate Face / Self Edge

1212  
Sunburst Veneer Face / Vertical Grain Edgeband

1468  
Solid Surface Face / Self Edge

**COFFEE TABLE**

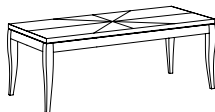
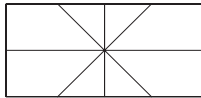

254220-L

254220-V

254220-C

**Overall:** 42"w 20"d 16"h  
**Weight:** 45 lbs.

COM	COL	1	2	3	4	5	6	7	8	9	10	L1	L2
-----	-----	---	---	---	---	---	---	---	---	---	----	----	----

1117  
High Pressure Laminate Face / Self Edge

1640  
Sunburst Veneer Face / Vertical Grain Edgeband

1989  
Solid Surface Face / Self Edge

**OVAL COFFEE TABLE**

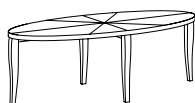
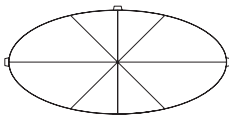

2548E16-L

2548E16-V

2548E16-C

**Overall:** 48"w 24"d 16"h  
**Weight:** 50 lbs.

COM	COL	1	2	3	4	5	6	7	8	9	10	L1	L2
-----	-----	---	---	---	---	---	---	---	---	---	----	----	----

1459  
High Pressure Laminate Face / Self Edge

2203  
Sunburst Veneer Face / Vertical Grain Edgeband

2389  
Solid Surface Face / Self Edge

**DESCRIPTION:**

- Solid Cherry Legs & Rails
- Cherry Veneer Top Banded With Cherry Veneer
- 10 Year Warranty

**OPTIONS:**

Specify Exposed Wood Finish (See Page 6)



Square Edge Profile Standard

**TABLES**

ITEM #:

SPECIFICATIONS | GRADES | LIST PRICES:

**SOFA TABLE**

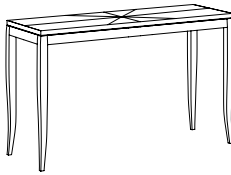
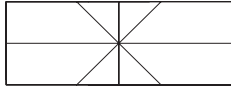

**Overall:** 48"w 18"d 30"h  
**Weight:** 50 lbs.

COM	COL	1	2	3	4	5	6	7	8	9	10	L1	L2
-----	-----	---	---	---	---	---	---	---	---	---	----	----	----

**254818-L**

1272  
*High Pressure Laminate Face / Self Edge*

**254818-V**

1754  
*Sunburst Veneer Face / Vertical Grain Edgeband*

**254818-C**

1981  
*Solid Surface Face / Self Edge*

COVERS	OPTION #:	SPECIFICATIONS   LIST PRICES   AVAILABILITY:
<p>CONTRASTING COVERS</p> 	<p><b>Overall:</b> n/a</p> <hr/> <p><b>CC</b> \$129</p> <p><i>NOTE: If Two Or More Upholsteries Or Leathers Are Used On Any Piece Of Furniture, Then A Contrast Charge Will Apply Per Order. When Using Trinity Upholstery, The Higher Priced Upholstery Grade Will Be Used In Pricing, Unless It's Trinity Leather With Fabric Contrast Welt, Or COM With Trinity Contrast Welt, Then Contact Customer Service For Pricing.</i></p> <p><b>Available:</b> Radcliffe Square Collection</p>	

Cilo<sup>2</sup>

---

EXECUTIVE SEATING

Effective: August 1, 2022

T R I N I T Y

**Date:**

**Page:**

**Modification:**

**Description:**

---



**DESCRIPTION:**

- Upholstery Frames: Curved Plywood & Hardwood
- Seat / Back: High Density Polyurethane Foam
- Aluminum Arms: Polished Cast Aluminum Arm Fitted w/ Black Rigid Polyurethane Arm Insert
- 10 Year Warranty
- 350 lbs. Weight Rating

**NOTE:** Cilo<sup>2</sup> Is A Redesign Of Our Original Cilo Executive Collection Released in 2013. Although Cilo<sup>2</sup> Has New Style Numbers And A New Design, The Original Cilo Is Still Available Upon Request. Please Contact Customer Service For More Information.

**OPTIONS:**









UA1 Cilo<sup>2</sup> Upholstered Arms ..... Contact Factory  
 Polished Aluminum Base / Tilt Swivel w/ Lock / Pneumatic Seat Height Adj.....\$98

**Note: For All (-2) Item Numbers**

Polished Aluminum Base / Knee Tilt Swivel / Pneumatic Seat Height Adj.....\$108

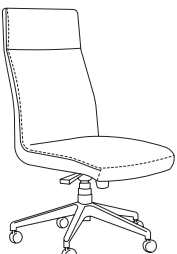
**Note: For All (-4) Item Numbers**

Base & Caster Options Available (See Cilo<sup>2</sup> Options Pages)

EXECUTIVE		ITEM #:	SPECIFICATIONS   GRADES   LIST PRICES:													
<b>HIGH BACK / UPHOLSTERED ARM</b>			<b>Overall:</b> 26"w 28"d 44.5"-47.25"h			<b>Arm:</b> 27"-29.75"h			<b>COM:</b> 3 yds.							
			<b>Seat:</b> 21.5"w 19.25"d 18"-21"h			<b>Weight:</b> 62 lbs.			<b>COL:</b> 54 sq.ft.							
			<b>COM</b>	<b>COL</b>	<b>1</b>	<b>2</b>	<b>3</b>	<b>4</b>	<b>5</b>	<b>6</b>	<b>7</b>	<b>8</b>	<b>9</b>	<b>10</b>	<b>L1</b>	<b>L2</b>
307-2	307-4	<b>307-2</b>	1447	1592	1519	1595	1670	1746	1821	1897	1973	2048	2124	2199	2366	2639
			<i>High Profile Black Base / Tilt Swivel w/ Lock / Pneumatic Seat Height Adjustment</i>													
		<b>307-4</b>	1499	1649	1569	1644	1720	1795	1871	1947	2022	2098	2173	2249	2416	2688
			<i>High Profile Black Base / Knee Tilt Swivel w/ Infinite Lock / Pneumatic Seat Height Adjustment</i>													
<b>HIGH BACK / ALUMINUM ARM</b>			<b>Overall:</b> 26"w 28"d 44.5"-47.25"h			<b>Arm:</b> 27"-29.75"h			<b>COM:</b> 2.5 yds.							
			<b>Seat:</b> 21.5"w 19.25"d 18"-21"h			<b>Weight:</b> 62 lbs.			<b>COL:</b> 45 sq.ft.							
			<b>COM</b>	<b>COL</b>	<b>1</b>	<b>2</b>	<b>3</b>	<b>4</b>	<b>5</b>	<b>6</b>	<b>7</b>	<b>8</b>	<b>9</b>	<b>10</b>	<b>L1</b>	<b>L2</b>
308-2	308-4	<b>308-2</b>	1476	1623	1519	1581	1643	1704	1766	1828	1890	1952	2014	2076	2211	2434
			<i>High Profile Black Base / Tilt Swivel w/ Lock / Pneumatic Seat Height Adjustment</i>													
		<b>308-4</b>	1534	1687	1574	1636	1698	1759	1821	1883	1945	2007	2069	2131	2266	2489
			<i>High Profile Black Base / Knee Tilt Swivel w/ Infinite Lock / Pneumatic Seat Height Adjustment</i>													
<b>HIGH BACK / ARMLESS</b>			<b>Overall:</b> 21.5"w 28"d 44.5"-47.25"h			<b>Arm:</b> n/a			<b>COM:</b> 2.5 yds.							
			<b>Seat:</b> 21.5"w 19.25"d 18"-21"h			<b>Weight:</b> 58 lbs.			<b>COL:</b> 45 sq.ft.							
			<b>COM</b>	<b>COL</b>	<b>1</b>	<b>2</b>	<b>3</b>	<b>4</b>	<b>5</b>	<b>6</b>	<b>7</b>	<b>8</b>	<b>9</b>	<b>10</b>	<b>L1</b>	<b>L2</b>
309-2	309-4	<b>309-2</b>	1259	1385	1301	1356	1411	1466	1521	1576	1631	1685	1740	1795	1926	2124
			<i>High Profile Black Base / Tilt Swivel w/ Lock / Pneumatic Seat Height Adjustment</i>													
		<b>309-4</b>	1312	1443	1350	1405	1460	1515	1570	1625	1680	1735	1790	1845	1975	2173
			<i>High Profile Black Base / Knee Tilt Swivel w/ Infinite Lock / Pneumatic Seat Height Adjustment</i>													
<b>MID-BACK / UPHOLSTERED ARM</b>			<b>Overall:</b> 26"w 27.25"d 37.5"-40.25"h			<b>Arm:</b> 27"-29.75"h			<b>COM:</b> 2.25 yds.							
			<b>Seat:</b> 21.5"w 19.25"d 18"-21"h			<b>Weight:</b> 53 lbs.			<b>COL:</b> 41 sq.ft.							
			<b>COM</b>	<b>COL</b>	<b>1</b>	<b>2</b>	<b>3</b>	<b>4</b>	<b>5</b>	<b>6</b>	<b>7</b>	<b>8</b>	<b>9</b>	<b>10</b>	<b>L1</b>	<b>L2</b>
310-2	310-4	<b>310-2</b>	1323	1455	1333	1375	1416	1457	1498	1540	1581	1622	1663	1705	1826	1975
			<i>High Profile Black Base / Tilt Swivel w/ Lock / Pneumatic Seat Height Adjustment</i>													
		<b>310-4</b>	1364	1500	1377	1413	1454	1496	1537	1578	1619	1661	1702	1743	1865	2013
			<i>High Profile Black Base / Knee Tilt Swivel w/ Infinite Lock / Pneumatic Seat Height Adjustment</i>													

**DESCRIPTION:**

- Upholstery Frames: Curved Plywood & Hardwood
- Seat / Back: High Density Polyurethane Foam
- Aluminum Arms: Polished Cast Aluminum Arm Fitted w/ Black Rigid Polyurethane Arm Insert
- 10 Year Warranty
- 350 lbs. Weight Rating

**NOTE:** Cilo<sup>2</sup> Is A Redesign Of Our Original Cilo Executive Collection Released in 2013. Although Cilo<sup>2</sup> Has New Style Numbers And A New Design, The Original Cilo Is Still Available Upon Request. Please Contact Customer Service For More Information.

**OPTIONS:**





UA1 Cilo<sup>2</sup> Upholstered Arms..... Contact Factory  
 Polished Aluminum Base / Tilt Swivel w/ Lock / Pneumatic Seat Height Adj.....\$98

**Note: For All (-2) Item Numbers**





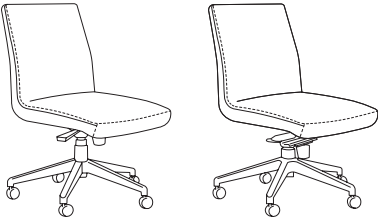

Polished Aluminum Base / Knee Tilt Swivel / Pneumatic Seat Height Adj.....\$108



**Note: For All (-4) Item Numbers**

Base & Caster Options Available (See Cilo<sup>2</sup> Options Pages)

EXECUTIVE		ITEM #:	SPECIFICATIONS   GRADES   LIST PRICES:												
<b>MID-BACK / UPHOLSTERED ARM JURY CHAIR</b>			<b>Overall:</b> 26"w 27.25"d 37.5"-40.25"h			<b>Arm:</b> 27"-29.75"h			<b>COM:</b> 2.25 yds.						
			<b>Seat:</b> 21.5"w 19.25"d 18"-21"h			<b>Weight:</b> 53 lbs.			<b>COL:</b> 41 sq.ft.						
	<b>310-5</b>	<b>COM</b>	<b>COL</b>	<b>1</b>	<b>2</b>	<b>3</b>	<b>4</b>	<b>5</b>	<b>6</b>	<b>7</b>	<b>8</b>	<b>9</b>	<b>10</b>	<b>L1</b>	<b>L2</b>
		1451	1596	1465	1496	1537	1578	1619	1661	1702	1743	1784	1825	1947	2096
<i>Black Jury Base / Tilt Swivel w/ Lock / Pneumatic Seat Height Adjustment / 360° Self-Centering</i>															
<b>MID-BACK / ALUMINUM ARM</b>			<b>Overall:</b> 26"w 27.25"d 37.5"-40.25"h			<b>Arm:</b> 27"-29.75"h			<b>COM:</b> 1.75 yds.						
			<b>Seat:</b> 21.5"w 19.25"d 18"-21"h			<b>Weight:</b> 53 lbs.			<b>COL:</b> 32 sq.ft.						
	<b>311-2</b>	<b>COM</b>	<b>COL</b>	<b>1</b>	<b>2</b>	<b>3</b>	<b>4</b>	<b>5</b>	<b>6</b>	<b>7</b>	<b>8</b>	<b>9</b>	<b>10</b>	<b>L1</b>	<b>L2</b>
		1358	1493	1366	1407	1449	1490	1531	1572	1614	1655	1696	1737	1841	1990
<i>High Profile Black Base / Tilt Swivel w/ Lock / Pneumatic Seat Height Adjustment</i>															
	<b>311-4</b>	<b>COM</b>	<b>COL</b>	<b>1</b>	<b>2</b>	<b>3</b>	<b>4</b>	<b>5</b>	<b>6</b>	<b>7</b>	<b>8</b>	<b>9</b>	<b>10</b>	<b>L1</b>	<b>L2</b>
		1416	1557	1427	1462	1504	1545	1586	1627	1668	1710	1751	1792	1896	2045
<i>High Profile Black Base / Knee Tilt Swivel w/ Infinite Lock / Pneumatic Seat Height Adjustment</i>															
<b>MID-BACK / ALUMINUM ARM JURY CHAIR</b>			<b>Overall:</b> 26"w 27.25"d 37.5"-40.25"h			<b>Arm:</b> 27"-29.75"h			<b>COM:</b> 1.75 yds.						
			<b>Seat:</b> 21.5"w 19.25"d 18"-21"h			<b>Weight:</b> 53 lbs.			<b>COL:</b> 32 sq.ft.						
	<b>311-5</b>	<b>COM</b>	<b>COL</b>	<b>1</b>	<b>2</b>	<b>3</b>	<b>4</b>	<b>5</b>	<b>6</b>	<b>7</b>	<b>8</b>	<b>9</b>	<b>10</b>	<b>L1</b>	<b>L2</b>
		1544	1698	1553	1583	1625	1666	1707	1748	1789	1831	1872	1913	2017	2166
<i>Black Jury Base / Tilt Swivel w/ Lock / Pneumatic Seat Height Adjustment / 360° Self-Centering</i>															
<b>MID-BACK / ARMLESS</b>			<b>Overall:</b> 21.5"w 27.25"d 37.5"-40.25"h			<b>Arm:</b> n/a			<b>COM:</b> 1.75 yds.						
			<b>Seat:</b> 21.5"w 19.25"d 18"-21"h			<b>Weight:</b> 49 lbs.			<b>COL:</b> 32 sq.ft.						
	<b>312-2</b>	<b>COM</b>	<b>COL</b>	<b>1</b>	<b>2</b>	<b>3</b>	<b>4</b>	<b>5</b>	<b>6</b>	<b>7</b>	<b>8</b>	<b>9</b>	<b>10</b>	<b>L1</b>	<b>L2</b>
		1150	1264	1169	1211	1252	1293	1334	1375	1417	1458	1499	1540	1644	1793
<i>High Profile Black Base / Tilt Swivel w/ Lock / Pneumatic Seat Height Adjustment</i>															
	<b>312-4</b>	<b>COM</b>	<b>COL</b>	<b>1</b>	<b>2</b>	<b>3</b>	<b>4</b>	<b>5</b>	<b>6</b>	<b>7</b>	<b>8</b>	<b>9</b>	<b>10</b>	<b>L1</b>	<b>L2</b>
		1196	1316	1219	1255	1296	1337	1378	1419	1461	1502	1543	1584	1688	1837
<i>High Profile Black Base / Knee Tilt Swivel w/ Infinite Lock / Pneumatic Seat Height Adjustment</i>															
<b>MID-BACK / ARMLESS JURY CHAIR</b>			<b>Overall:</b> 21.5"w 27.25"d 37.5"-40.25"h			<b>Arm:</b> n/a			<b>COM:</b> 1.75 yds.						
			<b>Seat:</b> 21.5"w 19.25"d 18"-21"h			<b>Weight:</b> 49 lbs.			<b>COL:</b> 32 sq.ft.						
	<b>312-5</b>	<b>COM</b>	<b>COL</b>	<b>1</b>	<b>2</b>	<b>3</b>	<b>4</b>	<b>5</b>	<b>6</b>	<b>7</b>	<b>8</b>	<b>9</b>	<b>10</b>	<b>L1</b>	<b>L2</b>
		1330	1463	1351	1381	1422	1463	1505	1546	1587	1628	1670	1711	1815	1963
<i>Black Jury Base / Tilt Swivel w/ Lock / Pneumatic Seat Height Adjustment / 360° Self-Centering</i>															

BASES	OPTION #:	SPECIFICATIONS   LIST PRICES   AVAILABILITY:								
<p>TRANSITIONAL WOOD BASE</p> 	<p>TWB</p>	<p><b>Overall:</b> 25"w 25"d 5.5"h</p> <hr/> <p><b>\$193</b> Solid Hardwood Cap, Steel Reinforced 5 Prong Base With 55mm Black Dual Wheel Casters.</p> <p>OPTIONS:</p> <table border="0"> <tr> <td>Carpet Caster - 2" Metal Balls</td> <td>\$164 (Set Of 5)</td> </tr> <tr> <td>Antique Bronze Hooded Caster - 2" Rubber Ball</td> <td>\$151 (Set Of 5)</td> </tr> <tr> <td>Brass Hooded Black Caster - 2" Dual Wheels</td> <td>\$84 (Set Of 5)</td> </tr> </table> <p><b>Available:</b> Cilo<sup>2</sup> Executive Seating</p>	Carpet Caster - 2" Metal Balls	\$164 (Set Of 5)	Antique Bronze Hooded Caster - 2" Rubber Ball	\$151 (Set Of 5)	Brass Hooded Black Caster - 2" Dual Wheels	\$84 (Set Of 5)		
Carpet Caster - 2" Metal Balls	\$164 (Set Of 5)									
Antique Bronze Hooded Caster - 2" Rubber Ball	\$151 (Set Of 5)									
Brass Hooded Black Caster - 2" Dual Wheels	\$84 (Set Of 5)									
<p>CLASSIC WOOD BASE</p> 	<p>CWB</p>	<p><b>Overall:</b> 28"w 28"d 5"h</p> <hr/> <p><b>\$193</b> Solid Hardwood Cap, Steel Reinforced 5 Prong Base With 55mm Black Dual Wheel Casters.</p> <p>OPTIONS:</p> <table border="0"> <tr> <td>Carpet Caster - 2" Metal Balls</td> <td>\$164 (Set Of 5)</td> </tr> <tr> <td>Antique Bronze Hooded Caster - 2" Rubber Ball</td> <td>\$151 (Set Of 5)</td> </tr> <tr> <td>Brass Hooded Black Caster - 2" Dual Wheels</td> <td>\$84 (Set Of 5)</td> </tr> <tr> <td>Brass Scuff Plates</td> <td>\$105 (Set Of 5)</td> </tr> </table> <p><b>Available:</b> Cilo<sup>2</sup> Executive Seating</p>	Carpet Caster - 2" Metal Balls	\$164 (Set Of 5)	Antique Bronze Hooded Caster - 2" Rubber Ball	\$151 (Set Of 5)	Brass Hooded Black Caster - 2" Dual Wheels	\$84 (Set Of 5)	Brass Scuff Plates	\$105 (Set Of 5)
Carpet Caster - 2" Metal Balls	\$164 (Set Of 5)									
Antique Bronze Hooded Caster - 2" Rubber Ball	\$151 (Set Of 5)									
Brass Hooded Black Caster - 2" Dual Wheels	\$84 (Set Of 5)									
Brass Scuff Plates	\$105 (Set Of 5)									
<p>ARCHED RESIN BASE</p> 	<p>ARB</p>	<p><b>Overall:</b> 27"w 27"d 6.25"h</p> <hr/> <p>No Charge Black Reinforced Nylon 5 Prong Base With 55mm Black Dual Wheel Casters.</p> <p>OPTIONS:</p> <table border="0"> <tr> <td>Black Sculptured Glides</td> <td>No Upcharge</td> </tr> </table> <p><b>Available:</b> Cilo<sup>2</sup> Executive Seating</p>	Black Sculptured Glides	No Upcharge						
Black Sculptured Glides	No Upcharge									
<p>POLISHED ALUMINUM BASE</p> 	<p>PAB</p>	<p><b>Overall:</b> 26"w 26"d 8"h</p> <hr/> <p><b>\$98</b> Polished Aluminum 5 Prong Base With 55mm Black Dual Wheel Casters</p> <p>OPTIONS:</p> <table border="0"> <tr> <td>C4 Black Sculptured Glides</td> <td>No Upcharge (Set Of 5)</td> </tr> <tr> <td>C5 Polished Aluminum Hooded Casters</td> <td>\$105 (Set Of 5)</td> </tr> </table> <p><b>Available:</b> Cilo<sup>2</sup> Executive Seating</p>	C4 Black Sculptured Glides	No Upcharge (Set Of 5)	C5 Polished Aluminum Hooded Casters	\$105 (Set Of 5)				
C4 Black Sculptured Glides	No Upcharge (Set Of 5)									
C5 Polished Aluminum Hooded Casters	\$105 (Set Of 5)									

BASES / CASTERS	OPTION #:	SPECIFICATIONS   LIST PRICES   AVAILABILITY:
<p><b>HIGH PROFILE BASE</b></p> 	<p><b>HPB</b></p>	<p><b>Overall:</b> 26"w 26"d 8"h</p> <hr/> <p>Standard CILO Base - No Charge  <i>Black Reinforced Nylon 5 Prong Base With 55mm Black Dual Wheel Casters</i></p> <p><b>Available:</b> Cilo<sup>2</sup> Executive Seating</p>
<p><b>JURY BASE</b></p> 	<p><b>JRB</b></p>	<p><b>Overall:</b> 8.5" Diameter 3.75"h</p> <hr/> <p>\$198  <i>360° Rotation, Self Centering With Pneumatic Height Adjustment</i></p> <p>OPTIONS:      No Rotation</p> <p><b>Available:</b> Cilo<sup>2</sup> Executive Seating</p>
<p><b>CASTERS</b></p> <div style="display: flex; flex-wrap: wrap;"> <div style="width: 50%;">  <p>(C1) Carpet Caster - 2" Metal Balls</p> </div> <div style="width: 50%;">  <p>(C2) Antique Bronze Hooded Caster - 2" Rubber Ball</p> </div> <div style="width: 50%;">  <p>(C3) Brass Hooded Black Caster - 2" Dual Wheels</p> </div> <div style="width: 50%;">  <p>(C4) Black Sculptured Glide - 2" Flat Bottom Glide</p> </div> <div style="width: 50%;">  <p>(C5) Polished Aluminum Caster - 2" Dual Wheels</p> </div> </div>	<p><b>C1</b></p> <p><b>C2</b></p> <p><b>C3</b></p> <p><b>C4</b></p> <p><b>C5</b></p>	<p><b>Overall:</b> 2"h</p> <hr/> <p>\$164 (Set Of 5)  <i>Carpet Caster - 2" Metal Balls (Additional Finishes Available)</i></p> <p>\$151 (Set Of 5)  <i>Antique Bronze Hooded Caster - 2" Rubber Ball (Additional Finishes Available)</i></p> <p>\$84 (Set Of 5)  <i>Brass Hooded Black Caster - 2" Dual Wheels (Additional Finishes Available)</i></p> <p>No Charge (Set Of 5)  <i>Black Sculptured Glide - 2" Flat Bottom Glide</i></p> <p>\$105 (Set Of 5)  <i>Polished Aluminum Hooded Caster - 2" Dual Wheels</i></p> <p><b>Available:</b> Cilo<sup>2</sup> Executive Seating</p>

SCUFF PLATES / ARMS / COVERS	OPTION #:	SPECIFICATIONS   LIST PRICES   AVAILABILITY:
<p>SCUFF PLATES</p> 	<p><b>Overall:</b> 1"w 4"d</p> <hr/> <p><b>SP</b> \$103 (Set Of 5) <i>(Specify Brass Or Pewter)</i></p> <p><b>Available:</b> Classic Wood Base Only</p>	
<p>CILO UPHOLSTERED ARMS</p> 	<p><b>Overall:</b> 2.75"w 11"d 13"h</p> <hr/> <p><b>UA1</b> Contact Factory For Pricing <i>(Specify Fabric Or Leather)</i></p> <p><b>Available:</b> Cilo<sup>2</sup> Executive Chairs</p>	
<p>CONTRASTING COVERS</p> 	<p><b>Overall:</b> n/a</p> <hr/> <p><b>CC</b> \$129</p> <p><i>NOTE: If Two Or More Upholsteries Or Leathers Are Used On Any Piece Of Furniture, Then A Contrast Charge Will Apply Per Order. When Using Trinity Upholstery, The Higher Priced Upholstery Grade Will Be Used In Pricing, Unless It's Trinity Leather With Fabric Contrast Welt, Or COM With Trinity Contrast Welt, Then Contact Customer Service For Pricing.</i></p> <p><b>Available:</b> Cilo<sup>2</sup> Executive Chairs</p>	

# Ziggy

---

GUEST SEATING

Effective: August 1, 2022

T R I N I T Y

**Date:**

**Page:**

**Modification:**

**Description:**









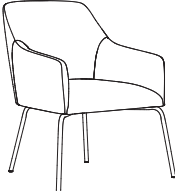

---

**DESCRIPTION:**

- Upholstery Frames: Plywood & Hardwood
- Seat: High Density Polyurethane Foam Over Plywood
- Back: High Density Foam Over Plywood Frame
- (5) Base Styles Available
- 10 Year Warranty

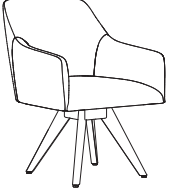
**OPTIONS:**

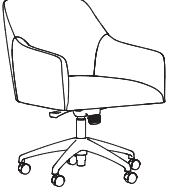
Feather Down & Polyester Pillows Available (See Page 5)  
Specify Exposed Wood Finish (See Page 6)

GUEST		ITEM #:	SPECIFICATIONS   GRADES   LIST PRICES:													
<b>BUCKET GUEST CHAIR / CLOSED &amp; OPEN BACK</b>			<b>Overall:</b> 25.5"w 27.75"d 35"h		<b>Arm:</b> 26"h		<b>COM:</b> 4 yds.									
			<b>Seat:</b> 20"w 20"d 19"h		<b>Weight:</b> 55 lbs.		<b>COL:</b> 72 sq.ft.									
			<b>COM</b>	<b>COL</b>	<b>1</b>	<b>2</b>	<b>3</b>	<b>4</b>	<b>5</b>	<b>6</b>	<b>7</b>	<b>8</b>	<b>9</b>	<b>10</b>	<b>L1</b>	<b>L2</b>
		<b>330-A</b>	1290	1419	1426	1529	1632	1735	1838	1941	2044	2147	2251	2354	2468	2839
			<i>4 Leg - Black Steel Base / Tight Seat &amp; Closed Back</i>													
		<b>331-A</b>	1368	1505	1500	1603	1706	1809	1912	2015	2118	2221	2324	2427	2553	2924
			<i>4 Leg - Black Steel Base / Tight Seat &amp; Open Back</i>													
330-A Closed Back																
331-A Open Back																
<b>BUCKET GUEST CHAIR / CLOSED &amp; OPEN BACK</b>			<b>Overall:</b> 25.5"w 27.75"d 35"h		<b>Arm:</b> 26"h		<b>COM:</b> 4 yds.									
			<b>Seat:</b> 20"w 20"d 19"h		<b>Weight:</b> 55 lbs.		<b>COL:</b> 72 sq.ft.									
			<b>COM</b>	<b>COL</b>	<b>1</b>	<b>2</b>	<b>3</b>	<b>4</b>	<b>5</b>	<b>6</b>	<b>7</b>	<b>8</b>	<b>9</b>	<b>10</b>	<b>L1</b>	<b>L2</b>
		<b>330-B</b>	1150	1266	1294	1397	1500	1603	1706	1809	1912	2016	2119	2222	2336	2708
			<i>4 Leg - Flat Polished Base / Tight Seat &amp; Closed Back</i>													
		<b>331-B</b>	1229	1351	1368	1471	1574	1677	1780	1883	1986	2089	2192	2296	2421	2792
			<i>4 Leg - Flat Polished Base / Tight Seat &amp; Open Back</i>													
330-B Closed Back																
331-B Open Back																
<b>BUCKET GUEST CHAIR / CLOSED &amp; OPEN BACK</b>			<b>Overall:</b> 25.5"w 27.75"d 35"h		<b>Arm:</b> 26"h		<b>COM:</b> 4 yds.									
			<b>Seat:</b> 20"w 20"d 19"h		<b>Weight:</b> 55 lbs.		<b>COL:</b> 72 sq.ft.									
			<b>COM</b>	<b>COL</b>	<b>1</b>	<b>2</b>	<b>3</b>	<b>4</b>	<b>5</b>	<b>6</b>	<b>7</b>	<b>8</b>	<b>9</b>	<b>10</b>	<b>L1</b>	<b>L2</b>
		<b>330-C</b>	1278	1406	1415	1518	1621	1724	1827	1930	2033	2136	2240	2343	2457	2828
			<i>4 Leg - Raised Polished Base / Tight Seat &amp; Closed Back</i>													
		<b>331-C</b>	1357	1492	1489	1592	1695	1798	1901	2004	2107	2210	2313	2416	2542	2913
			<i>4 Leg - Raised Polished Base / Tight Seat &amp; Open Back</i>													
330-C Closed Back																
331-C Open Back																
<b>BUCKET GUEST CHAIR / CLOSED &amp; OPEN BACK</b>			<b>Overall:</b> 25.5"w 27.75"d 35"h		<b>Arm:</b> 26"h		<b>COM:</b> 4 yds.									
			<b>Seat:</b> 20"w 20"d 19"h		<b>Weight:</b> 55 lbs.		<b>COL:</b> 72 sq.ft.									
			<b>COM</b>	<b>COL</b>	<b>1</b>	<b>2</b>	<b>3</b>	<b>4</b>	<b>5</b>	<b>6</b>	<b>7</b>	<b>8</b>	<b>9</b>	<b>10</b>	<b>L1</b>	<b>L2</b>
		<b>330-D</b>	1187	1306	1329	1432	1535	1638	1741	1844	1947	2050	2153	2256	2371	2742
			<i>4 Leg - Wood Base / Tight Seat &amp; Closed Back</i>													
		<b>331-D</b>	1312	1443	1446	1549	1653	1756	1859	1962	2065	2168	2271	2374	2499	2870
			<i>4 Leg - Wood Base / Tight Seat &amp; Open Back</i>													
330-D Closed Back																
331-D Open Back																
<b>BUCKET GUEST CHAIR / CLOSED &amp; OPEN BACK</b>			<b>Overall:</b> 25.5"w 27.75"d 35"h		<b>Arm:</b> 26"h		<b>COM:</b> 4 yds.									
			<b>Seat:</b> 20"w 20"d 19"h		<b>Weight:</b> 55 lbs.		<b>COL:</b> 72 sq.ft.									
			<b>COM</b>	<b>COL</b>	<b>1</b>	<b>2</b>	<b>3</b>	<b>4</b>	<b>5</b>	<b>6</b>	<b>7</b>	<b>8</b>	<b>9</b>	<b>10</b>	<b>L1</b>	<b>L2</b>
		<b>330-E</b>	1139	1253	1283	1386	1489	1592	1695	1798	1901	2005	2108	2211	2325	2697
			<i>Tilt Swivel / Pneumatic Seat Height Adjustment / Polished Five Star Base w/ 55mm Black Dual Wheel Casters / Tight Seat &amp; Closed Back</i>													
		<b>331-E</b>	1223	1345	1362	1465	1568	1672	1775	1878	1981	2084	2187	2290	2415	2786
			<i>Tilt Swivel / Pneumatic Seat Height Adjustment / Polished Five Star Base w/ 55mm Black Dual Wheel Casters / Tight Seat &amp; Open Back</i>													
330-E Closed Back																
331-E Open Back																



CONTRASTING COVERS	OPTION #:	SPECIFICATIONS   LIST PRICES   AVAILABILITY:
<p>CONTRASTING COVERS</p> 	<p><b>Overall:</b> n/a</p> <hr/> <p><b>CC</b> \$129  <i>NOTE: If Two Or More Upholsteries Or Leathers Are Used On Any Piece Of Furniture, Then A Contrast Charge Will Apply Per Order. When Using Trinity Upholstery, The Higher Priced Upholstery Grade Will Be Used In Pricing, Unless It's Trinity Leather With Fabric Contrast Welt, Or COM With Trinity Contrast Welt, Then Contact Customer Service For Pricing.</i></p> <p><b>Available:</b> Ziggy Collection</p>	

# Vroom

---

GUEST SEATING / TABLES

Effective: August 1, 2022

T R I N I T Y

**Date:**

**Page:**

**Modification:**

**Description:**





---

**DESCRIPTION:**

- Upholstery Frames: Molded Foam Over Steel
- Seat: Molded Foam Over Plywood
- Back: Molded Foam Over Steel
- (4) Base Styles Available
- 10 Year Warranty

**OPTIONS:**

Feather Down & Polyester Pillows Available (See Page 5)  
Specify Exposed Wood Finish / Laminate (See Page 6)



GUEST	ITEM #:	SPECIFICATIONS   GRADES   LIST PRICES:													
<p>HIGH BACK GUEST CHAIR</p> 	332-B	<b>Overall:</b> 25.25"w 26.25"d 37.5"h		<b>Arm:</b> 25"h		<b>COM:</b> 4 yds.									
		<b>Seat:</b> 19.25"w 18.25"d 19"h		<b>Weight:</b> 50 lbs.		<b>COL:</b> 72 sq.ft.									
		COM	COL	1	2	3	4	5	6	7	8	9	10	L1	L2
		1472	1619	1598	1701	1804	1907	2010	2113	2216	2319	2422	2525	2641	3012
<i>4 Leg - Flat Polished Base / Tight Seat &amp; Back</i>															
<p>HIGH BACK GUEST CHAIR</p> 	332-C	<b>Overall:</b> 25.25"w 26.25"d 37.5"h		<b>Arm:</b> 25"h		<b>COM:</b> 4 yds.									
		<b>Seat:</b> 19.25"w 18.25"d 19"h		<b>Weight:</b> 50 lbs.		<b>COL:</b> 72 sq.ft.									
		COM	COL	1	2	3	4	5	6	7	8	9	10	L1	L2
		1588	1747	1708	1811	1914	2017	2120	2223	2326	2429	2532	2635	2751	3122
<i>4 Leg - Raised Polished Base / Tight Seat &amp; Back</i>															
<p>HIGH BACK GUEST CHAIR</p> 	332-D	<b>Overall:</b> 25.25"w 26.25"d 37.5"h		<b>Arm:</b> 25"h		<b>COM:</b> 4 yds.									
		<b>Seat:</b> 19.25"w 18.25"d 19"h		<b>Weight:</b> 48 lbs.		<b>COL:</b> 72 sq.ft.									
		COM	COL	1	2	3	4	5	6	7	8	9	10	L1	L2
		1409	1550	1539	1642	1745	1848	1951	2054	2157	2260	2363	2467	2582	2953
<i>4 Leg - Wood Base / Tight Seat &amp; Back</i>															
<p>HIGH BACK GUEST CHAIR</p> 	332-E	<b>Overall:</b> 25.25"w 26.25"d 37.5"h		<b>Arm:</b> 25"h		<b>COM:</b> 4 yds.									
		<b>Seat:</b> 19.25"w 18.25"d 19"h		<b>Weight:</b> 50 lbs.		<b>COL:</b> 72 sq.ft.									
		COM	COL	1	2	3	4	5	6	7	8	9	10	L1	L2
		1385	1523	1515	1618	1721	1824	1928	2031	2134	2237	2340	2443	2558	2929
<i>Tilt Swivel / Pneumatic Seat Height Adjustment / Polished Five Star Base w/ 55mm Black Dual Wheel Casters / Tight Seat &amp; Back</i>															

**DESCRIPTION:**

- Table Top: High Pressure Laminate Top Over Plywood Core w/ Exposed Plywood Edge
- (3) Base Styles Available
- 10 Year Warranty

**OPTIONS:**

SE24D Self Edge Table Top - 24" Diameter .....\$33  
 Specify Exposed Wood Finish / Laminate (See Page 6)



END TABLES	ITEM #:	SPECIFICATIONS   GRADES   LIST PRICES:																																																						
<p><b>ROUND END TABLE WITH FLAT POLISHED BASE</b></p> 	324D22-B-L	<p><i>Overall: 24" Diameter 22"h</i>  <i>Weight: 30 lbs.</i></p> <table border="1" style="width: 100%; border-collapse: collapse;"> <thead> <tr> <th>COM</th> <th>COL</th> <th>1</th> <th>2</th> <th>3</th> <th>4</th> <th>5</th> <th>6</th> <th>7</th> <th>8</th> <th>9</th> <th>10</th> <th>L1</th> <th>L2</th> </tr> </thead> <tbody> <tr> <td colspan="14" style="text-align: center;">758</td> </tr> <tr> <td colspan="14" style="text-align: center;"><i>High Pressure Laminate Top w/ Exposed Plywood Edge / 4 Leg - Flat Polished Base</i></td> </tr> </tbody> </table>													COM	COL	1	2	3	4	5	6	7	8	9	10	L1	L2	758														<i>High Pressure Laminate Top w/ Exposed Plywood Edge / 4 Leg - Flat Polished Base</i>													
COM	COL	1	2	3	4	5	6	7	8	9	10	L1	L2																																											
758																																																								
<i>High Pressure Laminate Top w/ Exposed Plywood Edge / 4 Leg - Flat Polished Base</i>																																																								
<p><b>ROUND END TABLE WITH RAISED POLISHED BASE</b></p> 	324D22-C-L	<p><i>Overall: 24" Diameter 22"h</i>  <i>Weight: 30 lbs.</i></p> <table border="1" style="width: 100%; border-collapse: collapse;"> <thead> <tr> <th>COM</th> <th>COL</th> <th>1</th> <th>2</th> <th>3</th> <th>4</th> <th>5</th> <th>6</th> <th>7</th> <th>8</th> <th>9</th> <th>10</th> <th>L1</th> <th>L2</th> </tr> </thead> <tbody> <tr> <td colspan="14" style="text-align: center;">729</td> </tr> <tr> <td colspan="14" style="text-align: center;"><i>High Pressure Laminate Top w/ Exposed Plywood Edge / 4 Leg - Raised Polished Base</i></td> </tr> </tbody> </table>													COM	COL	1	2	3	4	5	6	7	8	9	10	L1	L2	729														<i>High Pressure Laminate Top w/ Exposed Plywood Edge / 4 Leg - Raised Polished Base</i>													
COM	COL	1	2	3	4	5	6	7	8	9	10	L1	L2																																											
729																																																								
<i>High Pressure Laminate Top w/ Exposed Plywood Edge / 4 Leg - Raised Polished Base</i>																																																								
<p><b>ROUND END TABLE WITH WOOD BASE</b></p> 	324D22-D-L	<p><i>Overall: 24" Diameter 22"h</i>  <i>Weight: 30 lbs.</i></p> <table border="1" style="width: 100%; border-collapse: collapse;"> <thead> <tr> <th>COM</th> <th>COL</th> <th>1</th> <th>2</th> <th>3</th> <th>4</th> <th>5</th> <th>6</th> <th>7</th> <th>8</th> <th>9</th> <th>10</th> <th>L1</th> <th>L2</th> </tr> </thead> <tbody> <tr> <td colspan="14" style="text-align: center;">703</td> </tr> <tr> <td colspan="14" style="text-align: center;"><i>High Pressure Laminate Top w/ Exposed Plywood Edge / 4 Leg - Wood Base</i></td> </tr> </tbody> </table>													COM	COL	1	2	3	4	5	6	7	8	9	10	L1	L2	703														<i>High Pressure Laminate Top w/ Exposed Plywood Edge / 4 Leg - Wood Base</i>													
COM	COL	1	2	3	4	5	6	7	8	9	10	L1	L2																																											
703																																																								
<i>High Pressure Laminate Top w/ Exposed Plywood Edge / 4 Leg - Wood Base</i>																																																								

**DESCRIPTION:**

- Upholstery Frames: Molded Foam Over Steel
- Seat: Molded Foam Over Plywood
- Back: Molded Foam Over Steel
- (4) Base Styles Available
- 10 Year Warranty

**OPTIONS:**

SE24S Self Edge Table Top - 24" x 24" Square .....\$41  
 Specify Exposed Wood Finish / Laminate (See Page 6)



END TABLES	ITEM #:	SPECIFICATIONS   GRADES   LIST PRICES:																																																						
<p><b>SQUARE END TABLE WITH FLAT POLISHED BASE</b></p> 	<p><b>3242422-B-L</b></p>	<p><i>Overall: 24"w 24"d 22"h</i>  <i>Weight: 30 lbs.</i></p> <table border="1" data-bbox="576 541 1534 583"> <thead> <tr> <th>COM</th> <th>COL</th> <th>1</th> <th>2</th> <th>3</th> <th>4</th> <th>5</th> <th>6</th> <th>7</th> <th>8</th> <th>9</th> <th>10</th> <th>L1</th> <th>L2</th> </tr> </thead> <tbody> <tr> <td colspan="14" style="text-align: center;">729</td> </tr> <tr> <td colspan="14" style="text-align: center;"><i>High Pressure Laminate Top w/ Exposed Plywood Edge / 4 Leg - Flat Polished Base</i></td> </tr> </tbody> </table>													COM	COL	1	2	3	4	5	6	7	8	9	10	L1	L2	729														<i>High Pressure Laminate Top w/ Exposed Plywood Edge / 4 Leg - Flat Polished Base</i>													
COM	COL	1	2	3	4	5	6	7	8	9	10	L1	L2																																											
729																																																								
<i>High Pressure Laminate Top w/ Exposed Plywood Edge / 4 Leg - Flat Polished Base</i>																																																								
<p><b>SQUARE END TABLE WITH RAISED POLISHED BASE</b></p> 	<p><b>3242422-C-L</b></p>	<p><i>Overall: 24"w 24"d 22"h</i>  <i>Weight: 30 lbs.</i></p> <table border="1" data-bbox="576 940 1534 982"> <thead> <tr> <th>COM</th> <th>COL</th> <th>1</th> <th>2</th> <th>3</th> <th>4</th> <th>5</th> <th>6</th> <th>7</th> <th>8</th> <th>9</th> <th>10</th> <th>L1</th> <th>L2</th> </tr> </thead> <tbody> <tr> <td colspan="14" style="text-align: center;">706</td> </tr> <tr> <td colspan="14" style="text-align: center;"><i>High Pressure Laminate Top w/ Exposed Plywood Edge / 4 Leg - Raised Polished Base</i></td> </tr> </tbody> </table>													COM	COL	1	2	3	4	5	6	7	8	9	10	L1	L2	706														<i>High Pressure Laminate Top w/ Exposed Plywood Edge / 4 Leg - Raised Polished Base</i>													
COM	COL	1	2	3	4	5	6	7	8	9	10	L1	L2																																											
706																																																								
<i>High Pressure Laminate Top w/ Exposed Plywood Edge / 4 Leg - Raised Polished Base</i>																																																								
<p><b>SQUARE END TABLE WITH WOOD BASE</b></p> 	<p><b>3242422-D-L</b></p>	<p><i>Overall: 24"w 24"d 22"h</i>  <i>Weight: 30 lbs.</i></p> <table border="1" data-bbox="576 1329 1534 1371"> <thead> <tr> <th>COM</th> <th>COL</th> <th>1</th> <th>2</th> <th>3</th> <th>4</th> <th>5</th> <th>6</th> <th>7</th> <th>8</th> <th>9</th> <th>10</th> <th>L1</th> <th>L2</th> </tr> </thead> <tbody> <tr> <td colspan="14" style="text-align: center;">674</td> </tr> <tr> <td colspan="14" style="text-align: center;"><i>High Pressure Laminate Top w/ Exposed Plywood Edge / 4 Leg - Wood Base</i></td> </tr> </tbody> </table>													COM	COL	1	2	3	4	5	6	7	8	9	10	L1	L2	674														<i>High Pressure Laminate Top w/ Exposed Plywood Edge / 4 Leg - Wood Base</i>													
COM	COL	1	2	3	4	5	6	7	8	9	10	L1	L2																																											
674																																																								
<i>High Pressure Laminate Top w/ Exposed Plywood Edge / 4 Leg - Wood Base</i>																																																								

**DESCRIPTION:**

- Upholstery Frames: Molded Foam Over Steel
- Seat: Molded Foam Over Plywood
- Back: Molded Foam Over Steel
- (4) Base Styles Available
- 10 Year Warranty

**OPTIONS:**

SE30D Self Edge Table Top - 30" Diameter .....\$33  
 Specify Exposed Wood Finish / Laminate (See Page 6)



COFFEE TABLES		ITEM #:	SPECIFICATIONS   GRADES   LIST PRICES:													
<p>ROUND COFFEE TABLE WITH FLAT POLISHED BASE</p> 	330D17-B-L	<p><b>Overall:</b> 30" Diameter 17"h  <b>Weight:</b> 30 lbs.</p>	COM	COL	1	2	3	4	5	6	7	8	9	10	L1	L2
		921 High Pressure Laminate Top w/ Exposed Plywood Edge / 4 Leg - Flat Polished Base														
<p>ROUND COFFEE TABLE WITH RAISED POLISHED BASE</p> 	330D17-C-L	<p><b>Overall:</b> 30" Diameter 17"h  <b>Weight:</b> 30 lbs.</p>	COM	COL	1	2	3	4	5	6	7	8	9	10	L1	L2
		898 High Pressure Laminate Top w/ Exposed Plywood Edge / 4 Leg - Raised Polished Base														
<p>ROUND COFFEE TABLE WITH WOOD BASE</p> 	330D17-D-L	<p><b>Overall:</b> 30" Diameter 17"h  <b>Weight:</b> 30 lbs.</p>	COM	COL	1	2	3	4	5	6	7	8	9	10	L1	L2
		828 High Pressure Laminate Top w/ Exposed Plywood Edge / 4 Leg - Wood Base														

**DESCRIPTION:**

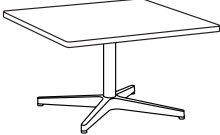

- Upholstery Frames: Molded Foam Over Steel
- Seat: Molded Foam Over Plywood
- Back: Molded Foam Over Steel
- (4) Base Styles Available
- 10 Year Warranty

**OPTIONS:**

SE30S Self Edge Table Top - 30" x 30" Square .....\$53  
 Specify Exposed Wood Finish / Laminate (See Page 6)

COFFEE TABLES		ITEM #:	SPECIFICATIONS   GRADES   LIST PRICES:													
<p>SQUARE COFFEE TABLE WITH FLAT POLISHED BASE</p> 	3303017-B-L	<p><b>Overall:</b> 30"w 30"d 17"h  <b>Weight:</b> 30 lbs.</p>	COM	COL	1	2	3	4	5	6	7	8	9	10	L1	L2
		898 High Pressure Laminate Top w/ Exposed Plywood Edge / 4 Leg - Flat Polished Base														
<p>SQUARE COFFEE TABLE WITH RAISED POLISHED BASE</p> 	3303017-C-L	<p><b>Overall:</b> 30"w 30"d 17"h  <b>Weight:</b> 30 lbs.</p>	COM	COL	1	2	3	4	5	6	7	8	9	10	L1	L2
		875 High Pressure Laminate Top w/ Exposed Plywood Edge / 4 Leg - Raised Polished Base														
<p>SQUARE COFFEE TABLE WITH WOOD BASE</p> 	3303017-D-L	<p><b>Overall:</b> 30"w 30"d 17"h  <b>Weight:</b> 30 lbs.</p>	COM	COL	1	2	3	4	5	6	7	8	9	10	L1	L2
		805 High Pressure Laminate Top w/ Exposed Plywood Edge / 4 Leg - Wood Base														



CONTRASTING COVERS	OPTION #:	SPECIFICATIONS   LIST PRICES   AVAILABILITY:												
<p>SELF EDGE TABLE TOP</p> 		<p><i>Overall: 24" Diameter x 1" h / 24"w x 24"d x 1" h / 30" Diameter x 1" h / 30"w x 30"d x 1" h</i></p> <hr/> <table border="0"> <tr> <td data-bbox="493 268 553 296">SE24D</td> <td data-bbox="581 268 1052 296">Self Edge Table Top - 24" Diameter</td> <td data-bbox="1068 268 1105 296">\$33</td> </tr> <tr> <td data-bbox="493 317 553 344">SE30D</td> <td data-bbox="581 317 1052 344">Self Edge Table Top - 30" Diameter</td> <td data-bbox="1068 317 1105 344">\$33</td> </tr> <tr> <td data-bbox="493 365 553 392">SE24S</td> <td data-bbox="581 365 1052 392">Self Edge Table Top - 24" x 24" Square</td> <td data-bbox="1068 365 1105 392">\$41</td> </tr> <tr> <td data-bbox="493 413 553 441">SE30S</td> <td data-bbox="581 413 1052 441">Self Edge Table Top - 30" x 30" Square</td> <td data-bbox="1068 413 1105 441">\$53</td> </tr> </table> <p><i>High Pressure Laminate Top w/ Self Edge</i></p> <p><b>Available: Vroom Tables</b></p>	SE24D	Self Edge Table Top - 24" Diameter	\$33	SE30D	Self Edge Table Top - 30" Diameter	\$33	SE24S	Self Edge Table Top - 24" x 24" Square	\$41	SE30S	Self Edge Table Top - 30" x 30" Square	\$53
SE24D	Self Edge Table Top - 24" Diameter	\$33												
SE30D	Self Edge Table Top - 30" Diameter	\$33												
SE24S	Self Edge Table Top - 24" x 24" Square	\$41												
SE30S	Self Edge Table Top - 30" x 30" Square	\$53												
<p>CONTRASTING COVERS</p> 		<p><i>Overall: n/a</i></p> <hr/> <p><b>CC</b> \$129</p> <p><i>NOTE: If Two Or More Upholsteries Or Leathers Are Used On Any Piece Of Furniture, Then A Contrast Charge Will Apply Per Order. When Using Trinity Upholstery, The Higher Priced Upholstery Grade Will Be Used In Pricing, Unless It's Trinity Leather With Fabric Contrast Welt, Or COM With Trinity Contrast Welt, Then Contact Customer Service For Pricing.</i></p> <p><b>Available: Vroom Collection</b></p>												

# Swerve

---

LOUNGE SEATING

Effective: August 1, 2022

T R I N I T Y

**Date:**

**Page:**

**Modification:**

**Description:**

---



**DESCRIPTION:**

- Upholstery Frames: Hardwood & Plywood
- Seat: High Density Foam Over Sheet Webbing
- Back: High Density Foam Over Plywood Frame
- 10 Year Warranty

**OPTIONS:**

Feather Down & Polyester Pillows Available (See Page 5)

**NOTE: Trinity Must Approve Fabric Selection Before Ordering.**

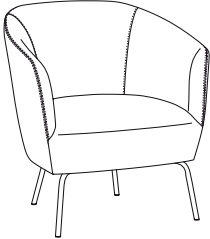
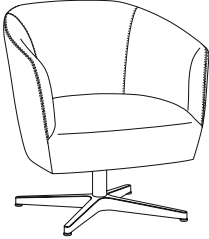
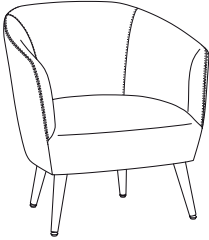
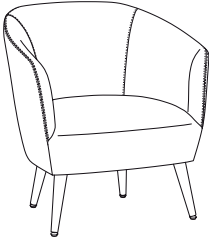
LOUNGE		ITEM #:	SPECIFICATIONS   GRADES   LIST PRICES:													
	LOUNGE CHAIR / FULLY UPHOLSTERED	343-A	<b>Overall:</b> 30.75"w 27"d 30.75"h		<b>Arm:</b> 25.5"h		<b>COM:</b> 3 yds.									
	<b>Seat:</b> 23"w 19.5"d 18"h		<b>Weight:</b> 60 lbs.		<b>COL:</b> 55 sq.ft.											
	<b>COM</b>		<b>COL</b>	<b>1</b>	<b>2</b>	<b>3</b>	<b>4</b>	<b>5</b>	<b>6</b>	<b>7</b>	<b>8</b>	<b>9</b>	<b>10</b>	<b>L1</b>	<b>L2</b>	
			1278	1406	1355	1429	1503	1577	1651	1725	1799	1873	1947	2022	2119	2385
<i>Tight Seat &amp; Back / 4 Leg - Black Steel Base</i>																
	LOUNGE CHAIR / FULLY UPHOLSTERED	343-B	<b>Overall:</b> 30.75"w 27"d 30.75"h		<b>Arm:</b> 25.5"h		<b>COM:</b> 3 yds.									
	<b>Seat:</b> 23"w 19.5"d 18"h		<b>Weight:</b> 60 lbs.		<b>COL:</b> 55 sq.ft.											
	<b>COM</b>		<b>COL</b>	<b>1</b>	<b>2</b>	<b>3</b>	<b>4</b>	<b>5</b>	<b>6</b>	<b>7</b>	<b>8</b>	<b>9</b>	<b>10</b>	<b>L1</b>	<b>L2</b>	
			1330	1463	1404	1478	1552	1626	1701	1775	1849	1923	1997	2071	2168	2435
<i>Tight Seat &amp; Back / 4 Leg - Flat Polished Base</i>																
	LOUNGE CHAIR / FULLY UPHOLSTERED	343-C	<b>Overall:</b> 30.75"w 27"d 30.75"h		<b>Arm:</b> 25.5"h		<b>COM:</b> 3 yds.									
	<b>Seat:</b> 23"w 19.5"d 18"h		<b>Weight:</b> 60 lbs.		<b>COL:</b> 55 sq.ft.											
	<b>COM</b>		<b>COL</b>	<b>1</b>	<b>2</b>	<b>3</b>	<b>4</b>	<b>5</b>	<b>6</b>	<b>7</b>	<b>8</b>	<b>9</b>	<b>10</b>	<b>L1</b>	<b>L2</b>	
			1461	1607	1528	1602	1676	1750	1824	1898	1972	2046	2120	2194	2292	2558
<i>Tight Seat &amp; Back / 4 Leg - Tapered Brushed Aluminum Metal Legs</i>																
	LOUNGE CHAIR / FULLY UPHOLSTERED	343-D	<b>Overall:</b> 30.75"w 27"d 30.75"h		<b>Arm:</b> 25.5"h		<b>COM:</b> 3 yds.									
	<b>Seat:</b> 23"w 19.5"d 18"h		<b>Weight:</b> 55 lbs.		<b>COL:</b> 55 sq.ft.											
	<b>COM</b>		<b>COL</b>	<b>1</b>	<b>2</b>	<b>3</b>	<b>4</b>	<b>5</b>	<b>6</b>	<b>7</b>	<b>8</b>	<b>9</b>	<b>10</b>	<b>L1</b>	<b>L2</b>	
			1173	1290	1256	1330	1404	1478	1552	1626	1701	1775	1849	1923	2020	2287
<i>Tight Seat &amp; Back / 4 Leg - Tapered Wooden Legs</i>																

CONTRASTING COVERS	OPTION #:	SPECIFICATIONS   LIST PRICES   AVAILABILITY:
<p>STORAGE CUBBY</p> 	<p><b>ST1</b></p>	<p><i>Overall: n/a</i></p> <hr/> <p>\$198  <i>Molded plastic bottom shelf for storage. (Available In Black or Gray)</i></p> <p><i>Available: Swerve Collection</i></p>
<p>CONTRASTING COVERS</p> 	<p><b>CC</b></p>	<p><i>Overall: n/a</i></p> <hr/> <p>\$129  <i>NOTE: If Two Or More Upholsteries Or Leathers Are Used On Any Piece Of Furniture, Then A Contrast Charge Will Apply Per Order. When Using Trinity Upholstery, The Higher Priced Upholstery Grade Will Be Used In Pricing, Unless It's Trinity Leather With Fabric Contrast Welt, Or COM With Trinity Contrast Welt, Then Contact Customer Service For Pricing.</i></p> <p><i>Available: Swerve Collection</i></p>

# Wingding

---

PRIVACY LOUNGE SEATING

Effective: August 1, 2022

T R I N I T Y

**Date:**

**Page:**

**Modification:**

**Description:**

---



**DESCRIPTION:**

- Upholstery Frames: Hardwood & Plywood
- Seat: High Density Foam Over Sheet Webbing
- Back: High Density Foam Over Plywood Frame
- Fixed Pillow Headrest
- 10 Year Warranty

**OPTIONS:**

- ST2 Storage Cubby (345-C / 345-D Models) .....\$198
  - USB-1 Dual Charging USB (2 Ports Available) .....\$185
  - CC Contrasting Covers .....\$129
- Note: Pillow Can Be A Contrasting Color From Privacy Chair*

Feather Down & Polyester Pillows Available (See Page 5)

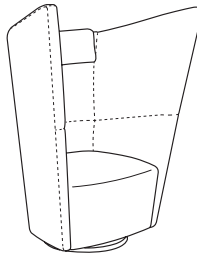
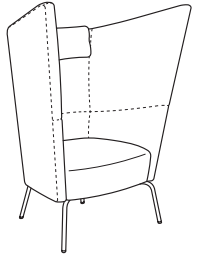
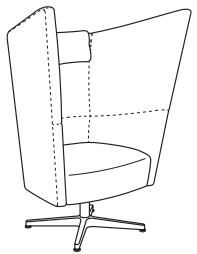
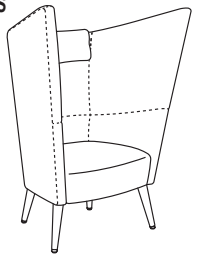
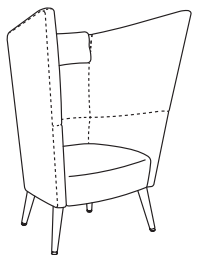
PRIVACY LOUNGE		ITEM #:	SPECIFICATIONS   GRADES   LIST PRICES:													
 <p><b>*NOTE*</b> Optional Storage Cubby Available</p>	<b>PRIVACY CHAIR W/ SWIVEL BASE</b>		<b>Overall:</b> 38.5"w 31"d 51.5"h <b>Seat:</b> 24.5"w 20"d 18.5"h				<b>Arm:</b> n/a <b>Weight:</b> 100 lbs.				<b>COM:</b> 6.25 yds. <b>COL:</b> 112.5 sq.ft.					
			<b>COM</b>	<b>COL</b>	<b>1</b>	<b>2</b>	<b>3</b>	<b>4</b>	<b>5</b>	<b>6</b>	<b>7</b>	<b>8</b>	<b>9</b>	<b>10</b>	<b>L1</b>	<b>L2</b>
	<b>345-C</b>		1710	1881	1960	2132	2304	2476	2648	2819	2991	3163	3335	3507	3726	4345
		360° Swivel Base / Tight Seat & Back														
	<b>345-D</b>		1722	1894	1971	2143	2315	2487	2659	2830	3002	3174	3346	3518	3737	4356
		Self-Return 180° Swivel Base / Tight Seat & Back														
	<b>PRIVACY LOUNGE CHAIR W/ BLACK STEEL BASE</b>		<b>Overall:</b> 38.5"w 31"d 51.5"h <b>Seat:</b> 24.5"w 20"d 18.5"h				<b>Arm:</b> n/a <b>Weight:</b> 85 lbs.				<b>COM:</b> 5.25 yds. <b>COL:</b> 94.5 sq.ft.					
			<b>COM</b>	<b>COL</b>	<b>1</b>	<b>2</b>	<b>3</b>	<b>4</b>	<b>5</b>	<b>6</b>	<b>7</b>	<b>8</b>	<b>9</b>	<b>10</b>	<b>L1</b>	<b>L2</b>
	<b>346-A</b>		1839	2022	2027	2171	2316	2460	2604	2749	2893	3037	3181	3326	3517	4037
		4 Leg - Black Steel Base / Tight Seat & Back														
	<b>PRIVACY LOUNGE CHAIR W/ FLAT POLISHED ALUMINUM BASE</b>		<b>Overall:</b> 38.5"w 31"d 51.5"h <b>Seat:</b> 24.5"w 20"d 18.5"h				<b>Arm:</b> n/a <b>Weight:</b> 85 lbs.				<b>COM:</b> 5.25 yds. <b>COL:</b> 94.5 sq.ft.					
			<b>COM</b>	<b>COL</b>	<b>1</b>	<b>2</b>	<b>3</b>	<b>4</b>	<b>5</b>	<b>6</b>	<b>7</b>	<b>8</b>	<b>9</b>	<b>10</b>	<b>L1</b>	<b>L2</b>
	<b>346-B</b>		1722	1895	1917	2061	2206	2350	2494	2639	2783	2927	3072	3216	3407	3927
		4 Leg - Flat Polished Base / Tight Seat & Back														
	<b>PRIVACY LOUNGE CHAIR W/ TAPERED BRUSHED ALUMINUM METAL LEGS</b>		<b>Overall:</b> 25.25"w 21.75"d 15"h <b>Seat:</b> n/a				<b>Arm:</b> n/a <b>Weight:</b> 85 lbs.				<b>COM:</b> 1.50 yds. <b>COL:</b> 27 sq.ft.					
			<b>COM</b>	<b>COL</b>	<b>1</b>	<b>2</b>	<b>3</b>	<b>4</b>	<b>5</b>	<b>6</b>	<b>7</b>	<b>8</b>	<b>9</b>	<b>10</b>	<b>L1</b>	<b>L2</b>
	<b>346-C</b>		1995	2195	2125	2245	2365	2485	2605	2725	2845	2965	3085	3205	3364	3796
		4 Leg - Tapered Brushed Aluminum Metal Legs / Tight Seat & Back														
	<b>PRIVACY LOUNGE CHAIR W/ TAPERED WOODEN LEGS</b>		<b>Overall:</b> 25.25"w 21.75"d 15"h <b>Seat:</b> n/a				<b>Arm:</b> n/a <b>Weight:</b> 85 lbs.				<b>COM:</b> 1.50 yds. <b>COL:</b> 27 sq.ft.					
			<b>COM</b>	<b>COL</b>	<b>1</b>	<b>2</b>	<b>3</b>	<b>4</b>	<b>5</b>	<b>6</b>	<b>7</b>	<b>8</b>	<b>9</b>	<b>10</b>	<b>L1</b>	<b>L2</b>
	<b>346-D</b>		1551	1707	1708	1830	1953	2075	2197	2320	2442	2564	2686	2809	2971	3411
		4 Leg - Tapered Wooden Legs / Tight Seat & Back														

**DESCRIPTION:**

- Upholstery Frames: Hardwood & Plywood
- Seat: High Density Foam Over Sheet Webbing
- Back: High Density Foam Over Plywood Frame
- Fixed Pillow Headrest
- 10 Year Warranty

**OPTIONS:**

CC Contrasting Covers.....\$129

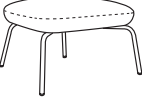
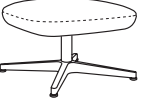
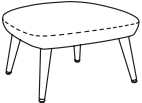
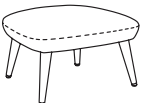
OTTOMANS		ITEM #:	SPECIFICATIONS   GRADES   LIST PRICES:														
	344-A	<b>Overall:</b> 25.25"w 21.75"d 15"h <b>Seat:</b> n/a	<b>Arm:</b> n/a <b>Weight:</b> 30 lbs.	<b>COM:</b> 1.50 yds. <b>COL:</b> 27 sq.ft.													
		COM	COL	1	2	3	4	5	6	7	8	9	10	L1	L2		
		520	572	559	593	627	660	694	728	761	795	829	862	899	1020		
4 Leg - Black Steel Base																	
	344-B	<b>Overall:</b> 25.25"w 21.75"d 15"h <b>Seat:</b> n/a	<b>Arm:</b> n/a <b>Weight:</b> 30 lbs.	<b>COM:</b> 1.50 yds. <b>COL:</b> 27 sq.ft.													
		COM	COL	1	2	3	4	5	6	7	8	9	10	L1	L2		
		506	557	546	579	613	647	680	714	748	781	815	849	885	1007		
4 Leg - Flat Polished Base																	
	344-C	<b>Overall:</b> 25.25"w 21.75"d 15"h <b>Seat:</b> n/a	<b>Arm:</b> n/a <b>Weight:</b> 30 lbs.	<b>COM:</b> 1.50 yds. <b>COL:</b> 27 sq.ft.													
		COM	COL	1	2	3	4	5	6	7	8	9	10	L1	L2		
		884	972	903	938	972	1006	1041	1075	1109	1143	1178	1212	1249	1373		
4 Leg - Tapered Brushed Aluminum Metal Legs																	
	344-D	<b>Overall:</b> 25.25"w 21.75"d 15"h <b>Seat:</b> n/a	<b>Arm:</b> n/a <b>Weight:</b> 30 lbs.	<b>COM:</b> 1.50 yds. <b>COL:</b> 27 sq.ft.													
		COM	COL	1	2	3	4	5	6	7	8	9	10	L1	L2		
		403	443	450	485	520	555	590	625	660	694	729	764	802	928		
4 Leg - Tapered Wooden Legs																	

CONTRASTING COVERS	OPTION #:	SPECIFICATIONS   LIST PRICES   AVAILABILITY:
<p>DUAL CHARGING USB</p> 	<p>USB-1</p>	<p><b>Overall:</b> 2"w 2"d .1875"h</p> <hr/> <p><b>\$185 (Per Arm)</b>  <i>Spill-Proof Technology / 2 Amps Per Port / Multiple Finish Options / Storm Color Standard (Specify Left or Right Facing)</i></p> <p><b>Available:</b> <i>Wingding Collection</i></p>
<p>STORAGE CUBBY</p> 	<p>ST2</p>	<p><b>Overall:</b> 22"w x 17.5"d x 11.5"h</p> <hr/> <p><b>\$198</b>  <i>Molded plastic bottom shelf for storage. (Available In Black or Gray)</i></p> <p><b>Available:</b> <i>Wingding Collection (345-C / 345-D Models Only)</i></p>
<p>CONTRASTING COVERS</p> 	<p>CC</p>	<p><b>Overall:</b> n/a</p> <hr/> <p><b>\$129</b>  <i>NOTE: If Two Or More Upholsteries Or Leathers Are Used On Any Piece Of Furniture, Then A Contrast Charge Will Apply Per Order. When Using Trinity Upholstery, The Higher Priced Upholstery Grade Will Be Used In Pricing, Unless It's Trinity Leather With Fabric Contrast Welt, Or COM With Trinity Contrast Welt, Then Contact Customer Service For Pricing.</i></p> <p><i>*Pillow Can Be A Contrasting Color From Privacy Chair</i></p> <p><b>Available:</b> <i>Wingding Collection</i></p>

Crest

---

PRIVACY LOUNGE & OTTOMANS

Effective: August 1, 2022

T R I N I T Y

**Date:**

**Page:**

**Modification:**

**Description:**

---

**DESCRIPTION:**

- Upholstery Frames: Hardwood & Plywood
- Seat: High Density Foam Over Sheet Webbing
- Back: High Density Foam Over Plywood Frame
- Fixed Pillow Headrest
- 10 Year Warranty

**OPTIONS:**

- USB-1 Dual Charging USB (2 Ports Available) .....\$185
- CC Contrasting Covers .....\$129
- Note: Pillow Can Be A Contrasting Color From Privacy Chair*

Feather Down & Polyester Pillows Available (See Page 5)

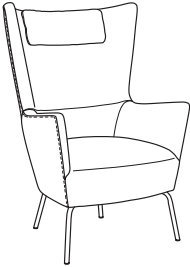
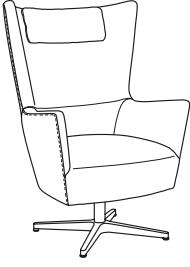
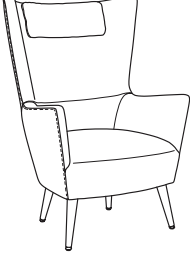
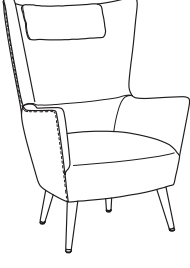



PRIVACY LOUNGE	ITEM #:	SPECIFICATIONS   GRADES   LIST PRICES:													
<b>PRIVACY LOUNGE CHAIR WITH BLACK STEEL BASE</b>  	347-A	<b>Overall:</b> 31.5"w 31"d 45.5"h		<b>Arm:</b> 26.75"h		<b>COM:</b> 4.5 yds.									
		<b>Seat:</b> 24.5"w 20"d 18.5"h		<b>Weight:</b> 75 lbs.		<b>COL:</b> 81 sq.ft.									
		<b>COM</b>	<b>COL</b>	<b>1</b>	<b>2</b>	<b>3</b>	<b>4</b>	<b>5</b>	<b>6</b>	<b>7</b>	<b>8</b>	<b>9</b>	<b>10</b>	<b>L1</b>	<b>L2</b>
		1582	1740	1696	1797	1898	1999	2100	2201	2302	2403	2504	2605	2860	3238
<i>4 Leg - Black Steel Base / Tight Seat &amp; Back</i>															
<b>PRIVACY LOUNGE CHAIR WITH FLAT POLISHED ALUMINUM BASE</b>  	347-B	<b>Overall:</b> 31.5"w 31"d 45.5"h		<b>Arm:</b> 26.75"h		<b>COM:</b> 4.5 yds.									
		<b>Seat:</b> 24.5"w 20"d 18.5"h		<b>Weight:</b> 75 lbs.		<b>COL:</b> 81 sq.ft.									
		<b>COM</b>	<b>COL</b>	<b>1</b>	<b>2</b>	<b>3</b>	<b>4</b>	<b>5</b>	<b>6</b>	<b>7</b>	<b>8</b>	<b>9</b>	<b>10</b>	<b>L1</b>	<b>L2</b>
		1617	1779	1729	1830	1931	2032	2133	2235	2336	2437	2538	2639	2895	3273
<i>4 Leg - Flat Polished Base / Tight Seat &amp; Back</i>															
<b>PRIVACY LOUNGE CHAIR WITH TAPERED BRUSHED ALUMINUM METAL LEGS</b>  	347-C	<b>Overall:</b> 31.5"w 31"d 45.5"h		<b>Arm:</b> 26.75"h		<b>COM:</b> 4.5 yds.									
		<b>Seat:</b> 24.5"w 20"d 18.5"h		<b>Weight:</b> 75 lbs.		<b>COL:</b> 81 sq.ft.									
		<b>COM</b>	<b>COL</b>	<b>1</b>	<b>2</b>	<b>3</b>	<b>4</b>	<b>5</b>	<b>6</b>	<b>7</b>	<b>8</b>	<b>9</b>	<b>10</b>	<b>L1</b>	<b>L2</b>
		2025	2227	2114	2216	2317	2418	2519	2620	2721	2822	2923	3024	3173	3537
<i>4 Leg - Tapered Brushed Aluminum Metal Legs / Tight Seat &amp; Back</i>															
<b>PRIVACY LOUNGE CHAIR WITH TAPERED WOODEN LEGS</b>  	347-D	<b>Overall:</b> 31.5"w 31"d 45.5"h		<b>Arm:</b> 26.75"h		<b>COM:</b> 4.5 yds.									
		<b>Seat:</b> 24.5"w 20"d 18.5"h		<b>Weight:</b> 75 lbs.		<b>COL:</b> 81 sq.ft.									
		<b>COM</b>	<b>COL</b>	<b>1</b>	<b>2</b>	<b>3</b>	<b>4</b>	<b>5</b>	<b>6</b>	<b>7</b>	<b>8</b>	<b>9</b>	<b>10</b>	<b>L1</b>	<b>L2</b>
		1515	1667	1638	1743	1848	1953	2058	2162	2267	2372	2477	2582	2842	3235
<i>4 Leg - Tapered Wooden Legs / Tight Seat &amp; Back</i>															



**DESCRIPTION:**

- Upholstery Frames: Hardwood & Plywood
- Seat: High Density Foam Over Sheet Webbing
- 10 Year Warranty

**OPTIONS:**

CC Contrasting Covers.....\$129  
 Feather Down & Polyester Pillows Available (See Page 5)

OTTOMANS		ITEM #:	SPECIFICATIONS   GRADES   LIST PRICES:													
	OTTOMAN WITH BLACK STEEL BASE	344-A	Overall: 25.25"w 21.75"d 15"h			Arm: n/a			COM: 1.50 yds.							
			Seat: n/a			Weight: 30 lbs.			COL: 27 sq.ft.							
			COM	COL	1	2	3	4	5	6	7	8	9	10	L1	L2
			520	572	559	593	627	660	694	728	761	795	829	862	899	1020
			4 Leg - Black Steel Base													
	OTTOMAN WITH FLAT POLISHED ALUMINUM BASE	344-B	Overall: 25.25"w 21.75"d 15"h			Arm: n/a			COM: 1.50 yds.							
			Seat: n/a			Weight: 30 lbs.			COL: 27 sq.ft.							
			COM	COL	1	2	3	4	5	6	7	8	9	10	L1	L2
			506	557	546	579	613	647	680	714	748	781	815	849	885	1007
			4 Leg - Flat Polished Base													
	OTTOMAN WITH TAPERED BRUSHED ALUMINUM METAL LEGS	344-C	Overall: 25.25"w 21.75"d 15"h			Arm: n/a			COM: 1.50 yds.							
			Seat: n/a			Weight: 30 lbs.			COL: 27 sq.ft.							
			COM	COL	1	2	3	4	5	6	7	8	9	10	L1	L2
			884	972	903	938	972	1006	1041	1075	1109	1143	1178	1212	1249	1373
			4 Leg - Tapered Brushed Aluminum Metal Legs													
	OTTOMAN WITH TAPERED WOODEN LEGS	344-D	Overall: 25.25"w 21.75"d 15"h			Arm: n/a			COM: 1.50 yds.							
			Seat: n/a			Weight: 30 lbs.			COL: 27 sq.ft.							
			COM	COL	1	2	3	4	5	6	7	8	9	10	L1	L2
			403	443	450	485	520	555	590	625	660	694	729	764	802	928
			4 Leg - Tapered Wooden Legs													

CONTRASTING COVERS	OPTION #:	SPECIFICATIONS   LIST PRICES   AVAILABILITY:
<p>DUAL CHARGING USB</p> 	<p>USB-1</p>	<p><b>Overall:</b> 2"w 2"d .1875"h</p> <hr/> <p><b>\$185 (Per Arm)</b>  <i>Spill-Proof Technology / 2 Amps Per Port / Multiple Finish Options / Storm Color Standard (Specify Left or Right Facing)</i></p> <p><b>Available:</b> Crest Collection</p>
<p>CONTRASTING COVERS</p> 	<p>CC</p>	<p><b>Overall:</b> n/a</p> <hr/> <p><b>\$129</b>  <i>NOTE: If Two Or More Upholsteries Or Leathers Are Used On Any Piece Of Furniture, Then A Contrast Charge Will Apply Per Order. When Using Trinity Upholstery, The Higher Priced Upholstery Grade Will Be Used In Pricing, Unless It's Trinity Leather With Fabric Contrast Welt, Or COM With Trinity Contrast Welt, Then Contact Customer Service For Pricing.</i></p> <p><i>*Pillow Can Be A Contrasting Color From Privacy Chair</i></p> <p><b>Available:</b> Crest Collection</p>



# Steel

---

GUEST SEATING

Effective: August 1, 2022

T R I N I T Y

**Date:**

**Page:**

**Modification:**

**Description:**

---

**DESCRIPTION:**

- Seat: High Density Polyurethane Foam Over Strap Webbing
- Back: High Density Polyurethane Foam Over Hardwood Frame
- Wallsaver Legs
- Brushed Stainless Steel Frame
- Top Stitching Standard
- 10 Year Warranty

**OPTIONS:**

- SPAC-1 Polyester Arm Caps For Rounded Arm Units ..... \$135 Pair
- Upholstered Arm Panels Available (See Next Page)
- Removable Velcro Seat Covers Over Antimicrobial Moisture Barrier:
  - Item #: 350/352/360/362 ..... \$77 List
  - Item #: 351/353/361/363 ..... \$83 List
  - Item #: 355/365 ..... \$103 List
- Contact Factory For Additional Powder Coat Frame Colors (Minimum Quantity 5)

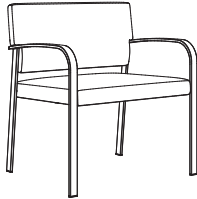
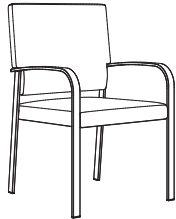
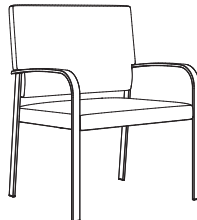
GUEST	ITEM #:	SPECIFICATIONS   GRADES   LIST PRICES:													
<b>SIDE CHAIR / ROUNDED ARM</b>  	350-B	<b>Overall:</b> 24"w 24"d 33"h		<b>Arm:</b> 26"h		<b>COM:</b> 1.5 yds.									
		<b>Seat:</b> 21"w 19"d 19"h		<b>Weight:</b> 27 lbs.		<b>COL:</b> 27 sq.ft.									
		<b>COM</b>	<b>COL</b>	<b>1</b>	<b>2</b>	<b>3</b>	<b>4</b>	<b>5</b>	<b>6</b>	<b>7</b>	<b>8</b>	<b>9</b>	<b>10</b>	<b>L1</b>	<b>L2</b>
		1438	1582	1441	1481	1522	1562	1603	1643	1684	1724	1765	1805	1873	2019
<i>Brushed Stainless Steel Frame / Tight Seat &amp; Back</i>															
<b>BARIATRIC SIDE CHAIR / ROUNDED ARM</b>  	351-B	<b>Overall:</b> 30"w 24"d 33"h		<b>Arm:</b> 26"h		<b>COM:</b> 2 yds.									
		<b>Seat:</b> 27"w 19"d 19"h		<b>Weight:</b> 37 lbs.		<b>COL:</b> 36 sq.ft.									
		<b>COM</b>	<b>COL</b>	<b>1</b>	<b>2</b>	<b>3</b>	<b>4</b>	<b>5</b>	<b>6</b>	<b>7</b>	<b>8</b>	<b>9</b>	<b>10</b>	<b>L1</b>	<b>L2</b>
		1642	1806	1647	1694	1741	1789	1836	1883	1930	1977	2025	2072	2155	2325
<i>Brushed Stainless Steel Frame / Tight Seat &amp; Back / 500 lbs. Weight Rating</i>															
<b>HIGH BACK SIDE CHAIR / ROUNDED ARM</b>  	352-B	<b>Overall:</b> 24"w 24"d 38"h		<b>Arm:</b> 26"h		<b>COM:</b> 1.75 yds.									
		<b>Seat:</b> 21"w 19"d 19"h		<b>Weight:</b> 32 lbs.		<b>COL:</b> 32 sq.ft.									
		<b>COM</b>	<b>COL</b>	<b>1</b>	<b>2</b>	<b>3</b>	<b>4</b>	<b>5</b>	<b>6</b>	<b>7</b>	<b>8</b>	<b>9</b>	<b>10</b>	<b>L1</b>	<b>L2</b>
		1507	1658	1506	1546	1587	1627	1668	1708	1749	1789	1830	1870	1939	2085
<i>Brushed Stainless Steel Frame / Tight Seat &amp; Back</i>															
<b>HIGH BACK BARIATRIC SIDE CHAIR / ROUNDED ARM</b>  	353-B	<b>Overall:</b> 30"w 24"d 38"h		<b>Arm:</b> 26"h		<b>COM:</b> 2 yds.									
		<b>Seat:</b> 21"w 19"d 19"h		<b>Weight:</b> 42 lbs.		<b>COL:</b> 36 sq.ft.									
		<b>COM</b>	<b>COL</b>	<b>1</b>	<b>2</b>	<b>3</b>	<b>4</b>	<b>5</b>	<b>6</b>	<b>7</b>	<b>8</b>	<b>9</b>	<b>10</b>	<b>L1</b>	<b>L2</b>
		1668	1835	1671	1718	1766	1813	1860	1907	1955	2002	2049	2096	2180	2350
<i>Brushed Stainless Steel Frame / Tight Seat &amp; Back / 500 lbs. Weight Rating</i>															

**DESCRIPTION:**

- Seat: High Density Polyurethane Foam Over Strap Webbing
- Back: High Density Polyurethane Foam Over Hardwood Frame
- Wallsaver Legs
- Brushed Stainless Steel Frame
- Top Stitching Standard
- 10 Year Warranty

**OPTIONS:**

- SPAC-1 Polyester Arm Caps For Rounded Arm Units ..... \$135 Pair
- Upholstered Arm Panels Available (See This Page)
- Removable Velcro Seat Covers Over Antimicrobial Moisture Barrier:
  - Item #: 350/352/360/362 ..... \$77 List
  - Item #: 351/353/361/363 ..... \$83 List
  - Item #: 355/365 ..... \$103 List
- Contact Factory For Additional Powder Coat Frame Colors (Minimum Quantity 5)

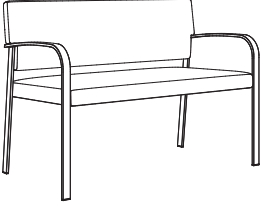
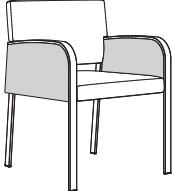
GUEST	ITEM #:	SPECIFICATIONS   GRADES   LIST PRICES:													
<b>TWO PLACE SOFA / ROUNDED ARM</b>  	355-B	<b>Overall:</b> 46.5"w 24"d 33"h		<b>Arm:</b> 26"h		<b>COM:</b> 3.25 yds.									
		<b>Seat:</b> 21"/42"w 19"d 19"h		<b>Weight:</b> 45 lbs.		<b>COL:</b> 59 sq.ft.									
		<b>COM</b>	<b>COL</b>	<b>1</b>	<b>2</b>	<b>3</b>	<b>4</b>	<b>5</b>	<b>6</b>	<b>7</b>	<b>8</b>	<b>9</b>	<b>10</b>	<b>L1</b>	<b>L2</b>
		2114	2325	2160	2241	2322	2403	2484	2565	2646	2727	2808	2889	3019	3310
<i>Brushed Stainless Steel Frame / Tight Seat &amp; Back</i>															
<b>UPHOLSTERED ARM PANELS</b>  	350-AP	<b>Overall:</b> 1.5"w 21.25"d 10"h		<b>Arm:</b> n/a		<b>COM:</b> TBD yds.									
		<b>Seat:</b> n/a		<b>Weight:</b> 6 lbs.		<b>COL:</b> TBD sq.ft.									
		<b>COM</b>	<b>COL</b>	<b>1</b>	<b>2</b>	<b>3</b>	<b>4</b>	<b>5</b>	<b>6</b>	<b>7</b>	<b>8</b>	<b>9</b>	<b>10</b>	<b>L1</b>	<b>L2</b>
		141	148	195	222	249	275	302	330	357	383	410	437	462	559
<i>(2) Upholstered Arm Panels</i>															

**FINISH**



Brushed  
Stainless

**DESCRIPTION:**

- Seat: High Density Polyurethane Foam Over Strap Webbing
- Back: High Density Polyurethane Foam Over Hardwood Frame
- Wallsaver Legs
- Powder Coated Steel Frame (Luster Grey Standard)
- Brushed Stainless Steel Frame
- Top Stitching Standard
- 10 Year Warranty

**OPTIONS:**

- SPAC-2 Polyester Arm Caps For 90° Square Arm Units ..... \$185 Pair
- WCA White Solid Surface Arm Caps ..... \$270 Pair
- SGS Soft Ganging Straps ..... \$24 Per Seat
- Upholstered Arm Panels Available (See 360-AP This Page)
- Removable Velcro Seat Covers Over Antimicrobial Moisture Barrier:
  - Item #: 350/352/360/362 ..... \$77 List
  - Item #: 351/353/361/363 ..... \$83 List
  - Item #: 355/365 ..... \$103 List
- Contact Factory For Additional Powder Coat Frame Colors (Minimum Quantity 5)

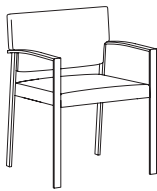
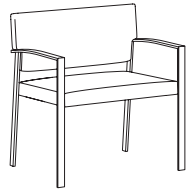
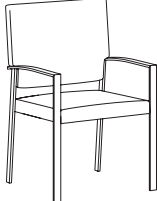
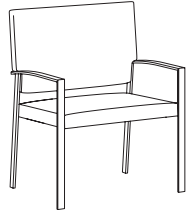
GUEST	ITEM #:	SPECIFICATIONS   GRADES   LIST PRICES:													
		<b>Overall:</b> 24"w 24"d 33"h	<b>Arm:</b> 26"h	<b>COM:</b> 1.5 yds.											
		<b>Seat:</b> 21"w 19"d 19"h	<b>Weight:</b> 27 lbs.	<b>COL:</b> 27 sq.ft.											
		<b>COM</b>	<b>COL</b>	<b>1</b>	<b>2</b>	<b>3</b>	<b>4</b>	<b>5</b>	<b>6</b>	<b>7</b>	<b>8</b>	<b>9</b>	<b>10</b>	<b>L1</b>	<b>L2</b>
	<b>360-PC</b>	1199	1319	1214	1255	1295	1336	1376	1417	1457	1498	1538	1578	1553	1691
		<i>Powder Coated Steel Frame / Tight Seat &amp; Back</i>													
	<b>360-B</b>	1433	1576	1435	1476	1516	1557	1597	1638	1678	1719	1759	1800	1762	1899
		<i>Brushed Stainless Steel Frame / Tight Seat &amp; Back</i>													
		<b>Overall:</b> 30"w 24"d 33"h	<b>Arm:</b> 26"h	<b>COM:</b> 2 yds.											
		<b>Seat:</b> 27"w 19"d 19"h	<b>Weight:</b> 37 lbs.	<b>COL:</b> 36 sq.ft.											
		<b>COM</b>	<b>COL</b>	<b>1</b>	<b>2</b>	<b>3</b>	<b>4</b>	<b>5</b>	<b>6</b>	<b>7</b>	<b>8</b>	<b>9</b>	<b>10</b>	<b>L1</b>	<b>L2</b>
	<b>361-PC</b>	1408	1549	1426	1473	1520	1567	1615	1662	1709	1756	1803	1851	1824	1985
		<i>Powder Coated Steel Frame / Tight Seat &amp; Back / 500 lbs. Weight Rating</i>													
	<b>361-B</b>	1636	1800	1641	1689	1736	1783	1830	1878	1925	1972	2019	2066	2028	2188
		<i>Brushed Stainless Steel Frame / Tight Seat &amp; Back / 500 lbs. Weight Rating</i>													
		<b>Overall:</b> 24"w 24"d 38"h	<b>Arm:</b> 26"h	<b>COM:</b> 1.75 yds.											
		<b>Seat:</b> 21"w 19"d 19"h	<b>Weight:</b> 32 lbs.	<b>COL:</b> 32 sq.ft.											
		<b>COM</b>	<b>COL</b>	<b>1</b>	<b>2</b>	<b>3</b>	<b>4</b>	<b>5</b>	<b>6</b>	<b>7</b>	<b>8</b>	<b>9</b>	<b>10</b>	<b>L1</b>	<b>L2</b>
	<b>362-PC</b>	1279	1407	1290	1331	1371	1411	1452	1492	1533	1573	1614	1654	1626	1763
		<i>Powder Coated Steel Frame / Tight Seat &amp; Back</i>													
	<b>362-B</b>	1507	1658	1506	1546	1587	1627	1668	1708	1749	1789	1830	1870	1830	1967
		<i>Brushed Stainless Steel Frame / Tight Seat &amp; Back</i>													
		<b>Overall:</b> 30"w 24"d 38"h	<b>Arm:</b> 26"h	<b>COM:</b> 2 yds.											
		<b>Seat:</b> 21"w 19"d 19"h	<b>Weight:</b> 42 lbs.	<b>COL:</b> 36 sq.ft.											
		<b>COM</b>	<b>COL</b>	<b>1</b>	<b>2</b>	<b>3</b>	<b>4</b>	<b>5</b>	<b>6</b>	<b>7</b>	<b>8</b>	<b>9</b>	<b>10</b>	<b>L1</b>	<b>L2</b>
	<b>363-PC</b>	1440	1583	1455	1503	1550	1597	1644	1691	1739	1786	1833	1880	1853	2013
		<i>Powder Coated Steel Frame / Tight Seat &amp; Back / 500 lbs. Weight Rating</i>													
	<b>363-B</b>	1668	1835	1671	1718	1766	1813	1860	1907	1955	2002	2049	2096	2057	2217
		<i>Brushed Stainless Steel Frame / Tight Seat &amp; Back / 500 lbs. Weight Rating</i>													

**DESCRIPTION:**

- Seat: High Density Polyurethane Foam Over Strap Webbing
- Back: High Density Polyurethane Foam Over Hardwood Frame
- Wallsaver Legs
- Powder Coated Steel Frame (Luster Grey Standard)
- Brushed Stainless Steel Frame
- Top Stitching Standard
- 10 Year Warranty

**OPTIONS:**

- SPAC-2 Polyester Arm Caps For 90° Square Arm Units ..... \$185 Pair
- WCA White Solid Surface Arm Caps ..... \$270 Pair
- SGS Soft Ganging Straps ..... \$24 Per Seat
- Upholstered Arm Panels Available (See 360-AP This Page)
- Removable Velcro Seat Covers Over Antimicrobial Moisture Barrier:
  - Item #: 350/352/360/362 ..... \$77 List
  - Item #: 351/353/361/363 ..... \$83 List
  - Item #: 355/365 ..... \$103 List
- Contact Factory For Additional Powder Coat Frame Colors (Minimum Quantity 5)

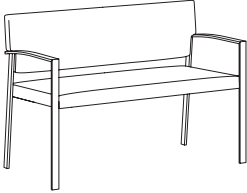
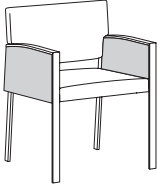
GUEST	ITEM #:	SPECIFICATIONS   GRADES   LIST PRICES:													
	<b>TWO PLACE SOFA / SQUARE ARM</b>  <b>365-PC</b>  <b>365-B</b>	<i>Overall: 46.5"w 24"d 33"h</i>			<i>Arm: 26"h</i>			<i>COM: 3.25 yds.</i>							
		<i>Seat: 21"/42"w 19"d 19"h</i>			<i>Weight: 45 lbs.</i>			<i>COL: 59 sq.ft.</i>							
		COM	COL	1	2	3	4	5	6	7	8	9	10	L1	L2
		1885	2074	1944	2025	2106	2187	2268	2349	2430	2511	2592	2673	2644	2919
		<i>Powder Coated Steel Frame / Tight Seat &amp; Back</i>													
		2114	2325	2160	2241	2322	2403	2484	2565	2646	2727	2808	2889	2848	3123
		<i>Brushed Stainless Steel Frame / Tight Seat &amp; Back</i>													
	<b>UPHOLSTERED ARM PANELS</b>  <b>360-AP</b>	<i>Overall: 1.5"w 21.25"d 10"h</i>			<i>Arm: n/a</i>			<i>COM: TBD yds.</i>							
		<i>Seat: n/a</i>			<i>Weight: 6 lbs.</i>			<i>COL: TBD sq.ft.</i>							
		COM	COL	1	2	3	4	5	6	7	8	9	10	L1	L2
		141	148	195	222	249	275	302	330	357	383	410	437	462	559
		<i>(2) Upholstered Arm Panels</i>													

**FINISHES**



Brushed  
Stainless

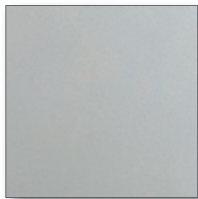

Powder Coated  
Luster Grey

ARM CAPS / STRAPS / COVERS	OPTION #:	SPECIFICATIONS   LIST PRICES   AVAILABILITY:
<b>POLYESTER ARM CAPS</b>		
	<b>SPAC-1</b>	<p><b>Overall:</b> 1.5"w 19.25"d .25"h</p> <hr/> <p>Polyester Arm Caps For Rounded Arm Units - \$135 (Set Of 2) <i>(Specify Finish)</i></p> <p><b>Available:</b> Steel Rounded Arm Chairs: 350, 351, 352, 353, 355</p>
	<b>SPAC-2</b>	<p>Polyester Arm Caps For 90° Square Arm Units - \$185 (Set Of 2) <i>(Specify Finish)</i></p> <p><b>Available:</b> Steel 90° Square Arm Chairs: 360, 361, 362, 363, 365</p>
<b>WHITE SOLID SURFACE ARM CAPS</b>		
	<b>WCA</b>	<p><b>Overall:</b> 1.375"w 14"d .4375"h</p> <hr/> <p>\$270 (Set Of 2) <i>(Available Only In White)</i></p> <p><b>Available:</b> Steel 90° Square Arm Chairs: 360, 361, 362, 363, 365</p>
<b>GANGING STRAPS</b>		
	<b>SGS</b>	<p><b>Overall:</b> 4"w 2"d</p> <hr/> <p>\$24 Per Seat <i>Black Velcro Soft Ganging Straps</i></p> <p><b>Available:</b> Steel Chairs</p>
<b>REMOVABLE COVERS</b>		
	<p>350/352/360/362</p> <p>351/353/361/363</p> <p>355/365</p>	<p><b>Overall:</b> n/a</p> <hr/> <p>\$77</p> <p>\$83</p> <p>\$103 <i>Removable Velcro Seat Covers Over Antimicrobial Moisture Barrier.</i></p> <p><b>Available:</b> Steel Chairs</p>

CONTRASTING COVERS	OPTION #:	SPECIFICATIONS   LIST PRICES   AVAILABILITY:
<p data-bbox="87 178 293 205">CONTRASTING COVERS</p> 	<p data-bbox="570 178 678 205"><i>Overall: n/a</i></p> <hr/> <p data-bbox="521 268 553 296"><b>CC</b></p> <p data-bbox="570 268 630 296"><b>\$129</b></p> <p data-bbox="570 296 1479 369"><i>NOTE: If Two Or More Upholsteries Or Leathers Are Used On Any Piece Of Furniture, Then A Contrast Charge Will Apply Per Order. When Using Trinity Upholstery, The Higher Priced Upholstery Grade Will Be Used In Pricing, Unless It's Trinity Leather With Fabric Contrast Welt, Or COM With Trinity Contrast Welt, Then Contact Customer Service For Pricing.</i></p> <p data-bbox="570 415 756 443"><b>Available: Steel Chairs</b></p>	



# Edge

---

LOUNGE / GUEST

Effective: August 1, 2022

T R I N I T Y

**Date:**

**Page:**

**Modification:**

**Description:**

---

**DESCRIPTION:**

- Upholstery Frames: Hardwood & Plywood
- Seat: High Density Polyurethane Foam Over Sheet Webbing
- Back: High Density Polyurethane Foam Over Hardwood Frame
- Exposed Wood Frame: Solid Maple
- Lumbar Support
- 10 Year Warranty

**OPTIONS:**

- Feather Down & Polyester Pillows Available (See Page 5)
- Specify Exposed Wood Finish (See Page 6)

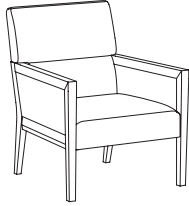
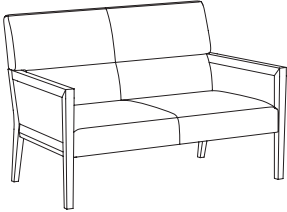
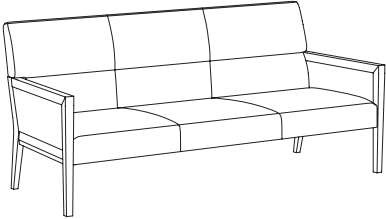
LOUNGE		ITEM #:	SPECIFICATIONS   GRADES   LIST PRICES:												
	371-P	<b>Overall:</b> 27"w 30.25"d 34.5"h <b>Seat:</b> 23.5"w 21"d 17.5"h	<b>Arm:</b> 23"h <b>Weight:</b> 35 lbs.	<b>COM:</b> 3.25 yds. <b>COL:</b> 59 sq.ft.											
		COM	COL	1	2	3	4	5	6	7	8	9	10	L1	L2
		1485	1634	1569	1652	1734	1817	1899	1982	2064	2147	2229	2311	2433	2729
Tight Seat & Back															
	372-P	<b>Overall:</b> 51"w 30.25"d 34.5"h <b>Seat:</b> 47.5"w 21"d 17.5"h	<b>Arm:</b> 23"h <b>Weight:</b> 65 lbs.	<b>COM:</b> 5.25 yds. <b>COL:</b> 95 sq.ft.											
		COM	COL	1	2	3	4	5	6	7	8	9	10	L1	L2
		2063	2269	2225	2363	2500	2637	2775	2912	3050	3187	3325	3462	3661	4156
Tight Seat & Back															
	373-P	<b>Overall:</b> 76.5"w 30.25"d 34.5"h <b>Seat:</b> 73"w 21"d 17.5"h	<b>Arm:</b> 23"h <b>Weight:</b> 95 lbs.	<b>COM:</b> 7.25 yds. <b>COL:</b> 131 sq.ft.											
		COM	COL	1	2	3	4	5	6	7	8	9	10	L1	L2
		2565	2821	2810	3002	3195	3387	3579	3772	3964	4157	4349	4541	2676	2714
Tight Seat & Back															

**DESCRIPTION:**

- Upholstery Frames: Hardwood & Plywood
- Seat: High Density Polyurethane Foam Over Sheet Webbing
- Back: High Density Polyurethane Foam Over Hardwood Frame
- Exposed Wood Frame: Solid Maple
- Lumbar Support
- 10 Year Warranty

**OPTIONS:**

- Feather Down & Polyester Pillows Available (See Page 5)
- Specify Exposed Wood Finish (See Page 6)

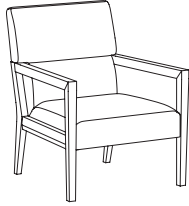
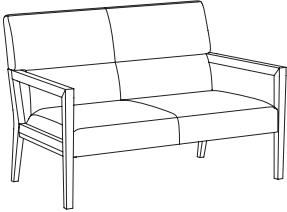
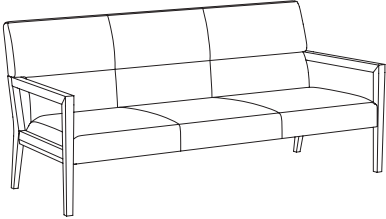
LOUNGE		ITEM #:	SPECIFICATIONS   GRADES   LIST PRICES:													
	LOUNGE CHAIR / OPEN ARM	374-P	Overall: 27"w 30.25"d 34.5"h			Arm: 23"h			COM: 2.5 yds.							
	Seat: 23.5"w 21"d 17.5"h			Weight: 33 lbs.			COL: 45 sq.ft.									
	COM		COL	1	2	3	4	5	6	7	8	9	10	L1	L2	
			1359	1495	1409	1471	1532	1594	1656	1718	1780	1842	1904	1965	2065	2287
			<i>Tight Seat &amp; Back</i>													
	TWO PLACE SOFA / OPEN ARM	375-P	Overall: 51"w 30.25"d 34.5"h			Arm: 23"h			COM: 4.5 yds.							
	Seat: 47.5"w 21"d 17.5"h			Weight: 63 lbs.			COL: 81 sq.ft.									
	COM		COL	1	2	3	4	5	6	7	8	9	10	L1	L2	
			1940	2134	2068	2185	2302	2418	2535	2652	2769	2886	3003	3119	3297	3717
			<i>Tight Seat &amp; Back</i>													
	THREE PLACE SOFA / OPEN ARM	376-P	Overall: 76.5"w 30.25"d 34.5"h			Arm: 23"h			COM: 6.5 yds.							
	Seat: 73"w 21"d 17.5"h			Weight: 93 lbs.			COL: 117 sq.ft.									
	COM		COL	1	2	3	4	5	6	7	8	9	10	L1	L2	
			2439	2682	2649	2821	2993	3165	3336	3508	3680	3852	4024	4195	5688	5860
			<i>Tight Seat &amp; Back</i>													

**DESCRIPTION:**

- Upholstery Frames: Hardwood & Plywood
- Seat: High Density Polyurethane Foam Over Sheet Webbing
- Back: High Density Polyurethane Foam Over Hardwood Frame
- Exposed Wood Frame: Solid Maple
- Wallsaver Legs
- 10 Year Warranty

**OPTIONS:**

Specify Exposed Wood Finish (See Page 6)

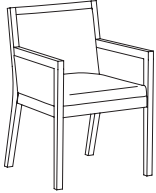
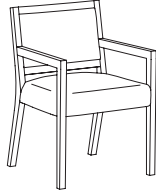
GUEST	ITEM #:	SPECIFICATIONS   GRADES   LIST PRICES:													
<b>SIDE CHAIR / CLOSED ARM / CLOSED BACK</b>  		<b>Overall:</b> 22"w 24"d 33"h			<b>Arm:</b> 25"h			<b>COM:</b> 2 yds. (380) / 2 yds. (381)							
		<b>Seat:</b> 19.5"w 17.75"d 18.75"h			<b>Weight:</b> 26 lbs.			<b>COL:</b> 36 sq.ft. (380) / 36 sq.ft. (381)							
		<b>COM</b>	<b>COL</b>	<b>1</b>	<b>2</b>	<b>3</b>	<b>4</b>	<b>5</b>	<b>6</b>	<b>7</b>	<b>8</b>	<b>9</b>	<b>10</b>	<b>L1</b>	<b>L2</b>
	<b>380</b>	1022	1124	1062	1110	1159	1207	1255	1303	1351	1399	1447	1495	1550	1723
		<i>Upholstered Back / Tight Seat &amp; Back</i>													
	<b>381</b>	1058	1163	1096	1144	1192	1241	1289	1337	1385	1433	1481	1529	1582	1755
		<i>Wood Back / Tight Seat &amp; Back</i>													
<b>SIDE CHAIR / OPEN ARM / OPEN BACK</b>  		<b>Overall:</b> 22"w 24"d 33"h			<b>Arm:</b> 25"h			<b>COM:</b> 1.5 yds. (384) / 1.25 yds. (385)							
		<b>Seat:</b> 19.5"w 17.75"d 18.75"h			<b>Weight:</b> 17 lbs.			<b>COL:</b> 27 sq.ft. (384) / 23 sq.ft. (385)							
		<b>COM</b>	<b>COL</b>	<b>1</b>	<b>2</b>	<b>3</b>	<b>4</b>	<b>5</b>	<b>6</b>	<b>7</b>	<b>8</b>	<b>9</b>	<b>10</b>	<b>L1</b>	<b>L2</b>
	<b>384</b>	939	1033	970	1012	1053	1094	1135	1177	1218	1259	1300	1341	1392	1541
		<i>Upholstered Back / Tight Seat &amp; Back</i>													
	<b>385</b>	962	1058	973	992	1019	1047	1074	1102	1129	1157	1184	1212	1249	1348
		<i>Wood Back / Tight Seat &amp; Back</i>													

**DESCRIPTION:**





- Exposed Frames: Solid Maple, Self Edge, Vertical Direction
- Veneer Top: Maple
- 10 Year Warranty

**OPTIONS:**

Specify Exposed Wood Finish / Laminate (See Page 6)

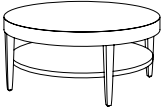

Square Edge Profile Standard

TABLES	ITEM #:	SPECIFICATIONS   GRADES   LIST PRICES:													
<p><b>ROUND OCCASIONAL TABLE</b></p> 		<p><b>Overall:</b> 22" Diameter 23"h  <b>Weight:</b> 45 lbs.</p>													
		COM	COL	1	2	3	4	5	6	7	8	9	10	L1	L2
	<b>322D23-V</b>	1336	Veneer Face / Self Edge												
	<b>322D23-C</b>	1455	Solid Surface Face / Self Edge												
	<b>322D23-G</b>	2717	Etched Tempered Glass / Eased Edge												
<p><b>SQUARE OCCASIONAL TABLE</b></p> 		<p><b>Overall:</b> 24"w 24"d 23"h  <b>Weight:</b> 47 lbs.</p>													
		COM	COL	1	2	3	4	5	6	7	8	9	10	L1	L2
	<b>3242423-V</b>	1199	Veneer Face / Self Edge												
	<b>3242423-C</b>	1688	Solid Surface Face / Self Edge												
	<b>3242423-G</b>	3043	Etched Tempered Glass / Eased Edge												
<p><b>ROUND COFFEE TABLE</b></p> 		<p><b>Overall:</b> 36" Diameter 16"h  <b>Weight:</b> 65 lbs.</p>													
		COM	COL	1	2	3	4	5	6	7	8	9	10	L1	L2
	<b>336D16-V</b>	2190	Veneer Face / Self Edge												
	<b>336D16-C</b>	2674	Solid Surface Face / Self Edge												
	<b>336D16-G</b>	6349	Etched Tempered Glass / Eased Edge												
<p><b>SQUARE OCCASIONAL TABLE</b></p> 		<p><b>Overall:</b> 24"w 24"d 16"h  <b>Weight:</b> 40 lbs.</p>													
		COM	COL	1	2	3	4	5	6	7	8	9	10	L1	L2
	<b>3242416-V</b>	1158	Veneer Face / Self Edge												
	<b>3242416-C</b>	1659	Solid Surface Face / Self Edge												
	<b>3242416-G</b>	3020	Etched Tempered Glass / Eased Edge												

COVERS	OPTION #:	SPECIFICATIONS   LIST PRICES   AVAILABILITY:
<p>CONTRASTING COVERS</p> 	<p><i>Overall: n/a</i></p> <hr/> <p><b>CC</b> \$129  <i>NOTE: If Two Or More Upholsteries Or Leathers Are Used On Any Piece Of Furniture, Then A Contrast Charge Will Apply Per Order. When Using Trinity Upholstery, The Higher Priced Upholstery Grade Will Be Used In Pricing, Unless It's Trinity Leather With Fabric Contrast Welt, Or COM With Trinity Contrast Welt, Then Contact Customer Service For Pricing.</i></p> <p><i>Available: Edge Collection</i></p>	

# Traditional

---

EXECUTIVE / GUEST / LOUNGE / TABLES

Effective: August 1, 2022

T R I N I T Y



**Date:**

**Page:**

**Modification:**

**Description:**

---

**DESCRIPTION:**

- Upholstery Frames: Hardwood & Plywood
- Seat: High Density Polyurethane Foam Over Eight-Way Hand Tied Coil Springs
- Back: High Density Polyurethane Foam Over Sinuous Wire Springs
- Upholstered Arms: Polyurethane Foam Over Hardwood
- Exposed Arms: Solid Cherry, Lacquer Finished
- Classic Base Standard
- 10 Year Warranty

**OPTIONS:**

Specify Exposed Wood Finish (See Page 6)  
 Base & Caster Options Available (See Traditional Options Pages)  
 Brass or Pewter Nail Head Trim (See Traditional Options Pages)

**Note: Trinity Must Approve Specific Fabrics / Leathers Used For Tufting.**

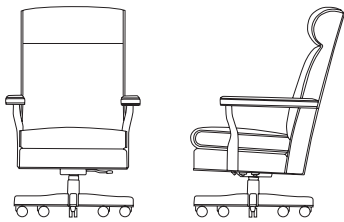
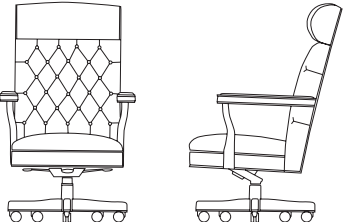
JUDGES / CHAMBERLAIN	ITEM #:	SPECIFICATIONS   GRADES   LIST PRICES:													
<p><b>HIGH BACK JUDGES CHAIR / OPEN WOOD UPHOLSTERED ARM / LOOSE CUSHION</b></p> 		<p><b>Overall:</b> 28.25"w 33"d 48"-52"h  <b>Seat:</b> 24.75"w 20"d 21"-24"h</p>		<p><b>Arm:</b> 30"-33"h  <b>Weight:</b> 85 lbs.</p>		<p><b>COM:</b> 3.75 yds. (400-2) / 3.75 yds. (400-3)  <b>COL:</b> 67.5 sq.ft. (400-2) / 67.5 sq.ft. (400-3)</p>									
	<b>400-2</b>	<b>COM</b>	<b>COL</b>	<b>1</b>	<b>2</b>	<b>3</b>	<b>4</b>	<b>5</b>	<b>6</b>	<b>7</b>	<b>8</b>	<b>9</b>	<b>10</b>	<b>L1</b>	<b>L2</b>
		1719	1891	1925	2028	2131	2234	2337	2440	2544	2647	2750	2853	2829	3386
	<i>Tilt Swivel w/ Lock / Pneumatic Seat Height Adjustment</i>														
<b>400-3</b>	1796	1975	2002	2105	2208	2311	2414	2517	2621	2724	2827	2930	3091	3463	
	<i>Tilt Swivel Infinite Lock / Pneumatic Seat Height Adjustment</i>														
<p><b>HIGH BACK JUDGES CHAIR / OPEN WOOD UPHOLSTERED ARM / TUFTED BACK / TIGHT CUSHION</b></p> 		<p><b>Overall:</b> 28.25"w 33"d 48"-52"h  <b>Seat:</b> 24.75"w 20"d 21"-24"h</p>		<p><b>Arm:</b> 30"-33"h  <b>Weight:</b> 85 lbs.</p>		<p><b>COM:</b> 3.75 yds. (401-2) / 3.75 yds. (401-4)  <b>COL:</b> 67.5 sq.ft. (401-2) / 67.5 sq.ft. (401-4)</p>									
	<b>401-2</b>	<b>COM</b>	<b>COL</b>	<b>1</b>	<b>2</b>	<b>3</b>	<b>4</b>	<b>5</b>	<b>6</b>	<b>7</b>	<b>8</b>	<b>9</b>	<b>10</b>	<b>L1</b>	<b>L2</b>
		1912	2103	2118	2221	2324	2428	2531	2634	2737	2840	2943	3046	3225	3596
	<i>Tilt Swivel w/ Lock / Pneumatic Seat Height Adjustment</i>														
<b>401-4</b>	1967	2164	2173	2276	2379	2483	2586	2689	2792	2895	2998	3101	3280	3651	
	<i>Knee Tilt Swivel Infinite Lock / Pneumatic Seat Height Adjustment</i>														

**DESCRIPTION:**

- Upholstery Frames: Hardwood & Plywood
- Seat: High Density Polyurethane Foam Over Eight-Way Hand Tied Coil Springs
- Back: High Density Polyurethane Foam Over Sinuous Wire Springs
- Upholstered Arms: Polyurethane Foam Over Hardwood
- Exposed Arms: Solid Cherry, Lacquer Finished
- Classic Base Standard
- 10 Year Warranty

**OPTIONS:**

Specify Exposed Wood Finish (See Page 6)  
 Base & Caster Options Available (See Traditional Options Pages)  
 Brass or Pewter Nail Head Trim (See Traditional Options Pages)

**Note: Trinity Must Approve Specific Fabrics / Leathers Used For Tufting.**

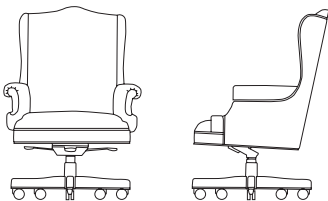
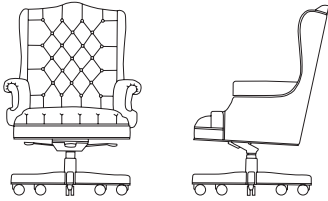
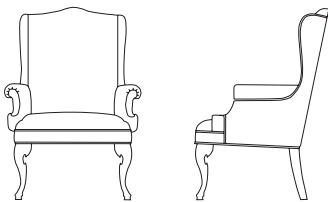
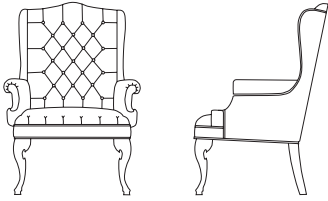
BARRISTER		ITEM #:	SPECIFICATIONS   GRADES   LIST PRICES:													
			<b>Overall:</b> 31"w 32"d 44"-47"h <b>Seat:</b> 21"w 19.5"d 19"-22"h			<b>Arm:</b> 28"-31"h <b>Weight:</b> 80 lbs.			<b>COM:</b> 5 yds. <b>COL:</b> 90 sq.ft.							
			<b>COM</b>	<b>COL</b>	<b>1</b>	<b>2</b>	<b>3</b>	<b>4</b>	<b>5</b>	<b>6</b>	<b>7</b>	<b>8</b>	<b>9</b>	<b>10</b>	<b>L1</b>	<b>L2</b>
		<b>410-2</b>	1625	1788	1886	2017	2148	2278	2409	2539	2670	2800	2931	3062	3246	3716
			<i>Tilt Swivel w/ Lock / Pneumatic Seat Height Adjustment</i>													
		<b>410-4</b>	1680	1848	1941	2072	2203	2333	2464	2594	2725	2855	2986	3117	3301	3771
			<i>Knee Tilt Swivel w/ Infinite Lock / Pneumatic Seat Height Adjustment</i>													
			<b>Overall:</b> 31"w 32"d 44"-47"h <b>Seat:</b> 21"w 19.5"d 19"-22"h			<b>Arm:</b> 28"-31"h <b>Weight:</b> 80 lbs.			<b>COM:</b> 5.25 yds. <b>COL:</b> 94.5 sq.ft.							
			<b>COM</b>	<b>COL</b>	<b>1</b>	<b>2</b>	<b>3</b>	<b>4</b>	<b>5</b>	<b>6</b>	<b>7</b>	<b>8</b>	<b>9</b>	<b>10</b>	<b>L1</b>	<b>L2</b>
		<b>411-2</b>	2031	2234	2319	2464	2608	2752	2897	3041	3185	3329	3474	3618	3870	4389
			<i>Tilt Swivel w/ Lock / Pneumatic Seat Height Adjustment</i>													
		<b>411-4</b>	2130	2343	2418	2563	2707	2851	2995	3140	3284	3428	3573	3717	3969	4488
			<i>Knee Tilt Swivel w/ Infinite Lock / Pneumatic Seat Height Adjustment</i>													
			<b>Overall:</b> 31"w 32"d 44"h <b>Seat:</b> 21"w 19.5"d 20"h			<b>Arm:</b> 28"h <b>Weight:</b> 62 lbs.			<b>COM:</b> 5 yds. (415-P) / 5.25 yds. (415-T) <b>COL:</b> 90 sq.ft. (415-P) / 94.5 sq.ft. (415-T)							
			<b>COM</b>	<b>COL</b>	<b>1</b>	<b>2</b>	<b>3</b>	<b>4</b>	<b>5</b>	<b>6</b>	<b>7</b>	<b>8</b>	<b>9</b>	<b>10</b>	<b>L1</b>	<b>L2</b>
		<b>415-P</b>	1528	1681	1790	1920	2051	2181	2312	2442	2573	2704	2834	2965	3149	3619
			<i>Tight Seat &amp; Back</i>													
		<b>415-T</b>	1866	2052	2154	2299	2443	2587	2732	2876	3020	3164	3309	3453	3705	4224
			<i>Fully Tufted Seat &amp; Back</i>													
			<b>Overall:</b> 31"w 32"d 44"h <b>Seat:</b> 21"w 19.5"d 20"h			<b>Arm:</b> 28"h <b>Weight:</b> 62 lbs.			<b>COM:</b> 5 yds. (415-P) / 5.25 yds. (415-T) <b>COL:</b> 90 sq.ft. (415-P) / 94.5 sq.ft. (415-T)							
			<b>COM</b>	<b>COL</b>	<b>1</b>	<b>2</b>	<b>3</b>	<b>4</b>	<b>5</b>	<b>6</b>	<b>7</b>	<b>8</b>	<b>9</b>	<b>10</b>	<b>L1</b>	<b>L2</b>
		<b>415-T</b>	1866	2052	2154	2299	2443	2587	2732	2876	3020	3164	3309	3453	3705	4224
			<i>Fully Tufted Seat &amp; Back</i>													

**DESCRIPTION:**

- Upholstery Frames: Hardwood & Plywood
- Seat: High Density Polyurethane Foam Over Eight-Way Hand Tied Coil Springs
- Back: High Density Polyurethane Foam Over Polypropylene Webbing
- Upholstered Arms: Polyurethane Foam Over Hardwood
- Exposed Arms: Solid Cherry, Lacquer Finished
- Classic Base Standard
- 10 Year Warranty

**OPTIONS:**

Specify Exposed Wood Finish (See Page 6)  
 Base & Caster Options Available (See Traditional Options Pages)  
 Brass or Pewter Nail Head Trim (See Traditional Options Pages)

**Note: Trinity Must Approve Specific Fabrics / Leathers Used For Tufting.**

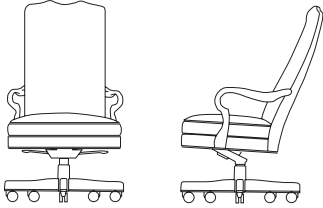
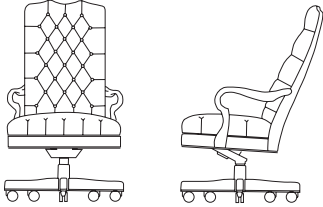
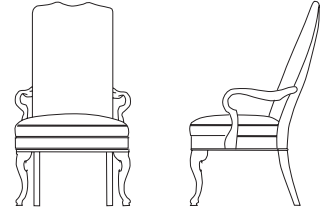
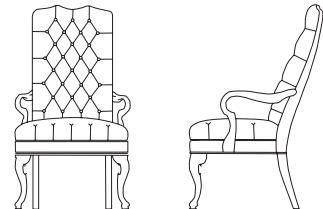
THURSTON	ITEM #:	SPECIFICATIONS   GRADES   LIST PRICES:															
<p><b>MEDIUM BACK CHAIR / EXPOSED WOOD OPEN ARM</b></p> 		<b>Overall:</b> 25"w 29"d 43"-46"h <b>Seat:</b> 20"w 19"d 20"-23"h			<b>Arm:</b> 26"-29"h <b>Weight:</b> 70 lbs.			<b>COM:</b> 2.75 yds. <b>COL:</b> 49.5 sq.ft.									
		<b>COM</b>	<b>COL</b>	<b>1</b>	<b>2</b>	<b>3</b>	<b>4</b>	<b>5</b>	<b>6</b>	<b>7</b>	<b>8</b>	<b>9</b>	<b>10</b>	<b>L1</b>	<b>L2</b>		
	<b>420-2</b>	1651	1816	1709	1781	1853	1924	1996	2068	2139	2211	2283	2354	2465	2723		
		<i>Tilt Swivel w/ Lock / Pneumatic Seat Height Adjustment</i>															
	<b>420-4</b>	1706	1877	1761	1833	1905	1976	2048	2120	2192	2263	2335	2407	2517	2775		
		<i>Knee Tilt Swivel w/ Infinite Lock / Pneumatic Seat Height Adjustment</i>															
<p><b>MEDIUM BACK CHAIR / OPEN ARM / TUFTED SEAT &amp; BACK</b></p> 		<b>Overall:</b> 25"w 29"d 43"-46"h <b>Seat:</b> 20"w 19"d 20"-23"h			<b>Arm:</b> 26"-29"h <b>Weight:</b> 70 lbs.			<b>COM:</b> 3 yds. <b>COL:</b> 54 sq.ft.									
		<b>COM</b>	<b>COL</b>	<b>1</b>	<b>2</b>	<b>3</b>	<b>4</b>	<b>5</b>	<b>6</b>	<b>7</b>	<b>8</b>	<b>9</b>	<b>10</b>	<b>L1</b>	<b>L2</b>		
	<b>421-2</b>	1932	2050	2015	2090	2166	2241	2317	2393	2468	2544	2619	2695	2843	3115		
		<i>Tilt Swivel w/ Lock / Pneumatic Seat Height Adjustment</i>															
	<b>421-4</b>	1984	2104	2064	2140	2215	2291	2367	2442	2518	2593	2669	2744	2893	3165		
		<i>Knee Tilt Swivel w/ Infinite Lock / Pneumatic Seat Height Adjustment</i>															
<p><b>ARM CHAIR / EXPOSED WOOD OPEN ARM / CABRIOLE LEG</b></p>  <p>425-P</p>  <p>425-T</p>		<b>Overall:</b> 25"w 29"d 43"h <b>Seat:</b> 20"w 19"d 20"h			<b>Arm:</b> 26.5"h <b>Weight:</b> 45 lbs.			<b>COM:</b> 2.75 yds. (425-P) / 3 yds. (425-T) <b>COL:</b> 49.5 sq.ft. (425-P) / 54 sq.ft. (425-T)									
		<b>COM</b>	<b>COL</b>	<b>1</b>	<b>2</b>	<b>3</b>	<b>4</b>	<b>5</b>	<b>6</b>	<b>7</b>	<b>8</b>	<b>9</b>	<b>10</b>	<b>L1</b>	<b>L2</b>		
	<b>425-P</b>	1633	1732	1726	1801	1877	1952	2028	2103	2179	2255	2330	2406	2523	2795		
		<i>Tight Seat &amp; Back</i>															
	<b>425-T</b>	1864	1977	1949	2024	2100	2175	2251	2327	2402	2478	2553	2629	2777	3049		
		<i>Fully Tufted Seat &amp; Back</i>															

**DESCRIPTION:**

- Upholstery Frames: Hardwood & Plywood
- Seat: High Density Polyurethane Foam Over Eight-Way Hand Tied Coil Springs
- Back: High Density Polyurethane Foam Over Polypropylene Webbing
- Upholstered Arms: Polyurethane Foam Over Hardwood
- Exposed Arms: Solid Cherry, Lacquer Finished
- Classic Base Standard
- 10 Year Warranty

**OPTIONS:**

- CCM Concentric Arm Medalion (430 Model)..... N/C
- Specify Exposed Wood Finish (See Page 6)  
 Base & Caster Options Available (See Traditional Options Pages)  
 Brass or Pewter Nail Head Trim (See Traditional Options Pages)

**Note: Trinity Must Approve Specific Fabrics / Leathers Used For Tufting.**

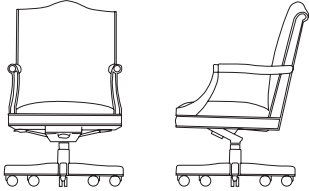
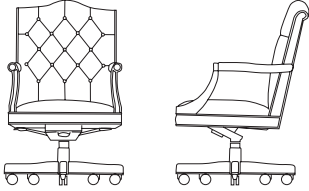
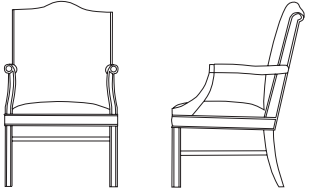
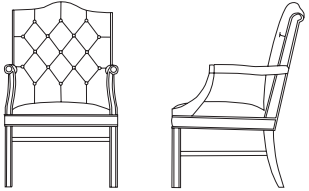
WASHINGTON	ITEM #:	SPECIFICATIONS   GRADES   LIST PRICES:													
<p><b>MEDIUM BACK CHAIR / OPEN WOOD UPHOLSTERED ARM</b></p> 		<p><b>Overall:</b> 24"w 29"d 40"-43"h  <b>Seat:</b> 20"w 19"d 19"-22"h</p>		<p><b>Arm:</b> 27"-30"h  <b>Weight:</b> 60 lbs.</p>				<p><b>COM:</b> 2.75 yds.  <b>COL:</b> 49.5 sq.ft.</p>							
		<b>COM</b>	<b>COL</b>	<b>1</b>	<b>2</b>	<b>3</b>	<b>4</b>	<b>5</b>	<b>6</b>	<b>7</b>	<b>8</b>	<b>9</b>	<b>10</b>	<b>L1</b>	<b>L2</b>
	<b>430-2</b>	1650	1814	1814	1897	1979	2062	2144	2227	2309	2392	2474	2557	2676	2972
		<i>Tilt Swivel w/ Lock / Pneumatic Seat Height Adjustment</i>													
	<b>430-4</b>	1699	1869	1864	1946	2029	2111	2194	2276	2359	2441	2524	2606	2725	3022
		<i>Knee Tilt Swivel w/ Infinite Lock / Pneumatic Seat Height Adjustment</i>													
<p><b>MEDIUM BACK CHAIR / OPEN WOOD UPHOLSTERED ARM / TUFTED BACK</b></p> 		<p><b>Overall:</b> 24"w 29"d 40"-43"h  <b>Seat:</b> 20"w 19"d 19"-22"h</p>		<p><b>Arm:</b> 27"-30"h  <b>Weight:</b> 60 lbs.</p>				<p><b>COM:</b> 3 yds.  <b>COL:</b> 54 sq.ft.</p>							
		<b>COM</b>	<b>COL</b>	<b>1</b>	<b>2</b>	<b>3</b>	<b>4</b>	<b>5</b>	<b>6</b>	<b>7</b>	<b>8</b>	<b>9</b>	<b>10</b>	<b>L1</b>	<b>L2</b>
	<b>431-2</b>	1929	2122	2080	2156	2231	2307	2382	2458	2534	2609	2685	2760	2904	3176
		<i>Tilt Swivel w/ Lock / Pneumatic Seat Height Adjustment</i>													
	<b>431-4</b>	1978	2176	2129	2205	2281	2356	2432	2507	2583	2659	2734	2810	2953	3226
		<i>Knee Tilt Swivel w/ Infinite Lock / Pneumatic Seat Height Adjustment</i>													
<p><b>ARM CHAIR / EXPOSED WOOD OPEN UPHOLSTERED ARM</b></p>  <p>435-P</p>  <p>435-T</p>		<p><b>Overall:</b> 24"w 29"d 40"h  <b>Seat:</b> 20"w 19"d 19"h</p>		<p><b>Arm:</b> 27"h  <b>Weight:</b> 45 lbs.</p>				<p><b>COM:</b> 2.75 yds. (435-P) / 3 yds. (435-T)  <b>COL:</b> 49.5 sq.ft. (435-P) / 54 sq.ft. (435-T)</p>							
		<b>COM</b>	<b>COL</b>	<b>1</b>	<b>2</b>	<b>3</b>	<b>4</b>	<b>5</b>	<b>6</b>	<b>7</b>	<b>8</b>	<b>9</b>	<b>10</b>	<b>L1</b>	<b>L2</b>
	<b>435-P</b>	1534	1687	1699	1781	1864	1946	2029	2111	2194	2276	2359	2441	2560	2857
		<i>Tight Seat &amp; Back</i>													
	<b>435-T</b>	1758	1934	1923	2006	2088	2171	2253	2336	2418	2501	2583	2666	2814	3111
		<i>Tight Seat / Tufted Back</i>													

**DESCRIPTION:**

- Upholstery Frames: Hardwood & Plywood
- Seat: High Density Polyurethane Foam Over Eight-Way Hand Tied Coil Springs
- Back: High Density Polyurethane Foam Over Polypropylene Webbing
- Upholstered Arms: Polyurethane Foam Over Hardwood
- Exposed Arms: Solid Cherry, Lacquer Finished
- Classic Base Standard (Executive Chairs)
- 10 Year Warranty

**OPTIONS:**

Specify Exposed Wood Finish (See Page 6)  
 Base & Caster Options Available (See Traditional Options Pages)  
 Brass or Pewter Nail Head Trim (See Traditional Options Pages)

**Note: Trinity Must Approve Specific Fabrics / Leathers Used For Tufting.**

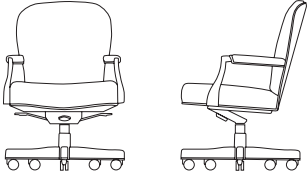
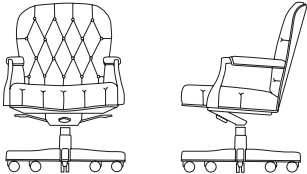
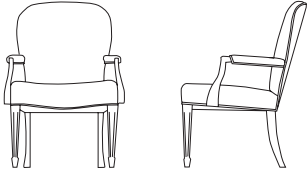
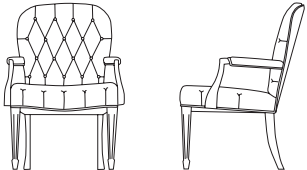
GEORGETOWN		ITEM #:	SPECIFICATIONS   GRADES   LIST PRICES:													
<b>LOW BACK CHAIR / OPEN WOOD UPHOLSTERED ARM / FULLY UPHOLSTERED</b>			<b>Overall:</b> 25"w 26"d 36"-39"h			<b>Arm:</b> 25"-28"h			<b>COM:</b> 2.25 yds.							
			<b>Seat:</b> 21.5"w 18"d 18"-21"h			<b>Weight:</b> 55 lbs.			<b>COL:</b> 40.5 sq.ft.							
			<b>COM</b>	<b>COL</b>	<b>1</b>	<b>2</b>	<b>3</b>	<b>4</b>	<b>5</b>	<b>6</b>	<b>7</b>	<b>8</b>	<b>9</b>	<b>10</b>	<b>L1</b>	<b>L2</b>
		<b>440-2</b>	1383	1521	1493	1548	1603	1658	1713	1768	1823	1878	1933	1988	2077	2275
			<i>Tilt Swivel w/ Lock / Pneumatic Seat Height Adjustment</i>													
		<b>440-4</b>	1438	1582	1548	1603	1658	1713	1768	1823	1878	1933	1988	2043	2132	2330
			<i>Knee Tilt Swivel w/ Infinite Lock / Pneumatic Seat Height Adjustment</i>													
<b>LOW BACK CHAIR / OPEN WOOD UPHOLSTERED ARM / TUFTED SEAT &amp; BACK</b>			<b>Overall:</b> 25"w 26"d 36"-39"h			<b>Arm:</b> 25"-28"h			<b>COM:</b> 2.25 yds.							
			<b>Seat:</b> 21.5"w 18"d 18"-21"h			<b>Weight:</b> 55 lbs.			<b>COL:</b> 40.5 sq.ft.							
			<b>COM</b>	<b>COL</b>	<b>1</b>	<b>2</b>	<b>3</b>	<b>4</b>	<b>5</b>	<b>6</b>	<b>7</b>	<b>8</b>	<b>9</b>	<b>10</b>	<b>L1</b>	<b>L2</b>
		<b>441-2</b>	1588	1746	1753	1835	1918	2000	2082	2165	2247	2330	2412	2495	2638	2935
			<i>Tilt Swivel w/ Lock / Pneumatic Seat Height Adjustment</i>													
		<b>441-4</b>	1637	1801	1802	1885	1967	2049	2132	2214	2297	2379	2462	2544	2687	2984
			<i>Knee Tilt Swivel w/ Infinite Lock / Pneumatic Seat Height Adjustment</i>													
<b>ARM CHAIR / OPEN WOOD UPHOLSTERED ARM</b>			<b>Overall:</b> 25"w 26"d 36"h			<b>Arm:</b> 26"h			<b>COM:</b> 2.25 yds. (445-P) / 2.5 yds. (445-T)							
			<b>Seat:</b> 21.5"w 18"d 20"h			<b>Weight:</b> 45 lbs.			<b>COL:</b> 40.5 sq.ft. (445-P) / 45 sq.ft. (445-T)							
			<b>COM</b>	<b>COL</b>	<b>1</b>	<b>2</b>	<b>3</b>	<b>4</b>	<b>5</b>	<b>6</b>	<b>7</b>	<b>8</b>	<b>9</b>	<b>10</b>	<b>L1</b>	<b>L2</b>
		<b>445-P</b>	1289	1418	1440	1516	1591	1667	1743	1818	1894	1969	2045	2120	2226	2498
			<i>Tight Seat &amp; Back</i>													
		<b>445-T</b>	1492	1641	1657	1739	1821	1904	1986	2069	2151	2234	2316	2399	2542	2838
			<i>Fully Tufted Seat &amp; Back</i>													
																
		<b>445-T</b>														

**DESCRIPTION:**

- Upholstery Frames: Hardwood & Plywood
- Seat: High Density Polyurethane Foam Over Eight-Way Hand Tied Coil Springs
- Back: High Density Polyurethane Foam Over Polypropylene Webbing (Item #: 448 - Strap Webbing)
- Upholstered Arms: Polyurethane Foam Over Hardwood
- Exposed Arms / Legs: Solid Maple, Lacquer Finished (#446, #447, #448)
- Classic Base Standard
- 10 Year Warranty

**OPTIONS:**

- Specify Exposed Wood Finish (See Page 6)
- Base & Caster Options Available (See Traditional Options Pages)
- Brass or Pewter Nail Head Trim (See Traditional Options Pages)

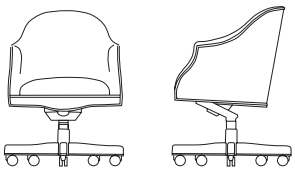
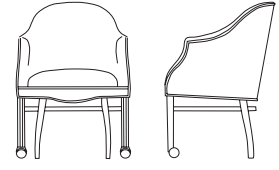
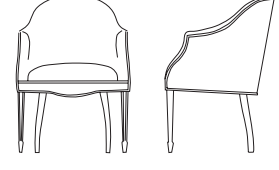
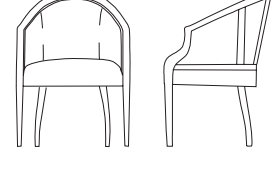
FAIRFORD / BARREL CHAIR		ITEM #:	SPECIFICATIONS   GRADES   LIST PRICES:													
		<b>LOW BACK CHAIR / FULLY UPHOLSTERED</b>  <b>442-2</b>  <b>442-4</b>	<b>Overall:</b> 24.5"w 26"d 32.5"-36"h <b>Seat:</b> 20"w 18"d 18.5"-21.5"h			<b>Arm:</b> 26.5"-30"h <b>Weight:</b> 45 lbs.			<b>COM:</b> 3.25 yds. <b>COL:</b> 58.5 sq.ft.							
			<b>COM</b>	<b>COL</b>	<b>1</b>	<b>2</b>	<b>3</b>	<b>4</b>	<b>5</b>	<b>6</b>	<b>7</b>	<b>8</b>	<b>9</b>	<b>10</b>	<b>L1</b>	<b>L2</b>
			1437	1524	1551	1633	1716	1798	1881	1963	2045	2128	2210	2293	2413	2710
			<i>Tilt Swivel w/ Lock / Pneumatic Seat Height Adjustment</i>													
			<i>Knee Tilt Swivel w/ Infinite Lock / Pneumatic Seat Height Adjustment</i>													
		<b>ARM CHAIR / FULLY UPHOLSTERED</b>  <b>446</b>	<b>Overall:</b> 24.5"w 24.5"d 34"h <b>Seat:</b> 20"w 18"d 18"h			<b>Arm:</b> 27"h <b>Weight:</b> 45 lbs.			<b>COM:</b> 3.25 yds. <b>COL:</b> 58.5 sq.ft.							
			<b>COM</b>	<b>COL</b>	<b>1</b>	<b>2</b>	<b>3</b>	<b>4</b>	<b>5</b>	<b>6</b>	<b>7</b>	<b>8</b>	<b>9</b>	<b>10</b>	<b>L1</b>	<b>L2</b>
			1220	1294	1342	1424	1507	1589	1672	1754	1837	1919	2001	2084	2204	2501
			<i>Tight Seat &amp; Back / Front Casters</i>													
		<b>ARM CHAIR / UPHOLSTERED</b>  <b>447</b>	<b>Overall:</b> 24.5"w 24.5"d 34"h <b>Seat:</b> 20"w 18"d 18"h			<b>Arm:</b> 27"h <b>Weight:</b> 45 lbs.			<b>COM:</b> 3.25 yds. <b>COL:</b> 58.5 sq.ft.							
			<b>COM</b>	<b>COL</b>	<b>1</b>	<b>2</b>	<b>3</b>	<b>4</b>	<b>5</b>	<b>6</b>	<b>7</b>	<b>8</b>	<b>9</b>	<b>10</b>	<b>L1</b>	<b>L2</b>
			1262	1338	1382	1464	1547	1629	1712	1794	1876	1959	2041	2124	2133	2430
			<i>Tight Seat &amp; Back</i>													
		<b>BARREL CHAIR / UPHOLSTERED / EXPOSED ARM</b>  <b>448</b>	<b>Overall:</b> 25.5"w 23"d 31"h <b>Seat:</b> 21"w 18.75"d 19"h			<b>Arm:</b> 26"h <b>Weight:</b> 45 lbs.			<b>COM:</b> 2.25 yds. <b>COL:</b> 40.5 sq.ft.							
			<b>COM</b>	<b>COL</b>	<b>1</b>	<b>2</b>	<b>3</b>	<b>4</b>	<b>5</b>	<b>6</b>	<b>7</b>	<b>8</b>	<b>9</b>	<b>10</b>	<b>L1</b>	<b>L2</b>
			1517	1610	1573	1628	1683	1738	1793	1848	1903	1958	2013	2068	2178	2376
			<i>Tight Seat &amp; Back</i>													

Standard With Brass Nail Head Trim

**DESCRIPTION:**

- Upholstery Frames: Hardwood & Plywood
- Seat: High Density Polyurethane Foam Over Eight-Way Hand Tied Coil Springs
- Back: High Density Polyurethane Foam Over Polypropylene Webbing
- Upholstered Arms: Polyurethane Foam Over Hardwood
- Exposed Arms: Solid Cherry, Lacquer Finished (#450 / #451 Arms Are Solid Steam Bent Cherry)
- Classic Base Standard
- 10 Year Warranty

**OPTIONS:**

Specify Exposed Wood Finish (See Page 6)  
 Base & Caster Options Available (See Traditional Options Pages)  
 Brass or Pewter Nail Head Trim (See Traditional Options Pages)

**Note: Trinity Must Approve Specific Fabrics / Leathers Used For Tufting.**

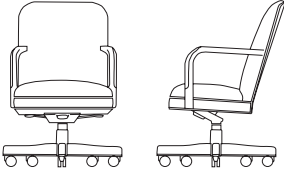
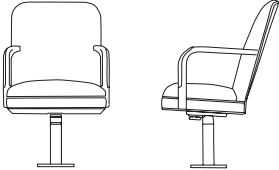
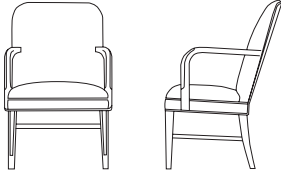
RALEIGH	ITEM #:	SPECIFICATIONS   GRADES   LIST PRICES:													
<b>LOW BACK CHAIR / OPEN WOOD UPHOLSTERED ARM</b>  		<b>Overall:</b> 24.5"w 26"d 37"-40"h			<b>Arm:</b> 27"-30"h			<b>COM:</b> 2.5 yds.							
		<b>Seat:</b> 21"w 18"d 18"-21"h			<b>Weight:</b> 60 lbs.			<b>COL:</b> 45 sq.ft.							
		<b>COM</b>	<b>COL</b>	<b>1</b>	<b>2</b>	<b>3</b>	<b>4</b>	<b>5</b>	<b>6</b>	<b>7</b>	<b>8</b>	<b>9</b>	<b>10</b>	<b>L1</b>	<b>L2</b>
	<b>450-2</b>	1531	1684	1668	1737	1806	1874	1943	2012	2081	2149	2218	2287	2393	2641
		<i>Tilt Swivel w/ Lock / Pneumatic Seat Height Adjustment</i>													
	<b>450-4</b>	1586	1744	1723	1792	1861	1929	1998	2067	2136	2204	2273	2342	2448	2696
		<i>Knee Tilt Swivel w/ Infinite Lock / Pneumatic Seat Height Adjustment</i>													
<b>LOW BACK JURY CHAIR / OPEN WOOD UPHOLSTERED ARM</b>  		<b>Overall:</b> 24.5"w 26"d 37"-40"h			<b>Arm:</b> 27"-30"h			<b>COM:</b> 2.5 yds.							
		<b>Seat:</b> 21"w 18"d 18"-21"h			<b>Weight:</b> 60 lbs.			<b>COL:</b> 45 sq.ft.							
		<b>COM</b>	<b>COL</b>	<b>1</b>	<b>2</b>	<b>3</b>	<b>4</b>	<b>5</b>	<b>6</b>	<b>7</b>	<b>8</b>	<b>9</b>	<b>10</b>	<b>L1</b>	<b>L2</b>
	<b>450-5</b>	1542	1696	1679	1748	1817	1885	1954	2023	2092	2160	2229	2298	2466	2714
		<i>Jury Base / Pneumatic Seat Height Adjustment / Self-Centering 360° Rotation</i>													
<b>ARM CHAIR / OPEN WOOD ARM</b>  		<b>Overall:</b> 23.25"w 26"d 37"h			<b>Arm:</b> 27"h			<b>COM:</b> 2.5 yds. (455-P) / 3 yds. (455-T)							
		<b>Seat:</b> 20"w 18"d 19"h			<b>Weight:</b> 40 lbs.			<b>COL:</b> 45 sq.ft. (455-P) / 54 sq.ft. (455-T)							
		<b>COM</b>	<b>COL</b>	<b>1</b>	<b>2</b>	<b>3</b>	<b>4</b>	<b>5</b>	<b>6</b>	<b>7</b>	<b>8</b>	<b>9</b>	<b>10</b>	<b>L1</b>	<b>L2</b>
	<b>455-P</b>	1290	1419	1428	1497	1565	1634	1703	1771	1840	1909	1978	2046	2145	2392
		<i>Tight Seat &amp; Back</i>													



**DESCRIPTION:**

- Upholstery Frames: Hardwood & Plywood
- Seat: High Density Polyurethane Foam Over Eight-Way Hand Tied Coil Springs
- Back: High Density Polyurethane Foam Over Polypropylene Webbing
- Upholstered Arms: Polyurethane Foam Over Hardwood
- Exposed Arms: Solid Cherry, Lacquer Finished (#455 Arms Are Solid Steam Bent Cherry)
- 10 Year Warranty

**OPTIONS:**

Specify Exposed Wood Finish (See Page 6)  
 Base & Caster Options Available (See Traditional Options Pages)  
 Brass or Pewter Nail Head Trim (See Traditional Options Pages)

**Note: Trinity Must Approve Specific Fabrics / Leathers Used For Tufting.**

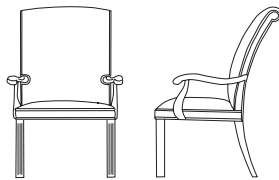
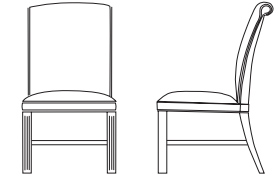
YORK		ITEM #:	SPECIFICATIONS   GRADES   LIST PRICES:													
<b>ARM CHAIR / OPEN WOOD ARM</b>  		452	<b>Overall:</b> 27.5"w 28"d 40"h <b>Seat:</b> 23"w 18.5"d 20"h		<b>Arm:</b> 26"h <b>Weight:</b> 45 lbs.			<b>COM:</b> 3 yds. <b>COL:</b> 54 sq.ft.								
			COM	COL	1	2	3	4	5	6	7	8	9	10	L1	L2
			1362	1499	1514	1589	1665	1740	1816	1892	1967	2043	2118	2194	2290	2563
			<i>Tight Seat &amp; Back</i>													
<b>ARMLESS SIDE CHAIR</b>  		453	<b>Overall:</b> 22"w 28"d 40"h <b>Seat:</b> 22"w 18.5"d 20"h		<b>Arm:</b> n/a <b>Weight:</b> 40 lbs.			<b>COM:</b> 3 yds. <b>COL:</b> 54 sq.ft.								
			COM	COL	1	2	3	4	5	6	7	8	9	10	L1	L2
			1075	1182	1226	1302	1377	1453	1528	1604	1680	1755	1831	1906	2002	2275
			<i>Tight Seat &amp; Back</i>													

**DESCRIPTION:**

- Upholstery Frames: Hardwood & Plywood
- Seat: High Density Polyurethane Foam Over Eight-Way Hand Tied Coil Springs
- Back: High Density Polyurethane Foam Over Sinuous Wire Springs
- Upholstered Arms: Polyurethane Foam Over Hardwood
- Exposed Legs: Solid Cherry, Lacquer Finished
- 10 Year Warranty

**OPTIONS:**

- Feather Down & Polyester Pillows Available (See Page 5)
- Specify Exposed Wood Finish (See Page 6)
- Brass or Pewter Nail Head Trim (See Traditional Options Pages)

**Note: Trinity Must Approve Specific Fabrics / Leathers Used For Tufting.**

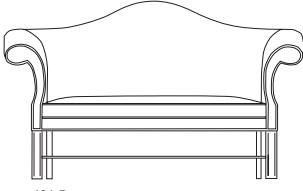
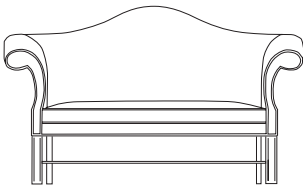
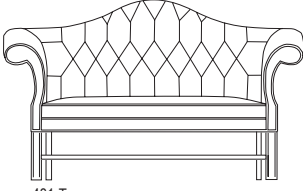
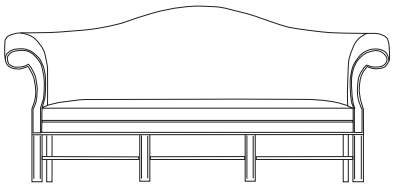
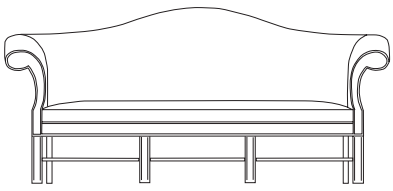
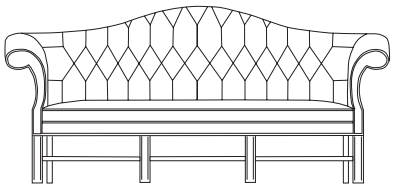
RICHMOND	ITEM #:	SPECIFICATIONS   GRADES   LIST PRICES:													
<p><b>TWO PLACE SOFA / STRAIGHT FLUTED LEG</b></p>  <p>481-P</p>  <p>481-C</p>  <p>481-T</p>		<b>Overall:</b> 59"w 34"d 35.5"h			<b>Arm:</b> 32"h			<b>COM:</b> 7 yds. (481-P) / 8 yds. (481-C) / 7.5 yds. (481-T)							
		<b>Seat:</b> 44"w 20.5"d 18"h			<b>Weight:</b> 105 lbs.			<b>COL:</b> 126 sq.ft. (481-P) / 144 sq.ft. (481-C) / 135 sq.ft. (481-T)							
		<b>COM</b>	<b>COL</b>	<b>1</b>	<b>2</b>	<b>3</b>	<b>4</b>	<b>5</b>	<b>6</b>	<b>7</b>	<b>8</b>	<b>9</b>	<b>10</b>	<b>L1</b>	<b>L2</b>
	<b>481-P</b>	2307	2447	2623	2822	3022	3221	3420	3620	3819	4018	4218	4417	4657	5374
		<i>Tight Seat &amp; Back</i>													
	<b>481-C</b>	2404	2550	2744	2957	3170	3383	3596	3809	4022	4235	4448	4661	4927	5694
		<i>Reversible Loose Cushion / Tight Back</i>													
	<b>481-T</b>	2460	2609	2798	3011	3224	3437	3650	3863	4076	4289	4502	4715	5289	6081
		<i>Tight Seat / Tufted Back</i>													
	<p><b>THREE PLACE SOFA / STRAIGHT FLUTED LEG</b></p>  <p>482-P</p>  <p>482-C</p>  <p>482-T</p>		<b>Overall:</b> 88"w 34"d 38.5"h			<b>Arm:</b> 32"h			<b>COM:</b> 9 yds. (482-P) / 10.75 yds. (482-C) / 9.75 yds. (482-T)						
		<b>Seat:</b> 73"w 20.5"d 18"h			<b>Weight:</b> 140 lbs.			<b>COL:</b> 162 sq.ft. (482-P) / 193.5 sq.ft. (482-C) / 175.5 sq.ft. (482-T)							
		<b>COM</b>	<b>COL</b>	<b>1</b>	<b>2</b>	<b>3</b>	<b>4</b>	<b>5</b>	<b>6</b>	<b>7</b>	<b>8</b>	<b>9</b>	<b>10</b>	<b>L1</b>	<b>L2</b>
<b>482-P</b>		2961	3141	3364	3618	3873	4127	4381	4635	4890	5144	5398	5653	5951	6866
		<i>Tight Seat &amp; Back</i>													
<b>482-C</b>		3145	3336	3596	3878	4160	4442	4723	5005	5287	5569	5850	6132	6476	7491
		<i>Reversible Loose Cushion / Tight Back</i>													
<b>482-T</b>		3444	3653	3857	4125	4393	4661	4929	5197	5465	5733	6001	6269	6885	7850
		<i>Tight Seat / Tufted Back</i>													

**DESCRIPTION:**

- Upholstery Frames: Hardwood & Plywood
- Seat: High Density Polyurethane Foam Over Eight-Way Hand Tied Coil Springs
- Back: High Density Polyurethane Foam Over Sinuous Wire Springs
- Loose Cushions: High Density Polydacron
- Integral Exposed Wood Legs: Solid Cherry
- Leather / Vinyl Cushions Are Not Reversible
- 10 Year Warranty

**OPTIONS:**

- PM1 Power/Data Module (1-Power / 1-USB 2 Port Simplex Charger) .....\$836
- Feather Down & Polyester Pillows Available (See Page 5)  
 Specify Exposed Wood Finish (See Page 6)  
 Brass or Pewter Nail Head Trim (See Traditional Options Pages)

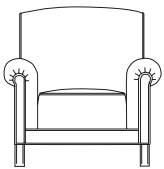
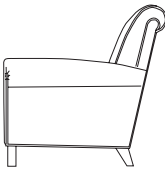
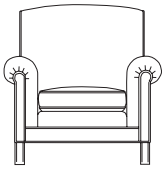
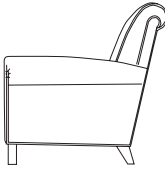
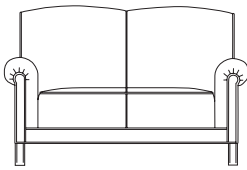
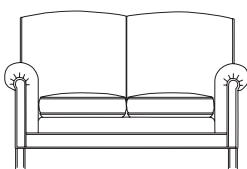
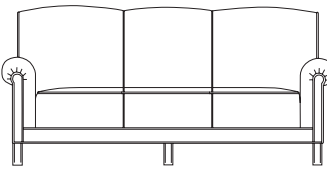
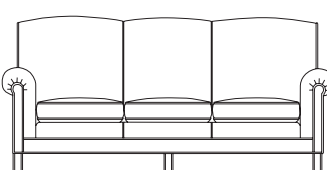
DAVENPORT		ITEM #:	SPECIFICATIONS   GRADES   LIST PRICES:													
<b>LOUNGE CHAIR</b>			<b>Overall:</b> 34.5"w 37"d 34.5"h				<b>Arm:</b> 24"h				<b>COM:</b> 5 yds. (486-P) / 5.5 yds. (486-C)					
			<b>Seat:</b> 21.5"w 21"d 18"h				<b>Weight:</b> 75 lbs.				<b>COL:</b> 90 sq.ft. (486-P) / 99 sq.ft. (486-C)					
 		<b>486-P</b>	<b>COM</b>	<b>COL</b>	<b>1</b>	<b>2</b>	<b>3</b>	<b>4</b>	<b>5</b>	<b>6</b>	<b>7</b>	<b>8</b>	<b>9</b>	<b>10</b>	<b>L1</b>	<b>L2</b>
			1664	1831	1939	2077	2214	2351	2489	2626	2764	2901	3039	3176	3361	3856
			<i>Tight Seat &amp; Back</i>													
 		<b>486-C</b>	1629	1792	1945	2103	2261	2419	2577	2735	2894	3052	3210	3368	3634	4203
			<i>Reversible Loose Seat Cushion / Tight Back</i>													
<b>TWO PLACE SOFA</b>			<b>Overall:</b> 65.5"w 37"d 34.5"h				<b>Arm:</b> 24"h				<b>COM:</b> 7.75 yds. (487-P) / 8.5 yds. (487-C)					
			<b>Seat:</b> 52.5"w 21"d 18"h				<b>Weight:</b> 110 lbs.				<b>COL:</b> 139.5 sq.ft. (487-P) / 153 sq.ft. (487-C)					
		<b>487-P</b>	<b>COM</b>	<b>COL</b>	<b>1</b>	<b>2</b>	<b>3</b>	<b>4</b>	<b>5</b>	<b>6</b>	<b>7</b>	<b>8</b>	<b>9</b>	<b>10</b>	<b>L1</b>	<b>L2</b>
			2436	2680	2862	3075	3288	3502	3715	3928	4141	4354	4567	4780	5055	5822
			<i>Tight Seat &amp; Back</i>													
		<b>487-C</b>	2058	2264	2511	2738	2965	3192	3419	3645	3872	4099	4326	4553	5170	5986
			<i>Reversible Loose Seat Cushions / Tight Back</i>													
<b>THREE PLACE SOFA</b>			<b>Overall:</b> 82.5"w 37"d 34.5"h				<b>Arm:</b> 24"h				<b>COM:</b> 9 yds. (488-P) / 10 yds. (488-C)					
			<b>Seat:</b> 69.5"w 21"d 18"h				<b>Weight:</b> 160 lbs.				<b>COL:</b> 162 sq.ft. (488-P) / 180 sq.ft. (488-C)					
		<b>488-P</b>	<b>COM</b>	<b>COL</b>	<b>1</b>	<b>2</b>	<b>3</b>	<b>4</b>	<b>5</b>	<b>6</b>	<b>7</b>	<b>8</b>	<b>9</b>	<b>10</b>	<b>L1</b>	<b>L2</b>
			2991	3290	3472	3712	3953	4193	4434	4675	4915	5156	5396	5637	5951	6817
			<i>Tight Seat &amp; Back</i>													
		<b>488-C</b>	2569	2826	3105	3373	3641	3909	4177	4445	4713	4981	5249	5517	6399	7364
			<i>Reversible Loose Seat Cushions / Tight Back</i>													

**DESCRIPTION:**

- Upholstery Frames: Hardwood & Plywood
- Seat: High Density Polyurethane Foam Over Eight-Way Hand Tied Coil Springs
- Back: High Density Polyurethane Foam Over Sinuous Wire Springs
- Loose Cushions: High Density Polydacron
- Integral Exposed Wood Legs: Solid Cherry
- Leather / Vinyl Cushions Are Not Reversible
- Brass Ferrules Standard
- 10 Year Warranty

**OPTIONS:**

- PM1 Power/Data Module (1-Power / 1-USB 2 Port Simplex Charger) .....\$836
- Feather Down & Polyester Pillows Available (See Page 5)  
Specify Exposed Wood Finish (See Page 6)  
Brass Nail Head Trim (See Traditional Options Pages)

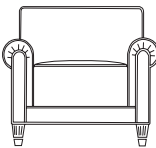
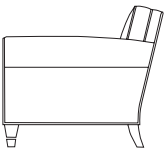
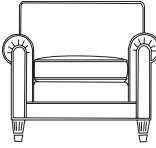
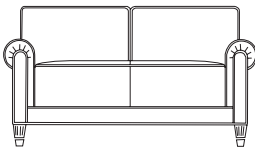
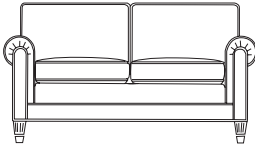
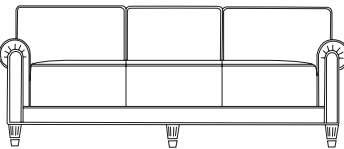
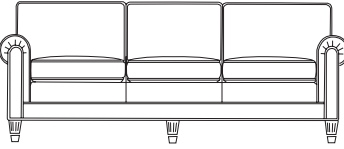
RANDOLPH		ITEM #:	SPECIFICATIONS   GRADES   LIST PRICES:													
<b>LOUNGE CHAIR</b>			<b>Overall:</b> 35"w 34"d 31"h			<b>Arm:</b> 23"h			<b>COM:</b> 4.75 yds. (490-P) / 5.25 yds. (490-C)							
			<b>Seat:</b> 21.5"w 20.5"d 17.5"h			<b>Weight:</b> 65 lbs.			<b>COL:</b> 85.5 sq.ft. (490-P) / 94.5 sq.ft. (490-C)							
 490-P  490-C		<b>490-P</b>	<b>COM</b>	<b>COL</b>	<b>1</b>	<b>2</b>	<b>3</b>	<b>4</b>	<b>5</b>	<b>6</b>	<b>7</b>	<b>8</b>	<b>9</b>	<b>10</b>	<b>L1</b>	<b>L2</b>
			1864	2050	2125	2256	2386	2517	2647	2778	2908	3039	3170	3300	3492	3962
			<i>Tight Seat &amp; Back</i>													
 490-C		<b>490-C</b>	1905	2096	2194	2338	2483	2627	2771	2916	3060	3204	3348	3493	3703	4222
			<i>Reversible Loose Seat Cushion / Tight Back</i>													
<p><i>Brass Nail Head Trim Available On Arm Fronts Only</i></p>																
<b>TWO PLACE SOFA</b>			<b>Overall:</b> 58.5"w 34"d 31"h			<b>Arm:</b> 23"h			<b>COM:</b> 6.75 yds. (491-P) / 7.25 yds. (491-C)							
			<b>Seat:</b> 44"w 20.5"d 17.5"h			<b>Weight:</b> 100 lbs.			<b>COL:</b> 121.5 sq.ft. (491-P) / 130.5 sq.ft. (491-C)							
 491-P		<b>491-P</b>	<b>COM</b>	<b>COL</b>	<b>1</b>	<b>2</b>	<b>3</b>	<b>4</b>	<b>5</b>	<b>6</b>	<b>7</b>	<b>8</b>	<b>9</b>	<b>10</b>	<b>L1</b>	<b>L2</b>
			2473	2720	2844	3029	3215	3400	3586	3771	3957	4143	4328	4514	4773	5441
			<i>Tight Seat &amp; Back</i>													
 491-C		<b>491-C</b>	2555	2810	2967	3174	3380	3586	3792	3998	4204	4411	4617	4823	5116	5858
			<i>Reversible Loose Seat Cushion / Tight Back</i>													
<p><i>Brass Nail Head Trim Available On Arm Fronts Only</i></p>																
<b>THREE PLACE SOFA</b>			<b>Overall:</b> 78.5"w 34"d 31"h			<b>Arm:</b> 23"h			<b>COM:</b> 8 yds. (492-P) / 9.5 yds. (492-C)							
			<b>Seat:</b> 64"w 20.5"d 17.5"h			<b>Weight:</b> 147 lbs.			<b>COL:</b> 144 sq.ft. (492-P) / 171 sq.ft. (492-C)							
 492-P		<b>492-P</b>	<b>COM</b>	<b>COL</b>	<b>1</b>	<b>2</b>	<b>3</b>	<b>4</b>	<b>5</b>	<b>6</b>	<b>7</b>	<b>8</b>	<b>9</b>	<b>10</b>	<b>L1</b>	<b>L2</b>
			3135	3449	3575	3795	4015	4235	4455	4675	4895	5115	5335	5555	5862	6653
			<i>Tight Seat &amp; Back</i>													
 492-C		<b>492-C</b>	3282	3610	3791	4045	4299	4553	4808	5062	5316	5570	5825	6079	6437	7352
			<i>Reversible Loose Seat Cushion / Tight Back</i>													
<p><i>Brass Nail Head Trim Available On Arm Fronts Only</i></p>																

**DESCRIPTION:**

- Upholstery Frames: Hardwood & Plywood
- Seat: High Density Polyurethane Foam Over Eight-Way Hand Tied Coil Springs
- Back: High Density Polyurethane Foam Over Sinuous Wire Springs
- Loose Cushions: High Density Polydacron
- Integral Exposed Wood Legs: Solid Cherry
- Leather / Vinyl Cushions Are Not Reversible
- Brass Nail Head Trim / Brass Ferrules Standard
- 10 Year Warranty



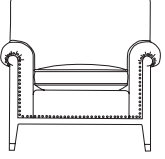
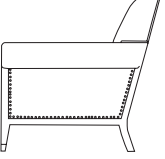
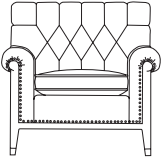
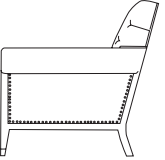
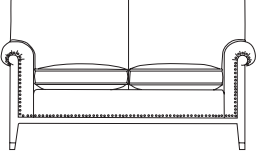
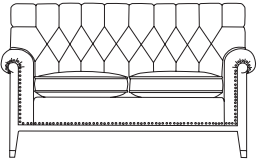
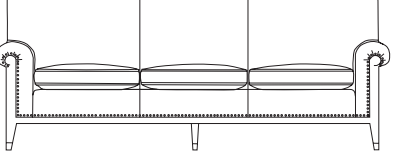
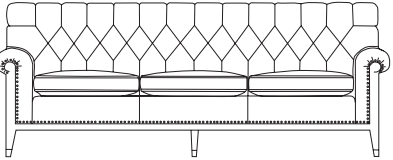

**OPTIONS:**

- PM1 Power/Data Module (1-Power / 1-USB 2 Port Simplex Charger) .....\$836
- Feather Down & Polyester Pillows Available (See Page 5)  
Specify Exposed Wood Finish (See Page 6)

**Note: Trinity Must Approve Specific Fabrics / Leathers Used For Tufting.**

RAYBURN		ITEM #:	SPECIFICATIONS   GRADES   LIST PRICES:													
<b>LOUNGE CHAIR / TUFTED BACK</b>			<b>Overall:</b> 34.5"w 34"d 34"h			<b>Arm:</b> 23"h			<b>COM:</b> 4.75 yds. (493-P) / 6.25 yds. (493-C) / 6.5 yds. (493-T)							
			<b>Seat:</b> 21.5"w 20"d 18"h			<b>Weight:</b> 65 lbs.			<b>COL:</b> 85.5 sq.ft. (493-P) / 112.5 sq.ft. (493-C) / 117 sq.ft. (493-T)							
 493-C  493-T  493-C  493-T			<b>COM</b>	<b>COL</b>	<b>1</b>	<b>2</b>	<b>3</b>	<b>4</b>	<b>5</b>	<b>6</b>	<b>7</b>	<b>8</b>	<b>9</b>	<b>10</b>	<b>L1</b>	<b>L2</b>
		<b>493-C</b>	2074	2282	2377	2528	2679	2830	2982	3133	3284	3435	3586	3737	4084	4628
			<i>Reversible Loose Seat Cushion / Tight Back</i>													
		<b>493-T</b>	2365	2601	2667	2818	2970	3121	3272	3423	3574	3726	3877	4028	4246	4790
			<i>Reversible Loose Seat Cushion / Tufted Back</i>													
Standard With Brass Nail Head Trim / Brass Ferrules																
<b>TWO PLACE SOFA / TUFTED BACK</b>			<b>Overall:</b> 64"w 34"d 34"h			<b>Arm:</b> 23"h			<b>COM:</b> 6.5 yds. (494-P) / 8 yds. (494-C) / 8.75 yds. (494-T)							
			<b>Seat:</b> 51"w 20"d 18"h			<b>Weight:</b> 100 lbs.			<b>COL:</b> 117 sq.ft. (494-P) / 144 sq.ft. (494-C) / 157.5 sq.ft. (494-T)							
 494-C  494-T			<b>COM</b>	<b>COL</b>	<b>1</b>	<b>2</b>	<b>3</b>	<b>4</b>	<b>5</b>	<b>6</b>	<b>7</b>	<b>8</b>	<b>9</b>	<b>10</b>	<b>L1</b>	<b>L2</b>
		<b>494-C</b>	2663	2929	3089	3302	3515	3728	3941	4154	4367	4580	4793	5006	5687	6454
			<i>Reversible Loose Seat Cushions / Tight Back</i>													
		<b>494-T</b>	3556	3912	4010	4237	4463	4690	4917	5144	5371	5597	5824	6051	6394	7210
			<i>Reversible Loose Seat Cushions / Tufted Back</i>													
Standard With Brass Nail Head Trim / Brass Ferrules																
<b>THREE PLACE SOFA / TUFTED BACK</b>			<b>Overall:</b> 89"w 34"d 34"h			<b>Arm:</b> 23"h			<b>COM:</b> 9.25 yds. (495-P) / 10.25 yds. (495-C) / 11 yds. (495-T)							
			<b>Seat:</b> 76"w 20"d 18"h			<b>Weight:</b> 170 lbs.			<b>COL:</b> 166.5 sq.ft. (495-P) / 184.5 sq.ft. (495-C) / 198 sq.ft. (495-T)							
 495-C  495-T			<b>COM</b>	<b>COL</b>	<b>1</b>	<b>2</b>	<b>3</b>	<b>4</b>	<b>5</b>	<b>6</b>	<b>7</b>	<b>8</b>	<b>9</b>	<b>10</b>	<b>L1</b>	<b>L2</b>
		<b>495-C</b>	3284	3612	3820	4088	4356	4624	4892	5160	5428	5696	5964	6232	7308	8272
			<i>Reversible Loose Seat Cushions / Tight Back</i>													
		<b>495-T</b>	4697	5167	5288	5584	5879	6175	6470	6766	7061	7357	7652	7948	8411	9474
			<i>Reversible Loose Seat Cushions / Tufted Back</i>													
Standard With Brass Nail Head Trim / Brass Ferrules																

BASES	OPTION #:	SPECIFICATIONS   LIST PRICES   AVAILABILITY:								
<p>TRANSITIONAL WOOD BASE</p> 	<p>TWB</p>	<p><b>Overall:</b> 25"w 25"d 5.5"h</p> <hr/> <p>No Charge Solid Hardwood Cap, Steel Reinforced 5 Prong Base With 55mm Black Dual Wheel Casters.</p> <p>OPTIONS:</p> <table border="0"> <tr> <td>Carpet Caster - 2" Metal Balls</td> <td>\$164 (Set Of 5)</td> </tr> <tr> <td>Antique Bronze Hooded Caster - 2" Rubber Ball</td> <td>\$151 (Set Of 5)</td> </tr> <tr> <td>Brass Hooded Black Caster - 2" Dual Wheels</td> <td>\$84 (Set Of 5)</td> </tr> </table> <p><b>Available:</b> Traditional Executive Seating</p>	Carpet Caster - 2" Metal Balls	\$164 (Set Of 5)	Antique Bronze Hooded Caster - 2" Rubber Ball	\$151 (Set Of 5)	Brass Hooded Black Caster - 2" Dual Wheels	\$84 (Set Of 5)		
Carpet Caster - 2" Metal Balls	\$164 (Set Of 5)									
Antique Bronze Hooded Caster - 2" Rubber Ball	\$151 (Set Of 5)									
Brass Hooded Black Caster - 2" Dual Wheels	\$84 (Set Of 5)									
<p>CLASSIC WOOD BASE</p> 	<p>CWB</p>	<p><b>Overall:</b> 28"w 28"d 5"h</p> <hr/> <p>Standard Traditional Base - No Charge Solid Hardwood Cap, Steel Reinforced 5 Prong Base With 55mm Black Dual Wheel Casters.</p> <p>OPTIONS:</p> <table border="0"> <tr> <td>Carpet Caster - 2" Metal Balls</td> <td>\$164 (Set Of 5)</td> </tr> <tr> <td>Antique Bronze Hooded Caster - 2" Rubber Ball</td> <td>\$151 (Set Of 5)</td> </tr> <tr> <td>Brass Hooded Black Caster - 2" Dual Wheels</td> <td>\$84 (Set Of 5)</td> </tr> <tr> <td>Brass Scuff Plates</td> <td>\$105 (Set Of 5)</td> </tr> </table> <p><b>Available:</b> Traditional Executive Seating</p>	Carpet Caster - 2" Metal Balls	\$164 (Set Of 5)	Antique Bronze Hooded Caster - 2" Rubber Ball	\$151 (Set Of 5)	Brass Hooded Black Caster - 2" Dual Wheels	\$84 (Set Of 5)	Brass Scuff Plates	\$105 (Set Of 5)
Carpet Caster - 2" Metal Balls	\$164 (Set Of 5)									
Antique Bronze Hooded Caster - 2" Rubber Ball	\$151 (Set Of 5)									
Brass Hooded Black Caster - 2" Dual Wheels	\$84 (Set Of 5)									
Brass Scuff Plates	\$105 (Set Of 5)									
<p>TAPERED RESIN BASE</p> 	<p>TRB</p>	<p><b>Overall:</b> 25.5"w 25.5"d 5"h</p> <hr/> <p>\$100 Deduct Black Reinforced Nylon 5 Prong Base With 55mm Black Dual Wheel Casters.</p> <p><b>Available:</b> Traditional Executive Seating</p>								
<p>JURY BASE</p> 	<p>JRB</p>	<p><b>Overall:</b> 8.5" Diameter 3.75"h</p> <hr/> <p>\$198 360° Rotation, Self Centering With Pneumatic Height Adjustment</p> <p>OPTIONS: No Rotation</p> <p><b>Available:</b> Traditional Executive Seating</p>								

CASTERS / SCUFF PLATES / NAIL TRIM / MEDALLIONS	OPTION #:	SPECIFICATIONS   LIST PRICES   AVAILABILITY:
<p><b>CASTERS</b></p>  <p>(C1) Carpet Caster - 2" Metal Balls</p> <p>(C2) Antique Bronze Hooded Caster - 2" Rubber Ball</p> <p>(C3) Brass Hooded Black Caster - 2" Dual Wheels</p> <p>(C4) Black Sculptured Glide - 2" Flat Bottom Glide</p>	<p><b>C1</b></p> <p><b>C2</b></p> <p><b>C3</b></p> <p><b>C4</b></p>	<p><b>Overall: 2"h</b></p> <hr/> <p>\$164 (Set Of 5) <i>Carpet Caster - 2" Metal Balls (Additional Finishes Available)</i></p> <p>\$151 (Set Of 5) <i>Antique Bronze Hooded Caster - 2" Rubber Ball (Additional Finishes Available)</i></p> <p>\$84 (Set Of 5) <i>Brass Hooded Black Caster - 2" Dual Wheels (Additional Finishes Available)</i></p> <p>No Charge (Set Of 5) <i>Black Sculptured Glide - 2" Flat Bottom Glide</i></p> <p><b>Available: Traditional Executive Seating</b></p>
<p><b>SCUFF PLATES</b></p> 	<p><b>SP</b></p>	<p><b>Overall: 1"w 4"d</b></p> <hr/> <p>\$105 (Set Of 5) <i>(Specify Brass Or Pewter)</i></p> <p><b>Available: Classic Base Only</b></p>
<p><b>NAIL HEAD TRIM</b></p> 	<p><b>NT-1</b></p> <p><b>NT-2</b></p> <p><b>NT-3</b></p>	<p><b>Overall: .4375" Diameter</b></p> <hr/> <p>\$65 - Lounge Chair <i>#9 French Natural Brass Standard. Pewter Nail Trim Is Available. (Specify Finish) NOTE: All Trim Is Placed Head To Head.</i></p> <p>\$98 - Executive Chair, Wing Back Chairs, Two Place Sofa (Love Seat) <i>#9 French Natural Brass Standard. Pewter Nail Trim Is Available. (Specify Finish) NOTE: All Trim Is Placed Head To Head.</i></p> <p>\$129 - Three Place Sofa <i>#9 French Natural Brass Standard. Pewter Nail Trim Is Available. (Specify Finish) NOTE: All Trim Is Placed Head To Head.</i></p> <p><b>Available: Traditional Executive, Guest, Lounge</b></p>
<p><b>CONCENTRIC CIRCLE ARM MEDALLIONS</b></p> 	<p><b>CCM</b></p>	<p><b>Overall: 1.25" Diameter</b></p> <hr/> <p>No Charge <i>(Specify Finish)</i></p> <p><b>Available: Traditional Executive Chairs</b></p>

POWER / COVERS	OPTION #:	SPECIFICATIONS   LIST PRICES   AVAILABILITY:
<p>POWER / DATA MODULE</p> 	<p><b>PM1</b></p>	<p><b>Overall:</b> 5.25"w 1.25"d 4.25"h</p> <hr/> <p><b>\$836</b> (1-Power / 1-USB 2 Port Simplex Charger Standard)  <i>Vertical / Horizontal Mount Power Module. Price Varies By Socket. Contact Customer Service For Quote. (Additional Colors Available)</i></p> <p><b>Available:</b> Traditional Lounge</p>
<p>CONTRASTING COVERS</p> 	<p><b>CC</b></p>	<p><b>Overall:</b> n/a</p> <hr/> <p><b>\$129</b>  <i>NOTE: If Two Or More Upholsteries Or Leathers Are Used On Any Piece Of Furniture, Then A Contrast Charge Will Apply Per Order. When Using Trinity Upholstery, The Higher Priced Upholstery Grade Will Be Used In Pricing, Unless It's Trinity Leather With Fabric Contrast Welt, Or COM With Trinity Contrast Welt, Then Contact Customer Service For Pricing.</i></p> <p><b>Available:</b> Traditional Collection</p>



# Conrad

---

EXECUTIVE / GUEST

Effective: August 1, 2022

T R I N I T Y

**Date:**

**Page:**

**Modification:**

**Description:**

---

**DESCRIPTION:**

- Upholstery Frames: Plywood & Hardwood
- Seat / Back: High Density Polyurethane Foam
- Arms: High Density Polyurethane Foam Over Plywood & Hardwood
- Exposed Wood Upholstered Arms & Exposed Wood Open Arms Have Exposed Solid Maple Front Posts Finished In Lacquer
- All Arms Attached & Reinforced w/ Steel
- Black Arched Resin Base Standard
- 10 Year Warranty

**OPTIONS:**

Specify Exposed Wood Finish (See Page 6)  
Base & Caster Options Available (See Conrad Options Pages)

**Note: Trinity Must Approve Specific Fabrics / Leathers Used For Tufting.**

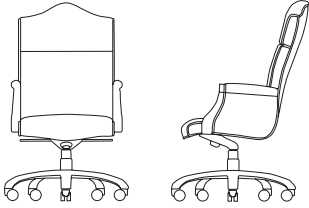
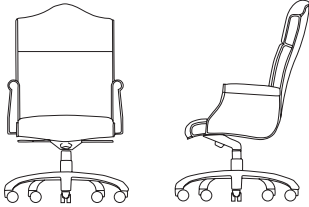
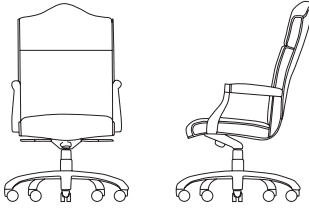
EXECUTIVE		ITEM #:	SPECIFICATIONS   GRADES   LIST PRICES:													
		<b>HIGH BACK CHAIR / EXPOSED WOOD UPHOLSTERED ARM</b>	<b>Overall:</b> 24.5"w 28"d 45"-48"h			<b>Arm:</b> 25"-28"h			<b>COM:</b> 3.25 yds. (500-2 / 500-4) / 3.5 yds. (500-2X)							
			<b>Seat:</b> 20.5"w 20"d 17"-20"h			<b>Weight:</b> 65 lbs.			<b>COL:</b> 58.5 sq.ft. (500-2 / 500-4) / 63 sq.ft. (500-2X)							
			<b>COM</b>	<b>COL</b>	<b>1</b>	<b>2</b>	<b>3</b>	<b>4</b>	<b>5</b>	<b>6</b>	<b>7</b>	<b>8</b>	<b>9</b>	<b>10</b>	<b>L1</b>	<b>L2</b>
			<b>500-2</b>	1420	1562	1508	1590	1673	1755	1837	1920	2002	2085	2167	2250	2382
Tilt Swivel / Pneumatic Seat Height Adjustment																
		<b>500-2X</b>	1571	1728	1664	1754	1843	1932	2022	2111	2200	2290	2379	2468	2605	2927
Heavy Duty Construction / Overall Size Increased: W + 1.5", D + 1.5" / Tilt Swivel / Pneumatic Seat Height Adjustment																
		<b>500-4</b>	1467	1613	1552	1634	1716	1799	1881	1964	2046	2129	2211	2294	2426	2723
Knee Tilt Swivel w/ Infinite Lock / Pneumatic Seat Height Adjustment																
		<b>HIGH BACK CHAIR / FULLY UPHOLSTERED ARM</b>	<b>Overall:</b> 26"w 28"d 45"-48"h			<b>Arm:</b> 25"-28"h			<b>COM:</b> 3.5 yds. (501-2 / 501-4) / 3.5 yds. (501-2X)							
			<b>Seat:</b> 20.5"w 20"d 17"-20"h			<b>Weight:</b> 65 lbs.			<b>COL:</b> 63 sq.ft. (501-2 / 501-4) / 63 sq.ft. (501-2X)							
			<b>COM</b>	<b>COL</b>	<b>1</b>	<b>2</b>	<b>3</b>	<b>4</b>	<b>5</b>	<b>6</b>	<b>7</b>	<b>8</b>	<b>9</b>	<b>10</b>	<b>L1</b>	<b>L2</b>
			<b>501-2</b>	1276	1404	1385	1474	1564	1653	1742	1832	1921	2010	2100	2189	2329
Tilt Swivel / Pneumatic Seat Height Adjustment																
		<b>501-2X</b>	1433	1576	1534	1623	1712	1802	1891	1980	2070	2159	2248	2338	2478	2799
Heavy Duty Construction / Overall Size Increased: W + 1.5", D + 1.5" / Tilt Swivel / Pneumatic Seat Height Adjustment																
		<b>501-4</b>	1340	1474	1446	1535	1624	1714	1803	1892	1982	2071	2160	2250	2390	2711
Knee Tilt Swivel w/ Infinite Lock / Pneumatic Seat Height Adjustment																
		<b>HIGH BACK CHAIR / EXPOSED WOOD / OPEN ARM</b>	<b>Overall:</b> 24.5"w 28"d 45"-48"h			<b>Arm:</b> 25"-28"h			<b>COM:</b> 2.75 yds.							
			<b>Seat:</b> 20.5"w 20"d 17"-20"h			<b>Weight:</b> 65 lbs.			<b>COL:</b> 49.5 sq.ft.							
			<b>COM</b>	<b>COL</b>	<b>1</b>	<b>2</b>	<b>3</b>	<b>4</b>	<b>5</b>	<b>6</b>	<b>7</b>	<b>8</b>	<b>9</b>	<b>10</b>	<b>L1</b>	<b>L2</b>
			<b>502-2</b>	1307	1438	1373	1442	1511	1579	1648	1717	1786	1854	1923	1992	2107
Tilt Swivel / Pneumatic Seat Height Adjustment																
		<b>502-4</b>	1371	1508	1434	1502	1571	1640	1709	1777	1846	1915	1984	2052	2167	2415
Knee Tilt Swivel w/ Infinite Lock / Pneumatic Seat Height Adjustment																

**DESCRIPTION:**

- Upholstery Frames: Plywood & Hardwood
- Seat / Back: High Density Polyurethane Foam
- Arms: High Density Polyurethane Foam Over Plywood & Hardwood
- Exposed Wood Upholstered Arms & Exposed Wood Open Arms Have Exposed Solid Maple Front Posts Finished In Lacquer
- All Arms Attached & Reinforced w/ Steel
- Task Arm Has Black Urethane Pad & Adjusts Vertically
- Black Arched Resin Base Standard
- 10 Year Warranty

**OPTIONS:**

Specify Exposed Wood Finish (See Page 6)  
Base & Caster Options Available (See Conrad Options Pages)

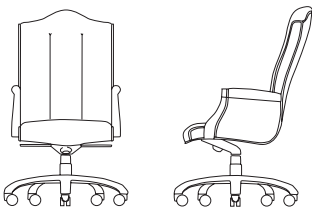
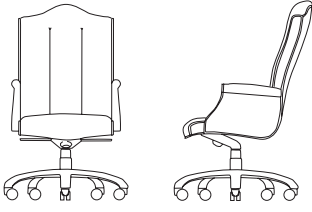
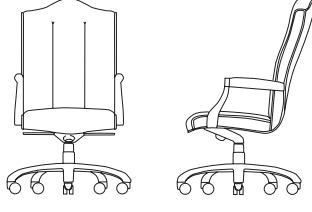
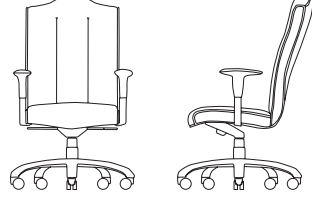
EXECUTIVE		ITEM #:	SPECIFICATIONS   GRADES   LIST PRICES:																	
		<b>HIGH BACK CHAIR / EXPOSED WOOD UPHOLSTERED ARM / VERTICAL CHANNEL BACK</b>	<b>Overall:</b> 25"w 28"d 45"-48"h <b>Seat:</b> 20.5"w 20"d 17"-20"h	<b>Arm:</b> 25"-28"h <b>Weight:</b> 65 lbs.	<b>COM:</b> 3.5 yds. (510-2 / 510-4) / 3.5 yds. (510-2X) <b>COL:</b> 63 sq.ft. (510-2 / 510-4) / 63 sq.ft. (510-2X)	<b>COM</b>	<b>COL</b>	<b>1</b>	<b>2</b>	<b>3</b>	<b>4</b>	<b>5</b>	<b>6</b>	<b>7</b>	<b>8</b>	<b>9</b>	<b>10</b>	<b>L1</b>	<b>L2</b>	
			<b>510-2</b>	1383	1521	1486	1575	1665	1754	1843	1933	2022	2111	2201	2290	2422	2744	<i>Tilt Swivel / Pneumatic Seat Height Adjustment</i>		
			<b>510-2X</b>	1439	1583	1539	1629	1718	1807	1897	1986	2076	2165	2254	2344	2478	2799	<i>Heavy Duty Construction / Overall Size Increased: W + 1.5", D + 1.5" / Tilt Swivel / Pneumatic Seat Height Adjustment</i>		
			<b>510-4</b>	1441	1585	1541	1630	1720	1809	1898	1988	2077	2166	2256	2345	2477	2799	<i>Knee Tilt Swivel w/ Infinite Lock / Pneumatic Seat Height Adjustment</i>		
		<b>HIGH BACK CHAIR / FULLY UPHOLSTERED ARM / VERTICAL CHANNEL BACK</b>	<b>Overall:</b> 25"w 28"d 45"-48"h <b>Seat:</b> 20.5"w 20"d 17"-20"h	<b>Arm:</b> 25"-28"h <b>Weight:</b> 65 lbs.	<b>COM:</b> 3.25 yds. (511-2 / 511-4) / 3.25 yds. (511-2X) <b>COL:</b> 58.5 sq.ft. (511-2 / 511-4) / 58.5 sq.ft. (511-2X)	<b>COM</b>	<b>COL</b>	<b>1</b>	<b>2</b>	<b>3</b>	<b>4</b>	<b>5</b>	<b>6</b>	<b>7</b>	<b>8</b>	<b>9</b>	<b>10</b>	<b>L1</b>	<b>L2</b>	
			<b>511-2</b>	1253	1378	1350	1432	1515	1597	1680	1762	1845	1927	2009	2092	2222	2519	<i>Tilt Swivel / Pneumatic Seat Height Adjustment</i>		
			<b>511-2X</b>	1310	1441	1403	1486	1568	1651	1733	1816	1898	1980	2063	2145	2277	2574	<i>Heavy Duty Construction / Overall Size Increased: W + 1.5", D + 1.5" / Tilt Swivel / Pneumatic Seat Height Adjustment</i>		
			<b>511-4</b>	1305	1436	1399	1482	1564	1647	1729	1812	1894	1976	2059	2141	2271	2568	<i>Knee Tilt Swivel w/ Infinite Lock / Pneumatic Seat Height Adjustment</i>		
		<b>HIGH BACK CHAIR / EXPOSED WOOD OPEN ARM / VERTICAL CHANNEL BACK</b>	<b>Overall:</b> 25"w 28"d 45"-48"h <b>Seat:</b> 20.5"w 20"d 17"-20"h	<b>Arm:</b> 25"-28"h <b>Weight:</b> 65 lbs.	<b>COM:</b> 3 yds. <b>COL:</b> 54 sq.ft.	<b>COM</b>	<b>COL</b>	<b>1</b>	<b>2</b>	<b>3</b>	<b>4</b>	<b>5</b>	<b>6</b>	<b>7</b>	<b>8</b>	<b>9</b>	<b>10</b>	<b>L1</b>	<b>L2</b>	
			<b>512-2</b>	1286	1414	1367	1442	1518	1594	1669	1745	1820	1896	1972	2047	2163	2435	<i>Tilt Swivel / Pneumatic Seat Height Adjustment</i>		
			<b>512-4</b>	1344	1478	1422	1497	1573	1649	1724	1800	1875	1951	2027	2102	2218	2490	<i>Knee Tilt Swivel w/ Infinite Lock / Pneumatic Seat Height Adjustment</i>		
					<b>HIGH BACK CHAIR / FULLY ADJUSTABLE TASK CHAIR / VERTICAL CHANNEL BACK</b>	<b>Overall:</b> 24"w 28"d 45"-48"h <b>Seat:</b> 20.5"w 20"d 17"-20"h	<b>Arm:</b> 25"-28"h <b>Weight:</b> 65 lbs.	<b>COM:</b> 3 yds. <b>COL:</b> 54 sq.ft.	<b>COM</b>	<b>COL</b>	<b>1</b>	<b>2</b>	<b>3</b>	<b>4</b>	<b>5</b>	<b>6</b>	<b>7</b>	<b>8</b>	<b>9</b>	<b>10</b>
<b>513-2</b>	1138	1251				1227	1302	1378	1454	1529	1605	1680	1756	1832	1907	2014	2286	<i>Tilt Swivel / Pneumatic Seat Height Adjustment</i>		
<b>513-4</b>	1196	1315				1282	1357	1433	1509	1584	1660	1735	1811	1887	1962	2069	2341	<i>Knee Tilt Swivel w/ Infinite Lock / Pneumatic Seat Height Adjustment</i>		

**DESCRIPTION:**

- Upholstery Frames: Plywood & Hardwood
- Seat / Back: High Density Polyurethane Foam
- Arms: High Density Polyurethane Foam Over Plywood & Hardwood
- Exposed Wood Upholstered Arms & Exposed Wood Open Arms Have Exposed Solid Maple Front Posts Finished In Lacquer
- All Arms Attached & Reinforced w/ Steel
- Black Arched Resin Base Standard
- 10 Year Warranty

**OPTIONS:**

Specify Exposed Wood Finish (See Page 6)  
Base & Caster Options Available (See Conrad Options Pages)

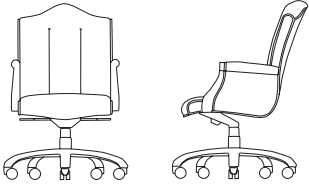
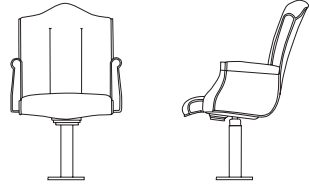
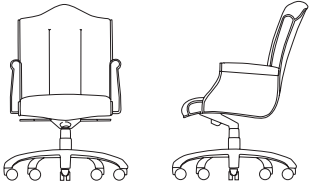
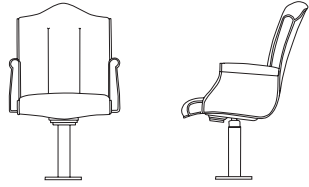
EXECUTIVE		ITEM #:	SPECIFICATIONS   GRADES   LIST PRICES:														
		<b>LOW BACK CHAIR / EXPOSED WOOD UPHOLSTERED ARM / VERTICAL CHANNEL BACK</b>	<b>Overall:</b> 24.5"w 28"d 36"-39"h <b>Seat:</b> 20.5"w 20"d 17"-20"h			<b>Arm:</b> 25"-28"h <b>Weight:</b> 60 lbs.			<b>COM:</b> 3 yds. <b>COL:</b> 54 sq.ft.								
			<b>COM</b>	<b>COL</b>	<b>1</b>	<b>2</b>	<b>3</b>	<b>4</b>	<b>5</b>	<b>6</b>	<b>7</b>	<b>8</b>	<b>9</b>	<b>10</b>	<b>L1</b>	<b>L2</b>	
			<b>520-2</b>	1362	1499	1439	1515	1591	1666	1742	1817	1893	1969	2044	2120	2242	2514
			<i>Tilt Swivel / Pneumatic Seat Height Adjustment</i>														
			<b>520-4</b>	1426	1569	1500	1575	1651	1727	1802	1878	1953	2029	2105	2180	2302	2574
			<i>Knee Tilt Swivel w/ Infinite Lock / Pneumatic Seat Height Adjustment</i>														
		<b>LOW BACK JURY CHAIR / EXPOSED WOOD UPHOLSTERED ARM / VERTICAL CHANNEL BACK</b>	<b>Overall:</b> 24.5"w 28"d 36"-39"h <b>Seat:</b> 20.5"w 20"d 17"-20"h			<b>Arm:</b> 25"-28"h <b>Weight:</b> 60 lbs.			<b>COM:</b> 3 yds. <b>COL:</b> 54 sq.ft.								
			<b>COM</b>	<b>COL</b>	<b>1</b>	<b>2</b>	<b>3</b>	<b>4</b>	<b>5</b>	<b>6</b>	<b>7</b>	<b>8</b>	<b>9</b>	<b>10</b>	<b>L1</b>	<b>L2</b>	
			<b>520-5</b>	1578	1735	1643	1718	1794	1870	1945	2021	2096	2172	2248	2323	2445	2717
			<i>Tilt Swivel / Pneumatic Seat Height Adjustment / Self-Centering 360° Rotation</i>														
		<b>LOW BACK CHAIR / FULLY UPHOLSTERED ARM / VERTICAL CHANNEL BACK</b>	<b>Overall:</b> 25"w 28"d 36"-39"h <b>Seat:</b> 20.5"w 20"d 17"-20"h			<b>Arm:</b> 25"-28"h <b>Weight:</b> 60 lbs.			<b>COM:</b> 3 yds. <b>COL:</b> 54 sq.ft.								
			<b>COM</b>	<b>COL</b>	<b>1</b>	<b>2</b>	<b>3</b>	<b>4</b>	<b>5</b>	<b>6</b>	<b>7</b>	<b>8</b>	<b>9</b>	<b>10</b>	<b>L1</b>	<b>L2</b>	
			<b>521-2</b>	1224	1346	1308	1384	1460	1535	1611	1686	1762	1838	1913	1989	2113	2385
			<i>Tilt Swivel / Pneumatic Seat Height Adjustment</i>														
			<b>521-4</b>	1282	1410	1363	1439	1515	1590	1666	1741	1817	1893	1968	2044	2168	2440
			<i>Knee Tilt Swivel w/ Infinite Lock / Pneumatic Seat Height Adjustment</i>														
		<b>LOW BACK JURY CHAIR / FULLY UPHOLSTERED ARM / VERTICAL CHANNEL BACK</b>	<b>Overall:</b> 25"w 28"d 36"-39"h <b>Seat:</b> 20.5"w 20"d 17"-20"h			<b>Arm:</b> 25"-28"h <b>Weight:</b> 60 lbs.			<b>COM:</b> 3 yds. <b>COL:</b> 54 sq.ft.								
			<b>COM</b>	<b>COL</b>	<b>1</b>	<b>2</b>	<b>3</b>	<b>4</b>	<b>5</b>	<b>6</b>	<b>7</b>	<b>8</b>	<b>9</b>	<b>10</b>	<b>L1</b>	<b>L2</b>	
			<b>521-5</b>	1439	1583	1512	1587	1663	1739	1814	1890	1965	2041	2117	2192	2316	2588
			<i>Tilt Swivel / Pneumatic Seat Height Adjustment / Self-Centering 360° Rotation</i>														

**DESCRIPTION:**

- Upholstery Frames: Plywood & Hardwood
- Seat / Back: High Density Polyurethane Foam
- Arms: High Density Polyurethane Foam Over Plywood & Hardwood
- Exposed Wood Upholstered Arms & Exposed Wood Open Arms Have Exposed Solid Maple Front Posts Finished In Lacquer
- All Arms Attached & Reinforced w/ Steel
- Task Arm Has Black Urethane Pad & Adjusts Vertically
- Black Arched Resin Base Standard
- 10 Year Warranty

**OPTIONS:**

Specify Exposed Wood Finish (See Page 6)  
Base & Caster Options Available (See Conrad Options Pages)

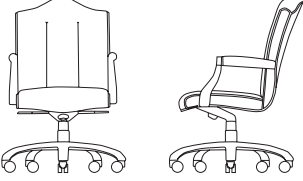
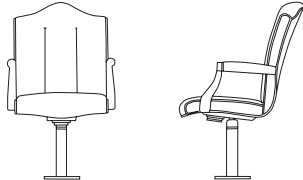
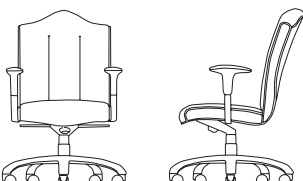
EXECUTIVE	ITEM #:	SPECIFICATIONS   GRADES   LIST PRICES:													
<b>LOW BACK CHAIR / EXPOSED WOOD OPEN ARM</b>  		<b>Overall:</b> 24.5"w 28"d 36"-39"h			<b>Arm:</b> 25"-28"h			<b>COM:</b> 2.75 yds.							
		<b>Seat:</b> 20.5"w 20"d 17"-20"h			<b>Weight:</b> 60 lbs.			<b>COL:</b> 49.5 sq.ft.							
		<b>COM</b>	<b>COL</b>	<b>1</b>	<b>2</b>	<b>3</b>	<b>4</b>	<b>5</b>	<b>6</b>	<b>7</b>	<b>8</b>	<b>9</b>	<b>10</b>	<b>L1</b>	<b>L2</b>
	<b>522-2</b>	1274	1402	1342	1411	1480	1548	1617	1686	1754	1823	1892	1961	2070	2317
		<i>Tilt Swivel / Pneumatic Seat Height Adjustment</i>													
	<b>522-4</b>	1332	1466	1397	1466	1535	1603	1672	1741	1809	1878	1947	2016	2125	2372
		<i>Knee Tilt Swivel w/ Infinite Lock / Pneumatic Seat Height Adjustment</i>													
<b>LOW BACK JURY CHAIR / EXPOSED WOOD OPEN ARM</b>  		<b>Overall:</b> 24.5"w 28"d 36"-39"h			<b>Arm:</b> 25"-28"h			<b>COM:</b> 2.75 yds.							
		<b>Seat:</b> 20.5"w 20"d 17"-20"h			<b>Weight:</b> 60 lbs.			<b>COL:</b> 49.5 sq.ft.							
		<b>COM</b>	<b>COL</b>	<b>1</b>	<b>2</b>	<b>3</b>	<b>4</b>	<b>5</b>	<b>6</b>	<b>7</b>	<b>8</b>	<b>9</b>	<b>10</b>	<b>L1</b>	<b>L2</b>
	<b>522-5</b>	1484	1632	1513	1568	1623	1678	1732	1787	1842	1897	1952	2007	2107	2305
		<i>Tilt Swivel / Pneumatic Seat Height Adjustment / Self-Centering 360° Rotation</i>													
<b>LOW BACK CHAIR / ADJUSTABLE TASK ARM</b>  		<b>Overall:</b> 25"w 28"d 36"-39"h			<b>Arm:</b> 25"-28"h			<b>COM:</b> 2.75 yds.							
		<b>Seat:</b> 20.5"w 20"d 17"-20"h			<b>Weight:</b> 60 lbs.			<b>COL:</b> 49.5 sq.ft.							
		<b>COM</b>	<b>COL</b>	<b>1</b>	<b>2</b>	<b>3</b>	<b>4</b>	<b>5</b>	<b>6</b>	<b>7</b>	<b>8</b>	<b>9</b>	<b>10</b>	<b>L1</b>	<b>L2</b>
	<b>523-2</b>	1113	1224	1190	1259	1327	1396	1465	1533	1602	1671	1740	1808	1909	2156
		<i>Tilt Swivel / Pneumatic Seat Height Adjustment</i>													
	<b>523-4</b>	1177	1295	1250	1319	1388	1456	1525	1594	1663	1731	1800	1869	1969	2216
		<i>Knee Tilt Swivel w/ Infinite Lock / Pneumatic Seat Height Adjustment</i>													

**DESCRIPTION:**

- Upholstery Frames: Plywood & Hardwood
- Seat / Back: High Density Polyurethane Foam
- Arms: High Density Polyurethane Foam Over Plywood & Hardwood
- Exposed Wood Upholstered Arms & Exposed Wood Open Arms Have Exposed Solid Maple Front Posts Finished In Lacquer
- All Arms Attached & Reinforced w/ Steel
- Black Arched Resin Base Standard
- 10 Year Warranty

**OPTIONS:**

Specify Exposed Wood Finish (See Page 6)  
Base & Caster Options Available (See Conrad Options Pages)

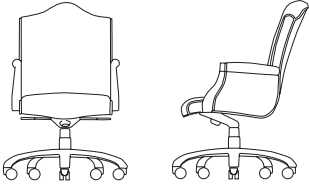
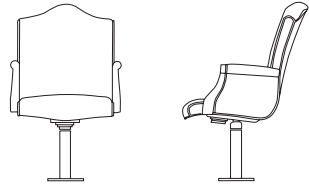
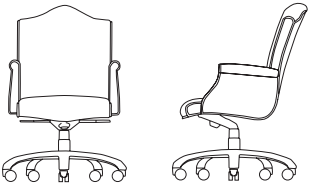
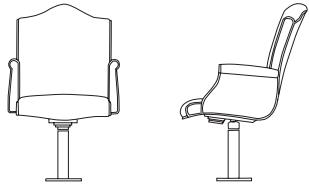
EXECUTIVE		ITEM #:	SPECIFICATIONS   GRADES   LIST PRICES:																					
	<b>LOW BACK CHAIR / EXPOSED WOOD UPHOLSTERED ARM</b>		<b>Overall:</b> 24.5"w 28"d 36"-39"h <b>Seat:</b> 20.5"w 20"d 17"-20"h			<b>Arm:</b> 25"-28"h <b>Weight:</b> 60 lbs.			<b>COM:</b> 3.25 yds. <b>COL:</b> 58.5 sq.ft.															
			<b>COM</b>	<b>COL</b>	<b>1</b>	<b>2</b>	<b>3</b>	<b>4</b>	<b>5</b>	<b>6</b>	<b>7</b>	<b>8</b>	<b>9</b>	<b>10</b>	<b>L1</b>	<b>L2</b>								
	<b>530-2</b>		1307	1437	1400	1483	1565	1648	1730	1813	1895	1978	2060	2143	2263	2560								
		<i>Tilt Swivel / Pneumatic Seat Height Adjustment</i>																						
		<b>530-4</b>	1365	1501	1455	1538	1620	1703	1785	1868	1950	2033	2115	2198	2318	2615								
		<i>Knee Tilt Swivel w/ Infinite Lock / Pneumatic Seat Height Adjustment</i>																						
	<b>LOW BACK JURY CHAIR / EXPOSED WOOD UPHOLSTERED ARM</b>		<b>Overall:</b> 24.5"w 28"d 36"-39"h <b>Seat:</b> 20.5"w 20"d 17"-20"h			<b>Arm:</b> 25"-28"h <b>Weight:</b> 60 lbs.			<b>COM:</b> 3.25 yds. <b>COL:</b> 58.5 sq.ft.															
			<b>COM</b>	<b>COL</b>	<b>1</b>	<b>2</b>	<b>3</b>	<b>4</b>	<b>5</b>	<b>6</b>	<b>7</b>	<b>8</b>	<b>9</b>	<b>10</b>	<b>L1</b>	<b>L2</b>								
	<b>530-5</b>		1516	1668	1598	1681	1763	1846	1928	2011	2093	2176	2258	2341	2461	2758								
		<i>Tilt Swivel / Pneumatic Seat Height Adjustment / Self-Centering 360° Rotation</i>																						
	<b>LOW BACK CHAIR / FULLY UPHOLSTERED ARM</b>		<b>Overall:</b> 26"w 28"d 36"-39"h <b>Seat:</b> 20.5"w 20"d 17"-20"h			<b>Arm:</b> 25"-28"h <b>Weight:</b> 60 lbs.			<b>COM:</b> 3.25 yds. <b>COL:</b> 58.5 sq.ft.															
			<b>COM</b>	<b>COL</b>	<b>1</b>	<b>2</b>	<b>3</b>	<b>4</b>	<b>5</b>	<b>6</b>	<b>7</b>	<b>8</b>	<b>9</b>	<b>10</b>	<b>L1</b>	<b>L2</b>								
	<b>531-2</b>		1189	1308	1289	1372	1454	1537	1619	1701	1784	1866	1949	2031	2156	2452								
		<i>Tilt Swivel / Pneumatic Seat Height Adjustment</i>																						
		<b>531-4</b>	1247	1372	1344	1427	1509	1591	1674	1756	1839	1921	2004	2086	2211	2507								
		<i>Knee Tilt Swivel w/ Infinite Lock / Pneumatic Seat Height Adjustment</i>																						
	<b>LOW BACK JURY CHAIR / FULLY UPHOLSTERED ARM</b>		<b>Overall:</b> 26"w 28"d 36"-39"h <b>Seat:</b> 20.5"w 20"d 17"-20"h			<b>Arm:</b> 25"-28"h <b>Weight:</b> 60 lbs.			<b>COM:</b> 3.25 yds. <b>COL:</b> 58.5 sq.ft.															
			<b>COM</b>	<b>COL</b>	<b>1</b>	<b>2</b>	<b>3</b>	<b>4</b>	<b>5</b>	<b>6</b>	<b>7</b>	<b>8</b>	<b>9</b>	<b>10</b>	<b>L1</b>	<b>L2</b>								
	<b>531-5</b>		1398	1538	1487	1570	1652	1734	1817	1899	1982	2064	2147	2229	2353	2650								
		<i>Tilt Swivel / Pneumatic Seat Height Adjustment / Self-Centering 360° Rotation</i>																						

**DESCRIPTION:**

- Upholstery Frames: Plywood & Hardwood
- Seat / Back: High Density Polyurethane Foam
- Arms: High Density Polyurethane Foam Over Plywood & Hardwood
- Exposed Wood Upholstered Arms & Exposed Wood Open Arms Have Exposed Solid Maple Front Posts Finished In Lacquer
- All Arms Attached & Reinforced w/ Steel
- Task Arm Has Black Urethane Pad & Adjusts Vertically
- Black Arched Resin Base Standard
- 10 Year Warranty

**OPTIONS:**

Specify Exposed Wood Finish (See Page 6)  
Base & Caster Options Available (See Conrad Options Pages)

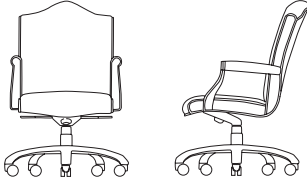
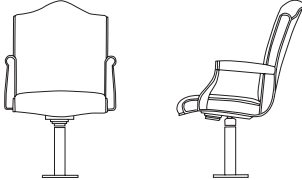
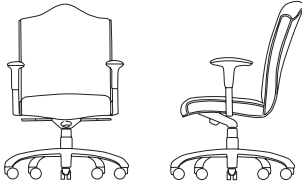
EXECUTIVE	ITEM #:	SPECIFICATIONS   GRADES   LIST PRICES:																	
	<b>LOW BACK CHAIR / EXPOSED WOOD OPEN ARM</b>  <b>532-2</b>  <b>532-4</b>	<b>Overall:</b> 25"w 28"d 36"-39"h <b>Seat:</b> 20.5"w 20"d 17"-20"h		<b>Arm:</b> 25"-28"h <b>Weight:</b> 60 lbs.		<b>COM:</b> 2.75 yds. <b>COL:</b> 49.5 sq.ft.													
		<b>COM</b>	<b>COL</b>	<b>1</b>	<b>2</b>	<b>3</b>	<b>4</b>	<b>5</b>	<b>6</b>	<b>7</b>	<b>8</b>	<b>9</b>	<b>10</b>	<b>L1</b>	<b>L2</b>				
		1230	1353	1301	1369	1438	1507	1576	1644	1713	1782	1850	1919	2024	2271				
		<i>Tilt Swivel / Pneumatic Seat Height Adjustment</i>																	
		<i>Knee Tilt Swivel w/ Infinite Lock / Pneumatic Seat Height Adjustment</i>																	
	<b>LOW BACK JURY CHAIR / EXPOSED WOOD OPEN ARM</b>  <b>532-5</b>	<b>Overall:</b> 25"w 28"d 36"-39"h <b>Seat:</b> 20.5"w 20"d 17"-20"h		<b>Arm:</b> 25"-28"h <b>Weight:</b> 60 lbs.		<b>COM:</b> 2.75 yds. <b>COL:</b> 49.5 sq.ft.													
		<b>COM</b>	<b>COL</b>	<b>1</b>	<b>2</b>	<b>3</b>	<b>4</b>	<b>5</b>	<b>6</b>	<b>7</b>	<b>8</b>	<b>9</b>	<b>10</b>	<b>L1</b>	<b>L2</b>				
		1440	1584	1499	1567	1636	1705	1774	1842	1911	1980	2048	2117	2222	2469				
		<i>Tilt Swivel / Pneumatic Seat Height Adjustment / Self-Centering 360° Rotation</i>																	
	<b>LOW BACK CHAIR / ADJUSTABLE TASK CHAIR</b>  <b>533-2</b>  <b>533-4</b>	<b>Overall:</b> 24"w 28"d 36"-39"h <b>Seat:</b> 20.5"w 20"d 17"-20"h		<b>Arm:</b> 25"-28"h <b>Weight:</b> 60 lbs.		<b>COM:</b> 2.75 yds. <b>COL:</b> 49.5 sq.ft.													
		<b>COM</b>	<b>COL</b>	<b>1</b>	<b>2</b>	<b>3</b>	<b>4</b>	<b>5</b>	<b>6</b>	<b>7</b>	<b>8</b>	<b>9</b>	<b>10</b>	<b>L1</b>	<b>L2</b>				
		1074	1181	1153	1222	1290	1359	1428	1497	1565	1634	1703	1771	1868	2115				
		<i>Tilt Swivel / Pneumatic Seat Height Adjustment</i>																	
		<i>Knee Tilt Swivel w/ Infinite Lock / Pneumatic Seat Height Adjustment</i>																	



**DESCRIPTION:**



- Exposed Frames: Solid Maple
- Seat: High Density Polyurethane Foam Over Sheet Webbing
- Back: High Density Polyurethane Foam Over Polypropylene Webbing
- Upholstered Arms: Polyurethane Foam Over Hardwood
- Stacking Chairs Stack (4) High
- 10 Year Warranty

**OPTIONS:**

- D350-6 Single Stacking Cart (Stacks 6 Chairs).....\$855
- D350-12 Double Stacing Cart (Stacks 12 Chairs).....\$1248
- ST-1 Wooden Horizontal Stretchers.....\$97
- BR-1 Wooden Horizontal Book Rack.....\$167

Specify Exposed Wood Finish (See Page 6)

Upholstered Arms May Be Specified In Vinyl / Leather (Contact Factory For Details)

GUEST	ITEM #:	SPECIFICATIONS   GRADES   LIST PRICES:													
<p>STACKING ARM CHAIR / UPHOLSTERED ARM</p> 	550	<i>Overall: 23"w 25"d 35"h</i>		<i>Arm: 25"h</i>					<i>COM: 1.75 yds.</i>						
		<i>Seat: 19.25"w 18"d 19"h</i>		<i>Weight: 25 lbs.</i>					<i>COL: 31.5 sq.ft.</i>						
		COM	COL	1	2	3	4	5	6	7	8	9	10	L1	L2
		1060	1166	1085	1126	1167	1209	1250	1291	1332	1373	1415	1456	1523	1672
		<i>Open Back</i>													
<p>CLOSED ARM SIDE CHAIR</p> 	560	<i>Overall: 23"w 25"d 35"h</i>		<i>Arm: 25"h</i>					<i>COM: 2.5 yds.</i>						
		<i>Seat: 19.25"w 18"d 19"h</i>		<i>Weight: 40 lbs.</i>					<i>COL: 45 sq.ft.</i>						
		COM	COL	1	2	3	4	5	6	7	8	9	10	L1	L2
		1240	1364	1296	1358	1420	1482	1544	1606	1667	1729	1791	1853	1948	2170
		<i>Closed Back</i>													
<p>OPEN ARM SIDE CHAIR / UPHOLSTERED TOP ARM / TUFTED BACK</p> 	571	<i>Overall: 23"w 25"d 35"h</i>		<i>Arm: 25"h</i>					<i>COM: 2 yds.</i>						
		<i>Seat: 19.25"w 18"d 19"h</i>		<i>Weight: 35 lbs.</i>					<i>COL: 36 sq.ft.</i>						
		COM	COL	1	2	3	4	5	6	7	8	9	10	L1	L2
		1071	1178	1108	1157	1205	1253	1301	1349	1397	1445	1493	1541	1623	1796
		<i>Closed Tufted Back</i>													

**DESCRIPTION:**







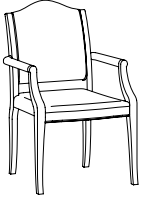

- Exposed Frames: Solid Maple
- Seat: High Density Polyurethane Foam Over Sheet Webbing
- Back: High Density Polyurethane Foam Over Polypropylene Webbing
- Upholstered Arms: Polyurethane Foam Over Hardwood
- 10 Year Warranty

**OPTIONS:**

- ST-1 Wooden Horizontal Stretchers.....\$97
  - BR-1 Wooden Horizontal Book Rack.....\$167
- Specify Exposed Wood Finish (See Page 6)  
 Upholstered Arms May Be Specified In Vinyl / Leather (Contact Factory For Details)

GUEST	ITEM #:	SPECIFICATIONS   GRADES   LIST PRICES:													
	572	<b>Overall:</b> 23"w 25"d 35"h		<b>Arm:</b> 25"h		<b>COM:</b> 1.75 yds.									
		<b>Seat:</b> 19.25"w 18"d 19"h		<b>Weight:</b> 35 lbs.		<b>COL:</b> 31.5 sq.ft.									
		<b>COM</b>	<b>COL</b>	<b>1</b>	<b>2</b>	<b>3</b>	<b>4</b>	<b>5</b>	<b>6</b>	<b>7</b>	<b>8</b>	<b>9</b>	<b>10</b>	<b>L1</b>	<b>L2</b>
		1008	1109	1036	1077	1118	1159	1201	1242	1283	1324	1365	1407	1465	1614
		<i>Open Back</i>													
	577	<b>Overall:</b> 23"w 25"d 35"h		<b>Arm:</b> 25"h		<b>COM:</b> 1.75 yds.									
		<b>Seat:</b> 19.25"w 18"d 19"h		<b>Weight:</b> 35 lbs.		<b>COL:</b> 31.5 sq.ft.									
		<b>COM</b>	<b>COL</b>	<b>1</b>	<b>2</b>	<b>3</b>	<b>4</b>	<b>5</b>	<b>6</b>	<b>7</b>	<b>8</b>	<b>9</b>	<b>10</b>	<b>L1</b>	<b>L2</b>
		1080	1188	1103	1145	1186	1227	1268	1310	1351	1392	1433	1474	1537	1685
		<i>Open Back</i>													

BASES	OPTION #:	SPECIFICATIONS   LIST PRICES   AVAILABILITY:								
TRANSITIONAL WOOD BASE	TWB	<p><b>Overall:</b> 25"w 25"d 5.5"h</p> <hr/> <p><b>\$193</b> Solid Hardwood Cap, Steel Reinforced 5 Prong Base With 55mm Black Dual Wheel Casters.</p> <p>OPTIONS:</p> <table border="0"> <tr> <td>Carpet Caster - 2" Metal Balls</td> <td>\$164 (Set Of 5)</td> </tr> <tr> <td>Antique Bronze Hooded Caster - 2" Rubber Ball</td> <td>\$151 (Set Of 5)</td> </tr> <tr> <td>Brass Hooded Black Caster - 2" Dual Wheels</td> <td>\$84 (Set Of 5)</td> </tr> </table> <p><b>Available:</b> Conrad Executive Seating</p>	Carpet Caster - 2" Metal Balls	\$164 (Set Of 5)	Antique Bronze Hooded Caster - 2" Rubber Ball	\$151 (Set Of 5)	Brass Hooded Black Caster - 2" Dual Wheels	\$84 (Set Of 5)		
Carpet Caster - 2" Metal Balls	\$164 (Set Of 5)									
Antique Bronze Hooded Caster - 2" Rubber Ball	\$151 (Set Of 5)									
Brass Hooded Black Caster - 2" Dual Wheels	\$84 (Set Of 5)									
CLASSIC WOOD BASE	CWB	<p><b>Overall:</b> 28"w 28"d 5"h</p> <hr/> <p><b>\$193</b> Solid Hardwood Cap, Steel Reinforced 5 Prong Base With 55mm Black Dual Wheel Casters.</p> <p>OPTIONS:</p> <table border="0"> <tr> <td>Carpet Caster - 2" Metal Balls</td> <td>\$164 (Set Of 5)</td> </tr> <tr> <td>Antique Bronze Hooded Caster - 2" Rubber Ball</td> <td>\$151 (Set Of 5)</td> </tr> <tr> <td>Brass Hooded Black Caster - 2" Dual Wheels</td> <td>\$84 (Set Of 5)</td> </tr> <tr> <td>Brass Scuff Plates</td> <td>\$105 (Set Of 5)</td> </tr> </table> <p><b>Available:</b> Conrad Executive Seating</p>	Carpet Caster - 2" Metal Balls	\$164 (Set Of 5)	Antique Bronze Hooded Caster - 2" Rubber Ball	\$151 (Set Of 5)	Brass Hooded Black Caster - 2" Dual Wheels	\$84 (Set Of 5)	Brass Scuff Plates	\$105 (Set Of 5)
Carpet Caster - 2" Metal Balls	\$164 (Set Of 5)									
Antique Bronze Hooded Caster - 2" Rubber Ball	\$151 (Set Of 5)									
Brass Hooded Black Caster - 2" Dual Wheels	\$84 (Set Of 5)									
Brass Scuff Plates	\$105 (Set Of 5)									
ARCHED RESIN BASE	ARB	<p><b>Overall:</b> 27"w 27"d 6.25"h</p> <hr/> <p>Standard - No Charge Black Reinforced Nylon 5 Prong Base With 55mm Black Dual Wheel Casters.</p> <p>OPTIONS:</p> <table border="0"> <tr> <td>Black Sculptured Glides</td> <td>No Upcharge</td> </tr> </table> <p><b>Available:</b> Conrad Executive Seating</p>	Black Sculptured Glides	No Upcharge						
Black Sculptured Glides	No Upcharge									
POLISHED ALUMINUM BASE	PAB	<p><b>Overall:</b> 26"w 26"d 8"h</p> <hr/> <p><b>\$98</b> Polished Aluminum 5 Prong Base With 55mm Black Dual Wheel Casters</p> <p>OPTIONS:</p> <table border="0"> <tr> <td>C4 Black Sculptured Glides</td> <td>No Upcharge (Set Of 5)</td> </tr> <tr> <td>C5 Polished Aluminum Hooded Casters</td> <td>\$105 (Set Of 5)</td> </tr> </table> <p><b>Available:</b> Conrad Executive Seating</p>	C4 Black Sculptured Glides	No Upcharge (Set Of 5)	C5 Polished Aluminum Hooded Casters	\$105 (Set Of 5)				
C4 Black Sculptured Glides	No Upcharge (Set Of 5)									
C5 Polished Aluminum Hooded Casters	\$105 (Set Of 5)									

BASES / CASTERS / SCUFF PLATES	OPTION #:	SPECIFICATIONS   LIST PRICES   AVAILABILITY:
<p><b>HIGH PROFILE BASE</b></p> 	<p><b>HPB</b></p>	<p><b>Overall:</b> 26"w 26"d 8"h</p> <hr/> <p>No Charge  <i>Black Reinforced Nylon 5 Prong Base With 55mm Black Dual Wheel Casters</i></p> <p><b>Available:</b> <i>Conrad Executive Seating</i></p>
<p><b>JURY BASE</b></p> 	<p><b>JRB</b></p>	<p><b>Overall:</b> 8.5" Diameter 3.75"h</p> <hr/> <p>\$198  <i>360° Rotation, Self Centering With Pneumatic Height Adjustment</i></p> <p>OPTIONS:      No Rotation</p> <p><b>Available:</b> <i>Conrad Executive Seating</i></p>
<p><b>CASTERS</b></p> <div style="display: flex; flex-wrap: wrap;"> <div style="width: 50%;">  <p>(C1) Carpet Caster - 2" Metal Balls</p> </div> <div style="width: 50%;">  <p>(C2) Antique Bronze Hooded Caster - 2" Rubber Ball</p> </div> <div style="width: 50%;">  <p>(C3) Brass Hooded Black Caster - 2" Dual Wheels</p> </div> <div style="width: 50%;">  <p>(C4) Black Sculptured Glide - 2" Flat Bottom Glide</p> </div> <div style="width: 50%;">  <p>(C5) Polished Aluminum Caster - 2" Dual Wheels</p> </div> </div>	<p><b>C1</b> <b>C2</b> <b>C3</b> <b>C4</b> <b>C5</b></p>	<p><b>Overall:</b> 2"h</p> <hr/> <p>\$164 (Set Of 5)  <i>Carpet Caster - 2" Metal Balls (Additional Finishes Available)</i></p> <p>\$151 (Set Of 5)  <i>Antique Bronze Hooded Caster - 2" Rubber Ball (Additional Finishes Available)</i></p> <p>\$84 (Set Of 5)  <i>Brass Hooded Black Caster - 2" Dual Wheels (Additional Finishes Available)</i></p> <p>No Charge (Set Of 5)  <i>Black Sculptured Glide - 2" Flat Bottom Glide</i></p> <p>\$105 (Set Of 5)  <i>Polished Aluminum Hooded Caster - 2" Dual Wheels</i></p> <p><b>Available:</b> <i>Conrad Executive Seating</i></p>
<p><b>SCUFF PLATES</b></p> 	<p><b>SP</b></p>	<p><b>Overall:</b> 1"w 4"d</p> <hr/> <p>\$105 (Set Of 5)  <i>(Specify Brass Or Pewter)</i></p> <p><b>Available:</b> <i>Classic Base Only</i></p>

STRETCHERS / BOOK RACK / STACKING / COVERS	OPTION #:	SPECIFICATIONS   LIST PRICES   AVAILABILITY:
<p><b>STRETCHERS</b></p> 	<p><b>ST-1</b></p> <p><i>Overall: 23"w 25"d 1"h</i></p> <p>\$97 <i>Wooden Horizontal Stretchers</i></p> <p><i>Available: Conrad Guest Chairs</i></p>	
<p><b>BOOK RACK</b></p> 	<p><b>BR-1</b></p> <p><i>Overall: 23"w 25"d 1"h</i></p> <p>\$167 <i>Wooden Horizontal Book Rack</i></p> <p><i>Available: Conrad Guest Chairs</i></p>	
<p><b>STACKING CARTS</b></p>  <p>Single Stacking</p> <p>Double Stacking</p>	<p><i>Overall: 26"w 37"d 12"h (Single Stacking Cart) / 37"w 50"d 12"h (Double Stacking Cart)</i></p> <p><b>D350-6</b> \$855 <i>Single Stacking Cart (Stacks 6 Chairs)</i></p> <p><b>D350-12</b> \$1248 <i>Double Stacking Cart (Stacks 12 Chairs)</i></p> <p><i>Available: Conrad Stacking Chairs</i></p>	
<p><b>CONTRASTING COVERS</b></p> 	<p><i>Overall: n/a</i></p> <p><b>CC</b> \$129</p> <p><i>NOTE: If Two Or More Upholsteries Or Leathers Are Used On Any Piece Of Furniture, Then A Contrast Charge Will Apply Per Order. When Using Trinity Upholstery, The Higher Priced Upholstery Grade Will Be Used In Pricing, Unless It's Trinity Leather With Fabric Contrast Welt, Or COM With Trinity Contrast Welt, Then Contact Customer Service For Pricing.</i></p> <p><i>Available: Conrad Collection</i></p>	

# Classic

---

EXECUTIVE / GUEST / LOUNGE / BENCHES / TABLES

Effective: August 1, 2022

T R I N I T Y

**Date:**

**Page:**

**Modification:**

**Description:**

---

**DESCRIPTION:**

- Upholstery Frames: Hardwood & Plywood
- Seat: High Density Polyurethane Foam Over Sheet Webbing
- Back: High Density Polyurethane Foam Over Polypropylene Webbing
- Upholstered Arms: Exposed Solid Cherry Front Posts w/ Rosette Medallions In Lacquer Finish
- Classic Base Standard
- 10 Year Warranty

**OPTIONS:**

- IL Inflatable Lumbar (#700, 701, 710, & 711 Models).....\$271
- CCM Concentric Arm Medallion (Please Specify)..... N/C

Specify Exposed Wood Finish (See Page 6)  
Base & Caster Options Available (See Classic Options Pages)

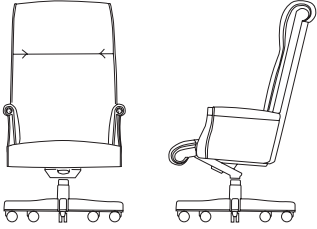
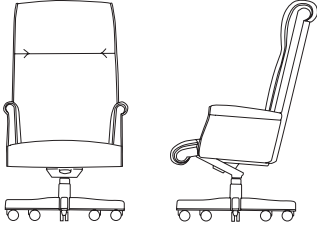
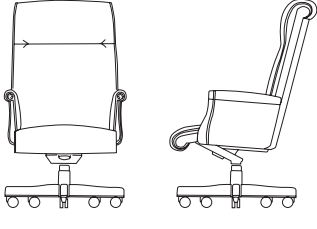
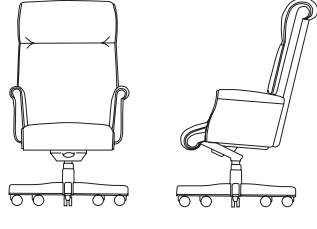
EXECUTIVE		ITEM #:	SPECIFICATIONS   GRADES   LIST PRICES:														
		<b>HIGH BACK JUDGES CHAIR / EXPOSED WOOD UPHOLSTERED ARM</b>	<b>Overall:</b> 27.5"w 31.5"d 50"-53"h <b>Seat:</b> 21"w 19"d 18.5"-21.5"h			<b>Arm:</b> 26"-29"h <b>Weight:</b> 85 lbs.			<b>COM:</b> 5.25 yds. (700-2 / 700-4) / 5.5 yds. (700-2X) <b>COL:</b> 94.5 sq.ft. (700-2 / 700-4) / 99 sq.ft. (700-2X)								
			<b>COM</b>	<b>COL</b>	<b>1</b>	<b>2</b>	<b>3</b>	<b>4</b>	<b>5</b>	<b>6</b>	<b>7</b>	<b>8</b>	<b>9</b>	<b>10</b>	<b>L1</b>	<b>L2</b>	
			<b>700-2</b>	2058	2264	2221	2358	2495	2633	2770	2908	3045	3183	3320	3458	3646	4141
			Tilt Swivel w/ Lock / Pneumatic Seat Height Adjustment														
<b>700-4</b>	2110	2321	2270	2407	2545	2682	2820	2957	3095	3232	3370	3507	3695	4190			
Knee Tilt Swivel w/ Infinite Lock / Pneumatic Seat Height Adjustment																	
<b>700-4X</b>	2128	2340	2300	2445	2589	2733	2877	3022	3166	3310	3455	3599	3792	4312			
Big & Tall: Knee Tilt Swivel w/ Infinite Lock / Pneumatic Seat Height Adjustment / Overall Size Increased: W + 1.5"																	
		<b>HIGH BACK JUDGES CHAIR / FULLY UPHOLSTERED ARM</b>	<b>Overall:</b> 27.5"w 31.5"d 50"-53"h <b>Seat:</b> 21"w 19"d 18.5"-21.5"h			<b>Arm:</b> 26"-29"h <b>Weight:</b> 85 lbs.			<b>COM:</b> 5.25 yds. (701-2 / 701-4) / 5.5 yds. (701-2X) <b>COL:</b> 94.5 sq.ft. (701-2 / 701-4) / 99 sq.ft. (701-2X)								
			<b>COM</b>	<b>COL</b>	<b>1</b>	<b>2</b>	<b>3</b>	<b>4</b>	<b>5</b>	<b>6</b>	<b>7</b>	<b>8</b>	<b>9</b>	<b>10</b>	<b>L1</b>	<b>L2</b>	
			<b>701-2</b>	1872	2059	2045	2182	2319	2457	2594	2732	2869	3007	3144	3282	3473	3967
			Tilt Swivel w/ Lock / Pneumatic Seat Height Adjustment														
<b>701-4</b>	1918	2110	2089	2226	2363	2501	2638	2776	2913	3051	3188	3326	3517	4011			
Knee Tilt Swivel w/ Infinite Lock / Pneumatic Seat Height Adjustment																	
<b>701-4X</b>	1982	2180	2163	2307	2451	2596	2740	2884	3029	3173	3317	3462	3648	4165			
Big & Tall: Knee Tilt Swivel w/ Infinite Lock / Pneumatic Seat Height Adjustment / Overall Size Increased: W + 1.5"																	
		<b>MEDIUM BACK CHAIR / EXPOSED WOOD UPHOLSTERED ARM</b>	<b>Overall:</b> 27.5"w 31.5"d 46"-49"h <b>Seat:</b> 21"w 19"d 18.5"-21.5"h			<b>Arm:</b> 26"-29"h <b>Weight:</b> 70 lbs.			<b>COM:</b> 5.25 yds. <b>COL:</b> 94.5 sq.ft.								
			<b>COM</b>	<b>COL</b>	<b>1</b>	<b>2</b>	<b>3</b>	<b>4</b>	<b>5</b>	<b>6</b>	<b>7</b>	<b>8</b>	<b>9</b>	<b>10</b>	<b>L1</b>	<b>L2</b>	
			<b>710-2</b>	2019	2221	2184	2321	2459	2596	2734	2871	3009	3146	3283	3421	3608	4103
			Tilt Swivel w/ Lock / Pneumatic Seat Height Adjustment														
<b>710-4</b>	2060	2266	2222	2360	2497	2635	2772	2910	3047	3184	3322	3459	3647	4142			
Knee Tilt Swivel w/ Infinite Lock / Pneumatic Seat Height Adjustment																	
		<b>MEDIUM BACK CHAIR / FULLY UPHOLSTERED ARM</b>	<b>Overall:</b> 27.5"w 31.5"d 46"-49"h <b>Seat:</b> 21"w 19"d 18.5"-21.5"h			<b>Arm:</b> 26"-29"h <b>Weight:</b> 70 lbs.			<b>COM:</b> 5.25 yds. <b>COL:</b> 94.5 sq.ft.								
			<b>COM</b>	<b>COL</b>	<b>1</b>	<b>2</b>	<b>3</b>	<b>4</b>	<b>5</b>	<b>6</b>	<b>7</b>	<b>8</b>	<b>9</b>	<b>10</b>	<b>L1</b>	<b>L2</b>	
			<b>711-2</b>	1821	2003	1997	2134	2271	2409	2546	2684	2821	2959	3096	3234	3424	3919
			Tilt Swivel w/ Lock / Pneumatic Seat Height Adjustment														
<b>711-4</b>	1879	2067	2052	2189	2326	2464	2601	2739	2876	3014	3151	3289	3479	3974			
Knee Tilt Swivel w/ Infinite Lock / Pneumatic Seat Height Adjustment																	



**DESCRIPTION:**

- Upholstery Frames: Hardwood & Plywood
- Seat: High Density Polyurethane Foam Over Sheet Webbing
- Back: High Density Polyurethane Foam Over Polypropylene Webbing
- Upholstered Arms: Exposed Solid Cherry Front Posts w/ Rosette Medallions In Lacquer Finish
- Classic Base Standard
- 10 Year Warranty

**OPTIONS:**

CCM Concentric Arm Medallion (Please Specify)..... N/C  
 Specify Exposed Wood Finish (See Page 6)  
 Base & Caster Options Available (See Classic Options Pages)

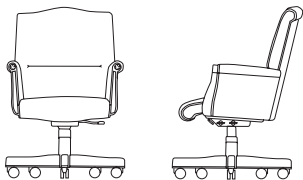
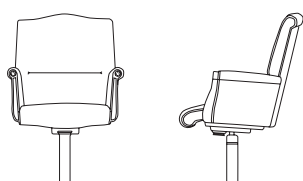
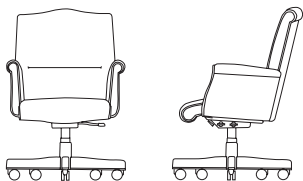
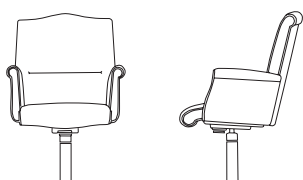
EXECUTIVE		ITEM #:	SPECIFICATIONS   GRADES   LIST PRICES:												
<b>LOW BACK CHAIR / EXPOSED WOOD UPHOLSTERED ARM</b>  			<b>Overall:</b> 25.5"w 29"d 36"-39"h			<b>Arm:</b> 26"-29"h			<b>COM:</b> 3.25 yds.						
			<b>Seat:</b> 21"w 19"d 18.5"-21.5"h			<b>Weight:</b> 60 lbs.			<b>COL:</b> 58.5 sq.ft.						
			<b>COM</b>	<b>COL</b>	<b>1</b>	<b>2</b>	<b>3</b>	<b>4</b>	<b>5</b>	<b>6</b>	<b>7</b>	<b>8</b>	<b>9</b>	<b>10</b>	<b>L1</b>
	<b>720-2</b>	1678	1846	1752	1834	1916	1999	2081	2164	2246	2329	2411	2494	2617	2914
		<i>Tilt Swivel w/ Lock / Pneumatic Seat Height Adjustment</i>													
	<b>720-4</b>	1730	1904	1801	1883	1966	2048	2131	2213	2296	2378	2461	2543	2667	2964
		<i>Knee Tilt Swivel w/ Infinite Lock / Pneumatic Seat Height Adjustment</i>													
<b>LOW BACK JURY CHAIR / EXPOSED WOOD UPHOLSTERED ARM</b>  			<b>Overall:</b> 25.5"w 29"d 36"-39"h			<b>Arm:</b> 26"-29"h			<b>COM:</b> 3.25 yds.						
			<b>Seat:</b> 21"w 19"d 18.5"-21.5"h			<b>Weight:</b> 60 lbs.			<b>COL:</b> 58.5 sq.ft.						
			<b>COM</b>	<b>COL</b>	<b>1</b>	<b>2</b>	<b>3</b>	<b>4</b>	<b>5</b>	<b>6</b>	<b>7</b>	<b>8</b>	<b>9</b>	<b>10</b>	<b>L1</b>
	<b>720-5</b>	1690	1859	1763	1845	1927	2010	2092	2175	2257	2340	2422	2505	2628	2925
		<i>Tilt Swivel / Pneumatic Seat Height Adjustment / Self-Centering 360° Rotation</i>													
<b>LOW BACK CHAIR / FULLY UPHOLSTERED ARM</b>  			<b>Overall:</b> 25.5"w 29"d 36"-39"h			<b>Arm:</b> 26"-29"h			<b>COM:</b> 3.5 yds.						
			<b>Seat:</b> 21"w 19"d 18.5"-21.5"h			<b>Weight:</b> 60 lbs.			<b>COL:</b> 63 sq.ft.						
			<b>COM</b>	<b>COL</b>	<b>1</b>	<b>2</b>	<b>3</b>	<b>4</b>	<b>5</b>	<b>6</b>	<b>7</b>	<b>8</b>	<b>9</b>	<b>10</b>	<b>L1</b>
	<b>721-2</b>	1487	1636	1585	1674	1764	1853	1942	2032	2121	2210	2300	2389	2521	2843
		<i>Tilt Swivel w/ Lock / Pneumatic Seat Height Adjustment</i>													
	<b>721-4</b>	1540	1694	1634	1724	1813	1902	1992	2081	2171	2260	2349	2439	2571	2893
		<i>Knee Tilt Swivel w/ Infinite Lock / Pneumatic Seat Height Adjustment</i>													
<b>LOW BACK JURY CHAIR / FULLY UPHOLSTERED ARM</b>  			<b>Overall:</b> 25.5"w 29"d 36"-39"h			<b>Arm:</b> 26"-29"h			<b>COM:</b> 3.5 yds.						
			<b>Seat:</b> 21"w 19"d 18.5"-21.5"h			<b>Weight:</b> 60 lbs.			<b>COL:</b> 63 sq.ft.						
			<b>COM</b>	<b>COL</b>	<b>1</b>	<b>2</b>	<b>3</b>	<b>4</b>	<b>5</b>	<b>6</b>	<b>7</b>	<b>8</b>	<b>9</b>	<b>10</b>	<b>L1</b>
	<b>721-5</b>	1499	1649	1596	1685	1775	1864	1953	2043	2132	2221	2311	2400	2532	2854
		<i>Tilt Swivel / Pneumatic Seat Height Adjustment / Self-Centering 360° Rotation</i>													

**DESCRIPTION:**

- Upholstery Frames: Hardwood & Plywood
- Seat: High Density Polyurethane Foam Over Sheet Webbing
- Back: High Density Polyurethane Foam Over Polypropylene Webbing
- Upholstered Arms: Exposed Solid Cherry Front Posts w/ Rosette Medallions In Lacquer Finish
- Classic Base Standard
- 10 Year Warranty

**OPTIONS:**

CCM Concentric Arm Medallion (Please Specify)..... N/C  
 Specify Exposed Wood Finish (See Page 6)  
 Base & Caster Options Available (See Classic Options Pages)

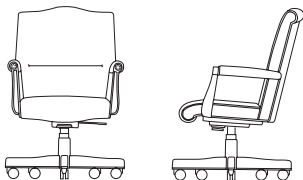
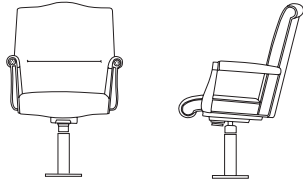
EXECUTIVE		ITEM #:	SPECIFICATIONS   GRADES   LIST PRICES:												
<b>LOW BACK CHAIR / OPEN WOOD UPHOLSTERED ARM</b>  			<b>Overall:</b> 25.5"w 29"d 36"-39"h			<b>Arm:</b> 26"-29"h			<b>COM:</b> 3 yds.						
			<b>Seat:</b> 21"w 19"d 18.5"-21.5"h			<b>Weight:</b> 60 lbs.			<b>COL:</b> 54 sq.ft.						
			<b>COM</b>	<b>COL</b>	<b>1</b>	<b>2</b>	<b>3</b>	<b>4</b>	<b>5</b>	<b>6</b>	<b>7</b>	<b>8</b>	<b>9</b>	<b>10</b>	<b>L1</b>
	<b>722-2</b>	1666	1832	1726	1802	1877	1953	2028	2104	2180	2255	2331	2406	2514	2786
			<i>Tilt Swivel w/ Lock / Pneumatic Seat Height Adjustment</i>												
	<b>722-4</b>	1724	1896	1781	1857	1932	2008	2083	2159	2235	2310	2386	2461	2569	2841
			<i>Knee Tilt Swivel w/ Infinite Lock / Pneumatic Seat Height Adjustment</i>												
<b>LOW BACK JURY CHAIR / EXPOSED WOOD UPHOLSTERED ARM</b>  			<b>Overall:</b> 25.5"w 29"d 36"-39"h			<b>Arm:</b> 26"-29"h			<b>COM:</b> 3 yds.						
			<b>Seat:</b> 21"w 19"d 18.5"-21.5"h			<b>Weight:</b> 60 lbs.			<b>COL:</b> 54 sq.ft.						
			<b>COM</b>	<b>COL</b>	<b>1</b>	<b>2</b>	<b>3</b>	<b>4</b>	<b>5</b>	<b>6</b>	<b>7</b>	<b>8</b>	<b>9</b>	<b>10</b>	<b>L1</b>
	<b>722-5</b>	1677	1845	1737	1813	1888	1964	2039	2115	2191	2266	2342	2417	2525	2797
			<i>Tilt Swivel / Pneumatic Seat Height Adjustment / Self-Centering 360° Rotation</i>												

**DESCRIPTION:**

- Upholstery Frames: Plywood
- Seat / Back: High Density Polyurethane Foam Over Plywood
- Black Urethane Arm Caps: 3" Vertical Adjustment
- Back Adjusts 4" Vertically
- Tapered Resin Base Standard
- 10 Year Warranty

**OPTIONS:**

- SCA Solid Cherry Arms.....\$186
- Specify Exposed Wood Finish (See Page 6)
- Base & Caster Options Available (See Classic Options Pages)

**NOTE:**

**Resin To Wood Base (730, 740, 750 Task Chairs Only)..... \$171 Upcharge**

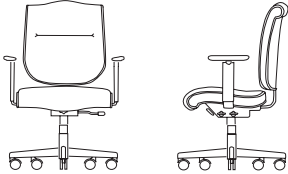
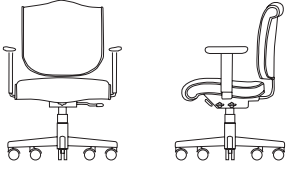
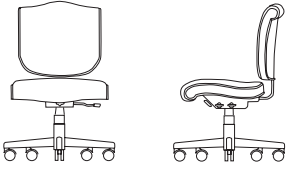

MANAGERIAL / TASK	ITEM #:	SPECIFICATIONS   GRADES   LIST PRICES:													
	730-3	<b>Overall:</b> 26.5"w 27.5"d 37.5"-43"h		<b>Arm:</b> 24"-29.5"h		<b>COM:</b> 3 yds.									
		<b>Seat:</b> 20.5"w 19.5"d 18.5"-24"h		<b>Weight:</b> 70 lbs.		<b>COL:</b> 54 sq.ft.									
		<b>COM</b>	<b>COL</b>	<b>1</b>	<b>2</b>	<b>3</b>	<b>4</b>	<b>5</b>	<b>6</b>	<b>7</b>	<b>8</b>	<b>9</b>	<b>10</b>	<b>L1</b>	<b>L2</b>
		1391	1530	1466	1542	1617	1693	1768	1844	1920	1995	2071	2146	2252	2524
<i>Tilt Swivel w/ Forward Tilt &amp; Infinite Lock / Vertical Adj. Arms / Height Adj. Articulating Back / Pneumatic Seat Height Adj.</i>															
	740-3	<b>Overall:</b> 26.5"w 27.5"d 34"-39.5"h		<b>Arm:</b> 24"-29.5"h		<b>COM:</b> 3 yds.									
		<b>Seat:</b> 20.5"w 19.5"d 18.5"-24"h		<b>Weight:</b> 70 lbs.		<b>COL:</b> 54 sq.ft.									
		<b>COM</b>	<b>COL</b>	<b>1</b>	<b>2</b>	<b>3</b>	<b>4</b>	<b>5</b>	<b>6</b>	<b>7</b>	<b>8</b>	<b>9</b>	<b>10</b>	<b>L1</b>	<b>L2</b>
		1337	1471	1415	1491	1566	1642	1718	1793	1869	1944	2020	2096	2192	2464
<i>Tilt Swivel w/ Forward Tilt &amp; Infinite Lock / Vertical Adj. Arms / Height Adj. Articulating Back / Pneumatic Seat Height Adj.</i>															
	750-3	<b>Overall:</b> 20.5"w 27.5"d 34"-39.5"h		<b>Arm:</b> n/a		<b>COM:</b> 3 yds.									
		<b>Seat:</b> 20.5"w 19.5"d 18.5"-24"h		<b>Weight:</b> 70 lbs.		<b>COL:</b> 54 sq.ft.									
		<b>COM</b>	<b>COL</b>	<b>1</b>	<b>2</b>	<b>3</b>	<b>4</b>	<b>5</b>	<b>6</b>	<b>7</b>	<b>8</b>	<b>9</b>	<b>10</b>	<b>L1</b>	<b>L2</b>
		1209	1330	1294	1370	1445	1521	1597	1672	1748	1823	1899	1975	2071	2343
<i>Tilt Swivel w/ Forward Tilt &amp; Infinite Lock / Pneumatic Seat Height Adj.</i>															

**DESCRIPTION:**

- Exposed Frames: Solid Cherry
- Seat: High Density Polyurethane Foam Over Sheet Webbing
- Back: High Density Polypropylene Webbing
- Fully Upholstered Arms: High Density Polyurethane Foam Over Hardwood
- Rosette Arm & Back Post Medallions Standard
- 10 Year Warranty

**OPTIONS:**

CCM Concentric Arm Medalion (Please Specify)..... N/C  
 Specify Exposed Wood Finish (See Page 6)



GUEST	ITEM #:	SPECIFICATIONS   GRADES   LIST PRICES:													
<b>CLOSED ARM SIDE CHAIR</b>  	760	<b>Overall:</b> 23.75"w 25.5"d 33.5"h		<b>Arm:</b> 26"h		<b>COM:</b> 2.75 yds.									
		<b>Seat:</b> 20.25"w 18.5"d 19"h		<b>Weight:</b> 38 lbs.		<b>COL:</b> 49.5 sq.ft.									
		<b>COM</b>	<b>COL</b>	<b>1</b>	<b>2</b>	<b>3</b>	<b>4</b>	<b>5</b>	<b>6</b>	<b>7</b>	<b>8</b>	<b>9</b>	<b>10</b>	<b>L1</b>	<b>L2</b>
		1416	1558	1476	1545	1614	1682	1751	1820	1889	1957	2026	2095	2193	2440
		<i>Closed Back</i>													
<b>OPEN ARM SIDE CHAIR</b>  	770	<b>Overall:</b> 23.75"w 25.5"d 33.5"h		<b>Arm:</b> 26"h		<b>COM:</b> 2.5 yds.									
		<b>Seat:</b> 20.25"w 18.5"d 19"h		<b>Weight:</b> 32 lbs.		<b>COL:</b> 45 sq.ft.									
		<b>COM</b>	<b>COL</b>	<b>1</b>	<b>2</b>	<b>3</b>	<b>4</b>	<b>5</b>	<b>6</b>	<b>7</b>	<b>8</b>	<b>9</b>	<b>10</b>	<b>L1</b>	<b>L2</b>
		1381	1519	1429	1491	1553	1615	1677	1738	1800	1862	1924	1986	2069	2292
		<i>Open Back</i>													
<b>ARMLESS SIDE CHAIR</b>  	780	<b>Overall:</b> 23"w 25.5"d 33.5"h		<b>Arm:</b> n/a		<b>COM:</b> 2.5 yds.									
		<b>Seat:</b> 22"w 18.5"d 19"h		<b>Weight:</b> 30 lbs.		<b>COL:</b> 45 sq.ft.									
		<b>COM</b>	<b>COL</b>	<b>1</b>	<b>2</b>	<b>3</b>	<b>4</b>	<b>5</b>	<b>6</b>	<b>7</b>	<b>8</b>	<b>9</b>	<b>10</b>	<b>L1</b>	<b>L2</b>
		953	1048	1024	1086	1148	1210	1272	1334	1396	1457	1519	1581	1651	1874
		<i>Open Back</i>													

**DESCRIPTION:**

- Upholstery Frames: Plywood & Hardwood
- Seat: High Density Polyurethane Foam Over Sheet Webbing
- Tight Seat: High Density Polyurethane Foam
- Back: High Density Polyurethane Foam Over Polypropylene Webbing
- Loose Cushions: High Density Polydacron
- Leather / Vinyl Cushions Are Not Reversible
- Exposed Wood Legs: Solid Cherry
- 10 Year Warranty

**OPTIONS:**

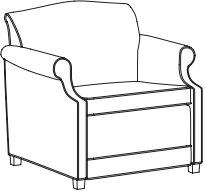
- PM1 Power/Data Module (1-Power / 1-USB 2 Port Simplex Charger) .....\$836
- Feather Down & Polyester Pillows Available (See Page 5)  
Specify Exposed Wood Finish (See Page 6)

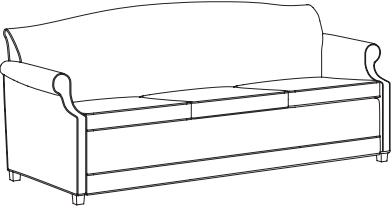
LOUNGE		ITEM #:	SPECIFICATIONS   GRADES   LIST PRICES:												
	790-C	<b>Overall:</b> 33"w 33.5"d 34"h	<b>Arm:</b> 24.5"h	<b>COM:</b> 5.75 yds. (790-P) / 6.75 yds. (790-C)											
		<b>Seat:</b> 22"w 20.5"d 18.5"h	<b>Weight:</b> 65 lbs.	<b>COL:</b> 103.5 sq.ft. (790-P) / 121.5 sq.ft. (790-C)											
		<b>COM</b>	<b>COL</b>	<b>1</b>	<b>2</b>	<b>3</b>	<b>4</b>	<b>5</b>	<b>6</b>	<b>7</b>	<b>8</b>	<b>9</b>	<b>10</b>	<b>L1</b>	<b>L2</b>
		1732	1905	1995	2173	2352	2531	2710	2888	3067	3246	3424	3603	3819	4463
<i>Reversible Loose Seat Cushion / Tight Back</i>															
	793-C	<b>Overall:</b> 59"w 33.5"d 34"h	<b>Arm:</b> 24.5"h	<b>COM:</b> 7.5 yds. (793-P) / 9.75 yds. (793-C)											
		<b>Seat:</b> 48"w 20.5"d 18.5"h	<b>Weight:</b> 100 lbs.	<b>COL:</b> 135 sq.ft. (793-P) / 175.5 sq.ft. (793-C)											
		<b>COM</b>	<b>COL</b>	<b>1</b>	<b>2</b>	<b>3</b>	<b>4</b>	<b>5</b>	<b>6</b>	<b>7</b>	<b>8</b>	<b>9</b>	<b>10</b>	<b>L1</b>	<b>L2</b>
		2373	2610	2766	3027	3288	3549	3810	4071	4333	4594	4855	5116	5413	6353
<i>Reversible Loose Seat Cushions / Tight Back</i>															
	796-C	<b>Overall:</b> 80"w 33.5"d 34"h	<b>Arm:</b> 24.5"h	<b>COM:</b> 10 yds. (796-P) / 11.25 yds. (796-C)											
		<b>Seat:</b> 69"w 20.5"d 18.5"h	<b>Weight:</b> 158 lbs.	<b>COL:</b> 180 sq.ft. (796-P) / 202.5 sq.ft. (796-C)											
		<b>COM</b>	<b>COL</b>	<b>1</b>	<b>2</b>	<b>3</b>	<b>4</b>	<b>5</b>	<b>6</b>	<b>7</b>	<b>8</b>	<b>9</b>	<b>10</b>	<b>L1</b>	<b>L2</b>
		2943	3237	3387	3690	3992	4294	4597	4899	5201	5504	5806	6109	6464	7552
<i>Reversible Loose Seat Cushion / Tight Back</i>															

**DESCRIPTION:**



- Upholstery Seat: High Density Polyurethane Foam Over Sheet Webbing
- Solid Cherry Legs & Apron
- Rosette Medallions Standard
- 10 Year Warranty

**OPTIONS:**

CCM Concentric Circle Medallion (Please Specify)..... N/C

Specify Exposed Wood Finish (See Page 6)

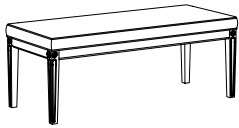
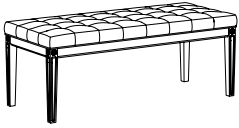
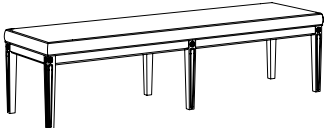
**Note: Trinity Must Approve Specific Fabrics / Leathers Used For Tufting.**

BENCHES		ITEM #:	SPECIFICATIONS   GRADES   LIST PRICES:													
 <p>748-P</p>  <p>748-T</p>		<b>Overall:</b> 48"w 20"d 19"h <b>Seat:</b> 19"h  <b>Arm:</b> n/a <b>Weight:</b> 48 lbs.  <b>COM:</b> 2.25 yds. (748-P / 748-T) <b>COL:</b> 40.5 sq.ft. (748-P / 748-T)														
			<b>COM</b>	<b>COL</b>	<b>1</b>	<b>2</b>	<b>3</b>	<b>4</b>	<b>5</b>	<b>6</b>	<b>7</b>	<b>8</b>	<b>9</b>	<b>10</b>	<b>L1</b>	<b>L2</b>
			932	1025	991	1046	1101	1156	1211	1266	1321	1376	1431	1486	1555	1753
			<i>Plain Upholstered</i>													
			1325	1457	1362	1417	1472	1527	1582	1637	1692	1747	1802	1857	1978	2176
			<i>Button Tufted Upholstered</i>													
 <p>772-P</p>  <p>772-T</p>		<b>Overall:</b> 72"w 20"d 19"h <b>Seat:</b> 19"h  <b>Arm:</b> n/a <b>Weight:</b> 60 lbs.  <b>COM:</b> 3 yds. (772-P) / 2.5 yds. (772-T) <b>COL:</b> 54 sq.ft. (772-P) / 45 sq.ft. (772-T)														
			<b>COM</b>	<b>COL</b>	<b>1</b>	<b>2</b>	<b>3</b>	<b>4</b>	<b>5</b>	<b>6</b>	<b>7</b>	<b>8</b>	<b>9</b>	<b>10</b>	<b>L1</b>	<b>L2</b>
			1401	1541	1437	1510	1584	1657	1731	1804	1878	1952	2025	2099	2195	2459
			<i>Plain Upholstered</i>													
			1806	1987	1831	1893	1955	2017	2079	2141	2202	2264	2326	2388	2541	2763
			<i>Button Tufted Upholstered</i>													

**DESCRIPTION:**



- Solid Cherry Legs & Apron
- Cherry Veneer Top Is Banded With Solid Cherry / Ebony Inlay Top
- Rosette Medallions Standard
- 10 Year Warranty

**OPTIONS:**

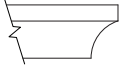
CCM Concentric Circle Medallion (Please Specify)..... N/C  
 Specify Exposed Wood Finish (See Page 6)

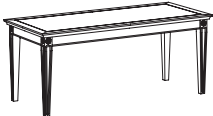

Classic Edge Profile Standard



TABLES		ITEM #:	SPECIFICATIONS   GRADES   LIST PRICES:													
<p>END TABLE</p> 			<p><b>Overall:</b> 20"w 24"d 23"h  <b>Weight:</b> 40 lbs.</p>													
			COM	COL	1	2	3	4	5	6	7	8	9	10	L1	L2
	7020-L															
			<p>940 Laminate Top</p>													
			<p>1091 Veneer Top / Ebony Inlay</p>													
<p>COFFEE TABLE</p> 			<p><b>Overall:</b> 42"w 20"d 18"h  <b>Weight:</b> 42 lbs.</p>													
			COM	COL	1	2	3	4	5	6	7	8	9	10	L1	L2
	7042-L															
			<p>1288 Laminate Top</p>													
			<p>1538 Veneer Top / Ebony Inlay</p>													
<p>SOFA TABLE</p> 			<p><b>Overall:</b> 48"w 18"d 30"h  <b>Weight:</b> 53 lbs.</p>													
			COM	COL	1	2	3	4	5	6	7	8	9	10	L1	L2
	7048-L															
			<p>1409 Laminate Top</p>													
			<p>1676 Veneer Top / Ebony Inlay</p>													

BASES	OPTION #:	SPECIFICATIONS   LIST PRICES   AVAILABILITY:								
TRANSITIONAL WOOD BASE		<b>Overall:</b> 25"w 25"d 5.5"h								
	<b>TWB</b>	<p>No Charge                      \$193 Upcharge From Resin To Wood Base (730, 740, 750 Task Chairs Only)  <i>Solid Hardwood Cap, Steel Reinforced 5 Prong Base With 55mm Black Dual Wheel Casters.</i></p> <p>OPTIONS:</p> <table border="0"> <tr> <td>Carpet Caster - 2" Metal Balls</td> <td>\$164 (Set Of 5)</td> </tr> <tr> <td>Antique Bronze Hooded Caster - 2" Rubber Ball</td> <td>\$151 (Set Of 5)</td> </tr> <tr> <td>Brass Hooded Black Caster - 2" Dual Wheels</td> <td>\$84 (Set Of 5)</td> </tr> </table> <p><b>Available:</b> <i>Classic Executive Seating</i></p>	Carpet Caster - 2" Metal Balls	\$164 (Set Of 5)	Antique Bronze Hooded Caster - 2" Rubber Ball	\$151 (Set Of 5)	Brass Hooded Black Caster - 2" Dual Wheels	\$84 (Set Of 5)		
Carpet Caster - 2" Metal Balls	\$164 (Set Of 5)									
Antique Bronze Hooded Caster - 2" Rubber Ball	\$151 (Set Of 5)									
Brass Hooded Black Caster - 2" Dual Wheels	\$84 (Set Of 5)									
CLASSIC WOOD BASE		<b>Overall:</b> 28"w 28"d 5"h								
	<b>CWB</b>	<p>Standard - No Charge                      \$193 Upcharge From Resin To Wood Base (730, 740, 750 Task Chairs Only)  <i>Solid Hardwood Cap, Steel Reinforced 5 Prong Base With 55mm Black Dual Wheel Casters.</i></p> <p>OPTIONS:</p> <table border="0"> <tr> <td>Carpet Caster - 2" Metal Balls</td> <td>\$164 (Set Of 5)</td> </tr> <tr> <td>Antique Bronze Hooded Caster - 2" Rubber Ball</td> <td>\$151 (Set Of 5)</td> </tr> <tr> <td>Brass Hooded Black Caster - 2" Dual Wheels</td> <td>\$84 (Set Of 5)</td> </tr> <tr> <td>Brass Scuff Plates</td> <td>\$105 (Set Of 5)</td> </tr> </table> <p><b>Available:</b> <i>Classic Executive Seating</i></p>	Carpet Caster - 2" Metal Balls	\$164 (Set Of 5)	Antique Bronze Hooded Caster - 2" Rubber Ball	\$151 (Set Of 5)	Brass Hooded Black Caster - 2" Dual Wheels	\$84 (Set Of 5)	Brass Scuff Plates	\$105 (Set Of 5)
Carpet Caster - 2" Metal Balls	\$164 (Set Of 5)									
Antique Bronze Hooded Caster - 2" Rubber Ball	\$151 (Set Of 5)									
Brass Hooded Black Caster - 2" Dual Wheels	\$84 (Set Of 5)									
Brass Scuff Plates	\$105 (Set Of 5)									
ARCHED RESIN BASE		<b>Overall:</b> 27"w 27"d 6.25"h								
	<b>ARB</b>	<p>\$100 Deduct  <i>Black Reinforced Nylon 5 Prong Base With 55mm Black Dual Wheel Casters.</i></p> <p>OPTIONS:</p> <table border="0"> <tr> <td>Black Sculptured Glides</td> <td>No Upcharge</td> </tr> </table> <p><b>Available:</b> <i>Classic Executive Seating</i></p>	Black Sculptured Glides	No Upcharge						
Black Sculptured Glides	No Upcharge									
POLISHED ALUMINUM BASE		<b>Overall:</b> 26"w 26"d 8"h								
	<b>PAB</b>	<p>\$50 Deduct  <i>Polished Aluminum 5 Prong Base With 55mm Black Dual Wheel Casters</i></p> <p>OPTIONS:</p> <table border="0"> <tr> <td>C4 Black Sculptured Glides</td> <td>No Upcharge (Set Of 5)</td> </tr> <tr> <td>C5 Polished Aluminum Hooded Casters</td> <td>\$105 (Set Of 5)</td> </tr> </table> <p><b>Available:</b> <i>Classic Executive Seating</i></p>	C4 Black Sculptured Glides	No Upcharge (Set Of 5)	C5 Polished Aluminum Hooded Casters	\$105 (Set Of 5)				
C4 Black Sculptured Glides	No Upcharge (Set Of 5)									
C5 Polished Aluminum Hooded Casters	\$105 (Set Of 5)									



BASES / CASTERS	OPTION #:	SPECIFICATIONS   LIST PRICES   AVAILABILITY:
<p><b>HIGH PROFILE BASE</b></p> 	<p><b>HPB</b></p>	<p><b>Overall:</b> 26"w 26"d 8"h</p> <hr/> <p>\$100 Deduct Black Reinforced Nylon 5 Prong Base With 55mm Black Dual Wheel Casters</p> <p><b>Available:</b> Classic Executive Seating</p>
<p><b>TAPERED RESIN BASE</b></p> 	<p><b>TRB</b></p>	<p><b>Overall:</b> 25.5"w 25.5"d 5"h</p> <hr/> <p>Standard On 730, 740, 750 - No Charge Classic To Tapered Resin Base - Deduct \$100 Black Reinforced Nylon 5 Prong Base With 55mm Black Dual Wheel Casters.</p> <p><b>Available:</b> Classic Executive Seating</p>
<p><b>JURY BASE</b></p> 	<p><b>JRB</b></p>	<p><b>Overall:</b> 8.5" Diameter 3.75"h</p> <hr/> <p>\$198 360° Rotation, Self Centering With Pneumatic Height Adjustment</p> <p>OPTIONS: No Rotation</p> <p><b>Available:</b> Classic Executive Seating</p>
<p><b>CASTERS</b></p> <div style="display: flex; flex-wrap: wrap;"> <div style="width: 50%;">  <p>(C1) Carpet Caster - 2" Metal Balls</p> </div> <div style="width: 50%;">  <p>(C2) Antique Bronze Hooded Caster - 2" Rubber Ball</p> </div> <div style="width: 50%;">  <p>(C3) Brass Hooded Black Caster - 2" Dual Wheels</p> </div> <div style="width: 50%;">  <p>(C4) Black Sculptured Glide - 2" Flat Bottom Glide</p> </div> <div style="width: 50%;">  <p>(C5) Polished Aluminum Caster - 2" Dual Wheels</p> </div> </div>	<p><b>Overall:</b> 2"h</p> <hr/> <p><b>C1</b> \$164 (Set Of 5) Carpet Caster - 2" Metal Balls (Additional Finishes Available)</p> <p><b>C2</b> \$151 (Set Of 5) Antique Bronze Hooded Caster - 2" Rubber Ball (Additional Finishes Available)</p> <p><b>C3</b> \$84 (Set Of 5) Brass Hooded Black Caster - 2" Dual Wheels (Additional Finishes Available)</p> <p><b>C4</b> No Charge (Set Of 5) Black Sculptured Glide - 2" Flat Bottom Glide</p> <p><b>C5</b> \$105 (Set Of 5) Polished Aluminum Hooded Caster - 2" Dual Wheels</p> <p><b>Available:</b> Classic Executive Seating</p>	

SCUFF PLATES / LUMBAR / MEDALLIONS / ARM CAPS	OPTION #:	SPECIFICATIONS   LIST PRICES   AVAILABILITY:
<p>SCUFF PLATES</p> 	<p><b>SP</b></p> <p><i>Overall: 1"w 4"d</i></p> <p>\$105 (Set Of 5) <i>(Specify Brass Or Pewter)</i></p> <p><i>Available: Classic Base Only</i></p>	
<p>INFLATABLE LUMBAR</p> 	<p><b>IL</b></p> <p><i>Overall: 2"w 3.75"h</i></p> <p>\$271 <i>Side Lever Lifts to Inflate &amp; Deflate Lumbar</i></p> <p><i>Available: Classic Executive Seating (700, 701, 710, 711 Models)</i></p>	
<p>CONCENTRIC CIRCLE ARM MEDALLIONS</p> 	<p><b>CCM</b></p> <p><i>Overall: 1.25" Diameter</i></p> <p>No Charge <i>(Specify Finish)</i></p> <p><i>Available: Classic Executive, Guest, And Benches</i></p>	
<p>SOLID CHERRY ARMS</p> 	<p><b>SCA</b></p> <p><i>Overall: 2.75"w 8.75"d 1.5"h</i></p> <p>\$186 (Set Of 2) <i>(Specify Finish)</i></p> <p><i>Available: Classic Task Arm Chairs</i></p>	

POWER / COVERS	OPTION #:	SPECIFICATIONS   LIST PRICES   AVAILABILITY:
<p>POWER / DATA MODULE</p> 	<p><b>PM1</b></p>	<p><b>Overall:</b> 5.25"w 1.25"d 4.25"h</p> <hr/> <p><b>\$836</b> (1-Power / 1-USB 2 Port Simplex Charger Standard)  <i>Vertical / Horizontal Mount Power Module. Price Varies By Socket. Contact Customer Service For Quote. (Additional Colors Available)</i></p> <p><b>Available:</b> <i>Classic Lounge</i></p>
<p>CONTRASTING COVERS</p> 	<p><b>CC</b></p>	<p><b>Overall:</b> n/a</p> <hr/> <p><b>\$129</b>  <i>NOTE: If Two Or More Upholsteries Or Leathers Are Used On Any Piece Of Furniture, Then A Contrast Charge Will Apply Per Order. When Using Trinity Upholstery, The Higher Priced Upholstery Grade Will Be Used In Pricing, Unless It's Trinity Leather With Fabric Contrast Welt, Or COM With Trinity Contrast Welt, Then Contact Customer Service For Pricing.</i></p> <p><b>Available:</b> <i>Classic Collection</i></p>

# Langton

---

EXECUTIVE / GUEST

Effective: August 1, 2022

T R I N I T Y

**Date:**

**Page:**

**Modification:**

**Description:**

---

**DESCRIPTION:**

- Upholstery Frames: Hardwood & Plywood
- Seat: High Density Polyurethane Foam Over Sheet Webbing
- Back: High Density Polyurethane Foam Over Polypropylene Webbing
- Arms: High Density Polyurethane Foam Over Hardwood & Plywood
- Black Arched Resin Base Standard
- 10 Year Warranty

**OPTIONS:**

Specify Exposed Wood Finish (See Page 6)  
 Base & Caster Options Available (See Langton Options Pages)

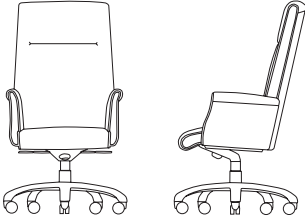
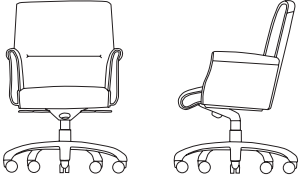
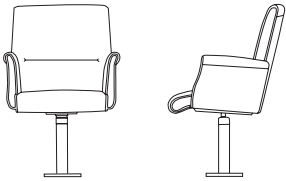
EXECUTIVE		ITEM #:	SPECIFICATIONS   GRADES   LIST PRICES:												
<b>HIGH BACK CHAIR / FULLY UPHOLSTERED ARMS</b>  			<i>Overall: 25"w 28"d 47"-50"h</i>			<i>Arm: 28"-31"h</i>			<i>COM: 4 yds.</i>						
			<i>Seat: 19"w 20"d 20.5"-23.5"h</i>			<i>Weight: 80 lbs.</i>			<i>COL: 72 sq.ft.</i>						
			<b>COM</b>	<b>COL</b>	<b>1</b>	<b>2</b>	<b>3</b>	<b>4</b>	<b>5</b>	<b>6</b>	<b>7</b>	<b>8</b>	<b>9</b>	<b>10</b>	<b>L1</b>
	<b>811-2</b>	1388	1527	1519	1622	1725	1828	1931	2034	2137	2240	2343	2446	2595	2966
		<i>Tilt Swivel w/ Lock / Pneumatic Seat Height Adjustment</i>													
	<b>811-4</b>	1429	1572	1557	1660	1763	1866	1969	2072	2176	2279	2382	2485	2634	3005
		<i>Knee Tilt Swivel w/ Infinite Lock / Pneumatic Seat Height Adjustment</i>													
<b>LOW BACK CHAIR / FULLY UPHOLSTERED ARMS</b>  			<i>Overall: 25"w 28"d 40"-43"h</i>			<i>Arm: 28"-31"h</i>			<i>COM: 3.75 yds.</i>						
			<i>Seat: 19"w 20"d 20.5"-23.5"h</i>			<i>Weight: 70 lbs.</i>			<i>COL: 68 sq.ft.</i>						
			<b>COM</b>	<b>COL</b>	<b>1</b>	<b>2</b>	<b>3</b>	<b>4</b>	<b>5</b>	<b>6</b>	<b>7</b>	<b>8</b>	<b>9</b>	<b>10</b>	<b>L1</b>
	<b>821-2</b>	1260	1386	1384	1480	1576	1672	1769	1865	1961	2057	2153	2250	2382	2728
		<i>Tilt Swivel w/ Lock / Pneumatic Seat Height Adjustment</i>													
	<b>821-4</b>	1318	1450	1439	1535	1631	1727	1824	1920	2016	2112	2208	2305	2437	2783
		<i>Knee Tilt Swivel w/ Infinite Lock / Pneumatic Seat Height Adjustment</i>													
<b>LOW BACK JURY CHAIR / FULLY UPHOLSTERED ARMS</b>  			<i>Overall: 25"w 28"d 40"-43"h</i>			<i>Arm: 28"-31"h</i>			<i>COM: 3.75 yds.</i>						
			<i>Seat: 19"w 20"d 20.5"-23.5"h</i>			<i>Weight: 70 lbs.</i>			<i>COL: 68 sq.ft.</i>						
			<b>COM</b>	<b>COL</b>	<b>1</b>	<b>2</b>	<b>3</b>	<b>4</b>	<b>5</b>	<b>6</b>	<b>7</b>	<b>8</b>	<b>9</b>	<b>10</b>	<b>L1</b>
	<b>821-5</b>	1452	1597	1565	1661	1758	1854	1950	2046	2142	2239	2335	2431	1500	1519
		<i>Tilt Swivel / Pneumatic Seat Height Adjustment / Self-Centering 360° Rotation</i>													

**DESCRIPTION:**

- Exposed Frames: Solid Cherry
- Seat: High Density Polyurethane Foam Over Sheet Webbing
- Back: High Density Polyurethane Foam Over Polypropylene Webbing
- Upholstered Arms: High Density Polyurethane Foam Over Hardwood
- 10 Year Warranty





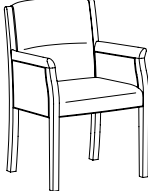
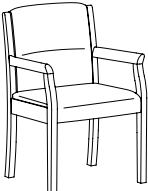
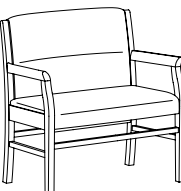

**OPTIONS:**



Specify Exposed Wood Finish (See Page 6)

GUEST	ITEM #:	SPECIFICATIONS   GRADES   LIST PRICES:													
<b>CLOSED ARM SIDE CHAIR</b>  	823	<b>Overall:</b> 22.5"w 24"d 33"h		<b>Arm:</b> 25"h		<b>COM:</b> 2.25 yds.									
		<b>Seat:</b> 19"w 18"d 19"h		<b>Weight:</b> 38 lbs.		<b>COL:</b> 41 sq.ft.									
		<b>COM</b>	<b>COL</b>	<b>1</b>	<b>2</b>	<b>3</b>	<b>4</b>	<b>5</b>	<b>6</b>	<b>7</b>	<b>8</b>	<b>9</b>	<b>10</b>	<b>L1</b>	<b>L2</b>
		1116	1228	1165	1220	1275	1330	1385	1440	1495	1550	1605	1660	1736	1934
		<i>Closed Back / Solid Wood Arms</i>													
<b>OPEN ARM SIDE CHAIR</b>  	824	<b>Overall:</b> 22.5"w 24"d 33"h		<b>Arm:</b> 25"h		<b>COM:</b> 1.75 yds.									
		<b>Seat:</b> 19"w 18"d 19"h		<b>Weight:</b> 32 lbs.		<b>COL:</b> 32 sq.ft.									
		<b>COM</b>	<b>COL</b>	<b>1</b>	<b>2</b>	<b>3</b>	<b>4</b>	<b>5</b>	<b>6</b>	<b>7</b>	<b>8</b>	<b>9</b>	<b>10</b>	<b>L1</b>	<b>L2</b>
		1034	1138	1060	1102	1143	1184	1225	1267	1308	1349	1390	1432	1489	1637
		<i>Closed Back / Solid Wood Arms</i>													
<b>BARIATRIC / OPEN ARM SIDE CHAIR</b>  	824-X	<b>Overall:</b> 32.5"w 24"d 33"h		<b>Arm:</b> 25"h		<b>COM:</b> 1.75 yds.									
		<b>Seat:</b> 29"w 18"d 19"h		<b>Weight:</b> 42 lbs.		<b>COL:</b> 32 sq.ft.									
		<b>COM</b>	<b>COL</b>	<b>1</b>	<b>2</b>	<b>3</b>	<b>4</b>	<b>5</b>	<b>6</b>	<b>7</b>	<b>8</b>	<b>9</b>	<b>10</b>	<b>L1</b>	<b>L2</b>
		1267	1393	1280	1321	1362	1404	1445	1486	1527	1569	1610	1651	1711	1859
		<i>Closed Back / Solid Wood Arms</i>													

BASES	OPTION #:	SPECIFICATIONS   LIST PRICES   AVAILABILITY:								
<p>TRANSITIONAL WOOD BASE</p> 	<p>TWB</p>	<p><b>Overall:</b> 25"w 25"d 5.5"h</p> <hr/> <p><b>\$193</b> Solid Hardwood Cap, Steel Reinforced 5 Prong Base With 55mm Black Dual Wheel Casters.</p> <p>OPTIONS:</p> <table border="0"> <tr> <td>Carpet Caster - 2" Metal Balls</td> <td>\$164 (Set Of 5)</td> </tr> <tr> <td>Antique Bronze Hooded Caster - 2" Rubber Ball</td> <td>\$151 (Set Of 5)</td> </tr> <tr> <td>Brass Hooded Black Caster - 2" Dual Wheels</td> <td>\$84 (Set Of 5)</td> </tr> </table> <p><b>Available:</b> Langton Executive Seating</p>	Carpet Caster - 2" Metal Balls	\$164 (Set Of 5)	Antique Bronze Hooded Caster - 2" Rubber Ball	\$151 (Set Of 5)	Brass Hooded Black Caster - 2" Dual Wheels	\$84 (Set Of 5)		
Carpet Caster - 2" Metal Balls	\$164 (Set Of 5)									
Antique Bronze Hooded Caster - 2" Rubber Ball	\$151 (Set Of 5)									
Brass Hooded Black Caster - 2" Dual Wheels	\$84 (Set Of 5)									
<p>CLASSIC WOOD BASE</p> 	<p>CWB</p>	<p><b>Overall:</b> 28"w 28"d 5"h</p> <hr/> <p><b>\$193</b> Solid Hardwood Cap, Steel Reinforced 5 Prong Base With 55mm Black Dual Wheel Casters.</p> <p>OPTIONS:</p> <table border="0"> <tr> <td>Carpet Caster - 2" Metal Balls</td> <td>\$164 (Set Of 5)</td> </tr> <tr> <td>Antique Bronze Hooded Caster - 2" Rubber Ball</td> <td>\$151 (Set Of 5)</td> </tr> <tr> <td>Brass Hooded Black Caster - 2" Dual Wheels</td> <td>\$84 (Set Of 5)</td> </tr> <tr> <td>Brass Scuff Plates</td> <td>\$105 (Set Of 5)</td> </tr> </table> <p><b>Available:</b> Langton Executive Seating</p>	Carpet Caster - 2" Metal Balls	\$164 (Set Of 5)	Antique Bronze Hooded Caster - 2" Rubber Ball	\$151 (Set Of 5)	Brass Hooded Black Caster - 2" Dual Wheels	\$84 (Set Of 5)	Brass Scuff Plates	\$105 (Set Of 5)
Carpet Caster - 2" Metal Balls	\$164 (Set Of 5)									
Antique Bronze Hooded Caster - 2" Rubber Ball	\$151 (Set Of 5)									
Brass Hooded Black Caster - 2" Dual Wheels	\$84 (Set Of 5)									
Brass Scuff Plates	\$105 (Set Of 5)									
<p>ARCHED RESIN BASE</p> 	<p>ARB</p>	<p><b>Overall:</b> 27"w 27"d 6.25"h</p> <hr/> <p>Standard - No Charge Black Reinforced Nylon 5 Prong Base With 55mm Black Dual Wheel Casters.</p> <p>OPTIONS:</p> <table border="0"> <tr> <td>Black Sculptured Glides</td> <td>No Upcharge</td> </tr> </table> <p><b>Available:</b> Langton Executive Seating</p>	Black Sculptured Glides	No Upcharge						
Black Sculptured Glides	No Upcharge									
<p>POLISHED ALUMINUM BASE</p> 	<p>PAB</p>	<p><b>Overall:</b> 26"w 26"d 8"h</p> <hr/> <p><b>\$98</b> Polished Aluminum 5 Prong Base With 55mm Black Dual Wheel Casters</p> <p>OPTIONS:</p> <table border="0"> <tr> <td>C4 Black Sculptured Glides</td> <td>No Upcharge (Set Of 5)</td> </tr> <tr> <td>C5 Polished Aluminum Hooded Casters</td> <td>\$105 (Set Of 5)</td> </tr> </table> <p><b>Available:</b> Langton Executive Seating</p>	C4 Black Sculptured Glides	No Upcharge (Set Of 5)	C5 Polished Aluminum Hooded Casters	\$105 (Set Of 5)				
C4 Black Sculptured Glides	No Upcharge (Set Of 5)									
C5 Polished Aluminum Hooded Casters	\$105 (Set Of 5)									



BASES / CASTERS	OPTION #:	SPECIFICATIONS   LIST PRICES   AVAILABILITY:
<p><b>HIGH PROFILE BASE</b></p> 	<p><b>HPB</b></p> <p>No Charge  <i>Black Reinforced Nylon 5 Prong Base With 55mm Black Dual Wheel Casters</i></p> <p><i>Available: Langton Executive Seating</i></p>	
<p><b>JURY BASE</b></p> 	<p><b>JRB</b></p> <p><i>Overall: 8.5" Diameter 3.75"h</i></p> <p>\$198  <i>360° Rotation, Self Centering With Pneumatic Height Adjustment</i></p> <p>OPTIONS:      No Rotation</p> <p><i>Available: Langton Executive Seating</i></p>	
<p><b>CASTERS</b></p> <div style="display: flex; flex-wrap: wrap;"> <div style="width: 50%;">  <p>(C1) Carpet Caster - 2" Metal Balls</p> </div> <div style="width: 50%;">  <p>(C2) Antique Bronze Hooded Caster - 2" Rubber Ball</p> </div> <div style="width: 50%;">  <p>(C3) Brass Hooded Black Caster - 2" Dual Wheels</p> </div> <div style="width: 50%;">  <p>(C4) Black Sculptured Glide - 2" Flat Bottom Glide</p> </div> <div style="width: 50%;">  <p>(C5) Polished Aluminum Caster - 2" Dual Wheels</p> </div> </div>	<p><i>Overall: 2"h</i></p> <p><b>C1</b> \$164 (Set Of 5)  <i>Carpet Caster - 2" Metal Balls (Additional Finishes Available)</i></p> <p><b>C2</b> \$151 (Set Of 5)  <i>Antique Bronze Hooded Caster - 2" Rubber Ball (Additional Finishes Available)</i></p> <p><b>C3</b> \$84 (Set Of 5)  <i>Brass Hooded Black Caster - 2" Dual Wheels (Additional Finishes Available)</i></p> <p><b>C4</b> No Charge (Set Of 5)  <i>Black Sculptured Glide - 2" Flat Bottom Glide</i></p> <p><b>C5</b> \$105 (Set Of 5)  <i>Polished Aluminum Hooded Caster - 2" Dual Wheels</i></p> <p><i>Available: Langton Executive Seating</i></p>	

SCUFF PLATES / COVERS	OPTION #:	SPECIFICATIONS   LIST PRICES   AVAILABILITY:
<p>SCUFF PLATES</p> 	<p><b>Overall:</b> 1"w 4"d</p> <hr/> <p><b>SP</b> \$105 (Set Of 5) <i>(Specify Brass Or Pewter)</i></p> <p><b>Available:</b> Classic Base Only</p>	
<p>CONTRASTING COVERS</p> 	<p><b>Overall:</b> n/a</p> <hr/> <p><b>CC</b> \$129</p> <p><i>NOTE: If Two Or More Upholsteries Or Leathers Are Used On Any Piece Of Furniture, Then A Contrast Charge Will Apply Per Order. When Using Trinity Upholstery, The Higher Priced Upholstery Grade Will Be Used In Pricing, Unless It's Trinity Leather With Fabric Contrast Welt, Or COM With Trinity Contrast Welt, Then Contact Customer Service For Pricing.</i></p> <p><b>Available:</b> Langton Chairs</p>	

# Luci Guci

---

LOUNGE / EXECUTIVE / GUEST

Effective: August 1, 2022

T R I N I T Y

**Date:**

**Page:**

**Modification:**

**Description:**

---

**DESCRIPTION:**

- Upholstery Frames: Plywood & Hardwood
- Seat / Back: High Density Polyurethane Foam
- Upholstered Arms: High Density Polyurethane Foam Over Plywood & Hardwood
- Open Arm: Black Urethane Molded Over A Steel Armature  
(All Arms Are Attached & Reinforced w/ Steel)
- Built-in Upholstered Lumbar
- Black Arched Resin Base Standard
- 10 Year Warranty

**OPTIONS:**

Specify Exposed Wood Finish (See Page 6)  
Base & Caster Options Available (See Luci Guci Options Pages)

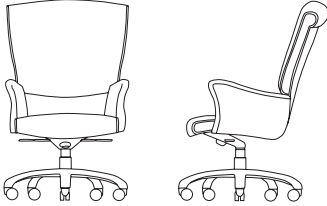
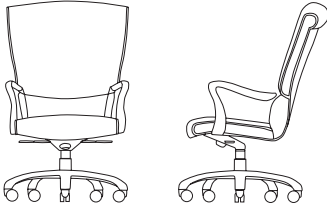
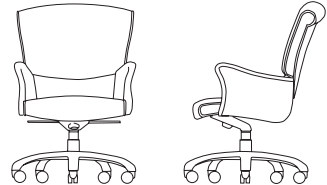
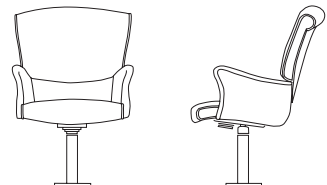
EXECUTIVE		ITEM #:	SPECIFICATIONS   GRADES   LIST PRICES:													
<b>HIGH BACK CHAIR / FULLY UPHOLSTERED ARM</b>			<b>Overall:</b> 26"w 30"d 43"-46"h			<b>Arm:</b> 25.5"-28.5"h			<b>COM:</b> 3.25 yds.							
			<b>Seat:</b> 22.5"w 18.5"d 17.5"-20.5"h			<b>Weight:</b> 65 lbs.			<b>COL:</b> 59 sq.ft.							
			<b>COM</b>	<b>COL</b>	<b>1</b>	<b>2</b>	<b>3</b>	<b>4</b>	<b>5</b>	<b>6</b>	<b>7</b>	<b>8</b>	<b>9</b>	<b>10</b>	<b>L1</b>	<b>L2</b>
		<b>831-2</b>	1378	1516	1468	1551	1633	1715	1798	1880	1963	2045	2128	2210	2341	2638
		<i>Tilt Swivel w/ Lock / Pneumatic Seat Height Adjustment</i>														
		<b>831-4</b>	1431	1574	1518	1600	1683	1765	1847	1930	2012	2095	2177	2260	2390	2687
		<i>Knee Tilt Swivel w/ Infinite Lock / Pneumatic Seat Height Adjustment</i>														
<b>HIGH BACK CHAIR / URETHANE OPEN ARM</b>			<b>Overall:</b> 26"w 30"d 43"-46"h			<b>Arm:</b> 25.5"-28.5"h			<b>COM:</b> 2.5 yds.							
			<b>Seat:</b> 22.5"w 18.5"d 17.5"-20.5"h			<b>Weight:</b> 65 lbs.			<b>COL:</b> 45 sq.ft.							
			<b>COM</b>	<b>COL</b>	<b>1</b>	<b>2</b>	<b>3</b>	<b>4</b>	<b>5</b>	<b>6</b>	<b>7</b>	<b>8</b>	<b>9</b>	<b>10</b>	<b>L1</b>	<b>L2</b>
		<b>832-2</b>	1212	1333	1270	1332	1393	1455	1517	1579	1641	1703	1765	1826	1928	2150
		<i>Tilt Swivel w/ Lock / Pneumatic Seat Height Adjustment</i>														
		<b>832-4</b>	1276	1404	1330	1392	1454	1516	1578	1639	1701	1763	1825	1887	1988	2211
		<i>Knee Tilt Swivel w/ Infinite Lock / Pneumatic Seat Height Adjustment</i>														
<b>LOW BACK CHAIR / FULLY UPHOLSTERED ARM</b>			<b>Overall:</b> 26"w 29"d 38"-41"h			<b>Arm:</b> 25.5"-28.5"h			<b>COM:</b> 3.25 yds.							
			<b>Seat:</b> 22.5"w 18.5"d 17.5"-20.5"h			<b>Weight:</b> 60 lbs.			<b>COL:</b> 59 sq.ft.							
			<b>COM</b>	<b>COL</b>	<b>1</b>	<b>2</b>	<b>3</b>	<b>4</b>	<b>5</b>	<b>6</b>	<b>7</b>	<b>8</b>	<b>9</b>	<b>10</b>	<b>L1</b>	<b>L2</b>
		<b>841-2</b>	1322	1454	1415	1497	1580	1662	1745	1827	1910	1992	2075	2157	2284	2581
		<i>Tilt Swivel w/ Lock / Pneumatic Seat Height Adjustment</i>														
		<b>841-4</b>	1374	1512	1464	1547	1629	1712	1794	1877	1959	2042	2124	2207	2333	2630
		<i>Knee Tilt Swivel w/ Infinite Lock / Pneumatic Seat Height Adjustment</i>														
<b>LOW BACK JURY CHAIR / FULLY UPHOLSTERED ARM</b>			<b>Overall:</b> 26"w 29"d 38"-41"h			<b>Arm:</b> 25.5"-28.5"h			<b>COM:</b> 3.25 yds.							
			<b>Seat:</b> 22.5"w 18.5"d 17.5"-20.5"h			<b>Weight:</b> 60 lbs.			<b>COL:</b> 59 sq.ft.							
			<b>COM</b>	<b>COL</b>	<b>1</b>	<b>2</b>	<b>3</b>	<b>4</b>	<b>5</b>	<b>6</b>	<b>7</b>	<b>8</b>	<b>9</b>	<b>10</b>	<b>L1</b>	<b>L2</b>
		<b>841-5</b>	1520	1672	1602	1684	1767	1849	1932	2014	2097	2179	2262	2344	2471	2768
		<i>Jury Base / Pneumatic Seat Height Adjustment / Self-Centering 360° Rotation</i>														

**DESCRIPTION:**

- Upholstery Frames: Plywood & Hardwood
- Seat / Back: High Density Polyurethane Foam
- Upholstered Arms: High Density Polyurethane Foam Over Plywood & Hardwood
- Exposed Wood Arm Cap: Solid Maple / Lacquered Finish
- Open Arm: Black Urethane Molded Over A Steel Armature (All Arms Are Attached & Reinforced w/ Steel)
- Black Arched Resin Base Standard
- 10 Year Warranty

**OPTIONS:**

Specify Exposed Wood Finish (See Page 6)  
 Base & Caster Options Available (See See Luci Guci Options Pages)

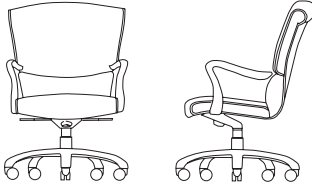
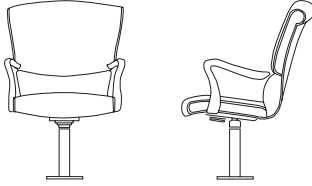
EXECUTIVE	ITEM #:	SPECIFICATIONS   GRADES   LIST PRICES:													
	<b>LOW BACK CHAIR / URETHANE OPEN ARM</b>	<b>Overall:</b> 26"w 29"d 38"-41"h <b>Seat:</b> 22.5"w 18.5"d 17.5"-20.5"h			<b>Arm:</b> 25.5"-28.5"h <b>Weight:</b> 60 lbs.			<b>COM:</b> 2.5 yds. <b>COL:</b> 45 sq.ft.							
		<b>COM</b>	<b>COL</b>	<b>1</b>	<b>2</b>	<b>3</b>	<b>4</b>	<b>5</b>	<b>6</b>	<b>7</b>	<b>8</b>	<b>9</b>	<b>10</b>	<b>L1</b>	<b>L2</b>
	<b>842-2</b>	1171	1288	1231	1292	1354	1416	1478	1540	1602	1664	1725	1787	1885	2108
		<i>Tilt Swivel w/ Lock / Pneumatic Seat Height Adjustment</i>													
	<b>842-4</b>	1229	1352	1286	1347	1409	1471	1533	1595	1657	1718	1780	1842	1940	2163
		<i>Knee Tilt Swivel w/ Infinite Lock / Pneumatic Seat Height Adjustment</i>													
	<b>LOW BACK JURY CHAIR / URETHANE OPEN ARM</b>	<b>Overall:</b> 26"w 29"d 38"-41"h <b>Seat:</b> 22.5"w 18.5"d 17.5"-20.5"h			<b>Arm:</b> 25.5"-28.5"h <b>Weight:</b> 60 lbs.			<b>COM:</b> 2.5 yds. <b>COL:</b> 45 sq.ft.							
		<b>COM</b>	<b>COL</b>	<b>1</b>	<b>2</b>	<b>3</b>	<b>4</b>	<b>5</b>	<b>6</b>	<b>7</b>	<b>8</b>	<b>9</b>	<b>10</b>	<b>L1</b>	<b>L2</b>
	<b>842-5</b>	1368	1505	1417	1479	1541	1603	1665	1727	1789	1850	1912	1974	2072	2295
		<i>Jury Base / Pneumatic Seat Height Adjustment / Self-Centering 360° Rotation</i>													



**DESCRIPTION:**

- Upholstery Frames: Plywood & Hardwood
- Seat: High Density Polyurethane Foam Over Sheet Webbing
- Back: High Density Polyurethane Foam Over Polypropylene Webbing (#854)
- Exposed Wood Arms: Solid Maple / Lacquered Finish  
(All Arms Are Attached & Reinforced w/ Steel)
- 10 Year Warranty

**OPTIONS:**

- ST-1 Wooden Horizontal Stretchers (Guest Chairs Only).....\$97
- BR-1 Wooden Horizontal Book Rack (Guest Chairs Only).....\$167
- SGS Soft Ganging Straps .....\$24 Per Seat
- D800-6 Single Stacking Cart (Stacks 6 Chairs).....\$855 Each
- D800-12 Double Stacing Cart (Stacks 12 Chairs).....\$1248 Each

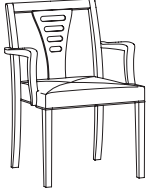
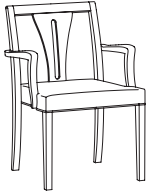
Specify Exposed Wood Finish (See Page 6)  
Optional Custom Engraving Back Designs Available (Contact Factory)

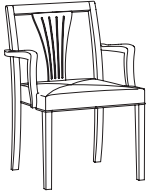
GUEST / STACKING		ITEM #:	SPECIFICATIONS   GRADES   LIST PRICES:													
<b>STACKING OPEN ARM SIDE CHAIR / HORIZONTAL DESIGN SLAT BACK</b>			<i>Overall: 21.5"w 23"d 31.5"h</i>			<i>Arm: 25.5"h</i>			<i>COM: 1.25 yds.</i>							
			<i>Seat: 19"w 18.5"d 18"h</i>			<i>Weight: 25 lbs.</i>			<i>COL: 20 sq.ft.</i>							
 			<b>COM</b>	<b>COL</b>	<b>1</b>	<b>2</b>	<b>3</b>	<b>4</b>	<b>5</b>	<b>6</b>	<b>7</b>	<b>8</b>	<b>9</b>	<b>10</b>	<b>L1</b>	<b>L2</b>
855-P		<b>855-P</b>	779	857	792	819	847	874	902	929	957	984	1012	1039	1042	1130
			<i>Fully Upholstered Plain Seat</i>													
855-T		<b>855-T</b>	796	876	808	835	863	890	918	945	973	1000	1028	1055	1061	1149
			<i>Fully Upholstered Seat / Diagonally Sewn Buttonless Tufting</i>													
<b>STACKING OPEN ARM SIDE CHAIR / VERTICAL DESIGN SLAT BACK</b>			<i>Overall: 21.5"w 23"d 31.5"h</i>			<i>Arm: 25.5"h</i>			<i>COM: 1.25 yds.</i>							
			<i>Seat: 19"w 18.5"d 18"h</i>			<i>Weight: 25 lbs.</i>			<i>COL: 20 sq.ft.</i>							
 			<b>COM</b>	<b>COL</b>	<b>1</b>	<b>2</b>	<b>3</b>	<b>4</b>	<b>5</b>	<b>6</b>	<b>7</b>	<b>8</b>	<b>9</b>	<b>10</b>	<b>L1</b>	<b>L2</b>
856-P		<b>856-P</b>	779	857	792	819	847	874	902	929	957	984	1012	1039	1042	1130
			<i>Fully Upholstered Plain Seat</i>													
856-T		<b>856-T</b>	796	876	808	835	863	890	918	945	973	1000	1028	1055	1061	1149
			<i>Fully Upholstered Seat / Diagonally Sewn Buttonless Tufting</i>													
<b>STACKING OPEN ARM SIDE CHAIR / WHEAT DESIGN SLAT BACK</b>			<i>Overall: 21.5"w 23"d 31.5"h</i>			<i>Arm: 25.5"h</i>			<i>COM: 1.25 yds.</i>							
			<i>Seat: 19"w 18.5"d 18"h</i>			<i>Weight: 25 lbs.</i>			<i>COL: 20 sq.ft.</i>							
 			<b>COM</b>	<b>COL</b>	<b>1</b>	<b>2</b>	<b>3</b>	<b>4</b>	<b>5</b>	<b>6</b>	<b>7</b>	<b>8</b>	<b>9</b>	<b>10</b>	<b>L1</b>	<b>L2</b>
857-P		<b>857-P</b>	779	857	792	819	847	874	902	929	957	984	1012	1039	1042	1130
			<i>Fully Upholstered Plain Seat</i>													
857-T		<b>857-T</b>	796	876	808	835	863	890	918	945	973	1000	1028	1055	1061	1149
			<i>Fully Upholstered Seat / Diagonally Sewn Buttonless Tufting</i>													





**DESCRIPTION:**

- Upholstery Frames: Plywood & Hardwood
- Seat: High Density Polyurethane Foam Over Sheet Webbing
- Back: High Density Polyurethane Foam Over Polypropylene Webbing (#859)
- Exposed Wood Arms: Solid Maple / Lacquered Finish  
(All Arms Are Attached & Reinforced w/ Steel)
- 10 Year Warranty

**OPTIONS:**

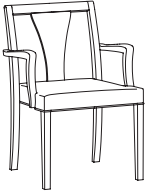







- SGS Soft Ganging Straps .....\$24 Per Seat
- D800-6 Single Stacking Cart (Stacks 6 Chairs).....\$855 Each
- D800-12 Double Stacing Cart (Stacks 12 Chairs).....\$1248 Each





Specify Exposed Wood Finish (See Page 6)  
Optional Custom Engraving Back Designs Available (Contact Factory)

GUEST / STACKING		ITEM #:	SPECIFICATIONS   GRADES   LIST PRICES:													
<b>STACKING OPEN ARM SIDE CHAIR / UPHOLSTERED SLAT BACK</b>			<i>Overall: 21.5"w 23"d 31.5"h</i>			<i>Arm: 25.5"h</i>			<i>COM: 1.5 yds.</i>							
			<i>Seat: 19"w 18.5"d 18"h</i>			<i>Weight: 25 lbs.</i>			<i>COL: 24 sq.ft.</i>							
 858-P  858-T			<b>COM</b>	<b>COL</b>	<b>1</b>	<b>2</b>	<b>3</b>	<b>4</b>	<b>5</b>	<b>6</b>	<b>7</b>	<b>8</b>	<b>9</b>	<b>10</b>	<b>L1</b>	<b>L2</b>
		<b>858-P</b>	805	886	830	864	899	933	967	1002	1036	1070	1105	1139	1141	1251
			<i>Fully Upholstered Plain Seat</i>													
		<b>858-T</b>	818	900	842	877	911	945	980	1014	1048	1083	1117	1151	1156	1266
			<i>Fully Upholstered Seat / Diagonally Sewn Buttonless Tufting</i>													
<b>STACKING OPEN ARM SIDE CHAIR / FULLY UPHOLSTERED BACK</b>			<i>Overall: 21.5"w 23"d 31.5"h</i>			<i>Arm: 25.5"h</i>			<i>COM: 1.75 yds.</i>							
			<i>Seat: 19"w 18.5"d 18"h</i>			<i>Weight: 25 lbs.</i>			<i>COL: 28 sq.ft.</i>							
 859-P  859-T			<b>COM</b>	<b>COL</b>	<b>1</b>	<b>2</b>	<b>3</b>	<b>4</b>	<b>5</b>	<b>6</b>	<b>7</b>	<b>8</b>	<b>9</b>	<b>10</b>	<b>L1</b>	<b>L2</b>
		<b>859-P</b>	744	819	786	827	869	910	951	992	1034	1075	1116	1157	1211	1360
			<i>Fully Upholstered Plain Seat</i>													
		<b>859-T</b>	761	837	802	843	885	926	967	1008	1050	1091	1132	1173	1231	1379
			<i>Fully Upholstered Seat / Diagonally Sewn Buttonless Tufting</i>													



BASES	OPTION #:	SPECIFICATIONS   LIST PRICES   AVAILABILITY:								
<p>TRANSITIONAL WOOD BASE</p> 	<p><b>TWB</b></p>	<p><b>Overall:</b> 25"w 25"d 5.5"h</p> <hr/> <p><b>\$193</b> Solid Hardwood Cap, Steel Reinforced 5 Prong Base With 55mm Black Dual Wheel Casters.</p> <p>OPTIONS:</p> <table border="0"> <tr> <td>Carpet Caster - 2" Metal Balls</td> <td>\$164 (Set Of 5)</td> </tr> <tr> <td>Antique Bronze Hooded Caster - 2" Rubber Ball</td> <td>\$151 (Set Of 5)</td> </tr> <tr> <td>Brass Hooded Black Caster - 2" Dual Wheels</td> <td>\$84 (Set Of 5)</td> </tr> </table> <p><b>Available:</b> <i>Luci Guci Executive Seating</i></p>	Carpet Caster - 2" Metal Balls	\$164 (Set Of 5)	Antique Bronze Hooded Caster - 2" Rubber Ball	\$151 (Set Of 5)	Brass Hooded Black Caster - 2" Dual Wheels	\$84 (Set Of 5)		
Carpet Caster - 2" Metal Balls	\$164 (Set Of 5)									
Antique Bronze Hooded Caster - 2" Rubber Ball	\$151 (Set Of 5)									
Brass Hooded Black Caster - 2" Dual Wheels	\$84 (Set Of 5)									
<p>CLASSIC WOOD BASE</p> 	<p><b>CWB</b></p>	<p><b>Overall:</b> 28"w 28"d 5"h</p> <hr/> <p><b>\$193</b> Solid Hardwood Cap, Steel Reinforced 5 Prong Base With 55mm Black Dual Wheel Casters.</p> <p>OPTIONS:</p> <table border="0"> <tr> <td>Carpet Caster - 2" Metal Balls</td> <td>\$164 (Set Of 5)</td> </tr> <tr> <td>Antique Bronze Hooded Caster - 2" Rubber Ball</td> <td>\$151 (Set Of 5)</td> </tr> <tr> <td>Brass Hooded Black Caster - 2" Dual Wheels</td> <td>\$84 (Set Of 5)</td> </tr> <tr> <td>Brass Scuff Plates</td> <td>\$105 (Set Of 5)</td> </tr> </table> <p><b>Available:</b> <i>Luci Guci Executive Seating</i></p>	Carpet Caster - 2" Metal Balls	\$164 (Set Of 5)	Antique Bronze Hooded Caster - 2" Rubber Ball	\$151 (Set Of 5)	Brass Hooded Black Caster - 2" Dual Wheels	\$84 (Set Of 5)	Brass Scuff Plates	\$105 (Set Of 5)
Carpet Caster - 2" Metal Balls	\$164 (Set Of 5)									
Antique Bronze Hooded Caster - 2" Rubber Ball	\$151 (Set Of 5)									
Brass Hooded Black Caster - 2" Dual Wheels	\$84 (Set Of 5)									
Brass Scuff Plates	\$105 (Set Of 5)									
<p>ARCHED RESIN BASE</p> 	<p><b>ARB</b></p>	<p><b>Overall:</b> 27"w 27"d 6.25"h</p> <hr/> <p>Standard - No Charge Black Reinforced Nylon 5 Prong Base With 55mm Black Dual Wheel Casters.</p> <p>OPTIONS:</p> <table border="0"> <tr> <td>Black Sculptured Glides</td> <td>No Upcharge</td> </tr> </table> <p><b>Available:</b> <i>Luci Guci Executive Seating</i></p>	Black Sculptured Glides	No Upcharge						
Black Sculptured Glides	No Upcharge									
<p>POLISHED ALUMINUM BASE</p> 	<p><b>PAB</b></p>	<p><b>Overall:</b> 26"w 26"d 8"h</p> <hr/> <p><b>\$98</b> Polished Aluminum 5 Prong Base With 55mm Black Dual Wheel Casters</p> <p>OPTIONS:</p> <table border="0"> <tr> <td>C4 Black Sculptured Glides</td> <td>No Upcharge (Set Of 5)</td> </tr> <tr> <td>C5 Polished Aluminum Hooded Casters</td> <td>\$105 (Set Of 5)</td> </tr> </table> <p><b>Available:</b> <i>Luci Guci Executive Seating</i></p>	C4 Black Sculptured Glides	No Upcharge (Set Of 5)	C5 Polished Aluminum Hooded Casters	\$105 (Set Of 5)				
C4 Black Sculptured Glides	No Upcharge (Set Of 5)									
C5 Polished Aluminum Hooded Casters	\$105 (Set Of 5)									

BASES / CASTERS / SCUFF PLATES	OPTION #:	SPECIFICATIONS   LIST PRICES   AVAILABILITY:
<p><b>HIGH PROFILE BASE</b></p> 	<p><b>HPB</b></p>	<p><b>Overall:</b> 26"w 26"d 8"h</p> <hr/> <p>No Charge  <i>Black Reinforced Nylon 5 Prong Base With 55mm Black Dual Wheel Casters</i></p> <p><b>Available:</b> <i>Luci Guci Executive Seating</i></p>
<p><b>JURY BASE</b></p> 	<p><b>JRB</b></p>	<p><b>Overall:</b> 8.5" Diameter 3.75"h</p> <hr/> <p>\$198  <i>360° Rotation, Self Centering With Pneumatic Height Adjustment</i></p> <p>OPTIONS:      No Rotation</p> <p><b>Available:</b> <i>Luci Guci Executive Seating</i></p>
<p><b>CASTERS</b></p> <div style="display: flex; flex-wrap: wrap;"> <div style="width: 50%;">  <p>(C1) Carpet Caster - 2" Metal Balls</p> </div> <div style="width: 50%;">  <p>(C2) Antique Bronze Hooded Caster - 2" Rubber Ball</p> </div> <div style="width: 50%;">  <p>(C3) Brass Hooded Black Caster - 2" Dual Wheels</p> </div> <div style="width: 50%;">  <p>(C4) Black Sculptured Glide - 2" Flat Bottom Glide</p> </div> <div style="width: 50%;">  <p>(C5) Polished Aluminum Caster - 2" Dual Wheels</p> </div> </div>	<p><b>C1</b></p> <p><b>C2</b></p> <p><b>C3</b></p> <p><b>C4</b></p> <p><b>C5</b></p>	<p><b>Overall:</b> 2"h</p> <hr/> <p>\$164 (Set Of 5)  <i>Carpet Caster - 2" Metal Balls (Additional Finishes Available)</i></p> <p>\$147 (Set Of 5)  <i>Antique Bronze Hooded Caster - 2" Rubber Ball (Additional Finishes Available)</i></p> <p>\$84 (Set Of 5)  <i>Brass Hooded Black Caster - 2" Dual Wheels (Additional Finishes Available)</i></p> <p>No Charge (Set Of 5)  <i>Black Sculptured Glide - 2" Flat Bottom Glide</i></p> <p>\$105 (Set Of 5)  <i>Polished Aluminum Hooded Caster - 2" Dual Wheels</i></p> <p><b>Available:</b> <i>Luci Guci Executive Seating</i></p>
<p><b>SCUFF PLATES</b></p> 	<p><b>SP</b></p>	<p><b>Overall:</b> 1"w 4"d</p> <hr/> <p>\$105 (Set Of 5)  <i>(Specify Brass Or Pewter)</i></p> <p><b>Available:</b> <i>Classic Base Only</i></p>

SCUFF PLATES / LEGS / GANGING / POWER	OPTION #:	SPECIFICATIONS   LIST PRICES   AVAILABILITY:
<p><b>BRUSHED ALUMINUM ROUND LEGS</b></p> 	<p><b>ARL</b></p>	<p><i>Overall: 2" Diameter 5"h</i></p> <hr/> <p>\$353 (Set Of 4) <i>(Brushed Aluminum Finish)</i></p> <p><i>Available: Luci Guci Lounge</i></p>
<p><b>SOFT GANGING</b></p> 	<p><b>SGS</b></p>	<p><i>Overall: 4"w 2"d</i></p> <hr/> <p>\$24 Per Seat <i>Black Velcro Soft Ganging Straps</i></p> <p><i>Available: Luci Guci Stacking Chairs</i></p>
<p><b>POWER / DATA MODULE</b></p> 	<p><b>PM1</b></p>	<p><i>Overall: 5.25"w 1.25"d 4.25"h</i></p> <hr/> <p>\$836 (1-Power / 1-USB 2 Port Simplex Charger Standard) <i>Vertical / Horizontal Mount Power Module. Price Varies By Socket. Contact Customer Service For Quote. (Additional Colors Available)</i></p> <p><i>Available: Luci Guci Lounge</i></p>
<p><b>CUSTOM ENGRAVING BACK DESIGNS</b></p> 	<p><b>PM1</b></p>	<p><i>Overall: n/a</i></p> <hr/> <p>CALL FOR PRICING <i>Custom Engraving Back Designs</i></p> <p><i>Available: Luci Guci Guest / Stacking Chairs</i></p>

STRETCHERS / BOOK RACK / STACKING / COVERS	OPTION #:	SPECIFICATIONS   LIST PRICES   AVAILABILITY:
<p><b>STRETCHERS</b></p> 	<p><b>ST-1</b></p> <p><i>Overall: 23"w 25"d 1"h</i></p> <p>\$97 <i>Wooden Horizontal Stretchers</i></p> <p><i>Available: Luci Guci Guest Chairs</i></p>	
<p><b>BOOK RACK</b></p> 	<p><b>BR-1</b></p> <p><i>Overall: 23"w 25"d 1"h</i></p> <p>\$167 <i>Wooden Horizontal Book Rack</i></p> <p><i>Available: Luci Guci Guest Chairs</i></p>	
<p><b>STACKING CARTS</b></p>  <p>Single Stacking</p> <p>Double Stacking</p>	<p><i>Overall: 26"w 37"d 12"h (Single Stacking Cart) / 37"w 50"d 12"h (Double Stacking Cart)</i></p> <p><b>D800-6</b></p> <p>\$855 <i>Single Stacking Cart (Stacks 6 Chairs)</i></p> <p><b>D800-12</b></p> <p>\$1248 <i>Double Stacking Cart (Stacks 12 Chairs)</i></p> <p><i>Available: Luci Guci Stacking Chairs</i></p>	
<p><b>CONTRASTING COVERS</b></p> 	<p><i>Overall: n/a</i></p> <p><b>CC</b></p> <p>\$129</p> <p><i>NOTE: If Two Or More Upholsteries Or Leathers Are Used On Any Piece Of Furniture, Then A Contrast Charge Will Apply Per Order. When Using Trinity Upholstery, The Higher Priced Upholstery Grade Will Be Used In Pricing, Unless It's Trinity Leather With Fabric Contrast Welt, Or COM With Trinity Contrast Welt, Then Contact Customer Service For Pricing.</i></p> <p><i>Available: Luci Guci Collection</i></p>	

# Quads

---

LOUNGE SEATING

Effective: August 1, 2022

T R I N I T Y

**Date:**

**Page:**

**Modification:**

**Description:**

---

**DESCRIPTION:**

- Upholstery Frames: Hardwood & Plywood
- Seat: High Density Polyurethane Foam Over Sheet Webbing
- Back: High Density Polyurethane Foam Over Sinuous Wire Springs
- Loose Cushions: High Density Polydacron
- Leather / Vinyl Cushions Are Not Reversible
- Integral Exposed Wood Legs: Solid Maple
- 10 Year Warranty

**OPTIONS:**

- ARL Brushed Aluminum Round Legs (Set Of 4).....\$353
  - PM1 Power/Data Module (1-Power / 1-USB 2 Port Simplex Charger) .....\$836
- Feather Down & Polyester Pillows Available (See Page 5)  
 Specify Exposed Wood Finish (See Page 6)  
 Tablet Arm / Cup Holder Options (See Quads Options Pages)

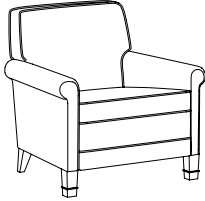
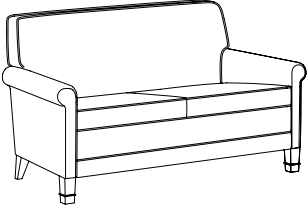
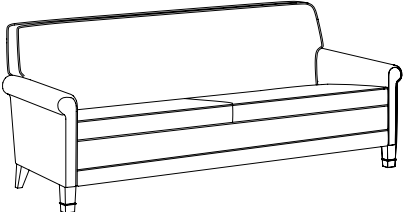
Q1 LOUNGE		ITEM #:	SPECIFICATIONS   GRADES   LIST PRICES:													
	LOUNGE CHAIR		<b>Overall:</b> 32"w 31"d 33"h			<b>Arm:</b> 23"h			<b>COM:</b> 5 yds. (861-P) / 5.25 yds. (861-C)							
			<b>Seat:</b> 22.5"w 20.5"d 18"h			<b>Weight:</b> 76 lbs.			<b>COL:</b> 90 sq.ft. (861-P) / 95 sq.ft. (861-C)							
			<b>COM</b>	<b>COL</b>	<b>1</b>	<b>2</b>	<b>3</b>	<b>4</b>	<b>5</b>	<b>6</b>	<b>7</b>	<b>8</b>	<b>9</b>	<b>10</b>	<b>L1</b>	<b>L2</b>
	<b>861-P</b>	1511	1662	1690	1820	1951	2082	2212	2343	2473	2604	2734	2865	3035	3505	
		<i>Tight Seat / Tight Back</i>														
	<b>861-C</b>	1541	1695	1732	1869	2007	2144	2282	2419	2557	2694	2832	2969	3144	3639	
		<i>Reversible Loose Seat Cushion / Tight Back</i>														
	TWO PLACE SOFA		<b>Overall:</b> 55.5"w 31"d 33"h			<b>Arm:</b> 23"h			<b>COM:</b> 7 yds. (862-P) / 7.5 yds. (862-C)							
			<b>Seat:</b> 46"w 20.5"d 18"h			<b>Weight:</b> 100 lbs.			<b>COL:</b> 126 sq.ft. (862-P) / 135 sq.ft. (862-C)							
			<b>COM</b>	<b>COL</b>	<b>1</b>	<b>2</b>	<b>3</b>	<b>4</b>	<b>5</b>	<b>6</b>	<b>7</b>	<b>8</b>	<b>9</b>	<b>10</b>	<b>L1</b>	<b>L2</b>
	<b>862-P</b>	2073	2280	2331	2516	2702	2888	3073	3259	3444	3630	3815	4001	4226	4894	
		<i>Tight Seat / Tight Back</i>														
	<b>862-C</b>	2024	2227	2312	2512	2711	2910	3110	3309	3508	3708	3907	4106	4347	5065	
		<i>Reversible Loose Seat Cushion / Tight Back</i>														
	THREE PLACE SOFA		<b>Overall:</b> 79"w 31"d 33"h			<b>Arm:</b> 23"h			<b>COM:</b> 8.75 yds. (863-P) / 10 yds. (863-C)							
			<b>Seat:</b> 69.5"w 20.5"d 18"h			<b>Weight:</b> 135 lbs.			<b>COL:</b> 158 sq.ft. (863-P) / 180 sq.ft. (863-C)							
			<b>COM</b>	<b>COL</b>	<b>1</b>	<b>2</b>	<b>3</b>	<b>4</b>	<b>5</b>	<b>6</b>	<b>7</b>	<b>8</b>	<b>9</b>	<b>10</b>	<b>L1</b>	<b>L2</b>
	<b>863-P</b>	2524	2776	2853	3087	3321	3554	3788	4022	4255	4489	4722	4956	5231	6072	
		<i>Tight Seat / Tight Back</i>														
	<b>863-C</b>	2487	2735	2887	3155	3423	3691	3959	4227	4495	4763	5031	5299	5606	6571	
		<i>Reversible Loose Seat Cushion / Tight Back</i>														

**DESCRIPTION:**

- Upholstery Frames: Hardwood & Plywood
- Seat: High Density Polyurethane Foam Over Sheet Webbing
- Back: High Density Polyurethane Foam Over Sinuous Wire Springs
- Loose Cushions: High Density Polydacron
- Leather / Vinyl Cushions Are Not Reversible
- Integral Exposed Wood Legs: Solid Maple
- 10 Year Warranty

**OPTIONS:**

- ARL Brushed Aluminum Round Legs (Set Of 4).....\$353
- PM1 Power/Data Module (1-Power / 1-USB 2 Port Simplex Charger) .....\$836
- Feather Down & Polyester Pillows Available (See Page 5)
- Specify Exposed Wood Finish (See Page 6)
- Tablet Arm / Cup Holder Options (See Quads Options Pages)

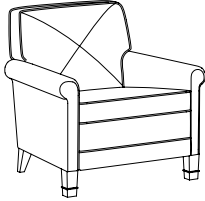
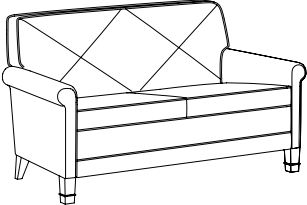
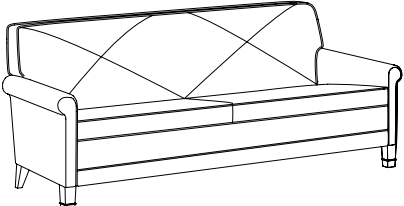
Q1 LOUNGE	ITEM #:	SPECIFICATIONS   GRADES   LIST PRICES:													
	<b>LOUNGE CHAIR</b>	<b>Overall:</b> 32"w 31"d 33"h	<b>Arm:</b> 23"h	<b>COM:</b> 5 yds. (864-P) / 5.25 yds. (864-C)											
		<b>Seat:</b> 22.5"w 20.5"d 18"h	<b>Weight:</b> 75 lbs.	<b>COL:</b> 90 sq.ft. (864-P) / 95 sq.ft. (864-C)											
		<b>COM</b>	<b>COL</b>	<b>1</b>	<b>2</b>	<b>3</b>	<b>4</b>	<b>5</b>	<b>6</b>	<b>7</b>	<b>8</b>	<b>9</b>	<b>10</b>	<b>L1</b>	<b>L2</b>
	<b>864-P</b>	1532	1685	1709	1840	1970	2101	2232	2362	2493	2623	2754	2884	3057	3527
		<i>Tight Seat / Diagonally Sewn Buttonless Tufted Back</i>													
	<b>864-C</b>	1562	1718	1752	1889	2026	2164	2301	2439	2576	2714	2851	2989	3167	3661
		<i>Reversible Loose Seat Cushion / Diagonally Sewn Buttonless Tufted Back</i>													
	<b>TWO PLACE SOFA</b>	<b>Overall:</b> 55.5"w 31"d 33"h	<b>Arm:</b> 23"h	<b>COM:</b> 7.25 yds. (865-P) / 8.25 yds. (865-C)											
		<b>Seat:</b> 46"w 20.5"d 18"h	<b>Weight:</b> 100 lbs.	<b>COL:</b> 131 sq.ft. (865-P) / 149 sq.ft. (865-C)											
		<b>COM</b>	<b>COL</b>	<b>1</b>	<b>2</b>	<b>3</b>	<b>4</b>	<b>5</b>	<b>6</b>	<b>7</b>	<b>8</b>	<b>9</b>	<b>10</b>	<b>L1</b>	<b>L2</b>
	<b>865-P</b>	2114	2325	2383	2576	2768	2961	3153	3346	3538	3730	3923	4115	4351	5044
		<i>Tight Seat / Diagonally Sewn Buttonless Tufted Back</i>													
	<b>865-C</b>	2065	2272	2392	2612	2832	3052	3272	3492	3712	3932	4152	4372	4631	5423
		<i>Reversible Loose Seat Cushion / Diagonally Sewn Buttonless Tufted Back</i>													
	<b>THREE PLACE SOFA</b>	<b>Overall:</b> 79"w 31"d 33"h	<b>Arm:</b> 23"h	<b>COM:</b> 8.75 yds. (866-P) / 9.5 yds. (866-C)											
		<b>Seat:</b> 69.5"w 20.5"d 18"h	<b>Weight:</b> 135 lbs.	<b>COL:</b> 158 sq.ft. (866-P) / 171 sq.ft. (866-C)											
		<b>COM</b>	<b>COL</b>	<b>1</b>	<b>2</b>	<b>3</b>	<b>4</b>	<b>5</b>	<b>6</b>	<b>7</b>	<b>8</b>	<b>9</b>	<b>10</b>	<b>L1</b>	<b>L2</b>
	<b>866-P</b>	2565	2821	2892	3126	3359	3593	3827	4060	4294	4528	4761	4995	5276	6117
		<i>Tight Seat / Diagonally Sewn Buttonless Tufted Back</i>													
	<b>866-C</b>	2517	2768	2888	3142	3396	3651	3905	4159	4414	4668	4922	5176	5478	6393
		<i>Reversible Loose Seat Cushion / Diagonally Sewn Buttonless Tufted Back</i>													



**DESCRIPTION:**

- Upholstery Frames: Hardwood & Plywood
- Seat: High Density Polyurethane Foam Over Sheet Webbing
- Back: High Density Polyurethane Foam Over Sinuous Wire Springs
- Loose Cushions: High Density Polydacron
- Leather / Vinyl Cushions Are Not Reversible
- Integral Exposed Wood Legs: Solid Maple
- 10 Year Warranty

**OPTIONS:**

- ARL Brushed Aluminum Round Legs (Set Of 4).....\$353
  - PM1 Power/Data Module (1-Power / 1-USB 2 Port Simplex Charger) .....\$836
- Feather Down & Polyester Pillows Available (See Page 5)  
 Specify Exposed Wood Finish (See Page 6)  
 Tablet Arm / Cup Holder Options (See Quads Options Pages)

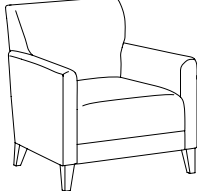
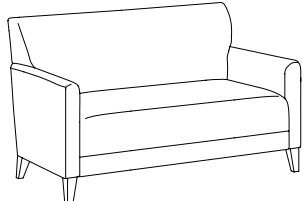
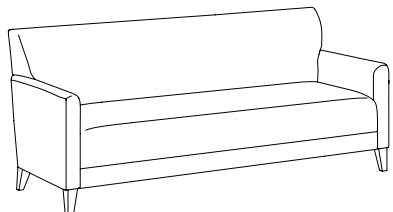
Q2 LOUNGE		ITEM #:	SPECIFICATIONS   GRADES   LIST PRICES:												
	LOUNGE CHAIR		<b>Overall:</b> 29"w 31"d 33"h			<b>Arm:</b> 22.5"h			<b>COM:</b> 5 yds. (871-P) / 5 yds. (871-C)						
			<b>Seat:</b> 22"w 21"d 17"h			<b>Weight:</b> 75 lbs.			<b>COL:</b> 90 sq.ft. (871-P) / 90 sq.ft. (871-C)						
			<b>COM</b>	<b>COL</b>	<b>1</b>	<b>2</b>	<b>3</b>	<b>4</b>	<b>5</b>	<b>6</b>	<b>7</b>	<b>8</b>	<b>9</b>	<b>10</b>	<b>L1</b>
	<b>871-P</b>	1388	1527	1573	1704	1835	1965	2096	2226	2357	2488	2618	2749	2915	3385
		<i>Tight Seat / Tight Back</i>													
	<b>871-C</b>	1404	1544	1588	1719	1849	1980	2111	2241	2372	2502	2633	2763	2931	3401
		<i>Reversible Loose Seat Cushion / Tight Back</i>													
	TWO PLACE SOFA		<b>Overall:</b> 53"w 31"d 33"h			<b>Arm:</b> 22.5"h			<b>COM:</b> 6.75 yds. (872-P) / 7 yds. (872-C)						
			<b>Seat:</b> 46"w 21"d 17"h			<b>Weight:</b> 100 lbs.			<b>COL:</b> 122 sq.ft. (872-P) / 126 sq.ft. (872-C)						
			<b>COM</b>	<b>COL</b>	<b>1</b>	<b>2</b>	<b>3</b>	<b>4</b>	<b>5</b>	<b>6</b>	<b>7</b>	<b>8</b>	<b>9</b>	<b>10</b>	<b>L1</b>
	<b>872-P</b>	1956	2151	2206	2385	2564	2742	2921	3100	3278	3457	3636	3814	4031	4675
		<i>Tight Seat / Tight Back</i>													
	<b>872-C</b>	1977	2174	2240	2426	2611	2797	2982	3168	3353	3539	3724	3910	4138	4806
		<i>Reversible Loose Seat Cushion / Tight Back</i>													
	THREE PLACE SOFA		<b>Overall:</b> 76.5"w 31"d 33"h			<b>Arm:</b> 22.5"h			<b>COM:</b> 9.25 yds. (873-P) / 9.25 yds. (873-C)						
			<b>Seat:</b> 69.5"w 21"d 17"h			<b>Weight:</b> 130 lbs.			<b>COL:</b> 167 sq.ft. (873-P) / 167 sq.ft. (873-C)						
			<b>COM</b>	<b>COL</b>	<b>1</b>	<b>2</b>	<b>3</b>	<b>4</b>	<b>5</b>	<b>6</b>	<b>7</b>	<b>8</b>	<b>9</b>	<b>10</b>	<b>L1</b>
	<b>873-P</b>	2424	2666	2786	3034	3281	3529	3776	4023	4271	4518	4766	5013	5294	6185
		<i>Tight Seat / Tight Back</i>													
	<b>873-C</b>	2450	2695	2811	3059	3306	3553	3801	4048	4296	4543	4790	5038	5325	6215
		<i>Reversible Loose Seat Cushion / Tight Back</i>													

**DESCRIPTION:**

- Upholstery Frames: Hardwood & Plywood
- Seat: High Density Polyurethane Foam Over Sheet Webbing
- Back: High Density Polyurethane Foam Over Sinuous Wire Springs
- Loose Cushions: High Density Polydacron
- Leather / Vinyl Cushions Are Not Reversible
- Integral Exposed Wood Legs: Solid Maple
- 10 Year Warranty

**OPTIONS:**

- ARL Brushed Aluminum Round Legs (Set Of 4).....\$353
  - PM1 Power/Data Module (1-Power / 1-USB 2 Port Simplex Charger) .....\$836
- Feather Down & Polyester Pillows Available (See Page 5)  
 Specify Exposed Wood Finish (See Page 6)  
 Tablet Arm / Cup Holder Options (See Quads Options Pages)

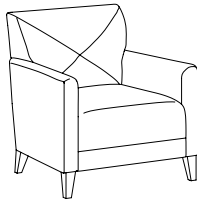
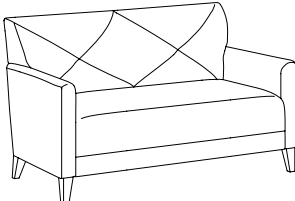
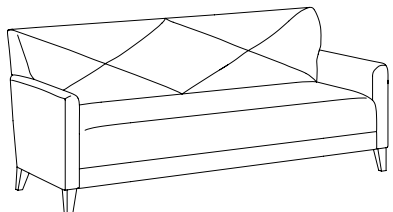
Q2 LOUNGE	ITEM #:	SPECIFICATIONS   GRADES   LIST PRICES:													
	<b>LOUNGE CHAIR</b>	<b>Overall:</b> 29"w 31"d 33"h		<b>Arm:</b> 22.5"h		<b>COM:</b> 4.75 yds. (874-P) / 4.75 yds. (874-C)									
		<b>Seat:</b> 22"w 21"d 17"h		<b>Weight:</b> 75 lbs.		<b>COL:</b> 86 sq.ft. (874-P) / 86 sq.ft. (874-C)									
		<b>COM</b>	<b>COL</b>	<b>1</b>	<b>2</b>	<b>3</b>	<b>4</b>	<b>5</b>	<b>6</b>	<b>7</b>	<b>8</b>	<b>9</b>	<b>10</b>	<b>L1</b>	<b>L2</b>
	<b>874-P</b>	1403	1543	1574	1697	1821	1945	2068	2192	2316	2440	2563	2687	2851	3296
		<i>Tight Seat / Diagonally Sewn Buttonless Tufted Back</i>													
	<b>874-C</b>	1421	1563	1591	1715	1839	1962	2086	2210	2333	2457	2581	2704	2869	3315
		<i>Reversible Loose Seat Cushion / Diagonally Sewn Buttonless Tufted Back</i>													
	<b>TWO PLACE SOFA</b>	<b>Overall:</b> 53"w 31"d 33"h		<b>Arm:</b> 22.5"h		<b>COM:</b> 6.5 yds. (875-P) / 7 yds. (875-C)									
		<b>Seat:</b> 46"w 21"d 17"h		<b>Weight:</b> 100 lbs.		<b>COL:</b> 117 sq.ft. (875-P) / 126 sq.ft. (875-C)									
		<b>COM</b>	<b>COL</b>	<b>1</b>	<b>2</b>	<b>3</b>	<b>4</b>	<b>5</b>	<b>6</b>	<b>7</b>	<b>8</b>	<b>9</b>	<b>10</b>	<b>L1</b>	<b>L2</b>
	<b>875-P</b>	1985	2183	2220	2392	2564	2736	2907	3079	3251	3423	3595	3766	3982	4601
		<i>Tight Seat / Diagonally Sewn Buttonless Tufted Back</i>													
	<b>875-C</b>	2012	2213	2287	2479	2672	2864	3057	3249	3441	3634	3826	4019	4256	4949
		<i>Reversible Loose Seat Cushion / Diagonally Sewn Buttonless Tufted Back</i>													
	<b>THREE PLACE SOFA</b>	<b>Overall:</b> 76.5"w 31"d 33"h		<b>Arm:</b> 22.5"h		<b>COM:</b> 8.75 yds. (876-P) / 9.25 yds. (876-C)									
		<b>Seat:</b> 69.5"w 21"d 17"h		<b>Weight:</b> 130 lbs.		<b>COL:</b> 158 sq.ft. (876-P) / 167 sq.ft. (876-C)									
		<b>COM</b>	<b>COL</b>	<b>1</b>	<b>2</b>	<b>3</b>	<b>4</b>	<b>5</b>	<b>6</b>	<b>7</b>	<b>8</b>	<b>9</b>	<b>10</b>	<b>L1</b>	<b>L2</b>
	<b>876-P</b>	2453	2698	2787	3020	3254	3488	3721	3955	4189	4422	4656	4889	5164	6006
		<i>Tight Seat / Diagonally Sewn Buttonless Tufted Back</i>													
	<b>876-C</b>	2493	2742	2852	3099	3346	3594	3841	4089	4336	4584	4831	5078	5371	6262
		<i>Reversible Loose Seat Cushion / Diagonally Sewn Buttonless Tufted Back</i>													

**DESCRIPTION:**

- Upholstery Frames: Hardwood & Plywood
- Seat: High Density Polyurethane Foam Over Sheet Webbing
- Back: High Density Polyurethane Foam Over Sinuous Wire Springs
- Loose Cushions: High Density Polydacron
- Leather / Vinyl Cushions Are Not Reversible
- Integral Exposed Wood Legs: Solid Maple
- 10 Year Warranty

**OPTIONS:**

- ARL-2 Aluminum Round Legs (Set Of 2).....\$289
- QWAC Solid Wood Arm Caps (Set Of 2).....\$193
- PM1 Power/Data Module (1-Power / 1-USB 2 Port Simplex Charger) .....\$836

Feather Down & Polyester Pillows Available (See Page 5)  
 Specify Exposed Wood Finish (See Page 6)  
 Tablet Arm / Cup Holder Options (See Quads Options Pages)  
 Casters Replace Rear Legs (See Quads Options Pages)

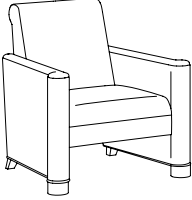
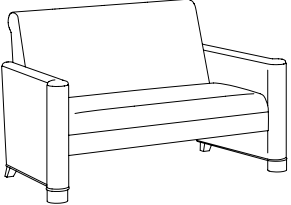
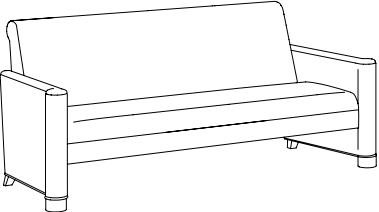
Q3 LOUNGE		ITEM #:	SPECIFICATIONS   GRADES   LIST PRICES:													
	<b>LOUNGE CHAIR</b>		<b>Overall:</b> 31.5"w 33"d 33"h			<b>Arm:</b> 22.5"h			<b>COM:</b> 5 yds. (881-P) / 5.5 yds. (881-C)							
			<b>Seat:</b> 23"w 19.5"d 17.5"h			<b>Weight:</b> 75 lbs.			<b>COL:</b> 90 sq.ft. (881-P) / 99 sq.ft. (881-C)							
			<b>COM</b>	<b>COL</b>	<b>1</b>	<b>2</b>	<b>3</b>	<b>4</b>	<b>5</b>	<b>6</b>	<b>7</b>	<b>8</b>	<b>9</b>	<b>10</b>	<b>L1</b>	<b>L2</b>
	<b>881-P</b>	1646	1811	1817	1948	2078	2209	2340	2470	2601	2731	2862	2992	3165	3636	
		<i>Tight Seat / Tight Back</i>														
	<b>881-C</b>	1650	1815	1849	1993	2137	2282	2426	2570	2715	2859	3003	3147	3332	3851	
		<i>Reversible Loose Seat Cushion / Tight Back</i>														
	<b>TWO PLACE SOFA</b>		<b>Overall:</b> 54.5"w 33"d 33"h			<b>Arm:</b> 22.5"h			<b>COM:</b> 6.5 yds. (882-P) / 7 yds. (882-C)							
			<b>Seat:</b> 46"w 19.5"d 17.5"h			<b>Weight:</b> 100 lbs.			<b>COL:</b> 117 sq.ft. (882-P) / 126 sq.ft. (882-C)							
			<b>COM</b>	<b>COL</b>	<b>1</b>	<b>2</b>	<b>3</b>	<b>4</b>	<b>5</b>	<b>6</b>	<b>7</b>	<b>8</b>	<b>9</b>	<b>10</b>	<b>L1</b>	<b>L2</b>
	<b>882-P</b>	2242	2467	2464	2636	2807	2979	3151	3323	3495	3666	3838	4010	4229	4848	
		<i>Tight Seat / Tight Back</i>														
	<b>882-C</b>	2270	2496	2517	2702	2888	3074	3259	3445	3630	3816	4001	4187	4422	5090	
		<i>Reversible Loose Seat Cushion / Tight Back</i>														
	<b>THREE PLACE SOFA</b>		<b>Overall:</b> 78"w 33"d 33"h			<b>Arm:</b> 22.5"h			<b>COM:</b> 8 yds. (883-P) / 9 yds. (883-C)							
			<b>Seat:</b> 69.5"w 19.5"d 17.5"h			<b>Weight:</b> 130 lbs.			<b>COL:</b> 144 sq.ft. (883-P) / 162 sq.ft. (883-C)							
			<b>COM</b>	<b>COL</b>	<b>1</b>	<b>2</b>	<b>3</b>	<b>4</b>	<b>5</b>	<b>6</b>	<b>7</b>	<b>8</b>	<b>9</b>	<b>10</b>	<b>L1</b>	<b>L2</b>
	<b>883-P</b>	2740	3014	3016	3229	3442	3655	3869	4082	4295	4508	4721	4934	5198	5965	
		<i>Tight Seat / Tight Back</i>														
	<b>883-C</b>	2767	3044	3097	3338	3578	3819	4059	4300	4540	4781	5021	5262	5553	6419	
		<i>Reversible Loose Seat Cushion / Tight Back</i>														

**DESCRIPTION:**

- Upholstery Frames: Hardwood & Plywood
- Seat: High Density Polyurethane Foam Over Sheet Webbing
- Back: High Density Polyurethane Foam Over Sinuous Wire Springs
- Loose Cushions: High Density Polydacron
- Leather / Vinyl Cushions Are Not Reversible
- Integral Exposed Wood Legs: Solid Maple
- 10 Year Warranty

**OPTIONS:**

- ARL-2 Aluminum Round Legs (Set Of 2).....\$289
- QWAC Solid Wood Arm Caps (Set Of 2).....\$193
- PM1 Power/Data Module (1-Power / 1-USB 2 Port Simplex Charger) .....\$836

Feather Down & Polyester Pillows Available (See Page 5)  
 Specify Exposed Wood Finish (See Page 6)  
 Tablet Arm / Cup Holder Options (See Quads Options Pages)  
 Casters Replace Rear Legs (See Quads Options Pages)

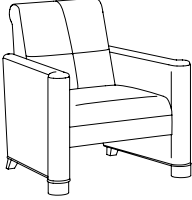
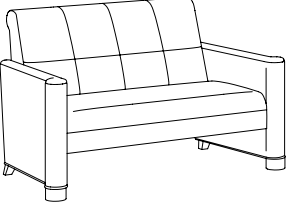
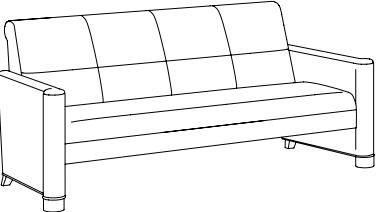
Q3 LOUNGE		ITEM #:	SPECIFICATIONS   GRADES   LIST PRICES:													
<b>LOUNGE CHAIR</b>			<b>Overall:</b> 31.5"w 33"d 33"h			<b>Arm:</b> 22.5"h			<b>COM:</b> 5 yds. (884-P) / 5.5 yds. (884-C)							
			<b>Seat:</b> 23"w 19.5"d 17.5"h			<b>Weight:</b> 75 lbs.			<b>COL:</b> 90 sq.ft. (884-P) / 99 sq.ft. (884-C)							
			<b>COM</b>	<b>COL</b>	<b>1</b>	<b>2</b>	<b>3</b>	<b>4</b>	<b>5</b>	<b>6</b>	<b>7</b>	<b>8</b>	<b>9</b>	<b>10</b>	<b>L1</b>	<b>L2</b>
		<b>884-P</b>	1666	1833	1837	1967	2098	2228	2359	2490	2620	2751	2881	3012	3188	3658
		<i>Tight Seat / Sewn Buttonless Tufted Back</i>														
	<b>884-C</b>	1667	1834	1865	2009	2154	2298	2442	2587	2731	2875	3020	3164	3350	3870	
<i>Reversible Loose Seat Cushion / Sewn Buttonless Tufted Back</i>																
<b>TWO PLACE SOFA</b>			<b>Overall:</b> 54.5"w 33"d 33"h			<b>Arm:</b> 22.5"h			<b>COM:</b> 6.5 yds. (885-P) / 7 yds. (885-C)							
			<b>Seat:</b> 46"w 19.5"d 17.5"h			<b>Weight:</b> 100 lbs.			<b>COL:</b> 117 sq.ft. (885-P) / 126 sq.ft. (885-C)							
			<b>COM</b>	<b>COL</b>	<b>1</b>	<b>2</b>	<b>3</b>	<b>4</b>	<b>5</b>	<b>6</b>	<b>7</b>	<b>8</b>	<b>9</b>	<b>10</b>	<b>L1</b>	<b>L2</b>
		<b>885-P</b>	2278	2505	2497	2669	2841	3012	3184	3356	3528	3700	3872	4043	4268	4887
		<i>Tight Seat / Sewn Buttonless Tufted Back</i>														
	<b>885-C</b>	2299	2529	2544	2730	2916	3101	3287	3472	3658	3843	4029	4214	4454	5122	
<i>Reversible Loose Seat Cushion / Sewn Buttonless Tufted Back</i>																
<b>THREE PLACE SOFA</b>			<b>Overall:</b> 78"w 33"d 33"h			<b>Arm:</b> 22.5"h			<b>COM:</b> 8.25 yds. (886-P) / 9.25 yds. (886-C)							
			<b>Seat:</b> 69.5"w 19.5"d 17.5"h			<b>Weight:</b> 130 lbs.			<b>COL:</b> 149 sq.ft. (886-P) / 167 sq.ft. (886-C)							
			<b>COM</b>	<b>COL</b>	<b>1</b>	<b>2</b>	<b>3</b>	<b>4</b>	<b>5</b>	<b>6</b>	<b>7</b>	<b>8</b>	<b>9</b>	<b>10</b>	<b>L1</b>	<b>L2</b>
		<b>886-P</b>	2792	3072	3080	3300	3520	3740	3960	4180	4399	4619	4839	5059	5336	6128
		<i>Tight Seat / Diagonally Sewn Buttonless Tufted Back</i>														
	<b>886-C</b>	2814	3095	3155	3402	3650	3897	4145	4392	4639	4887	5134	5382	5684	6575	
<i>Reversible Loose Seat Cushion / Sewn Buttonless Tufted Back</i>																

**DESCRIPTION:**

- Upholstery Frames: Hardwood & Plywood
- Seat: High Density Polyurethane Foam Over Sheet Webbing
- Back: High Density Polyurethane Foam Over Sinuous Wire Springs
- Loose Cushions: High Density Polydacron
- Leather / Vinyl Cushions Are Not Reversible
- Integral Exposed Wood Legs: Solid Maple
- 10 Year Warranty

**OPTIONS:**

- ASL Aluminum Square Legs (Set Of 4).....\$347
  - PM1 Power/Data Module (1-Power / 1-USB 2 Port Simplex Charger) .....\$836
- Feather Down & Polyester Pillows Available (See Page 5)  
 Specify Exposed Wood Finish (See Page 6)  
 Tablet Arm / Cup Holder Options (See Quads Options Pages)

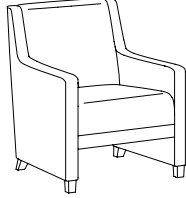
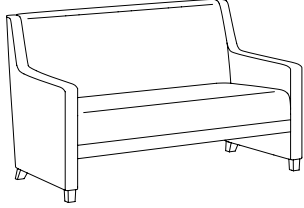
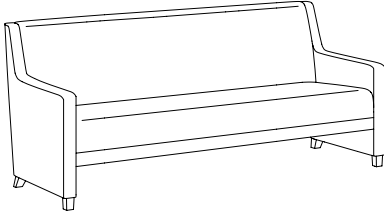
Q4 LOUNGE		ITEM #:	SPECIFICATIONS   GRADES   LIST PRICES:												
	LOUNGE CHAIR		<b>Overall:</b> 29"w 30"d 33"h			<b>Arm:</b> 23"h			<b>COM:</b> 5.5 yds. (891-P) / 6 yds. (891-C)						
			<b>Seat:</b> 22"w 20"d 18"h			<b>Weight:</b> 75 lbs.			<b>COL:</b> 99 sq.ft. (891-P) / 108 sq.ft. (891-C)						
			<b>COM</b>	<b>COL</b>	<b>1</b>	<b>2</b>	<b>3</b>	<b>4</b>	<b>5</b>	<b>6</b>	<b>7</b>	<b>8</b>	<b>9</b>	<b>10</b>	<b>L1</b>
	<b>891-P</b>	1589	1748	1791	1935	2080	2224	2368	2513	2657	2801	2946	3090	3287	3807
		<i>Tight Seat / Tight Back</i>													
	<b>891-C</b>	1593	1752	1822	1980	2138	2297	2455	2613	2771	2929	3087	3245	3453	4022
		<i>Reversible Loose Seat Cushion / Tight Back</i>													
	TWO PLACE SOFA		<b>Overall:</b> 53"w 30"d 33"h			<b>Arm:</b> 23"h			<b>COM:</b> 7 yds. (892-P) / 7.75 yds. (892-C)						
			<b>Seat:</b> 46"w 20"d 18"h			<b>Weight:</b> 100 lbs.			<b>COL:</b> 126 sq.ft. (892-P) / 140 sq.ft. (892-C)						
			<b>COM</b>	<b>COL</b>	<b>1</b>	<b>2</b>	<b>3</b>	<b>4</b>	<b>5</b>	<b>6</b>	<b>7</b>	<b>8</b>	<b>9</b>	<b>10</b>	<b>L1</b>
	<b>892-P</b>	2180	2398	2432	2618	2803	2989	3174	3360	3545	3731	3916	4102	4345	5013
		<i>Tight Seat / Tight Back</i>													
	<b>892-C</b>	2213	2434	2504	2710	2917	3123	3329	3535	3741	3948	4154	4360	4624	5366
		<i>Reversible Loose Seat Cushion / Tight Back</i>													
	THREE PLACE SOFA		<b>Overall:</b> 76.5"w 30"d 33"h			<b>Arm:</b> 23"h			<b>COM:</b> 9.75 yds. (893-P) / 10.75 yds. (893-C)						
			<b>Seat:</b> 69.5"w 20"d 18"h			<b>Weight:</b> 130 lbs.			<b>COL:</b> 176 sq.ft. (893-P) / 194 sq.ft. (893-C)						
			<b>COM</b>	<b>COL</b>	<b>1</b>	<b>2</b>	<b>3</b>	<b>4</b>	<b>5</b>	<b>6</b>	<b>7</b>	<b>8</b>	<b>9</b>	<b>10</b>	<b>L1</b>
	<b>893-P</b>	2654	2919	3031	3292	3554	3815	4076	4337	4598	4859	5120	5382	5694	6634
		<i>Tight Seat / Tight Back</i>													
	<b>893-C</b>	2704	2975	3134	3423	3711	4000	4289	4577	4866	5154	5443	5732	6071	7110
		<i>Reversible Loose Seat Cushion / Tight Back</i>													

**DESCRIPTION:**

- Upholstery Frames: Hardwood & Plywood
- Seat: High Density Polyurethane Foam Over Sheet Webbing
- Back: High Density Polyurethane Foam Over Sinuous Wire Springs
- Loose Cushions: High Density Polydacron
- Leather / Vinyl Cushions Are Not Reversible
- Integral Exposed Wood Legs: Solid Maple
- 10 Year Warranty

**OPTIONS:**



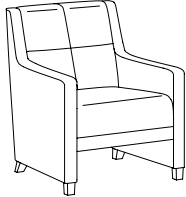
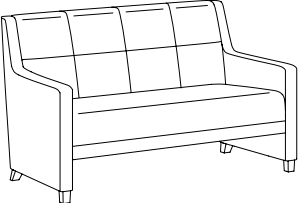
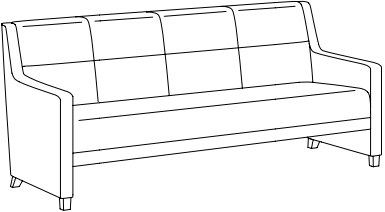

- ASL Aluminum Square Legs (Set Of 4).....\$347
- PM1 Power/Data Module (1-Power / 1-USB 2 Port Simplex Charger) .....\$836
- Feather Down & Polyester Pillows Available (See Page 5)
- Specify Exposed Wood Finish (See Page 6)
- Tablet Arm / Cup Holder Options (See Quads Options Pages)

Q4 LOUNGE		ITEM #:	SPECIFICATIONS   GRADES   LIST PRICES:													
	<b>LOUNGE CHAIR</b>		<b>Overall:</b> 29"w 30"d 33"h			<b>Arm:</b> 23"h			<b>COM:</b> 5.5 yds. (894-P) / 6 yds. (894-C)							
			<b>Seat:</b> 22"w 20"d 18"h			<b>Weight:</b> 75 lbs.			<b>COL:</b> 99 sq.ft. (894-P) / 108 sq.ft. (894-C)							
			<b>COM</b>	<b>COL</b>	<b>1</b>	<b>2</b>	<b>3</b>	<b>4</b>	<b>5</b>	<b>6</b>	<b>7</b>	<b>8</b>	<b>9</b>	<b>10</b>	<b>L1</b>	<b>L2</b>
	<b>894-P</b>	1604	1764	1805	1949	2094	2238	2382	2526	2671	2815	2959	3104	3304	3823	
		<i>Tight Seat / Sewn Buttonless Tufted Back</i>														
	<b>894-C</b>	1611	1772	1839	1997	2155	2313	2471	2629	2787	2945	3103	3261	3472	4041	
		<i>Reversible Loose Seat Cushion / Sewn Buttonless Tufted Back</i>														
	<b>TWO PLACE SOFA</b>		<b>Overall:</b> 53"w 30"d 33"h			<b>Arm:</b> 23"h			<b>COM:</b> 7.25 yds. (895-P) / 7.75 yds. (895-C)							
			<b>Seat:</b> 46"w 20"d 18"h			<b>Weight:</b> 100 lbs.			<b>COL:</b> 131 sq.ft. (895-P) / 140 sq.ft. (895-C)							
			<b>COM</b>	<b>COL</b>	<b>1</b>	<b>2</b>	<b>3</b>	<b>4</b>	<b>5</b>	<b>6</b>	<b>7</b>	<b>8</b>	<b>9</b>	<b>10</b>	<b>L1</b>	<b>L2</b>
	<b>895-P</b>	2203	2424	2468	2660	2853	3045	3238	3430	3623	3815	4007	4200	4454	5146	
		<i>Tight Seat / Sewn Buttonless Tufted Back</i>														
	<b>895-C</b>	2242	2466	2546	2759	2972	3185	3398	3611	3824	4037	4250	4463	4736	5503	
		<i>Reversible Loose Seat Cushion / Sewn Buttonless Tufted Back</i>														
	<b>THREE PLACE SOFA</b>		<b>Overall:</b> 76.5"w 30"d 33"h			<b>Arm:</b> 23"h			<b>COM:</b> 9.75 yds. (896-P) / 10.75 yds. (896-C)							
			<b>Seat:</b> 69.5"w 20"d 18"h			<b>Weight:</b> 130 lbs.			<b>COL:</b> 176 sq.ft. (896-P) / 194 sq.ft. (896-C)							
			<b>COM</b>	<b>COL</b>	<b>1</b>	<b>2</b>	<b>3</b>	<b>4</b>	<b>5</b>	<b>6</b>	<b>7</b>	<b>8</b>	<b>9</b>	<b>10</b>	<b>L1</b>	<b>L2</b>
	<b>896-P</b>	2701	2971	3076	3337	3598	3859	4120	4381	4643	4904	5165	5426	5746	6686	
		<i>Tight Seat / Sewn Buttonless Tufted Back</i>														
	<b>896-C</b>	2745	3020	3173	3461	3750	4039	4327	4616	4904	5193	5482	5770	6116	7156	
		<i>Reversible Loose Seat Cushion / Sewn Buttonless Tufted Back</i>														

LEGS	OPTION #:	SPECIFICATIONS   LIST PRICES   AVAILABILITY:
<p><b>BRUSHED ALUMINUM ROUND LEGS</b></p> 	<p><b>ARL</b></p> <p>\$353 (Set Of 4) <i>(Brushed Aluminum Finish)</i></p> <p><i>Available: Quads 1 / Quads 2 Collections</i></p>	
<p><b>ALUMINUM ROUND LEGS (SHORT)</b></p> 	<p><b>ARL-2</b></p> <p>\$289 (Set Of 2) <i>(Brushed Finish)</i></p> <p><i>Available: Quads 3 Collection</i></p>	
<p><b>ALUMINUM SQUARE LEGS</b></p> 	<p><b>ASL</b></p> <p>\$347 (Set Of 4) <i>(Brushed Finish)</i></p> <p><i>Available: Quads 4 Collection</i></p>	

TABLETS / ARM CAPS	OPTION #:	SPECIFICATIONS   LIST PRICES   AVAILABILITY:
<p><b>TABLET ARMS / CUP HOLDER</b></p>  <p>Laminate Tablet Arm Shown w/ Cup Holder</p>  <p>Veneer Tablet Arm Shown w/ Cup Holder</p>  <p>Solid Surface Tablet Arm Shown w/ Cup Holder</p>	<p><b>Overall:</b> 14" Diameter .75"h</p> <hr/> <p><b>TA-L</b> \$440 <i>Tablet Arm With 360° Rotation - High Pressure Laminate. (Specify Laminate / Specify Left Or Right Facing Arm Location)</i></p> <p><b>TA-V</b> \$503 <i>Tablet Arm With 360° Rotation - Sunburst Cherry Veneer. (Specify Finish / Specify Left Or Right Facing Arm Location)</i></p> <p><b>TA-C</b> \$654 <i>Tablet Arm With 360° Rotation - White Solid Surface. (Available In White Only / Specify Left Or Right Facing Arm Location)</i></p> <p><b>CH-1</b> \$105 <i>Black Plastic Cup Holder (Only Available If Used With Tablet Arm)</i></p> <p><b>CH-2</b> \$157 <i>Spun Aluminum Cup Holder (Only Available If Used With Tablet Arm)</i></p> <p><b>Available:</b> Quads Collection</p>	
<p><b>FOLD DOWN TABLET ARM</b></p>  	<p><b>Overall:</b> 14" Diameter .75"h</p> <hr/> <p><b>FDTA-L</b> \$1056 <i>Tablet Arm With 360° Rotation - High Pressure Laminate. (Specify Laminate / Specify Left Or Right Facing Arm Location)</i></p> <p><b>FDTA-V</b> \$1108 <i>Tablet Arm With 360° Rotation - Sunburst Cherry Veneer. (Specify Finish / Specify Left Or Right Facing Arm Location)</i></p> <p><b>FDTA-C</b> \$1259 <i>Tablet Arm With 360° Rotation - White Solid Surface. (Available In White Only / Specify Left Or Right Facing Arm Location)</i></p> <p><b>Available:</b> Quads Collection</p>	
<p><b>ARTICULATING / SWIVEL TABLET ARM</b></p>  <p>ATA-L Double Articulating / Swivel Tablet Arm</p>  <p>ATA-L w/ CH-1 Black Plastic Cup Holder</p>	<p><b>Overall:</b> 14" Diameter .75"h</p> <hr/> <p><b>ATA-L</b> \$865 <i>Tablet Arm With 360° Rotation - High Pressure Laminate. (Specify Laminate / Specify Left Or Right Facing Arm Location)</i></p> <p><b>ATA-V</b> \$904 <i>Tablet Arm With 360° Rotation - Sunburst Cherry Veneer. (Specify Finish / Specify Left Or Right Facing Arm Location)</i></p> <p><b>ATA-C</b> \$1089 <i>Tablet Arm With 360° Rotation - White Solid Surface. (Available In White Only / Specify Left Or Right Facing Arm Location)</i></p> <p><b>CH-1</b> \$105 <i>Black Plastic Cup Holder (Only Available If Used With Tablet Arm)</i></p> <p><b>CH-2</b> \$157 <i>Spun Aluminum Cup Holder (Only Available If Used With Tablet Arm)</i></p> <p><b>Available:</b> Quads Collection</p>	
<p><b>SOLID WOOD ARM CAPS</b></p> 	<p><b>Overall:</b> 2.5"w (3.75"w "P") 30"d .75"h</p> <hr/> <p><b>QWAC</b> \$193 (Set Of 2) <i>(Specify Finish)</i></p> <p><b>Available:</b> Quads 3 Collection</p>	



CASTERS / POWER / COVERS	OPTION #:	SPECIFICATIONS   LIST PRICES   AVAILABILITY:
<p><b>CASTERS</b></p>  <p>(C1-NL / C1-L) Carpet Caster - 2" Metal Balls</p>  <p>(C2) Antique Bronze Hooded Caster - 2" Rubber Ball</p>	<p><b>Overall:</b> 2"h</p> <hr/> <p><b>C1-NL</b> \$79 (Set Of 2) <i>Non-Locking Carpet Caster - 2" Metal Balls (Additional Finishes Available)</i></p> <p><b>C1-L</b> \$131 (Set Of 2) <i>Locking Carpet Caster - 2" Metal Balls (Additional Finishes Available)</i></p> <p><b>C2</b> \$79 (Set Of 2) <i>Antique Bronze Hooded Caster - 2" Rubber Ball (Additional Finishes Available)</i></p> <p><b>Available:</b> Quads 3 Collection</p>	
<p><b>POWER / DATA MODULE</b></p> 	<p><b>Overall:</b> 5.25"w 1.25"d 4.25"h</p> <hr/> <p><b>PM1</b> \$836 (1-Power / 1-USB 2 Port Simplex Charger Standard) <i>Vertical / Horizontal Mount Power Module. Price Varies By Socket. Contact Customer Service For Quote. (Additional Colors Available)</i></p> <p><b>Available:</b> Quads Collection</p>	
<p><b>CONTRASTING COVERS</b></p> 	<p><b>Overall:</b> n/a</p> <hr/> <p><b>CC</b> \$129 <i>NOTE: If Two Or More Upholsteries Or Leathers Are Used On Any Piece Of Furniture, Then A Contrast Charge Will Apply Per Order. When Using Trinity Upholstery, The Higher Priced Upholstery Grade Will Be Used In Pricing, Unless It's Trinity Leather With Fabric Contrast Welt, Or COM With Trinity Contrast Welt, Then Contact Customer Service For Pricing.</i></p> <p><b>Available:</b> Quads Collection</p>	

# Savoye

---

LOUNGE SEATING

Effective: August 1, 2022

T R I N I T Y

**Date:**

**Page:**

**Modification:**

**Description:**

---

**DESCRIPTION:**

- Upholstery Frames: Plywood
- Seat & Back: High Density Polyurethane Foam Over Plywood
- Legs: Standard Black Powdercoat Over Steel (Optional Polished Stainless Steel Legs Available)
- 10 Year Warranty
- 500 lbs. Weight Rating

**OPTIONS:**

- PSL-1 Polished Stainless Steel Legs .....\$567  
(Replaces Standard Black Powdercoat Legs On Lounge Unit)
- PM1 Power/Data Module (1-Power / 1-USB 2 Port Simplex Charger) .....\$836
- Feather Down & Polyester Pillows Available (See Page 5)
- Tablet Arm / Cup Holder Options (See Savoie Options Pages)

**LOUNGE**

**ITEM #: SPECIFICATIONS | GRADES | LIST PRICES:**

**LOUNGE CHAIR / ARMS LEFT & RIGHT / FULLY UPHOLSTERED**

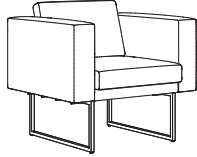

**1001-S**

**Overall:** 32"w 29"d 30"h      **Arm:** 26"h      **COM:** 5.25 yds.  
**Seat:** 22"w 19.75"d 18"h      **Weight:** tbd lbs.      **COL:** 94.5 sq.ft.

COM	COL	1	2	3	4	5	6	7	8	9	10	L1	L2
1560	1716	1750	1887	2024	2162	2299	2437	2574	2712	2849	2987	3135	3630

*Tight Seat & Back*

**ONE PLACE LOUNGE / ARM LEFT / FULLY UPHOLSTERED**

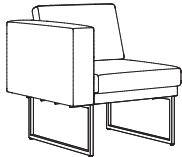

**1002-S**

**Overall:** 27"w 29"d 30"h      **Arm:** 26"h      **COM:** 4.25 yds.  
**Seat:** 22"w 19.75"d 18"h      **Weight:** tbd lbs.      **COL:** 76.5 sq.ft.

COM	COL	1	2	3	4	5	6	7	8	9	10	L1	L2
1359	1495	1505	1615	1725	1835	1945	2055	2164	2274	2384	2494	2615	3010

*Tight Seat & Back*

**ONE PLACE LOUNGE / ARM RIGHT / FULLY UPHOLSTERED**

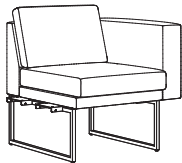

**1003-S**

**Overall:** 27"w 29"d 30"h      **Arm:** 26"h      **COM:** 4.25 yds.  
**Seat:** 22"w 19.75"d 18"h      **Weight:** tbd lbs.      **COL:** 76.5 sq.ft.

COM	COL	1	2	3	4	5	6	7	8	9	10	L1	L2
1359	1495	1505	1615	1725	1835	1945	2055	2164	2274	2384	2494	2615	3010

*Tight Seat & Back*

**ONE PLACE LOUNGE / ARMLESS / FULLY UPHOLSTERED**



Left Hookup



Right Hookup

**1004-S**

**Overall:** 22"w 29"d 30"h      **Arm:** 26"h      **COM:** 3.25 yds.  
**Seat:** 22"w 19.75"d 18"h      **Weight:** tbd lbs.      **COL:** 58.5 sq.ft.

COM	COL	1	2	3	4	5	6	7	8	9	10	L1	L2
1137	1250	1240	1322	1405	1487	1570	1652	1735	1817	1899	1982	2069	2366

*Tight Seat & Back*

Specify Left Or Right Hookup

**ONE PLACE BENCH / FULLY UPHOLSTERED**



Left Hookup

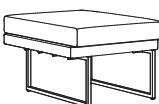

Right Hookup

**1005-B**

**Overall:** 22"w 29"d 18"h      **Arm:** n/a      **COM:** 2.25 yds.  
**Seat:** 22"w 29"d 18"h      **Weight:** tbd lbs.      **COL:** 40.5 sq.ft.

COM	COL	1	2	3	4	5	6	7	8	9	10	L1	L2
945	1039	1003	1058	1113	1168	1223	1278	1333	1388	1443	1498	1557	1755

*Tight Seat & Back*

Specify Left Or Right Hookup

**DESCRIPTION:**

- Upholstery Frames: Plywood
- Seat & Back: High Density Polyurethane Foam Over Plywood
- Legs: Standard Black Powdercoat Over Steel  
(Optional Polished Stainless Steel Legs Available)
- Table: High Pressure Laminate Top
- 10 Year Warranty
- 500 lbs. Weight Rating

**OPTIONS:**

- PSL-1 Polished Stainless Steel Legs .....\$567  
(Replaces Standard Black Powdercoat Legs On Lounge Unit)
  - PM1 Power/Data Module (1-Power / 1-USB 2 Port Simplex Charger) .....\$836
- Feather Down & Polyester Pillows Available (See Page 5)  
Tablet Arm / Cup Holder Options (See Savoie Options Pages)

**LOUNGE**

ITEM #: SPECIFICATIONS | GRADES | LIST PRICES:

**ONE PLACE TABLE**

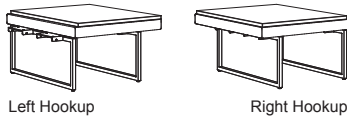

Left Hookup

Right Hookup

1006-T

**Overall:** 22"w 29"d 14"h  
**Seat:** n/a

**Arm:** n/a  
**Weight:** tbd lbs.

**COM:** 1.25 yds.  
**COL:** 22.5 sq.ft.

COM	COL	1	2	3	4	5	6	7	8	9	10	L1	L2
1057	1162	1054	1081	1109	1136	1164	1191	1219	1246	1274	1301	1331	1430

High Pressure Laminate Top

Specify Left Or Right Hookup

**CORNER SEAT / TWO BACKS / FULLY UPHOLSTERED**

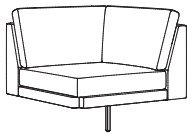

1012-CS

**Overall:** 29"w 29"d 30"h  
**Seat:** 22"w 19.75"d 18"h

**Arm:** n/a  
**Weight:** tbd lbs.

**COM:** 5 yds.  
**COL:** 90 sq.ft.

COM	COL	1	2	3	4	5	6	7	8	9	10	L1	L2
1096	1205	1297	1428	1558	1689	1819	1950	2081	2211	2342	2472	2610	3080

Tight Seat & Back

**CORNER BENCH / FULLY UPHOLSTERED**



1013-CB

**Overall:** 29"w 29"d 18"h  
**Seat:** 29"w 29"d 18"h

**Arm:** n/a  
**Weight:** tbd lbs.

**COM:** 2.25 yds.  
**COL:** 40.5 sq.ft.

COM	COL	1	2	3	4	5	6	7	8	9	10	L1	L2
631	694	707	761	816	871	926	981	1036	1091	1146	1201	1260	1458

Tight Seat

**CORNER TABLE**



1014-CT

**Overall:** 29"w 29"d 14"h  
**Seat:** n/a

**Arm:** n/a  
**Weight:** tbd lbs.

**COM:** 1.25 yds.  
**COL:** 22.5 sq.ft.

COM	COL	1	2	3	4	5	6	7	8	9	10	L1	L2
772	849	784	812	839	867	894	922	949	977	1004	1032	1062	1160

High Pressure Laminate Top

**TWO PLACE SEAT-SEAT / ARMS LEFT & RIGHT / FULLY UPHOLSTERED**

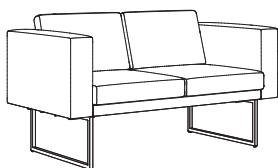

1015-SS

**Overall:** 54"w 29"d 30"h  
**Seat:** 44"w 19.75"d 18"h

**Arm:** 26"h  
**Weight:** tbd lbs.

**COM:** 7 yds.  
**COL:** 126 sq.ft.

COM	COL	1	2	3	4	5	6	7	8	9	10	L1	L2
2125	2338	2380	2566	2751	2937	3123	3308	3494	3679	3865	4050	4261	4929

Tight Seat & Back

**DESCRIPTION:**

- Upholstery Frames: Plywood
- Seat & Back: High Density Polyurethane Foam Over Plywood
- Legs: Standard Black Powdercoat Over Steel  
(Optional Polished Stainless Steel Legs Available)
- Table: High Pressure Laminate Top
- 10 Year Warranty
- 500 lbs. Weight Rating

**OPTIONS:**

- PSL-1 Polished Stainless Steel Legs .....\$567  
(Replaces Standard Black Powdercoat Legs On Lounge Unit)
  - PM1 Power/Data Module (1-Power / 1-USB 2 Port Simplex Charger) .....\$836
- Feather Down & Polyester Pillows Available (See Page 5)  
Tablet Arm / Cup Holder Options (See Savoie Options Pages)

**LOUNGE**

**ITEM #: SPECIFICATIONS | GRADES | LIST PRICES:**

**TWO PLACE SEAT-SEAT / ARM LEFT / FULLY UPHOLSTERED**

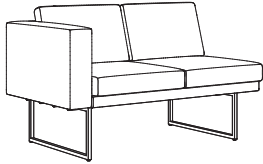

**1016-SS**

**Overall:** 49"w 29"d 30"h  
**Seat:** 44"w 19.75"d 18"h

**Arm:** n/a  
**Weight:** tbd lbs.

**COM:** 6 yds.  
**COL:** 108 sq.ft.

COM	COL	1	2	3	4	5	6	7	8	9	10	L1	L2
1930	2123	2141	2299	2457	2615	2773	2931	3089	3247	3405	3564	3746	4315

*Tight Seat & Back*

**TWO PLACE SEAT-SEAT / ARM RIGHT / FULLY UPHOLSTERED**

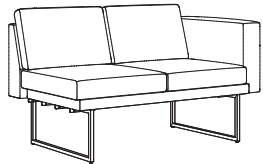

**1017-SS**

**Overall:** 49"w 29"d 30"h  
**Seat:** 44"w 19.75"d 18"h

**Arm:** n/a  
**Weight:** tbd lbs.

**COM:** 6 yds.  
**COL:** 108 sq.ft.

COM	COL	1	2	3	4	5	6	7	8	9	10	L1	L2
1930	2123	2141	2299	2457	2615	2773	2931	3089	3247	3405	3564	3746	4315

*Tight Seat & Back*

**TWO PLACE BENCH-SEAT / ONE ARM RIGHT-BENCH LEFT / FULLY UPHOLSTERED**

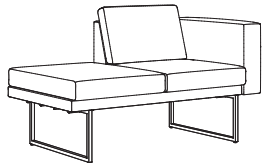

**1018-BS**

**Overall:** 49"w 29"d 30"h  
**Seat:** 44"w 19.75"d 18"h

**Arm:** 26"h  
**Weight:** tbd lbs.

**COM:** 4.75 yds.  
**COL:** 85.5 sq.ft.

COM	COL	1	2	3	4	5	6	7	8	9	10	L1	L2
1767	1944	1918	2042	2166	2289	2413	2537	2661	2784	2908	3032	3182	3627

*Tight Seat & Back*

**TWO PLACE SEAT-BENCH / ONE ARM LEFT-BENCH RIGHT / FULLY UPHOLSTERED**

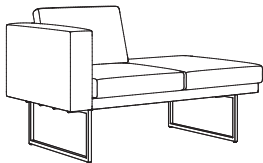

**1019-SB**

**Overall:** 49"w 29"d 30"h  
**Seat:** 44"w 19.75"d 18"h

**Arm:** 26"h  
**Weight:** tbd lbs.

**COM:** 4.75 yds.  
**COL:** 85.5 sq.ft.

COM	COL	1	2	3	4	5	6	7	8	9	10	L1	L2
1767	1944	1918	2042	2166	2289	2413	2537	2661	2784	2908	3032	3182	3627

*Tight Seat & Back*

**TWO PLACE TABLE-SEAT / ONE ARM RIGHT-TABLE LEFT**

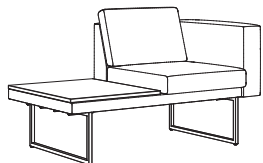

**1020-TS**

**Overall:** 49"w 29"d 30"h  
**Seat:** 22"w 19.75"d 18"h

**Arm:** n/a  
**Weight:** tbd lbs.

**COM:** 3.75 yds.  
**COL:** 67.5 sq.ft.

COM	COL	1	2	3	4	5	6	7	8	9	10	L1	L2
1885	2073	1974	2071	2167	2263	2359	2455	2552	2648	2744	2840	2961	3307

*High Pressure Laminate Top / Tight Seat & Back*

**DESCRIPTION:**

- Upholstery Frames: Plywood
- Seat & Back: High Density Polyurethane Foam Over Plywood
- Legs: Standard Black Powdercoat Over Steel (Optional Polished Stainless Steel Legs Available)
- Table: High Pressure Laminate Top
- 10 Year Warranty
- 500 lbs. Weight Rating

**OPTIONS:**

- PSL-1 Polished Stainless Steel Legs .....\$567  
(Replaces Standard Black Powdercoat Legs On Lounge Unit)
  - PM1 Power/Data Module (1-Power / 1-USB 2 Port Simplex Charger) .....\$836
- Feather Down & Polyester Pillows Available (See Page 5)  
Tablet Arm / Cup Holder Options (See Savoie Options Pages)

**LOUNGE**

**ITEM #: SPECIFICATIONS | GRADES | LIST PRICES:**

**TWO PLACE SEAT-TABLE / ONE ARM LEFT-TABLE RIGHT**

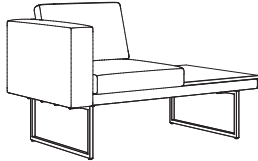

**1021-ST**

**Overall:** 49"w 29"d 30"h      **Arm:** 26"h      **COM:** 3.75 yds.  
**Seat:** 22"w 19.75"d 18"h      **Weight:** tbd lbs.      **COL:** 67.5 sq.ft.

COM	COL	1	2	3	4	5	6	7	8	9	10	L1	L2
1885	2073	1974	2071	2167	2263	2359	2455	2552	2648	2744	2840	2961	3307

*High Pressure Laminate Top / Tight Seat & Back*

**TWO PLACE SEAT-SEAT / ARMLESS / FULLY UPHOLSTERED**

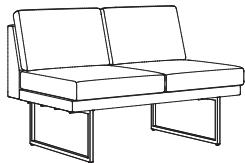

**1022-SS**

**Overall:** 44"w 29"d 30"h      **Arm:** n/a      **COM:** 5 yds.  
**Seat:** 44"w 19.75"d 18"h      **Weight:** tbd lbs.      **COL:** 90 sq.ft.

COM	COL	1	2	3	4	5	6	7	8	9	10	L1	L2
1702	1872	1870	2001	2132	2262	2393	2523	2654	2784	2915	3046	3195	3666

*Tight Seat & Back*

**TWO PLACE BENCH-SEAT / ARMLESS-BENCH LEFT / FULLY UPHOLSTERED**

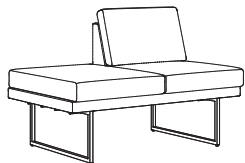

**1023-BS**

**Overall:** 44"w 29"d 30"h      **Arm:** n/a      **COM:** 4.5 yds.  
**Seat:** 44"w 19.75"d 18"h      **Weight:** tbd lbs.      **COL:** 81 sq.ft.

COM	COL	1	2	3	4	5	6	7	8	9	10	L1	L2
1545	1700	1695	1811	1928	2045	2162	2279	2396	2512	2629	2746	2877	3298

*Tight Seat & Back*

**TWO PLACE SEAT-BENCH / ARMLESS-BENCH RIGHT / FULLY UPHOLSTERED**



**1024-SB**

**Overall:** 44"w 29"d 30"h      **Arm:** n/a      **COM:** 4.5 yds.  
**Seat:** 44"w 19.75"d 18"h      **Weight:** tbd lbs.      **COL:** 81 sq.ft.

COM	COL	1	2	3	4	5	6	7	8	9	10	L1	L2
1545	1700	1695	1811	1928	2045	2162	2279	2396	2512	2629	2746	2877	3298

*Tight Seat & Back*

**TWO PLACE TABLE-SEAT / ARMLESS-TABLE LEFT**



**1025-TS**

**Overall:** 44"w 29"d 30"h      **Arm:** n/a      **COM:** 3.5 yds.  
**Seat:** 22"w 19.75"d 18"h      **Weight:** tbd lbs.      **COL:** 63 sq.ft.

COM	COL	1	2	3	4	5	6	7	8	9	10	L1	L2
1663	1829	1751	1840	1929	2019	2108	2197	2287	2376	2465	2555	2656	2978

*High Pressure Laminate Top / Tight Seat & Back*

**DESCRIPTION:**

- Upholstery Frames: Plywood
- Seat & Back: High Density Polyurethane Foam Over Plywood
- Legs: Standard Black Powdercoat Over Steel  
(Optional Polished Stainless Steel Legs Available)
- Table: High Pressure Laminate Top
- 10 Year Warranty
- 500 lbs. Weight Rating

**OPTIONS:**

- PSL-1 Polished Stainless Steel Legs .....\$567  
(Replaces Standard Black Powdercoat Legs On Lounge Unit)
  - PM1 Power/Data Module (1-Power / 1-USB 2 Port Simplex Charger) .....\$836
- Feather Down & Polyester Pillows Available (See Page 5)  
Tablet Arm / Cup Holder Options (See Savoie Options Pages)

**LOUNGE**

**ITEM #: SPECIFICATIONS | GRADES | LIST PRICES:**

**TWO PLACE SEAT-TABLE /  
ARMLESS-TABLE RIGHT**

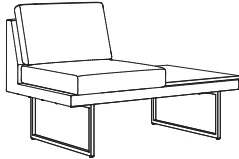

**1026-ST**

**Overall:** 44"w 29"d 30"h      **Arm:** n/a      **COM:** 3.5 yds.  
**Seat:** 22"w 19.75"d 18"h      **Weight:** tbd lbs.      **COL:** 63 sq.ft.

COM	COL	1	2	3	4	5	6	7	8	9	10	L1	L2
1663	1829	1751	1840	1929	2019	2108	2197	2287	2376	2465	2555	2656	2978

*High Pressure Laminate Top / Tight Seat & Back*

**TWO PLACE BENCH-BENCH /  
FULLY UPHOLSTERED**

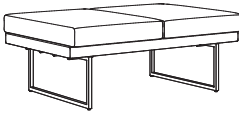

**1027-BB**

**Overall:** 44"w 29"d 18"h      **Arm:** n/a      **COM:** 3.25 yds.  
**Seat:** 44"w 29"d 18"h      **Weight:** tbd lbs.      **COL:** 58.5 sq.ft.

COM	COL	1	2	3	4	5	6	7	8	9	10	L1	L2
1359	1495	1450	1533	1615	1697	1780	1862	1945	2027	2110	2192	2290	2587

*Tight Seat & Back*

**TWO PLACE BENCH-TABLE**

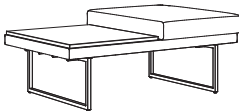

**1028-BT**

**Overall:** 44"w 29"d 18"h      **Arm:** n/a      **COM:** 2.25 yds.  
**Seat:** 22"w 29"d 18"h      **Weight:** tbd lbs.      **COL:** 40.5 sq.ft.

COM	COL	1	2	3	4	5	6	7	8	9	10	L1	L2
1471	1618	1501	1556	1610	1665	1720	1775	1830	1885	1940	1995	2064	2262

*High Pressure Laminate Top / Tight Seat*

**THREE PLACE SEAT-SEAT-SEAT /  
ARMS LEFT & RIGHT / FULLY UPHOLSTERED**

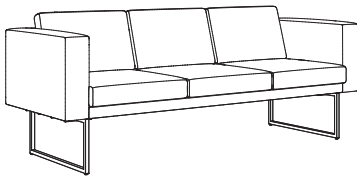

**1030-SSS**

**Overall:** 76"w 29"d 30"h      **Arm:** 26"h      **COM:** 9.25 yds.  
**Seat:** 66"w 19.75"d 18"h      **Weight:** tbd lbs.      **COL:** 166.5 sq.ft.

COM	COL	1	2	3	4	5	6	7	8	9	10	L1	L2
2688	2956	3036	3283	3531	3778	4026	4273	4520	4768	5015	5263	5452	6343

*Tight Seat & Back*

**THREE PLACE SEAT-TABLE-SEAT /  
ARMS LEFT & RIGHT-TABLE CENTER**

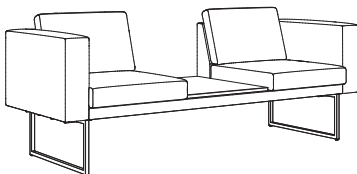

**1031-STS**

**Overall:** 76"w 29"d 30"h      **Arm:** 26"h      **COM:** 8 yds.  
**Seat:** 66"w 19.75"d 18"h      **Weight:** tbd lbs.      **COL:** 144 sq.ft.

COM	COL	1	2	3	4	5	6	7	8	9	10	L1	L2
2562	2818	2849	3062	3275	3488	3701	3914	4127	4340	4553	4766	5004	5771

*High Pressure Laminate Top / Tight Seat & Back*



**DESCRIPTION:**

- Upholstery Frames: Plywood
- Seat & Back: High Density Polyurethane Foam Over Plywood
- Legs: Standard Black Powdercoat Over Steel (Optional Polished Stainless Steel Legs Available)
- Table: High Pressure Laminate Top
- 10 Year Warranty
- 500 lbs. Weight Rating

**OPTIONS:**

- PSL-1 Polished Stainless Steel Legs .....\$567  
(Replaces Standard Black Powdercoat Legs On Lounge Unit)
  - PM1 Power/Data Module (1-Power / 1-USB 2 Port Simplex Charger) .....\$836
- Feather Down & Polyester Pillows Available (See Page 5)  
Tablet Arm / Cup Holder Options (See Savoie Options Pages)

**LOUNGE**

**ITEM #: SPECIFICATIONS | GRADES | LIST PRICES:**

**THREE PLACE SEAT-SEAT-SEAT / ONE ARM LEFT / FULLY UPHOLSTERED**

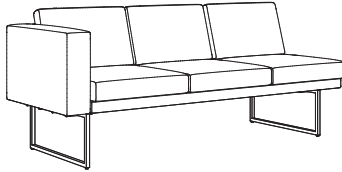

**1032-SSS**

**Overall:** 71"w 29"d 30"h  
**Seat:** 66"w 19.75"d 18"h

**Arm:** 26"h  
**Weight:** tbd lbs.

**COM:** 8.5 yds.  
**COL:** 153 sq.ft.

COM	COL	1	2	3	4	5	6	7	8	9	10	L1	L2
2395	2635	2718	2945	3172	3398	3625	3852	4079	4306	4532	4759	5018	5834

*Tight Seat & Back*

**THREE PLACE SEAT-SEAT-SEAT / ONE ARM RIGHT / FULLY UPHOLSTERED**

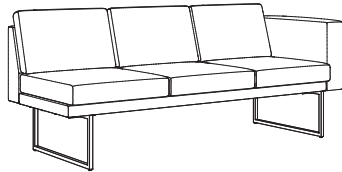

**1033-SSS**

**Overall:** 71"w 29"d 30"h  
**Seat:** 66"w 19.75"d 18"h

**Arm:** 26"h  
**Weight:** tbd lbs.

**COM:** 8.5 yds.  
**COL:** 153 sq.ft.

COM	COL	1	2	3	4	5	6	7	8	9	10	L1	L2
2395	2635	2718	2945	3172	3398	3625	3852	4079	4306	4532	4759	5018	5834

*Tight Seat & Back*

**THREE PLACE SEAT-TABLE-SEAT / ONE ARM LEFT-TABLE CENTER**

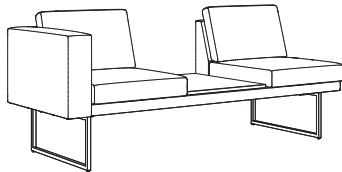

**1034-ST5**

**Overall:** 71"w 29"d 30"h  
**Seat:** 44"w 19.75"d 18"h

**Arm:** 26"h  
**Weight:** tbd lbs.

**COM:** 7 yds.  
**COL:** 126 sq.ft.

COM	COL	1	2	3	4	5	6	7	8	9	10	L1	L2
2373	2610	2615	2800	2986	3171	3357	3542	3728	3914	4099	4285	4495	4495

*High Pressure Laminate Top / Tight Seat & Back*

**THREE PLACE SEAT-TABLE-SEAT / ONE ARM RIGHT-TABLE CENTER**

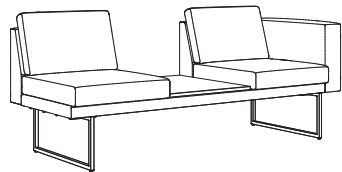

**1035-ST5**

**Overall:** 71"w 29"d 30"h  
**Seat:** 44"w 19.75"d 18"h

**Arm:** 26"h  
**Weight:** tbd lbs.

**COM:** 7 yds.  
**COL:** 126 sq.ft.

COM	COL	1	2	3	4	5	6	7	8	9	10	L1	L2
2373	2610	2615	2800	2986	3171	3357	3542	3728	3914	4099	4285	4495	4495

*High Pressure Laminate Top / Tight Seat & Back*

**THREE PLACE BENCH-SEAT-SEAT / ONE ARM RIGHT-BENCH LEFT / FULLY UPHOLSTERED**

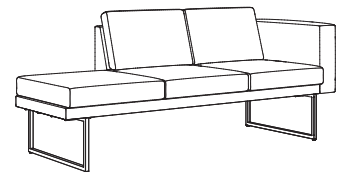

**1036-BSS**

**Overall:** 71"w 29"d 30"h  
**Seat:** 66"w 19.75"d 18"h

**Arm:** 26"h  
**Weight:** tbd lbs.

**COM:** 8 yds.  
**COL:** 144 sq.ft.

COM	COL	1	2	3	4	5	6	7	8	9	10	L1	L2
2232	2456	2537	2750	2963	3176	3389	3602	3815	4028	4241	4454	4694	5461

*Tight Seat & Back*

**DESCRIPTION:**

- Upholstery Frames: Plywood
- Seat & Back: High Density Polyurethane Foam Over Plywood
- Legs: Standard Black Powdercoat Over Steel (Optional Polished Stainless Steel Legs Available)
- Table: High Pressure Laminate Top
- 10 Year Warranty
- 500 lbs. Weight Rating

**OPTIONS:**

- PSL-1 Polished Stainless Steel Legs .....\$567  
(Replaces Standard Black Powdercoat Legs On Lounge Unit)
  - PM1 Power/Data Module (1-Power / 1-USB 2 Port Simplex Charger) .....\$836
- Feather Down & Polyester Pillows Available (See Page 5)  
Tablet Arm / Cup Holder Options (See Savoie Options Pages)

**LOUNGE**

**ITEM #: SPECIFICATIONS | GRADES | LIST PRICES:**

**THREE PLACE SEAT-SEAT-BENCH / ONE ARM LEFT-BENCH RIGHT / FULLY UPHOLSTERED**

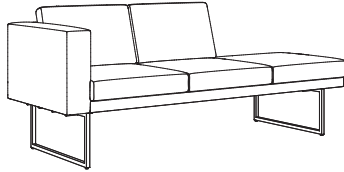

**1037-SSB**

**Overall:** 71"w 29"d 30"h      **Arm:** 26"h      **COM:** 8 yds.  
**Seat:** 66"w 19.75"d 18"h      **Weight:** tbd lbs.      **COL:** 144 sq.ft.

COM	COL	1	2	3	4	5	6	7	8	9	10	L1	L2
2232	2456	2537	2750	2963	3176	3389	3602	3815	4028	4241	4454	4694	5461

*Tight Seat & Back*

**THREE PLACE TABLE-SEAT-SEAT / ONE ARM RIGHT-TABLE LEFT**

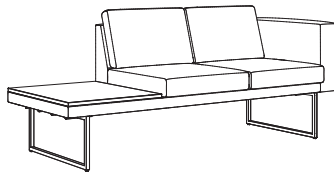

**1038-TSS**

**Overall:** 71"w 29"d 30"h      **Arm:** 26"h      **COM:** 7 yds.  
**Seat:** 44"w 19.75"d 18"h      **Weight:** tbd lbs.      **COL:** 126 sq.ft.

COM	COL	1	2	3	4	5	6	7	8	9	10	L1	L2
2379	2617	2620	2806	2991	3177	3362	3548	3733	3919	4105	4290	4501	5169

*High Pressure Laminate Top / Tight Seat & Back*

**THREE PLACE SEAT-SEAT-TABLE / ONE ARM LEFT-TABLE RIGHT**

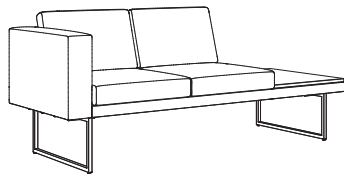

**1039-SST**

**Overall:** 71"w 29"d 30"h      **Arm:** 26"h      **COM:** 7 yds.  
**Seat:** 44"w 19.75"d 18"h      **Weight:** tbd lbs.      **COL:** 126 sq.ft.

COM	COL	1	2	3	4	5	6	7	8	9	10	L1	L2
2379	2617	2620	2806	2991	3177	3362	3548	3733	3919	4105	4290	4501	5169

*High Pressure Laminate Top / Tight Seat & Back*

**THREE PLACE SEAT-SEAT-SEAT / ARMLESS / FULLY UPHOLSTERED**

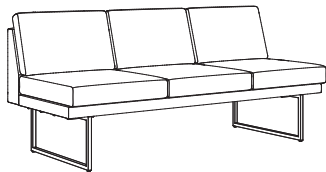

**1040-SSS**

**Overall:** 66"w 29"d 30"h      **Arm:** n/a      **COM:** 7.25 yds.  
**Seat:** 66"w 19.75"d 18"h      **Weight:** tbd lbs.      **COL:** 130.5 sq.ft.

COM	COL	1	2	3	4	5	6	7	8	9	10	L1	L2
2222	2444	2485	2678	2870	3063	3255	3448	3640	3832	4025	4217	4435	5128

*Tight Seat & Back*

**THREE PLACE BENCH-SEAT-SEAT / ARMLESS-BENCH LEFT / FULLY UPHOLSTERED**

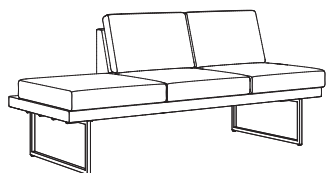

**1041-BSS**

**Overall:** 66"w 29"d 30"h      **Arm:** n/a      **COM:** 7 yds.  
**Seat:** 66"w 19.75"d 18"h      **Weight:** tbd lbs.      **COL:** 126 sq.ft.

COM	COL	1	2	3	4	5	6	7	8	9	10	L1	L2
2010	2211	2272	2457	2643	2828	3014	3199	3385	3571	3756	3942	4149	4817

*Tight Seat & Back*

**DESCRIPTION:**

- Upholstery Frames: Plywood
- Seat & Back: High Density Polyurethane Foam Over Plywood
- Legs: Standard Black Powdercoat Over Steel  
(Optional Polished Stainless Steel Legs Available)
- Table: High Pressure Laminate Top
- 10 Year Warranty
- 500 lbs. Weight Rating

**OPTIONS:**

- PSL-1 Polished Stainless Steel Legs .....\$567  
(Replaces Standard Black Powdercoat Legs On Lounge Unit)
  - PM1 Power/Data Module (1-Power / 1-USB 2 Port Simplex Charger) .....\$836
- Feather Down & Polyester Pillows Available (See Page 5)  
Tablet Arm / Cup Holder Options (See Savoie Options Pages)

**LOUNGE**

**ITEM #: SPECIFICATIONS | GRADES | LIST PRICES:**

**THREE PLACE SEAT-SEAT-BENCH /  
ARMLESS-BENCH RIGHT / FULLY UPHOLSTERED**

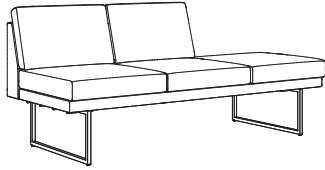

**1042-SSB**

**Overall:** 66"w 29"d 30"h      **Arm:** n/a      **COM:** 7 yds.  
**Seat:** 66"w 19.75"d 18"h      **Weight:** tbd lbs.      **COL:** 126 sq.ft.

COM	COL	1	2	3	4	5	6	7	8	9	10	L1	L2
2010	2211	2272	2457	2643	2828	3014	3199	3385	3571	3756	3942	4149	4817

*Tight Seat & Back*

**THREE PLACE TABLE-SEAT-SEAT /  
ARMLESS-TABLE LEFT**

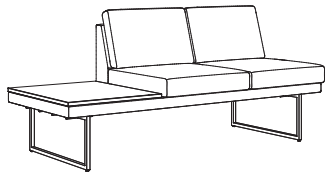

**1043-TSS**

**Overall:** 66"w 29"d 30"h      **Arm:** n/a      **COM:** 6 yds.  
**Seat:** 44"w 19.75"d 18"h      **Weight:** tbd lbs.      **COL:** 108 sq.ft.

COM	COL	1	2	3	4	5	6	7	8	9	10	L1	L2
2128	2340	2328	2486	2644	2802	2960	3118	3276	3434	3592	3750	3928	4497

*High Pressure Laminate Top / Tight Seat & Back*

**THREE PLACE SEAT-SEAT-TABLE /  
ARMLESS-TABLE RIGHT**

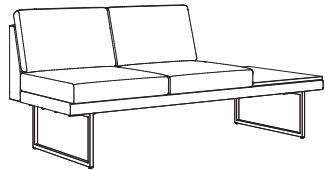

**1044-SST**

**Overall:** 66"w 29"d 30"h      **Arm:** n/a      **COM:** 6 yds.  
**Seat:** 44"w 19.75"d 18"h      **Weight:** tbd lbs.      **COL:** 108 sq.ft.

COM	COL	1	2	3	4	5	6	7	8	9	10	L1	L2
2128	2340	2328	2486	2644	2802	2960	3118	3276	3434	3592	3750	3928	4497

*High Pressure Laminate Top / Tight Seat & Back*

**THREE PLACE SEAT-TABLE-SEAT /  
ARMLESS-TABLE CENTER**

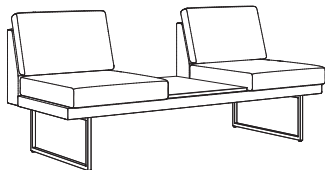

**1045-ST5**

**Overall:** 66"w 29"d 30"h      **Arm:** n/a      **COM:** 6 yds.  
**Seat:** 44"w 19.75"d 18"h      **Weight:** tbd lbs.      **COL:** 108 sq.ft.

COM	COL	1	2	3	4	5	6	7	8	9	10	L1	L2
2151	2366	2350	2508	2666	2824	2982	3140	3298	3456	3614	3772	3950	4519

*High Pressure Laminate / Tight Seat & Back*

**THREE PLACE BENCH-BENCH-BENCH /  
FULLY UPHOLSTERED**

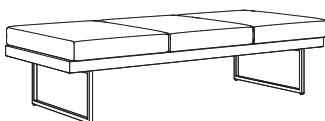

**1046-BBB**

**Overall:** 66"w 29"d 18"h      **Arm:** n/a      **COM:** 4.75 yds.  
**Seat:** 66"w 29"d 18"h      **Weight:** tbd lbs.      **COL:** 85.5 sq.ft.

COM	COL	1	2	3	4	5	6	7	8	9	10	L1	L2
1622	1784	1781	1905	2028	2152	2276	2399	2523	2647	2770	2894	3030	3475

*Tight Seat*

**DESCRIPTION:**

- Upholstery Frames: Plywood
- Seat & Back: High Density Polyurethane Foam Over Plywood
- Legs: Standard Black Powdercoat Over Steel  
(Optional Polished Stainless Steel Legs Available)
- Table: High Pressure Laminate Top
- 10 Year Warranty
- 500 lbs. Weight Rating

**OPTIONS:**

- PSL-1 Polished Stainless Steel Legs .....\$567  
(Replaces Standard Black Powdercoat Legs On Lounge Unit)
- PSL-2 Polished Stainless Steel Legs .....\$711  
(Replaces Standard Black Powdercoat Legs On End Table)
- PSL-3 Polished Stainless Steel Legs .....\$686  
(Replaces Standard Black Powdercoat Legs On Coffee Table)
- PM1 Power/Data Module (1-Power / 1-USB 2 Port Simplex Charger) .....\$836

Tablet Arm / Cup Holder Options (See Savoie Options Pages)

**LOUNGE / TABLES**

ITEM #: SPECIFICATIONS | GRADES | LIST PRICES:

**THREE PLACE BENCH-BENCH-TABLE / TABLE RIGHT**

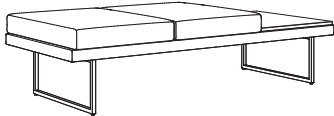

1047-BBT

**Overall:** 66"w 29"d 18"h      **Arm:** n/a      **COM:** 3.75 yds.  
**Seat:** 44"w 29"d 18"h      **Weight:** tbd lbs.      **COL:** 67.5 sq.ft.

COM	COL	1	2	3	4	5	6	7	8	9	10	L1	L2
1791	1970	1885	1981	2078	2174	2270	2366	2463	2559	2655	2751	2867	3214

*High Pressure Laminate Top / Tight Seat*

**THREE PLACE BENCH-TABLE-BENCH / TABLE CENTER**

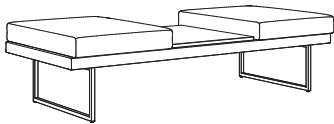

1048-BTB

**Overall:** 66"w 29"d 18"h      **Arm:** n/a      **COM:** 3.75 yds.  
**Seat:** 44"w 29"d 18"h      **Weight:** tbd lbs.      **COL:** 67.5 sq.ft.

COM	COL	1	2	3	4	5	6	7	8	9	10	L1	L2
1791	1970	1885	1981	2078	2174	2270	2366	2463	2559	2655	2751	2867	3214

*High Pressure Laminate Top / Tight Seat*

**END TABLE**

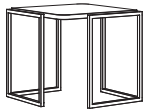

102020-L

102020-C

**Overall:** 20"w 20"d 20"h      **Weight:** 38 lbs.

COM	COL	1	2	3	4	5	6	7	8	9	10	L1	L2
1058													

*High Pressure Laminate Top*

Call For Pricing  
*Solid Surface Top*

**COFFEE TABLE**

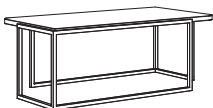

102242-L

102242-C

**Overall:** 22"w 42"d 16"h      **Weight:** 52 lbs.

COM	COL	1	2	3	4	5	6	7	8	9	10	L1	L2
1621													

*High Pressure Laminate Top*

Call For Pricing  
*Solid Surface Top*

CONTRASTING COVERS	OPTION #:	SPECIFICATIONS   LIST PRICES   AVAILABILITY:
<p><b>POLISHED STAINLESS STEEL LEGS</b></p>  <p>PSL-1</p>  <p>PSL-2</p>  <p>PSL-3</p>	<p><b>Overall:</b> n/a</p> <p><b>PSL-1</b> \$567 <i>Replaces Standard Black Powdercoat Legs On Lounge Unit With Polished Stainless Steel Legs.</i></p> <p><b>PSL-2</b> \$711 <i>Replaces Standard Black Powdercoat Legs On End Table With Polished Stainless Steel Legs.</i></p> <p><b>PSL-3</b> \$686 <i>Replaces Standard Black Powdercoat Legs On Coffee Table With Polished Stainless Steel Legs.</i></p> <p><b>Available:</b> <b>Savoie Collection</b></p>	
<p><b>TABLET ARMS / CUP HOLDER</b></p>  <p>Laminate Tablet Arm Shown w/ Cup Holder</p>  <p>Veneer Tablet Arm Shown w/ Cup Holder</p>  <p>Solid Surface Tablet Arm Shown w/ Cup Holder</p>	<p><b>Overall:</b> 14" Diameter .75"h</p> <p><b>TA-L</b> \$440 <i>Tablet Arm With 360° Rotation - High Pressure Laminate. (Specify Laminate / Specify Left Or Right Facing Arm Location)</i></p> <p><b>TA-V</b> \$503 <i>Tablet Arm With 360° Rotation - Sunburst Cherry Veneer. (Specify Finish / Specify Left Or Right Facing Arm Location)</i></p> <p><b>TA-C</b> \$654 <i>Tablet Arm With 360° Rotation - White Solid Surface. (Available In White Only / Specify Left Or Right Facing Arm Location)</i></p> <p><b>CH-1</b> \$105 <i>Black Plastic Cup Holder (Only Available If Used With Tablet Arm)</i></p> <p><b>CH-2</b> \$157 <i>Spun Aluminum Cup Holder (Only Available If Used With Tablet Arm)</i></p> <p><b>Available:</b> <b>Savoie Lounge</b></p>	
<p><b>FOLD DOWN TABLET ARM</b></p>  	<p><b>Overall:</b> 14" Diameter .75"h</p> <p><b>FDTA-L</b> \$1056 <i>Tablet Arm With 360° Rotation - High Pressure Laminate. (Specify Laminate / Specify Left Or Right Facing Arm Location)</i></p> <p><b>FDTA-V</b> \$1108 <i>Tablet Arm With 360° Rotation - Sunburst Cherry Veneer. (Specify Finish / Specify Left Or Right Facing Arm Location)</i></p> <p><b>FDTA-C</b> \$1259 <i>Tablet Arm With 360° Rotation - White Solid Surface. (Available In White Only / Specify Left Or Right Facing Arm Location)</i></p> <p><b>Available:</b> <b>Savoie Lounge</b></p>	
<p><b>POWER / DATA MODULE</b></p> 	<p><b>Overall:</b> 5.25"w 1.25"d 4.25"h</p> <p><b>PM1</b> \$836 (1-Power / 1-USB 2 Port Simplex Charger Standard) <i>Vertical / Horizontal Mount Power Module. Price Varies By Socket. Contact Customer Service For Quote. (Additional Colors Available)</i></p> <p><b>Available:</b> <b>Savoie Collection</b></p>	
<p><b>CONTRASTING COVERS</b></p> 	<p><b>Overall:</b> n/a</p> <p><b>CC</b> \$129 <i>NOTE: If Two Or More Upholsteries Or Leathers Are Used On Any Piece Of Furniture, Then A Contrast Charge Will Apply Per Order. When Using Trinity Upholstery, The Higher Priced Upholstery Grade Will Be Used In Pricing, Unless It's Trinity Leather With Fabric Contrast Welt, Or COM With Trinity Contrast Welt, Then Contact Customer Service For Pricing.</i></p> <p><b>Available:</b> <b>Savoie Collection</b></p>	

Ace

---

WALLSAVER RECLINER

Effective: August 1, 2022

T R I N I T Y

**Date:**

**Page:**

**Modification:**

**Description:**

---

**DESCRIPTION:**

- Upholstery Frames: Steel, Plywood & Hardwood
- Removable Seat: High Density Polyurethane Foam Over Sheet Webbing
- Back: High Density Polyurethane Foam Over Contoured Curved Plywood Back
- Upholstered Covers On Seat & Back: Attached w/ Velcro / Removable For Maintenance
- Antimicrobial Moisture Barrier Fully Encapsulates All Foam Areas On Seat & Back
- Double Needle Stitching Standard
- Leather Upholstery Available
- 10 Year Warranty

**OPTIONS:**

- SSAC Solid Surface Arm Caps (Set Of 2) ..... \$702
  - VAC Vinyl Arm Caps (Set Of 2) ..... \$297
  - PP Power Port ..... \$243
  - PDM Power/Data Module ..... \$836
  - HM Heat & Massage (Back Only) ..... \$918
  - H Heat ..... \$810
  - NRS Non-Removable Seat ..... \$54
- Feather Down & Polyester Pillows Available (See Page 5)  
Specify Exposed Wood Finish (See Page 6)

**WALLSAVER**

ITEM #:

SPECIFICATIONS | GRADES | LIST PRICES:

**WALLSAVER RECLINER / TAPERED WOODEN LEGS / FULLY UPHOLSTERED**

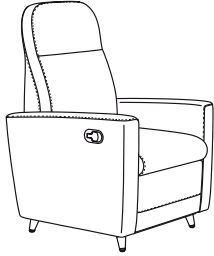

Healthcare Motion

1055-A

**Overall:** 29"w 33"d 46.5"h      **Arm:** 27"h  
**Seat:** 21"w 21.5"d 19.5"h      **Weight:**      **COM:** 5.75 yds.  
**COL:** 103.5 sq.ft.

COM	COL	1	2	3	4	5	6	7	8	9	10	L1	L2
2048	2253	2186	2311	2437	2563	2689	2814	2940	3066	3191	3317	3469	3921

*Tight Seat & Back / Removable Seat & Back Upholstery / 7" Wall Proximity / 350 lb. Weight Capacity*

**WALLSAVER RECLINER / 360° SWIVEL BASE / FULLY UPHOLSTERED**

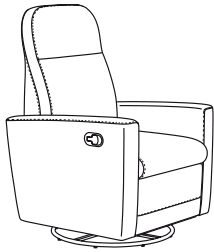

Healthcare Motion

1055-B

**Overall:** 29"w 33"d 46.5"h      **Arm:** 27"h  
**Seat:** 21"w 21.5"d 18"h      **Weight:**      **COM:** 5.75 yds.  
**COL:** 103.5 sq.ft.

COM	COL	1	2	3	4	5	6	7	8	9	10	L1	L2
2012	2213	2152	2278	2403	2529	2655	2781	2906	3032	3158	3283	3435	3887

*Tight Seat & Back / Removable Seat & Back Upholstery / 7" Wall Proximity / 350 lb. Weight Capacity*

**WALLSAVER RECLINER / CASTERS / FULLY UPHOLSTERED**

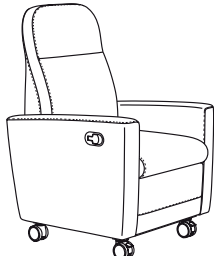

Healthcare Motion

1055-C

**Overall:** 29"w 33"d 46.5"h      **Arm:** 27"h  
**Seat:** 21"w 21.5"d 19.5"h      **Weight:**      **COM:** 5.75 yds.  
**COL:** 103.5 sq.ft.

COM	COL	1	2	3	4	5	6	7	8	9	10	L1	L2
2061	2267	2198	2323	2449	2575	2701	2826	2952	3078	3203	3329	3481	3933

*Tight Seat & Back / Removable Seat & Back Upholstery / 7" Wall Proximity / 350 lb. Weight Capacity*

**WALLSAVER RECLINER / TAPERED BRUSHED ALUMINUM LEGS / FULLY UPHOLSTERED**

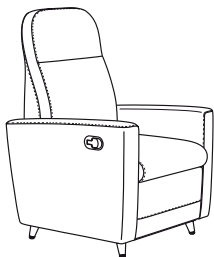

Healthcare Motion

1055-D

**Overall:** 29"w 33"d 46.5"h      **Arm:** 27"h  
**Seat:** 21"w 21.5"d 19.5"h      **Weight:**      **COM:** 5.75 yds.  
**COL:** 103.5 sq.ft.

COM	COL	1	2	3	4	5	6	7	8	9	10	L1	L2
2191	2410	2321	2447	2572	2698	2824	2950	3075	3201	3327	3453	3604	4057

*Tight Seat & Back / Removable Seat & Back Upholstery / 7" Wall Proximity / 350 lb. Weight Capacity*



ARM CAPS / POWER / COVERS	OPTION #:	SPECIFICATIONS   LIST PRICES   AVAILABILITY:
<p><b>ARM CAPS</b></p> 	<p><b>Overall:</b> 2.5"w 28"d .25"h</p> <hr/> <p><b>SSAC</b> \$702 (Set Of 2) Solid Surface <i>Glacier White Arm Cap (Additional Colors Available)</i></p> <p><b>VAC</b> \$297 (Set Of 2) Vinyl <i>Vinyl Arm Cap (Specify Upholstery)</i></p> <p><b>Available:</b> Ace Collection</p>	
<p><b>POWER PORTS</b></p> 	<p><b>Overall:</b> 5.25"w 1.25"d 4.25"h</p> <hr/> <p><b>PP</b> \$243 <i>Power Port</i></p> <p><b>PM1</b> \$836 (1-Power / 1-USB 2 Port Simplex Charger Standard) <i>Vertical / Horizontal Mount Power Module. Price Varies By Socket. Contact Customer Service For Quote. (Additional Colors Available)</i></p> <p><b>Available:</b> Ace Collection</p>	
<p><b>HEAT &amp; MASSAGE</b></p>  <p>HM Heat &amp; Massage (All Recliner Models)</p> <p>H Heat (All Recliner Models)</p>	<p><b>Overall:</b> N/A</p> <hr/> <p><b>HM</b> \$918 Heat &amp; Massage <i>Add Heat &amp; Massage To Any Wallsaver, Layflat, Or Standup Electric Recliner - Surface Mounts On Inside Arm (Specify Left Or Right Facing)</i></p> <p><b>H</b> \$810 Heat <i>Add Heat Only To Any Wallsaver, Layflat, Or Standup Electric Recliner - Surface Mounts On Inside Arm (Specify Left Or Right Facing)</i></p> <p><b>Available:</b> Ace Collection</p>	
<p><b>Non-Removable Seat</b></p>	<p><b>Overall:</b></p> <hr/> <p><b>NRS</b> \$54 Non-Removable Seat</p> <p><b>Available:</b> Ace Collection</p>	
<p><b>CONTRASTING COVERS</b></p> 	<p><b>Overall:</b> N/A</p> <hr/> <p><b>CC</b> \$129 <i>NOTE: If Two Or More Upholsteries Or Leathers Are Used On Any Piece Of Furniture, Then A Contrast Charge Will Apply Per Order. When Using Trinity Upholstery, The Higher Priced Upholstery Grade Will Be Used In Pricing, Unless It's Trinity Leather With Fabric Contrast Welt, Or COM With Trinity Contrast Welt, Then Contact Customer Service For Pricing.</i></p> <p><b>Available:</b> Austen Guest / Tandem Collection</p>	

# Austen

---

GUEST / TANDEM / TABLES

Effective: August 1, 2022

T R I N I T Y

**Date:**

**Page:**

**Modification:**

**Description:**

---

**DESCRIPTION:**

- Upholstery Frames: Steel, Plywood & Hardwood
- Seat: High Density Polyurethane Foam Over Strap Webbing
- Back: High Density Polyurethane Foam Over Plywood
- Upholstered Covers: Stapled On Seat & Back
- Urethane Arm Caps - Standard
- Exposed Metal Legs: 14 Gauge Steel Tubing / Powder Coated (Wallsaver Back Legs)
- Leather Upholstery Not Available
- Adjustable Height Leveling Glides Standard
- 10 Year Warranty

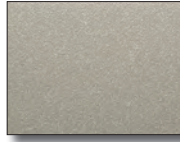

Leg Color: Champagne

**OPTIONS:**

- EPAC-1 Black Polyester Arm Caps (Set Of 2).....\$355
- AWAC-1 Wood Arm Caps (Set Of 2)..... Call For Pricing
- ARC-1 Removable Upholstery Covers Attached w/ Velcro (1922-1923)..... \$62 COM
- CC Contrasting Covers .....\$129

*All Austen Components Are Field Replaceable.*

*NOTE: All Seating Configurations Are Viewed From Left To Right Facing. Please Attach A Layout Showing Seating Configuration w/ Your Order. Assembled Units Must Be Shipped In Configurations Of 3 Or Less.*

**GUEST / TANDEM**

ITEM #:

SPECIFICATIONS | GRADES | LIST PRICES:

**ARM SIDE CHAIR / URETHANE ARMS**

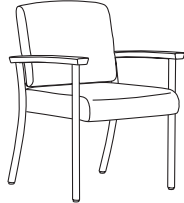

1922

<b>Overall:</b> 23.25"w 25.5"d 34"h		<b>Arm:</b> 25"h		<b>COM:</b> 1.75 yds.									
<b>Seat:</b> 20"w 18.25"d 18.5"h		<b>Weight:</b> 45 lbs.		<b>COL:</b> n/a									
COM	COL	1	2	3	4	5	6	7	8	9	10	L1	L2
1254	N/A	1261	1282	1315	1347	1379	1411	1443	1475	1507	1539	N/A	N/A

*Open Back / Tight Seat & Back*

**ARM CHAIR / URETHANE ARMS / ACCEPTS SEAT ON RIGHT**

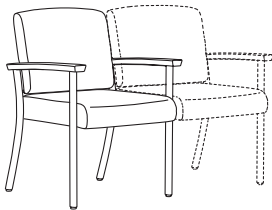

1922-C

<b>Overall:</b> 23.25"w 25.5"d 34"h		<b>Arm:</b> 25"h		<b>COM:</b> 1.75 yds.									
<b>Seat:</b> 20"w 18.25"d 18.5"h		<b>Weight:</b> 45 lbs.		<b>COL:</b> n/a									
COM	COL	1	2	3	4	5	6	7	8	9	10	L1	L2
1254	N/A	1261	1282	1315	1347	1379	1411	1443	1475	1507	1539	N/A	N/A

*Open Back / Tight Seat & Back*

**ARM CHAIR / URETHANE ARMS / ACCEPTS TABLE ON RIGHT**

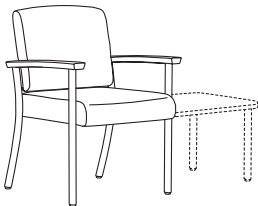

1922-T

<b>Overall:</b> 23.25"w 25.5"d 34"h		<b>Arm:</b> 25"h		<b>COM:</b> 1.75 yds.									
<b>Seat:</b> 20"w 18.25"d 18.5"h		<b>Weight:</b> 45 lbs.		<b>COL:</b> n/a									
COM	COL	1	2	3	4	5	6	7	8	9	10	L1	L2
1254	N/A	1261	1282	1315	1347	1379	1411	1443	1475	1507	1539	N/A	N/A

*Open Back / Tight Seat & Back*

**ARM CHAIR / URETHANE ARMS / ACCEPTS TABLE ON LEFT**

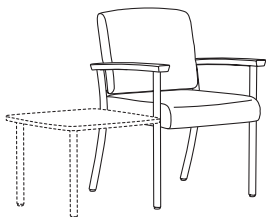

1922-LT

<b>Overall:</b> 23.25"w 25.5"d 34"h		<b>Arm:</b> 25"h		<b>COM:</b> 1.75 yds.									
<b>Seat:</b> 20"w 18.25"d 18.5"h		<b>Weight:</b> 45 lbs.		<b>COL:</b> n/a									
COM	COL	1	2	3	4	5	6	7	8	9	10	L1	L2
1254	N/A	1261	1282	1315	1347	1379	1411	1443	1475	1507	1539	N/A	N/A

*Open Back / Tight Seat & Back*

**DESCRIPTION:**

- Upholstery Frames: Steel, Plywood & Hardwood
- Seat: High Density Polyurethane Foam Over Strap Webbing
- Back: High Density Polyurethane Foam Over Plywood
- Upholstered Covers: Stapled On Seat & Back
- Urethane Arm Caps - Standard
- Exposed Metal Legs: 14 Gauge Steel Tubing / Powder Coated (Wallsaver Back Legs)
- Leather Upholstery Not Available
- Adjustable Height Leveling Glides Standard
- 10 Year Warranty

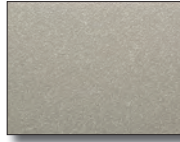

Leg Color: Champagne

**OPTIONS:**

- EPAC-1 Black Polyester Arm Caps (Set Of 2).....\$355
- AWAC-1 Wood Arm Caps (Set Of 2)..... Call For Pricing
- ARC-1 Removable Upholstery Covers Attached w/ Velcro (1922-1923)..... \$62 COM
- CC Contrasting Covers .....\$129

*All Austen Components Are Field Replaceable.*

*NOTE: All Seating Configurations Are Viewed From Left To Right Facing. Please Attach A Layout Showing Seating Configuration w/ Your Order. Assembled Units Must Be Shipped In Configurations Of 3 Or Less.*

**TANDEM**

ITEM #:

SPECIFICATIONS | GRADES | LIST PRICES:

**ARM CHAIR / URETHANE ARMS / ACCEPTS TABLE ON LEFT / SEAT ON RIGHT**

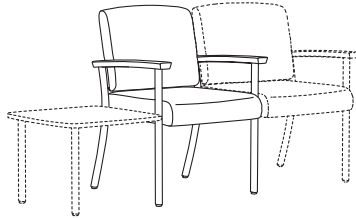

1922-TC

**Overall:** 23.25"w 25.5"d 34"h      **Arm:** 25"h      **COM:** 1.75 yds.  
**Seat:** 20"w 18.25"d 18.5"h      **Weight:** 45 lbs.      **COL:** n/a

COM	COL	1	2	3	4	5	6	7	8	9	10	L1	L2
1254	N/A	1261	1282	1315	1347	1379	1411	1443	1475	1507	1539	N/A	N/A

*Open Back / Tight Seat & Back*

**ARM CHAIR / URETHANE ARMS / ACCEPTS TABLE ON LEFT / RIGHT**

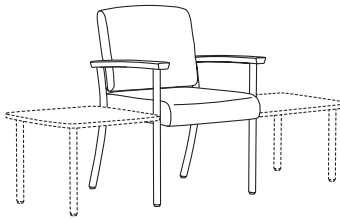

1922-TT

**Overall:** 23.25"w 25.5"d 34"h      **Arm:** 25"h      **COM:** 1.75 yds.  
**Seat:** 20"w 18.25"d 18.5"h      **Weight:** 45 lbs.      **COL:** n/a

COM	COL	1	2	3	4	5	6	7	8	9	10	L1	L2
1254	N/A	1261	1282	1315	1347	1379	1411	1443	1475	1507	1539	N/A	N/A

*Open Back / Tight Seat & Back*

**DESCRIPTION:**

- Upholstery Frames: Steel, Plywood & Hardwood
- Seat: High Density Polyurethane Foam Over Strap Webbing
- Back: High Density Polyurethane Foam Over Plywood
- Upholstered Covers: Stapled On Seat & Back
- Urethane Arm Caps - Standard
- Exposed Metal Legs: 14 Gauge Steel Tubing / Powder Coated (Wallsaver Back Legs, Except 1925 Patient Chair)
- Leather Upholstery Not Available
- Adjustable Height Leveling Glides Standard
- 10 Year Warranty

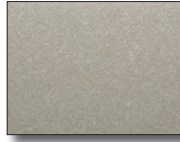

Leg Color: Champagne

**OPTIONS:**

- EPAC-1 Black Polyester Arm Caps (Set Of 2).....\$355
- AWAC-1 Wood Arm Caps (Set Of 2)..... Call For Pricing
- ARC-1 Removable Upholstery Covers Attached w/ Velcro (1922-1923)..... \$62 COM
- ARC-2 Removable Upholstery Covers Attached w/ Velcro (1925)..... \$73 COM
- CC Contrasting Covers.....\$129

All Austen Components Are Field Replaceable.

NOTE: All Seating Configurations Are Viewed From Left To Right Facing. Please Attach A Layout Showing Seating Configuration w/ Your Order. Assembled Units Must Be Shipped In Configurations Of 3 Or Less.

**TANDEM**

ITEM #:

SPECIFICATIONS | GRADES | LIST PRICES:

**ADD-A-SEAT / URETHANE ARMS**

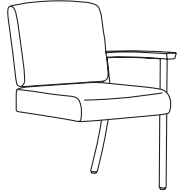

1923

<b>Overall:</b> 21.75"w 25.5"d 34"h		<b>Arm:</b> 25"h		<b>COM:</b> 1.75 yds.									
<b>Seat:</b> 20"w 18.25"d 18.5"h		<b>Weight:</b> 40 lbs.		<b>COL:</b> n/a									
COM	COL	1	2	3	4	5	6	7	8	9	10	L1	L2
1017	N/A	1026	1058	1090	1122	1154	1186	1219	1251	1283	1315	N/A	N/A

Open Back / Tight Seat & Back

**ADD-A-SEAT / URETHANE ARMS / ACCEPTS SEAT ON RIGHT**

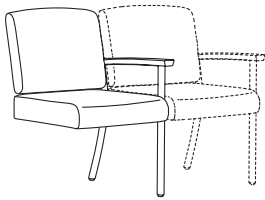

1923-C

<b>Overall:</b> 21.75"w 25.5"d 34"h		<b>Arm:</b> 25"h		<b>COM:</b> 1.75 yds.									
<b>Seat:</b> 20"w 18.25"d 18.5"h		<b>Weight:</b> 40 lbs.		<b>COL:</b> n/a									
COM	COL	1	2	3	4	5	6	7	8	9	10	L1	L2
1017	N/A	1026	1058	1090	1122	1154	1186	1219	1251	1283	1315	N/A	N/A

Open Back / Tight Seat & Back

**ADD-A-SEAT / URETHANE ARMS / ACCEPTS TABLE ON RIGHT**

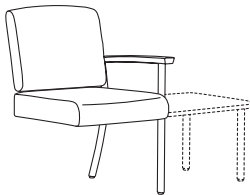

1923-T

<b>Overall:</b> 21.75"w 25.5"d 34"h		<b>Arm:</b> 25"h		<b>COM:</b> 1.75 yds.									
<b>Seat:</b> 20"w 18.25"d 18.5"h		<b>Weight:</b> 40 lbs.		<b>COL:</b> n/a									
COM	COL	1	2	3	4	5	6	7	8	9	10	L1	L2
1017	N/A	1026	1058	1090	1122	1154	1186	1219	1251	1283	1315	N/A	N/A

Open Back / Tight Seat & Back

**HIGH BACK PATIENT CHAIR / URETHANE ARMS**

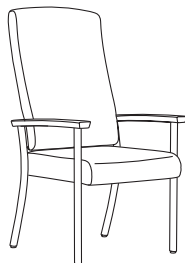

1925

<b>Overall:</b> 23.25"w 25.5"d 34"h		<b>Arm:</b> 25"h		<b>COM:</b> 2.25 yds.									
<b>Seat:</b> 20"w 18.25"d 18.5"h		<b>Weight:</b> 50 lbs.		<b>COL:</b> n/a									
COM	COL	1	2	3	4	5	6	7	8	9	10	L1	L2
1605	N/A	1643	1691	1748	1806	1864	1922	1980	2037	2095	2153	N/A	N/A

Open Back / Tight Seat & Back

**DESCRIPTION:**

- Upholstery Frames: Steel, Plywood & Hardwood
- Seat: High Density Polyurethane Foam Over Strap Webbing
- Back: High Density Polyurethane Foam Over Plywood
- Upholstered Covers: Stapled On Seat & Back
- Urethane Arm Caps - Standard
- Exposed Metal Legs: 14 Gauge Steel Tubing / Powder Coated (Wallsaver Back Legs)
- Leather Upholstery Not Available
- Adjustable Height Leveling Glides Standard
- 10 Year Warranty

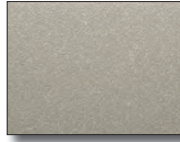

Leg Color: Champagne

**OPTIONS:**

- EPAC-1 Black Polyester Arm Caps (Set Of 2).....\$355
- AWAC-1 Wood Arm Caps (Set Of 2)..... Call For Pricing
- ARC-3 Removable Upholstery Covers Attached w/ Velcro (1932-1933)..... \$88 COM
- CC Contrasting Covers .....\$129

*All Austen Components Are Field Replaceable.*

*NOTE: All Seating Configurations Are Viewed From Left To Right Facing. Please Attach A Layout Showing Seating Configuration w/ Your Order. Assembled Units Must Be Shipped In Configurations Of 3 Or Less.*

BARIATRIC / TANDEM		ITEM #:	SPECIFICATIONS   GRADES   LIST PRICES:													
	1932	<b>Overall:</b> 33.25"w 25.5"d 34"h <b>Seat:</b> 30"w 18.25"d 18.5"h	<b>Arm:</b> 25"h <b>Weight:</b> 55 lbs.	<b>COM:</b> 2.25 yds. <b>COL:</b> n/a											L1	L2
		COM	COL	1	2	3	4	5	6	7	8	9	10	L1	L2	
		1667	N/A	1679	1730	1781	1833	1884	1935	1987	2038	2090	2141	N/A	N/A	
<i>Open Back / Tight Seat &amp; Back / 500 lb. Weight Capacity</i>																
	1932-C	<b>Overall:</b> 33.25"w 25.5"d 34"h <b>Seat:</b> 30"w 18.25"d 18.5"h	<b>Arm:</b> 25"h <b>Weight:</b> 55 lbs.	<b>COM:</b> 2.25 yds. <b>COL:</b> n/a											L1	L2
		COM	COL	1	2	3	4	5	6	7	8	9	10	L1	L2	
		1667	N/A	1679	1730	1781	1833	1884	1935	1987	2038	2090	2141	N/A	N/A	
<i>Open Back / Tight Seat &amp; Back / 500 lb. Weight Capacity</i>																
	1932-T	<b>Overall:</b> 33.25"w 25.5"d 34"h <b>Seat:</b> 30"w 18.25"d 18.5"h	<b>Arm:</b> 25"h <b>Weight:</b> 55 lbs.	<b>COM:</b> 2.25 yds. <b>COL:</b> n/a											L1	L2
		COM	COL	1	2	3	4	5	6	7	8	9	10	L1	L2	
		1667	N/A	1679	1730	1781	1833	1884	1935	1987	2038	2090	2141	N/A	N/A	
<i>Open Back / Tight Seat &amp; Back / 500 lb. Weight Capacity</i>																
	1932-LT	<b>Overall:</b> 33.25"w 25.5"d 34"h <b>Seat:</b> 30"w 18.25"d 18.5"h	<b>Arm:</b> 25"h <b>Weight:</b> 55 lbs.	<b>COM:</b> 2.25 yds. <b>COL:</b> n/a											L1	L2
		COM	COL	1	2	3	4	5	6	7	8	9	10	L1	L2	
		1667	N/A	1679	1730	1781	1833	1884	1935	1987	2038	2090	2141	N/A	N/A	
<i>Open Back / Tight Seat &amp; Back / 500 lb. Weight Capacity</i>																

**DESCRIPTION:**

- Upholstery Frames: Steel, Plywood & Hardwood
- Seat: High Density Polyurethane Foam Over Strap Webbing
- Back: High Density Polyurethane Foam Over Plywood
- Upholstered Covers: Stapled On Seat & Back
- Urethane Arm Caps - Standard
- Exposed Metal Legs: 14 Gauge Steel Tubing / Powder Coated (Wallsaver Back Legs)
- Leather Upholstery Not Available
- Adjustable Height Leveling Glides Standard
- 10 Year Warranty

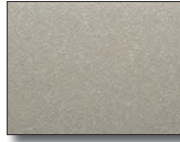

Leg Color: Champagne

**OPTIONS:**

- EPAC-1 Black Polyester Arm Caps (Set Of 2).....\$355
- AWAC-1 Wood Arm Caps (Set Of 2)..... Call For Pricing
- ARC-3 Removable Upholstery Covers Attached w/ Velcro (1932-1933)..... \$88 COM
- CC Contrasting Covers .....\$129

*All Austen Components Are Field Replaceable.*

*NOTE: All Seating Configurations Are Viewed From Left To Right Facing. Please Attach A Layout Showing Seating Configuration w/ Your Order. Assembled Units Must Be Shipped In Configurations Of 3 Or Less.*

**BARIATRIC / TANDEM**

ITEM #:

SPECIFICATIONS | GRADES | LIST PRICES:

**BARIATRIC CHAIR / URETHANE ARMS / ACCEPTS TABLE ON LEFT / SEAT ON RIGHT**

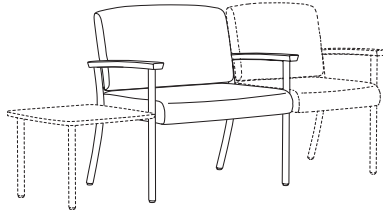

1932-TC

**Overall:** 33.25"w 25.5"d 34"h      **Arm:** 25"h      **COM:** 2.25 yds.  
**Seat:** 30"w 18.25"d 18.5"h      **Weight:** 55 lbs.      **COL:** n/a

COM	COL	1	2	3	4	5	6	7	8	9	10	L1	L2
1667	N/A	1679	1730	1781	1833	1884	1935	1987	2038	2090	2141	N/A	N/A

*Open Back / Tight Seat & Back / 500 lb. Weight Capacity*

**BARIATRIC CHAIR / URETHANE ARMS / ACCEPTS TABLE ON LEFT / RIGHT**

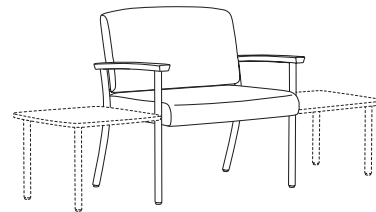

1932-TT

**Overall:** 33.25"w 25.5"d 34"h      **Arm:** 25"h      **COM:** 2.25 yds.  
**Seat:** 30"w 18.25"d 18.5"h      **Weight:** 55 lbs.      **COL:** n/a

COM	COL	1	2	3	4	5	6	7	8	9	10	L1	L2
1667	N/A	1679	1730	1781	1833	1884	1935	1987	2038	2090	2141	N/A	N/A

*Open Back / Tight Seat & Back / 500 lb. Weight Capacity*



**DESCRIPTION:**

- Upholstery Frames: Steel, Plywood & Hardwood
- Seat: High Density Polyurethane Foam Over Strap Webbing
- Back: High Density Polyurethane Foam Over Plywood
- Upholstered Covers: Stapled On Seat & Back
- Urethane Arm Caps - Standard
- Exposed Metal Legs: 14 Gauge Steel Tubing / Powder Coated (Wallsaver Back Legs)
- Leather Upholstery Not Available
- Adjustable Height Leveling Glides Standard
- 10 Year Warranty

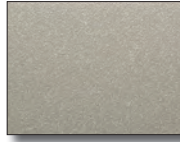

Leg Color: Champagne

**OPTIONS:**

- EPAC-1 Black Polyester Arm Caps (Set Of 2).....\$355
- AWAC-1 Wood Arm Caps (Set Of 2)..... Call For Pricing
- ARC-3 Removable Upholstery Covers Attached w/ Velcro (1932-1933)..... \$88 COM
- CC Contrasting Covers .....\$129

*All Austen Components Are Field Replaceable.*

*NOTE: All Seating Configurations Are Viewed From Left To Right Facing. Please Attach A Layout Showing Seating Configuration w/ Your Order. Assembled Units Must Be Shipped In Configurations Of 3 Or Less.*

**BARIATRIC / TANDEM**

ITEM #:

**SPECIFICATIONS | GRADES | LIST PRICES:**

**BARIATRIC ADD-A-SEAT / URETHANE ARMS**

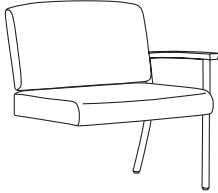

1933

**Overall:** 31.75"w 25.5"d 34"h      **Arm:** 25"h      **COM:** 2.25 yds.  
**Seat:** 30"w 18.25"d 18.5"h      **Weight:** 52 lbs.      **COL:** n/a

COM	COL	1	2	3	4	5	6	7	8	9	10	L1	L2
1361	N/A	1389	1441	1492	1543	1595	1646	1698	1749	1800	1852	N/A	N/A

*Open Back / Tight Seat & Back / 500 lb. Weight Capacity*

**BARIATRIC ADD-A-SEAT / URETHANE ARMS / ACCEPTS SEAT ON RIGHT**

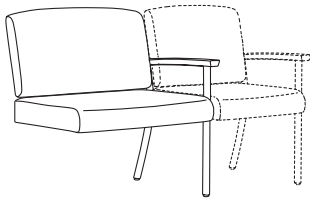

1933-C

**Overall:** 31.75"w 25.5"d 34"h      **Arm:** 25"h      **COM:** 2.25 yds.  
**Seat:** 30"w 18.25"d 18.5"h      **Weight:** 52 lbs.      **COL:** n/a

COM	COL	1	2	3	4	5	6	7	8	9	10	L1	L2
1361	N/A	1389	1441	1492	1543	1595	1646	1698	1749	1800	1852	N/A	N/A

*Open Back / Tight Seat & Back / 500 lb. Weight Capacity*

**BARIATRIC ADD-A-SEAT / URETHANE ARMS / ACCEPTS TABLE ON RIGHT**

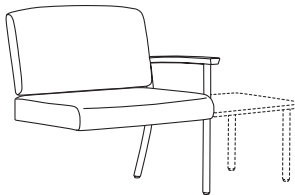

1933-T

**Overall:** 31.75"w 25.5"d 34"h      **Arm:** 25"h      **COM:** 2.25 yds.  
**Seat:** 30"w 18.25"d 18.5"h      **Weight:** 52 lbs.      **COL:** n/a

COM	COL	1	2	3	4	5	6	7	8	9	10	L1	L2
1361	N/A	1389	1441	1492	1543	1595	1646	1698	1749	1800	1852	N/A	N/A

*Open Back / Tight Seat & Back / 500 lb. Weight Capacity*

**DESCRIPTION:**

- Upholstery Frames: Steel, Plywood & Hardwood
- Seat: High Density Polyurethane Foam Over Strap Webbing
- Back: High Density Polyurethane Foam Over Plywood
- Upholstered Covers: Stapled On Seat & Back
- Urethane Arm Caps - Standard
- Exposed Metal Legs: 14 Gauge Steel Tubing / Powder Coated (Wallsaver Back Legs)
- Leather Upholstery Not Available
- Adjustable Height Leveling Glides Standard
- 10 Year Warranty

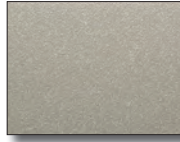

Leg Color: Champagne

**OPTIONS:**

- EPAC-1 Black Polyester Arm Caps (Set Of 2).....\$355
- AWAC-1 Wood Arm Caps (Set Of 2)..... Call For Pricing
- ARC-4 Removable Upholstery Covers Attached w/ Velcro (1950-1951)..... \$107 COM
- CC Contrasting Covers .....\$129

*All Austen Components Are Field Replaceable.*

*NOTE: All Seating Configurations Are Viewed From Left To Right Facing. Please Attach A Layout Showing Seating Configuration w/ Your Order. Assembled Units Must Be Shipped In Configurations Of 3 Or Less.*

**TANDEM**

ITEM #:

SPECIFICATIONS | GRADES | LIST PRICES:

**TWO PLACE SOFA / URETHANE ARMS**

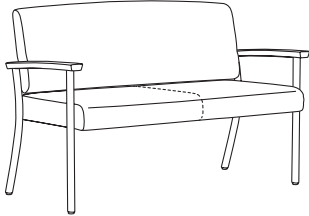

1950

<b>Overall:</b> 51.25"w 25.5"d 34"h		<b>Arm:</b> 25"h		<b>COM:</b> 3.5 yds.									
<b>Seat:</b> 48"w 18.25"d 18.5"h		<b>Weight:</b> 65 lbs.		<b>COL:</b> n/a									
COM	COL	1	2	3	4	5	6	7	8	9	10	L1	L2
2072	N/A	2126	2210	2293	2377	2460	2544	2627	2711	2794	2878	N/A	N/A

*Open Back / Tight Seat & Back*

**TWO PLACE SOFA / URETHANE ARMS / ACCEPTS SEAT ON RIGHT**

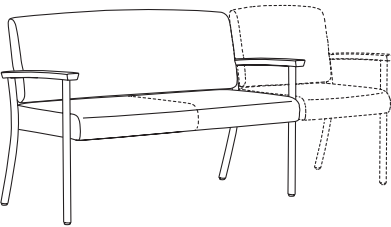

1950-C

<b>Overall:</b> 51.25"w 25.5"d 34"h		<b>Arm:</b> 25"h		<b>COM:</b> 3.5 yds.									
<b>Seat:</b> 48"w 18.25"d 18.5"h		<b>Weight:</b> 65 lbs.		<b>COL:</b> n/a									
COM	COL	1	2	3	4	5	6	7	8	9	10	L1	L2
2072	N/A	2126	2210	2293	2377	2460	2544	2627	2711	2794	2878	N/A	N/A

*Open Back / Tight Seat & Back*

**TWO PLACE SOFA / URETHANE ARMS / ACCEPTS TABLE ON RIGHT**

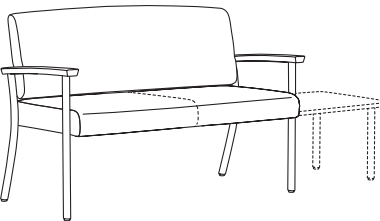

1950-T

<b>Overall:</b> 51.25"w 25.5"d 34"h		<b>Arm:</b> 25"h		<b>COM:</b> 3.5 yds.									
<b>Seat:</b> 48"w 18.25"d 18.5"h		<b>Weight:</b> 65 lbs.		<b>COL:</b> n/a									
COM	COL	1	2	3	4	5	6	7	8	9	10	L1	L2
2072	N/A	2126	2210	2293	2377	2460	2544	2627	2711	2794	2878	N/A	N/A

*Open Back / Tight Seat & Back*

**TWO PLACE SOFA / URETHANE ARMS / ACCEPTS TABLE ON LEFT**

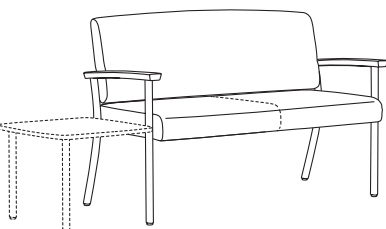

1950-LT

<b>Overall:</b> 51.25"w 25.5"d 34"h		<b>Arm:</b> 25"h		<b>COM:</b> 3.5 yds.									
<b>Seat:</b> 48"w 18.25"d 18.5"h		<b>Weight:</b> 65 lbs.		<b>COL:</b> n/a									
COM	COL	1	2	3	4	5	6	7	8	9	10	L1	L2
2072	N/A	2126	2210	2293	2377	2460	2544	2627	2711	2794	2878	N/A	N/A

*Open Back / Tight Seat & Back*

**DESCRIPTION:**

- Upholstery Frames: Steel, Plywood & Hardwood
- Seat: High Density Polyurethane Foam Over Strap Webbing
- Back: High Density Polyurethane Foam Over Plywood
- Upholstered Covers: Stapled On Seat & Back
- Urethane Arm Caps - Standard
- Exposed Metal Legs: 14 Gauge Steel Tubing / Powder Coated (Wallsaver Back Legs)
- Leather Upholstery Not Available
- Adjustable Height Leveling Glides Standard
- 10 Year Warranty

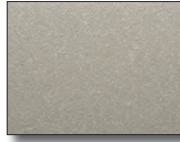

Leg Color: Champagne

**OPTIONS:**

- EPAC-1 Black Polyester Arm Caps (Set Of 2).....\$355
- AWAC-1 Wood Arm Caps (Set Of 2)..... Call For Pricing
- ARC-4 Removable Upholstery Covers Attached w/ Velcro (1950-1951)..... \$107 COM
- CC Contrasting Covers .....\$129

*All Austen Components Are Field Replaceable.*

*NOTE: All Seating Configurations Are Viewed From Left To Right Facing. Please Attach A Layout Showing Seating Configuration w/ Your Order. Assembled Units Must Be Shipped In Configurations Of 3 Or Less.*

**TANDEM**

ITEM #:

SPECIFICATIONS | GRADES | LIST PRICES:

**TWO PLACE SOFA / URETHANE ARMS / ACCEPTS TABLE ON LEFT / SEAT ON RIGHT**

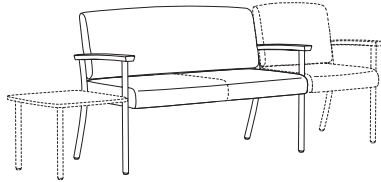

1950-TC

**Overall:** 51.25"w 25.5"d 34"h      **Arm:** 25"h      **COM:** 3.5 yds.  
**Seat:** 48"w 18.25"d 18.5"h      **Weight:** 65 lbs.      **COL:** n/a

COM	COL	1	2	3	4	5	6	7	8	9	10	L1	L2
2072	N/A	2126	2210	2293	2377	2460	2544	2627	2711	2794	2878	N/A	N/A

*Open Back / Tight Seat & Back*

**TWO PLACE SOFA / URETHANE ARMS / ACCEPTS TABLE ON LEFT / RIGHT**

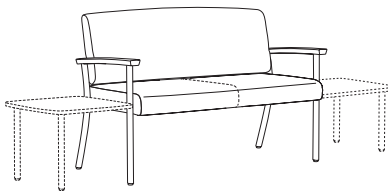

1950-TT

**Overall:** 51.25"w 25.5"d 34"h      **Arm:** 25"h      **COM:** 3.5 yds.  
**Seat:** 48"w 18.25"d 18.5"h      **Weight:** 65 lbs.      **COL:** n/a

COM	COL	1	2	3	4	5	6	7	8	9	10	L1	L2
2072	N/A	2126	2210	2293	2377	2460	2544	2627	2711	2794	2878	N/A	N/A

*Open Back / Tight Seat & Back*

**DESCRIPTION:**

- Upholstery Frames: Steel, Plywood & Hardwood
- Seat: High Density Polyurethane Foam Over Strap Webbing
- Back: High Density Polyurethane Foam Over Plywood
- Upholstered Covers: Stapled On Seat & Back
- Urethane Arm Caps - Standard
- Exposed Metal Legs: 14 Gauge Steel Tubing / Powder Coated (Wallsaver Back Legs)
- Leather Upholstery Not Available
- Adjustable Height Leveling Glides Standard
- 10 Year Warranty

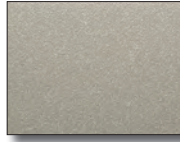

Leg Color: Champagne

**OPTIONS:**

- EPAC-1 Black Polyester Arm Caps (Set Of 2).....\$355
- AWAC-1 Wood Arm Caps (Set Of 2)..... Call For Pricing
- ARC-4 Removable Upholstery Covers Attached w/ Velcro (1950-1951)..... \$107 COM
- CC Contrasting Covers .....\$129

*All Austen Components Are Field Replaceable.*

*NOTE: All Seating Configurations Are Viewed From Left To Right Facing. Please Attach A Layout Showing Seating Configuration w/ Your Order. Assembled Units Must Be Shipped In Configurations Of 3 Or Less.*

**TANDEM**

ITEM #:

**SPECIFICATIONS | GRADES | LIST PRICES:**

**TWO PLACE ADD-A-SEAT / URETHANE ARMS**

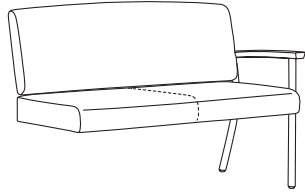

1951

**Overall:** 49.75"w 25.5"d 34"h      **Arm:** 25"h      **COM:** 3.5 yds.  
**Seat:** 48"w 18.25"d 18.5"h      **Weight:** 62 lbs.      **COL:** n/a

COM	COL	1	2	3	4	5	6	7	8	9	10	L1	L2
1572	N/A	1653	1737	1820	1904	1987	2071	2154	2238	2321	2405	N/A	N/A

*Open Back / Tight Seat & Back*

**TWO PLACE ADD-A-SEAT / URETHANE ARMS / ACCEPTS SEAT ON RIGHT**

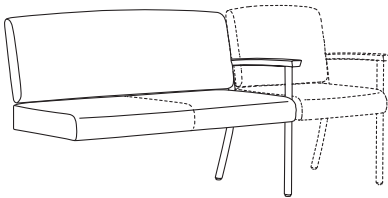

1951-C

**Overall:** 49.75"w 25.5"d 34"h      **Arm:** 25"h      **COM:** 3.5 yds.  
**Seat:** 48"w 18.25"d 18.5"h      **Weight:** 62 lbs.      **COL:** n/a

COM	COL	1	2	3	4	5	6	7	8	9	10	L1	L2
1572	N/A	1653	1737	1820	1904	1987	2071	2154	2238	2321	2405	N/A	N/A

*Open Back / Tight Seat & Back*

**TWO PLACE ADD-A-SEAT / URETHANE ARMS / ACCEPTS TABLE ON RIGHT**

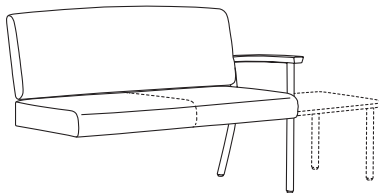

1951-T

**Overall:** 49.75"w 25.5"d 34"h      **Arm:** 25"h      **COM:** 3.5 yds.  
**Seat:** 48"w 18.25"d 18.5"h      **Weight:** 62 lbs.      **COL:** n/a

COM	COL	1	2	3	4	5	6	7	8	9	10	L1	L2
1572	N/A	1653	1737	1820	1904	1987	2071	2154	2238	2321	2405	N/A	N/A

*Open Back / Tight Seat & Back*

**DESCRIPTION:**

- High Pressure Laminate Over Plywood Core (Exposed Plywood Edge Is Tinted To Complement Top Laminate Color) \*Optional Self-Edge Available
- Wilsonart Plastic Laminates Standard. Alternate Selections May Be Specified From Most Major Laminate Manufacturers. (Contact Factory For Availability)
- Exposed Metal Legs: 14 Gauge Steel Tubing / Powder Coated
- 10 Year Warranty

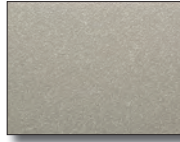

Leg Color: Champagne

**OPTIONS:**

- SE10W Self-Edge Table Top - 10"W x 22.5"D ..... Call For Pricing
- SE20W Self-Edge Table Top - 20"W x 22.5"D ..... Call For Pricing
- SE27W Self-Edge Table Top - 27.5"W x 27.5"D ..... Call For Pricing

Specify Laminate (See Page 6)

*NOTE: All Seating Configurations Are Viewed From Left To Right Facing. Please Attach A Layout Showing Seating Configuration w/ Your Order. Assembled Units Must Be Shipped In Configurations Of 3 Or Less.*

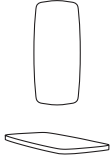
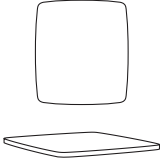
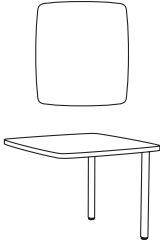
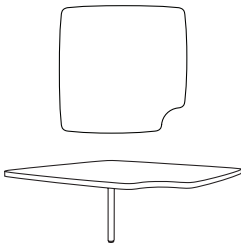
CONNECTING TABLES		ITEM #:	SPECIFICATIONS   GRADES   LIST PRICES:												
CONNECTING HALF TABLE		19C1022-L	<i>Overall: 10"w 22.5"d 16"h</i>		<i>Weight: 15 lbs.</i>										
			COM	COL	1	2	3	4	5	6	7	8	9	10	L1
			446 High Pressure Laminate Over Plywood Core												
CONNECTING TABLE		19C2022-L	<i>Overall: 20"w 22.5"d 16"h</i>		<i>Weight: 20 lbs.</i>										
			COM	COL	1	2	3	4	5	6	7	8	9	10	L1
			600 High Pressure Laminate Over Plywood Core												
CONNECTING END TABLE		19E2022-L	<i>Overall: 20"w 22.5"d 16"h</i>		<i>Weight: 22 lbs.</i>										
			COM	COL	1	2	3	4	5	6	7	8	9	10	L1
			776 High Pressure Laminate Over Plywood Core												
CONNECTING CORNER TABLE		19SC2727-L	<i>Overall: 27.5"w 27.5"d 16"h</i>		<i>Weight: 40 lbs.</i>										
			COM	COL	1	2	3	4	5	6	7	8	9	10	L1
			823 High Pressure Laminate Over Plywood Core												

**DESCRIPTION:**

- High Pressure Laminate Over Plywood Core (Exposed Plywood Edge Is Tinted To Complement Top Laminate Color) \*Optional Self-Edge Available
- Wilsonart Plastic Laminates Standard. Alternate Selections May Be Specified From Most Major Laminate Manufacturers. (Contact Factory For Availability)
- Exposed Metal Legs: 14 Gauge Steel Tubing / Powder Coated
- 10 Year Warranty

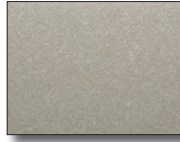





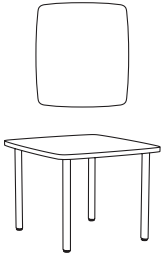
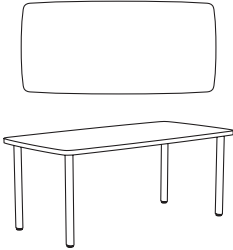

Leg Color: Champagne

**OPTIONS:**

- SE20W Self-Edge Table Top - 20"W x 22.5"D ..... Call For Pricing
- SE27W Self-Edge Table Top - 27.5"W x 27.5"D ..... Call For Pricing

Specify Laminate (See Page 6)

TABLES		ITEM #:	SPECIFICATIONS   GRADES   LIST PRICES:													
FREESTANDING END TABLE			<i>Overall: 20"w 22.5"d 16"h</i>		<i>Weight: 25 lbs.</i>											
		192022-L	COM	COL	1	2	3	4	5	6	7	8	9	10	L1	L2
			974 <i>High Pressure Laminate Over Plywood Core</i>													
FREESTANDING COFFEE TABLE			<i>Overall: 42"w 20"d 16"h</i>		<i>Weight: 45 lbs.</i>											
		194220-L	COM	COL	1	2	3	4	5	6	7	8	9	10	L1	L2
			1120 <i>High Pressure Laminate Over Plywood Core</i>													

ARM CAPS / COVERS	OPTION #:	SPECIFICATIONS   LIST PRICES   AVAILABILITY:
<p><b>POLYESTER ARM CAPS</b></p> 	<p><b>EPAC-1</b></p> <p><i>Overall: 2.75"w 22.5"d 1.125"h</i></p> <p>\$355 (Set Of 2) POLYESTER <i>Black Polyester Arm Cap (Additional Colors Available)</i></p> <p><i>Available: Austen Guest / Tandem Collection</i></p>	
<p><b>WOOD ARM CAPS</b></p> 	<p><b>AWAC-1</b></p> <p><i>Overall: 2.75"w 22.5"d 1.125"h</i></p> <p>CALL FOR PRICING (Set Of 2) WOOD <i>Wood Arm Cap (Specify Finish)</i></p> <p><i>Available: Austen Guest / Tandem Collection</i></p>	
<p><b>REMOVABLE UPHOLSTERY COVERS</b></p> 	<p><i>Overall: N/A</i></p> <p><b>ARC-1</b> \$62 COM (Seat &amp; Back For 1922-1923) <i>Removable Upholstery Covers Attached w/ Velcro (Antimicrobial Moisture Barrier Fully Encapsulates All Foam Areas)</i></p> <p><b>ARC-2</b> \$73 COM (Seat &amp; Back For 1925) <i>Removable Upholstery Covers Attached w/ Velcro (Antimicrobial Moisture Barrier Fully Encapsulates All Foam Areas)</i></p> <p><b>ARC-3</b> \$88 COM (Seat &amp; Back For 1932-1933) <i>Removable Upholstery Covers Attached w/ Velcro (Antimicrobial Moisture Barrier Fully Encapsulates All Foam Areas)</i></p> <p><b>ARC-4</b> \$107 COM (Seat &amp; Back For 1950-1951) <i>Removable Upholstery Covers Attached w/ Velcro (Antimicrobial Moisture Barrier Fully Encapsulates All Foam Areas)</i></p> <p><i>Available: Austen Guest / Tandem Collection</i></p>	
<p><b>SELF EDGE TABLE TOP</b></p> 	<p><i>Overall: 10"W x 22.5"D x .75"H / 20"W x 22.5"D x .75"H / 27.5"W x 27.5"D x .75"H</i></p> <p><b>SE10W</b> CALL FOR PRICING (Self Edge Table Top - 10"W x 22.5"D) <i>High Pressure Laminate Top w/ Self Edge - Specify Laminate Color</i></p> <p><b>SE20W</b> CALL FOR PRICING (Self Edge Table Top - 20"W x 22.5"D) <i>High Pressure Laminate Top w/ Self Edge - Specify Laminate Color</i></p> <p><b>SE27W</b> CALL FOR PRICING (Self Edge Table Top - 27.5"W x 27.5"D) <i>High Pressure Laminate Top w/ Self Edge - Specify Laminate Color</i></p> <p><i>Available: Austen Table Collection</i></p>	
<p><b>CONTRASTING COVERS</b></p> 	<p><i>Overall: N/A</i></p> <p><b>CC</b> \$129</p> <p><i>NOTE: If Two Or More Upholsteries Or Leathers Are Used On Any Piece Of Furniture, Then A Contrast Charge Will Apply Per Order. When Using Trinity Upholstery, The Higher Priced Upholstery Grade Will Be Used In Pricing, Unless It's Trinity Leather With Fabric Contrast Welt, Or COM With Trinity Contrast Welt, Then Contact Customer Service For Pricing.</i></p> <p><i>Available: Austen Guest / Tandem Collection</i></p>	

# Serene

---

CHESTS / BEDSIDE CABINETS /  
WARDROBES / OVER-THE-BED TABLE

Effective: August 1, 2022

T R I N I T Y



**Date:**

**Page:**

**Modification:**

**Description:**

---

### Casegoods Laminates

Due to variations in screen displays, digital laminate images shown here may not match actual laminate samples exactly. These images are for color reference only. If you require an actual laminate sample, please contact your representative or contact customer service.

#### Laminates For Casegoods (Serene Collection)



Wilsonart  
Fusion Maple

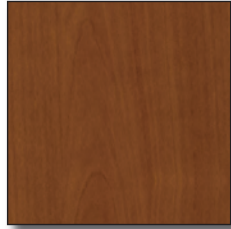

Wilsonart  
Bltmore Cherry

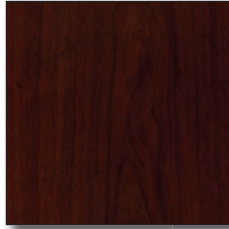

Wilsonart  
Empire Mahogany

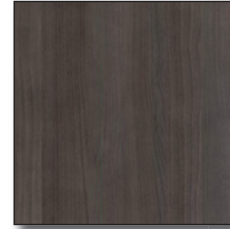

Wilsonart  
Skyline Walnut



Wilsonart  
Ebony

NOTE: Serene chassis are TFL with matching HPL top option. Additional colors available. Please contact Customer Service for more information.

#### Laminates For Over-The-Bed Table Top (Serene Collection)



Nevamar  
Clear Maple



Wilsonart  
Fusion Maple



Wilsonart  
Quartered Oak



Wilsonart  
Bannister Oak



Wilsonart  
Solar Oak



Wilsonart  
Nepal Teak

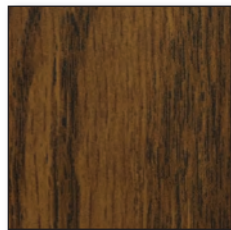

Wilsonart  
English Oak

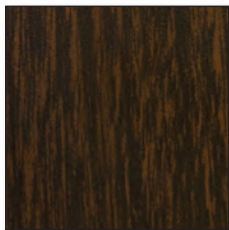

Wilsonart  
Gunstock Walnut

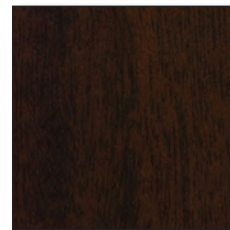

Wilsonart  
Figured Mahogany



Wilsonart  
Wild Cherry

NOTE: Over-The-Bed Table top laminates are available in (10) standard colors, including Fusion Maple. Bltmore Cherry, Empire Mahogany, Skyline Walnut, and Ebony laminates are available as an upcharge. Additional colors and top options available. Please contact Customer Service for more information.

#### Metal Base Finish For Over-The-Bed Table (Serene Collection)

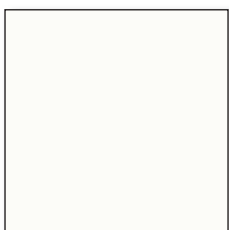

Opal - Standard

NOTE: Over-The-Bed Table metal base is standard in Opal powder coat finish. Other metal base colors are available as an upcharge with qualifying quantities. Please contact customer service for more information.

Pull Selections

Trinity offers (3) pull selections for the Serene Collection.

P02 Bow Pull - Matte Black Finish (STANDARD PULL)

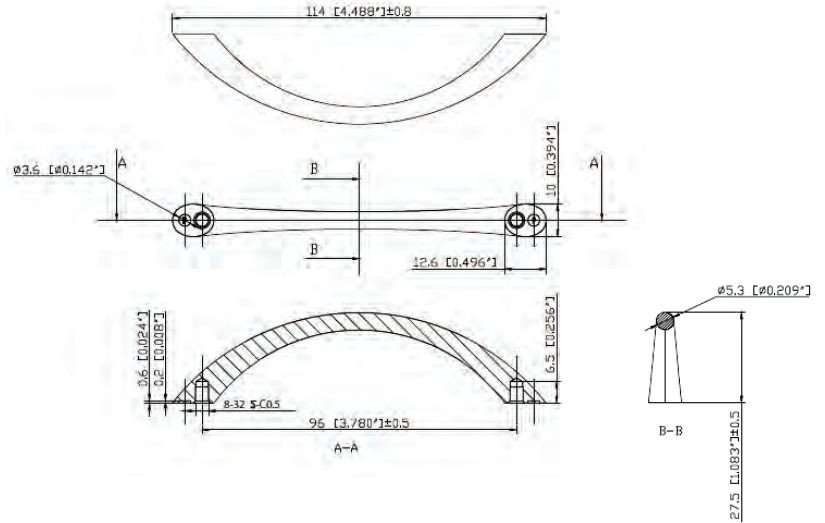

P03 Bow Pull - Brushed Nickel Finish (OPTIONAL PULL - NO UPCHARGE)

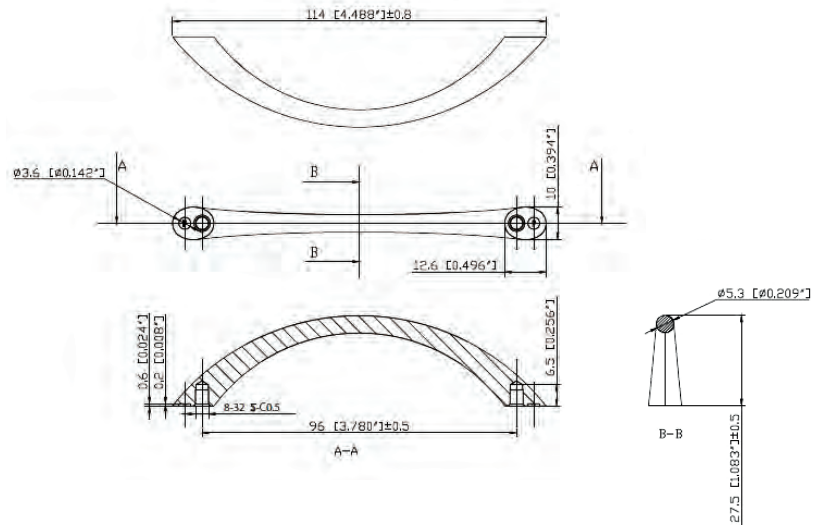

P01 Bar Pull - Brushed Nickel Finish (OPTIONAL PULL - NO UPCHARGE)

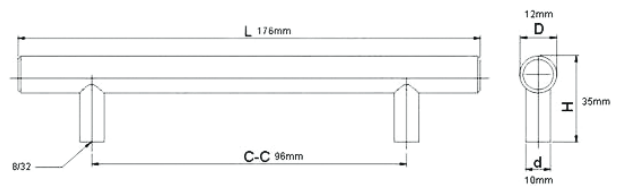



**DESCRIPTION:**

- PVC Banded HPL Top Standard
- TFL Chassis Construction w/ Matching 1mm PVC Edges
- White Vinyl Wrapped Drawers
- HD Full Extension Ball Bearing Side Guides
- P02 Matte Black Bow Pull Standard
- Plinth Base Standard
- Tack Glides On Plinth Bases
- Locking Top Drawer (Std. On Drawers)
- Vented Back Panel w/ Black Plastic Wire Grommet
- 10 Year Warranty

**OPTIONS:**

- P01 Brushed Nickel Bar Pull (See Serene Hardware Page)..... n/c
- P03 Brushed Nickel Bow Pull (See Serene Hardware Page)..... n/c
- MLB 2" Dia. x 4" h Matte Black Metal Legs (Set Of 4) ..... \$153
- MLN 2" Dia. x 4" h Nickel Metal Legs (Set Of 4) ..... \$153
- TDPT-1 Thermofoil Drip Proof Top (Chests) ..... Call For Pricing
- SDPT-1 Solid Surface Drip Proof Top (Chests) ..... Call For Pricing
- RDL-1 Removable Drawer Liner (1 Per Drawer - Chests) ..... Call For Pricing

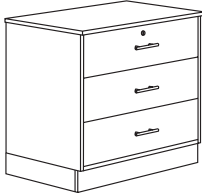
Specify Laminate Color (See Serene Casegoods Laminates Page)



CHESTS	ITEM #:	SPECIFICATIONS   LIST PRICES:
<p><b>3 DRAWER CHEST</b></p> 	<p><b>61-128</b></p>	<p><b>Overall:</b> 33.5"w 21.5"d 30"h <b>Weight:</b> 110 lbs.</p> <p><b>LIST PRICE</b></p> <hr/> <p>1810 <i>PVC Banded HPL Top / Plinth Base</i></p>
<p><b>4 DRAWER CHEST</b></p> 	<p><b>61-152</b></p>	<p><b>Overall:</b> 33.5"w 21.5"d 38"h <b>Weight:</b> 132 lbs.</p> <p><b>LIST PRICE</b></p> <hr/> <p>2177 <i>PVC Banded HPL Top / Plinth Base</i></p>

**DESCRIPTION:**

- PVC Banded HPL Top Standard
- TFL Chassis Construction w/ Matching 1mm PVC Edges
- White Vinyl Wrapped Drawers
- HD Full Extension Ball Bearing Side Guides (Drawers Only)
- P02 Matte Black Bow Pull Standard
- Plinth Base Standard
- Tack Glides On Plinth Bases
- European Concealed Hinges, 90° Opening (Doors Only)
- Locking Top Drawer (Std. On Drawers)
- Vented Back Panel w/ Black Plastic Wire Grommet
- 10 Year Warranty

**OPTIONS:**

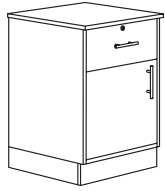
- P01 Brushed Nickel Bar Pull (See Serene Hardware Page)..... n/c
  - P03 Brushed Nickel Bow Pull (See Serene Hardware Page)..... n/c
  - CAS-NL Non-Locking Swivel Casters (Set Of 2) ..... \$305
  - CAS-L Locking Swivel Casters (Set Of 2) ..... \$305
  - MLB 2" Dia. x 4" h Matte Black Metal Legs (Set Of 4) ..... \$153
  - MLN 2" Dia. x 4" h Nickel Metal Legs (Set Of 4) ..... \$153
  - TDPT-2 Thermofoil Drip Proof Top (Bedside Cabinets) ..... Call For Pricing
  - SDPT-2 Solid Surface Drip Proof Top (Bedside Cabinets) ..... Call For Pricing
  - RDL-2 Removable Drawer Liner (1 Per Drawer - Bedside Cabinets) ..... \$127
  - DOL Drawer/Door Lock (61-232 / 61-801 / 61-803) ..... \$135
- Specify Laminate Color (See Serene Casegoods Laminates Page)

BEDSIDE CABINETS	ITEM #:	SPECIFICATIONS   LIST PRICES:
<p><b>1 DRAWER BEDSIDE CABINET</b></p> 	<p><b>61-222</b></p>	<p><b>Overall:</b> 17"w 21.5"d 30"h <b>Weight:</b> 60 lbs.</p> <p><b>LIST PRICE</b></p> <hr/> <p>929 <i>PVC Banded HPL Top / Plinth Base</i></p>
<p><b>1 DOOR / 1 DRAWER BEDSIDE CABINET</b></p> 	<p><b>61-232</b></p>	<p><b>Overall:</b> 21.5"w 21.5"d 30"h <b>Weight:</b> 75 lbs.</p> <p><b>LIST PRICE</b></p> <hr/> <p>983 <i>PVC Banded HPL Top / Plinth Base</i></p>
<p><b>3 DRAWER BEDSIDE CABINET</b></p> 	<p><b>61-233</b></p>	<p><b>Overall:</b> 17"w 21.5"d 30"h <b>Weight:</b> 70 lbs.</p> <p><b>LIST PRICE</b></p> <hr/> <p>1085 <i>PVC Banded HPL Top / Plinth Base</i></p>

**DESCRIPTION:**

- TFL Chassis Construction w/ Matching 1mm PVC Edges
- White Vinyl Wrapped Drawer (61-803)
- HD Full Extension Ball Bearing Side Guides (61-803 Drawer Only)
- P02 Matte Black Bow Pull Standard
- Full Width Metal Coat Rod
- Adjustable Shelf (61-801)
- Plinth Base Standard
- Tack Glides On Plinth Bases
- European Concealed Hinges, 90° Opening (Doors Only)
- Vented Back Panel w/ Black Plastic Wire Grommet
- 10 Year Warranty

**OPTIONS:**

- P01 Brushed Nickel Bar Pull (See Serene Hardware Page)..... n/c
- P03 Brushed Nickel Bow Pull (See Serene Hardware Page)..... n/c
- DOL Drawer/Door Lock (61-232 / 61-801 / 61-803)..... \$135
- RDL-3 Removable Drawer Liner (1 Per Drawer - 61-803 Only)..... Call For Pricing

Specify Laminate Color (See Serene Casegoods Laminates Page)

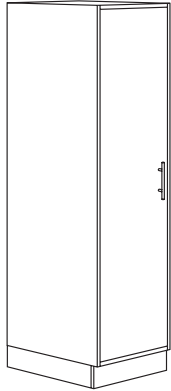
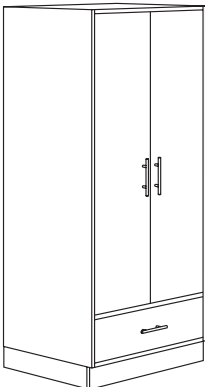
WARDROBES	ITEM #:	SPECIFICATIONS   LIST PRICES:
<p><b>HALF WARDROBE</b></p> 	<p><b>61-801</b></p>	<p><b>Overall:</b> 20"w 25"d 71.25"h <b>Weight:</b> 120 lbs.</p> <hr/> <p><b>LIST PRICE</b></p> <hr/> <p>2468 <i>Full Width Coat Rod / Adjustable Shelf / Plinth Base</i></p>
<p><b>FULL WARDROBE WITH 1 DRAWER</b></p> 	<p><b>61-803</b></p>	<p><b>Overall:</b> 32"w 25"d 71.25"h <b>Weight:</b> 220 lbs.</p> <hr/> <p><b>LIST PRICE</b></p> <hr/> <p>2546 <i>Full Width Coat Rod / Bottom Drawer (Non-Locking Std.) / Plinth Base</i></p>

**DESCRIPTION:**

- PVC Banded HPL Top Standard
- 40mm Dual Wheel Casters
- Pneumatic Height Adjustment
- Opal Powder Coat Finish Standard

**OPTIONS:**

- TDPT-3 Thermofoil Drip Proof Top (Over-The-Bed Table Top) ..... Call For Pricing
- SDPT-3 Solid Surface Drip Proof Top (Over-The-Bed Table Top) ..... Call For Pricing

Specify Top Laminate Color (See Serene Casegoods Laminates Page)

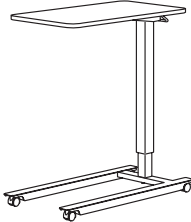
OVER-THE-BED TABLE	ITEM #:	SPECIFICATIONS   LIST PRICES:
<p>OVER-THE-BED TABLE</p> 	<p><b>61-4828</b></p>	<p><b>Overall:</b> 35"w 18"d 25.5"h - 41.25"h  <b>Weight:</b> 30 lbs.</p> <hr/> <p><b>LIST PRICE</b></p> <hr/> <p>1265  <i>PVC Banded HPL Top / Fork Style Base / Pneumatic Height Adjustment</i></p>

LEGS / CASTERS / LOCK / TOPS	OPTION #:	SPECIFICATIONS   LIST PRICES   AVAILABILITY:
<p><b>METAL LEGS</b></p>  <p>MLN</p>  <p>MLB</p>	<p><b>Overall:</b> 2"dia 4"h</p> <hr/> <p><b>MLN</b> \$153 (Set Of 4) <i>Nickel Metal Legs</i></p> <p><b>MLB</b> \$153 (Set Of 4) <i>Matte Black Metal Legs</i></p> <p><b>Available:</b> Serene Chests &amp; Bedside Cabinets</p>	
<p><b>CASTERS</b></p>  <p>CAS-NL</p>  <p>CAS-L</p>	<p><b>Overall:</b> 3"dia 2"w 4"h</p> <hr/> <p><b>CAS-NL</b> \$305 (Set Of 2) <i>Non-Locking Swivel Gray &amp; Silver Plastic Casters</i></p> <p><b>CAS-L</b> \$305 (Set Of 2) <i>Locking Swivel Gray &amp; Silver Plastic Casters</i></p> <p><b>Available:</b> Serene Bedside Cabinets</p>	
<p><b>DRAWER / DOOR LOCK</b></p> 	<p><b>Overall:</b> 7/8" dia</p> <hr/> <p><b>DOL</b> \$127 (Per Lock) <i>Black Metal Drawer / Door Lock</i></p> <p><b>Available:</b> Serene 61-232, 61-801, 61-803</p>	
<p><b>THERMOFOIL DRIP PROOF TOP</b></p> 	<p><b>Overall:</b> Per Top Size</p> <hr/> <p><b>TDPT-1</b> CALL FOR PRICING (Top For Chest) <i>TFL Thermofoil Drip Proof Top - Specify Color</i></p> <p><b>TDPT-2</b> CALL FOR PRICING (Top For Bedside Cabinet) <i>TFL Thermofoil Drip Proof Top - Specify Color</i></p> <p><b>TDPT-3</b> CALL FOR PRICING (Top For Over-The-Bed Table) <i>TFL Thermofoil Drip Proof Top - Specify Color</i></p> <p><b>Available:</b> Serene Chests, Bedside Cabinets &amp; Over-The-Bed Table</p>	



TOPS / DRAWER LINERS	OPTION #:	SPECIFICATIONS   LIST PRICES   AVAILABILITY:
<p><b>SOLID SURFACE DRIP PROOF TOP</b></p> 	<p><i>Overall: Per Top Size</i></p> <hr/> <p><b>SDPT-1</b> CALL FOR PRICING (Top For Chest) <i>Solid Surface Drip Proof Top - Standard In White (Additional Colors Available)</i></p> <p><b>SDPT-2</b> CALL FOR PRICING (Top For Bedside Cabinet) <i>Solid Surface Drip Proof Top - Standard In White (Additional Colors Available)</i></p> <p><b>SDPT-3</b> CALL FOR PRICING (Top For Over-The-Bed Table) <i>Solid Surface Drip Proof Top - Standard In White (Additional Colors Available)</i></p> <p><i>Available: Serene Chests, Bedside Cabinets &amp; Over-The-Bed Table</i></p>	
<p><b>REMOVABLE PLASTIC DRAWER LINERS</b></p>	<p><i>Overall: Per Drawer Size</i></p> <hr/> <p><b>RDL-1</b> CALL FOR PRICING (1 Liner Per Drawer - Chest) <i>Removable Plastic Drawer Liner - Black Color</i></p> <p><b>RDL-2</b> \$133 (1 Liner Per Drawer - Bedside Cabinet) <i>Removable Plastic Drawer Liner - Black Color</i></p> <p><b>RDL-3</b> CALL FOR PRICING (1 Liner Per Drawer - Full Wardrobe) <i>Removable Plastic Drawer Liner - Black Color</i></p> <p><i>Available: Serene Chests, Bedside Cabinets &amp; Full Wardrobe</i></p>	

# FACELIFT

COLLECTION

PRICE LIST • AUGUST 1, 2022

T R I N I T Y

**FACELIFT FEATURES**

ALL PRODUCTS ARE MODULAR, REPLACEABLE, RECYCLABLE AND RENEWABLE. ALL UPHOLSTERY ATTACHES WITH VELCRO BRAND HOOK AND LOOP FASTENERS. NO TOOLS ARE NEEDED TO RENEW ANY UPHOLSTERY COMPONENTS. SIMPLY PEEL OFF AND REPLACE. SAFE-T-GUARD® ANTIMICROBIAL WOOD FINISH TOP COAT IS STANDARD ON EXPOSED WOOD. ANTIMICROBIAL BARRIER FULLY ENCAPSULATES THE SEAT, BACK AND ARMS. THE HYBRID FRAME IS MADE FROM RECYCLED STEEL, FSC APPROVED HARDWOOD AND PLYWOOD. SELECTED BARIATRIC MODELS ARE RATED 500 TO 1000 POUNDS. ALL MAINTENANCE CAN BE PERFORMED TOTALLY ON-SITE. ALL COMPONENTS CAN BE REPLACED INDEPENDENTLY, INCLUDING:

- UPHOLSTERY COVERS
- SEAT AND BACK CUSHIONS
- SEAT SUSPENSION SYSTEM
- ALL FRAME COMPONENTS

**FLAMMABILITY**

UNLESS OTHERWISE SPECIFIED, FOAM USED IN ALL TRINITY FURNITURE INCORPORATED SEATING PRODUCTS COMPLIES WITH CALIFORNIA TECHNICAL BULLETIN 117. PLEASE CONTACT CUSTOMER SUPPORT IF COMPLIANCE IS REQUIRED FOR THE OTHER FIRE CODES. INCLUDING:

**BOSTON FIRE CODE****CALIFORNIA TECHNICAL BULLETIN 133****NEW YORK PORT AUTHORITY****SPECIFICATIONS**

UPHOLSTERY FRAMES ARE PLYWOOD AND HARDWOOD. STEEL SEAT FRAME. SEAT IS HIGH DENSITY POLYURETHANE OVER RUBBER WOVEN POLYPROPYLENE STRAPS. BACK IS HIGH DENSITY POLYURETHANE OVER SINUOUS WIRE. ANTI-MICROBIAL MOISTURE BARRIER STANDARD. EXPOSED WOOD IS SOLID MAPLE. ALL ITEMS ARE PRODUCED TO PRICE LIST SPECIFICATIONS. WE RESERVE THE RIGHT TO MAKE MODIFICATIONS AND IMPROVEMENTS WITHOUT PRIOR NOTICE. ALL DIMENSIONS SHOWN ARE APPROXIMATE AND MAY VARY DUE TO COVER BEING USED.

**FACELIFT WARRANTY**

TRINITY WARRANTS ALL FACELIFT PRODUCTS FOR THE LIFE OF THE PRODUCT AGAINST MANUFACTURING AND FACTORY DEFECTS, EXCLUDING COVERING MATERIALS, UNDER NORMAL SINGLE SHIFT SERVICE FOR ORIGINAL PURCHASER. DURING THIS PERIOD TRINITY FURNITURE, AT OUR OPTION, WILL REPLACE, REPAIR OR RETURN THE PURCHASE PRICE OF ANY MERCHANDISE THAT, UPON OUR INSPECTION, IS DEEMED TO BE DEFECTIVE, THIS CONSTITUTES THE SOLE AND EXCLUSIVE REMEDY TO THE CUSTOMER. DAMAGES, RESULTING FROM FREIGHT, CLAIMED OR UNCLAIMED, FROM ACCIDENT, ALTERATION, TAMPERING, MISUSE, NEGLIGENCE OR ABUSE VOIDS THIS WARRANTY. IN THE EVENT ANY PRODUCT HAS TO BE RETURNED TO THE FACTORY FOR VERIFICATION OF A COMPLAINT, IT MUST BE SHIPPED PREPAID AND INCLUDE WRITTEN INFORMATION CONTAINING THE NAME OF THE ORIGINAL PURCHASER, ORIGINAL INVOICE NUMBER, AND A COPY OF THE ORIGINAL PURCHASE ORDER MUST BE PROVIDED. BECAUSE OF NATURAL VARIATIONS ON MATERIALS OVER WHICH TRINITY FURNITURE INC HAS NO CONTROL, THIS WARRANTY DOES NOT EXTEND TO COLOR, GRAIN, OR TEXTURE OF WOOD, OR UPHOLSTERY COVER. THIS WARRANTY IS APPLICABLE ONLY TO THOSE PARTS ACTUALLY MANUFACTURED BY TRINITY FURNITURE. FOR PURCHASED COMPONENT PARTS, WE WILL APPLY EXACTLY THE SAME WARRANTY THIS IS EXTENDED TO US BY OUR SUPPLIER. TRINITY FURNITURE SHALL NOT BE LIABLE FOR CONSEQUENTIAL OR INCIDENTAL DAMAGES ARISING FROM ANY PRODUCT DEFECT.

**MADE IN AMERICA**

ALL FURNITURE IS PROUDLY MADE IN THE UNITED STATES OF AMERICA.

**ENVIRONMENTAL SUSTAINABILITY****ALL TRINITY FURNITURE PRODUCTS HAVE LEVEL 1 CERTIFICATION**

THE BUSINESS INSTITUTIONAL FURNITURE MANUFACTURERS ASSOCIATES (BIFMA) LEVEL STANDARD IS TO PROVIDE MEASURABLE MARKET-BASED DEFINITIONS OF PROGRESSIVELY MORE SUSTAINABLE FURNITURE BY ESTABLISHING PERFORMANCE CRITERIA THAT ADDRESS ENVIRONMENTAL AND SOCIAL ASPECTS THROUGHOUT THE SUPPLY CHAIN.

THIS STANDARD PROVIDES A PATHWAY TOWARDS SUSTAINABILITY BY ESTABLISHING MEASURABLE CRITERIA FOR MULTIPLE LEVELS OF ACHIEVEMENT AND/OR PERFORMANCE. IT ADDRESSES PRODUCT BASED CHARACTERISTICS IN THE GENERAL AREA OF MATERIALS, USE OF ENERGY, HUMAN AND ECOSYSTEM HEALTH, AND SOCIAL RESPONSIBILITY IMPACTS.



# Facelift Replay

---

GUEST / LOUNGE / TANDEM

Effective: August 1, 2022

T R I N I T Y

**Date:**

**Page:**

**Modification:**

**Description:**

---

**DESCRIPTION:**

- Upholstery Frames: Steel, Plywood & Hardwood
- Seat: High Density Polyurethane Foam Over Strap Webbing
- Back: High Density Polyurethane Foam Over Sinuous Wire Springs
- Upholstered Covers: Attached w/ Velcro / Removable For Maintenance
- Antimicrobial Moisture Barrier Fully Encapsulates All Foam Areas
- Double Needle Stitching Standard (Welting Optional - No Charge)
- Exposed Wood Legs: Solid Hardwood / Removable For Maintenance
- Leather Upholstery Not Available
- Lifetime Warranty
- 1501: 500 lbs. Weight Rating / 1501-X, 1502, 1503: 1000 lbs. Weight Rating

**OPTIONS:**

- RWAC-1 Solid Wood Arm Caps (Set Of 2) .....\$374
- RPAC-1 Black Polyester Arm Caps (Set Of 2).....\$484
- ASL Aluminum Square Legs (Set Of 4).....\$348
- PM1 Power/Data Module (1-Power / 1-USB 2 Port Simplex Charger) .....\$836

Feather Down & Polyester Pillows Available (See Page 5)  
 Specify Exposed Wood Finish (See Page 6)  
 Tablet Arm / Cup Holder Options (See Facelift Replay Options Pages)

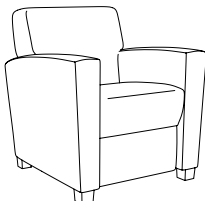
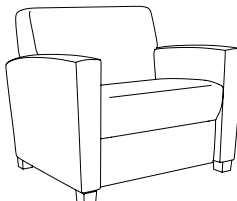
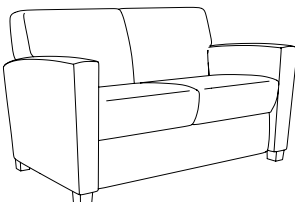
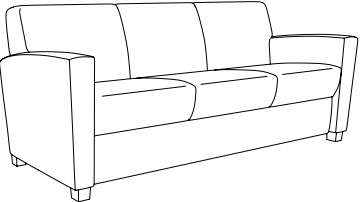
LOUNGE		ITEM #:	SPECIFICATIONS   GRADES   LIST PRICES:														
	<b>LOUNGE CHAIR / FULLY UPHOLSTERED</b>		<b>Overall:</b> 31.25"w 31"d 34.5"h			<b>Arm:</b> 25.5"h			<b>COM:</b> 5.25 yds.								
	<b>Seat:</b> 21"w 20"d 18"h			<b>Weight:</b> 80 lbs.			<b>COL:</b> n/a										
				<b>COM</b>	<b>COL</b>	<b>1</b>	<b>2</b>	<b>3</b>	<b>4</b>	<b>5</b>	<b>6</b>	<b>7</b>	<b>8</b>	<b>9</b>	<b>10</b>	<b>L1</b>	<b>L2</b>
	<b>1501</b>			1469	N/A	1663	1801	1938	2076	2213	2351	2488	2626	2763	2901	N/A	N/A
			<i>Tight Seat &amp; Back / Removable Upholstery</i>														
	<b>1501-R</b>		247	N/A	508	646	783	921	1058	1196	1333	1471	1608	1745	N/A	N/A	
			<i>Replacement Upholstery Covers</i>														
	<b>BARIATRIC LOUNGE CHAIR / FULLY UPHOLSTERED</b>		<b>Overall:</b> 39.25"w 31"d 34.5"h			<b>Arm:</b> 25.5"h			<b>COM:</b> 5.75 yds.								
	<b>Seat:</b> 29"w 20"d 18"h			<b>Weight:</b> 95 lbs.			<b>COL:</b> n/a										
				<b>COM</b>	<b>COL</b>	<b>1</b>	<b>2</b>	<b>3</b>	<b>4</b>	<b>5</b>	<b>6</b>	<b>7</b>	<b>8</b>	<b>9</b>	<b>10</b>	<b>L1</b>	<b>L2</b>
	<b>1501-X</b>			1818	N/A	2021	2172	2323	2474	2626	2777	2928	3079	3230	3382	N/A	N/A
			<i>Tight Seat &amp; Back / Removable Upholstery / 1000 lb. Weight Capacity</i>														
	<b>1501-XR</b>		253	N/A	541	693	844	995	1146	1297	1449	1600	1751	1902	N/A	N/A	
			<i>Replacement Upholstery Covers</i>														
	<b>TWO PLACE SOFA / FULLY UPHOLSTERED</b>		<b>Overall:</b> 56.75"w 31"d 34.5"h			<b>Arm:</b> 25.5"h			<b>COM:</b> 7.25 yds.								
	<b>Seat:</b> 46.5"w 20"d 18"h			<b>Weight:</b> 137 lbs.			<b>COL:</b> n/a										
				<b>COM</b>	<b>COL</b>	<b>1</b>	<b>2</b>	<b>3</b>	<b>4</b>	<b>5</b>	<b>6</b>	<b>7</b>	<b>8</b>	<b>9</b>	<b>10</b>	<b>L1</b>	<b>L2</b>
	<b>1502</b>			2361	N/A	2617	2809	3002	3194	3387	3579	3772	3964	4156	4349	N/A	N/A
			<i>Tight Seat &amp; Back / Removable Upholstery</i>														
	<b>1502-R</b>		362	N/A	727	919	1112	1304	1497	1689	1881	2074	2266	2459	N/A	N/A	
			<i>Replacement Upholstery Covers</i>														
	<b>THREE PLACE SOFA / FULLY UPHOLSTERED</b>		<b>Overall:</b> 80.25"w 31"d 34.5"h			<b>Arm:</b> 25.5"h			<b>COM:</b> 9.25 yds.								
	<b>Seat:</b> 70"w 20"d 18"h			<b>Weight:</b> 185 lbs.			<b>COL:</b> n/a										
				<b>COM</b>	<b>COL</b>	<b>1</b>	<b>2</b>	<b>3</b>	<b>4</b>	<b>5</b>	<b>6</b>	<b>7</b>	<b>8</b>	<b>9</b>	<b>10</b>	<b>L1</b>	<b>L2</b>
	<b>1503</b>			3160	N/A	3483	3730	3978	4225	4472	4720	4967	5215	5462	5709	N/A	N/A
			<i>Tight Seat &amp; Back / Removable Upholstery</i>														
	<b>1503-R</b>		456	N/A	926	1173	1420	1668	1915	2163	2410	2657	2905	3152	N/A	N/A	
			<i>Replacement Upholstery Covers</i>														

**DESCRIPTION:**

- Upholstery Frames: Steel, Plywood & Hardwood
- Seat: High Density Polyurethane Foam Over Strap Webbing
- Back: High Density Polyurethane Foam Over Sinuous Wire Springs
- Upholstered Covers: Attached w/ Velcro / Removable For Maintenance
- Antimicrobial Moisture Barrier Fully Encapsulates All Foam Areas
- Double Needle Stitching Standard (Welting Optional - No Charge)
- Exposed Wood Legs: Solid Hardwood / Removable For Maintenance
- Leather Upholstery Not Available
- Lifetime Warranty
- 1515, 1516: 500 lbs. Weight Rating / 1515-X: 1000 lbs. Weight Rating

**OPTIONS:**

- RWAC-1 Solid Wood Arm Caps (Set Of 2) .....\$374
- RPAC-1 Black Polyester Arm Caps (Set Of 2).....\$484
- ASL Aluminum Square Legs (Set Of 4).....\$348
- PM1 Power/Data Module (1-Power / 1-USB 2 Port Simplex Charger) .....\$836

Feather Down & Polyester Pillows Available (See Page 5)  
 Specify Exposed Wood Finish (See Page 6)  
 Tablet Arm / Cup Holder Options (See Facelift Replay Options Pages)

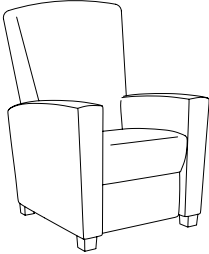
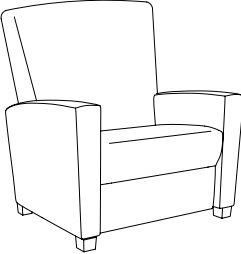
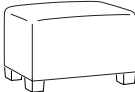
LOUNGE		ITEM #:	SPECIFICATIONS   GRADES   LIST PRICES:												
			<b>Overall:</b> 31.25"w 31"d 44"h			<b>Arm:</b> 25.5"h			<b>COM:</b> 5.75 yds.						
			<b>Seat:</b> 21"w 20"d 18"h			<b>Weight:</b> 85 lbs.			<b>COL:</b> n/a						
			<b>COM</b>	<b>COL</b>	<b>1</b>	<b>2</b>	<b>3</b>	<b>4</b>	<b>5</b>	<b>6</b>	<b>7</b>	<b>8</b>	<b>9</b>	<b>10</b>	<b>L1</b>
	<b>1515</b>	1573	N/A	1790	1941	2092	2243	2395	2546	2697	2848	2999	3150	N/A	N/A
		<i>Tight Seat &amp; Back / Removable Upholstery</i>													
	<b>1515-R</b>	262	N/A	550	701	853	1004	1155	1306	1457	1608	1760	1911	N/A	N/A
		<i>Replacement Upholstery Covers</i>													
			<b>Overall:</b> 39.25"w 31"d 44"h			<b>Arm:</b> 25.5"h			<b>COM:</b> 6 yds.						
			<b>Seat:</b> 29"w 20"d 18"h			<b>Weight:</b> 100 lbs.			<b>COL:</b> n/a						
			<b>COM</b>	<b>COL</b>	<b>1</b>	<b>2</b>	<b>3</b>	<b>4</b>	<b>5</b>	<b>6</b>	<b>7</b>	<b>8</b>	<b>9</b>	<b>10</b>	<b>L1</b>
	<b>1515-X</b>	1945	N/A	2142	2293	2444	2595	2746	2898	3049	3200	3351	3502	N/A	N/A
		<i>Tight Seat &amp; Back / Removable Upholstery / 500 lb. Weight Capacity</i>													
	<b>1515-XR</b>	268	N/A	556	707	858	1009	1160	1312	1463	1614	1765	1916	N/A	N/A
		<i>Replacement Upholstery Covers</i>													
			<b>Overall:</b> 22"w 18"d 15"h			<b>Arm:</b> n/a			<b>COM:</b> 2 yds.						
			<b>Seat:</b> 15"h			<b>Weight:</b> 18 lbs.			<b>COL:</b> n/a						
			<b>COM</b>	<b>COL</b>	<b>1</b>	<b>2</b>	<b>3</b>	<b>4</b>	<b>5</b>	<b>6</b>	<b>7</b>	<b>8</b>	<b>9</b>	<b>10</b>	<b>L1</b>
	<b>1516</b>	505	N/A	573	622	670	718	766	814	862	910	958	1006	N/A	N/A
		<i>Tight Seat &amp; Back / Removable Upholstery</i>													
	<b>1516-R</b>	105	N/A	196	244	292	340	388	436	484	532	581	629	N/A	N/A
		<i>Replacement Upholstery Covers</i>													



**DESCRIPTION:**

- Exposed Wood Frames: Solid Maple (Steambent Wallsaver Back Legs)
- Glued, Screwed, & Doweled Construction
- Mortise & Tenon Construction (Stacking Chairs)
- Seat: High Density Polyurethane Foam Over Sheet Webbing
- Back: High Density Polyurethane Foam Over Plywood
- Upholstered Covers: Attached w/ Velcro / Removable For Maintenance (Except 1520/1521)
- Antimicrobial Moisture Barrier Fully Encapsulates All Foam Areas (Except 1520/1521)
- Adjustable Height Leveling Glides Standard
- Lifetime Warranty
- 1520-1524-C: 350 lbs. Weight Rating

**OPTIONS:**

- RPAC-2 Black Polyester Arm Caps (Set Of 2).....\$172
- ST-1 Wooden Horizontal Stretchers (Guest Chairs Only).....\$97
- BR-1 Wooden Horizontal Book Rack (Guest Chairs Only).....\$167
- MGP Metal Ganging Plates (Side Chairs) .....\$36 Per Seat
- Stapled On Covers ..... n/c

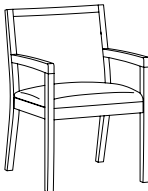
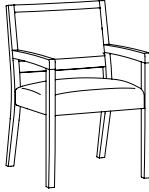
Specify Exposed Wood Finish (See Page 6)

GUEST	ITEM #:	SPECIFICATIONS   GRADES   LIST PRICES:													
		<b>Overall:</b> 22"w 24"d 33"h				<b>Arm:</b> 25"h				<b>COM:</b> 1.75 yds. (1520) / 1.5 yds. (1521)					
		<b>Seat:</b> 19.5"w 17.5"d 18.5"h				<b>Weight:</b> 28 lbs.				<b>COL:</b> n/a					
		<b>COM</b>	<b>COL</b>	<b>1</b>	<b>2</b>	<b>3</b>	<b>4</b>	<b>5</b>	<b>6</b>	<b>7</b>	<b>8</b>	<b>9</b>	<b>10</b>	<b>L1</b>	<b>L2</b>
	<b>1520</b>	1000	N/A	1028	1069	1111	1152	1193	1234	1276	1317	1358	1399	N/A	N/A
		<i>Wallsaver / Fully Upholstered Outside Back / Plain Seat</i>													
	<b>1521</b>	1027	N/A	1040	1074	1108	1143	1177	1211	1246	1280	1315	1349	N/A	N/A
		<i>Wallsaver / Exposed Wood Outside Back / Plain Seat</i>													
Removable Covers / Antimicrobial Moisture Barrier Not Available On 1520/1521															
		<b>Overall:</b> 22"w 24"d 33"h				<b>Arm:</b> 25"h				<b>COM:</b> 2 yds. (1522) / 1.5 yds. (1523)					
		<b>Seat:</b> 19.5"w 19"d 18.5"h				<b>Weight:</b> 28 lbs.				<b>COL:</b> n/a					
		<b>COM</b>	<b>COL</b>	<b>1</b>	<b>2</b>	<b>3</b>	<b>4</b>	<b>5</b>	<b>6</b>	<b>7</b>	<b>8</b>	<b>9</b>	<b>10</b>	<b>L1</b>	<b>L2</b>
	<b>1522</b>	965	N/A	1009	1057	1105	1153	1201	1249	1298	1346	1394	1442	N/A	N/A
		<i>Wallsaver / Upholstered Outside Back / Plain Seat / Removable Upholstery</i>													
	<b>1522-R</b>	79	N/A	157	198	239	280	322	363	404	445	487	528	N/A	N/A
		<i>Replacement Upholstery Covers</i>													
	<b>1523</b>	981	N/A	996	1031	1065	1099	1134	1168	1202	1237	1271	1305	N/A	N/A
		<i>Wallsaver / Exposed Wood Outside Back / Plain Seat / Removable Upholstery</i>													
	<b>1523-R</b>	75	N/A	140	174	209	243	278	312	346	381	415	449	N/A	N/A
		<i>Replacement Upholstery Covers</i>													
		<b>Overall:</b> 20"w 24"d 33"h				<b>Arm:</b> n/a				<b>COM:</b> 2 yds. (1524) / 1.5 yds. (1525)					
		<b>Seat:</b> 20"w 19"d 18.5"h				<b>Weight:</b> 25 lbs.				<b>COL:</b> n/a					
		<b>COM</b>	<b>COL</b>	<b>1</b>	<b>2</b>	<b>3</b>	<b>4</b>	<b>5</b>	<b>6</b>	<b>7</b>	<b>8</b>	<b>9</b>	<b>10</b>	<b>L1</b>	<b>L2</b>
	<b>1524</b>	901	N/A	948	997	1045	1093	1141	1189	1237	1285	1333	1381	N/A	N/A
		<i>Wallsaver / Upholstered Outside Back / Plain Seat / Removable Upholstery</i>													
	<b>1524-R</b>	79	N/A	157	198	239	280	322	363	404	445	487	528	N/A	N/A
		<i>Replacement Upholstery Covers</i>													
	<b>1525</b>	911	N/A	930	965	999	1033	1068	1102	1136	1171	1205	1239	N/A	N/A
		<i>Wallsaver / Exposed Wood Outside Back / Plain Seat / Removable Upholstery</i>													
	<b>1525-R</b>	75	N/A	140	174	209	243	278	312	346	381	415	449	N/A	N/A
		<i>Replacement Upholstery Covers</i>													
		<b>Overall:</b> 20"w 24"d 39"h				<b>Arm:</b> n/a				<b>COM:</b> 2 yds.					
		<b>Seat:</b> 20"w 19"d 24"h				<b>Weight:</b> 28 lbs.				<b>COL:</b> n/a					
		<b>COM</b>	<b>COL</b>	<b>1</b>	<b>2</b>	<b>3</b>	<b>4</b>	<b>5</b>	<b>6</b>	<b>7</b>	<b>8</b>	<b>9</b>	<b>10</b>	<b>L1</b>	<b>L2</b>
	<b>1524-C</b>	930	N/A	976	1024	1072	1120	1168	1216	1265	1313	1361	1409	N/A	N/A
		<i>Wallsaver / Upholstered Outside Back / Plain Seat / Removable Upholstery</i>													
	<b>1524-R</b>	79	N/A	157	198	239	280	322	363	404	445	487	528	N/A	N/A
		<i>Replacement Upholstery Covers</i>													



**DESCRIPTION:**

- Exposed Wood Frames: Solid Maple (Steambent Wallsaver Back Legs)
- Glued, Screwed, & Doweled Construction
- Mortise & Tenon Construction (Stacking Chairs)
- Seat: High Density Polyurethane Foam Over Sheet Webbing
- Back: High Density Polyurethane Foam Over Plywood
- Upholstered Covers: Attached w/ Velcro / Removable For Maintenance
- Antimicrobial Moisture Barrier Fully Encapsulates All Foam Areas
- Adjustable Height Leveling Glides Standard
- Lifetime Warranty
- 1528-1529: 500 lbs. Weight Rating / 1532-1533: 350 lbs. Weight Rating

**OPTIONS:**



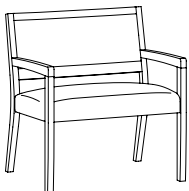
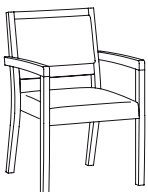

- RPAC-2 Black Polyester Arm Caps (Set Of 2).....\$172
- ST-1 Wooden Horizontal Stretchers (Guest Chairs Only).....\$97
- BR-1 Wooden Horizontal Book Rack (Guest Chairs Only).....\$167
- MGP Metal Ganging Plates (Side Chairs).....\$36 Per Seat
- SGS Soft Ganging Straps (Stacking Chairs).....\$24 Per Seat
- D800-6 Single Stacking Cart (Stacks 6 Chairs).....\$855 Each
- D800-12 Double Stacking Cart (Stacks 12 Chairs).....\$1248 Each
- Stapled On Covers ..... n/c

Specify Exposed Wood Finish (See Page 6)

GUEST / STACKING		ITEM #:	SPECIFICATIONS   GRADES   LIST PRICES:													
			<b>Overall:</b> 28"w 24"d 33"h			<b>Arm:</b> 25"h			<b>COM:</b> 2.25 yds. (1528) / 1.75 yds. (1529)							
			<b>Seat:</b> 25.5"w 19"d 18.5"h			<b>Weight:</b> 28 lbs.			<b>COL:</b> n/a							
			<b>COM</b>	<b>COL</b>	<b>1</b>	<b>2</b>	<b>3</b>	<b>4</b>	<b>5</b>	<b>6</b>	<b>7</b>	<b>8</b>	<b>9</b>	<b>10</b>	<b>L1</b>	<b>L2</b>
	<b>1528</b>	N/A	1159	1214	1269	1324	1379	1434	1489	1544	1599	1654	N/A	N/A		
			<i>Wallsaver / Upholstered Outside Back / Plain Seat / Removable Upholstery</i>													
<b>1528-R</b>	N/A	165	206	247	288	330	371	412	453	495	536	N/A	N/A			
		<i>Replacement Upholstery Covers</i>														
<b>1529</b>	N/A	1171	1212	1253	1295	1336	1377	1418	1459	1501	1542	N/A	N/A			
		<i>Wallsaver / Exposed Wood Outside Back / Plain Seat / Removable Upholstery</i>														
<b>1529-R</b>	N/A	148	182	217	251	285	320	354	389	423	457	N/A	N/A			
		<i>Replacement Upholstery Covers</i>														
			<b>Overall:</b> 22"w 24"d 33"h			<b>Arm:</b> 25"h			<b>COM:</b> 2 yds. (1532) / 1.5 yds. (1533)							
			<b>Seat:</b> 19.5"w 19"d 18.5"h			<b>Weight:</b> 28 lbs.			<b>COL:</b> n/a							
			<b>COM</b>	<b>COL</b>	<b>1</b>	<b>2</b>	<b>3</b>	<b>4</b>	<b>5</b>	<b>6</b>	<b>7</b>	<b>8</b>	<b>9</b>	<b>10</b>	<b>L1</b>	<b>L2</b>
	<b>1532</b>	N/A	1025	1074	1122	1170	1218	1266	1314	1362	1410	1458	N/A	N/A		
			<i>Wallsaver / Upholstered Outside Back / Plain Seat / Removable Upholstery</i>													
<b>1532-R</b>	N/A	157	198	239	280	322	363	404	445	487	528	N/A	N/A			
		<i>Replacement Upholstery Covers</i>														
<b>1533</b>	N/A	1040	1075	1109	1143	1178	1212	1246	1281	1315	1349	N/A	N/A			
		<i>Wallsaver / Exposed Wood Outside Back / Plain Seat / Removable Upholstery</i>														
<b>1533-R</b>	N/A	140	174	209	243	278	312	346	381	415	449	N/A	N/A			
		<i>Replacement Upholstery Covers</i>														

ARM CAPS / TABLETS	OPTION #:	SPECIFICATIONS   LIST PRICES   AVAILABILITY:
<p><b>WOOD / POLYESTER ARM CAPS</b></p>  <p>RWAC-1 Solid Wood Arm Cap</p>  <p>RPAC-1 Polyester Arm Cap</p>	<p><b>Overall:</b> 3.625"w 30.25"d .5"h</p> <p><b>RWAC-1</b> \$374 (Set Of 2) Solid Wood Arm Cap (Specify Finish)</p> <p><b>RPAC-1</b> \$484 (Set Of 2) Black Polyester Arm Cap (Additional Colors Available)</p> <p><b>RPAC-2</b> \$172 (Set Of 2) Black Polyester Arm Cap (Additional Colors Available)</p> <p><b>Available:</b> Facelift Replay Lounge (1501 / 1515) Facelift Replay Guest</p>  <p>RPAC-2 Polyester Arm Cap</p>	
<p><b>TABLET ARMS / CUP HOLDER</b></p>  <p>Laminate Tablet Arm Shown w/ Cup Holder</p>  <p>Veneer Tablet Arm Shown w/ Cup Holder</p>  <p>Solid Surface Tablet Arm Shown w/ Cup Holder</p>	<p><b>Overall:</b> 14" Diameter .75"h</p> <p><b>TA-L</b> \$440 Tablet Arm With 360° Rotation - High Pressure Laminate. (Specify Laminate / Specify Left Or Right Facing Arm Location)</p> <p><b>TA-V</b> \$503 Tablet Arm With 360° Rotation - Sunburst Cherry Veneer. (Specify Finish / Specify Left Or Right Facing Arm Location)</p> <p><b>TA-C</b> \$654 Tablet Arm With 360° Rotation - White Solid Surface. (Available In White Only / Specify Left Or Right Facing Arm Location)</p> <p><b>CH-1</b> \$105 Black Plastic Cup Holder (Only Available If Used With Tablet Arm)</p> <p><b>CH-2</b> \$157 Spun Aluminum Cup Holder (Only Available If Used With Tablet Arm)</p> <p><b>Available:</b> Facelift Replay Lounge</p>	
<p><b>FOLD DOWN TABLET ARM</b></p>   	<p><b>Overall:</b> 14" Diameter .75"h</p> <p><b>FDTA-L</b> \$1056 Tablet Arm With 360° Rotation - High Pressure Laminate. (Specify Laminate / Specify Left Or Right Facing Arm Location)</p> <p><b>FDTA-V</b> \$1108 Tablet Arm With 360° Rotation - Sunburst Cherry Veneer. (Specify Finish / Specify Left Or Right Facing Arm Location)</p> <p><b>FDTA-C</b> \$1259 Tablet Arm With 360° Rotation - White Solid Surface. (Available In White Only / Specify Left Or Right Facing Arm Location)</p> <p><b>Available:</b> Facelift Replay Lounge</p>	
<p><b>DOUBLE ARTICULATING / SWIVEL TABLET ARM</b></p>  <p>ATA-L Double Articulating / Swivel Tablet Arm</p>  <p>ATA-L w/ CH-1 Black Plastic Cup Holder</p>	<p><b>Overall:</b> 14" Diameter .75"h</p> <p><b>ATA-L</b> \$865 Tablet Arm With 360° Rotation - High Pressure Laminate. (Specify Laminate / Specify Left Or Right Facing Arm Location)</p> <p><b>ATA-V</b> \$904 Tablet Arm With 360° Rotation - Sunburst Cherry Veneer. (Specify Finish / Specify Left Or Right Facing Arm Location)</p> <p><b>ATA-C</b> \$1089 Tablet Arm With 360° Rotation - White Solid Surface. (Available In White Only / Specify Left Or Right Facing Arm Location)</p> <p><b>CH-1</b> \$105 Black Plastic Cup Holder (Only Available If Used With Tablet Arm)</p> <p><b>CH-2</b> \$157 Spun Aluminum Cup Holder (Only Available If Used With Tablet Arm)</p> <p><b>Available:</b> Facelift Replay Lounge</p>	

LEGS / POWER / GANGING	OPTION #:	SPECIFICATIONS   LIST PRICES   AVAILABILITY:
<p><b>ALUMINUM LEGS</b></p> 	<p><b>ASL</b></p> <p><b>\$348 (Set Of 4)</b> <i>(Brushed Finish)</i></p> <p><b>Available: Facelift Replay Lounge</b></p>	
<p><b>POWER / DATA MODULE</b></p> 	<p><b>PM1</b></p> <p><b>\$836 (1-Power / 1-USB 2 Port Simplex Charger Standard)</b> <i>Vertical / Horizontal Mount Power Module. Price Varies By Socket. Contact Customer Service For Quote. (Additional Colors Available)</i></p> <p><b>Available: Facelift Replay Lounge</b></p>	
<p><b>METAL GANGING PLATES</b></p>  <p>Replay Side Chairs Ganged With Metal Ganging Plates</p>   <p>Female &amp; Male Ganging Connectors</p>	<p><b>MGP</b></p> <p><b>\$36 Per Seat</b> <i>(Black Finish)</i></p> <p><b>Available: Facelift Replay Side Chairs</b></p>	
<p><b>SOFT GANGING STRAPS</b></p>  <p>Replay Stacking Chairs Soft Ganged</p>	<p><b>SGS</b></p> <p><b>\$24 Per Seat</b> <i>Black Velcro Soft Ganging Straps</i></p> <p><b>Available: Facelift Replay Stacking Chairs</b></p>	

STRETCHERS / BOOK RACK / STACKING / COVERS	OPTION #:	SPECIFICATIONS   LIST PRICES   AVAILABILITY:
<p><b>STRETCHERS</b></p> 	<p><b>ST-1</b></p> <p><i>Overall: 23"w 25"d 1"h</i></p> <p>\$97 <i>Wooden Horizontal Stretchers</i></p> <p><i>Available: Facelift Replay Guest Chairs</i></p>	
<p><b>BOOK RACK</b></p> 	<p><b>BR-1</b></p> <p><i>Overall: 23"w 25"d 1"h</i></p> <p>\$167 <i>Wooden Horizontal Book Rack</i></p> <p><i>Available: Facelift Replay Guest Chairs</i></p>	
<p><b>STACKING CARTS</b></p>  <p>Single Stacking</p> <p>Double Stacking</p>	<p><i>Overall: 26"w 37"d 12"h (Single Stacking Cart) / 37"w 50"d 12"h (Double Stacking Cart)</i></p> <p><b>D800-6</b> \$855 <i>Single Stacking Cart (Stacks 6 Chairs)</i></p> <p><b>D800-12</b> \$1248 <i>Double Stacking Cart (Stacks 12 Chairs)</i></p> <p><i>Available: Replay Stacking Chairs</i></p>	
<p><b>CONTRASTING COVERS</b></p> 	<p><i>Overall: N/A</i></p> <p><b>CC</b> \$129</p> <p><i>NOTE: If Two Or More Upholsteries Or Leathers Are Used On Any Piece Of Furniture, Then A Contrast Charge Will Apply Per Order. When Using Trinity Upholstery, The Higher Priced Upholstery Grade Will Be Used In Pricing, Unless It's Trinity Leather With Fabric Contrast Welt, Or COM With Trinity Contrast Welt, Then Contact Customer Service For Pricing.</i></p> <p><i>Available: Facelift Replay Collection</i></p>	

# Facelift Replay

---

HEALTHCARE MOTION

Effective: August 1, 2022

T R I N I T Y

**Date:**

**Page:**

**Modification:**

**Description:**

---

### DESCRIPTION:

- Upholstery Frames: Steel, Plywood & Hardwood
- Seat: High Density Polyurethane Foam Over Sheet Webbing
- Back: High Density Polyurethane Foam Over Polypropylene Webbing
- Upholstered Covers: Attached w/ Velcro / Removable For Maintenance
- Removable Bolster Pillow For 1504 / 1505 (5" Diameter)
- Antimicrobial Moisture Barrier Fully Encapsulates All Foam Areas
- Double Needle Stitching Standard (Welting Optional - No Charge)
- Metal To Metal Connections For All Hardware Assembly
- Leather Upholstery Not Available
- Lifetime Warranty

### OPTIONS:

- RWAC-1 Solid Wood Arm Caps (Set Of 2) .....\$374
- ILC In-Line Casters (Set Of 2).....\$57
- LC Locking Casters (Set Of 2) .....\$31
- NLC Non-Locking Casters (Set Of 2).....\$26
- 3LC 3" Locking Casters - #1506 Model Only (Set Of 2).....\$208
- PM1 Power/Data Module (1-Power / 1-USB 2 Port Simplex Charger) .....\$836
- Tablet Arm / Cup Holder Options (See Facelift Replay Healthcare Options Pages)
- Feather Down & Polyester Pillows Available (See Page 5)
- Specify Exposed Wood Finish (See Page 6)

## SLEEPOVER UNITS

**LOUNGE CHAIR / FULLY UPHOLSTERED**

**Overall:** 37.5"w 34.5"d 33"h      **Overall Length:** 84"d      **Arm:** 24"h      **COM:** 6.5 yds.  
**Sleep Area:** 28"w 80"d      **Seat:** 28"w 23"d 17.5"h      **Weight:** 175 lbs.      **COL:** n/a

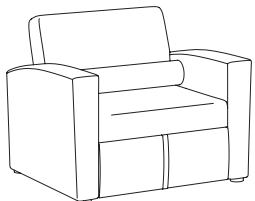

COM	COL	1	2	3	4	5	6	7	8	9	10	L1	L2
1504	N/A	4629	4800	4972	5144	5316	5488	5659	5831	6003	6175	N/A	N/A
<i>Tight Seat &amp; Back / Removable Upholstery / 500 lb. Weight Capacity</i>													
1504-R	N/A	625	797	968	1140	1312	1484	1656	1828	1999	2171	N/A	N/A
<i>Replacement Upholstery Covers</i>													



**TWO PLACE SOFA / FULLY UPHOLSTERED**

**Overall:** 57.5"w 34.5"d 33"h      **Overall Length:** 84"d      **Arm:** 24"h      **COM:** 9 yds.  
**Sleep Area:** 48"w 80"d      **Seat:** 48"w 23"d 17.5"h      **Weight:** 225 lbs.      **COL:** n/a

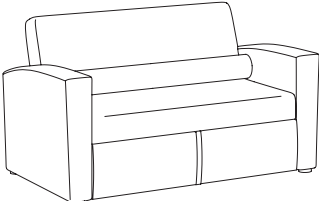

COM	COL	1	2	3	4	5	6	7	8	9	10	L1	L2
1505	N/A	5778	6019	6259	6500	6740	6981	7222	7462	7703	7943	N/A	N/A
<i>Tight Seat &amp; Back / Removable Upholstery / 500 lb. Weight Capacity</i>													
1505-R	N/A	825	1066	1306	1547	1787	2028	1443	1581	1718	1856	N/A	N/A
<i>Replacement Upholstery Covers</i>													



### FOUR POSITION ADJUSTMENT FOR 1504 / 1505

See Revival Healthcare Motion And Evolve Healthcare Motion For Additional Sleeper Units.



1) Closed Position

2) Ottoman Position

3) Chaise Position

4) Full-Recline Position  
Overall Length - 84"d

**BACK-FLIP SLEEPER SOFA**

**Overall:** 79"w 36"d 36"h      **Arm:** 24.5"h      **COM:** 13 yds.  
**Sleep Area:** 70"w 31"d 20"h      **Weight:** 235 lbs.      **COL:** n/a

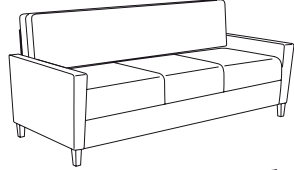

COM	COL	1	2	3	4	5	6	7	8	9	10	L1	L2
1506	N/A	4499	4849	5199	5550	5900	6251	6601	6952	7302	7653	N/A	N/A
<i>Tight Seat &amp; Back / Removable Upholstery / 1000 lbs. Weight Capacity</i>													
1506-R	N/A	1664	2008	2351	2695	3038	3382	3726	4069	4413	4757	N/A	N/A
<i>Replacement Upholstery Covers</i>													

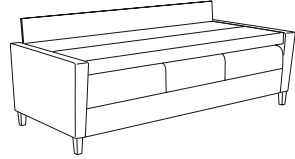

**DESCRIPTION:**

- Upholstery Frames: Steel, Plywood & Hardwood
- Seat: High Density Polyurethane Foam Over Sheet Webbing
- Back: High Density Polyurethane Foam Over Polypropylene Webbing
- Upholstered Covers: Attached w/ Velcro / Removable For Maintenance
- Antimicrobial Moisture Barrier Fully Encapsulates All Foam Areas
- Double Needle Stitching Standard (Wetling Optional - No Charge)
- Exposed Wood Legs: Solid Hardwood / Removable For Maintenance
- Leather Upholstery Not Available
- Lifetime Warranty

**OPTIONS:**

- RWAC-1 Solid Wood Arm Caps (Set Of 2) .....\$374
  - RPAC-1 Polyester Arm Caps (Set Of 2) .....\$484
  - ASL Aluminum Square Legs (Set Of 4) .....\$338
  - LC Locking Casters For 1809 Ottoman (Set Of 2) .....\$31
  - WR Wood Ring Base - Replaces Metal Base On 1510-G/1510-SG .....\$224
  - PM1 Power/Data Module (1-Power / 1-USB 2 Port Simplex Charger) .....\$836
- Feather Down & Polyester Pillows Available (See Page 5)  
Specify Exposed Wood Finish (See Page 6)  
Tablet Arm / Cup Holder Options (See Facelift Replay Healthcare Options Pages)

**PATIENT CHAIR / GLIDER**

ITEM #:

SPECIFICATIONS | GRADES | LIST PRICES:

**ASYNCHRONOUS PATIENT CHAIR / FULLY UPHOLSTERED**

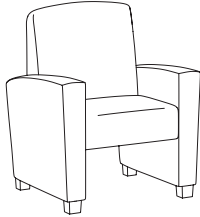

Healthcare Motion

		Overall: 32.5"w 35.5"d 38"h			Arm: 24"h			COM: 4.5 yds.					
		Seat: 21"w 20"d 18"h			Weight: 70 lbs.			COL: n/a					
COM	COL	1	2	3	4	5	6	7	8	9	10	L1	L2
1508	N/A	1760	1896	2031	2166	2301	2437	2572	2707	2842	2977	N/A	N/A
<i>Tight Seat &amp; Back / Removable Upholstery</i>													
1508-R	N/A	443	559	676	793	910	1027	1144	1260	1377	1494	N/A	N/A
<i>Replacement Upholstery Covers</i>													
1508-X	N/A	1824	1959	2095	2230	2365	2500	2635	2771	2906	3041	N/A	N/A
<i>Tight Seat &amp; Back / Removable Upholstery / 500 lbs. Weight Capacity</i>													
1508-XR	N/A	443	559	676	793	910	1027	1144	1260	1377	1494	N/A	N/A
<i>Replacement Upholstery Covers</i>													

**OTTOMAN ON CASTERS / STOWS UNDER ALL PATIENT CHAIRS**

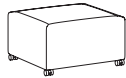

Healthcare Motion

		Overall: 18"w 18"d 11"h			Arm: n/a			COM: 1 yd.					
		Seat: n/a			Weight: 25 lbs.			COL: n/a					
COM	COL	1	2	3	4	5	6	7	8	9	10	L1	L2
1809	N/A	389	410	430	451	472	492	513	534	554	575	N/A	N/A
<i>Removable Upholstery</i>													
1809-R	N/A	118	139	159	180	201	221	242	262	283	304	N/A	N/A
<i>Replacement Upholstery Covers</i>													

**LOUNGE GLIDER / FULLY UPHOLSTERED**

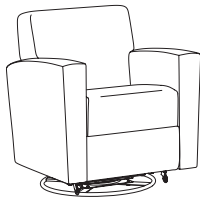

Healthcare Motion

		Overall: 32"w 32"d 35"h			Arm: 24"h			COM: 5.25 yds.					
		Seat: 21"w 20"d 18"h			Weight: 115 lbs.			COL: n/a					
COM	COL	1	2	3	4	5	6	7	8	9	10	L1	L2
1510-G	N/A	1917	2054	2192	2329	2467	2604	2741	2879	3016	3154	N/A	N/A
<i>Circular Metal Base / Tight Seat &amp; Back / Removable Upholstery</i>													
1510-SG	N/A	2049	2186	2324	2461	2598	2736	2873	3011	3148	3286	N/A	N/A
<i>Swivel Glider w/ Circular Metal Base / Tight Seat &amp; Back / Removable Upholstery</i>													
1510-R	N/A	505	643	780	918	1055	1192	1330	1467	1605	1742	N/A	N/A
<i>Replacement Upholstery Covers</i>													

See Revival Healthcare Motion And Evolve Healthcare Motion For Additional Patient Chairs & Gliders.









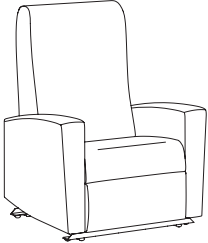

**DESCRIPTION:**

- Upholstery Frames: Steel, Plywood & Hardwood
- Seat: High Density Polyurethane Foam Over Sheet Webbing
- Back: High Density Polyurethane Foam Over Sinuous Wire Springs
- Upholstered Covers: Attached w/ Velcro / Removable For Maintenance
- Antimicrobial Moisture Barrier Fully Encapsulates All Foam Areas
- Double Needle Stitching Standard (Welting Optional - No Charge)
- Leather Upholstery Not Available
- Lifetime Warranty

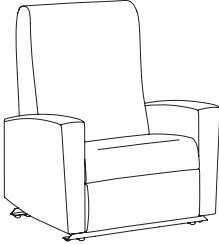
**OPTIONS:**

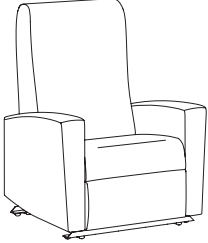
- RWAC-1 Solid Wood Arm Caps (Set Of 2) .....\$374
- RPAC-1 Polyester Arm Caps (Set Of 2) .....\$484
- ER-1 Electric Recline .....\$1048
- BB Battery Backup .....\$529
- HM Heat & Massage .....\$1500
- H Heat Only .....\$1339

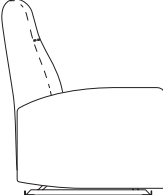
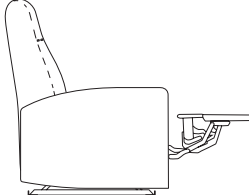
Feather Down & Polyester Pillows Available (See Page 5)  
Specify Exposed Wood Finish (See Page 6)

WALLSAVER		ITEM #:	SPECIFICATIONS   GRADES   LIST PRICES:														
	<b>WALLSAVER RECLINER / FULLY UPHOLSTERED</b>		<b>Overall:</b> 30.5"w 32"d 43"h <b>Seat:</b> 21"w 20.5"d 18"h			<b>Arm:</b> 23"h <b>Weight:</b> 110 lbs.			<b>COM:</b> 5 yds. <b>COL:</b> n/a								
			<b>COM</b>	<b>COL</b>	<b>1</b>	<b>2</b>	<b>3</b>	<b>4</b>	<b>5</b>	<b>6</b>	<b>7</b>	<b>8</b>	<b>9</b>	<b>10</b>	<b>L1</b>	<b>L2</b>	
	<b>1511</b>		1990	N/A	2183	2334	2485	2637	2788	2939	3090	3241	3392	3543	N/A	N/A	
		<i>Tight Seat &amp; Back / Removable Upholstery / 6" Wall Proximity / 350 lb. Weight Capacity</i>															
		<b>1511-R</b>	257	N/A	504	635	765	896	1027	1157	1288	1418	1549	1679	N/A	N/A	
		<i>Replacement Upholstery Covers</i>															
		 Healthcare Motion															
	<b>BARIATRIC WALLSAVER RECLINER / FULLY UPHOLSTERED</b>		<b>Overall:</b> 35.5"w 32"d 43"h <b>Seat:</b> 26"w 20.5"d 18"h			<b>Arm:</b> 23"h <b>Weight:</b> 125 lbs.			<b>COM:</b> 5.5 yds. <b>COL:</b> n/a								
			<b>COM</b>	<b>COL</b>	<b>1</b>	<b>2</b>	<b>3</b>	<b>4</b>	<b>5</b>	<b>6</b>	<b>7</b>	<b>8</b>	<b>9</b>	<b>10</b>	<b>L1</b>	<b>L2</b>	
	<b>1511-X</b>		2124	N/A	2311	2462	2613	2764	2915	3066	3217	3368	3520	3671	N/A	N/A	
		<i>Tight Seat &amp; Back / Removable Upholstery / 6" Wall Proximity / 500 lb. Weight Capacity</i>															
		<b>1511-XR</b>	263	N/A	537	682	826	970	1115	1259	1403	1548	1692	1836	N/A	N/A	
		<i>Replacement Upholstery Covers</i>															
		 Healthcare Motion															
	<b>ELECTRIC WALLSAVER RECLINER / FULLY UPHOLSTERED</b>		<b>Overall:</b> 30.5"w 32"d 43"h <b>Seat:</b> 21"w 20.5"d 18"h			<b>Arm:</b> 23"h <b>Weight:</b> 110 lbs.			<b>COM:</b> 5 yds. <b>COL:</b> n/a								
			<b>COM</b>	<b>COL</b>	<b>1</b>	<b>2</b>	<b>3</b>	<b>4</b>	<b>5</b>	<b>6</b>	<b>7</b>	<b>8</b>	<b>9</b>	<b>10</b>	<b>L1</b>	<b>L2</b>	
	<b>1511-E</b>		2891	N/A	3036	3187	3338	3489	3640	3792	3943	4094	4245	4396	N/A	N/A	
		<i>Tight Seat &amp; Back / Removable Upholstery / 6" Wall Proximity / 350 lb. Weight Capacity</i>															
		<b>1511-R</b>	257	N/A	504	635	765	896	1027	1157	1288	1418	1549	1679	N/A	N/A	
		<i>Replacement Upholstery Covers</i>															
		 Healthcare Motion															
																	
			Upright Position 32°D			Extended Footrest Position 52°D			Full Recline Position 64.5°D								
		 See Revival Healthcare Motion And Evolve Healthcare Motion For Additional Wallsaver Recliners.															

**DESCRIPTION:**

- Upholstery Frames: Steel, Plywood & Hardwood
- Seat: High Density Polyurethane Foam Over Sheet Webbing
- Back: High Density Polyurethane Foam Over Sinuous Wire Springs
- Upholstered Covers: Attached w/ Velcro / Removable For Maintenance
- Antimicrobial Moisture Barrier Fully Encapsulates All Foam Areas
- Double Needle Stitching Standard (Wetling Optional - No Charge)
- Dual-Wheel Casters: (2) Front Locking/Swivel & (2) Rear Non-Locking/Non-Swivel (1514)
- (2) Drop Down Side Trays Mounted To Black Metal Tubing (1514)
- Exposed Wood Legs (1512): Solid Hardwood / Removable For Maintenance
- Leather Upholstery Not Available
- Lifetime Warranty

**OPTIONS:**

(See Facelift Replay Healthcare Options Pages)  
 Feather Down & Polyester Pillows Available (See Page 5)

**INFUSION / STAND-UP RECLINER**

ITEM #:

SPECIFICATIONS | GRADES | LIST PRICES:

**INFUSION WALLSAVER RECLINER / FULLY UPHOLSTERED**



Optional Central Braking Available

Healthcare Motion

See Revival & Evolve Healthcare Motion For Additional Infusion WallSaver Recliners.

Overall: 31.25"w 34"d 46"h	Arm: 27"h	COM: 5 yds.														
Seat: 21"w 20.5"d 19"h	Weight: 130 lbs.	COL: n/a	COM	COL	1	2	3	4	5	6	7	8	9	10	L1	L2
			3077	N/A	3213	3364	3516	3667	3819	3970	4122	4273	4425	4576	N/A	N/A
<i>Tight Seat &amp; Back / Removable Upholstery / 350 lb. Weight Capacity</i>																
			281	N/A	582	740	898	1056	1214	1372	1530	1688	1846	2004	N/A	N/A
<i>Replacement Upholstery Covers</i>																



Upright Position  
32"D



Extended Footrest Position  
52"D



Full Recline Position  
64.5"D

**ELECTRIC STAND-UP RECLINER / FULLY UPHOLSTERED**

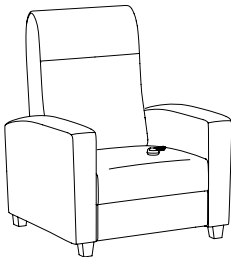

Healthcare Motion

See Revival Healthcare Motion For Additional Electric Stand-Up Recliner.

Overall: 33"w 35"d 42"h	Arm: 24.5"h	COM: 6.5 yds.														
Seat: 21.5"w 21.75"d 18"h	Weight: 145 lbs.	COL: n/a	COM	COL	1	2	3	4	5	6	7	8	9	10	L1	L2
			3264	N/A	3483	3682	3881	4080	4279	4478	4676	4875	5074	5273	N/A	N/A
<i>Tight Seat &amp; Back / Removable Upholstery / 350 lb. Weight Capacity</i>																
			284	N/A	613	784	956	1128	1300	1472	1643	1815	1987	2159	N/A	N/A
<i>Replacement Upholstery Covers</i>																

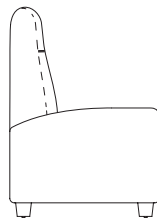

Upright Position  
35"D

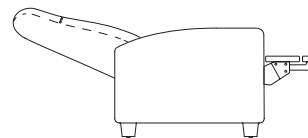

Full Recline Position  
66"D

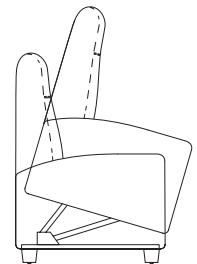





Stand-Up Position  
59"H

**DESCRIPTION:**

- Upholstery Frames: Steel, Plywood & Hardwood
- Seat: High Density Polyurethane Foam Over Sheet Webbing
- Back: High Density Polyurethane Foam Over Sinuous Wire Springs
- Upholstered Covers: Attached w/ Velcro / Removable For Maintenance
- Antimicrobial Moisture Barrier Fully Encapsulates All Foam Areas
- Double Needle Stitching Standard (Welting Optional - No Charge)
- Rotational & Directional Locking Casters (Rear)
- Leather Upholstery Not Available
- Lifetime Warranty

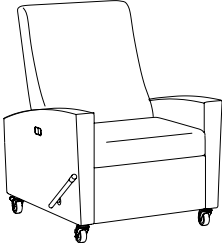
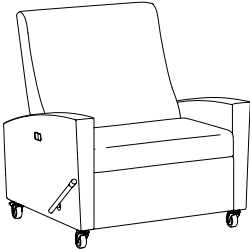
**OPTIONS:**

Layflat Medical Recliner Options (See Facelift Replay Healthcare Options Pages)  
 Feather Down & Polyester Pillows Available (See Page 5)

LAYFLAT MEDICAL RECLINER		ITEM #:	SPECIFICATIONS   GRADES   LIST PRICES:														
		<b>LAYFLAT / TRENDELENBURG RECLINER</b>	<b>Overall:</b> 32.75"w 38.5"d 45"h <b>Seat:</b> 24"w 20"d 20"h		<b>Arm:</b> 28"h <b>Weight:</b> 160 lbs.				<b>COM:</b> 5.5 yds. <b>COL:</b> n/a								
			<b>COM</b>	<b>COL</b>	<b>1</b>	<b>2</b>	<b>3</b>	<b>4</b>	<b>5</b>	<b>6</b>	<b>7</b>	<b>8</b>	<b>9</b>	<b>10</b>	<b>L1</b>	<b>L2</b>	
			<b>1513-L</b>	3550	N/A	3691	3858	4025	4192	4359	4526	4693	4860	5027	5194	N/A	N/A
			<i>Layflat / Tight Seat &amp; Back / Removable Upholstery / 500 lb. Weight Capacity</i>														
		<b>BARIATRIC LAYFLAT / TRENDELENBURG RECLINER</b>	<b>Overall:</b> 37.75"w 38.5"d 45"h <b>Seat:</b> 29"w 20"d 20"h		<b>Arm:</b> 28"h <b>Weight:</b> 185 lbs.				<b>COM:</b> 6 yds. <b>COL:</b> n/a								
			<b>COM</b>	<b>COL</b>	<b>1</b>	<b>2</b>	<b>3</b>	<b>4</b>	<b>5</b>	<b>6</b>	<b>7</b>	<b>8</b>	<b>9</b>	<b>10</b>	<b>L1</b>	<b>L2</b>	
			<b>1513-XL</b>	3671	N/A	3837	4020	4203	4386	4569	4752	4935	5118	5300	5483	N/A	N/A
			<i>Layflat / Tight Seat &amp; Back / Removable Upholstery / 600 lb. Weight Capacity</i>														
			<b>1513-XT</b>	3840	N/A	3996	4179	4362	4545	4728	4911	5094	5277	5460	5643	N/A	N/A
			<i>Trendelenburg / Tight Seat &amp; Back / Removable Upholstery / 600 lb. Weight Capacity</i>														
			<b>1513-XR</b>	303	N/A	603	761	919	1077	1235	1393	1551	1709	1867	2025	N/A	N/A
			<i>Replacement Upholstery Covers</i>														

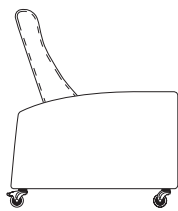

Upright Position  
38.5"D

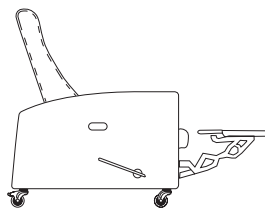

Extended Footrest Position  
57.5"D

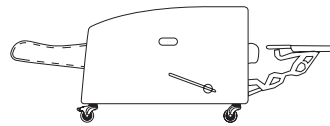

Layflat Position  
73.75"D

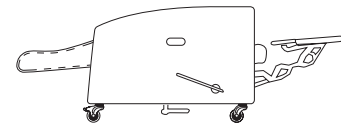



Trendelenburg Position  
74.75"D

 See Revival Healthcare Motion And Evolve Healthcare Motion For Additional Layflat Medical Recliners.

ARM CAPS / TABLETS	OPTION #:	SPECIFICATIONS   LIST PRICES   AVAILABILITY:
<p><b>SOLID WOOD ARM CAPS</b></p> 	<p><b>Overall:</b> Dimensions Will Vary By Style</p> <hr/> <p><b>RWAC-1</b> \$374 (Set Of 2)                      (1504 / 1505 Sleepover Lounge) - Specify Finish                      (1508 Asynchronous Patient Chair) - Specify Finish                      (1510-G Lounge Glider / 1510-SG Lounge Swivel Glider) - Specify Finish                      (1511 Wallsaver Recliner / 1511-X Bariatric Wallsaver Recliner / 1514 Infusion Wallsaver Recliner) - Specify Finish</p> <p><b>RWAC-2</b> \$411 (Set Of 2)                      (1512 Electric Standup Recliner) - Specify Finish</p> <p><b>RWAC-3</b> \$411 (Set Of 2)                      (1513-L &amp; 1513-T Medical Recliners / 1513-XL &amp; 1513-XT Bariatric Medical Recliners) - Specify Finish</p>	
<p><b>POLYESTER ARM CAPS</b></p> 	<p><b>Overall:</b> Dimensions Will Vary By Style</p> <hr/> <p><b>RPAC-1</b> \$484 (Set Of 2) POLYESTER                      (1508 Asynchronous Patient Chair)                      (1510-G Lounge Glider / 1510-SG Lounge Swivel Glider)                      (1511 Wallsaver Recliner / 1511-X Bariatric Wallsaver Recliner / 1514 Infusion Wallsaver Recliner)</p>	
<p><b>TABLET ARMS / CUP HOLDER</b></p>  <p>Laminate Tablet Arm Shown w/ Cup Holder</p>  <p>Veneer Tablet Arm Shown w/ Cup Holder</p>  <p>Solid Surface Tablet Arm Shown w/ Cup Holder</p>	<p><b>Overall:</b> 14" Diameter .75"h</p> <hr/> <p><b>TA-L</b> \$440                      Tablet Arm With 360° Rotation - High Pressure Laminate. (Specify Laminate / Specify Left Or Right Facing Arm Location)</p> <p><b>TA-V</b> \$503                      Tablet Arm With 360° Rotation - Sunburst Cherry Veneer. (Specify Finish / Specify Left Or Right Facing Arm Location)</p> <p><b>TA-C</b> \$654                      Tablet Arm With 360° Rotation - White Solid Surface. (Available In White Only / Specify Left Or Right Facing Arm Location)</p> <p><b>CH-1</b> \$103                      Black Plastic Cup Holder (Only Available If Used With Tablet Arm)</p> <p><b>CH-2</b> \$154                      Spun Aluminum Cup Holder (Only Available If Used With Tablet Arm)</p> <p><b>Available:</b> <b>Facelift Replay Sleepover Lounge</b></p>	
<p><b>FOLD DOWN TABLET ARM</b></p>  	<p><b>Overall:</b> 14" Diameter .75"h</p> <hr/> <p><b>FDTA-L</b> \$1056                      Tablet Arm With 360° Rotation - High Pressure Laminate. (Specify Laminate / Specify Left Or Right Facing Arm Location)</p> <p><b>FDTA-V</b> \$1108                      Tablet Arm With 360° Rotation - Sunburst Cherry Veneer. (Specify Finish / Specify Left Or Right Facing Arm Location)</p> <p><b>FDTA-C</b> \$1259                      Tablet Arm With 360° Rotation - White Solid Surface. (Available In White Only / Specify Left Or Right Facing Arm Location)</p> <p><b>Available:</b> <b>Facelift Replay Sleepover Lounge</b></p>	

TABLETS / CASTERS	OPTION #:	SPECIFICATIONS   LIST PRICES   AVAILABILITY:
<p><b>DOUBLE ARTICULATING / SWIVEL TABLET ARM</b></p>  <p>ATA-L Double Articulating / Swivel Tablet Arm</p>  <p>ATA-L w/ CH-1 Black Plastic Cup Holder</p>	<p><b>Overall:</b> 14" Diameter .75"h</p> <hr/> <p><b>ATA-L</b> \$865 <i>Tablet Arm With 360° Rotation - High Pressure Laminate. (Specify Laminate / Specify Left Or Right Facing Arm Location)</i></p> <p><b>ATA-V</b> \$904 <i>Tablet Arm With 360° Rotation - Sunburst Cherry Veneer. (Specify Finish / Specify Left Or Right Facing Arm Location)</i></p> <p><b>ATA-C</b> \$1089 <i>Tablet Arm With 360° Rotation - White Solid Surface. (Available In White Only / Specify Left Or Right Facing Arm Location)</i></p> <p><b>CH-1</b> \$105 <i>Black Plastic Cup Holder (Only Available If Used With Tablet Arm)</i></p> <p><b>CH-2</b> \$157 <i>Spun Aluminum Cup Holder (Only Available If Used With Tablet Arm)</i></p> <p><b>Available:</b> <i>Facelift Replay Sleepover Lounge</i></p>	
<p><b>IN-LINE CASTERS</b></p> 	<p><b>Overall:</b> 2.75" Diameter 1.75"h</p> <hr/> <p><b>ILC</b> \$57 (Set Of Two) <i>Single Direction In-Line Caster (Non-Locking / Specify Wood Finish / Specify Location)</i></p> <p><b>Available:</b> <i>Facelift Replay Sleepover Lounge</i></p>	
<p><b>LOCKING / NON-LOCKING CASTERS</b></p>  <p>Locking Casters</p>  <p>Non-Locking Casters</p>	<p><b>Overall:</b> 1.875"w 2.25"d 1.5"h (Locking) / 1.875"w 1.625"d 1.5"h (Non-Locking)</p> <hr/> <p><b>LC</b> \$31 (Set Of Two) <i>Locking Casters (Black Finish / Specify Location)</i></p> <p><b>NLC</b> \$26 (Set Of Two) <i>Non-Locking Casters (Black Finish / Specify Location)</i></p> <p><b>Available:</b> <i>Facelift Replay Sleepover Lounge</i></p>	
<p><b>MEDICAL LOCKING / NON-LOCKING CASTERS</b></p>  <p>Locking Casters</p>  <p>Non-Locking Casters</p>	<p><b>Overall:</b> 2.25"w 5"d 5.25"h (Locking) / 2"w 3.75"d 5.25"h (Non-Locking)</p> <hr/> <p><b>MLC</b> \$179 (Set Of Two) <i>Locking Casters - Motion &amp; Direction (Gray Finish / Specify Location)</i></p> <p><b>MNLC</b> \$205 (Set Of Two) <i>Non-Locking Casters - Single Direction (Gray Finish / Specify Location)</i></p> <p><b>Available:</b> <i>Facelift Replay Electric Standup Recliner</i></p>	

BRAKE / LEGS / POWER / ELECTRIC / PUSH BAR	OPTION #:	SPECIFICATIONS   LIST PRICES   AVAILABILITY:
<p><b>CENTRAL BRAKING</b></p> 	<p><b>CB-1</b></p>	<p><b>Overall:</b> 7.5"w 2"d .5"h</p> <p><b>\$405 (Set Of 1)</b> <i>(White Plastic Brake w/ Lock &amp; Unlock Pedals)</i></p> <p><b>Available:</b> <i>Facelift Replay Wallsaver &amp; Infusion Wallsaver Recliners</i></p>
<p><b>ALUMINUM LEGS</b></p> 	<p><b>ASL</b></p>	<p><b>Overall:</b> 2.25"w 2.25"d 2.25"h</p> <p><b>\$338 (Set Of 4)</b> <i>(Brushed Finish)</i></p> <p><b>Available:</b> <i>Facelift Replay Patient Chair / Glider (1508 / 1510 Models)</i></p>
<p><b>POWER / DATA MODULE</b></p> 	<p><b>PM1</b></p>	<p><b>Overall:</b> 5.25"w 1.25"d 4.25"h</p> <p><b>\$836 (1-Power / 1-USB 2 Port Simplex Charger Standard)</b> <i>Vertical / Horizontal Mount Power Module. Price Varies By Socket. Contact Customer Service For Quote. (Additional Colors Available)</i></p> <p><b>Available:</b> <i>Facelift Replay Sleepover Lounge</i></p>
<p><b>ELECTRIC RECLINE / BATTERY BACKUP / HEAT / MASSAGE</b></p>  <p>ER-1 Electric Recline (Wallsaver Model) ER-2/ER-3 Electric Recline (Layflat Model) HM Heat &amp; Massage (All Recliner Models) H Heat (All Recliner Models)</p>	<p><b>ER-1</b> <b>ER-2</b> <b>ER-3</b> <b>BB</b> <b>HM</b> <b>H</b></p>	<p><b>Overall:</b> N/A</p> <p><b>\$1048 Electric Recline</b> <i>Replaces Manual Mechanism On Any Wallsaver Model - Surface Mounts On Inside Arm (Specify Left Or Right Facing)</i></p> <p><b>\$1084 Electric Recline</b> <i>Replaces Manual Mechanism On Any Layflat Model - Surface Mounts On Inside Arm (Specify Left Or Right Facing)</i></p> <p><b>\$1474 Electric Recline</b> <i>Replaces Manual Mechanism On Any Trendelenburg Layflat Model - Surface Mounts On Inside Arm (Specify Left Or Right Facing)</i></p> <p><b>\$529 Battery Backup</b> <i>Allows Any Wallsaver, Layflat, Or Standup Electric Recliner To Be Cordless - Surface Mounts On Inside Arm (Specify Left Or Right Facing)</i></p> <p><b>\$1500 Heat &amp; Massage</b> <i>Add Heat &amp; Massage To Any Wallsaver, Layflat, Or Standup Electric Recliner - Surface Mounts On Inside Arm (Specify Left Or Right Facing)</i></p> <p><b>\$1339 Heat</b> <i>Add Heat Only To Any Wallsaver, Layflat, Or Standup Electric Recliner - Surface Mounts On Inside Arm (Specify Left Or Right Facing)</i></p> <p><b>Available:</b> <i>Facelift Replay Recliners</i></p>
<p><b>PUSH BAR</b></p> 	<p><b>PB</b></p>	<p><b>Overall:</b> 18.5"w 3.5"d 1"h</p> <p><b>\$235</b> <i>(Black Finish)</i></p> <p><b>Available:</b> <i>Facelift Replay Medical Recliners</i></p>

I.V. POLE / SIDE TRAY / BAG HOLDER / BUCKLE / FOOTREST	OPTION #:	SPECIFICATIONS   LIST PRICES   AVAILABILITY:
<p>I.V. POLE</p> 	<p><b>IV</b></p> <p><b>Overall:</b> 10"w 2.5"d 39.5" / 69.75"h</p> <hr/> <p><b>\$471</b>  <i>Height Adjustable I.V. Pole (Chrome &amp; Black Finish / Specify Left Or Right Facing Location)</i></p> <p><b>Available: Facelift Replay Medical Recliners</b></p>	
<p>SIDE TRAY</p> 	<p><b>Overall:</b> 12.75"w 10"d 4"h (Small Side Tray) / 17"w 10"d 4"h (Large Side Tray)</p> <hr/> <p><b>ST-1</b> <b>\$245</b>  <i>Drop-Down Side Tray (Small Side Tray)</i></p> <p><b>ST-2</b> <b>\$335</b>  <i>Drop-Down Side Tray (Large Side Tray)</i></p> <p><b>Available: Facelift Replay Medical Recliners</b>  <i>Note: If A Medical Recliner With A Manual Mechanism Is Selected, The Standard Side Tray Location Will Be Front Right Facing</i></p>	
<p>BAG HOLDER / PERSONAL RESTRAINT BUCKLE</p> 	<p><b>Overall:</b> 2.19"w .38"d 2.56"h</p> <hr/> <p><b>BH</b> <b>\$65</b>  <i>Bag Holder (Brushed Finish / Specify Left Or Right Facing Location)</i></p> <p><b>RB</b> <b>\$117 Pair</b>  <i>Personal Restraint Buckle (Brushed Finish)</i></p> <p><b>Available: Facelift Replay Medical Recliners</b></p>	
<p>FOOTREST</p> 	<p><b>Overall:</b> 16"w 8"d .1875"h</p> <hr/> <p><b>FR</b> <b>\$360</b>  <i>(Black Finish)</i></p> <p><b>Available: Facelift Replay Medical Recliners</b></p>	

OXYGEN TANK HOLDER / WOOD RING BASE / COVERS / SPRINGS	OPTION #:	SPECIFICATIONS   LIST PRICES   AVAILABILITY:
<p>OXYGEN TANK HOLDER</p>		<p><b>Overall:</b> 4.75" Diameter 9.75"h</p>
	<p><b>OH</b></p>	<p><b>\$238</b>                      Black Metal Oxygen Tank Holder Holds a 4.375" Diameter Oxygen Tank (Not Included) (Specify Left Or Right Facing Location)</p> <p><b>Available:</b> Facelift Replay Medical Recliners</p>
<p>LOUNGE GLIDER WOOD RING BASE</p>		<p><b>Overall:</b> 22"dia. 3"h</p>
	<p><b>WR</b></p>	<p><b>\$224</b>                      Wood Ring Base replaces circular metal base (1510-G) or swivel glider w/ circular metal base (1510-SG).</p> <p>Specify Exposed Wood Finish. (See Page 6)</p> <p><b>Available:</b> Facelift Replay Lounge Glider</p>
<p>CONTRASTING COVERS</p>		<p><b>Overall:</b> N/A</p>
	<p><b>CC</b></p>	<p><b>\$129</b>                      NOTE: If Two Or More Upholsteries Or Leathers Are Used On Any Piece Of Furniture, Then A Contrast Charge Will Apply Per Order. When Using Trinity Upholstery, The Higher Priced Upholstery Grade Will Be Used In Pricing, Unless It's Trinity Leather With Fabric Contrast Welt, Or COM With Trinity Contrast Welt, Then Contact Customer Service For Pricing.</p> <p><b>Available:</b> Facelift Replay Healthcare Motion</p>



# Facelift Polliwogs

---

BENCHES / OTTOMANS / TABLES

Effective: August 1, 2022

T R I N I T Y

**Date:**

**Page:**

**Modification:**

**Description:**

---

**DESCRIPTION:**

- Upholstery Frames: Hardwood Plywood
- Seat: High Density Polyurethane Foam Over Hardwood Plywood
- Upholstered Covers: Attached w/ Velcro / Removable For Maintenance
- Antimicrobial Moisture Barrier Fully Encapsulates All Foam Areas
- Round Black Plastic Feet / Removable For Maintenance
- Ganging Connectors Standard
- Leather Upholstery Is Available
- Lifetime Warranty

**OPTIONS:**

- LC Locking Casters (Set Of 2) .....\$31
- NLC Non-Locking Casters (Set Of 2).....\$26
- CC Contrasting Covers .....\$129

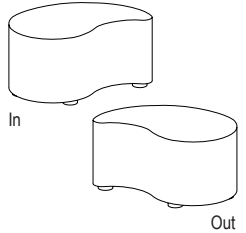
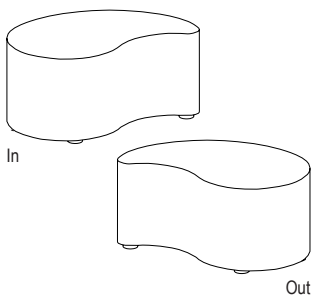
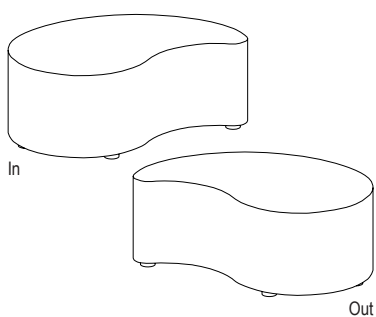
BENCHES		ITEM #:	SPECIFICATIONS   GRADES   LIST PRICES:														
<b>SMALL BENCH / FULLY UPHOLSTERED</b>			<b>Overall:</b> 18"w 30"d 14"h				<b>Arm:</b> n/a				<b>COM:</b> 2.75 yds.						
			<b>Seat:</b> 14"h				<b>Weight:</b> TBD lbs.				<b>COL:</b> 50 sq.ft.						
			<b>COM</b>	<b>COL</b>	<b>1</b>	<b>2</b>	<b>3</b>	<b>4</b>	<b>5</b>	<b>6</b>	<b>7</b>	<b>8</b>	<b>9</b>	<b>10</b>	<b>L1</b>	<b>L2</b>	
		<b>1540-I</b>	697	766	796	865	934	1002	1071	1140	1208	1277	1346	1415	1495	1743	
			<i>Small Size - In / Tight Seat / Removable Upholstery</i>														
		<b>1540-O</b>	697	766	796	865	934	1002	1071	1140	1208	1277	1346	1415	1495	1743	
	<i>Small Size - Out / Tight Seat / Removable Upholstery</i>																
	<b>1540-I/O R</b>	147	161	276	345	413	482	551	620	688	757	826	895	962	1210		
	<i>Replacement Upholstery Covers</i>																
<b>MEDIUM BENCH / FULLY UPHOLSTERED</b>			<b>Overall:</b> 24"w 40"d 18"h				<b>Arm:</b> n/a				<b>COM:</b> 3.00 yds.						
			<b>Seat:</b> 18"h				<b>Weight:</b> TBD lbs.				<b>COL:</b> 54 sq.ft.						
			<b>COM</b>	<b>COL</b>	<b>1</b>	<b>2</b>	<b>3</b>	<b>4</b>	<b>5</b>	<b>6</b>	<b>7</b>	<b>8</b>	<b>9</b>	<b>10</b>	<b>L1</b>	<b>L2</b>	
		<b>1541-I</b>	980	1078	1078	1154	1229	1305	1381	1456	1532	1607	1683	1758	1848	2120	
			<i>Medium Size - In / Tight Seat / Removable Upholstery</i>														
		<b>1541-O</b>	980	1078	1078	1154	1229	1305	1381	1456	1532	1607	1683	1758	1848	2120	
	<i>Medium Size - Out / Tight Seat / Removable Upholstery</i>																
	<b>1541-I/O R</b>	173	190	315	390	466	541	617	692	768	844	919	995	1070	1342		
	<i>Replacement Upholstery Covers</i>																
<b>LARGE BENCH / FULLY UPHOLSTERED</b>			<b>Overall:</b> 30"w 50"d 18"h				<b>Arm:</b> n/a				<b>COM:</b> 3.25 yds.						
			<b>Seat:</b> 18"h				<b>Weight:</b> TBD lbs.				<b>COL:</b> 59 sq.ft.						
			<b>COM</b>	<b>COL</b>	<b>1</b>	<b>2</b>	<b>3</b>	<b>4</b>	<b>5</b>	<b>6</b>	<b>7</b>	<b>8</b>	<b>9</b>	<b>10</b>	<b>L1</b>	<b>L2</b>	
		<b>1542-I</b>	1287	1416	1382	1465	1547	1630	1712	1795	1877	1959	2042	2124	2223	2519	
			<i>Large Size - In / Tight Seat / Removable Upholstery</i>														
		<b>1542-O</b>	1287	1416	1382	1465	1547	1630	1712	1795	1877	1959	2042	2124	2223	2519	
	<i>Large Size - Out / Tight Seat / Removable Upholstery</i>																
	<b>1542-I/O R</b>	194	213	348	431	513	596	678	760	843	925	1008	1090	1172	1469		
	<i>Replacement Upholstery Covers</i>																

**DESCRIPTION:**

- Upholstery Frames: Hardwood Plywood
- Seat: High Density Polyurethane Foam Over Hardwood Plywood
- Upholstered Covers: Attached w/ Velcro / Removable For Maintenance
- Antimicrobial Moisture Barrier Fully Encapsulates All Foam Areas
- Round Black Plastic Feet / Removable For Maintenance
- Ganging Connectors Standard
- Leather Upholstery Is Available
- Lifetime Warranty

**OPTIONS:**

- LC Locking Casters (Set Of 2) .....\$31
- NLC Non-Locking Casters (Set Of 2).....\$26
- CC Contrasting Covers .....\$129

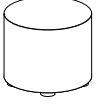
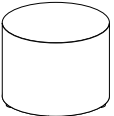
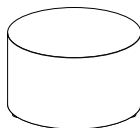
OTTOMANS		ITEM #:	SPECIFICATIONS   GRADES   LIST PRICES:													
	SMALL ROUND OTTOMAN / FULLY UPHOLSTERED		<b>Overall:</b> 18" Diameter 14"h			<b>Arm:</b> n/a			<b>COM:</b> 2.00 yds.							
			<b>Seat:</b> 14"h			<b>Weight:</b> TBD lbs.			<b>COL:</b> 36 sq.ft.							
			<b>COM</b>	<b>COL</b>	<b>1</b>	<b>2</b>	<b>3</b>	<b>4</b>	<b>5</b>	<b>6</b>	<b>7</b>	<b>8</b>	<b>9</b>	<b>10</b>	<b>L1</b>	<b>L2</b>
	<b>1543-18D</b>	460	506	531	579	628	676	724	772	820	868	916	964	1015	1189	
		<i>Small Size / Tight Seat / Removable Upholstery</i>														
	<b>1543-18DR</b>	89	98	180	229	277	325	373	421	469	517	565	613	657	830	
		<i>Replacement Upholstery Covers</i>														
	MEDIUM ROUND OTTOMAN / FULLY UPHOLSTERED		<b>Overall:</b> 24" Diameter 18"h			<b>Arm:</b> n/a			<b>COM:</b> 2.25 yds.							
			<b>Seat:</b> 18"h			<b>Weight:</b> 46 lbs.			<b>COL:</b> 41 sq.ft.							
			<b>COM</b>	<b>COL</b>	<b>1</b>	<b>2</b>	<b>3</b>	<b>4</b>	<b>5</b>	<b>6</b>	<b>7</b>	<b>8</b>	<b>9</b>	<b>10</b>	<b>L1</b>	<b>L2</b>
	<b>1543-24D</b>	703	773	774	829	884	939	994	1049	1104	1159	1214	1269	1328	1525	
		<i>Medium Size / Tight Seat / Removable Upholstery</i>														
	<b>1543-24DR</b>	104	114	208	263	318	373	428	483	538	593	648	703	753	951	
		<i>Replacement Upholstery Covers</i>														
	LARGE ROUND OTTOMAN / FULLY UPHOLSTERED		<b>Overall:</b> 30" Diameter 18"h			<b>Arm:</b> n/a			<b>COM:</b> 2.50 yds.							
			<b>Seat:</b> 18"h			<b>Weight:</b> TBD lbs.			<b>COL:</b> 45 sq.ft.							
			<b>COM</b>	<b>COL</b>	<b>1</b>	<b>2</b>	<b>3</b>	<b>4</b>	<b>5</b>	<b>6</b>	<b>7</b>	<b>8</b>	<b>9</b>	<b>10</b>	<b>L1</b>	<b>L2</b>
	<b>1543-30D</b>	827	910	906	968	1029	1091	1153	1215	1277	1339	1401	1462	1529	1752	
		<i>Large Size / Tight Seat / Removable Upholstery</i>														
	<b>1543-30DR</b>	125	137	242	304	366	427	489	551	613	675	737	799	856	1079	
		<i>Replacement Upholstery Covers</i>														

**DESCRIPTION:**

- Upholstery Frames: Hardwood Plywood
- Table Top: High Pressure Laminate Top Over Plywood Core
- Upholstered Covers: Attached w/ Velcro / Removable For Maintenance
- Antimicrobial Moisture Barrier Fully Encapsulates All Foam Areas
- Round Black Plastic Feet / Removable For Maintenance
- Ganging Connectors Standard
- Leather Upholstery Is Available
- Lifetime Warranty

**OPTIONS:**

- SE18D Self Edge Table Top - 18" Diameter.....\$30
- SE24D Self Edge Table Top - 24" Diameter.....\$33
- SE30D Self Edge Table Top - 30" Diameter.....\$33
- LC Locking Casters (Set Of 2).....\$31
- NLC Non-Locking Casters (Set Of 2).....\$26
- CC Contrasting Covers.....\$129

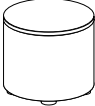
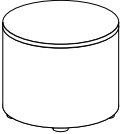
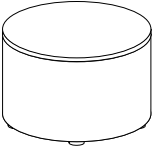
TABLES		ITEM #:	SPECIFICATIONS   GRADES   LIST PRICES:												
<b>SMALL ROUND TABLE / UPHOLSTERED BASE</b>  			<b>Overall:</b> 18" Diameter 14"h			<b>Arm:</b> n/a			<b>COM:</b> 1.25 yds.						
			<b>Seat:</b> 14"h			<b>Weight:</b> TBD lbs.			<b>COL:</b> 23 sq.ft.						
			<b>COM</b>	<b>COL</b>	<b>1</b>	<b>2</b>	<b>3</b>	<b>4</b>	<b>5</b>	<b>6</b>	<b>7</b>	<b>8</b>	<b>9</b>	<b>10</b>	<b>L1</b>
	<b>1544-18T</b>	566	623	590	618	645	673	700	728	755	783	810	838	874	973
		<i>Small Size / High Pressure Laminate Top / Removable Upholstery</i>													
	<b>1544-18TR</b>	89	98	139	167	194	222	249	277	304	332	359	387	416	515
		<i>Replacement Upholstery Covers</i>													
<b>MEDIUM ROUND TABLE / UPHOLSTERED BASE</b>  			<b>Overall:</b> 24" Diameter 18"h			<b>Arm:</b> n/a			<b>COM:</b> 1.50 yds.						
			<b>Seat:</b> 18"h			<b>Weight:</b> TBD lbs.			<b>COL:</b> 27 sq.ft.						
			<b>COM</b>	<b>COL</b>	<b>1</b>	<b>2</b>	<b>3</b>	<b>4</b>	<b>5</b>	<b>6</b>	<b>7</b>	<b>8</b>	<b>9</b>	<b>10</b>	<b>L1</b>
	<b>1544-24T</b>	857	943	879	914	948	982	1017	1051	1086	1120	1154	1189	1233	1356
		<i>Medium Size / High Pressure Laminate Top / Removable Upholstery</i>													
	<b>1544-24TR</b>	104	114	167	201	236	270	305	339	373	408	442	476	512	636
		<i>Replacement Upholstery Covers</i>													
<b>LARGE ROUND TABLE / UPHOLSTERED BASE</b>  			<b>Overall:</b> 30" Diameter 18"h			<b>Arm:</b> n/a			<b>COM:</b> 1.75 yds.						
			<b>Seat:</b> 18"h			<b>Weight:</b> TBD lbs.			<b>COL:</b> 32 sq.ft.						
			<b>COM</b>	<b>COL</b>	<b>1</b>	<b>2</b>	<b>3</b>	<b>4</b>	<b>5</b>	<b>6</b>	<b>7</b>	<b>8</b>	<b>9</b>	<b>10</b>	<b>L1</b>
	<b>1544-30T</b>	1019	1121	1032	1067	1101	1135	1170	1204	1238	1273	1307	1341	987	1513
		<i>Large Size / High Pressure Laminate Top / Removable Upholstery</i>													
	<b>1544-30TR</b>	125	137	201	242	283	324	366	407	448	489	531	572	132	658
		<i>Replacement Upholstery Covers</i>													

**DESCRIPTION:**

- Upholstery Frames: Hardwood Plywood
- Table Top: High Pressure Laminate Top Over Plywood Core
- Upholstered Covers: Attached w/ Velcro / Removable For Maintenance
- Antimicrobial Moisture Barrier Fully Encapsulates All Foam Areas
- Round Black Plastic Feet / Removable For Maintenance
- Ganging Connectors Standard
- Leather Upholstery Is Available
- Lifetime Warranty

**OPTIONS:**

- SE18D Self Edge Table Top - 18" Diameter.....\$30
- SE24D Self Edge Table Top - 24" Diameter.....\$33
- SE30D Self Edge Table Top - 30" Diameter.....\$33
- LC Locking Casters (Set Of 2).....\$31
- NLC Non-Locking Casters (Set Of 2).....\$26
- CC Contrasting Covers.....\$129

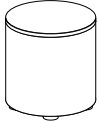
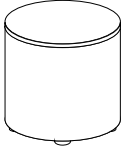
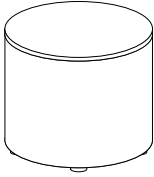
TABLES		ITEM #:	SPECIFICATIONS   GRADES   LIST PRICES:													
<p>TALL SMALL ROUND TABLE / UPHOLSTERED BASE</p> 			<b>Overall: 18" Diameter 18"h</b>			<b>Arm: n/a</b>			<b>COM: 1.25 yds.</b>							
			<b>Seat: 18"h</b>			<b>Weight: TBD lbs.</b>			<b>COL: 23 sq.ft.</b>							
			<b>COM</b>	<b>COL</b>	<b>1</b>	<b>2</b>	<b>3</b>	<b>4</b>	<b>5</b>	<b>6</b>	<b>7</b>	<b>8</b>	<b>9</b>	<b>10</b>	<b>L1</b>	<b>L2</b>
	<b>1545-18T</b>	620	682	641	668	696	723	751	778	806	833	861	888	927	1026	
		<i>Small Size / High Pressure Laminate Top / Removable Upholstery</i>														
	<b>1545-18TR</b>	95	105	145	172	200	227	255	282	310	337	365	392	423	522	
		<i>Replacement Upholstery Covers</i>														
<p>TALL MEDIUM ROUND TABLE / UPHOLSTERED BASE</p> 			<b>Overall: 24" Diameter 24"h</b>			<b>Arm: n/a</b>			<b>COM: 1.50 yds.</b>							
			<b>Seat: 24"h</b>			<b>Weight: TBD lbs.</b>			<b>COL: 27 sq.ft.</b>							
			<b>COM</b>	<b>COL</b>	<b>1</b>	<b>2</b>	<b>3</b>	<b>4</b>	<b>5</b>	<b>6</b>	<b>7</b>	<b>8</b>	<b>9</b>	<b>10</b>	<b>L1</b>	<b>L2</b>
	<b>1545-24T</b>	771	849	798	832	867	901	936	970	1004	1039	1073	1107	1153	1277	
		<i>Medium Size / High Pressure Laminate Top / Removable Upholstery</i>														
	<b>1545-24TR</b>	110	121	173	207	242	276	310	345	379	413	448	482	519	643	
		<i>Replacement Upholstery Covers</i>														
<p>TALL LARGE ROUND TABLE / UPHOLSTERED BASE</p> 			<b>Overall: 30" Diameter 24"h</b>			<b>Arm: n/a</b>			<b>COM: 1.75 yds.</b>							
			<b>Seat: 24"h</b>			<b>Weight: TBD lbs.</b>			<b>COL: 32 sq.ft.</b>							
			<b>COM</b>	<b>COL</b>	<b>1</b>	<b>2</b>	<b>3</b>	<b>4</b>	<b>5</b>	<b>6</b>	<b>7</b>	<b>8</b>	<b>9</b>	<b>10</b>	<b>L1</b>	<b>L2</b>
	<b>1545-30T</b>	1038	1141	1064	1105	1146	1187	1229	1270	1311	1352	1393	1435	1489	1638	
		<i>Large Size / High Pressure Laminate Top / Removable Upholstery</i>														
	<b>1545-30TR</b>	131	144	206	248	289	330	371	413	454	495	536	578	622	770	
		<i>Replacement Upholstery Covers</i>														

**CONFIGURATION EXAMPLES:**

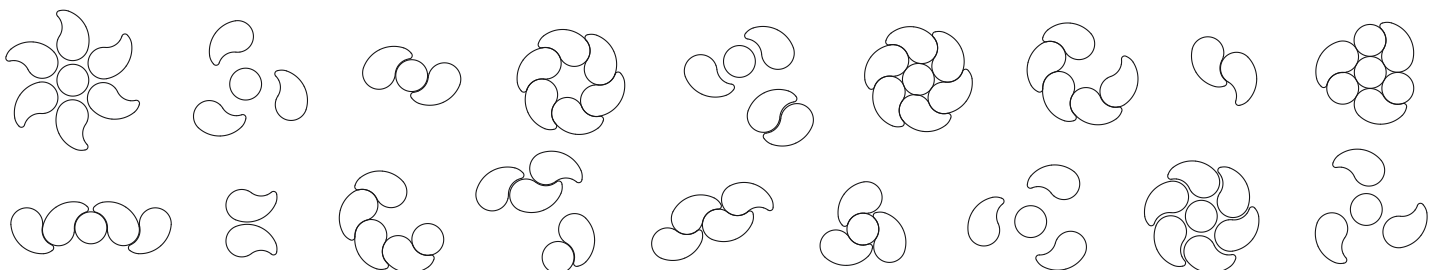

POWER / COVERS	OPTION #:	SPECIFICATIONS   LIST PRICES   AVAILABILITY:								
<p><b>LOCKING / NON-LOCKING CASTERS</b></p>  <p>Locking Casters</p>  <p>Non-Locking Casters</p>	<p><b>Overall:</b> 1.875"w 2.25"d 1.5"h (Locking) / 1.875"w 1.625"d 1.5"h (Non-Locking)</p> <hr/> <p><b>LC</b> \$31 (Set Of Two) <i>Locking Casters (Black Finish / Specify Location)</i></p> <p><b>NLC</b> \$26 (Set Of Two) <i>Non-Locking Casters (Black Finish / Specify Location)</i></p> <p><b>Available:</b> <i>Facelift Polliwogs Collection</i></p>									
<p><b>SELF EDGE TABLE TOP</b></p> 	<p><b>Overall:</b> 18" Diameter x 1"h / 24" Diameter x 1"h / 30" Diameter x 1"h</p> <hr/> <table border="0"> <tr> <td data-bbox="493 730 553 758"><b>SE18D</b></td> <td data-bbox="581 730 1052 758"><b>Self Edge Table Top - 18" Diameter</b></td> <td data-bbox="1068 730 1105 758"><b>\$30</b></td> </tr> <tr> <td data-bbox="493 779 553 806"><b>SE24D</b></td> <td data-bbox="581 779 1052 806"><b>Self Edge Table Top - 24" Diameter</b></td> <td data-bbox="1068 779 1105 806"><b>\$33</b></td> </tr> <tr> <td data-bbox="493 827 553 854"><b>SE30D</b></td> <td data-bbox="581 827 1052 854"><b>Self Edge Table Top - 30" Diameter</b></td> <td data-bbox="1068 827 1105 854"><b>\$33</b></td> </tr> </table> <p><i>High Pressure Laminate Top w/ Self Edge</i></p> <p><b>Available:</b> <i>Facelift Polliwogs Tables</i></p>	<b>SE18D</b>	<b>Self Edge Table Top - 18" Diameter</b>	<b>\$30</b>	<b>SE24D</b>	<b>Self Edge Table Top - 24" Diameter</b>	<b>\$33</b>	<b>SE30D</b>	<b>Self Edge Table Top - 30" Diameter</b>	<b>\$33</b>
<b>SE18D</b>	<b>Self Edge Table Top - 18" Diameter</b>	<b>\$30</b>								
<b>SE24D</b>	<b>Self Edge Table Top - 24" Diameter</b>	<b>\$33</b>								
<b>SE30D</b>	<b>Self Edge Table Top - 30" Diameter</b>	<b>\$33</b>								
<p><b>CONTRASTING COVERS</b></p> 	<p><b>Overall:</b> N/A</p> <hr/> <p><b>CC</b> \$129</p> <p><i>NOTE: If Two Or More Upholsteries Or Leathers Are Used On Any Piece Of Furniture, Then A Contrast Charge Will Apply Per Order. When Using Trinity Upholstery, The Higher Priced Upholstery Grade Will Be Used In Pricing, Unless It's Trinity Leather With Fabric Contrast Welt, Or COM With Trinity Contrast Welt, Then Contact Customer Service For Pricing.</i></p> <p><b>Available:</b> <i>Facelift Polliwogs Collection</i></p>									

# Facelift Fair & Square

---

LOUNGE / TANDEM / BENCHES / TABLES

Effective: August 1, 2022

T R I N I T Y



**Date:**

**Page:**

**Modification:**

**Description:**

---

**DESCRIPTION:**

- Upholstery Frames: Plywood & Hardwood
- Seat: High Density Polyurethane Foam Over Sheet Webbing
- Upholstered Covers: Attached w/ Velcro / Removable For Maintenance
- Antimicrobial Moisture Barrier Fully Encapsulates All Foam Areas
- Ganging Straps Standard
- Brushed Aluminum Round Legs / Removable For Maintenance
- Leather Upholstery Is Available
- Lifetime Warranty

**OPTIONS:**

- USB-1 USB In Back (2 Ports Available - Specify Left or Right Facing).....\$185
- Feather Down & Polyester Pillows Available (See Page 5)

**NOTE: Additional Seaming May Be Required If Fabric Is Railroaded.**

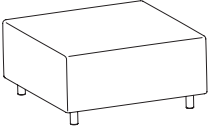
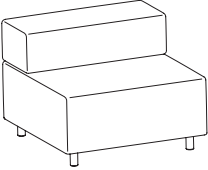
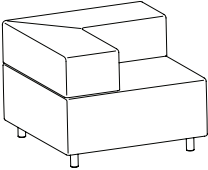
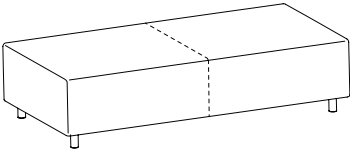
TANDEM		ITEM #:	SPECIFICATIONS   GRADES   LIST PRICES:													
			<b>Overall:</b> 36"w 36"d 18"h			<b>Arm:</b> n/a			<b>COM:</b> 2.5 yds.							
			<b>Seat:</b> 36"w 36"d 18"h			<b>Weight:</b> 62 lbs.			<b>COL:</b> 45 sq.ft.							
			<b>COM</b>	<b>COL</b>	<b>1</b>	<b>2</b>	<b>3</b>	<b>4</b>	<b>5</b>	<b>6</b>	<b>7</b>	<b>8</b>	<b>9</b>	<b>10</b>	<b>L1</b>	<b>L2</b>
	<b>1550</b>		1001	1101	1138	1235	1331	1427	1523	1619	1716	1812	1908	2004	2094	2441
			<i>Tight Seat / Removable Upholstery</i>													
	<b>1550-R</b>		117	129	234	296	358	420	482	544	605	667	729	791	848	1070
			<i>Replacement Upholstery Covers</i>													
			<b>Overall:</b> 36"w 36"d 28"h			<b>Arm:</b> n/a			<b>COM:</b> 3.25 yds.							
			<b>Seat:</b> 36"w 22"d 18"h			<b>Weight:</b> 70 lbs.			<b>COL:</b> 59 sq.ft.							
			<b>COM</b>	<b>COL</b>	<b>1</b>	<b>2</b>	<b>3</b>	<b>4</b>	<b>5</b>	<b>6</b>	<b>7</b>	<b>8</b>	<b>9</b>	<b>10</b>	<b>L1</b>	<b>L2</b>
	<b>1551</b>		1392	1531	1481	1563	1646	1728	1811	1893	1976	2058	2140	2223	2312	2609
			<i>Tight Seat &amp; Back / Removable Upholstery</i>													
	<b>1551-R</b>		160	176	316	399	481	564	646	729	811	894	976	1059	1134	1431
			<i>Replacement Upholstery Covers</i>													
			<b>Overall:</b> 36"w 36"d 28"h			<b>Arm:</b> n/a			<b>COM:</b> 4 yds.							
			<b>Seat:</b> 36"w 22"d 18"h			<b>Weight:</b> 74 lbs.			<b>COL:</b> 72 sq.ft.							
			<b>COM</b>	<b>COL</b>	<b>1</b>	<b>2</b>	<b>3</b>	<b>4</b>	<b>5</b>	<b>6</b>	<b>7</b>	<b>8</b>	<b>9</b>	<b>10</b>	<b>L1</b>	<b>L2</b>
	<b>1552</b>		1593	1752	1712	1815	1918	2022	2125	2228	2331	2434	2537	2640	2754	3125
			<i>Tight Seat &amp; Back / Removable Upholstery</i>													
	<b>1552-R</b>		211	232	406	509	612	715	818	921	1024	1127	1231	1334	1431	1802
			<i>Replacement Upholstery Covers</i>													
			<b>Overall:</b> 72"w 36"d 18"h			<b>Arm:</b> n/a			<b>COM:</b> 4.5 yds.							
			<b>Seat:</b> 72"w 36"d 18"h			<b>Weight:</b> 121 lbs.			<b>COL:</b> 81 sq.ft.							
			<b>COM</b>	<b>COL</b>	<b>1</b>	<b>2</b>	<b>3</b>	<b>4</b>	<b>5</b>	<b>6</b>	<b>7</b>	<b>8</b>	<b>9</b>	<b>10</b>	<b>L1</b>	<b>L2</b>
	<b>1555</b>		1452	1597	1606	1723	1840	1957	2074	2191	2307	2424	2541	2658	2771	3191
			<i>Tight Seat / Removable Upholstery</i>													
	<b>1555-R</b>		181	199	404	521	638	755	872	989	1105	1222	1339	1456	1554	1975
			<i>Replacement Upholstery Covers</i>													

**DESCRIPTION:**

- Upholstery Frames: Plywood & Hardwood
- Seat: High Density Polyurethane Foam Over Sheet Webbing
- Upholstered Covers: Attached w/ Velcro / Removable For Maintenance
- Antimicrobial Moisture Barrier Fully Encapsulates All Foam Areas
- Ganging Straps Standard
- Brushed Aluminum Round Legs / Removable For Maintenance
- Leather Upholstery Is Available
- Lifetime Warranty

**OPTIONS:**

- USB-1 USB In Back (2 Ports Available - Specify Left or Right Facing).....\$185
- Feather Down & Polyester Pillows Available (See Page 5)

**NOTE: Additional Seaming May Be Required If Fabric Is Railroaded.**

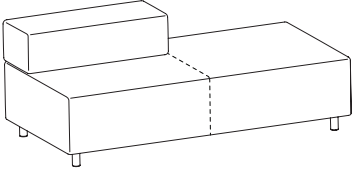
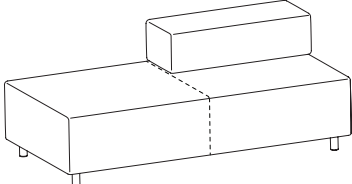
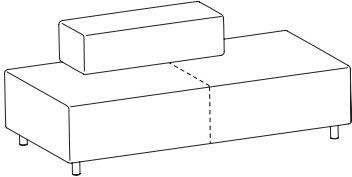
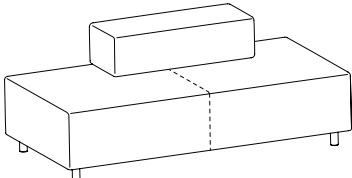
TANDEM		ITEM #:	SPECIFICATIONS   GRADES   LIST PRICES:													
			<b>Overall:</b> 72"w 36"d 28"h			<b>Arm:</b> n/a			<b>COM:</b> 5.25 yds.							
			<b>Seat:</b> 72"w 22"/36"d 18"h			<b>Weight:</b> 129 lbs.			<b>COL:</b> 95 sq.ft.							
			<b>COM</b>	<b>COL</b>	<b>1</b>	<b>2</b>	<b>3</b>	<b>4</b>	<b>5</b>	<b>6</b>	<b>7</b>	<b>8</b>	<b>9</b>	<b>10</b>	<b>L1</b>	<b>L2</b>
	<b>1556</b>		1964	2161	2132	2270	2407	2545	2682	2819	2957	3094	3232	3369	3508	4002
			<i>Tight Seat &amp; Back / Removable Upholstery</i>													
	<b>1556-R</b>		236	260	498	635	773	910	1048	1185	1323	1460	1598	1735	1853	2348
			<i>Replacement Upholstery Covers</i>													
			<b>Overall:</b> 72"w 36"d 28"h			<b>Arm:</b> n/a			<b>COM:</b> 5.25 yds.							
			<b>Seat:</b> 72"w 22"/36"d 18"h			<b>Weight:</b> 129 lbs.			<b>COL:</b> 95 sq.ft.							
			<b>COM</b>	<b>COL</b>	<b>1</b>	<b>2</b>	<b>3</b>	<b>4</b>	<b>5</b>	<b>6</b>	<b>7</b>	<b>8</b>	<b>9</b>	<b>10</b>	<b>L1</b>	<b>L2</b>
	<b>1557</b>		1964	2161	2132	2270	2407	2545	2682	2819	2957	3094	3232	3369	3508	4002
			<i>Tight Seat &amp; Back / Removable Upholstery</i>													
	<b>1557-R</b>		236	260	498	635	773	910	1048	1185	1323	1460	1598	1735	1853	2348
			<i>Replacement Upholstery Covers</i>													
			<b>Overall:</b> 72"w 36"d 28"h			<b>Arm:</b> n/a			<b>COM:</b> 5.25 yds.							
			<b>Seat:</b> 72"w 22"d 18"h			<b>Weight:</b> 129 lbs.			<b>COL:</b> 95 sq.ft.							
			<b>COM</b>	<b>COL</b>	<b>1</b>	<b>2</b>	<b>3</b>	<b>4</b>	<b>5</b>	<b>6</b>	<b>7</b>	<b>8</b>	<b>9</b>	<b>10</b>	<b>L1</b>	<b>L2</b>
	<b>1558</b>		1970	2167	2138	2275	2413	2550	2687	2825	2962	3100	3237	3375	3513	4008
			<i>Tight Seat &amp; Back / Removable Upholstery</i>													
	<b>1558-R</b>		236	260	498	635	773	910	1048	1185	1323	1460	1598	1735	1853	2348
			<i>Replacement Upholstery Covers</i>													
			<b>Overall:</b> 72"w 36"d 28"h			<b>Arm:</b> n/a			<b>COM:</b> 5.25 yds.							
			<b>Seat:</b> 72"w 22"d 18"h			<b>Weight:</b> 129 lbs.			<b>COL:</b> 95 sq.ft.							
			<b>COM</b>	<b>COL</b>	<b>1</b>	<b>2</b>	<b>3</b>	<b>4</b>	<b>5</b>	<b>6</b>	<b>7</b>	<b>8</b>	<b>9</b>	<b>10</b>	<b>L1</b>	<b>L2</b>
	<b>1559</b>		1970	2167	2138	2275	2413	2550	2687	2825	2962	3100	3237	3375	3513	4008
			<i>Tight Seat &amp; Back / Removable Upholstery</i>													
	<b>1559-R</b>		236	260	498	635	773	910	1048	1185	1323	1460	1598	1735	1853	2348
			<i>Replacement Upholstery Covers</i>													

**DESCRIPTION:**

- Upholstery Frames: Plywood & Hardwood
- Seat: High Density Polyurethane Foam Over Sheet Webbing
- Upholstered Covers: Attached w/ Velcro / Removable For Maintenance
- Antimicrobial Moisture Barrier Fully Encapsulates All Foam Areas
- Ganging Straps Standard
- Brushed Aluminum Round Legs / Removable For Maintenance
- Leather Upholstery Is Available
- Lifetime Warranty

**OPTIONS:**

- USB-1 USB In Back (2 Ports Available - Specify Left or Right Facing).....\$185
- Feather Down & Polyester Pillows Available (See Page 5)

**NOTE: Additional Seaming May Be Required If Fabric Is Railroaded.**

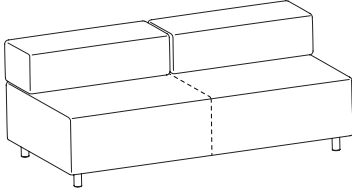
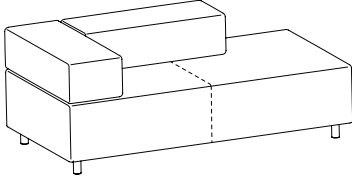
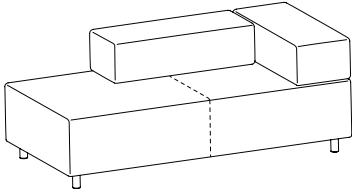
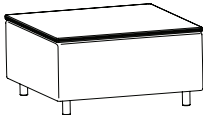
TANDEM		ITEM #:	SPECIFICATIONS   GRADES   LIST PRICES:													
			<b>Overall:</b> 72"w 36"d 28"h			<b>Arm:</b> n/a			<b>COM:</b> 6 yds.							
			<b>Seat:</b> 72"w 22"d 18"h			<b>Weight:</b> 137 lbs.			<b>COL:</b> 108 sq.ft.							
			<b>COM</b>	<b>COL</b>	<b>1</b>	<b>2</b>	<b>3</b>	<b>4</b>	<b>5</b>	<b>6</b>	<b>7</b>	<b>8</b>	<b>9</b>	<b>10</b>	<b>L1</b>	<b>L2</b>
	<b>1560</b>		2323	2556	2513	2671	2829	2987	3145	3303	3461	3619	3777	3935	4112	4681
			<i>Tight Seat &amp; Back / Removable Upholstery</i>													
	<b>1560-R</b>		256	281	558	716	874	1032	1190	1348	1506	1664	1822	1980	2118	2687
			<i>Replacement Upholstery Covers</i>													
			<b>Overall:</b> 72"w 36"d 28"h			<b>Arm:</b> n/a			<b>COM:</b> 6 yds.							
			<b>Seat:</b> 72"w 22"/36"d 18"h			<b>Weight:</b> 137 lbs.			<b>COL:</b> 108 sq.ft.							
			<b>COM</b>	<b>COL</b>	<b>1</b>	<b>2</b>	<b>3</b>	<b>4</b>	<b>5</b>	<b>6</b>	<b>7</b>	<b>8</b>	<b>9</b>	<b>10</b>	<b>L1</b>	<b>L2</b>
	<b>1561</b>		2358	2594	2546	2704	2862	3020	3178	3336	3494	3652	3810	3968	4145	4714
			<i>Tight Seat &amp; Back / Removable Upholstery</i>													
	<b>1561-R</b>		256	281	558	716	874	1032	1190	1348	1506	1664	1822	1980	2118	2687
			<i>Replacement Upholstery Covers</i>													
			<b>Overall:</b> 72"w 36"d 28"h			<b>Arm:</b> n/a			<b>COM:</b> 6 yds.							
			<b>Seat:</b> 72"w 22"/36"d 18"h			<b>Weight:</b> 137 lbs.			<b>COL:</b> 108 sq.ft.							
			<b>COM</b>	<b>COL</b>	<b>1</b>	<b>2</b>	<b>3</b>	<b>4</b>	<b>5</b>	<b>6</b>	<b>7</b>	<b>8</b>	<b>9</b>	<b>10</b>	<b>L1</b>	<b>L2</b>
	<b>1562</b>		2358	2594	2546	2704	2862	3020	3178	3336	3494	3652	3810	3968	4145	4714
			<i>Tight Seat &amp; Back / Removable Upholstery</i>													
	<b>1562-R</b>		256	281	558	716	874	1032	1190	1348	1506	1664	1822	1980	2118	2687
			<i>Replacement Upholstery Covers</i>													
			<b>Overall:</b> 36"w 36"d 19"h			<b>Arm:</b> n/a			<b>COM:</b> 2.25 yds.							
			<b>Seat:</b> n/a			<b>Weight:</b> 103 lbs.			<b>COL:</b> 41 sq.ft.							
			<b>COM</b>	<b>COL</b>	<b>1</b>	<b>2</b>	<b>3</b>	<b>4</b>	<b>5</b>	<b>6</b>	<b>7</b>	<b>8</b>	<b>9</b>	<b>10</b>	<b>L1</b>	<b>L2</b>
	<b>1564-L</b>		1437	1580	1468	1523	1578	1633	1688	1743	1798	1853	1908	1963	2024	2222
			<i>High Pressure Laminate Face / Multi-Ply Edge</i>													
	<b>1564-R</b>		117	129	234	296	358	420	482	544	605	667	729	791	848	1070
			<i>Replacement Upholstery Covers</i>													

**DESCRIPTION:**

- High Pressure Laminate Face
- Multi-Ply Edge
- Lifetime Warranty

**OPTIONS:**

Specify Laminate (See Page 6)

TANDEM	ITEM #:	SPECIFICATIONS   GRADES   LIST PRICES:																
TABLE TOP ONLY / CAN BE SUBSTITUTED FOR ANY BACK  		<b>Overall:</b> 36"w 14"d 1"h <b>Seat:</b> n/a	<b>Arm:</b> n/a <b>Weight:</b> 16 lbs.	<b>COM:</b> n/a <b>COL:</b> n/a														
	<b>COM</b> <b>COL</b> 1   2   3   4   5   6   7   8   9   10   L1   L2	T1-L 229 High Pressure Laminate Face / Multi-Ply Edge																

Configuration Examples

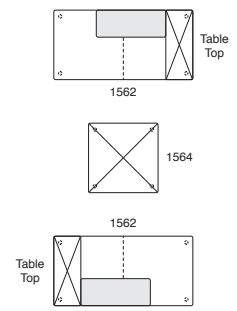
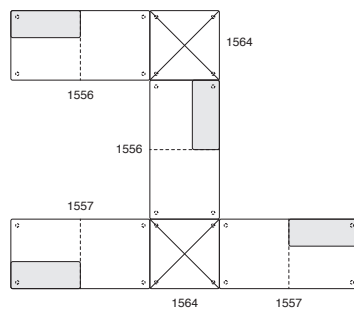
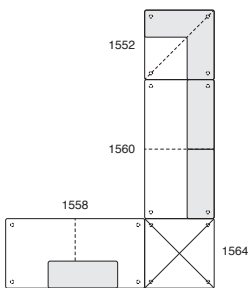
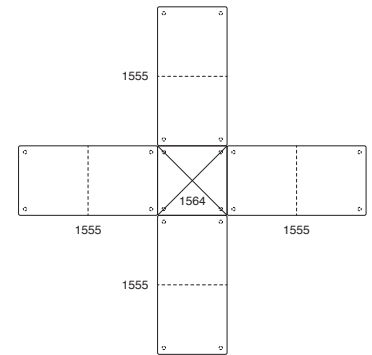
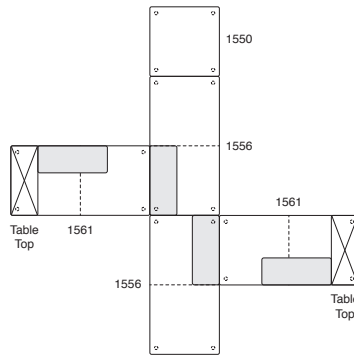
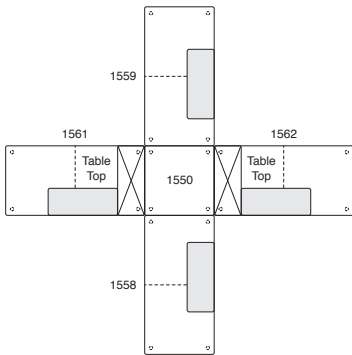
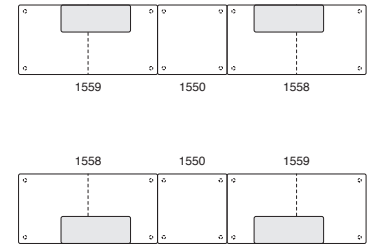
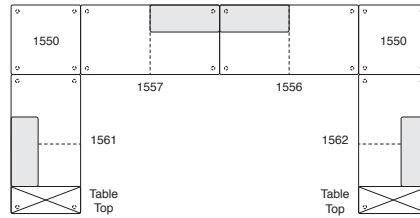
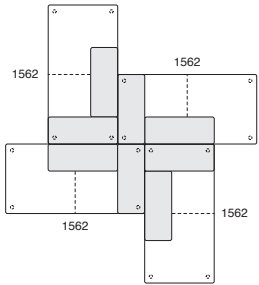
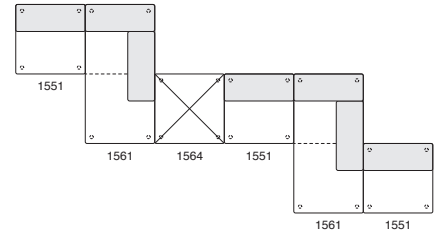
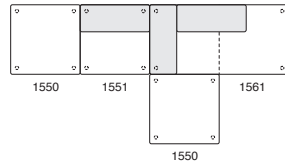
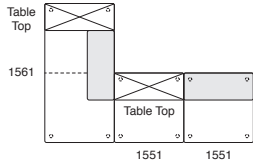

POWER / COVERS	OPTION #:	SPECIFICATIONS   LIST PRICES   AVAILABILITY:
<p>DUAL CHARGING USB</p> 	<p><b>USB-1</b></p>	<p><i>Overall: 2"w 2"d .1875"h</i></p> <hr/> <p><b>\$185 (Per Arm)</b>  <i>Spill-Proof Technology / 2 Amps Per Port / Multiple Finish Options / Storm Color Standard (Specify Left or Right Facing)</i></p> <p><i>Available: Facelift Fair &amp; Square Collection</i></p>
<p>CONTRASTING COVERS</p> 	<p><b>CC</b></p>	<p><i>Overall: N/A</i></p> <hr/> <p><b>\$129</b>  <i>NOTE: If Two Or More Upholsteries Or Leathers Are Used On Any Piece Of Furniture, Then A Contrast Charge Will Apply Per Order. When Using Trinity Upholstery, The Higher Priced Upholstery Grade Will Be Used In Pricing, Unless It's Trinity Leather With Fabric Contrast Welt, Or COM With Trinity Contrast Welt, Then Contact Customer Service For Pricing.</i></p> <p><i>Available: Facelift Fair &amp; Square Collection</i></p>

# Facelift Serpentine

---

LOUNGE / TANDEM / BENCHES / TABLES

Effective: August 1, 2022

T R I N I T Y



**Date:**

**Page:**

**Modification:**

**Description:**

---

**DESCRIPTION:**

- Upholstery Frames: Plywood & Hardwood
- Seat: High Density Polyurethane Foam Over Sheet Webbing
- Back: High Density Polyurethane Foam Over Strap Webbing
- Upholstered Covers: Attached w/ Velcro / Removable For Maintenance
- Antimicrobial Moisture Barrier Fully Encapsulates All Foam Areas
- Ganging Straps Standard
- Brushed Aluminum Round Legs Standard / Removable For Maintenance
- Leather Upholstery Is Not Available
- Lifetime Warranty

**OPTIONS:**

(See Facelift Serpentine Options Pages)

Feather Down & Polyester Pillows Available (See Page 5)

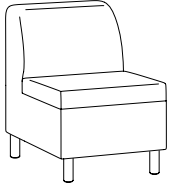
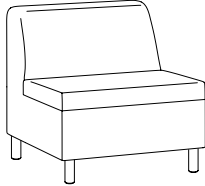
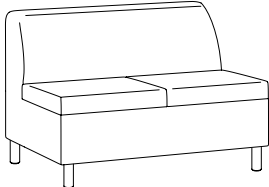
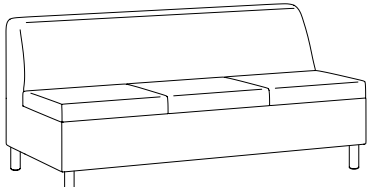
LOUNGE / TANDEM	ITEM #:	SPECIFICATIONS   GRADES   LIST PRICES:													
<b>STRAIGHT LOUNGE SECTION / FULLY UPHOLSTERED</b>  		<b>Overall:</b> 22"w 30"d 32"h		<b>Arm:</b> n/a		<b>COM:</b> 2.5 yds.									
		<b>Seat:</b> 22"w 19.5"d 18"h		<b>Weight:</b> 45 lbs.		<b>COL:</b> n/a									
		<b>COM</b>	<b>COL</b>	<b>1</b>	<b>2</b>	<b>3</b>	<b>4</b>	<b>5</b>	<b>6</b>	<b>7</b>	<b>8</b>	<b>9</b>	<b>10</b>	<b>L1</b>	<b>L2</b>
	<b>1571</b>	1133	N/A	1195	1257	1319	1381	1443	1505	1566	1628	1690	1752	N/A	N/A
		<i>Tight Seat &amp; Back / Removable Upholstery</i>													
	<b>1571-R</b>	166	N/A	281	343	404	466	528	590	652	714	775	837	N/A	N/A
		<i>Replacement Upholstery Covers</i>													
<b>STRAIGHT BARIATRIC LOUNGE SECTION / FULLY UPHOLSTERED</b>  		<b>Overall:</b> 30"w 30"d 32"h		<b>Arm:</b> n/a		<b>COM:</b> 3 yds.									
		<b>Seat:</b> 30"w 19.5"d 18"h		<b>Weight:</b> 65 lbs.		<b>COL:</b> n/a									
		<b>COM</b>	<b>COL</b>	<b>1</b>	<b>2</b>	<b>3</b>	<b>4</b>	<b>5</b>	<b>6</b>	<b>7</b>	<b>8</b>	<b>9</b>	<b>10</b>	<b>L1</b>	<b>L2</b>
	<b>1571-X</b>	1238	N/A	1322	1397	1473	1549	1624	1700	1775	1851	1927	2002	N/A	N/A
		<i>Tight Seat &amp; Back / Removable Upholstery</i>													
	<b>1571-XR</b>	172	N/A	314	389	465	540	616	692	767	843	918	994	N/A	N/A
		<i>Replacement Upholstery Covers</i>													
<b>STRAIGHT TWO PLACE LOUNGE SECTION / FULLY UPHOLSTERED</b>  		<b>Overall:</b> 44"w 30"d 32"h		<b>Arm:</b> n/a		<b>COM:</b> 4.25 yds.									
		<b>Seat:</b> 44"w 19.5"d 18"h		<b>Weight:</b> 80 lbs.		<b>COL:</b> n/a									
		<b>COM</b>	<b>COL</b>	<b>1</b>	<b>2</b>	<b>3</b>	<b>4</b>	<b>5</b>	<b>6</b>	<b>7</b>	<b>8</b>	<b>9</b>	<b>10</b>	<b>L1</b>	<b>L2</b>
	<b>1572</b>	1748	N/A	1872	1982	2092	2202	2312	2422	2532	2642	2752	2862	N/A	N/A
		<i>Tight Seat &amp; Back / Removable Upholstery</i>													
	<b>1572-R</b>	182	N/A	392	502	612	722	832	942	1052	1162	1272	1381	N/A	N/A
		<i>Replacement Upholstery Covers</i>													
<b>STRAIGHT THREE PLACE LOUNGE SECTION / FULLY UPHOLSTERED</b>  		<b>Overall:</b> 66"w 30"d 32"h		<b>Arm:</b> n/a		<b>COM:</b> 5.5 yds.									
		<b>Seat:</b> 66"w 19.5"d 18"h		<b>Weight:</b> 95 lbs.		<b>COL:</b> n/a									
		<b>COM</b>	<b>COL</b>	<b>1</b>	<b>2</b>	<b>3</b>	<b>4</b>	<b>5</b>	<b>6</b>	<b>7</b>	<b>8</b>	<b>9</b>	<b>10</b>	<b>L1</b>	<b>L2</b>
	<b>1573</b>	2394	N/A	2552	2696	2840	2985	3129	3273	3418	3562	3706	3851	N/A	N/A
		<i>Tight Seat &amp; Back / Removable Upholstery</i>													
	<b>1573-R</b>	238	N/A	514	658	803	947	1091	1236	1380	1524	1668	1813	N/A	N/A
		<i>Replacement Upholstery Covers</i>													

**DESCRIPTION:**

- Upholstery Frames: Plywood & Hardwood
- Seat: High Density Polyurethane Foam Over Sheet Webbing
- Back: High Density Polyurethane Foam Over Strap Webbing
- Upholstered Covers: Attached w/ Velcro / Removable For Maintenance
- Antimicrobial Moisture Barrier Fully Encapsulates All Foam Areas
- Ganging Straps Standard
- Brushed Aluminum Round Legs Standard / Removable For Maintenance
- Leather Upholstery Is Not Available
- Lifetime Warranty

**OPTIONS:**

(See Facelift Serpentine Options Pages)

Feather Down & Polyester Pillows Available (See Page 5)

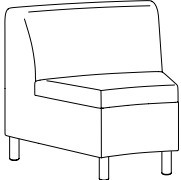
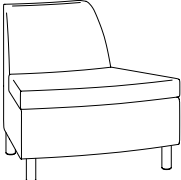
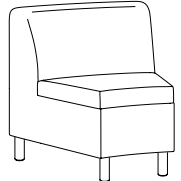
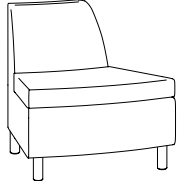
TANDEM	ITEM #:	SPECIFICATIONS   GRADES   LIST PRICES:													
		<b>Overall:</b> 34"w 30"d 32"h		<b>Arm:</b> n/a		<b>COM:</b> 3.25 yds.									
		<b>Seat:</b> 28"w 19.5"d 18"h		<b>Weight:</b> 50 lbs.		<b>COL:</b> n/a									
		<b>COM</b>	<b>COL</b>	<b>1</b>	<b>2</b>	<b>3</b>	<b>4</b>	<b>5</b>	<b>6</b>	<b>7</b>	<b>8</b>	<b>9</b>	<b>10</b>	<b>L1</b>	<b>L2</b>
	<b>1574</b>	1366	N/A	1457	1539	1622	1704	1786	1869	1951	2034	2116	2199	N/A	N/A
		<i>Tight Seat &amp; Back / 60" Radius / Removable Upholstery</i>													
	<b>1574-R</b>	184	N/A	339	421	504	586	669	751	669	731	793	854	N/A	N/A
		<i>Replacement Upholstery Covers</i>													
		<b>Overall:</b> 34"w 30"d 32"h		<b>Arm:</b> n/a		<b>COM:</b> 3.25 yds.									
		<b>Seat:</b> 34"w 19.5"d 18"h		<b>Weight:</b> 45 lbs.		<b>COL:</b> n/a									
		<b>COM</b>	<b>COL</b>	<b>1</b>	<b>2</b>	<b>3</b>	<b>4</b>	<b>5</b>	<b>6</b>	<b>7</b>	<b>8</b>	<b>9</b>	<b>10</b>	<b>L1</b>	<b>L2</b>
	<b>1575</b>	1293	N/A	1387	1470	1552	1635	1717	1800	1882	1965	2047	2130	N/A	N/A
		<i>Tight Seat &amp; Back / 60" Radius / Removable Upholstery</i>													
	<b>1575-R</b>	169	N/A	325	407	490	572	655	737	820	902	984	1067	N/A	N/A
		<i>Replacement Upholstery Covers</i>													
		<b>Overall:</b> 32"w 30"d 32"h		<b>Arm:</b> n/a		<b>COM:</b> 2.75 yds.									
		<b>Seat:</b> 25.5"w 19.5"d 18"h		<b>Weight:</b> 50 lbs.		<b>COL:</b> n/a									
		<b>COM</b>	<b>COL</b>	<b>1</b>	<b>2</b>	<b>3</b>	<b>4</b>	<b>5</b>	<b>6</b>	<b>7</b>	<b>8</b>	<b>9</b>	<b>10</b>	<b>L1</b>	<b>L2</b>
	<b>1576</b>	1244	N/A	1314	1382	1451	1520	1589	1657	1726	1795	1863	1932	N/A	N/A
		<i>Tight Seat &amp; Back / 30" Radius / Removable Upholstery</i>													
	<b>1576-R</b>	178	N/A	306	375	443	512	581	650	718	787	856	925	N/A	N/A
		<i>Replacement Upholstery Covers</i>													
		<b>Overall:</b> 32"w 30"d 32"h		<b>Arm:</b> n/a		<b>COM:</b> 2.75 yds.									
		<b>Seat:</b> 32"w 19.5"d 18"h		<b>Weight:</b> 45 lbs.		<b>COL:</b> n/a									
		<b>COM</b>	<b>COL</b>	<b>1</b>	<b>2</b>	<b>3</b>	<b>4</b>	<b>5</b>	<b>6</b>	<b>7</b>	<b>8</b>	<b>9</b>	<b>10</b>	<b>L1</b>	<b>L2</b>
	<b>1577</b>	1212	N/A	1283	1352	1420	1489	1558	1627	1695	1764	1833	1901	N/A	N/A
		<i>Tight Seat &amp; Back / 30" Radius / Removable Upholstery</i>													
	<b>1577-R</b>	163	N/A	292	360	429	498	567	635	1309	1453	1598	1742	N/A	N/A
		<i>Replacement Upholstery Covers</i>													

**DESCRIPTION:**

- Upholstery Frames: Plywood & Hardwood
- Seat: High Density Polyurethane Foam Over Sheet Webbing
- Back: High Density Polyurethane Foam Over Strap Webbing
- Upholstered Covers: Attached w/ Velcro / Removable For Maintenance
- Antimicrobial Moisture Barrier Fully Encapsulates All Foam Areas
- Ganging Straps Standard
- Brushed Aluminum Round Legs Standard / Removable For Maintenance
- Leather Upholstery Is Not Available
- Lifetime Warranty

**OPTIONS:**

(See Facelift Serpentine Options Pages)

Feather Down & Polyester Pillows Available (See Page 5)

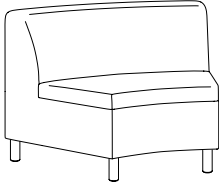
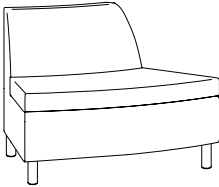
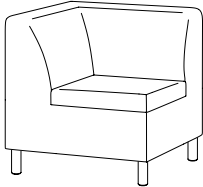
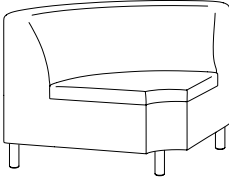
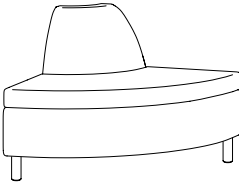
TANDEM		ITEM #:	SPECIFICATIONS   GRADES   LIST PRICES:													
			<b>Overall:</b> 46.5"w 30"d 32"h			<b>Arm:</b> n/a			<b>COM:</b> 3.5 yds.							
			<b>Seat:</b> 37.5"w 19.5"d 18"h			<b>Weight:</b> 50 lbs.			<b>COL:</b> n/a							
			<b>COM</b>	<b>COL</b>	<b>1</b>	<b>2</b>	<b>3</b>	<b>4</b>	<b>5</b>	<b>6</b>	<b>7</b>	<b>8</b>	<b>9</b>	<b>10</b>	<b>L1</b>	<b>L2</b>
	<b>1578</b>		1696	N/A	1782	1871	1961	2050	2139	2229	2318	2407	2497	2586	N/A	N/A
			<i>Tight Seat &amp; Back / 30" Radius / Removable Upholstery</i>													
	<b>1578-R</b>		208	N/A	375	465	554	643	733	822	911	1001	1090	1179	N/A	N/A
			<i>Replacement Upholstery Covers</i>													
			<b>Overall:</b> 46.5"w 30"d 32"h			<b>Arm:</b> n/a			<b>COM:</b> 3.25 yds.							
			<b>Seat:</b> 46.5"w 19.5"d 18"h			<b>Weight:</b> 50 lbs.			<b>COL:</b> n/a							
			<b>COM</b>	<b>COL</b>	<b>1</b>	<b>2</b>	<b>3</b>	<b>4</b>	<b>5</b>	<b>6</b>	<b>7</b>	<b>8</b>	<b>9</b>	<b>10</b>	<b>L1</b>	<b>L2</b>
	<b>1579</b>		1632	N/A	1708	1790	1873	1955	2037	2120	2202	2285	2367	2450	N/A	N/A
			<i>Tight Seat &amp; Back / 30" Radius / Removable Upholstery</i>													
	<b>1579-R</b>		208	N/A	362	444	527	609	691	774	856	939	1021	1104	N/A	N/A
			<i>Replacement Upholstery Covers</i>													
			<b>Overall:</b> 30"w 30"d 32"h			<b>Arm:</b> n/a			<b>COM:</b> 3.5 yds.							
			<b>Seat:</b> 19.5"w 19.5"d 18"h			<b>Weight:</b> 80 lbs.			<b>COL:</b> n/a							
			<b>COM</b>	<b>COL</b>	<b>1</b>	<b>2</b>	<b>3</b>	<b>4</b>	<b>5</b>	<b>6</b>	<b>7</b>	<b>8</b>	<b>9</b>	<b>10</b>	<b>L1</b>	<b>L2</b>
	<b>1580</b>		1700	N/A	1731	1793	1855	1917	1978	2040	2102	2164	2226	2288	N/A	N/A
			<i>Tight Seat &amp; Back / Removable Upholstery</i>													
	<b>1580-R</b>		236	N/A	443	553	663	773	883	993	718	779	841	903	N/A	N/A
			<i>Replacement Upholstery Covers</i>													
			<b>Overall:</b> 51"w 33"d 32"h			<b>Arm:</b> n/a			<b>COM:</b> 4 yds.							
			<b>Seat:</b> 37.5"w 19.5"d 18"h			<b>Weight:</b> 70 lbs.			<b>COL:</b> n/a							
			<b>COM</b>	<b>COL</b>	<b>1</b>	<b>2</b>	<b>3</b>	<b>4</b>	<b>5</b>	<b>6</b>	<b>7</b>	<b>8</b>	<b>9</b>	<b>10</b>	<b>L1</b>	<b>L2</b>
	<b>1581</b>		1967	N/A	2066	2169	2272	2375	2478	2581	2685	2788	2891	2994	N/A	N/A
			<i>Tight Seat &amp; Back / 6" Radius / Removable Upholstery</i>													
	<b>1581-R</b>		223	N/A	348	417	486	554	623	692	761	829	898	967	N/A	N/A
			<i>Replacement Upholstery Covers</i>													
			<b>Overall:</b> 51"w 33"d 32"h			<b>Arm:</b> n/a			<b>COM:</b> 4 yds.							
			<b>Seat:</b> 51"w 19.5"d 18"h			<b>Weight:</b> 70 lbs.			<b>COL:</b> n/a							
			<b>COM</b>	<b>COL</b>	<b>1</b>	<b>2</b>	<b>3</b>	<b>4</b>	<b>5</b>	<b>6</b>	<b>7</b>	<b>8</b>	<b>9</b>	<b>10</b>	<b>L1</b>	<b>L2</b>
	<b>1582</b>		1770	N/A	1880	1983	2086	2189	2292	2395	2498	2601	2704	2808	N/A	N/A
			<i>Tight Seat &amp; Back / 6" Radius / Removable Upholstery</i>													
	<b>1582-R</b>		213	N/A	380	470	559	649	738	827	917	1006	1095	1185	N/A	N/A
			<i>Replacement Upholstery Covers</i>													



**DESCRIPTION:**

- Upholstery Frames: Plywood & Hardwood
- Seat: High Density Polyurethane Foam Over Sheet Webbing
- Upholstered Covers: Attached w/ Velcro / Removable For Maintenance
- Antimicrobial Moisture Barrier Fully Encapsulates All Foam Areas
- Ganging Straps Standard
- Brushed Aluminum Round Legs Standard / Removable For Maintenance
- Leather Upholstery Is Not Available
- Lifetime Warranty

**OPTIONS:**

(See Facelift Serpentine Options Pages)

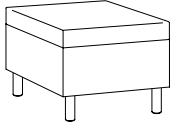
Feather Down & Polyester Pillows Available (See Page 5)

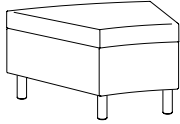
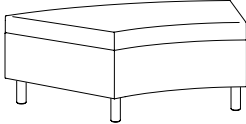
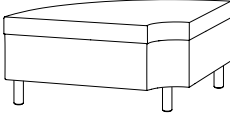
BENCHES		ITEM #:	SPECIFICATIONS   GRADES   LIST PRICES:													
			<b>Overall:</b> 30"w 22"d 18"h				<b>Arm:</b> n/a				<b>COM:</b> 2 yds.					
			<b>Seat:</b> 30"w 22"d 18"h				<b>Weight:</b> 20 lbs.				<b>COL:</b> n/a					
			<b>COM</b>	<b>COL</b>	<b>1</b>	<b>2</b>	<b>3</b>	<b>4</b>	<b>5</b>	<b>6</b>	<b>7</b>	<b>8</b>	<b>9</b>	<b>10</b>	<b>L1</b>	<b>L2</b>
	<b>1587</b>		797	N/A	850	898	946	994	1042	1090	1139	1187	1235	1283	N/A	N/A
			<i>Tight Seat / Removable Upholstery</i>													
	<b>1587-R</b>		118	N/A	208	256	304	352	400	449	497	545	593	641	N/A	N/A
			<i>Replacement Upholstery Covers</i>													
			<b>Overall:</b> 34"w 30"d 18"h				<b>Arm:</b> n/a				<b>COM:</b> 2.25 yds.					
			<b>Seat:</b> 34"w 19.5"d 18"h				<b>Weight:</b> 40 lbs.				<b>COL:</b> n/a					
			<b>COM</b>	<b>COL</b>	<b>1</b>	<b>2</b>	<b>3</b>	<b>4</b>	<b>5</b>	<b>6</b>	<b>7</b>	<b>8</b>	<b>9</b>	<b>10</b>	<b>L1</b>	<b>L2</b>
	<b>1588</b>		975	N/A	1032	1087	1142	1197	1252	1306	1361	1416	1471	1526	N/A	N/A
			<i>Tight Seat / 60" Radius / Removable Upholstery</i>													
	<b>1588-R</b>		130	N/A	233	288	343	398	453	508	563	618	673	728	N/A	N/A
			<i>Replacement Upholstery Covers</i>													
			<b>Overall:</b> 32"w 30"d 18"h				<b>Arm:</b> n/a				<b>COM:</b> 1.75 yds.					
			<b>Seat:</b> 52"w 19.5"d 18"h				<b>Weight:</b> 40 lbs.				<b>COL:</b> n/a					
			<b>COM</b>	<b>COL</b>	<b>1</b>	<b>2</b>	<b>3</b>	<b>4</b>	<b>5</b>	<b>6</b>	<b>7</b>	<b>8</b>	<b>9</b>	<b>10</b>	<b>L1</b>	<b>L2</b>
	<b>1589</b>		925	N/A	957	998	1039	1081	1122	1163	1204	1246	1287	1328	N/A	N/A
			<i>Tight Seat / 30" Radius / Removable Upholstery</i>													
	<b>1589-R</b>		116	N/A	192	233	274	316	357	398	439	481	522	563	N/A	N/A
			<i>Replacement Upholstery Covers</i>													
			<b>Overall:</b> 46.5"w 30"d 18"h				<b>Arm:</b> n/a				<b>COM:</b> 2.5 yds.					
			<b>Seat:</b> 46.5"w 19.5"d 18"h				<b>Weight:</b> 45 lbs.				<b>COL:</b> n/a					
			<b>COM</b>	<b>COL</b>	<b>1</b>	<b>2</b>	<b>3</b>	<b>4</b>	<b>5</b>	<b>6</b>	<b>7</b>	<b>8</b>	<b>9</b>	<b>10</b>	<b>L1</b>	<b>L2</b>
	<b>1590</b>		1296	N/A	1349	1411	1473	1535	1596	1658	1720	1782	1844	1906	N/A	N/A
			<i>Tight Seat / 30" Radius / Removable Upholstery</i>													
	<b>1590-R</b>		149	N/A	265	326	388	450	512	574	636	698	759	821	N/A	N/A
			<i>Replacement Upholstery Covers</i>													
			<b>Overall:</b> 51"w 33"d 18"h				<b>Arm:</b> n/a				<b>COM:</b> 2.75 yds.					
			<b>Seat:</b> 51"w 19.5"d 18"h				<b>Weight:</b> 50 lbs.				<b>COL:</b> n/a					
			<b>COM</b>	<b>COL</b>	<b>1</b>	<b>2</b>	<b>3</b>	<b>4</b>	<b>5</b>	<b>6</b>	<b>7</b>	<b>8</b>	<b>9</b>	<b>10</b>	<b>L1</b>	<b>L2</b>
	<b>1591</b>		1413	N/A	1473	1542	1611	1679	1748	1817	1886	1954	2023	2092	N/A	N/A
			<i>Tight Seat / 6" Radius / Removable Upholstery</i>													
	<b>1591-R</b>		185	N/A	312	381	449	518	587	656	724	793	862	930	N/A	N/A
			<i>Replacement Upholstery Covers</i>													

**DESCRIPTION:**

- Upholstery Frames: Plywood & Hardwood
- Seat: High Density Polyurethane Foam Over Sheet Webbing
- Upholstered Covers: Attached w/ Velcro / Removable For Maintenance
- Antimicrobial Moisture Barrier Fully Encapsulates All Foam Areas
- Ganging Straps Standard
- Brushed Aluminum Round Legs Standard / Removable For Maintenance
- Leather Upholstery Is Not Available
- Lifetime Warranty

**OPTIONS:**

(See Facelift Serpentine Options Pages)

Feather Down & Polyester Pillows Available (See Page 5)

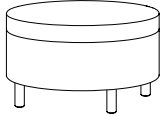
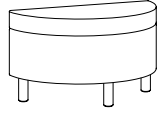
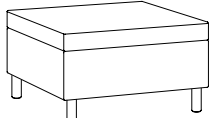
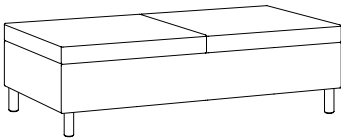
BENCHES		ITEM #:	SPECIFICATIONS   GRADES   LIST PRICES:												
<b>ROUND BENCH / FULLY UPHOLSTERED</b>  			<b>Overall:</b> 30" Diameter 18"h			<b>Arm:</b> n/a			<b>COM:</b> 2.5 yds.						
			<b>Seat:</b> 30"w 30"d 18"h			<b>Weight:</b> 30 lbs.			<b>COL:</b> n/a						
			<b>COM</b>	<b>COL</b>	<b>1</b>	<b>2</b>	<b>3</b>	<b>4</b>	<b>5</b>	<b>6</b>	<b>7</b>	<b>8</b>	<b>9</b>	<b>10</b>	<b>L1</b>
	<b>1592</b>	1084	N/A	1149	1210	1272	1334	1396	1458	1520	1581	1643	1705	N/A	N/A
		<i>Tight Seat / Removable Upholstery</i>													
	<b>1592-R</b>	119	N/A	236	298	359	421	483	545	607	669	731	792	N/A	N/A
		<i>Replacement Upholstery Covers</i>													
<b>HALF-ROUND BENCH / FULLY UPHOLSTERED</b>  			<b>Overall:</b> 30"w 15"d 18"h			<b>Arm:</b> n/a			<b>COM:</b> 1.75 yds.						
			<b>Seat:</b> 30"w 15"d 18"h			<b>Weight:</b> 20 lbs.			<b>COL:</b> n/a						
			<b>COM</b>	<b>COL</b>	<b>1</b>	<b>2</b>	<b>3</b>	<b>4</b>	<b>5</b>	<b>6</b>	<b>7</b>	<b>8</b>	<b>9</b>	<b>10</b>	<b>L1</b>
	<b>1593</b>	863	N/A	899	940	981	1023	1064	1105	1146	1187	1229	1270	N/A	N/A
		<i>Tight Seat / 60" Radius / Removable Upholstery</i>													
	<b>1593-R</b>	116	N/A	192	233	274	315	357	398	439	480	522	563	N/A	N/A
		<i>Replacement Upholstery Covers</i>													
<b>FREESTANDING BENCH / FULLY UPHOLSTERED</b>  			<b>Overall:</b> 30"w 30"d 18"h			<b>Arm:</b> n/a			<b>COM:</b> 1.5 yds.						
			<b>Seat:</b> 30"w 30"d 18"h			<b>Weight:</b> 30 lbs.			<b>COL:</b> n/a						
			<b>COM</b>	<b>COL</b>	<b>1</b>	<b>2</b>	<b>3</b>	<b>4</b>	<b>5</b>	<b>6</b>	<b>7</b>	<b>8</b>	<b>9</b>	<b>10</b>	<b>L1</b>
	<b>1594</b>	1003	N/A	1196	1319	1443	1567	1690	1814	1938	2062	2185	2309	N/A	N/A
		<i>Tight Seat / Removable Upholstery</i>													
	<b>1594-R</b>	118	N/A	180	215	249	283	318	352	386	421	455	489	N/A	N/A
		<i>Replacement Upholstery Covers</i>													
<b>FREESTANDING BENCH / FULLY UPHOLSTERED</b>  			<b>Overall:</b> 60"w 30"d 18"h			<b>Arm:</b> n/a			<b>COM:</b> 5.25 yds.						
			<b>Seat:</b> 60"w 30"d 18"h			<b>Weight:</b> 60 lbs.			<b>COL:</b> n/a						
			<b>COM</b>	<b>COL</b>	<b>1</b>	<b>2</b>	<b>3</b>	<b>4</b>	<b>5</b>	<b>6</b>	<b>7</b>	<b>8</b>	<b>9</b>	<b>10</b>	<b>L1</b>
	<b>1595</b>	1727	1899	1907	2045	2182	2320	2457	2595	2732	2870	3007	3144	N/A	N/A
		<i>Tight Seat / Removable Upholstery</i>													
	<b>1595-R</b>	166	182	431	569	706	844	981	1119	1256	1394	1531	1668	N/A	N/A
		<i>Replacement Upholstery Covers</i>													

**DESCRIPTION:**

- Upholstery Frames: Plywood & Hardwood
- Upholstered Covers: Attached w/ Velcro / Removable For Maintenance
- Antimicrobial Moisture Barrier Fully Encapsulates All Foam Areas
- Ganging Straps Standard
- Brushed Aluminum Round Legs Standard / Removable For Maintenance
- High Pressure Laminate Top - Self Edge
- Leather Upholstery Is Not Available
- Lifetime Warranty

**OPTIONS:**

(See Facelift Serpentine Options Pages)

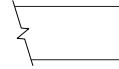

Square Edge Profile Standard

**TABLES**

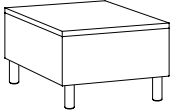
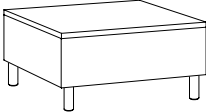
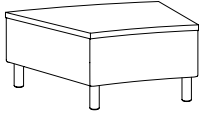
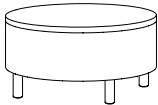
ITEM #:	SPECIFICATIONS   GRADES   LIST PRICES:													
<b>STRAIGHT TABLE / FREESTANDING OR CONNECTING</b>  	<b>Overall:</b> 30"w 22"d 16"h			<b>Arm:</b> n/a					<b>COM:</b> 1.25 yds.					
	<b>Seat:</b> n/a			<b>Weight:</b> 55 lbs.					<b>COL:</b> n/a					
	<b>COM</b>	<b>COL</b>	<b>1</b>	<b>2</b>	<b>3</b>	<b>4</b>	<b>5</b>	<b>6</b>	<b>7</b>	<b>8</b>	<b>9</b>	<b>10</b>	<b>L1</b>	<b>L2</b>
	152230-L	1036	N/A	1054	1082	1110	1138	1166	1194	1222	1250	1278	1306	N/A
	<i>High Pressure Laminate Face</i>													
152230-C	1513	N/A	1522	1550	1578	1606	1634	1662	1691	1719	1747	1775	N/A	N/A
	<i>Solid Surface Face (Glacier White)</i>													
152230-R	100	N/A	149	177	204	232	259	287	314	342	369	397	N/A	N/A
	<i>Replacement Upholstery Covers</i>													
<b>STRAIGHT TABLE / FREESTANDING OR CONNECTING</b>  	<b>Overall:</b> 30"w 30"d 16"h			<b>Arm:</b> n/a					<b>COM:</b> 1.25 yds.					
	<b>Seat:</b> n/a			<b>Weight:</b> 60 lbs.					<b>COL:</b> n/a					
	<b>COM</b>	<b>COL</b>	<b>1</b>	<b>2</b>	<b>3</b>	<b>4</b>	<b>5</b>	<b>6</b>	<b>7</b>	<b>8</b>	<b>9</b>	<b>10</b>	<b>L1</b>	<b>L2</b>
	153030-L	1127	N/A	1141	1169	1197	1225	1253	1281	1309	1337	1365	1393	N/A
	<i>High Pressure Laminate Face</i>													
153030-C	1918	N/A	1920	1949	1977	2005	2033	2062	2090	2118	2146	2175	N/A	N/A
	<i>Solid Surface Face (Glacier White)</i>													
153030-R	110	N/A	159	187	214	242	269	297	324	352	379	407	N/A	N/A
	<i>Replacement Upholstery Covers</i>													
<b>22.5° TABLE WEDGE / FREESTANDING OR CONNECTING</b>  	<b>Overall:</b> 34"w 30"d 16"h			<b>Arm:</b> n/a					<b>COM:</b> 1.25 yds.					
	<b>Seat:</b> n/a			<b>Weight:</b> 65 lbs.					<b>COL:</b> n/a					
	<b>COM</b>	<b>COL</b>	<b>1</b>	<b>2</b>	<b>3</b>	<b>4</b>	<b>5</b>	<b>6</b>	<b>7</b>	<b>8</b>	<b>9</b>	<b>10</b>	<b>L1</b>	<b>L2</b>
	1522DG60-L	1408	N/A	1412	1440	1468	1496	1524	1552	1580	1608	1636	1664	N/A
	<i>High Pressure Laminate Face / 60" Radius</i>													
1522DG60-C	2239	N/A	2246	2274	2303	2331	2359	2388	2416	2445	2473	2502	N/A	N/A
	<i>Solid Surface Face (Glacier White) / 60" Radius</i>													
1522DG60-R	117	N/A	166	193	221	248	276	303	330	358	385	413	N/A	N/A
	<i>Replacement Upholstery Covers</i>													
<b>ROUND COFFEE TABLE / FREESTANDING</b>  	<b>Overall:</b> 30" Diameter 16"h			<b>Arm:</b> n/a					<b>COM:</b> 1.25 yds.					
	<b>Seat:</b> 18"h			<b>Weight:</b> 55 lbs.					<b>COL:</b> n/a					
	<b>COM</b>	<b>COL</b>	<b>1</b>	<b>2</b>	<b>3</b>	<b>4</b>	<b>5</b>	<b>6</b>	<b>7</b>	<b>8</b>	<b>9</b>	<b>10</b>	<b>L1</b>	<b>L2</b>
	1530D16-L	1230	N/A	1241	1269	1297	1325	1353	1381	1409	1437	1465	1493	N/A
	<i>High Pressure Laminate Face / Round</i>													
1530D16-C	2143	N/A	2148	2176	2204	2233	2261	2290	2318	2346	2375	2403	N/A	N/A
	<i>Solid Surface Face (Glacier White) / Round</i>													
1530D16-R	117	N/A	166	193	221	248	276	303	331	358	386	413	N/A	N/A
	<i>Replacement Upholstery Covers</i>													

**DESCRIPTION:**

- Upholstery Frames: Plywood & Hardwood
- Upholstered Covers: Attached w/ Velcro / Removable For Maintenance
- Antimicrobial Moisture Barrier Fully Encapsulates All Foam Areas
- Ganging Straps Standard
- Brushed Aluminum Round Legs Standard / Removable For Maintenance
- High Pressure Laminate Top - Self Edge
- Leather Upholstery Is Not Available
- Lifetime Warranty

**OPTIONS:**

(See Facelift Serpentine Options Pages)

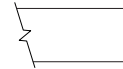

Square Edge Profile Standard

**TABLES**

ITEM #:		SPECIFICATIONS   GRADES   LIST PRICES:													
<p><b>STRAIGHT TABLE / FREESTANDING OR CONNECTING</b></p>		<b>Overall:</b> 32"w 30"d 16"h			<b>Arm:</b> n/a			<b>COM:</b> 1.25 yds.							
		<b>Seat:</b> n/a			<b>Weight:</b> 60 lbs.			<b>COL:</b> n/a							
		<b>COM</b>	<b>COL</b>	<b>1</b>	<b>2</b>	<b>3</b>	<b>4</b>	<b>5</b>	<b>6</b>	<b>7</b>	<b>8</b>	<b>9</b>	<b>10</b>	<b>L1</b>	<b>L2</b>
	<b>1530DG30-L</b>	1256	N/A	1265	1293	1321	1349	1377	1405	1433	1461	1489	1517	N/A	N/A
		<i>High Pressure Laminate Face / 30" Radius</i>													
	<b>1530DG30-C</b>	2221	N/A	2224	2252	2280	2309	2337	2366	2394	2422	2451	2479	N/A	N/A
		<i>Solid Surface Face (Glacier White) / 30" Radius</i>													
	<b>1530DG30-R</b>	107	N/A	156	184	211	239	266	294	321	348	376	403	N/A	N/A
		<i>Replacement Upholstery Covers</i>													
<p><b>STRAIGHT TABLE / FREESTANDING OR CONNECTING</b></p>		<b>Overall:</b> 46.5"w 30"d 16"h			<b>Arm:</b> n/a			<b>COM:</b> 1.25 yds.							
		<b>Seat:</b> n/a			<b>Weight:</b> 95 lbs.			<b>COL:</b> n/a							
		<b>COM</b>	<b>COL</b>	<b>1</b>	<b>2</b>	<b>3</b>	<b>4</b>	<b>5</b>	<b>6</b>	<b>7</b>	<b>8</b>	<b>9</b>	<b>10</b>	<b>L1</b>	<b>L2</b>
	<b>1545DG30-L</b>	1796	N/A	1799	1827	1855	1884	1912	1940	1968	1996	2025	2053	N/A	N/A
		<i>High Pressure Laminate Face / 30" Radius</i>													
	<b>1545DG30-C</b>	3576	N/A	3579	3607	3636	3665	3693	3722	3751	3779	3808	3836	N/A	N/A
		<i>Solid Surface Face (Glacier White) / 30" Radius</i>													
	<b>1545DG30-R</b>	155	N/A	201	229	256	284	311	339	366	394	421	449	N/A	N/A
		<i>Replacement Upholstery Covers</i>													
<p><b>22.5° TABLE WEDGE / FREESTANDING OR CONNECTING</b></p>		<b>Overall:</b> 51"w 32"d 16"h			<b>Arm:</b> n/a			<b>COM:</b> 2 yds.							
		<b>Seat:</b> n/a			<b>Weight:</b> 110 lbs.			<b>COL:</b> n/a							
		<b>COM</b>	<b>COL</b>	<b>1</b>	<b>2</b>	<b>3</b>	<b>4</b>	<b>5</b>	<b>6</b>	<b>7</b>	<b>8</b>	<b>9</b>	<b>10</b>	<b>L1</b>	<b>L2</b>
	<b>1590DG6-L</b>	1789	N/A	1797	1846	1894	1943	1991	2039	2088	2136	2184	2233	N/A	N/A
		<i>High Pressure Laminate Face / 6" Radius</i>													
	<b>1590DG6-C</b>	3190	N/A	3194	3243	3293	3342	3391	3441	3490	3539	3589	3638	N/A	N/A
		<i>Solid Surface Face (Glacier White) / 6" Radius</i>													
	<b>1590DG6-R</b>	173	N/A	260	308	356	405	453	501	549	597	645	693	N/A	N/A
		<i>Replacement Upholstery Covers</i>													
<p><b>HALF ROUND COFFEE TABLE / FREESTANDING</b></p>		<b>Overall:</b> 30"w 15"d 16"h			<b>Arm:</b> n/a			<b>COM:</b> 1 yd.							
		<b>Seat:</b> n/a			<b>Weight:</b> 40 lbs.			<b>COL:</b> n/a							
		<b>COM</b>	<b>COL</b>	<b>1</b>	<b>2</b>	<b>3</b>	<b>4</b>	<b>5</b>	<b>6</b>	<b>7</b>	<b>8</b>	<b>9</b>	<b>10</b>	<b>L1</b>	<b>L2</b>
	<b>15180DG16-L</b>	1091	N/A	1092	1113	1134	1155	1176	1197	1218	1239	1260	1281	N/A	N/A
		<i>High Pressure Laminate Face</i>													
	<b>15180DG16-C</b>	1480	N/A	1481	1502	1524	1545	1566	1587	1608	1630	1651	1672	N/A	N/A
		<i>Solid Surface Face (Glacier White)</i>													
	<b>15180DG16-R</b>	106	N/A	182	223	265	306	347	388	430	471	512	553	N/A	N/A
		<i>Replacement Upholstery Covers</i>													





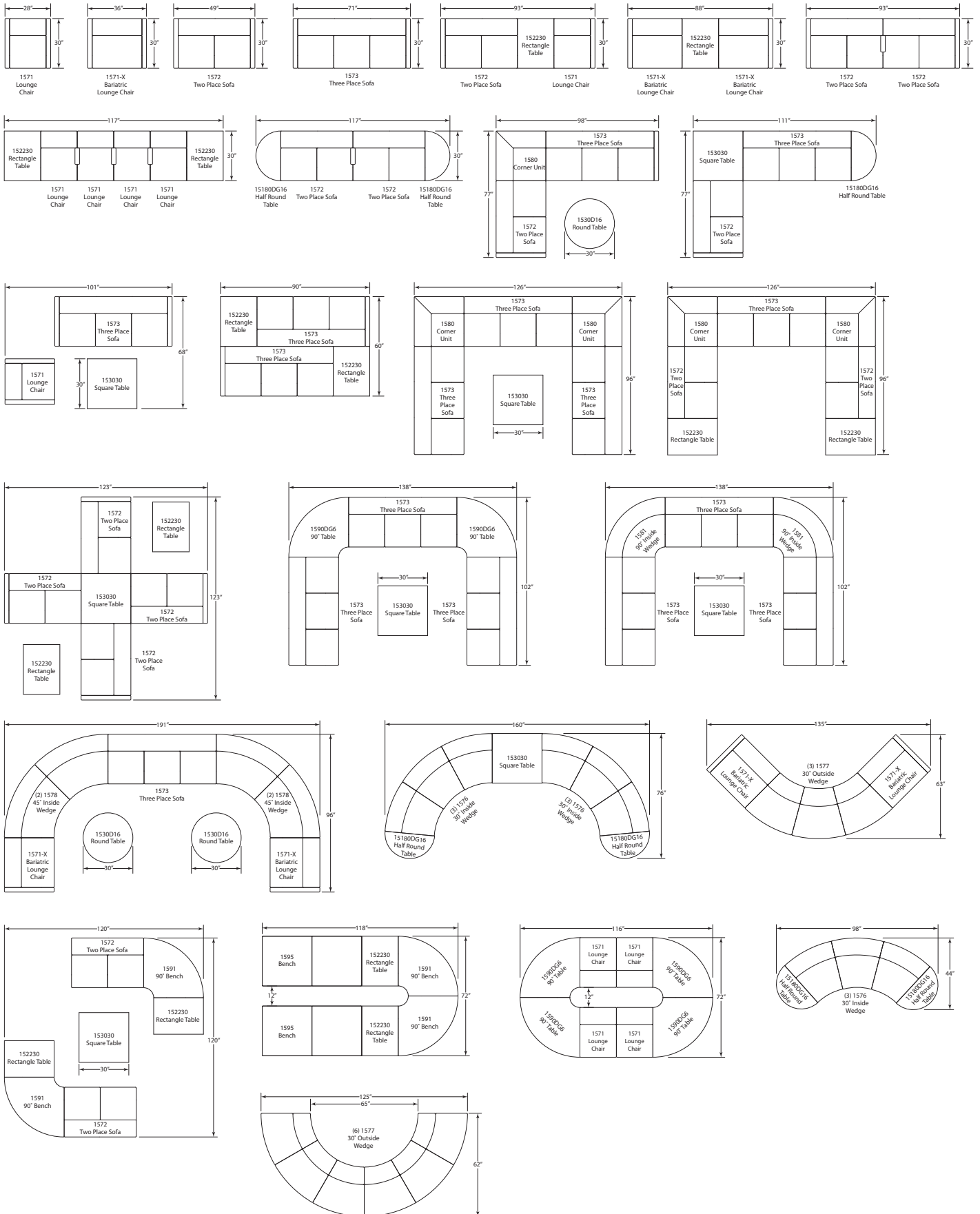

## Configuration Examples

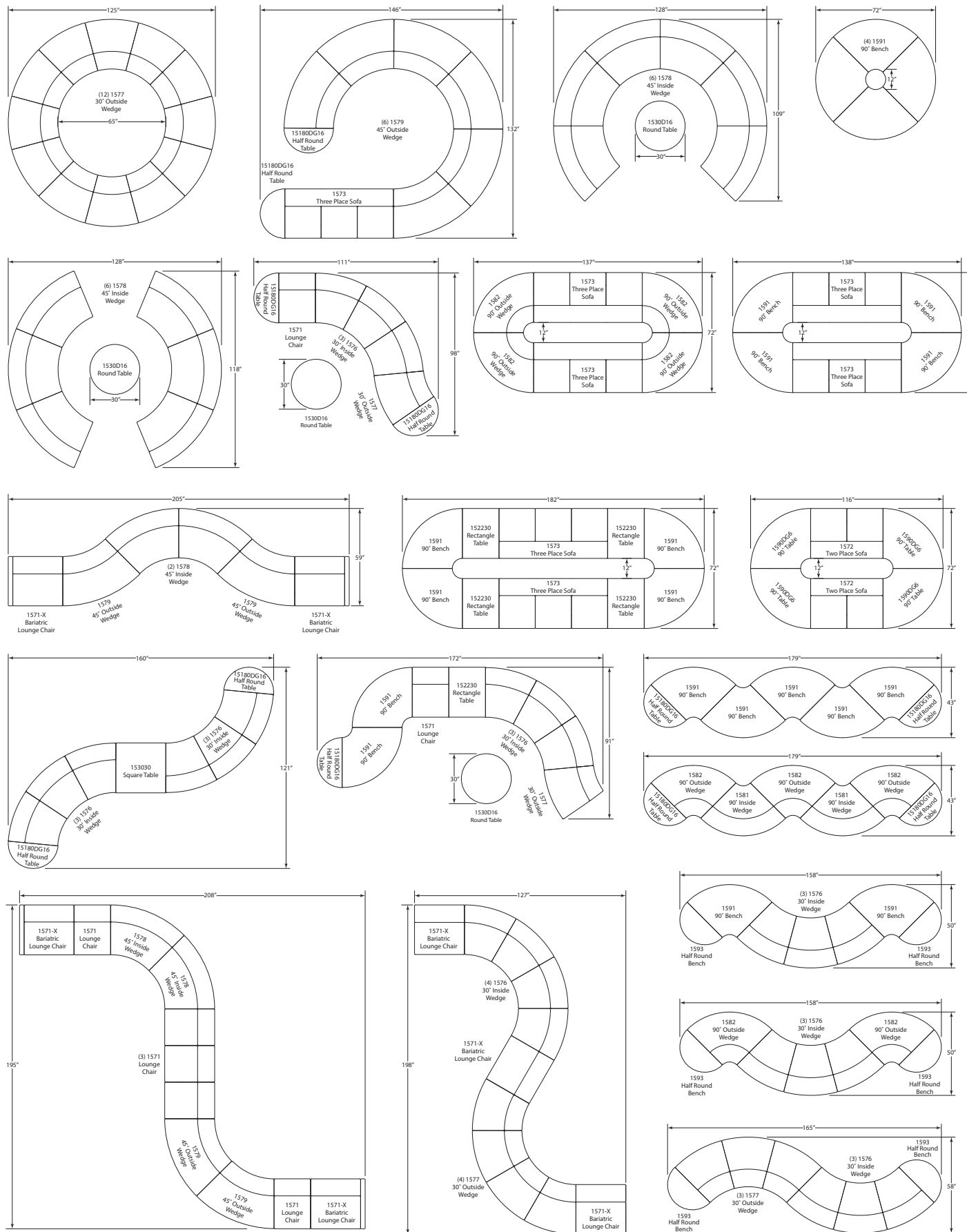

## Configuration Examples



ARM CAPS	OPTION #:	SPECIFICATIONS   LIST PRICES   AVAILABILITY:													
<p>FULLY UPHOLSTERED ARM</p> 		<p><b>Overall:</b> 2.5"w 30.5"d 18"h <b>COM:</b> 1.5 yds.</p>													
		COM	COL	1	2	3	4	5	6	7	8	9	10	L1	L2
	A1	215	N/A	271	307	340	377	411	447	483	518	554	589	N/A	N/A
	A1-R	67	N/A	135	171	206	243	279	315	350	388	422	460	N/A	N/A
		<p><i>Fully Upholstered Arm (Specify Fabric)</i></p> <p><i>Replacement Upholstery Covers</i></p> <p><b>Available: Facelift Serpentine Lounge Units</b></p>													
<p>UPHOLSTERED ARM / EXPOSED WOOD ARM CAP</p> 		<p><b>Overall:</b> 2.5"w 30.5"d 18.5"h <b>COM:</b> 1.5 yds.</p>													
		COM	COL	1	2	3	4	5	6	7	8	9	10	L1	L2
	A1W	292	N/A	348	383	418	455	489	524	559	595	631	666	N/A	N/A
	A1W-R	67	N/A	135	171	206	243	279	315	350	388	422	460	N/A	N/A
		<p><i>Upholstered Arm / Exposed Wood Arm Cap (Specify Fabric &amp; Finish)</i></p> <p><i>Replacement Upholstery Covers</i></p> <p><b>Available: Facelift Serpentine Lounge Units</b></p>													
<p>UPHOLSTERED ARM / CONTRASTING FABRIC / VINYL ARM CAP</p> 		<p><b>Overall:</b> 2.5"w 30.5"d 18"h <b>COM:</b> 1.5 yds.</p>													
		COM	COL	1	2	3	4	5	6	7	8	9	10	L1	L2
	A1U	275	N/A	332	366	402	437	471	509	542	580	615	650	N/A	N/A
	A1U-R	67	N/A	135	171	206	243	279	315	350	388	422	460	N/A	N/A
		<p><i>Upholstered Arm / Contrasting Fabric / Vinyl Arm Cap (Specify Fabric &amp; Vinyl)</i></p> <p><i>Replacement Upholstery Covers</i></p> <p><b>Available: Facelift Serpentine Lounge Units</b></p>													
<p>INTERIM UPHOLSTERED ARM / EXPOSED WOOD ARM CAP</p> 		<p><b>Overall:</b> 3"w 13.5"d 6"h <b>COM:</b> .75 yds.</p>													
		COM	COL	1	2	3	4	5	6	7	8	9	10	L1	L2
	A2W	289	N/A	300	314	327	341	356	369	384	398	413	427	N/A	N/A
	A2W-R	54	N/A	79	94	108	122	137	151	166	180	194	210	N/A	N/A
		<p><i>Interim Upholstered Arm / Exposed Wood Arm Cap (Specify Fabric &amp; Finish)</i></p> <p><i>Replacement Upholstery Covers</i></p> <p><b>Available: Facelift Serpentine Lounge &amp; Wedge Units</b></p>													

ARM CAPS / TABLET ARMS	OPTION #:	SPECIFICATIONS   LIST PRICES   AVAILABILITY:																																																																								
<p data-bbox="87 178 430 231">INTERIM UPHOLSTERED ARM / CONTRASTING FABRIC / VINYL ARM CAP</p> 	<p data-bbox="570 178 779 231"><b>Overall:</b> 3"w 13.5"d 6"h <b>COM:</b> .75 yds.</p>																																																																									
	<table border="1"> <thead> <tr> <th>COM</th> <th>COL</th> <th>1</th> <th>2</th> <th>3</th> <th>4</th> <th>5</th> <th>6</th> <th>7</th> <th>8</th> <th>9</th> <th>10</th> <th>L1</th> <th>L2</th> </tr> </thead> </table>	COM	COL	1	2	3	4	5	6	7	8	9	10	L1	L2																																																											
	COM	COL	1	2	3	4	5	6	7	8	9	10	L1	L2																																																												
<table border="1"> <tbody> <tr> <td data-bbox="570 304 625 346"><b>A2U</b></td> <td data-bbox="625 304 673 346">246</td> <td data-bbox="673 304 722 346">N/A</td> <td data-bbox="722 304 771 346">256</td> <td data-bbox="771 304 820 346">271</td> <td data-bbox="820 304 868 346">285</td> <td data-bbox="868 304 917 346">299</td> <td data-bbox="917 304 966 346">312</td> <td data-bbox="966 304 1015 346">327</td> <td data-bbox="1015 304 1063 346">340</td> <td data-bbox="1063 304 1112 346">355</td> <td data-bbox="1112 304 1161 346">368</td> <td data-bbox="1161 304 1209 346">373</td> <td data-bbox="1209 304 1258 346">N/A</td> <td data-bbox="1258 304 1307 346">N/A</td> </tr> <tr> <td colspan="15" data-bbox="570 346 1537 378"><i>Interim Upholstered Arm / Contrasting Fabric / Vinyl Arm Cap (Specify Fabric &amp; Vinyl)</i></td> </tr> <tr> <td data-bbox="570 378 625 420"><b>A2U-R</b></td> <td data-bbox="625 378 673 420">54</td> <td data-bbox="673 378 722 420">N/A</td> <td data-bbox="722 378 771 420">79</td> <td data-bbox="771 378 820 420">94</td> <td data-bbox="820 378 868 420">108</td> <td data-bbox="868 378 917 420">122</td> <td data-bbox="917 378 966 420">137</td> <td data-bbox="966 378 1015 420">151</td> <td data-bbox="1015 378 1063 420">166</td> <td data-bbox="1063 378 1112 420">177</td> <td data-bbox="1112 378 1161 420">194</td> <td data-bbox="1161 378 1209 420">210</td> <td data-bbox="1209 378 1258 420">N/A</td> <td data-bbox="1258 378 1307 420">N/A</td> </tr> <tr> <td colspan="15" data-bbox="570 420 1537 451"><i>Replacement Upholstery Covers</i></td> </tr> </tbody> </table> <p data-bbox="570 483 974 514"><b>Available:</b> Facelift Serpentine Lounge &amp; Wedge Units</p>	<b>A2U</b>	246	N/A	256	271	285	299	312	327	340	355	368	373	N/A	N/A	<i>Interim Upholstered Arm / Contrasting Fabric / Vinyl Arm Cap (Specify Fabric &amp; Vinyl)</i>															<b>A2U-R</b>	54	N/A	79	94	108	122	137	151	166	177	194	210	N/A	N/A	<i>Replacement Upholstery Covers</i>																												
<b>A2U</b>	246	N/A	256	271	285	299	312	327	340	355	368	373	N/A	N/A																																																												
<i>Interim Upholstered Arm / Contrasting Fabric / Vinyl Arm Cap (Specify Fabric &amp; Vinyl)</i>																																																																										
<b>A2U-R</b>	54	N/A	79	94	108	122	137	151	166	177	194	210	N/A	N/A																																																												
<i>Replacement Upholstery Covers</i>																																																																										
<p data-bbox="87 640 422 672"><b>UPHOLSTERED / URETHANE TASK ARM</b></p> 	<p data-bbox="570 640 795 693"><b>Overall:</b> 3.25"w 9.5"d 18"h <b>COM:</b> .75 yds.</p>																																																																									
	<table border="1"> <thead> <tr> <th>COM</th> <th>COL</th> <th>1</th> <th>2</th> <th>3</th> <th>4</th> <th>5</th> <th>6</th> <th>7</th> <th>8</th> <th>9</th> <th>10</th> <th>L1</th> <th>L2</th> </tr> </thead> </table>	COM	COL	1	2	3	4	5	6	7	8	9	10	L1	L2																																																											
	COM	COL	1	2	3	4	5	6	7	8	9	10	L1	L2																																																												
	<table border="1"> <tbody> <tr> <td data-bbox="570 766 625 808"><b>A3</b></td> <td data-bbox="625 766 673 808">226</td> <td data-bbox="673 766 722 808">N/A</td> <td data-bbox="722 766 771 808">241</td> <td data-bbox="771 766 820 808">256</td> <td data-bbox="820 766 868 808">270</td> <td data-bbox="868 766 917 808">284</td> <td data-bbox="917 766 966 808">298</td> <td data-bbox="966 766 1015 808">313</td> <td data-bbox="1015 766 1063 808">328</td> <td data-bbox="1063 766 1112 808">342</td> <td data-bbox="1112 766 1161 808">356</td> <td data-bbox="1161 766 1209 808">370</td> <td data-bbox="1209 766 1258 808">N/A</td> <td data-bbox="1258 766 1307 808">N/A</td> </tr> <tr> <td colspan="15" data-bbox="570 808 1537 840"><i>Outside Upholstered Task Arm (Specify Fabric Or Vinyl)</i></td> </tr> </tbody> </table>	<b>A3</b>	226	N/A	241	256	270	284	298	313	328	342	356	370	N/A	N/A	<i>Outside Upholstered Task Arm (Specify Fabric Or Vinyl)</i>																																																									
	<b>A3</b>	226	N/A	241	256	270	284	298	313	328	342	356	370	N/A	N/A																																																											
<i>Outside Upholstered Task Arm (Specify Fabric Or Vinyl)</i>																																																																										
<table border="1"> <tbody> <tr> <td data-bbox="570 840 625 882"><b>A4</b></td> <td data-bbox="625 840 673 882">178</td> <td data-bbox="673 840 722 882">N/A</td> <td data-bbox="722 840 771 882">193</td> <td data-bbox="771 840 820 882">208</td> <td data-bbox="820 840 868 882">224</td> <td data-bbox="868 840 917 882">239</td> <td data-bbox="917 840 966 882">253</td> <td data-bbox="966 840 1015 882">268</td> <td data-bbox="1015 840 1063 882">282</td> <td data-bbox="1063 840 1112 882">296</td> <td data-bbox="1112 840 1161 882">310</td> <td data-bbox="1161 840 1209 882">324</td> <td data-bbox="1209 840 1258 882">N/A</td> <td data-bbox="1258 840 1307 882">N/A</td> </tr> <tr> <td colspan="15" data-bbox="570 882 1537 913"><i>Inside Upholstered Task Arm (Specify Fabric Or Vinyl)</i></td> </tr> </tbody> </table>	<b>A4</b>	178	N/A	193	208	224	239	253	268	282	296	310	324	N/A	N/A	<i>Inside Upholstered Task Arm (Specify Fabric Or Vinyl)</i>																																																										
<b>A4</b>	178	N/A	193	208	224	239	253	268	282	296	310	324	N/A	N/A																																																												
<i>Inside Upholstered Task Arm (Specify Fabric Or Vinyl)</i>																																																																										
<p data-bbox="570 913 625 945"><b>A5</b></p> <p data-bbox="570 945 812 976">\$210 <i>Outside Urethane Task Arm (Black)</i></p>																																																																										
<p data-bbox="570 976 625 1008"><b>A6</b></p> <p data-bbox="570 1008 812 1039">\$157 <i>Inside Urethane Task Arm (Black)</i></p>																																																																										
<b>Available:</b> Facelift Serpentine Lounge & Wedge Units																																																																										
<p data-bbox="87 1102 324 1134"><b>POLE SWIVEL TABLET ARM</b></p> 	<p data-bbox="570 1102 828 1134"><b>Overall:</b> 14.25" Diameter 22.5"h</p>																																																																									
	<p data-bbox="570 1186 893 1228"><b>PT</b> \$448 (Pole &amp; Black Laminate Tablet)</p>																																																																									
	<p data-bbox="570 1228 828 1270"><b>ST-1</b> \$513 (Pole &amp; Veneer Tablet)</p>																																																																									
	<p data-bbox="570 1270 925 1312"><b>ST-2</b> \$667 (Pole &amp; White Solid Surface Tablet)</p>																																																																									
<b>Available:</b> Facelift Serpentine Lounge & Wedge End Units																																																																										

LEGS / CASTERS / PUSH BAR	OPTION #:	SPECIFICATIONS   LIST PRICES   AVAILABILITY:
<p>BRUSHED ALUMINUM ROUND LEGS</p> 	<p>ARL</p>	<p><b>Overall:</b> 2" Diameter 5"h</p> <hr/> <p>Standard Leg On All Serpentine Units - No Charge (Brushed Aluminum Finish)</p> <p><b>Available:</b> Facelift Serpentine Collection</p>
<p>WOOD ROUND LEGS</p> 	<p>WR</p>	<p><b>Overall:</b> 1.75" Diameter 5"h</p> <hr/> <p>Deduct \$80 (Set Of 4) Wood Round Leg (Specify Finish)</p> <p><b>Available:</b> Facelift Serpentine Collection</p>
<p>CASTERS</p> 	<p>CS  CL</p>	<p><b>Overall:</b> 3"w 4"d 4"h</p> <hr/> <p>\$108 (Set Of 2) Dual Wheel / Non-Locking Casters (Black Finish)</p> <p>\$122 (Set Of 2) Dual Wheel / Locking Casters (Black Finish)</p> <p><b>Available:</b> Facelift Serpentine Lounge Units</p>
<p>PUSH BAR</p> 	<p>PB</p>	<p><b>Overall:</b> 18.5"w 3.5"d 1"h</p> <hr/> <p>\$235 (Black Finish)</p> <p><b>Available:</b> Facelift Serpentine Lounge Units</p>

POWER / COVERS	OPTION #:	SPECIFICATIONS   LIST PRICES   AVAILABILITY:
<p data-bbox="87 178 446 210">VERTICAL / HORIZONTAL MOUNT MODULE</p> 	<p data-bbox="570 262 1055 304"><b>PM1</b></p> <p data-bbox="570 262 1534 325">\$836 (1-Power / 1-USB 2 Port Simplex Charger Standard) Vertical / Horizontal Mount Power Module. Price Varies By Socket. Contact Customer Service For Quote. (Additional Colors Available)</p> <p data-bbox="570 367 876 399"><i>Available: Facelift Serpentine Collection</i></p>	
<p data-bbox="87 640 292 672">CONTRASTING COVERS</p> 	<p data-bbox="570 724 617 756"><b>CC</b></p> <p data-bbox="570 724 1534 829">\$129 <i>NOTE: If Two Or More Upholsteries Or Leathers Are Used On Any Piece Of Furniture, Then A Contrast Charge Will Apply Per Order. When Using Trinity Upholstery, The Higher Priced Upholstery Grade Will Be Used In Pricing, Unless It's Trinity Leather With Fabric Contrast Welt, Or COM With Trinity Contrast Welt, Then Contact Customer Service For Pricing.</i></p> <p data-bbox="570 871 876 903"><i>Available: Facelift Serpentine Collection</i></p>	

# Facelift Tuxedo

---

LOUNGE SLEEPER

Effective: August 1, 2022

T R I N I T Y

**Date:**

**Page:**

**Modification:**

**Description:**

---



**DESCRIPTION:**

- Upholstery Frames: Plywood & Hardwood
- Seat: High Density Polyurethane Foam Over Sheet Webbing
- Back: High Density Poly-Dacron Foam Over Hardwood Plywood
- Upholstered Covers: Attached w/ Velcro / Removable For Maintenance (Seat Only)
- Antimicrobial Moisture Barrier Fully Encapsulates Seat Area
- Removable Bolster Pillows (2)
- Double Needle Stitching Standard
- Wood Legs Front / Casters Rear
- Leather Upholstery Not Available / Storage Drawer Not Available
- Lifetime Warranty

**OPTIONS:**

- ASL Aluminum Square Legs (Set Of 4).....\$348
  - CSC-1 Solid Surface Surface Caps (Set Of 4).....\$699
  - FSC-1 Foil Wrap Surface Caps (Set Of 4).....CALL
  - PT Pole & Black Laminate Tablet.....\$440
  - ST-1 Pole & Veneer Tablet.....\$503
  - ST-2 Pole & White Solid Surface Tablet.....\$654
  - PM1 Power/Data Module (1-Power / 1-USB 2 Port Simplex Charger).....\$836
  - WB Wallsaver Bumpers.....n/c
- Feather Down & Polyester Pillows Available (See Page 5)

**LOUNGE SLEEPER**

ITEM #:

SPECIFICATIONS | GRADES | LIST PRICES:

**SLEEPER / FULLY UPHOLSTERED**

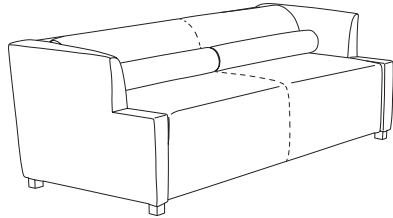

**Overall:** 87"w 36"d 28"h      **Arm:** 28"h      **COM:** 10.25 yds.  
**Seat:** 76"w 30"d 18"h      **Weight:** 185 lbs.      **COL:** n/a

COM	COL	1	2	3	4	5	6	7	8	9	10	L1	L2
3796	N/A	4193	4496	4798	5101	5403	5705	6008	6310	6612	6915	N/A	N/A

*Tight Seat & Back / Removable Upholstery (Seat Only)*

**1603**

**1603-R**

Call For Pricing  
*Replacement Seat Upholstery*

Our Tuxedo Lounge reveals a fully suspended adult sleep surface by simply raising the back cushion; a transformation requiring no additional space in the patient room.

LEGS / SURFACE CAPS / POWER / COVERS	OPTION #:	SPECIFICATIONS   LIST PRICES   AVAILABILITY:
<p><b>ALUMINUM LEGS</b></p> 	ASL	<p><b>Overall:</b> 2.25"w 2.25"d 2.25"h</p> <hr/> <p>\$348 (Set Of 4) <i>(Brushed Finish)</i></p> <p><b>Available:</b> <i>Facelift Tuxedo Collection</i></p>
<p><b>SURFACE CAPS</b></p> 	CSC-1	<p><b>Overall:</b> 5.25"w 1.25"d 4.25"h</p> <hr/> <p>\$699 (Set Of 4) <i>Solid Surface Surface Caps (White)</i></p>
	FSC-1	<p>CALL (Set Of 4) <i>Foil Wrap Surface Caps (Black Standard / Additional Colors Available)</i></p> <p><b>Available:</b> <i>Facelift Tuxedo Collection</i></p>
<p><b>POLE SWIVEL TABLET ARM</b></p> 	PT	<p><b>Overall:</b> 14.25" Diameter 22.5"h</p> <hr/> <p>\$440 (Pole &amp; Black Laminate Tablet)</p>
	ST-1	<p>\$503 (Pole &amp; Veneer Tablet)</p>
	ST-2	<p>\$654 (Pole &amp; White Solid Surface Tablet)</p> <p><b>Available:</b> <i>Facelift Serpentine Lounge &amp; Wedge End Units</i></p>
<p><b>POWER / DATA MODULE</b></p> 	PM1	<p><b>Overall:</b> 5.25"w 1.25"d 4.25"h</p> <hr/> <p>\$836 (1-Power / 1-USB 2 Port Simplex Charger Standard) <i>Vertical / Horizontal Mount Power Module. Price Varies By Socket. Contact Customer Service For Quote. (Additional Colors Available)</i></p> <p><b>Available:</b> <i>Facelift Tuxedo Collection</i></p>
<p><b>CONTRASTING COVERS</b></p> 	CC	<p><b>Overall:</b> N/A</p> <hr/> <p>\$129</p> <p><i>NOTE: If Two Or More Upholsteries Or Leathers Are Used On Any Piece Of Furniture, Then A Contrast Charge Will Apply Per Order. When Using Trinity Upholstery, The Higher Priced Upholstery Grade Will Be Used In Pricing, Unless It's Trinity Leather With Fabric Contrast Welt, Or COM With Trinity Contrast Welt, Then Contact Customer Service For Pricing.</i></p> <p><b>Available:</b> <i>Facelift Tuxedo Collection</i></p>

# Facelift Prime

---

LOUNGE

Effective: August 1, 2022

T R I N I T Y

**Date:**

**Page:**

**Modification:**

**Description:**

---

**DESCRIPTION:**

- Upholstery Frames: Steel, Plywood & Hardwood
- Seat: High Density Polyurethane Foam Over Strap Webbing
- Back: High Density Polyurethane Foam Over Sinuous Wire Springs
- Upholstered Covers: Attached w/ Velcro / Removable For Maintenance
- Exposed Wood Legs: Solid Hardwood / Removable For Maintenance
- Antimicrobial Moisture Barrier Fully Encapsulates All Foam Areas
- Leather Upholstery Not Available
- Lifetime Warranty

**OPTIONS:**

- WAC-1 Solid Wood Arm Caps (Set Of 2) .....\$154
- UAC-1 Black Urethane Arm Caps (Set Of 2).....\$205
- ARL Brushed Aluminum Round Legs (Set Of 4).....\$353
- PM1 Power/Data Module (1-Power / 1-USB 2 Port Simplex Charger) .....\$836

Feather Down & Polyester Pillows Available (See Page 5)  
 Specify Exposed Wood Finish (See Page 6)  
 Tablet Arm / Cup Holder Options (See Facelift Prime Lounge Options Pages)  
 Biscuit Tufting Available Upon Request (Contact Customer Service For Pricing)

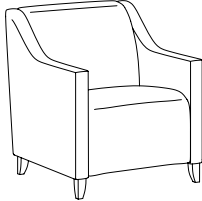
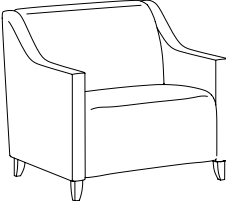
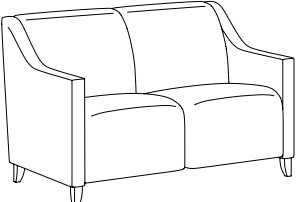
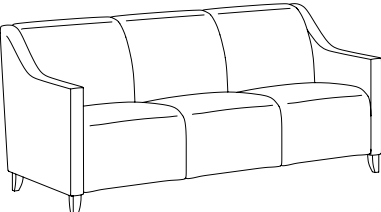
LOUNGE		ITEM #:	SPECIFICATIONS   GRADES   LIST PRICES:																		
	<p><b>LOUNGE CHAIR / FULLY UPHOLSTERED</b></p>	<p><b>Overall:</b> 28"w 32.5"d 34"h  <b>Seat:</b> 23"w 20.5"d 18"h</p>	<p><b>Arm:</b> 25"h  <b>Weight:</b> 90 lbs.</p>	<p><b>COM:</b> 5 yds.  <b>COL:</b> n/a</p>	<b>COM</b>	<b>COL</b>	<b>1</b>	<b>2</b>	<b>3</b>	<b>4</b>	<b>5</b>	<b>6</b>	<b>7</b>	<b>8</b>	<b>9</b>	<b>10</b>	<b>L1</b>	<b>L2</b>			
					1701	1490	N/A	1670	1800	1931	2061	2192	2322	2453	2584	2714	2845	N/A	N/A	Tight Seat & Back / Removable Upholstery	
					1701-R	244	N/A	492	622	753	883	1014	1144	1275	1406	1536	1667	N/A	N/A	Replacement Upholstery Covers	
	<p><b>BARIATRIC LOUNGE CHAIR / FULLY UPHOLSTERED</b></p>	<p><b>Overall:</b> 34"w 32.5"d 34"h  <b>Seat:</b> 29"w 20.5"d 18"h</p>	<p><b>Arm:</b> 25"h  <b>Weight:</b> 100 lbs.</p>	<p><b>COM:</b> 5.5 yds.  <b>COL:</b> n/a</p>	<b>COM</b>	<b>COL</b>	<b>1</b>	<b>2</b>	<b>3</b>	<b>4</b>	<b>5</b>	<b>6</b>	<b>7</b>	<b>8</b>	<b>9</b>	<b>10</b>	<b>L1</b>	<b>L2</b>			
					1701-X	1862	N/A	2049	2193	2338	2482	2626	2771	2915	3059	3203	3348	N/A	N/A	Tight Seat & Back / Removable Upholstery / 1000 lb. Weight Capacity	
					1701-XR	244	N/A	519	663	808	952	1096	1241	1385	1529	1674	1818	N/A	N/A	Replacement Upholstery Covers	
	<p><b>TWO PLACE SOFA / FULLY UPHOLSTERED</b></p>	<p><b>Overall:</b> 51"w 32.5"d 34"h  <b>Seat:</b> 46"w 20.5"d 18"h</p>	<p><b>Arm:</b> 25"h  <b>Weight:</b> 155 lbs.</p>	<p><b>COM:</b> 7.25 yds.  <b>COL:</b> n/a</p>	<b>COM</b>	<b>COL</b>	<b>1</b>	<b>2</b>	<b>3</b>	<b>4</b>	<b>5</b>	<b>6</b>	<b>7</b>	<b>8</b>	<b>9</b>	<b>10</b>	<b>L1</b>	<b>L2</b>			
					1702	2286	N/A	2546	2739	2931	3124	3316	3508	3701	3893	4086	4278	N/A	N/A	Tight Seat & Back / Removable Upholstery	
					1702-R	358	N/A	724	916	1109	1301	1493	1686	1878	2071	2263	2456	N/A	N/A	Replacement Upholstery Covers	
	<p><b>THREE PLACE SOFA / FULLY UPHOLSTERED</b></p>	<p><b>Overall:</b> 74"w 32.5"d 34"h  <b>Seat:</b> 69"w 20.5"d 18"h</p>	<p><b>Arm:</b> 25"h  <b>Weight:</b> 215 lbs.</p>	<p><b>COM:</b> 9.75 yds.  <b>COL:</b> n/a</p>	<b>COM</b>	<b>COL</b>	<b>1</b>	<b>2</b>	<b>3</b>	<b>4</b>	<b>5</b>	<b>6</b>	<b>7</b>	<b>8</b>	<b>9</b>	<b>10</b>	<b>L1</b>	<b>L2</b>			
					1703	3088	N/A	3441	3703	3964	4225	4486	4747	5008	5270	5531	5792	N/A	N/A	Tight Seat & Back / Removable Upholstery	
					1703-R	452	N/A	950	1211	1472	1733	1995	2256	2517	2778	3039	3300	N/A	N/A	Replacement Upholstery Covers	

**DESCRIPTION:**



- Upholstery Frames: Steel, Plywood & Hardwood
- Seat: High Density Polyurethane Foam Over Strap Webbing
- Back: High Density Polyurethane Foam Over Sinuous Wire Springs
- Upholstered Covers: Attached w/ Velcro / Removable For Maintenance
- Exposed Wood Legs: Solid Hardwood / Removable For Maintenance
- Antimicrobial Moisture Barrier Fully Encapsulates All Foam Areas
- Leather Upholstery Not Available
- Lifetime Warranty

**OPTIONS:**

- WAC-1 Solid Wood Arm Caps (Set Of 2) .....\$154
- UAC-1 Black Urethane Arm Caps (Set Of 2).....\$205
- PM1 Power/Data Module (1-Power / 1-USB 2 Port Simplex Charger) .....\$836

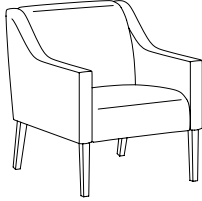
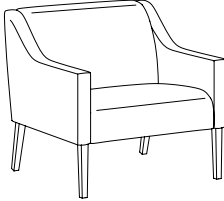
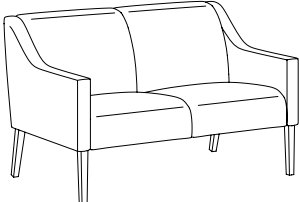
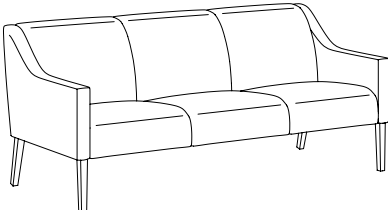
Feather Down & Polyester Pillows Available (See Page 5)  
 Specify Exposed Wood Finish (See Page 6)  
 Tablet Arm / Cup Holder Options (See Facelift Prime Lounge Options Pages)  
 Biscuit Tufting Available Upon Request (Contact Customer Service For Pricing)

LOUNGE		ITEM #:	SPECIFICATIONS   GRADES   LIST PRICES:																			
	<p><b>LOUNGE CHAIR / FULLY UPHOLSTERED</b></p>	<p><b>Overall:</b> 28"w 32.5"d 34"h  <b>Seat:</b> 23"w 20.5"d 18"h</p>	<p><b>Arm:</b> 25"h  <b>Weight:</b> 80 lbs.</p>	<p><b>COM:</b> 4.75 yds.  <b>COL:</b> n/a</p>	<b>COM</b>	<b>COL</b>	<b>1</b>	<b>2</b>	<b>3</b>	<b>4</b>	<b>5</b>	<b>6</b>	<b>7</b>	<b>8</b>	<b>9</b>	<b>10</b>	<b>L1</b>	<b>L2</b>				
					1711	1583	N/A	1744	1868	1991	2115	2239	2362	2486	2610	2733	2857	N/A	N/A	<i>Tight Seat &amp; Back / Removable Upholstery</i>		
					1711-R	228	N/A	463	586	710	834	958	1081	1205	1329	1452	1576	N/A	N/A	<i>Replacement Upholstery Covers</i>		
	<p><b>BARIATRIC LOUNGE CHAIR / FULLY UPHOLSTERED</b></p>	<p><b>Overall:</b> 34"w 32.5"d 34"h  <b>Seat:</b> 29"w 20.5"d 18"h</p>	<p><b>Arm:</b> 25"h  <b>Weight:</b> 90 lbs.</p>	<p><b>COM:</b> 5.25 yds.  <b>COL:</b> n/a</p>	<b>COM</b>	<b>COL</b>	<b>1</b>	<b>2</b>	<b>3</b>	<b>4</b>	<b>5</b>	<b>6</b>	<b>7</b>	<b>8</b>	<b>9</b>	<b>10</b>	<b>L1</b>	<b>L2</b>				
					1711-X	1839	N/A	2013	2151	2288	2426	2563	2700	2838	2975	3113	3250	N/A	N/A	<i>Tight Seat &amp; Back / Removable Upholstery / 750 lb. Weight Capacity</i>		
					1711-XR	228	N/A	490	628	765	903	1040	1177	1315	1452	1590	1727	N/A	N/A	<i>Replacement Upholstery Covers</i>		
	<p><b>TWO PLACE SOFA / FULLY UPHOLSTERED</b></p>	<p><b>Overall:</b> 51"w 32.5"d 34"h  <b>Seat:</b> 46"w 20.5"d 18"h</p>	<p><b>Arm:</b> 25"h  <b>Weight:</b> 140 lbs.</p>	<p><b>COM:</b> 6.5 yds.  <b>COL:</b> n/a</p>	<b>COM</b>	<b>COL</b>	<b>1</b>	<b>2</b>	<b>3</b>	<b>4</b>	<b>5</b>	<b>6</b>	<b>7</b>	<b>8</b>	<b>9</b>	<b>10</b>	<b>L1</b>	<b>L2</b>				
					1712	2437	N/A	2648	2820	2992	3163	3335	3507	3679	3851	4022	4194	N/A	N/A	<i>Tight Seat &amp; Back / Removable Upholstery</i>		
					1712-R	337	N/A	663	834	1006	1178	1350	1522	1693	1865	2037	2209	N/A	N/A	<i>Replacement Upholstery Covers</i>		
	<p><b>THREE PLACE SOFA / FULLY UPHOLSTERED</b></p>	<p><b>Overall:</b> 74"w 32.5"d 34"h  <b>Seat:</b> 69"w 20.5"d 18"h</p>	<p><b>Arm:</b> 25"h  <b>Weight:</b> 200 lbs.</p>	<p><b>COM:</b> 8.5 yds.  <b>COL:</b> n/a</p>	<b>COM</b>	<b>COL</b>	<b>1</b>	<b>2</b>	<b>3</b>	<b>4</b>	<b>5</b>	<b>6</b>	<b>7</b>	<b>8</b>	<b>9</b>	<b>10</b>	<b>L1</b>	<b>L2</b>				
					1713	3192	N/A	3472	3699	3925	4152	4379	4606	4832	5059	5286	5513	N/A	N/A	<i>Tight Seat &amp; Back / Removable Upholstery</i>		
					1713-R	426	N/A	856	1083	1310	1537	1763	1990	2217	2444	2671	2897	N/A	N/A	<i>Replacement Upholstery Covers</i>		

ARM CAPS / LEGS	OPTION #:	SPECIFICATIONS   LIST PRICES   AVAILABILITY:
<p>SOLID WOOD ARM CAPS</p> 	<p><b>WAC-1</b></p>	<p><i>Overall: 3.25"w 17.5"d 1.25"h</i></p> <hr/> <p>\$154 (Set Of 2) <i>(Specify Finish)</i></p> <p><i>Available: Facelift 1 Prime Collection</i></p>
<p>URETHANE ARM CAPS</p> 	<p><b>UAC-1</b></p>	<p><i>Overall: 3.25"w 17.5"d 1.25"h</i></p> <hr/> <p>\$205 (Set Of 2) <i>(Black Urethane)</i></p> <p><i>Available: Facelift 1 Prime Collection</i></p>
<p>BRUSHED ALUMINUM ROUND LEGS</p> 	<p><b>ARL</b></p>	<p><i>Overall: 2" Diameter 5"h</i></p> <hr/> <p>\$353 (Set Of 4) <i>(Brushed Aluminum Finish)</i></p> <p><i>Available: Facelift 1 Prime Lounge Collection (1701, 1701-X, 1702, 1703)</i></p>

TABLET ARMS / POWER / COVERS	OPTION #:	SPECIFICATIONS   LIST PRICES   AVAILABILITY:
<p><b>TABLET ARMS / CUP HOLDER</b></p>  <p>Laminate Tablet Arm Shown w/ Cup Holder</p>  <p>Veneer Tablet Arm Shown w/ Cup Holder</p>  <p>Solid Surface Tablet Arm Shown w/ Cup Holder</p>	<p><b>TA-L</b></p> <p><b>TA-V</b></p> <p><b>TA-C</b></p> <p><b>CH-1</b></p> <p><b>CH-2</b></p>	<p><b>Overall:</b> 14" Diameter .75"h</p> <hr/> <p>\$440 <i>Tablet Arm With 360° Rotation - High Pressure Laminate. (Specify Laminate / Specify Left Or Right Facing Arm Location)</i></p> <p>\$503 <i>Tablet Arm With 360° Rotation - Sunburst Cherry Veneer. (Specify Finish / Specify Left Or Right Facing Arm Location)</i></p> <p>\$654 <i>Tablet Arm With 360° Rotation - White Solid Surface. (Available In White Only / Specify Left Or Right Facing Arm Location)</i></p> <p>\$105 <i>Black Plastic Cup Holder (Only Available If Used With Tablet Arm)</i></p> <p>\$157 <i>Spun Aluminum Cup Holder (Only Available If Used With Tablet Arm)</i></p> <p><b>Available:</b> <i>Facelift 1 Prime Collection</i></p>
<p><b>DOUBLE ARTICULATING / SWIVEL TABLET ARM</b></p>  <p>ATA-L Double Articulating / Swivel Tablet Arm</p>  <p>ATA-L w/ CH-1 Black Plastic Cup Holder</p>	<p><b>ATA-L</b></p> <p><b>ATA-V</b></p> <p><b>ATA-C</b></p> <p><b>CH-1</b></p> <p><b>CH-2</b></p>	<p><b>Overall:</b> 14" Diameter .75"h</p> <hr/> <p>\$865 <i>Tablet Arm With 360° Rotation - High Pressure Laminate. (Specify Laminate / Specify Left Or Right Facing Arm Location)</i></p> <p>\$904 <i>Tablet Arm With 360° Rotation - Sunburst Cherry Veneer. (Specify Finish / Specify Left Or Right Facing Arm Location)</i></p> <p>\$1089 <i>Tablet Arm With 360° Rotation - White Solid Surface. (Available In White Only / Specify Left Or Right Facing Arm Location)</i></p> <p>\$105 <i>Black Plastic Cup Holder (Only Available If Used With Tablet Arm)</i></p> <p>\$157 <i>Spun Aluminum Cup Holder (Only Available If Used With Tablet Arm)</i></p> <p><b>Available:</b> <i>Facelift 1 Prime Collection</i></p>
<p><b>POWER / DATA MODULE</b></p> 	<p><b>PM1</b></p>	<p><b>Overall:</b> 5.25"w 1.25"d 4.25"h</p> <hr/> <p>\$836 (1-Power / 1-USB 2 Port Simplex Charger Standard) <i>Vertical / Horizontal Mount Power Module. Price Varies By Socket. Contact Customer Service For Quote. (Additional Colors Available)</i></p> <p><b>Available:</b> <i>Facelift 1 Prime Low Leg Lounge</i></p>
<p><b>CONTRASTING COVERS</b></p> 	<p><b>CC</b></p>	<p><b>Overall:</b> N/A</p> <hr/> <p>\$129 <i>NOTE: If Two Or More Upholsteries Or Leathers Are Used On Any Piece Of Furniture, Then A Contrast Charge Will Apply Per Order. When Using Trinity Upholstery, The Higher Priced Upholstery Grade Will Be Used In Pricing, Unless It's Trinity Leather With Fabric Contrast Welt, Or COM With Trinity Contrast Welt, Then Contact Customer Service For Pricing.</i></p> <p><b>Available:</b> <i>Facelift 1 Prime Collection</i></p>



# Facelift Prime

---

GUEST / TANDEM / BENCHES / TABLES

Effective: August 1, 2022

T R I N I T Y

**Date:**

**Page:**

**Modification:**

**Description:**

---

### DESCRIPTION:

- Upholstery Frames: Steel, Plywood & Hardwood
- Seat: High Density Polyurethane Foam Over Strap Webbing
- Back: High Density Polyurethane Foam Over Sinuous Wire Springs
- Upholstered Covers: Attached w/ Velcro / Removable For Maintenance
- Exposed Wood Legs: Solid Hardwood / Removable For Maintenance
- Antimicrobial Moisture Barrier Fully Encapsulates All Foam Areas
- Leather Upholstery Not Available
- Lifetime Warranty

### Behavioral Chair:

- Upholstery Frames: Steel, Plywood & Hardwood
- Recycled 22" Wide 1 1/2" X 1 1/2" Steel Inner-frame
- Seat: High Density Polyurethane Foam Over Sheet Webbing
- Back: High Density Polyurethane Foam Over Hardwood Plywood

- Arms: Held In Place By Non-Removable Helical Fasteners
- Exposed Wood Legs: Solid Hardwood / Removable For Maintenance
- Full Underbody Panel
- Tamperproof Screws On Seat Pan
- Full Clean-Out Between Seat & Back
- No Exposed Hardware Or "Pick Points"
- All Staples Are Concealed & Inaccessible

### Behavioral Chair Enhancements:

- Vacuum Formed ABS Under Panel With Drain
- Additional Weight Can Be Added To The Seat
- Can Be Bolted To Floor
- Replaceable Seat Cover w/ Antimicrobial Moisture Barrier
- Bariatric 30" Wide 500lbs. Available

### OPTIONS:

- WAC-2 Solid Wood Arm Caps (Set Of 2) .....\$143
- UAC-2 Black Urethane Arm Caps (Set Of 2) .....\$193
- PM1 Power/Data Module (1-Power / 1-USB 2 Port Simplex Charger) .....\$836

Tablet Arm / Cup Holder Options (See Facelift Prime Guest/Tandem Options Page)  
Specify Exposed Wood Finish (See Page 6)  
Biscuit Tufting Available Upon Request (Contact Customer Service For Pricing)

**NOTE: All Seating Configurations Are Viewed From Left To Right Facing. Please Attach A Layout Showing Seating Configuration w/ Your Order. Assembled Units Must Be Shipped In Configurations Of 3 Or Less.**

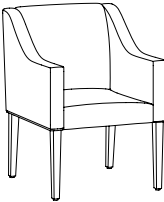
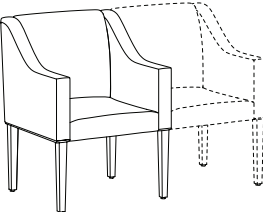
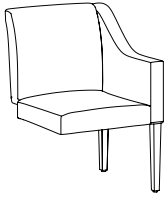
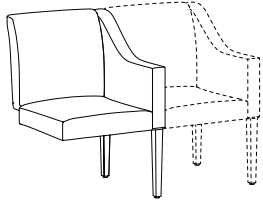
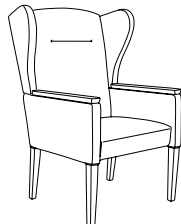
GUEST / TANDEM		ITEM #:	SPECIFICATIONS   GRADES   LIST PRICES:												
	<b>ARM SIDE CHAIR</b>		<b>Overall:</b> 24"w 28"d 34"h <b>Seat:</b> 19"w 20"d 19"h			<b>Arm:</b> 26"h <b>Weight:</b> 60 lbs.			<b>COM:</b> 4 yds. <b>COL:</b> n/a						
	1720	1320	N/A	1454	1557	1660	1763	1866	1969	2072	2175	2278	2382	N/A	N/A
	1720-R	157	N/A	355	458	561	664	767	870	973	1076	1179	1282	N/A	N/A
			<i>Tight Seat &amp; Back / Removable Upholstery</i> <i>Replacement Upholstery Covers</i>												
	<b>ARM CHAIR / ACCEPTS SEAT ON RIGHT</b>		<b>Overall:</b> 24"w 28"d 34"h <b>Seat:</b> 19"w 20"d 19"h			<b>Arm:</b> 26"h <b>Weight:</b> 60 lbs.			<b>COM:</b> 4 yds. <b>COL:</b> n/a						
	1720-C	1320	N/A	1454	1557	1660	1763	1866	1969	2072	2175	2278	2382	N/A	N/A
	1720-CR	157	N/A	355	458	561	664	767	870	973	1076	1179	1282	N/A	N/A
			<i>Tight Seat &amp; Back / Removable Upholstery</i> <i>Replacement Upholstery Covers</i>												
	<b>ARM CHAIR / ADD-A-SEAT</b>		<b>Overall:</b> 21.5"w 28"d 34"h <b>Seat:</b> 19"w 20"d 19"h			<b>Arm:</b> 26"h <b>Weight:</b> 45 lbs.			<b>COM:</b> 3 yds. <b>COL:</b> n/a						
	1721	1001	N/A	1098	1174	1249	1325	1400	1476	1552	1627	1703	1778	N/A	N/A
	1721-R	127	N/A	271	347	422	498	574	649	725	800	876	952	N/A	N/A
			<i>Tight Seat &amp; Back / Removable Upholstery</i> <i>Replacement Upholstery Covers</i>												
	<b>ARM CHAIR / ADD-A-SEAT / ACCEPTS SEAT ON RIGHT</b>		<b>Overall:</b> 21.5"w 28"d 34"h <b>Seat:</b> 19"w 20"d 19"h			<b>Arm:</b> 26"h <b>Weight:</b> 45 lbs.			<b>COM:</b> 3 yds. <b>COL:</b> n/a						
	1721-C	1001	N/A	1098	1174	1249	1325	1400	1476	1552	1627	1703	1778	N/A	N/A
	1721-CR	127	N/A	271	347	422	498	574	649	725	800	876	952	N/A	N/A
			<i>Tight Seat &amp; Back / Removable Upholstery</i> <i>Replacement Upholstery Covers</i>												
	<b>WINGBACK BEHAVIORAL HEALTH CHAIR / URETHANE ARMS</b>		<b>Overall:</b> 26"w 28.5"d 46"h <b>Seat:</b> 21"w 20"d 19"h			<b>Arm:</b> 26.5"h <b>Weight:</b> 80 lbs.			<b>COM:</b> 4 yds. <b>COL:</b> n/a						
	BH1722-WB	1986	N/A	2084	2187	2290	2393	2496	2600	2703	2806	2909	3012	N/A	N/A
				<i>Tight Seat &amp; Back / Removable Upholstery Seat Only</i>											

Meets Behavioral Health Requirements

**DESCRIPTION:**

- Upholstery Frames: Steel, Plywood & Hardwood
- Seat: High Density Polyurethane Foam Over Strap Webbing
- Back: High Density Polyurethane Foam Over Sinuous Wire Springs
- Upholstered Covers: Attached w/ Velcro / Removable For Maintenance
- Exposed Wood Legs: Solid Hardwood / Removable For Maintenance
- Antimicrobial Moisture Barrier Fully Encapsulates All Foam Areas
- Leather Upholstery Not Available
- Lifetime Warranty

**OPTIONS:**

- WAC-2 Solid Wood Arm Caps (Set Of 2) .....\$143
- UAC-2 Black Urethane Arm Caps (Set Of 2).....\$193
- PM1 Power/Data Module (1-Power / 1-USB 2 Port Simplex Charger) .....\$836

Tablet Arm / Cup Holder Options (See Facelift Prime Guest/Tandem Options Pages)  
Specify Exposed Wood Finish (See Page 6)  
Biscuit Tufting Available Upon Request (Contact Customer Service For Pricing)

*NOTE: All Seating Configurations Are Viewed From Left To Right Facing. Please Attach A Layout Showing Seating Configuration w/ Your Order. Assembled Units Must Be Shipped In Configurations Of 3 Or Less.*

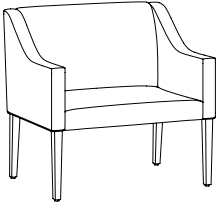
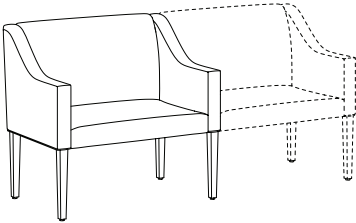
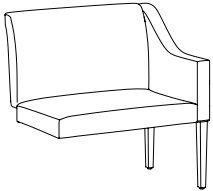
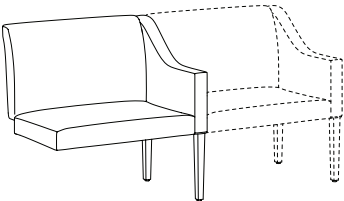
TANDEM / BARIATRIC		ITEM #:	SPECIFICATIONS   GRADES   LIST PRICES:													
<b>BARIATRIC ARM SIDE CHAIR</b>			<b>Overall:</b> 34"w 28"d 34"h			<b>Arm:</b> 26"h			<b>COM:</b> 4.25 yds.							
			<b>Seat:</b> 29"w 20"d 19"h			<b>Weight:</b> 65 lbs.			<b>COL:</b> n/a							
			<b>COM</b>	<b>COL</b>	<b>1</b>	<b>2</b>	<b>3</b>	<b>4</b>	<b>5</b>	<b>6</b>	<b>7</b>	<b>8</b>	<b>9</b>	<b>10</b>	<b>L1</b>	<b>L2</b>
	<b>1730</b>		1648	N/A	1778	1888	1998	2108	2218	2328	2438	2548	2658	2768	N/A	N/A
<i>Tight Seat &amp; Back / Removable Upholstery / 500 lb. Weight Capacity</i>																
	<b>1730-R</b>		172	N/A	382	492	602	712	822	932	1042	1152	1262	1372	N/A	N/A
<i>Replacement Upholstery Covers</i>																
<b>BARIATRIC ARM CHAIR / ACCEPTS SEAT ON RIGHT</b>			<b>Overall:</b> 34"w 28"d 34"h			<b>Arm:</b> 26"h			<b>COM:</b> 4.25 yds.							
			<b>Seat:</b> 29"w 20"d 19"h			<b>Weight:</b> 65 lbs.			<b>COL:</b> n/a							
			<b>COM</b>	<b>COL</b>	<b>1</b>	<b>2</b>	<b>3</b>	<b>4</b>	<b>5</b>	<b>6</b>	<b>7</b>	<b>8</b>	<b>9</b>	<b>10</b>	<b>L1</b>	<b>L2</b>
	<b>1730-C</b>		1648	N/A	1778	1888	1998	2108	2218	2328	2438	2548	2658	2768	N/A	N/A
<i>Tight Seat &amp; Back / Removable Upholstery / 500 lb. Weight Capacity</i>																
	<b>1730-CR</b>		172	N/A	382	492	602	712	822	932	1042	1152	1262	1372	N/A	N/A
<i>Replacement Upholstery Covers</i>																
<b>BARIATRIC ARM CHAIR / ADD-A-SEAT</b>			<b>Overall:</b> 31.5"w 28"d 34"h			<b>Arm:</b> 26"h			<b>COM:</b> 3.75 yds.							
			<b>Seat:</b> 29"w 20"d 19"h			<b>Weight:</b> 50 lbs.			<b>COL:</b> n/a							
			<b>COM</b>	<b>COL</b>	<b>1</b>	<b>2</b>	<b>3</b>	<b>4</b>	<b>5</b>	<b>6</b>	<b>7</b>	<b>8</b>	<b>9</b>	<b>10</b>	<b>L1</b>	<b>L2</b>
	<b>1731</b>		1335	N/A	1455	1551	1647	1743	1840	1936	2032	2128	2224	2321	N/A	N/A
<i>Tight Seat &amp; Back / Removable Upholstery / 500 lb. Weight Capacity</i>																
	<b>1731-R</b>		141	N/A	325	421	518	614	710	806	903	999	1095	1191	N/A	N/A
<i>Replacement Upholstery Covers</i>																
<b>BARIATRIC ARM CHAIR / ADD-A-SEAT / ACCEPTS SEAT ON RIGHT</b>			<b>Overall:</b> 31.5"w 28"d 34"h			<b>Arm:</b> 26"h			<b>COM:</b> 3.75 yds.							
			<b>Seat:</b> 29"w 20"d 19"h			<b>Weight:</b> 50 lbs.			<b>COL:</b> n/a							
			<b>COM</b>	<b>COL</b>	<b>1</b>	<b>2</b>	<b>3</b>	<b>4</b>	<b>5</b>	<b>6</b>	<b>7</b>	<b>8</b>	<b>9</b>	<b>10</b>	<b>L1</b>	<b>L2</b>
	<b>1731-C</b>		1335	N/A	1455	1551	1647	1743	1840	1936	2032	2128	2224	2321	N/A	N/A
<i>Tight Seat &amp; Back / Removable Upholstery / 500 lb. Weight Capacity</i>																
	<b>1731-CR</b>		141	N/A	325	421	518	614	710	806	903	999	1095	1191	N/A	N/A
<i>Replacement Upholstery Covers</i>																

**DESCRIPTION:**

- Upholstery Frames: Steel, Plywood & Hardwood
- Seat: High Density Polyurethane Foam Over Strap Webbing
- Back: High Density Polyurethane Foam Over Sinuous Wire Springs
- Upholstered Covers: Attached w/ Velcro / Removable For Maintenance
- Exposed Wood Legs: Solid Hardwood / Removable For Maintenance
- Antimicrobial Moisture Barrier Fully Encapsulates All Foam Areas
- Leather Upholstery Not Available
- Lifetime Warranty

**OPTIONS:**

- WAC-2 Solid Wood Arm Caps (Set Of 2) .....\$143
- UAC-2 Black Urethane Arm Caps (Set Of 2).....\$193
- PM1 Power/Data Module (1-Power / 1-USB 2 Port Simplex Charger) .....\$836

Tablet Arm / Cup Holder Options (See Facelift Prime Guest/Tandem Options Pages)  
Specify Exposed Wood Finish (See Page 6)  
Biscuit Tufting Available Upon Request (Contact Customer Service For Pricing)

*NOTE: All Seating Configurations Are Viewed From Left To Right Facing. Please Attach A Layout Showing Seating Configuration w/ Your Order. Assembled Units Must Be Shipped In Configurations Of 3 Or Less.*

**TANDEM**

**ITEM #: SPECIFICATIONS | GRADES | LIST PRICES:**

**TWO PLACE SOFA**

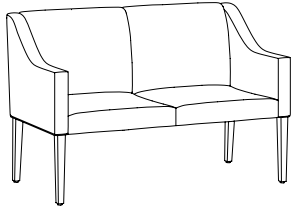

**Overall:** 52"w 28"d 34"h      **Arm:** 26"h      **COM:** 5.25 yds.  
**Seat:** 47"w 20"d 19"h      **Weight:** 135 lbs.      **COL:** n/a

COM	COL	1	2	3	4	5	6	7	8	9	10	L1	L2	
1748	N/A	2287	2424	2562	2699	2836	2974	3111	3249	3386	3524	N/A	N/A	
<i>Tight Seat &amp; Back / Removable Upholstery</i>														
1748-R	N/A	265	525	663	800	938	1075	1212	1350	1487	1625	1762	N/A	N/A
<i>Replacement Upholstery Covers</i>														

**TWO PLACE SOFA / ACCEPTS SEAT ON RIGHT**

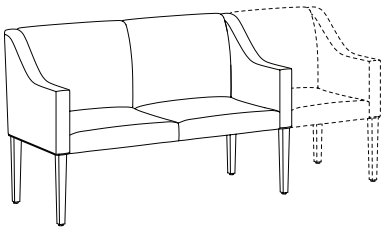

**Overall:** 52"w 28"d 34"h      **Arm:** 26"h      **COM:** 5.25 yds.  
**Seat:** 47"w 20"d 19"h      **Weight:** 135 lbs.      **COL:** n/a

COM	COL	1	2	3	4	5	6	7	8	9	10	L1	L2	
1748-C	N/A	2287	2424	2562	2699	2836	2974	3111	3249	3386	3524	N/A	N/A	
<i>Tight Seat &amp; Back / Removable Upholstery</i>														
1748-CR	N/A	265	525	663	800	938	1075	1212	1350	1487	1625	1762	N/A	N/A
<i>Replacement Upholstery Covers</i>														

**TWO PLACE SOFA / ADD-A-SEAT**

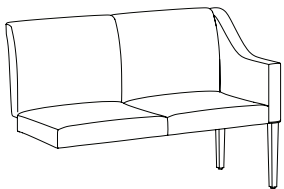

**Overall:** 49.5"w 28"d 34"h      **Arm:** 26"h      **COM:** 4.75 yds.  
**Seat:** 47"w 20"d 19"h      **Weight:** 120 lbs.      **COL:** n/a

COM	COL	1	2	3	4	5	6	7	8	9	10	L1	L2	
1749	N/A	1945	2069	2192	2316	2440	2563	2687	2811	2935	3058	N/A	N/A	
<i>Tight Seat &amp; Back / Removable Upholstery</i>														
1749-R	N/A	198	434	558	682	806	929	1053	1177	1300	1424	1548	N/A	N/A
<i>Replacement Upholstery Covers</i>														

**TWO PLACE SOFA / ADD-A-SEAT / ACCEPTS SEAT ON RIGHT**

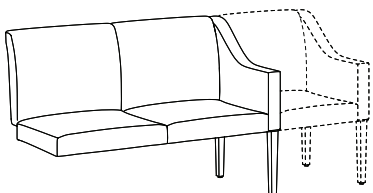

**Overall:** 49.5"w 28"d 34"h      **Arm:** 26"h      **COM:** 4.75 yds.  
**Seat:** 47"w 20"d 19"h      **Weight:** 120 lbs.      **COL:** n/a

COM	COL	1	2	3	4	5	6	7	8	9	10	L1	L2	
1749-C	N/A	1945	2069	2192	2316	2440	2563	2687	2811	2935	3058	N/A	N/A	
<i>Tight Seat &amp; Back / Removable Upholstery</i>														
1749-CR	N/A	198	434	558	682	806	929	1053	1177	1300	1424	1548	N/A	N/A
<i>Replacement Upholstery Covers</i>														

**DESCRIPTION:**

- Upholstery Frames: Steel, Plywood & Hardwood
- Seat: High Density Polyurethane Foam Over Strap Webbing
- Upholstered Covers: Attached w/ Velcro / Removable For Maintenance
- Exposed Wood Legs: Solid Hardwood / Removable For Maintenance
- Antimicrobial Moisture Barrier Fully Encapsulates All Foam Areas
- Leather Upholstery Not Available
- Lifetime Warranty

**OPTIONS:**

- 26HA 26" High Arms.....\$40 Per Arm
  - ARL Brushed Aluminum Round Legs (Set Of 4).....\$353
  - PM1 Power/Data Module (1-Power / 1-USB 2 Port Simplex Charger) .....\$836
- Specify Exposed Wood Finish (See Page 6)  
Biscuit Tufting Available Upon Request (Contact Customer Service For Pricing)

*NOTE: All Seating Configurations Are Viewed From Left To Right Facing. Please Attach A Layout Showing Seating Configuration w/ Your Order. Assembled Units Must Be Shipped In Configurations Of 3 Or Less.*

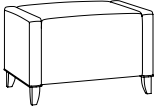
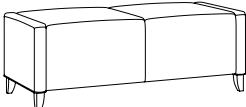
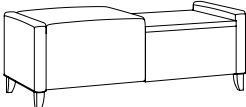
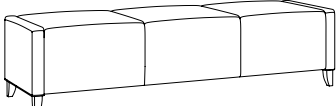
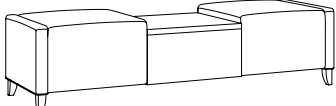
BENCHES		ITEM #:	SPECIFICATIONS   GRADES   LIST PRICES:													
	<b>BENCH / OTTOMAN</b>		<b>Overall:</b> 28"w 22"d 19"h <b>Seat:</b> 23"w 22"d 19"h		<b>Arm:</b> n/a <b>Weight:</b> 40 lbs.		<b>COM:</b> 3.25 yds. <b>COL:</b> n/a									
			<b>COM</b>	<b>COL</b>	<b>1</b>	<b>2</b>	<b>3</b>	<b>4</b>	<b>5</b>	<b>6</b>	<b>7</b>	<b>8</b>	<b>9</b>	<b>10</b>	<b>L1</b>	<b>L2</b>
	1761		1045	N/A	1153	1235	1318	1400	1483	1565	1648	1730	1813	1895	N/A	N/A
			<i>Removable Upholstery</i>													
		1761-R	147	N/A	304	386	469	551	634	716	799	881	964	1046	N/A	N/A
			<i>Replacement Upholstery Covers</i>													
	<b>TWO SEAT BENCH</b>		<b>Overall:</b> 52"w 22"d 19"h <b>Seat:</b> 47"w 22"d 19"h		<b>Arm:</b> n/a <b>Weight:</b> 60 lbs.		<b>COM:</b> 4.5 yds. <b>COL:</b> n/a									
			<b>COM</b>	<b>COL</b>	<b>1</b>	<b>2</b>	<b>3</b>	<b>4</b>	<b>5</b>	<b>6</b>	<b>7</b>	<b>8</b>	<b>9</b>	<b>10</b>	<b>L1</b>	<b>L2</b>
	1762		1622	N/A	1767	1884	2001	2118	2235	2351	2468	2585	2702	2819	N/A	N/A
			<i>Removable Upholstery</i>													
		1762-R	190	N/A	413	530	647	764	880	997	1114	1231	1348	1464	N/A	N/A
			<i>Replacement Upholstery Covers</i>													
	<b>SEAT / TABLE BENCH</b>		<b>Overall:</b> 52"w 22"d 19"h <b>Seat:</b> 47"w 22"d 19"h		<b>Arm:</b> n/a <b>Weight:</b> 70 lbs.		<b>COM:</b> 3.25 yds. <b>COL:</b> n/a									
			<b>COM</b>	<b>COL</b>	<b>1</b>	<b>2</b>	<b>3</b>	<b>4</b>	<b>5</b>	<b>6</b>	<b>7</b>	<b>8</b>	<b>9</b>	<b>10</b>	<b>L1</b>	<b>L2</b>
	1762-ST		1876	N/A	1939	2022	2104	2186	2269	2351	2434	2516	2599	2681	N/A	N/A
			<i>Removable Upholstery / High Pressure Laminate Top (Square Edge)</i>													
		1761-R	147	N/A	304	386	469	551	634	716	799	881	964	1046	N/A	N/A
			<i>Replacement Upholstery Covers</i>													
	<b>THREE SEAT BENCH</b>		<b>Overall:</b> 76"w 22"d 19"h <b>Seat:</b> 71"w 22"d 19"h		<b>Arm:</b> n/a <b>Weight:</b> 85 lbs.		<b>COM:</b> 6 yds. <b>COL:</b> n/a									
			<b>COM</b>	<b>COL</b>	<b>1</b>	<b>2</b>	<b>3</b>	<b>4</b>	<b>5</b>	<b>6</b>	<b>7</b>	<b>8</b>	<b>9</b>	<b>10</b>	<b>L1</b>	<b>L2</b>
	1763		2135	N/A	2335	2493	2651	2809	2967	3125	3283	3441	3600	3758	N/A	N/A
			<i>Removable Upholstery</i>													
		1763-R	232	N/A	536	694	852	1010	1168	1326	1484	1642	1800	1958	N/A	N/A
			<i>Replacement Upholstery Covers</i>													
	<b>SEAT / TABLE / SEAT BENCH</b>		<b>Overall:</b> 76"w 22"d 19"h <b>Seat:</b> 71"w 22"d 19"h		<b>Arm:</b> n/a <b>Weight:</b> 95 lbs.		<b>COM:</b> 4.5 yds. <b>COL:</b> n/a									
			<b>COM</b>	<b>COL</b>	<b>1</b>	<b>2</b>	<b>3</b>	<b>4</b>	<b>5</b>	<b>6</b>	<b>7</b>	<b>8</b>	<b>9</b>	<b>10</b>	<b>L1</b>	<b>L2</b>
	1763-ST		2384	N/A	2488	2604	2721	2838	2955	3072	3188	3305	3422	3539	N/A	N/A
			<i>Removable Upholstery / High Pressure Laminate Top (Square Edge)</i>													
		1762-R	190	N/A	413	530	647	764	880	997	1114	1231	1348	1464	N/A	N/A
			<i>Replacement Upholstery Covers</i>													

**DESCRIPTION:**

- Upholstery Frames: Steel, Plywood & Hardwood
- Seat: High Density Polyurethane Foam Over Strap Webbing
- Upholstered Covers: Attached w/ Velcro / Removable For Maintenance
- Exposed Wood Legs: Solid Hardwood / Removable For Maintenance
- Antimicrobial Moisture Barrier Fully Encapsulates All Foam Areas
- Leather Upholstery Not Available
- Lifetime Warranty

**OPTIONS:**

- 26HA 26" High Arms .....\$40 Per Arm
- PM1 Power/Data Module (1-Power / 1-USB 2 Port Simplex Charger) .....\$836

Specify Exposed Wood Finish (See Page 6)  
 Biscuit Tufting Available Upon Request (Contact Customer Service For Pricing)  
 Veneer Table Tops (Contact Factory)

*NOTE: All Seating Configurations Are Viewed From Left To Right Facing. Please Attach A Layout Showing Seating Configuration w/ Your Order. Assembled Units Must Be Shipped In Configurations Of 3 Or Less.*

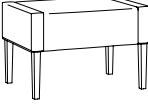
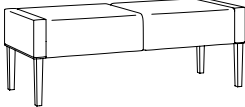
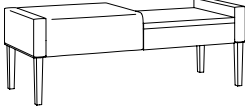
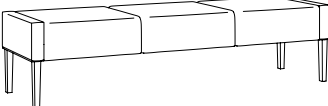
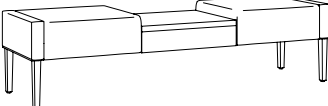
BENCHES		ITEM #:	SPECIFICATIONS   GRADES   LIST PRICES:												
<b>BENCH / OTTOMAN</b>  			<b>Overall:</b> 28"w 22"d 19"h			<b>Arm:</b> n/a			<b>COM:</b> 2 yds.						
			<b>Seat:</b> 23"w 22"d 19"h			<b>Weight:</b> 40 lbs.			<b>COL:</b> n/a						
			<b>COM</b>	<b>COL</b>	<b>1</b>	<b>2</b>	<b>3</b>	<b>4</b>	<b>5</b>	<b>6</b>	<b>7</b>	<b>8</b>	<b>9</b>	<b>10</b>	<b>L1</b>
	<b>1771</b>	983	N/A	1026	1074	1122	1170	1218	1266	1314	1362	1410	1459	N/A	N/A
		<i>Removable Upholstery</i>													
	<b>1771-R</b>	141	N/A	229	277	325	373	422	470	518	566	614	662	N/A	N/A
		<i>Replacement Upholstery Covers</i>													
<b>TWO SEAT BENCH</b>  			<b>Overall:</b> 52"w 22"d 19"h			<b>Arm:</b> n/a			<b>COM:</b> 3.25 yds.						
			<b>Seat:</b> 47"w 22"d 19"h			<b>Weight:</b> 50 lbs.			<b>COL:</b> n/a						
			<b>COM</b>	<b>COL</b>	<b>1</b>	<b>2</b>	<b>3</b>	<b>4</b>	<b>5</b>	<b>6</b>	<b>7</b>	<b>8</b>	<b>9</b>	<b>10</b>	<b>L1</b>
	<b>1772</b>	1520	N/A	1602	1684	1767	1849	1931	2014	2096	2179	2261	2344	N/A	N/A
		<i>Removable Upholstery</i>													
	<b>1772-R</b>	183	N/A	338	421	503	586	668	751	833	916	998	1080	N/A	N/A
		<i>Replacement Upholstery Covers</i>													
<b>SEAT / TABLE BENCH</b>  			<b>Overall:</b> 52"w 22"d 19"h			<b>Arm:</b> n/a			<b>COM:</b> 2 yds.						
			<b>Seat:</b> 47"w 22"d 19"h			<b>Weight:</b> 60 lbs.			<b>COL:</b> n/a						
			<b>COM</b>	<b>COL</b>	<b>1</b>	<b>2</b>	<b>3</b>	<b>4</b>	<b>5</b>	<b>6</b>	<b>7</b>	<b>8</b>	<b>9</b>	<b>10</b>	<b>L1</b>
	<b>1772-ST</b>	1698	N/A	1702	1750	1798	1846	1894	1942	1991	2039	2087	2135	N/A	N/A
		<i>Removable Upholstery / High Pressure Laminate Top (Square Edge)</i>													
	<b>1771-R</b>	141	N/A	229	277	325	373	422	470	518	566	614	662	N/A	N/A
		<i>Replacement Upholstery Covers</i>													
<b>THREE SEAT BENCH</b>  			<b>Overall:</b> 76"w 22"d 19"h			<b>Arm:</b> n/a			<b>COM:</b> 4 yds.						
			<b>Seat:</b> 71"w 22"d 19"h			<b>Weight:</b> 70 lbs.			<b>COL:</b> n/a						
			<b>COM</b>	<b>COL</b>	<b>1</b>	<b>2</b>	<b>3</b>	<b>4</b>	<b>5</b>	<b>6</b>	<b>7</b>	<b>8</b>	<b>9</b>	<b>10</b>	<b>L1</b>
	<b>1773</b>	1973	N/A	2071	2174	2277	2380	2484	2587	2690	2793	2896	2999	N/A	N/A
		<i>Removable Upholstery</i>													
	<b>1773-R</b>	226	N/A	420	523	626	729	832	935	1038	1141	1245	1348	N/A	N/A
		<i>Replacement Upholstery Covers</i>													
<b>SEAT / TABLE / SEAT BENCH</b>  			<b>Overall:</b> 76"w 22"d 19"h			<b>Arm:</b> n/a			<b>COM:</b> 3.25 yds.						
			<b>Seat:</b> 71"w 22"d 19"h			<b>Weight:</b> 80 lbs.			<b>COL:</b> n/a						
			<b>COM</b>	<b>COL</b>	<b>1</b>	<b>2</b>	<b>3</b>	<b>4</b>	<b>5</b>	<b>6</b>	<b>7</b>	<b>8</b>	<b>9</b>	<b>10</b>	<b>L1</b>
	<b>1773-ST</b>	2177	N/A	2223	2305	2388	2470	2553	2635	2718	2800	2883	2965	N/A	N/A
		<i>Removable Upholstery / High Pressure Laminate Top (Square Edge)</i>													
	<b>1772-R</b>	183	N/A	338	421	503	586	668	751	833	916	998	1080	N/A	N/A
		<i>Replacement Upholstery Covers</i>													

**DESCRIPTION:**

- Exposed Frames: Solid Maple, Self Edge, Vertical Direction
- Wilsonart Plastic Laminates Standard. Alternate Selections May Be Specified From Most Major Laminate Manufacturers. (Contact Factory For Availability)
- Lifetime Warranty



**OPTIONS:**

Specify Exposed Wood Finish / Laminate (See Page 6)





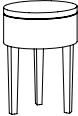
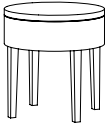
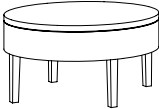

Square Edge Profile Standard



*NOTE: All Seating Configurations Are Viewed From Left To Right Facing. Please Attach A Layout Showing Seating Configuration w/ Your Order. Assembled Units Must Be Shipped In Configurations Of 3 Or Less.*

TABLES	ITEM #:	SPECIFICATIONS   GRADES   LIST PRICES:													
<p>END TABLE / THREE LEG BASE</p> 		<p><b>Overall:</b> 16" Diameter 23"h <b>Weight:</b> 20 lbs.</p>													
		COM	COL	1	2	3	4	5	6	7	8	9	10	L1	L2
	1716D23-L	871	High Pressure Laminate Face / Self Edge												
	1716D23-C	1104	Solid Surface Face (Glacier White) / Self Edge												
<p>END TABLE</p> 		<p><b>Overall:</b> 22" Diameter 23"h <b>Weight:</b> 37 lbs.</p>													
		COM	COL	1	2	3	4	5	6	7	8	9	10	L1	L2
	1722D23-L	1013	High Pressure Laminate Face / Self Edge												
	1722D23-C	1426	Solid Surface Face (Glacier White) / Self Edge												
<p>COFFEE TABLE</p> 		<p><b>Overall:</b> 36" Diameter 18"h <b>Weight:</b> 40 lbs.</p>													
		COM	COL	1	2	3	4	5	6	7	8	9	10	L1	L2
	1736D18-L	2093	High Pressure Laminate Face / Self Edge												
	1736D18-C	3099	Solid Surface Face (Glacier White) / Self Edge												
<p>18" / 180° ADJUSTABLE TABLE / CONNECTS ANY TANDEM CHAIR</p> 		<p><b>Overall:</b> 18" Diameter <b>Weight:</b> 25 lbs.</p>													
		COM	COL	1	2	3	4	5	6	7	8	9	10	L1	L2
	1718DC-L	714	High Pressure Laminate Face												
	1718DC-C	871	Solid Surface Face (Glacier White) / Self Edge												
<p>22" / 180° ADJUSTABLE TABLE / CONNECTS ANY TANDEM CHAIR</p> 		<p><b>Overall:</b> 22" Diameter <b>Weight:</b> 25 lbs.</p>													
		COM	COL	1	2	3	4	5	6	7	8	9	10	L1	L2
	1722DC-L	726	High Pressure Laminate Face												
	1722DC-C	1040	Solid Surface Face (Glacier White) / Self Edge												



ARM CAPS / LEGS	OPTION #:	SPECIFICATIONS   LIST PRICES   AVAILABILITY:
<p>SOLID WOOD ARM CAPS</p> 	<p><b>WAC-2</b></p> <p>\$143 <i>(Specify Finish)</i></p> <p><b>Available: Facelift 1 Prime Guest / Tandem Units</b></p>	<p><b>Overall:</b> 3.25"w 15"d 1.25"h</p>
<p>URETHANE ARM CAPS</p> 	<p><b>UAC-2</b></p> <p>\$193 <i>(Black Urethane)</i></p> <p><b>Available: Facelift 1 Prime Guest / Tandem Units</b></p>	<p><b>Overall:</b> 3.25"w 15"d 1.25"h</p>
<p>BRUSHED ALUMINUM ROUND LEGS</p> 	<p><b>ARL</b></p> <p>\$353 (Set Of 4) <i>(Brushed Aluminum Finish)</i></p> <p><b>Available: Facelift 1 Prime Low Leg Benches (1761, 1762,1762-ST, 1763, 1763-ST)</b></p>	<p><b>Overall:</b> 2" Diameter 5"h</p>

TABLET ARMS / POWER	OPTION #:	SPECIFICATIONS   LIST PRICES   AVAILABILITY:
<b>TABLET ARMS / CUP HOLDER</b>		
 <p>Laminate Tablet Arm Shown w/ Cup Holder</p>	<b>TA-L</b>	<p><b>Overall:</b> 14" Diameter .75"h</p> <p>\$440 Tablet Arm With 360° Rotation - High Pressure Laminate. (Specify Laminate / Specify Left Or Right Facing Arm Location)</p>
 <p>Veneer Tablet Arm Shown w/ Cup Holder</p>	<b>TA-V</b>	<p>\$503 Tablet Arm With 360° Rotation - Sunburst Cherry Veneer. (Specify Finish / Specify Left Or Right Facing Arm Location)</p>
 <p>Solid Surface Tablet Arm Shown w/ Cup Holder</p>	<b>TA-C</b>	<p>\$654 Tablet Arm With 360° Rotation - White Solid Surface. (Available In White Only / Specify Left Or Right Facing Arm Location)</p>
<p><b>CH-1</b> \$105 Black Plastic Cup Holder (Only Available If Used With Tablet Arm)</p>		
<p><b>CH-2</b> \$157 Spun Aluminum Cup Holder (Only Available If Used With Tablet Arm)</p>		
<p><b>Available: Facelift 1 Prime Collection</b></p>		
<b>DOUBLE ARTICULATING / SWIVEL TABLET ARM</b>		
 <p>ATA-L Double Articulating / Swivel Tablet Arm</p>	<b>ATA-L</b>	<p><b>Overall:</b> 14" Diameter .75"h</p> <p>\$865 Tablet Arm With 360° Rotation - High Pressure Laminate. (Specify Laminate / Specify Left Or Right Facing Arm Location)</p>
<p><b>ATA-V</b> \$904 Tablet Arm With 360° Rotation - Sunburst Cherry Veneer. (Specify Finish / Specify Left Or Right Facing Arm Location)</p>		
<p><b>ATA-C</b> \$1089 Tablet Arm With 360° Rotation - White Solid Surface. (Available In White Only / Specify Left Or Right Facing Arm Location)</p>		
<p><b>CH-1</b> \$105 Black Plastic Cup Holder (Only Available If Used With Tablet Arm)</p>		
<p><b>CH-2</b> \$157 Spun Aluminum Cup Holder (Only Available If Used With Tablet Arm)</p>		
<p><b>Available: Facelift 1 Prime Collection</b></p>		
<b>POWER / DATA MODULE</b>		
	<b>PM1</b>	<p><b>Overall:</b> 5.25"w 1.25"d 4.25"h</p> <p>\$836 (1-Power / 1-USB 2 Port Simplex Charger Standard) Vertical / Horizontal Mount Power Module. Price Varies By Socket. Contact Customer Service For Quote. (Additional Colors Available)</p>
<p><b>Available: Facelift 1 Prime Collection</b></p>		

ARMS / COVERS	OPTION #:	SPECIFICATIONS   LIST PRICES   AVAILABILITY:
<p>26" HIGH ARMS</p> 	<p><b>26HA</b></p>	<p><i>Overall: 2.75"w 22"d 26"h</i></p> <hr/> <p><b>\$40 (Per Arm)</b>  <i>26" High Arms For Benches (Specify Fabric)</i></p> <p><b>Available: Facelift 1 Prime Benches</b></p>
<p>CONTRASTING COVERS</p> 	<p><b>CC</b></p>	<p><i>Overall: N/A</i></p> <hr/> <p><b>\$129</b>  <i>NOTE: If Two Or More Upholsteries Or Leathers Are Used On Any Piece Of Furniture, Then A Contrast Charge Will Apply Per Order. When Using Trinity Upholstery, The Higher Priced Upholstery Grade Will Be Used In Pricing, Unless It's Trinity Leather With Fabric Contrast Welt, Or COM With Trinity Contrast Welt, Then Contact Customer Service For Pricing.</i></p> <p><b>Available: Facelift 1 Prime Collection</b></p>

# Facelift Revival

---

LOUNGE / BENCHES

Effective: August 1, 2022

T R I N I T Y

**Date:**

**Page:**

**Modification:**

**Description:**

---

**DESCRIPTION:**

- Upholstery Frames: Steel, Plywood & Hardwood
- Seat: High Density Polyurethane Foam Over Strap Webbing
- Back: High Density Polyurethane Foam Over Sinuous Wire Springs
- Upholstered Covers: Attached w/ Velcro / Removable For Maintenance
- Antimicrobial Moisture Barrier Fully Encapsulates All Foam Areas
- Double Needle Stitching Standard (Welting Optional - No Charge)
- Exposed Wood Legs: Solid Hardwood / Removable For Maintenance
- Leather Upholstery Not Available
- Lifetime Warranty

**OPTIONS:**

- ARL Brushed Aluminum Round Legs (Set Of 4).....\$353
  - PM1 Power/Data Module (1-Power / 1-USB 2 Port Simplex Charger) .....\$836
- Feather Down & Polyester Pillows Available (See Page 5)  
Specify Exposed Wood Finish (See Page 6)

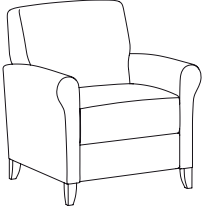
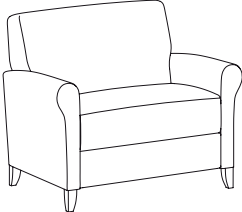
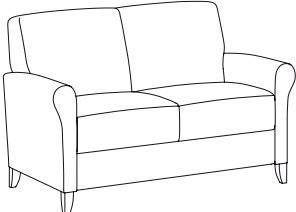
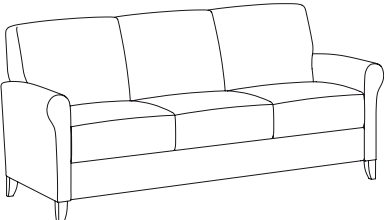
LOUNGE	ITEM #:	SPECIFICATIONS   GRADES   LIST PRICES:													
		<b>Overall:</b> 31"w 32"d 34"h		<b>Arm:</b> 24"h					<b>COM:</b> 4.75 yds.						
		<b>Seat:</b> 21"w 20"d 18.5"h		<b>Weight:</b> 82 lbs.					<b>COL:</b> n/a						
		<b>COM</b>	<b>COL</b>	<b>1</b>	<b>2</b>	<b>3</b>	<b>4</b>	<b>5</b>	<b>6</b>	<b>7</b>	<b>8</b>	<b>9</b>	<b>10</b>	<b>L1</b>	<b>L2</b>
	<b>1801</b>	1488	N/A	1594	1740	1864	1987	2111	2235	2359	2482	2606	2730	N/A	N/A
		<i>Tight Seat &amp; Back / Removable Upholstery</i>													
	<b>1801-R</b>	227	N/A	462	586	709	833	957	1081	1204	1328	1452	1575	N/A	N/A
		<i>Replacement Upholstery Covers</i>													
		<b>Overall:</b> 39.5"w 32"d 34"h		<b>Arm:</b> 24"h					<b>COM:</b> 5.25 yds.						
		<b>Seat:</b> 29.5"w 20"d 18.5"h		<b>Weight:</b> 95 lbs.					<b>COL:</b> n/a						
		<b>COM</b>	<b>COL</b>	<b>1</b>	<b>2</b>	<b>3</b>	<b>4</b>	<b>5</b>	<b>6</b>	<b>7</b>	<b>8</b>	<b>9</b>	<b>10</b>	<b>L1</b>	<b>L2</b>
	<b>1801-X</b>	1721	N/A	1902	2040	2177	2315	2452	2589	2727	2864	3002	3139	N/A	N/A
		<i>Tight Seat &amp; Back / Removable Upholstery / 1000 lb. Weight Capacity</i>													
	<b>1801-XR</b>	227	N/A	490	627	764	902	1039	1177	1314	1452	1589	1727	N/A	N/A
		<i>Replacement Upholstery Covers</i>													
		<b>Overall:</b> 57"w 32"d 34"h		<b>Arm:</b> 24"h					<b>COM:</b> 6.75 yds.						
		<b>Seat:</b> 47.5"w 20"d 18.5"h		<b>Weight:</b> 120 lbs.					<b>COL:</b> n/a						
		<b>COM</b>	<b>COL</b>	<b>1</b>	<b>2</b>	<b>3</b>	<b>4</b>	<b>5</b>	<b>6</b>	<b>7</b>	<b>8</b>	<b>9</b>	<b>10</b>	<b>L1</b>	<b>L2</b>
	<b>1802</b>	2318	N/A	2539	2699	2828	3007	3186	3364	3543	3722	3900	4079	N/A	N/A
		<i>Tight Seat &amp; Back / Removable Upholstery</i>													
	<b>1802-R</b>	334	N/A	673	852	1031	1210	1388	1567	1746	1924	2103	2282	N/A	N/A
		<i>Replacement Upholstery Covers</i>													
		<b>Overall:</b> 80"w 32"d 34"h		<b>Arm:</b> 24"h					<b>COM:</b> 8.75 yds.						
		<b>Seat:</b> 70.5"w 20"d 18.5"h		<b>Weight:</b> 155 lbs.					<b>COL:</b> n/a						
		<b>COM</b>	<b>COL</b>	<b>1</b>	<b>2</b>	<b>3</b>	<b>4</b>	<b>5</b>	<b>6</b>	<b>7</b>	<b>8</b>	<b>9</b>	<b>10</b>	<b>L1</b>	<b>L2</b>
	<b>1803</b>	3076	N/A	3375	3609	3842	4076	4310	4543	4777	5011	5244	5478	N/A	N/A
		<i>Tight Seat &amp; Back / Removable Upholstery</i>													
	<b>1803-R</b>	421	N/A	866	1099	1333	1567	1800	2034	2268	2501	2735	2969	N/A	N/A
		<i>Replacement Upholstery Covers</i>													



**DESCRIPTION:**

- Upholstery Frames: Steel, Plywood & Hardwood
- Seat: High Density Polyurethane Foam Over Strap Webbing
- Back: High Density Polyurethane Foam Over Sinuous Wire Springs
- Upholstered Covers: Attached w/ Velcro / Removable For Maintenance
- Antimicrobial Moisture Barrier Fully Encapsulates All Foam Areas
- Double Needle Stitching Standard (Welting Optional - No Charge)
- Exposed Wood Legs: Solid Hardwood / Removable For Maintenance
- Leather Upholstery Not Available
- Lifetime Warranty

**OPTIONS:**

- ARL Brushed Aluminum Round Legs (Set Of 4).....\$353
- PM1 Power/Data Module (1-Power / 1-USB 2 Port Simplex Charger) .....\$836
- 24HA 24" High Arms For Bench .....\$77 Per Arm

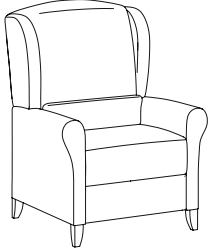
Feather Down & Polyester Pillows Available (See Page 5)  
Specify Exposed Wood Finish (See Page 6)

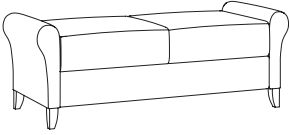
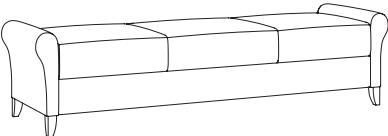
LOUNGE / BENCHES		ITEM #:	SPECIFICATIONS   GRADES   LIST PRICES:												
			<b>Overall:</b> 31" w 32" d 42" h			<b>Arm:</b> 24" h			<b>COM:</b> 6.25 yds.						
			<b>Seat:</b> 21" w 20" d 18.5" h			<b>Weight:</b> 115 lbs.			<b>COL:</b> n/a						
			<b>COM</b>	<b>COL</b>	<b>1</b>	<b>2</b>	<b>3</b>	<b>4</b>	<b>5</b>	<b>6</b>	<b>7</b>	<b>8</b>	<b>9</b>	<b>10</b>	<b>L1</b>
	<b>1815</b>	1663	N/A	1902	2067	2232	2397	2562	2727	2891	3056	3221	3386	N/A	N/A
		<i>Tight Seat &amp; Back / Adjustable Semi-Attached Pillow-Lumbar / Removable Upholstery</i>													
	<b>1815-R</b>	272	N/A	574	732	890	1048	1206	1364	1522	1680	1838	1996	N/A	N/A
		<i>Replacement Upholstery Covers</i>													
			<b>Overall:</b> 22" w 18" d 15" h			<b>Arm:</b> n/a			<b>COM:</b> 1.75 yds.						
			<b>Seat:</b> 15" h			<b>Weight:</b> 18 lbs.			<b>COL:</b> n/a						
			<b>COM</b>	<b>COL</b>	<b>1</b>	<b>2</b>	<b>3</b>	<b>4</b>	<b>5</b>	<b>6</b>	<b>7</b>	<b>8</b>	<b>9</b>	<b>10</b>	<b>L1</b>
	<b>1816</b>	528	N/A	582	623	664	705	747	788	829	870	912	953	N/A	N/A
		<i>Tight Seat / Removable Upholstery</i>													
	<b>1816-R</b>	105	N/A	182	223	264	306	347	388	429	471	512	553	N/A	N/A
		<i>Replacement Upholstery Covers</i>													
			<b>Overall:</b> 56" w 23" d 20" h			<b>Arm:</b> 20" h			<b>COM:</b> 4 yds.						
			<b>Seat:</b> 18" h			<b>Weight:</b> 90 lbs.			<b>COL:</b> n/a						
			<b>COM</b>	<b>COL</b>	<b>1</b>	<b>2</b>	<b>3</b>	<b>4</b>	<b>5</b>	<b>6</b>	<b>7</b>	<b>8</b>	<b>9</b>	<b>10</b>	<b>L1</b>
	<b>1818</b>	1561	N/A	1682	1785	1888	1991	2094	2197	2300	2403	2506	2610	N/A	N/A
		<i>Tight Seat &amp; Back / Removable Upholstery</i>													
	<b>1818-R</b>	181	N/A	378	481	584	687	790	893	996	1099	1202	1305	N/A	N/A
		<i>Replacement Upholstery Covers</i>													
			<b>Overall:</b> 81" w 23" d 20" h			<b>Arm:</b> 20" h			<b>COM:</b> 5.25 yds.						
			<b>Seat:</b> 18" h			<b>Weight:</b> 115 lbs.			<b>COL:</b> n/a						
			<b>COM</b>	<b>COL</b>	<b>1</b>	<b>2</b>	<b>3</b>	<b>4</b>	<b>5</b>	<b>6</b>	<b>7</b>	<b>8</b>	<b>9</b>	<b>10</b>	<b>L1</b>
	<b>1819</b>	2073	N/A	2235	2372	2509	2647	2784	2922	3059	3197	3334	3472	N/A	N/A
		<i>Tight Seat &amp; Back / Removable Upholstery</i>													
	<b>1819-R</b>	219	N/A	481	619	756	894	1031	1169	1306	1444	1581	1719	N/A	N/A
		<i>Replacement Upholstery Covers</i>													

LEGS / ARMS / POWER / COVERS	OPTION #:	SPECIFICATIONS   LIST PRICES   AVAILABILITY:
<p><b>BRUSHED ALUMINUM ROUND LEGS</b></p> 	<p><b>ARL</b></p>	<p><b>Overall:</b> 2" Diameter 5"h</p> <hr/> <p>\$353 (Set Of 4) <i>(Brushed Aluminum Finish)</i></p> <p><b>Available:</b> <i>Facelift 2 Revival Collection</i></p>
<p><b>24" HIGH ARMS</b></p> 	<p><b>24HA</b></p>	<p><b>Overall:</b> 5"w 23"d 24"h</p> <hr/> <p>\$77 (Per Arm) <i>24" High Arms For Bench (Specify Fabric)</i></p> <p><b>Available:</b> <i>Facelift 2 Revival Benches</i></p>
<p><b>POWER / DATA MODULE</b></p> 	<p><b>PM1</b></p>	<p><b>Overall:</b> 5.25"w 1.25"d 4.25"h</p> <hr/> <p>\$836 (1-Power / 1-USB 2 Port Simplex Charger Standard) <i>Vertical / Horizontal Mount Power Module. Price Varies By Socket. Contact Customer Service For Quote. (Additional Colors Available)</i></p> <p><b>Available:</b> <i>Facelift 2 Revival Collection</i></p>
<p><b>CONTRASTING COVERS</b></p> 	<p><b>CC</b></p>	<p><b>Overall:</b> N/A</p> <hr/> <p>\$129 <i>NOTE: If Two Or More Upholsteries Or Leathers Are Used On Any Piece Of Furniture, Then A Contrast Charge Will Apply Per Order. When Using Trinity Upholstery, The Higher Priced Upholstery Grade Will Be Used In Pricing, Unless It's Trinity Leather With Fabric Contrast Welt, Or COM With Trinity Contrast Welt, Then Contact Customer Service For Pricing.</i></p> <p><b>Available:</b> <i>Facelift 2 Revival Collection</i></p>



# Facelift Revival

---

HEALTHCARE MOTION

Effective: August 1, 2022

T R I N I T Y

**Date:**

**Page:**

**Modification:**

**Description:**

---

### DESCRIPTION:





- Upholstery Frames: Steel, Plywood & Hardwood
- Seat: High Density Polyurethane Foam Over Sheet Webbing
- Back: High Density Polyurethane Foam Over Polypropylene Webbing
- Upholstered Covers: Attached w/ Velcro / Removable For Maintenance
- Removable Bolster Pillow For 1804 / 1805 (5" Diameter)
- Antimicrobial Moisture Barrier Fully Encapsulates All Foam Areas
- Double Needle Stitching Standard (Welting Optional - No Charge)
- Metal To Metal Connections For All Hardware Assembly
- Leather Upholstery Not Available
- Lifetime Warranty

### OPTIONS:

- ILC In-Line Casters (Set Of 2).....\$57
- LC Locking Casters (Set Of 2) .....\$31
- NLC Non-Locking Casters (Set Of 2).....\$26
- 3LC 3" Locking Casters - #1806 Model Only (Set Of 2).....\$208
- PM1 Power/Data Module (1-Power / 1-USB 2 Port Simplex Charger) .....\$836

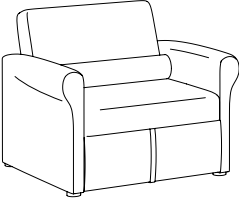
Feather Down & Polyester Pillows Available (See Page 5)  
Specify Exposed Wood Finish (See Page 6)

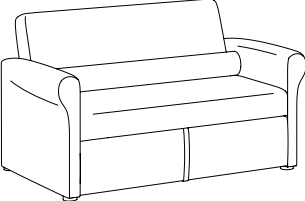
### SLEEPOVER UNITS

ITEM #:	SPECIFICATIONS   GRADES   LIST PRICES:													
<b>LOUNGE CHAIR / FULLY UPHOLSTERED</b>    	<b>Overall:</b> 40"w 34.5"d 33"h				<b>Overall Length:</b> 84"d				<b>Arm:</b> 24"h		<b>COM:</b> 6.5 yds.			
	<b>Sleep Area:</b> 28"w 80"d				<b>Seat:</b> 28"w 23"d 17.5"h				<b>Weight:</b> 175 lbs.		<b>COL:</b> n/a			
	<b>COM</b>	<b>COL</b>	<b>1</b>	<b>2</b>	<b>3</b>	<b>4</b>	<b>5</b>	<b>6</b>	<b>7</b>	<b>8</b>	<b>9</b>	<b>10</b>	<b>L1</b>	<b>L2</b>
<b>1804</b>	N/A	4540	4712	4883	5055	5227	5399	5571	5742	5914	6086	N/A	N/A	
<i>Tight Seat &amp; Back / Removable Upholstery / 500 lb. Weight Capacity</i>														
<b>1804-R</b>	N/A	592	764	936	1108	1280	1451	1623	1795	1967	2139	N/A	N/A	
<i>Replacement Upholstery Covers</i>														
<b>TWO PLACE SOFA / FULLY UPHOLSTERED</b>    	<b>Overall:</b> 60"w 34.5"d 33"h				<b>Overall Length:</b> 84"d				<b>Arm:</b> 24"h		<b>COM:</b> 9 yds.			
	<b>Sleep Area:</b> 48"w 80"d				<b>Seat:</b> 48"w 23"d 17.5"h				<b>Weight:</b> 225 lbs.		<b>COL:</b> n/a			
	<b>COM</b>	<b>COL</b>	<b>1</b>	<b>2</b>	<b>3</b>	<b>4</b>	<b>5</b>	<b>6</b>	<b>7</b>	<b>8</b>	<b>9</b>	<b>10</b>	<b>L1</b>	<b>L2</b>
<b>1805</b>	N/A	5802	6043	6283	6524	6764	7005	7245	7486	7726	7967	N/A	N/A	
<i>Tight Seat &amp; Back / Removable Upholstery / 500 lb. Weight Capacity</i>														
<b>1805-R</b>	N/A	777	1018	1258	1499	1739	1980	2220	2461	2701	2942	N/A	N/A	
<i>Replacement Upholstery Covers</i>														

### FOUR POSITION ADJUSTMENT FOR 1804 / 1805

 See Replay Healthcare Motion And Evolve Healthcare Motion For Additional Sleeper Units.



1) Closed Position



2) Ottoman Position



3) Chaise Position



4) Full-Recline Position  
Overall Length - 84"d

### BACK-FLIP SLEEPER SOFA

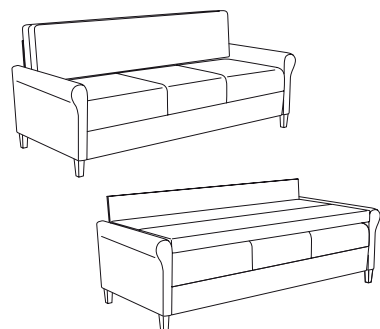

<b>Overall:</b> 80"w 36"d 36"h				<b>Arm:</b> 24.5"h				<b>COM:</b> 12.75 yds.					
<b>Sleep Area:</b> 70"w 31"d 20"h				<b>Weight:</b> 235 lbs.				<b>COL:</b> n/a					
<b>COM</b>	<b>COL</b>	<b>1</b>	<b>2</b>	<b>3</b>	<b>4</b>	<b>5</b>	<b>6</b>	<b>7</b>	<b>8</b>	<b>9</b>	<b>10</b>	<b>L1</b>	<b>L2</b>
<b>1806</b>	N/A	4504	4848	5191	5535	5879	6222	6566	6910	7253	7597	N/A	N/A
<i>Tight Seat &amp; Back / Removable Upholstery / 1000 lbs. Weight Capacity</i>													
<b>1806-R</b>	N/A	1662	2005	2349	2692	3036	3380	3723	4067	4410	4754	N/A	N/A
<i>Replacement Upholstery Covers</i>													







**DESCRIPTION:**

- Upholstery Frames: Steel, Plywood & Hardwood
- Seat: High Density Polyurethane Foam Over Sheet Webbing
- Back: High Density Polyurethane Foam Over Polypropylene Webbing
- Upholstered Covers: Attached w/ Velcro / Removable For Maintenance
- Antimicrobial Moisture Barrier Fully Encapsulates All Foam Areas
- Double Needle Stitching Standard (Wetling Optional - No Charge)
- Exposed Wood Legs: Solid Hardwood / Removable For Maintenance
- Leather Upholstery Not Available
- Lifetime Warranty

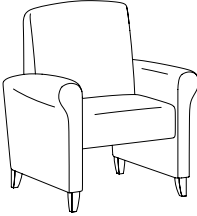
**OPTIONS:**

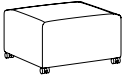
- ARL Brushed Aluminum Round Legs (Set Of 4).....\$353
- LC Locking Casters For 1809 Ottoman (Set Of 2) .....\$31
- WR Wood Ring Base - Replaces Metal Base On 1810-G/1810-SG .....\$224
- PM1 Power/Data Module (1-Power / 1-USB 2 Port Simplex Charger) .....\$836

Feather Down & Polyester Pillows Available (See Page 5)  
Specify Exposed Wood Finish (See Page 6)

PATIENT CHAIR / GLIDER		ITEM #:	SPECIFICATIONS   GRADES   LIST PRICES:													
		<b>1808</b>	<b>Overall:</b> 32.5"w 35.5"d 38"h			<b>Arm:</b> 24"h			<b>COM:</b> 5.25 yds.							
			<b>Seat:</b> 21"w 20"d 18"h			<b>Weight:</b> 63 lbs.			<b>COL:</b> n/a							
			<b>COM</b>	<b>COL</b>	<b>1</b>	<b>2</b>	<b>3</b>	<b>4</b>	<b>5</b>	<b>6</b>	<b>7</b>	<b>8</b>	<b>9</b>	<b>10</b>	<b>L1</b>	<b>L2</b>
			1639	N/A	1868	2027	2186	2345	2504	2663	2822	2981	3140	3299	N/A	N/A
			<i>Tight Seat &amp; Back / Removable Upholstery</i>													
		<b>1808-R</b>	195	N/A	459	597	734	872	1009	1147	1284	1422	1559	1696	N/A	N/A
			<i>Replacement Upholstery Covers</i>													
																
		<b>1809</b>	<b>Overall:</b> 18"w 18"d 11"h			<b>Arm:</b> n/a			<b>COM:</b> 1 yd.							
			<b>Seat:</b> n/a			<b>Weight:</b> 25 lbs.			<b>COL:</b> n/a							
			<b>COM</b>	<b>COL</b>	<b>1</b>	<b>2</b>	<b>3</b>	<b>4</b>	<b>5</b>	<b>6</b>	<b>7</b>	<b>8</b>	<b>9</b>	<b>10</b>	<b>L1</b>	<b>L2</b>
			368	N/A	389	410	430	451	472	492	513	534	554	575	N/A	N/A
			<i>Removable Upholstery</i>													
		<b>1809-R</b>	81	N/A	118	139	159	180	201	221	242	262	283	304	N/A	N/A
			<i>Replacement Upholstery Covers</i>													
																
		<b>1810-G</b>	<b>Overall:</b> 32"w 32"d 35"h			<b>Arm:</b> 24"h			<b>COM:</b> 4.75 yds.							
			<b>Seat:</b> 21"w 20"d 18"h			<b>Weight:</b> 115 lbs.			<b>COL:</b> n/a							
			<b>COM</b>	<b>COL</b>	<b>1</b>	<b>2</b>	<b>3</b>	<b>4</b>	<b>5</b>	<b>6</b>	<b>7</b>	<b>8</b>	<b>9</b>	<b>10</b>	<b>L1</b>	<b>L2</b>
			1777	N/A	1927	2051	2175	2299	2422	2546	2670	2793	2917	3041	N/A	N/A
			<i>Circular Metal Base / Tight Seat &amp; Back / Removable Upholstery</i>													
		<b>1810-SG</b>	1951	N/A	2048	2172	2296	2420	2543	2667	2791	2914	3038	3162	N/A	N/A
			<i>Swivel Glider w/ Circular Metal Base / Tight Seat &amp; Back / Removable Upholstery</i>													
		<b>1810-GR</b>	227	N/A	462	586	709	833	957	1081	1204	1328	1452	1575	N/A	N/A
			<i>Replacement Upholstery Covers</i>													
																
		<p>See Replay Healthcare Motion And Evolve Healthcare Motion For Additional Patient Chairs &amp; Gliders.</p>														







**DESCRIPTION:**

- Upholstery Frames: Steel, Plywood & Hardwood
- Seat: High Density Polyurethane Foam Over Sheet Webbing
- Back: High Density Polyurethane Foam Over Sinuous Wire Springs
- Upholstered Covers: Attached w/ Velcro / Removable For Maintenance
- Antimicrobial Moisture Barrier Fully Encapsulates All Foam Areas
- Double Needle Stitching Standard (Wetling Optional - No Charge)
- Leather Upholstery Not Available
- Lifetime Warranty

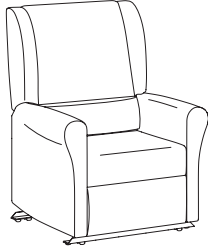
**OPTIONS:**

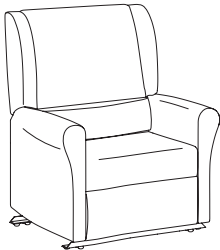
- ER-1 Electric Recline .....\$1048
- BB Battery Backup .....\$529
- HM Heat & Massage .....\$1500
- H Heat Only .....\$1339

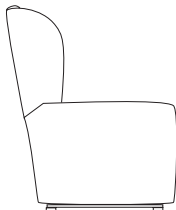
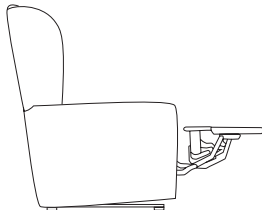
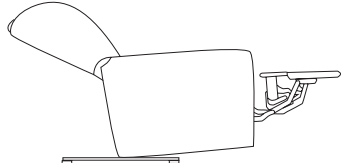
Feather Down & Polyester Pillows Available (See Page 5)  
Specify Exposed Wood Finish (See Page 6)

WALLSAVER		ITEM #:	SPECIFICATIONS   GRADES   LIST PRICES:													
	<b>WALLSAVER RECLINER / FULLY UPHOLSTERED</b>		<b>Overall:</b> 31.5"w 34"d 42.25"h <b>Seat:</b> 21"w 21.75"d 18"h			<b>Arm:</b> 23"h <b>Weight:</b> 115 lbs.			<b>COM:</b> 6.25 yds. <b>COL:</b> n/a							
			<b>COM</b>	<b>COL</b>	<b>1</b>	<b>2</b>	<b>3</b>	<b>4</b>	<b>5</b>	<b>6</b>	<b>7</b>	<b>8</b>	<b>9</b>	<b>10</b>	<b>L1</b>	<b>L2</b>
	<b>1811</b>		2242	N/A	2502	2693	2883	3074	3265	3456	3647	3838	4029	4220	N/A	N/A
			<i>Tight Seat &amp; Back / Removable Upholstery / Adjustable Semi-Attached Pillow-Lumbar / 6" Wall Proximity / 350 lb. Weight Capacity</i>													
		<b>1811-R</b>	256	N/A	572	737	901	1066	1231	1396	1561	1726	1891	2056	N/A	N/A
			<i>Replacement Upholstery Covers</i>													
																
	<b>BARIATRIC WALLSAVER RECLINER / FULLY UPHOLSTERED</b>		<b>Overall:</b> 36.5"w 34"d 42.25"h <b>Seat:</b> 26"w 21.75"d 18"h			<b>Arm:</b> 23"h <b>Weight:</b> 125 lbs.			<b>COM:</b> 6.75 yds. <b>COL:</b> n/a							
			<b>COM</b>	<b>COL</b>	<b>1</b>	<b>2</b>	<b>3</b>	<b>4</b>	<b>5</b>	<b>6</b>	<b>7</b>	<b>8</b>	<b>9</b>	<b>10</b>	<b>L1</b>	<b>L2</b>
	<b>1811-X</b>		2323	N/A	2610	2817	3023	3230	3437	3644	3851	4057	4264	4471	N/A	N/A
			<i>Tight Seat &amp; Back / Removable Upholstery / Adjustable Semi-Attached Pillow-Lumbar / 6" Wall Proximity / 500 lb. Weight Capacity</i>													
		<b>1811-XR</b>	262	N/A	577	742	907	1072	1237	1402	1567	1732	1897	2062	N/A	N/A
			<i>Replacement Upholstery Covers</i>													
																
																
			Upright Position 34"D			Extended Footrest Position 57.5"D			Full Recline Position 67"D							
			See Replay Healthcare Motion And Evolve Healthcare Motion For Additional WallSaver Recliners.													

**DESCRIPTION:**

- Upholstery Frames: Steel, Plywood & Hardwood
- Seat: High Density Polyurethane Foam Over Sheet Webbing
- Back: High Density Polyurethane Foam Over Sinuous Wire Springs
- Upholstered Covers: Attached w/ Velcro / Removable For Maintenance
- Antimicrobial Moisture Barrier Fully Encapsulates All Foam Areas
- Double Needle Stitching Standard (Wetling Optional - No Charge)
- Dual-Wheel Casters: (2) Front Locking/Swivel & (2) Rear Non-Locking/Non-Swivel (1514)
- (2) Drop Down Side Trays Mounted To Black Metal Tubing (1514)
- Exposed Wood Legs (1812): Solid Hardwood / Removable For Maintenance
- Leather Upholstery Not Available
- Lifetime Warranty

**OPTIONS:**

(See Facelift Revival Healthcare Options Pages)  
 Feather Down & Polyester Pillows Available (See Page 5)

**INFUSION / STAND-UP RECLINER**

ITEM #:

SPECIFICATIONS | GRADES | LIST PRICES:

**INFUSION WALLSAVER RECLINER / FULLY UPHOLSTERED**

**Overall:** 31.25"w 34"d 46"h      **Arm:** 27"h      **COM:** 6.5 yds.  
**Seat:** 21"w 20.5"d 19"h      **Weight:** 130 lbs.      **COL:** n/a

COM	COL	1	2	3	4	5	6	7	8	9	10	L1	L2
1814	N/A	3176	3358	3540	3722	3904	4085	4267	4449	4631	4813	N/A	N/A
<i>Tight Seat &amp; Back / Removable Upholstery / 350 lb. Weight Capacity</i>													
1814-R	N/A	554	699	843	987	1132	1276	1420	1565	1709	1853	N/A	N/A
<i>Replacement Upholstery Covers</i>													



Optional Central Braking Available

Healthcare Motion

See Replay & Evolve Healthcare Motion For Additional Infusion WallSaver Recliners.



Upright Position  
32"D



Extended Footrest Position  
52"D



Full Recline Position  
64.5"D

**ELECTRIC STAND-UP RECLINER / FULLY UPHOLSTERED**

**Overall:** 35"w 35"d 42"h      **Arm:** 24.5"h      **COM:** 5.25 yds.  
**Seat:** 21.5"w 21.75"d 18"h      **Weight:** 145 lbs.      **COL:** n/a

COM	COL	1	2	3	4	5	6	7	8	9	10	L1	L2
1812	N/A	3457	3616	3775	3934	4093	4252	4411	4570	4729	4888	N/A	N/A
<i>Tight Seat &amp; Back / Removable Upholstery / 350 lb. Weight Capacity</i>													
1812-R	N/A	529	666	803	941	1078	1216	1353	1491	1628	1766	N/A	N/A
<i>Replacement Upholstery Covers</i>													

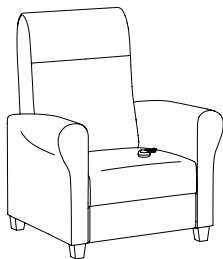

Healthcare Motion

See Replay Healthcare Motion For Additional Electric Stand-Up Recliner.

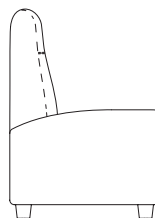

Upright Position  
35"D

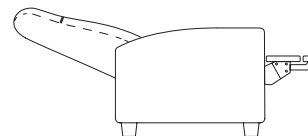

Full Recline Position  
66"D

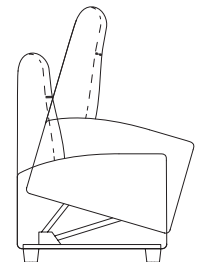

Stand-Up Position  
59"H

**DESCRIPTION:**

- Upholstery Frames: Steel, Plywood & Hardwood
- Seat: High Density Polyurethane Foam Over Sheet Webbing
- Back: High Density Polyurethane Foam Over Sinuous Wire Springs
- Upholstered Covers: Attached w/ Velcro / Removable For Maintenance
- Antimicrobial Moisture Barrier Fully Encapsulates All Foam Areas
- Double Needle Stitching Standard (Welting Optional - No Charge)
- Rotational & Directional Locking Casters (Rear)
- Leather Upholstery Not Available
- Lifetime Warranty

**OPTIONS:**

- Layflat Medical Recliner Options (See Revival Healthcare Options Pages)
- Feather Down & Polyester Pillows Available (See Page 5)

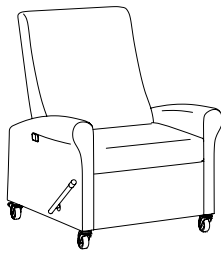
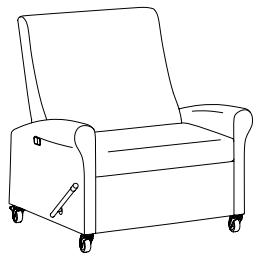
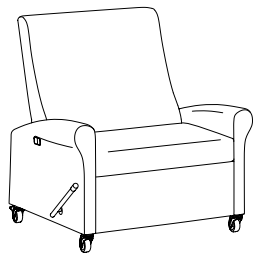
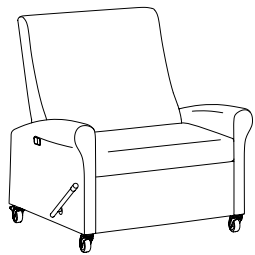
LAYFLAT MEDICAL RECLINER		ITEM #:	SPECIFICATIONS   GRADES   LIST PRICES:														
		<b>LAYFLAT / TRENDELENBURG RECLINER</b>	<b>Overall:</b> 35"w 38.5"d 45"h <b>Seat:</b> 24"w 20"d 20"h			<b>Arm:</b> 28"h <b>Weight:</b> 160 lbs.			<b>COM:</b> 5.5 yds. <b>COL:</b> n/a								
			<b>COM</b>	<b>COL</b>	<b>1</b>	<b>2</b>	<b>3</b>	<b>4</b>	<b>5</b>	<b>6</b>	<b>7</b>	<b>8</b>	<b>9</b>	<b>10</b>	<b>L1</b>	<b>L2</b>	
			<b>1813-L</b>	3494	N/A	3638	3805	3972	4139	4306	4473	4640	4807	4974	5141	N/A	N/A
			<i>Layflat / Tight Seat &amp; Back / Removable Upholstery / 500 lb. Weight Capacity</i>														
		<b>BARIATRIC LAYFLAT / TRENDELENBURG RECLINER</b>	<b>Overall:</b> 40"w 38.5"d 45"h <b>Seat:</b> 29"w 20"d 20"h			<b>Arm:</b> 28"h <b>Weight:</b> 185 lbs.			<b>COM:</b> 6.25 yds. <b>COL:</b> n/a								
			<b>COM</b>	<b>COL</b>	<b>1</b>	<b>2</b>	<b>3</b>	<b>4</b>	<b>5</b>	<b>6</b>	<b>7</b>	<b>8</b>	<b>9</b>	<b>10</b>	<b>L1</b>	<b>L2</b>	
			<b>1813-XL</b>	3677	N/A	3858	4049	4240	4431	4622	4813	5004	5195	5386	5577	N/A	N/A
			<i>Layflat / Tight Seat &amp; Back / Removable Upholstery / 600 lb. Weight Capacity</i>														
		<b>BARIATRIC LAYFLAT / TRENDELENBURG RECLINER</b>	<b>Overall:</b> 40"w 38.5"d 45"h <b>Seat:</b> 29"w 20"d 20"h			<b>Arm:</b> 28"h <b>Weight:</b> 185 lbs.			<b>COM:</b> 6.25 yds. <b>COL:</b> n/a								
			<b>COM</b>	<b>COL</b>	<b>1</b>	<b>2</b>	<b>3</b>	<b>4</b>	<b>5</b>	<b>6</b>	<b>7</b>	<b>8</b>	<b>9</b>	<b>10</b>	<b>L1</b>	<b>L2</b>	
			<b>1813-XT</b>	3845	N/A	4018	4208	4399	4590	4781	4972	5163	5354	5545	5736	N/A	N/A
			<i>Trendelenburg / Tight Seat &amp; Back / Removable Upholstery / 600 lb. Weight Capacity</i>														
		<b>BARIATRIC LAYFLAT / TRENDELENBURG RECLINER</b>	<b>Overall:</b> 40"w 38.5"d 45"h <b>Seat:</b> 29"w 20"d 20"h			<b>Arm:</b> 28"h <b>Weight:</b> 185 lbs.			<b>COM:</b> 6.25 yds. <b>COL:</b> n/a								
			<b>COM</b>	<b>COL</b>	<b>1</b>	<b>2</b>	<b>3</b>	<b>4</b>	<b>5</b>	<b>6</b>	<b>7</b>	<b>8</b>	<b>9</b>	<b>10</b>	<b>L1</b>	<b>L2</b>	
			<b>1813-XR</b>	309	N/A	581	725	869	1014	1158	1302	1447	1591	1735	1880	N/A	N/A
			<i>Replacement Upholstery Covers</i>														

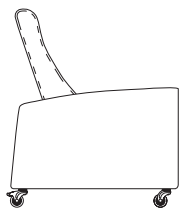

Upright Position  
38.5"D

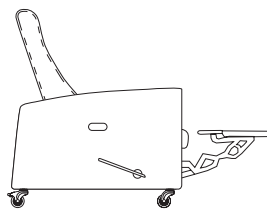

Extended Footrest Position  
57.5"D

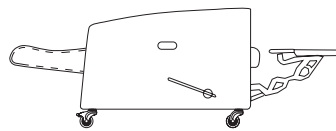

Layflat Position  
73.75"D

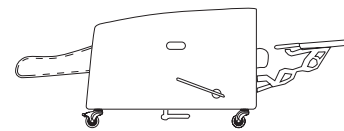







Trendelenburg Position  
74.75"D

See *Replay Healthcare Motion* (Page 176)  
 And *Evolve Healthcare Motion* (Page 290)  
 For Additional Layflat Medical Recliners.

CASTERS / POWER	OPTION #:	SPECIFICATIONS   LIST PRICES   AVAILABILITY:
<p><b>IN-LINE CASTERS</b></p> 	<p><b>ILC</b></p> <p>\$57 (Set Of Two) Single Direction In-Line Caster (Non-Locking / Specify Wood Finish / Specify Location)</p> <p><b>Available: Facelift 2 Revival Sleepover Lounge</b></p>	
<p><b>LOCKING / NON-LOCKING CASTERS</b></p>  <p>Locking Casters</p> <p>Non-Locking Casters</p>	<p><b>LC</b></p> <p>\$31 (Set Of Two) Locking Casters (Black Finish / Specify Location)</p> <p><b>NLC</b></p> <p>\$26 (Set Of Two) Non-Locking Casters (Black Finish / Specify Location)</p> <p><b>Available: Facelift 2 Revival Sleepover Lounge</b></p>	
<p><b>MEDICAL LOCKING / NON-LOCKING CASTERS</b></p>  <p>Locking Casters</p> <p>Non-Locking Casters</p>	<p><b>MLC</b></p> <p>\$179 (Set Of Two) Locking Casters - Motion &amp; Direction (Gray Finish / Specify Location)</p> <p><b>MNLC</b></p> <p>\$205 (Set Of Two) Non-Locking Casters - Single Direction (Gray Finish / Specify Location)</p> <p><b>Available: Facelift 2 Revival Electric Standup Recliner</b></p>	
<p><b>POWER / DATA MODULE</b></p> 	<p><b>PM1</b></p> <p>\$836 (1-Power / 1-USB 2 Port Simplex Charger Standard) Vertical / Horizontal Mount Power Module. Price Varies By Socket. Contact Customer Service For Quote. (Additional Colors Available)</p> <p><b>Available: Facelift 2 Revival Sleepover Lounge</b></p>	



BRAKE / LEGS / ELECTRIC / PUSH BAR	OPTION #:	SPECIFICATIONS   LIST PRICES   AVAILABILITY:
<p><b>CENTRAL BRAKING</b></p> 	<p><b>Overall:</b> 7.5"w 2"d .5"h</p> <hr/> <p><b>CB-1</b> \$405 (Set Of 1) <i>(White Plastic Brake w/ Lock &amp; Unlock Pedals)</i></p> <p><b>Available:</b> <i>Facelift Revival Wallsaver &amp; Infusion Wallsaver Recliners</i></p>	
<p><b>ALUMINUM ROUND LEGS</b></p> 	<p><b>Overall:</b> 2" Diameter 5"h</p> <hr/> <p><b>ARL</b> \$353 (Set Of 4) <i>(Brushed Aluminum Finish)</i></p> <p><b>Available:</b> <i>Facelift 2 Revival Asynchronous Patient Chair (1808 Model)</i></p>	
<p><b>ELECTRIC RECLINE / BATTERY BACKUP / HEAT / MASSAGE</b></p>  <p>ER-1 Electric Recline (Wallsaver Model)</p> <p>ER-2/ER-3 Electric Recline (Layflat Model)</p> <p>BB \$529 Battery Backup <i>Allows Any Wallsaver, Layflat, Or Standup Electric Recliner To Be Cordless - Surface Mounts On Inside Arm (Specify Left Or Right Facing)</i></p> <p>HM \$1500 Heat &amp; Massage <i>Add Heat &amp; Massage To Any Wallsaver, Layflat, Or Standup Electric Recliner - Surface Mounts On Inside Arm (Specify Left Or Right Facing)</i></p> <p>H \$1339 Heat <i>Add Heat Only To Any Wallsaver, Layflat, Or Standup Electric Recliner - Surface Mounts On Inside Arm (Specify Left Or Right Facing)</i></p>	<p><b>Overall:</b> N/A</p> <hr/> <p><b>ER-1</b> \$1048 Electric Recline <i>Replaces Manual Mechanism On Any Wallsaver Model - Surface Mounts On Inside Arm (Specify Left Or Right Facing)</i></p> <p><b>ER-2</b> \$1084 Electric Recline <i>Replaces Manual Mechanism On Any Layflat Model - Surface Mounts On Inside Arm (Specify Left Or Right Facing)</i></p> <p><b>ER-3</b> \$1474 Electric Recline <i>Replaces Manual Mechanism On Any Trendelenburg Layflat Model - Surface Mounts On Inside Arm (Specify Left Or Right Facing)</i></p> <p><b>BB</b> \$529 Battery Backup <i>Allows Any Wallsaver, Layflat, Or Standup Electric Recliner To Be Cordless - Surface Mounts On Inside Arm (Specify Left Or Right Facing)</i></p> <p><b>HM</b> \$1500 Heat &amp; Massage <i>Add Heat &amp; Massage To Any Wallsaver, Layflat, Or Standup Electric Recliner - Surface Mounts On Inside Arm (Specify Left Or Right Facing)</i></p> <p><b>H</b> \$1339 Heat <i>Add Heat Only To Any Wallsaver, Layflat, Or Standup Electric Recliner - Surface Mounts On Inside Arm (Specify Left Or Right Facing)</i></p> <p><b>Available:</b> <i>Facelift Revival Recliners</i></p>	
<p><b>PUSH BAR</b></p> 	<p><b>Overall:</b> 18.5"w 3.5"d 1"h</p> <hr/> <p><b>PB</b> \$240 <i>(Black Finish)</i></p> <p><b>Available:</b> <i>Facelift 2 Revival Medical Recliners</i></p>	

I.V. / SIDE TRAY / BAG HOLDER / RESTRAINT BUCKLE / FOOTREST	OPTION #:	SPECIFICATIONS   LIST PRICES   AVAILABILITY:
<p>I.V. POLE</p> 	<p><b>IV</b></p> <p><b>Overall:</b> 10"w 2.5"d 39.5" / 69.75"h</p> <hr/> <p><b>\$471</b>  <i>Height Adjustable I.V. Pole (Chrome &amp; Black Finish / Specify Left Or Right Facing Location)</i></p> <p><b>Available: Facelift 2 Revival Medical Recliners</b></p>	
<p>SIDE TRAY</p> 	<p><b>Overall:</b> 12.75"w 10"d 4"h (Small Side Tray) / 17"w 10"d 4"h (Large Side Tray)</p> <hr/> <p><b>ST-1</b> <b>\$245</b>  <i>Drop-Down Side Tray (Small Side Tray)</i></p> <p><b>ST-2</b> <b>\$335</b>  <i>Drop-Down Side Tray (Large Side Tray)</i></p> <p><b>Available: Facelift 2 Revival Medical Recliners</b>  <i>Note: If A Medical Recliner With A Manual Mechanism Is Selected, The Standard Side Tray Location Will Be Front Right Facing</i></p>	
<p>BAG HOLDER / PERSONAL RESTRAINT BUCKLE</p> 	<p><b>Overall:</b> 2.19"w .38"d 2.56"h</p> <hr/> <p><b>BH</b> <b>\$65</b>  <i>Bag Holder (Brushed Finish / Specify Left Or Right Facing Location)</i></p> <p><b>RB</b> <b>\$117 (Set Of 2)</b>  <i>Personal Restraint Buckle (Brushed Finish)</i></p> <p><b>Available: Facelift 2 Revival Medical Recliners</b></p>	
<p>FOOTREST</p> 	<p><b>Overall:</b> 16"w 8"d .1875"h</p> <hr/> <p><b>FR</b> <b>\$360</b>  <i>(Black Finish)</i></p> <p><b>Available: Facelift 2 Revival Medical Recliners</b></p>	

OXYGEN TANK HOLDER / WOOD RING BASE / COVERS	OPTION #:	SPECIFICATIONS   LIST PRICES   AVAILABILITY:
<p>OXYGEN TANK HOLDER</p> 	<p><b>OH</b></p> <p><b>\$238</b>  <i>Black Metal Oxygen Tank Holder Holds a 4.375" Diameter Oxygen Tank (Not Included) (Specify Left Or Right Facing Location)</i></p> <p><i>Available: Facelift 3 Revival Medical Recliners</i></p>	
<p>LOUNGE GLIDER WOOD RING BASE</p> 	<p><b>WR</b></p> <p><b>\$224</b>  <i>Wood Ring Base replaces circular metal base (1810-G) or swivel glider w/ circular metal base (1810-SG).</i></p> <p><i>Specify Exposed Wood Finish. (See Page 6)</i></p> <p><i>Available: Facelift Revival Lounge Glider</i></p>	
<p>CONTRASTING COVERS</p> 	<p><b>CC</b></p> <p><b>\$129</b>  <i>NOTE: If Two Or More Upholsteries Or Leathers Are Used On Any Piece Of Furniture, Then A Contrast Charge Will Apply Per Order. When Using Trinity Upholstery, The Higher Priced Upholstery Grade Will Be Used In Pricing, Unless It's Trinity Leather With Fabric Contrast Welt, Or COM With Trinity Contrast Welt, Then Contact Customer Service For Pricing.</i></p> <p><i>Available: Facelift 2 Revival Healthcare Motion</i></p>	

# Facelift Evolve

---

GUEST / TANDEM / TABLES

Effective: August 1, 2022

T R I N I T Y

**Date:**

**Page:**

**Modification:**

**Description:**

---

**DESCRIPTION:**

- Upholstery Frames: Steel, Plywood & Hardwood
- Seat: High Density Polyurethane Foam Over Strap Webbing
- Back: High Density Polyurethane Foam Over Plywood
- Upholstered Covers: Attached w/ Velcro / Removable For Maintenance
- Exposed Wood Legs: Solid Hardwood / Removable For Maintenance / Wallsaver Legs
- Antimicrobial Moisture Barrier Fully Encapsulates All Foam Areas
- Leather Upholstery Not Available
- Adjustable Height Leveling Glides Standard
- Lifetime Warranty

**OPTIONS:**

- Closed Arm Panels (See 1800-PL / 1800-PR Item #'s)
- Specify Exposed Wood Finish (See Page 6)

*NOTE: All Seating Configurations Are Viewed From Left To Right Facing. Please Attach A Layout Showing Seating Configuration w/ Your Order. Assembled Units Must Be Shipped In Configurations Of 3 Or Less.*

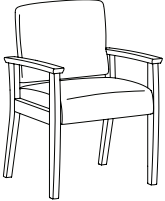
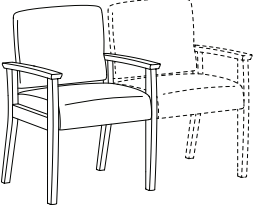
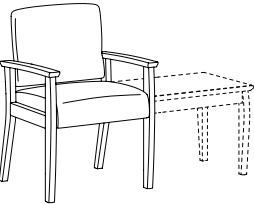
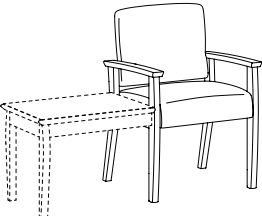
GUEST / TANDEM		ITEM #:	SPECIFICATIONS   GRADES   LIST PRICES:													
	<b>ARM SIDE CHAIR / WOOD ARMS</b>		<b>Overall:</b> 23.5"w 24"d 34"h <b>Seat:</b> 20"w 19"d 18.5"h			<b>Arm:</b> 25"h <b>Weight:</b> 45 lbs.			<b>COM:</b> 1.75 yds. <b>COL:</b> n/a							
	<b>1820</b>		<b>COM</b>	<b>COL</b>	<b>1</b>	<b>2</b>	<b>3</b>	<b>4</b>	<b>5</b>	<b>6</b>	<b>7</b>	<b>8</b>	<b>9</b>	<b>10</b>	<b>L1</b>	<b>L2</b>
	<b>1820-R</b>		1162	N/A	1181	1222	1264	1305	1346	1387	1428	1470	1511	1552	N/A	N/A
			<i>Open Back / Tight Seat &amp; Back / Removable Upholstery</i>													
			<i>Replacement Upholstery Covers</i>													
	<b>ARM CHAIR / WOOD ARMS / ACCEPTS SEAT ON RIGHT</b>		<b>Overall:</b> 23.5"w 24"d 34"h <b>Seat:</b> 20"w 19"d 18.5"h			<b>Arm:</b> 25"h <b>Weight:</b> 45 lbs.			<b>COM:</b> 1.75 yds. <b>COL:</b> n/a							
	<b>1820-C</b>		<b>COM</b>	<b>COL</b>	<b>1</b>	<b>2</b>	<b>3</b>	<b>4</b>	<b>5</b>	<b>6</b>	<b>7</b>	<b>8</b>	<b>9</b>	<b>10</b>	<b>L1</b>	<b>L2</b>
	<b>1820-R</b>		1162	N/A	1181	1222	1264	1305	1346	1387	1428	1470	1511	1552	N/A	N/A
			<i>Open Back / Tight Seat &amp; Back / Removable Upholstery</i>													
			<i>Replacement Upholstery Covers</i>													
	<b>ARM CHAIR / WOOD ARMS / ACCEPTS TABLE ON RIGHT</b>		<b>Overall:</b> 23.5"w 24"d 34"h <b>Seat:</b> 20"w 19"d 18.5"h			<b>Arm:</b> 25"h <b>Weight:</b> 45 lbs.			<b>COM:</b> 1.75 yds. <b>COL:</b> n/a							
	<b>1820-T</b>		<b>COM</b>	<b>COL</b>	<b>1</b>	<b>2</b>	<b>3</b>	<b>4</b>	<b>5</b>	<b>6</b>	<b>7</b>	<b>8</b>	<b>9</b>	<b>10</b>	<b>L1</b>	<b>L2</b>
	<b>1820-R</b>		1162	N/A	1181	1222	1264	1305	1346	1387	1428	1470	1511	1552	N/A	N/A
			<i>Open Back / Tight Seat &amp; Back / Removable Upholstery</i>													
			<i>Replacement Upholstery Covers</i>													
	<b>ARM CHAIR / WOOD ARMS / ACCEPTS TABLE ON LEFT</b>		<b>Overall:</b> 23.5"w 24"d 34"h <b>Seat:</b> 20"w 19"d 18.5"h			<b>Arm:</b> 25"h <b>Weight:</b> 45 lbs.			<b>COM:</b> 1.75 yds. <b>COL:</b> n/a							
	<b>1820-LT</b>		<b>COM</b>	<b>COL</b>	<b>1</b>	<b>2</b>	<b>3</b>	<b>4</b>	<b>5</b>	<b>6</b>	<b>7</b>	<b>8</b>	<b>9</b>	<b>10</b>	<b>L1</b>	<b>L2</b>
	<b>1820-R</b>		1162	N/A	1181	1222	1264	1305	1346	1387	1428	1470	1511	1552	N/A	N/A
			<i>Open Back / Tight Seat &amp; Back / Removable Upholstery</i>													
			<i>Replacement Upholstery Covers</i>													

**DESCRIPTION:**

- Upholstery Frames: Steel, Plywood & Hardwood
- Seat: High Density Polyurethane Foam Over Strap Webbing
- Back: High Density Polyurethane Foam Over Plywood
- Upholstered Covers: Attached w/ Velcro / Removable For Maintenance
- Exposed Wood Legs: Solid Hardwood / Removable For Maintenance / Wallsaver Legs
- Antimicrobial Moisture Barrier Fully Encapsulates All Foam Areas
- Leather Upholstery Not Available
- Adjustable Height Leveling Glides Standard
- Lifetime Warranty

**OPTIONS:**

- Closed Arm Panels (See 1800-PL / 1800-PR Item #'s)
- Specify Exposed Wood Finish (See Page 6)

*NOTE: All Seating Configurations Are Viewed From Left To Right Facing. Please Attach A Layout Showing Seating Configuration w/ Your Order. Assembled Units Must Be Shipped In Configurations Of 3 Or Less.*

**TANDEM**

ITEM #:

SPECIFICATIONS | GRADES | LIST PRICES:

ARM CHAIR / WOOD ARMS / ACCEPTS  
TABLE ON LEFT / SEAT ON RIGHT

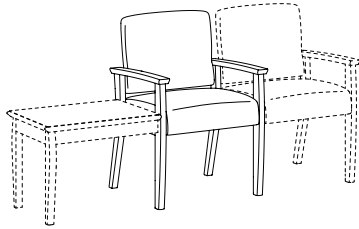

1820-TC

1820-R

**Overall:** 23.5"w 24"d 34"h  
**Seat:** 20"w 19"d 18.5"h

**Arm:** 25"h  
**Weight:** 45 lbs.

**COM:** 1.75 yds.  
**COL:** n/a

COM	COL	1	2	3	4	5	6	7	8	9	10	L1	L2
1162	N/A	1181	1222	1264	1305	1346	1387	1428	1470	1511	1552	N/A	N/A
<i>Open Back / Tight Seat &amp; Back / Removable Upholstery</i>													
131	N/A	206	247	288	330	371	412	453	495	536	577	N/A	N/A
<i>Replacement Upholstery Covers</i>													

ARM CHAIR / WOOD ARMS /  
ACCEPTS TABLE ON LEFT / RIGHT

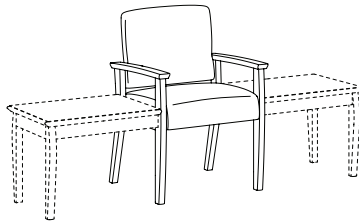

1820-TT

1820-R

**Overall:** 23.5"w 24"d 34"h  
**Seat:** 20"w 19"d 18.5"h

**Arm:** 25"h  
**Weight:** 45 lbs.

**COM:** 1.75 yds.  
**COL:** n/a

COM	COL	1	2	3	4	5	6	7	8	9	10	L1	L2
1162	N/A	1181	1222	1264	1305	1346	1387	1428	1470	1511	1552	N/A	N/A
<i>Open Back / Tight Seat &amp; Back / Removable Upholstery</i>													
131	N/A	206	247	288	330	371	412	453	495	536	577	N/A	N/A
<i>Replacement Upholstery Covers</i>													

**DESCRIPTION:**

- Upholstery Frames: Steel, Plywood & Hardwood
- Seat: High Density Polyurethane Foam Over Strap Webbing
- Back: High Density Polyurethane Foam Over Plywood
- Upholstered Covers: Attached w/ Velcro / Removable For Maintenance
- Exposed Wood Legs: Solid Hardwood / Removable For Maintenance / Wallsaver Legs
- Antimicrobial Moisture Barrier Fully Encapsulates All Foam Areas
- Leather Upholstery Not Available
- Adjustable Height Leveling Glides Standard
- Lifetime Warranty

**OPTIONS:**

- Closed Arm Panels (See 1800-PL / 1800-PR Item #'s)
- Specify Exposed Wood Finish (See Page 6)

*NOTE: All Seating Configurations Are Viewed From Left To Right Facing. Please Attach A Layout Showing Seating Configuration w/ Your Order. Assembled Units Must Be Shipped In Configurations Of 3 Or Less.*

**TANDEM**

**ADD-A-SEAT / WOOD ARMS**

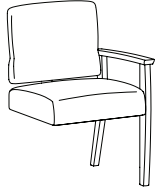

ITEM #:	SPECIFICATIONS   GRADES   LIST PRICES:													
	<b>Overall:</b> 21.75"w 24"d 34"h				<b>Arm:</b> 25"h				<b>COM:</b> 1.75 yds.					
	<b>Seat:</b> 20"w 19"d 18.5"h				<b>Weight:</b> 40 lbs.				<b>COL:</b> n/a					
	<b>COM</b>	<b>COL</b>	<b>1</b>	<b>2</b>	<b>3</b>	<b>4</b>	<b>5</b>	<b>6</b>	<b>7</b>	<b>8</b>	<b>9</b>	<b>10</b>	<b>L1</b>	<b>L2</b>
<b>1821</b>	924	N/A	956	997	1038	1079	1121	1162	1203	1244	1286	1327	N/A	N/A
	<i>Open Back / Tight Seat &amp; Back / Removable Upholstery</i>													
<b>1820-R</b>	131	N/A	206	247	288	330	371	412	453	495	536	577	N/A	N/A
	<i>Replacement Upholstery Covers</i>													

**ADD-A-SEAT / WOOD ARMS / ACCEPTS SEAT ON RIGHT**

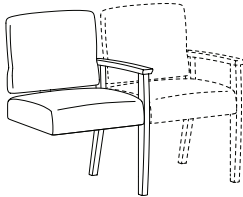

	<b>Overall:</b> 21.75"w 24"d 34"h				<b>Arm:</b> 25"h				<b>COM:</b> 1.75 yds.					
	<b>Seat:</b> 20"w 19"d 18.5"h				<b>Weight:</b> 40 lbs.				<b>COL:</b> n/a					
	<b>COM</b>	<b>COL</b>	<b>1</b>	<b>2</b>	<b>3</b>	<b>4</b>	<b>5</b>	<b>6</b>	<b>7</b>	<b>8</b>	<b>9</b>	<b>10</b>	<b>L1</b>	<b>L2</b>
<b>1821-C</b>	924	N/A	956	997	1038	1079	1121	1162	1203	1244	1286	1327	N/A	N/A
	<i>Open Back / Tight Seat &amp; Back / Removable Upholstery</i>													
<b>1820-R</b>	131	N/A	206	247	288	330	371	412	453	495	536	577	N/A	N/A
	<i>Replacement Upholstery Covers</i>													

**ADD-A-SEAT / WOOD ARMS / ACCEPTS TABLE ON RIGHT**

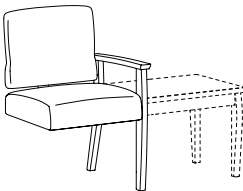

	<b>Overall:</b> 21.75"w 24"d 34"h				<b>Arm:</b> 25"h				<b>COM:</b> 1.75 yds.					
	<b>Seat:</b> 20"w 19"d 18.5"h				<b>Weight:</b> 40 lbs.				<b>COL:</b> n/a					
	<b>COM</b>	<b>COL</b>	<b>1</b>	<b>2</b>	<b>3</b>	<b>4</b>	<b>5</b>	<b>6</b>	<b>7</b>	<b>8</b>	<b>9</b>	<b>10</b>	<b>L1</b>	<b>L2</b>
<b>1821-T</b>	924	N/A	956	997	1038	1079	1121	1162	1203	1244	1286	1327	N/A	N/A
	<i>Open Back / Tight Seat &amp; Back / Removable Upholstery</i>													
<b>1820-R</b>	131	N/A	206	247	288	330	371	412	453	495	536	577	N/A	N/A
	<i>Replacement Upholstery Covers</i>													



**DESCRIPTION:**

- Upholstery Frames: Steel, Plywood & Hardwood
- Seat: High Density Polyurethane Foam Over Strap Webbing
- Back: High Density Polyurethane Foam Over Plywood
- Upholstered Covers: Attached w/ Velcro / Removable For Maintenance
- Exposed Wood Legs: Solid Hardwood / Removable For Maintenance / Wallsaver Legs
- Antimicrobial Moisture Barrier Fully Encapsulates All Foam Areas
- Leather Upholstery Not Available
- Adjustable Height Leveling Glides Standard
- Lifetime Warranty

**OPTIONS:**

- EPAC-1 Black Polyester Arm Caps (Set Of 2).....\$355
- Closed Arm Panels (See 1800-PL / 1800-PR Item #'s)
- Specify Exposed Wood Finish (See Page 6)

*NOTE: All Seating Configurations Are Viewed From Left To Right Facing. Please Attach A Layout Showing Seating Configuration w/ Your Order. Assembled Units Must Be Shipped In Configurations Of 3 Or Less.*

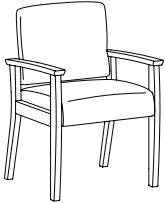
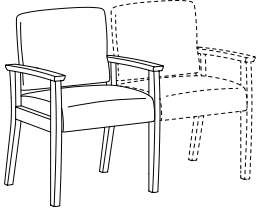
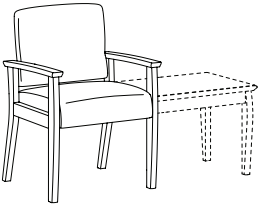
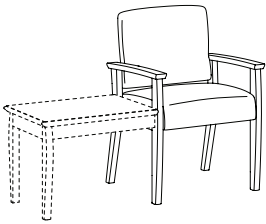
GUEST / TANDEM		ITEM #:	SPECIFICATIONS   GRADES   LIST PRICES:												
			<b>Overall:</b> 23.5"w 24"d 34"h			<b>Arm:</b> 25"h			<b>COM:</b> 1.75 yds.						
			<b>Seat:</b> 20"w 19"d 18.5"h			<b>Weight:</b> 45 lbs.			<b>COL:</b> n/a						
			<b>COM</b>	<b>COL</b>	<b>1</b>	<b>2</b>	<b>3</b>	<b>4</b>	<b>5</b>	<b>6</b>	<b>7</b>	<b>8</b>	<b>9</b>	<b>10</b>	<b>L1</b>
	<b>1822</b>		N/A	1209	1239	1280	1321	1363	1404	1445	1486	1527	1569	N/A	N/A
		<i>Open Back / Tight Seat &amp; Back / Removable Upholstery</i>													
	<b>1820-R</b>		N/A	206	247	288	330	371	412	453	495	536	577	N/A	N/A
		<i>Replacement Upholstery Covers</i>													
			<b>Overall:</b> 23.5"w 24"d 34"h			<b>Arm:</b> 25"h			<b>COM:</b> 1.75 yds.						
			<b>Seat:</b> 20"w 19"d 18.5"h			<b>Weight:</b> 45 lbs.			<b>COL:</b> n/a						
			<b>COM</b>	<b>COL</b>	<b>1</b>	<b>2</b>	<b>3</b>	<b>4</b>	<b>5</b>	<b>6</b>	<b>7</b>	<b>8</b>	<b>9</b>	<b>10</b>	<b>L1</b>
	<b>1822-C</b>		N/A	1209	1239	1280	1321	1363	1404	1445	1486	1527	1569	N/A	N/A
		<i>Open Back / Tight Seat &amp; Back / Removable Upholstery</i>													
	<b>1820-R</b>		N/A	206	247	288	330	371	412	453	495	536	577	N/A	N/A
		<i>Replacement Upholstery Covers</i>													
			<b>Overall:</b> 23.5"w 24"d 34"h			<b>Arm:</b> 25"h			<b>COM:</b> 1.75 yds.						
			<b>Seat:</b> 20"w 19"d 18.5"h			<b>Weight:</b> 45 lbs.			<b>COL:</b> n/a						
			<b>COM</b>	<b>COL</b>	<b>1</b>	<b>2</b>	<b>3</b>	<b>4</b>	<b>5</b>	<b>6</b>	<b>7</b>	<b>8</b>	<b>9</b>	<b>10</b>	<b>L1</b>
	<b>1822-T</b>		N/A	1209	1239	1280	1321	1363	1404	1445	1486	1527	1569	N/A	N/A
		<i>Open Back / Tight Seat &amp; Back / Removable Upholstery</i>													
	<b>1820-R</b>		N/A	206	247	288	330	371	412	453	495	536	577	N/A	N/A
		<i>Replacement Upholstery Covers</i>													
			<b>Overall:</b> 23.5"w 24"d 34"h			<b>Arm:</b> 25"h			<b>COM:</b> 1.75 yds.						
			<b>Seat:</b> 20"w 19"d 18.5"h			<b>Weight:</b> 45 lbs.			<b>COL:</b> n/a						
			<b>COM</b>	<b>COL</b>	<b>1</b>	<b>2</b>	<b>3</b>	<b>4</b>	<b>5</b>	<b>6</b>	<b>7</b>	<b>8</b>	<b>9</b>	<b>10</b>	<b>L1</b>
	<b>1822-LT</b>		N/A	1209	1239	1280	1321	1363	1404	1445	1486	1527	1569	N/A	N/A
		<i>Open Back / Tight Seat &amp; Back / Removable Upholstery</i>													
	<b>1820-R</b>		N/A	206	247	288	330	371	412	453	495	536	577	N/A	N/A
		<i>Replacement Upholstery Covers</i>													

**DESCRIPTION:**

- Upholstery Frames: Steel, Plywood & Hardwood
- Seat: High Density Polyurethane Foam Over Strap Webbing
- Back: High Density Polyurethane Foam Over Plywood
- Upholstered Covers: Attached w/ Velcro / Removable For Maintenance
- Exposed Wood Legs: Solid Hardwood / Removable For Maintenance / Wallsaver Legs
- Antimicrobial Moisture Barrier Fully Encapsulates All Foam Areas
- Leather Upholstery Not Available
- Adjustable Height Leveling Glides Standard
- Lifetime Warranty

**OPTIONS:**

- EPAC-1 Black Polyester Arm Caps (Set Of 2).....\$355
- Closed Arm Panels (See 1800-PL / 1800-PR Item #'s)
- Specify Exposed Wood Finish (See Page 6)

*NOTE: All Seating Configurations Are Viewed From Left To Right Facing. Please Attach A Layout Showing Seating Configuration w/ Your Order. Assembled Units Must Be Shipped In Configurations Of 3 Or Less.*

**TANDEM**

ITEM #:

SPECIFICATIONS | GRADES | LIST PRICES:

ARM CHAIR / URETHANE ARMS / ACCEPTS TABLE ON LEFT / SEAT ON RIGHT

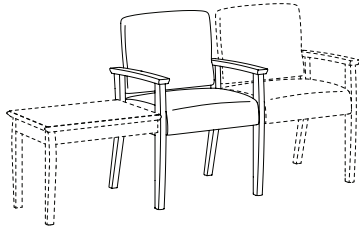

1822-TC

1820-R

<b>Overall:</b> 23.5"w 24"d 34"h		<b>Arm:</b> 25"h		<b>COM:</b> 1.75 yds.									
<b>Seat:</b> 20"w 19"d 18.5"h		<b>Weight:</b> 45 lbs.		<b>COL:</b> n/a									
COM	COL	1	2	3	4	5	6	7	8	9	10	L1	L2
1179	N/A	1209	1239	1280	1321	1363	1404	1445	1486	1527	1569	N/A	N/A
<i>Open Back / Tight Seat &amp; Back / Removable Upholstery</i>													
131	N/A	206	247	288	330	371	412	453	495	536	577	N/A	N/A
<i>Replacement Upholstery Covers</i>													

ARM CHAIR / URETHANE ARMS / ACCEPTS TABLE ON LEFT / RIGHT

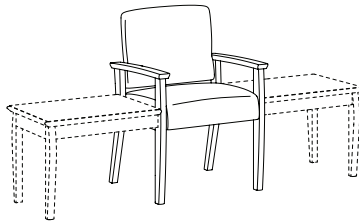

1822-TT

1820-R

<b>Overall:</b> 23.5"w 24"d 34"h		<b>Arm:</b> 25"h		<b>COM:</b> 1.75 yds.									
<b>Seat:</b> 20"w 19"d 18.5"h		<b>Weight:</b> 45 lbs.		<b>COL:</b> n/a									
COM	COL	1	2	3	4	5	6	7	8	9	10	L1	L2
1179	N/A	1209	1239	1280	1321	1363	1404	1445	1486	1527	1569	N/A	N/A
<i>Open Back / Tight Seat &amp; Back / Removable Upholstery</i>													
131	N/A	206	247	288	330	371	412	453	495	536	577	N/A	N/A
<i>Replacement Upholstery Covers</i>													

**DESCRIPTION:**

- Upholstery Frames: Steel, Plywood & Hardwood
- Seat: High Density Polyurethane Foam Over Strap Webbing
- Back: High Density Polyurethane Foam Over Plywood
- Upholstered Covers: Attached w/ Velcro / Removable For Maintenance
- Exposed Wood Legs: Solid Hardwood / Removable For Maintenance / Wallsaver Legs
- Antimicrobial Moisture Barrier Fully Encapsulates All Foam Areas
- Leather Upholstery Not Available
- Adjustable Height Leveling Glides Standard
- Lifetime Warranty

**OPTIONS:**

- EPAC-1 Black Polyester Arm Caps (Set Of 2).....\$355
- Closed Arm Panels (See 1800-PL / 1800-PR Item #'s)
- Specify Exposed Wood Finish (See Page 6)

*NOTE: All Seating Configurations Are Viewed From Left To Right Facing. Please Attach A Layout Showing Seating Configuration w/ Your Order. Assembled Units Must Be Shipped In Configurations Of 3 Or Less.*

**TANDEM**

**ITEM #: SPECIFICATIONS | GRADES | LIST PRICES:**

**ADD-A-SEAT / URETHANE ARMS**

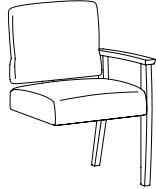

		<b>Overall:</b> 21.75"w 24"d 34"h		<b>Arm:</b> 25"h		<b>COM:</b> 1.75 yds.							
		<b>Seat:</b> 20"w 19"d 18.5"h		<b>Weight:</b> 40 lbs.		<b>COL:</b> n/a							
<b>COM</b>	<b>COL</b>	<b>1</b>	<b>2</b>	<b>3</b>	<b>4</b>	<b>5</b>	<b>6</b>	<b>7</b>	<b>8</b>	<b>9</b>	<b>10</b>	<b>L1</b>	<b>L2</b>
<b>1823</b>	N/A	961	1002	1044	1085	1126	1167	1209	1250	1291	1332	N/A	N/A
<i>Open Back / Tight Seat &amp; Back / Removable Upholstery</i>													
<b>1820-R</b>	N/A	206	247	288	330	371	412	453	495	536	577	N/A	N/A
<i>Replacement Upholstery Covers</i>													

**ADD-A-SEAT / URETHANE ARMS / ACCEPTS SEAT ON RIGHT**

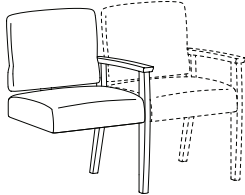

		<b>Overall:</b> 21.75"w 24"d 34"h		<b>Arm:</b> 25"h		<b>COM:</b> 1.75 yds.							
		<b>Seat:</b> 20"w 19"d 18.5"h		<b>Weight:</b> 40 lbs.		<b>COL:</b> n/a							
<b>COM</b>	<b>COL</b>	<b>1</b>	<b>2</b>	<b>3</b>	<b>4</b>	<b>5</b>	<b>6</b>	<b>7</b>	<b>8</b>	<b>9</b>	<b>10</b>	<b>L1</b>	<b>L2</b>
<b>1823-C</b>	N/A	961	1002	1044	1085	1126	1167	1209	1250	1291	1332	N/A	N/A
<i>Open Back / Tight Seat &amp; Back / Removable Upholstery</i>													
<b>1820-R</b>	N/A	206	247	288	330	371	412	453	495	536	577	N/A	N/A
<i>Replacement Upholstery Covers</i>													

**ADD-A-SEAT / URETHANE ARMS / ACCEPTS TABLE ON RIGHT**

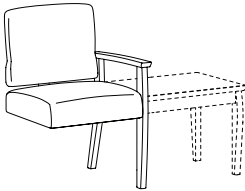

		<b>Overall:</b> 21.75"w 24"d 34"h		<b>Arm:</b> 25"h		<b>COM:</b> 1.75 yds.							
		<b>Seat:</b> 20"w 19"d 18.5"h		<b>Weight:</b> 40 lbs.		<b>COL:</b> n/a							
<b>COM</b>	<b>COL</b>	<b>1</b>	<b>2</b>	<b>3</b>	<b>4</b>	<b>5</b>	<b>6</b>	<b>7</b>	<b>8</b>	<b>9</b>	<b>10</b>	<b>L1</b>	<b>L2</b>
<b>1823-T</b>	N/A	961	1002	1044	1085	1126	1167	1209	1250	1291	1332	N/A	N/A
<i>Open Back / Tight Seat &amp; Back / Removable Upholstery</i>													
<b>1820-R</b>	N/A	206	247	288	330	371	412	453	495	536	577	N/A	N/A
<i>Replacement Upholstery Covers</i>													

**DESCRIPTION:**

- Upholstery Frames: Steel, Plywood & Hardwood
- Seat: High Density Polyurethane Foam Over Strap Webbing
- Back: High Density Polyurethane Foam Over Plywood
- Upholstered Covers: Attached w/ Velcro / Removable For Maintenance
- Exposed Wood Legs: Solid Hardwood / Removable For Maintenance / Wallsaver Legs
- Antimicrobial Moisture Barrier Fully Encapsulates All Foam Areas
- Leather Upholstery Not Available
- Adjustable Height Leveling Glides Standard
- Lifetime Warranty

**OPTIONS:**

- Closed Arm Panels (See 1800-PL / 1800-PR Item #'s)
- Specify Exposed Wood Finish (See Page 6)

*NOTE: All Seating Configurations Are Viewed From Left To Right Facing. Please Attach A Layout Showing Seating Configuration w/ Your Order. Assembled Units Must Be Shipped In Configurations Of 3 Or Less.*

**BARIATRIC / TANDEM**

ITEM #:

SPECIFICATIONS | GRADES | LIST PRICES:

**BARIATRIC CHAIR / WOOD ARMS**

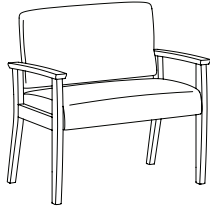

**Overall:** 33.5"w 24"d 34"h      **Arm:** 25"h      **COM:** 2.25 yds.  
**Seat:** 30"w 19"d 18.5"h      **Weight:** 55 lbs.      **COL:** n/a

COM	COL	1	2	3	4	5	6	7	8	9	10	L1	L2
1830	N/A	1537	1592	1647	1702	1757	1812	1867	1922	1977	2032	N/A	N/A
<i>Open Back / Tight Seat &amp; Back / Removable Upholstery / 500 lb. Weight Capacity</i>													
1830-R	N/A	242	297	352	407	462	517	572	627	682	737	N/A	N/A
<i>Replacement Upholstery Covers</i>													

**BARIATRIC CHAIR / WOOD ARMS / ACCEPTS SEAT ON RIGHT**

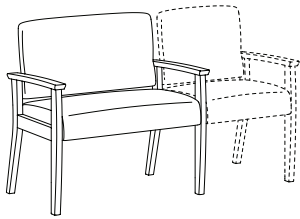

**Overall:** 33.5"w 24"d 34"h      **Arm:** 25"h      **COM:** 2.25 yds.  
**Seat:** 30"w 19"d 18.5"h      **Weight:** 55 lbs.      **COL:** n/a

COM	COL	1	2	3	4	5	6	7	8	9	10	L1	L2
1830-C	N/A	1537	1592	1647	1702	1757	1812	1867	1922	1977	2032	N/A	N/A
<i>Open Back / Tight Seat &amp; Back / Removable Upholstery / 500 lb. Weight Capacity</i>													
1830-R	N/A	242	297	352	407	462	517	572	627	682	737	N/A	N/A
<i>Replacement Upholstery Covers</i>													

**BARIATRIC CHAIR / WOOD ARMS / ACCEPTS TABLE ON RIGHT**

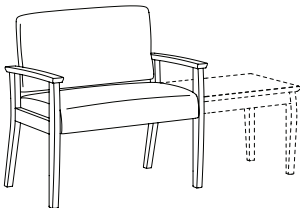

**Overall:** 33.5"w 24"d 34"h      **Arm:** 25"h      **COM:** 2.25 yds.  
**Seat:** 30"w 19"d 18.5"h      **Weight:** 55 lbs.      **COL:** n/a

COM	COL	1	2	3	4	5	6	7	8	9	10	L1	L2
1830-T	N/A	1537	1592	1647	1702	1757	1812	1867	1922	1977	2032	N/A	N/A
<i>Open Back / Tight Seat &amp; Back / Removable Upholstery / 500 lb. Weight Capacity</i>													
1830-R	N/A	242	297	352	407	462	517	572	627	682	737	N/A	N/A
<i>Replacement Upholstery Covers</i>													

**BARIATRIC CHAIR / WOOD ARMS / ACCEPTS TABLE ON LEFT**

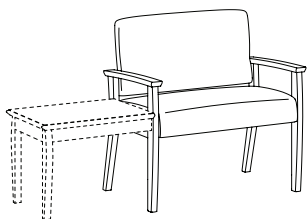

**Overall:** 33.5"w 24"d 34"h      **Arm:** 25"h      **COM:** 2.25 yds.  
**Seat:** 30"w 19"d 18.5"h      **Weight:** 55 lbs.      **COL:** n/a

COM	COL	1	2	3	4	5	6	7	8	9	10	L1	L2
1830-LT	N/A	1537	1592	1647	1702	1757	1812	1867	1922	1977	2032	N/A	N/A
<i>Open Back / Tight Seat &amp; Back / Removable Upholstery / 500 lb. Weight Capacity</i>													
1830-R	N/A	242	297	352	407	462	517	572	627	682	737	N/A	N/A
<i>Replacement Upholstery Covers</i>													

**DESCRIPTION:**

- Upholstery Frames: Steel, Plywood & Hardwood
- Seat: High Density Polyurethane Foam Over Strap Webbing
- Back: High Density Polyurethane Foam Over Plywood
- Upholstered Covers: Attached w/ Velcro / Removable For Maintenance
- Exposed Wood Legs: Solid Hardwood / Removable For Maintenance / Wallsaver Legs
- Antimicrobial Moisture Barrier Fully Encapsulates All Foam Areas
- Leather Upholstery Not Available
- Adjustable Height Leveling Glides Standard
- Lifetime Warranty

**OPTIONS:**

- Closed Arm Panels (See 1800-PL / 1800-PR Item #'s)
- Specify Exposed Wood Finish (See Page 6)

*NOTE: All Seating Configurations Are Viewed From Left To Right Facing. Please Attach A Layout Showing Seating Configuration w/ Your Order. Assembled Units Must Be Shipped In Configurations Of 3 Or Less.*

**BARIATRIC / TANDEM**

ITEM #:

SPECIFICATIONS | GRADES | LIST PRICES:

**BARIATRIC CHAIR / WOOD ARMS /  
ACCEPTS TABLE ON LEFT / SEAT ON RIGHT**

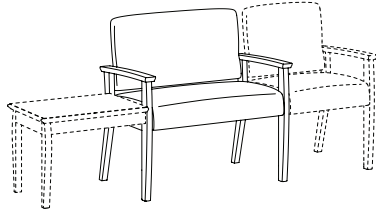

**1830-TC**

**1830-R**

		<i>Overall: 33.5"w 24"d 34"h</i>			<i>Arm: 25"h</i>			<i>COM: 2.25 yds.</i>					
		<i>Seat: 30"w 19"d 18.5"h</i>			<i>Weight: 55 lbs.</i>			<i>COL: n/a</i>					
COM	COL	1	2	3	4	5	6	7	8	9	10	L1	L2
1509	N/A	1537	1592	1647	1702	1757	1812	1867	1922	1977	2032	N/A	N/A
<i>Open Back / Tight Seat &amp; Back / Removable Upholstery / 500 lb. Weight Capacity</i>													
140	N/A	242	297	352	407	462	517	572	627	682	737	N/A	N/A
<i>Replacement Upholstery Covers</i>													

**BARIATRIC CHAIR / WOOD ARMS /  
ACCEPTS TABLE ON LEFT / RIGHT**

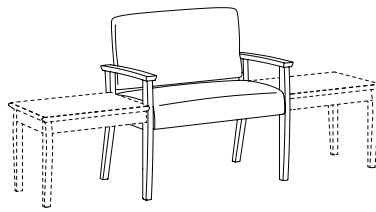

**1830-TT**

**1830-R**

		<i>Overall: 33.5"w 24"d 34"h</i>			<i>Arm: 25"h</i>			<i>COM: 2.25 yds.</i>					
		<i>Seat: 30"w 19"d 18.5"h</i>			<i>Weight: 55 lbs.</i>			<i>COL: n/a</i>					
COM	COL	1	2	3	4	5	6	7	8	9	10	L1	L2
1509	N/A	1537	1592	1647	1702	1757	1812	1867	1922	1977	2032	N/A	N/A
<i>Open Back / Tight Seat &amp; Back / Removable Upholstery / 500 lb. Weight Capacity</i>													
140	N/A	242	297	352	407	462	517	572	627	682	737	N/A	N/A
<i>Replacement Upholstery Covers</i>													

**DESCRIPTION:**

- Upholstery Frames: Steel, Plywood & Hardwood
- Seat: High Density Polyurethane Foam Over Strap Webbing
- Back: High Density Polyurethane Foam Over Plywood
- Upholstered Covers: Attached w/ Velcro / Removable For Maintenance
- Exposed Wood Legs: Solid Hardwood / Removable For Maintenance / Wallsaver Legs
- Antimicrobial Moisture Barrier Fully Encapsulates All Foam Areas
- Leather Upholstery Not Available
- Adjustable Height Leveling Glides Standard
- Lifetime Warranty

**OPTIONS:**

- Closed Arm Panels (See 1800-PL / 1800-PR Item #'s)
- Specify Exposed Wood Finish (See Page 6)

*NOTE: All Seating Configurations Are Viewed From Left To Right Facing. Please Attach A Layout Showing Seating Configuration w/ Your Order. Assembled Units Must Be Shipped In Configurations Of 3 Or Less.*

**BARIATRIC / TANDEM**

ITEM #:

SPECIFICATIONS | GRADES | LIST PRICES:

**BARIATRIC ADD-A-SEAT / WOOD ARMS**

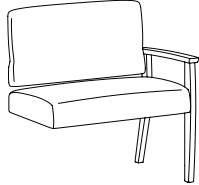

**Overall:** 31.75"w 24"d 34"h      **Arm:** 25"h      **COM:** 2.25 yds.  
**Seat:** 30"w 19"d 18.5"h      **Weight:** 52 lbs.      **COL:** n/a

COM	COL	1	2	3	4	5	6	7	8	9	10	L1	L2
1831	N/A	1300	1355	1410	1465	1520	1575	1630	1685	1740	1795	N/A	N/A
<i>Open Back / Tight Seat &amp; Back / Removable Upholstery / 500 lb. Weight Capacity</i>													
1830-R	N/A	242	297	352	407	462	517	572	627	682	737	N/A	N/A
<i>Replacement Upholstery Covers</i>													

**BARIATRIC ADD-A-SEAT / WOOD ARMS / ACCEPTS SEAT ON RIGHT**

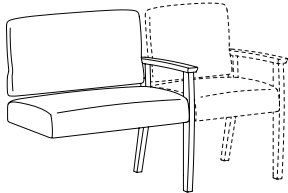

**Overall:** 31.75"w 24"d 34"h      **Arm:** 25"h      **COM:** 2.25 yds.  
**Seat:** 30"w 19"d 18.5"h      **Weight:** 52 lbs.      **COL:** n/a

COM	COL	1	2	3	4	5	6	7	8	9	10	L1	L2
1831-C	N/A	1300	1355	1410	1465	1520	1575	1630	1685	1740	1795	N/A	N/A
<i>Open Back / Tight Seat &amp; Back / Removable Upholstery / 500 lb. Weight Capacity</i>													
1830-R	N/A	242	297	352	407	462	517	572	627	682	737	N/A	N/A
<i>Replacement Upholstery Covers</i>													

**BARIATRIC ADD-A-SEAT / WOOD ARMS / ACCEPTS TABLE ON RIGHT**

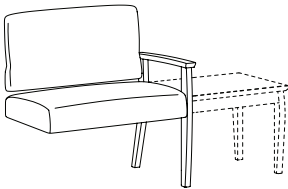

**Overall:** 31.75"w 24"d 34"h      **Arm:** 25"h      **COM:** 2.25 yds.  
**Seat:** 30"w 19"d 18.5"h      **Weight:** 52 lbs.      **COL:** n/a

COM	COL	1	2	3	4	5	6	7	8	9	10	L1	L2
1831-T	N/A	1300	1355	1410	1465	1520	1575	1630	1685	1740	1795	N/A	N/A
<i>Open Back / Tight Seat &amp; Back / Removable Upholstery / 500 lb. Weight Capacity</i>													
1830-R	N/A	242	297	352	407	462	517	572	627	682	737	N/A	N/A
<i>Replacement Upholstery Covers</i>													

**DESCRIPTION:**

- Upholstery Frames: Steel, Plywood & Hardwood
- Seat: High Density Polyurethane Foam Over Strap Webbing
- Back: High Density Polyurethane Foam Over Plywood
- Upholstered Covers: Attached w/ Velcro / Removable For Maintenance
- Exposed Wood Legs: Solid Hardwood / Removable For Maintenance / Wallsaver Legs
- Antimicrobial Moisture Barrier Fully Encapsulates All Foam Areas
- Leather Upholstery Not Available
- Adjustable Height Leveling Glides Standard
- Lifetime Warranty

**OPTIONS:**

- EPAC-1 Black Polyester Arm Caps (Set Of 2).....\$355
- Closed Arm Panels (See 1800-PL / 1800-PR Item #'s)
- Specify Exposed Wood Finish (See Page 6)

*NOTE: All Seating Configurations Are Viewed From Left To Right Facing. Please Attach A Layout Showing Seating Configuration w/ Your Order. Assembled Units Must Be Shipped In Configurations Of 3 Or Less.*

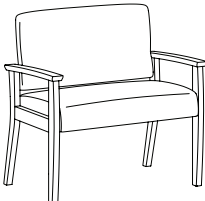
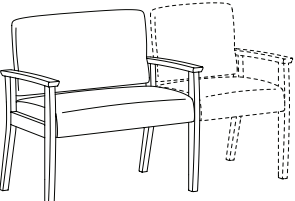
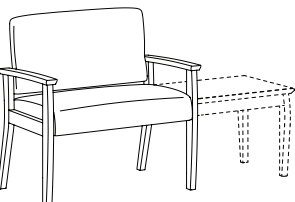
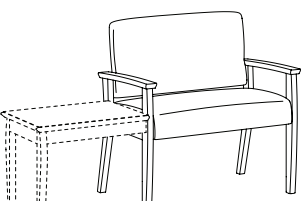
BARIATRIC / TANDEM		ITEM #:	SPECIFICATIONS   GRADES   LIST PRICES:													
		1832	<b>Overall:</b> 33.5"w 24"d 34"h		<b>Arm:</b> 25"h		<b>COM:</b> 2.25 yds.									
			<b>Seat:</b> 30"w 19"d 18.5"h		<b>Weight:</b> 55 lbs.		<b>COL:</b> n/a									
			<b>COM</b>	<b>COL</b>	<b>1</b>	<b>2</b>	<b>3</b>	<b>4</b>	<b>5</b>	<b>6</b>	<b>7</b>	<b>8</b>	<b>9</b>	<b>10</b>	<b>L1</b>	<b>L2</b>
			1521	N/A	1548	1603	1658	1713	1768	1823	1878	1933	1988	2043	N/A	N/A
			<i>Open Back / Tight Seat &amp; Back / Removable Upholstery / 500 lb. Weight Capacity</i>													
		1830-R	140	N/A	242	297	352	407	462	517	572	627	682	737	N/A	N/A
			<i>Replacement Upholstery Covers</i>													
		1832-C	<b>Overall:</b> 33.5"w 24"d 34"h		<b>Arm:</b> 25"h		<b>COM:</b> 2.25 yds.									
			<b>Seat:</b> 30"w 19"d 18.5"h		<b>Weight:</b> 55 lbs.		<b>COL:</b> n/a									
			<b>COM</b>	<b>COL</b>	<b>1</b>	<b>2</b>	<b>3</b>	<b>4</b>	<b>5</b>	<b>6</b>	<b>7</b>	<b>8</b>	<b>9</b>	<b>10</b>	<b>L1</b>	<b>L2</b>
			1521	N/A	1548	1603	1658	1713	1768	1823	1878	1933	1988	2043	N/A	N/A
			<i>Open Back / Tight Seat &amp; Back / Removable Upholstery / 500 lb. Weight Capacity</i>													
		1830-R	140	N/A	242	297	352	407	462	517	572	627	682	737	N/A	N/A
			<i>Replacement Upholstery Covers</i>													
		1832-T	<b>Overall:</b> 33.5"w 24"d 34"h		<b>Arm:</b> 25"h		<b>COM:</b> 2.25 yds.									
			<b>Seat:</b> 30"w 19"d 18.5"h		<b>Weight:</b> 55 lbs.		<b>COL:</b> n/a									
			<b>COM</b>	<b>COL</b>	<b>1</b>	<b>2</b>	<b>3</b>	<b>4</b>	<b>5</b>	<b>6</b>	<b>7</b>	<b>8</b>	<b>9</b>	<b>10</b>	<b>L1</b>	<b>L2</b>
			1521	N/A	1548	1603	1658	1713	1768	1823	1878	1933	1988	2043	N/A	N/A
			<i>Open Back / Tight Seat &amp; Back / Removable Upholstery / 500 lb. Weight Capacity</i>													
		1830-R	140	N/A	242	297	352	407	462	517	572	627	682	737	N/A	N/A
			<i>Replacement Upholstery Covers</i>													
		1832-LT	<b>Overall:</b> 33.5"w 24"d 34"h		<b>Arm:</b> 25"h		<b>COM:</b> 2.25 yds.									
			<b>Seat:</b> 30"w 19"d 18.5"h		<b>Weight:</b> 55 lbs.		<b>COL:</b> n/a									
			<b>COM</b>	<b>COL</b>	<b>1</b>	<b>2</b>	<b>3</b>	<b>4</b>	<b>5</b>	<b>6</b>	<b>7</b>	<b>8</b>	<b>9</b>	<b>10</b>	<b>L1</b>	<b>L2</b>
			1521	N/A	1548	1603	1658	1713	1768	1823	1878	1933	1988	2043	N/A	N/A
			<i>Open Back / Tight Seat &amp; Back / Removable Upholstery / 500 lb. Weight Capacity</i>													
		1830-R	140	N/A	242	297	352	407	462	517	572	627	682	737	N/A	N/A
			<i>Replacement Upholstery Covers</i>													

**DESCRIPTION:**

- Upholstery Frames: Steel, Plywood & Hardwood
- Seat: High Density Polyurethane Foam Over Strap Webbing
- Back: High Density Polyurethane Foam Over Plywood
- Upholstered Covers: Attached w/ Velcro / Removable For Maintenance
- Exposed Wood Legs: Solid Hardwood / Removable For Maintenance / Wallsaver Legs
- Antimicrobial Moisture Barrier Fully Encapsulates All Foam Areas
- Leather Upholstery Not Available
- Adjustable Height Leveling Glides Standard
- Lifetime Warranty

**OPTIONS:**

- EPAC-1 Black Polyester Arm Caps (Set Of 2).....\$355
- Closed Arm Panels (See 1800-PL / 1800-PR Item #'s)
- Specify Exposed Wood Finish (See Page 6)

*NOTE: All Seating Configurations Are Viewed From Left To Right Facing. Please Attach A Layout Showing Seating Configuration w/ Your Order. Assembled Units Must Be Shipped In Configurations Of 3 Or Less.*

**BARIATRIC / TANDEM**

ITEM #:

SPECIFICATIONS | GRADES | LIST PRICES:

**BARIATRIC CHAIR / URETHANE ARMS / ACCEPTS TABLE ON LEFT / SEAT ON RIGHT**

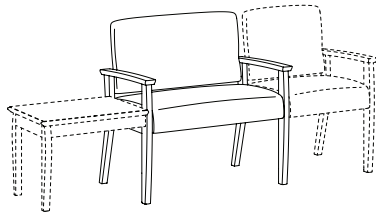

**1832-TC**

**1830-R**

<b>Overall:</b> 33.5"w 24"d 34"h		<b>Arm:</b> 25"h		<b>COM:</b> 2.25 yds.									
<b>Seat:</b> 30"w 19"d 18.5"h		<b>Weight:</b> 55 lbs.		<b>COL:</b> n/a									
COM	COL	1	2	3	4	5	6	7	8	9	10	L1	L2
1521	N/A	1548	1603	1658	1713	1768	1823	1878	1933	1988	2043	N/A	N/A
<i>Open Back / Tight Seat &amp; Back / Removable Upholstery / 500 lb. Weight Capacity</i>													
140	N/A	242	297	352	407	462	517	572	627	682	737	N/A	N/A
<i>Replacement Upholstery Covers</i>													

**BARIATRIC CHAIR / URETHANE ARMS / ACCEPTS TABLE ON LEFT / RIGHT**

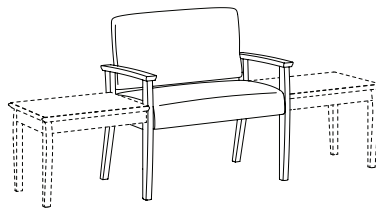

**1832-TT**

**1830-R**

<b>Overall:</b> 33.5"w 24"d 34"h		<b>Arm:</b> 25"h		<b>COM:</b> 2.25 yds.									
<b>Seat:</b> 30"w 19"d 18.5"h		<b>Weight:</b> 55 lbs.		<b>COL:</b> n/a									
COM	COL	1	2	3	4	5	6	7	8	9	10	L1	L2
1521	N/A	1548	1603	1658	1713	1768	1823	1878	1933	1988	2043	N/A	N/A
<i>Open Back / Tight Seat &amp; Back / Removable Upholstery / 500 lb. Weight Capacity</i>													
140	N/A	242	297	352	407	462	517	572	627	682	737	N/A	N/A
<i>Replacement Upholstery Covers</i>													



**DESCRIPTION:**

- Upholstery Frames: Steel, Plywood & Hardwood
- Seat: High Density Polyurethane Foam Over Strap Webbing
- Back: High Density Polyurethane Foam Over Plywood
- Upholstered Covers: Attached w/ Velcro / Removable For Maintenance
- Exposed Wood Legs: Solid Hardwood / Removable For Maintenance / Wallsaver Legs
- Antimicrobial Moisture Barrier Fully Encapsulates All Foam Areas
- Leather Upholstery Not Available
- Adjustable Height Leveling Glides Standard
- Lifetime Warranty

**OPTIONS:**

- EPAC-1 Black Polyester Arm Caps (Set Of 2).....\$355
- Closed Arm Panels (See 1800-PL / 1800-PR Item #'s)
- Specify Exposed Wood Finish (See Page 6)

*NOTE: All Seating Configurations Are Viewed From Left To Right Facing. Please Attach A Layout Showing Seating Configuration w/ Your Order. Assembled Units Must Be Shipped In Configurations Of 3 Or Less.*

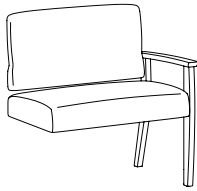
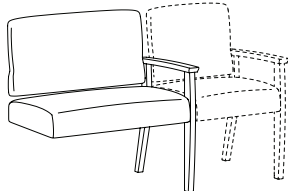
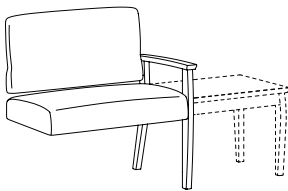
BARIATRIC / TANDEM		ITEM #:	SPECIFICATIONS   GRADES   LIST PRICES:													
BARIATRIC ADD-A-SEAT / URETHANE ARMS			<i>Overall: 31.75"w 24"d 34"h</i>			<i>Arm: 25"h</i>			<i>COM: 2.25 yds.</i>							
			<i>Seat: 30"w 19"d 18.5"h</i>			<i>Weight: 52 lbs.</i>			<i>COL: n/a</i>							
			COM	COL	1	2	3	4	5	6	7	8	9	10	L1	L2
		1833	1265	N/A	1306	1361	1416	1471	1526	1581	1636	1690	1745	1800	N/A	N/A
			<i>Open Back / Tight Seat &amp; Back / Removable Upholstery / 500 lb. Weight Capacity</i>													
		1830-R	140	N/A	242	297	352	407	462	517	572	627	682	737	N/A	N/A
			<i>Replacement Upholstery Covers</i>													
BARIATRIC ADD-A-SEAT / URETHANE ARMS / ACCEPTS SEAT ON RIGHT			<i>Overall: 31.75"w 24"d 34"h</i>			<i>Arm: 25"h</i>			<i>COM: 2.25 yds.</i>							
			<i>Seat: 30"w 19"d 18.5"h</i>			<i>Weight: 52 lbs.</i>			<i>COL: n/a</i>							
			COM	COL	1	2	3	4	5	6	7	8	9	10	L1	L2
		1833-C	1265	N/A	1306	1361	1416	1471	1526	1581	1636	1690	1745	1800	N/A	N/A
			<i>Open Back / Tight Seat &amp; Back / Removable Upholstery / 500 lb. Weight Capacity</i>													
		1830-R	140	N/A	242	297	352	407	462	517	572	627	682	737	N/A	N/A
			<i>Replacement Upholstery Covers</i>													
BARIATRIC ADD-A-SEAT / URETHANE ARMS / ACCEPTS TABLE ON RIGHT			<i>Overall: 31.75"w 24"d 34"h</i>			<i>Arm: 25"h</i>			<i>COM: 2.25 yds.</i>							
			<i>Seat: 30"w 19"d 18.5"h</i>			<i>Weight: 52 lbs.</i>			<i>COL: n/a</i>							
			COM	COL	1	2	3	4	5	6	7	8	9	10	L1	L2
		1833-T	1265	N/A	1306	1361	1416	1471	1526	1581	1636	1690	1745	1800	N/A	N/A
			<i>Open Back / Tight Seat &amp; Back / Removable Upholstery / 500 lb. Weight Capacity</i>													
		1830-R	140	N/A	242	297	352	407	462	517	572	627	682	737	N/A	N/A
			<i>Replacement Upholstery Covers</i>													

**DESCRIPTION:**

- Upholstery Frames: Steel, Plywood & Hardwood
- Seat: High Density Polyurethane Foam Over Strap Webbing
- Back: High Density Polyurethane Foam Over Plywood
- Upholstered Covers: Attached w/ Velcro / Removable For Maintenance
- Exposed Wood Legs: Solid Hardwood / Removable For Maintenance / Wallsaver Legs
- Antimicrobial Moisture Barrier Fully Encapsulates All Foam Areas
- Leather Upholstery Not Available
- Adjustable Height Leveling Glides Standard
- Lifetime Warranty

**OPTIONS:**

- Closed Arm Panels (See 1800-PL / 1800-PR Item #'s)
- Specify Exposed Wood Finish (See Page 6)

*NOTE: All Seating Configurations Are Viewed From Left To Right Facing. Please Attach A Layout Showing Seating Configuration w/ Your Order. Assembled Units Must Be Shipped In Configurations Of 3 Or Less.*

**TANDEM**

ITEM #:

SPECIFICATIONS | GRADES | LIST PRICES:

**TWO PLACE SOFA / WOOD ARMS**

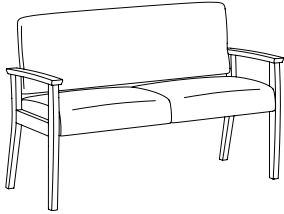

**Overall:** 51.5"w 24"d 34"h      **Arm:** 25"h      **COM:** 3.5 yds.  
**Seat:** 48"w 19"d 18.5"h      **Weight:** 65 lbs.      **COL:** n/a

COM	COL	1	2	3	4	5	6	7	8	9	10	L1	L2
1848	N/A	2009	2099	2188	2277	2367	2456	2545	2635	2724	2813	N/A	N/A
<i>Open Back / Tight Seat &amp; Back / Removable Upholstery</i>													
1848-R	N/A	362	451	540	630	719	808	898	987	1076	1166	N/A	N/A
<i>Replacement Upholstery Covers</i>													

**TWO PLACE SOFA / WOOD ARMS / ACCEPTS SEAT ON RIGHT**

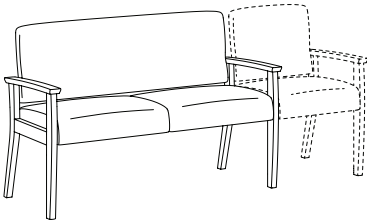

**Overall:** 51.5"w 24"d 34"h      **Arm:** 25"h      **COM:** 3.5 yds.  
**Seat:** 48"w 19"d 18.5"h      **Weight:** 65 lbs.      **COL:** n/a

COM	COL	1	2	3	4	5	6	7	8	9	10	L1	L2
1848-C	N/A	2009	2099	2188	2277	2367	2456	2545	2635	2724	2813	N/A	N/A
<i>Open Back / Tight Seat &amp; Back / Removable Upholstery</i>													
1848-R	N/A	362	451	540	630	719	808	898	987	1076	1166	N/A	N/A
<i>Replacement Upholstery Covers</i>													

**TWO PLACE SOFA / WOOD ARMS / ACCEPTS TABLE ON RIGHT**

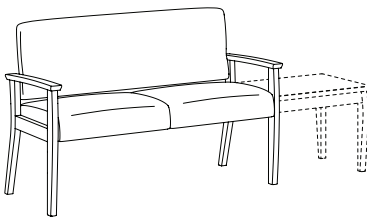

**Overall:** 51.5"w 24"d 34"h      **Arm:** 25"h      **COM:** 3.5 yds.  
**Seat:** 48"w 19"d 18.5"h      **Weight:** 65 lbs.      **COL:** n/a

COM	COL	1	2	3	4	5	6	7	8	9	10	L1	L2
1848-T	N/A	2009	2099	2188	2277	2367	2456	2545	2635	2724	2813	N/A	N/A
<i>Open Back / Tight Seat &amp; Back / Removable Upholstery</i>													
1848-R	N/A	362	451	540	630	719	808	898	987	1076	1166	N/A	N/A
<i>Replacement Upholstery Covers</i>													

**TWO PLACE SOFA / WOOD ARMS / ACCEPTS TABLE ON LEFT**

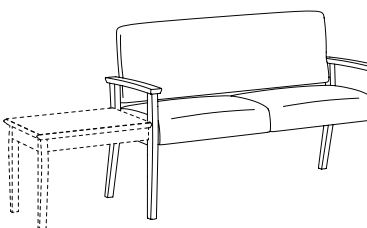

**Overall:** 51.5"w 24"d 34"h      **Arm:** 25"h      **COM:** 3.5 yds.  
**Seat:** 48"w 19"d 18.5"h      **Weight:** 65 lbs.      **COL:** n/a

COM	COL	1	2	3	4	5	6	7	8	9	10	L1	L2
1848-LT	N/A	2009	2099	2188	2277	2367	2456	2545	2635	2724	2813	N/A	N/A
<i>Open Back / Tight Seat &amp; Back / Removable Upholstery</i>													
1848-R	N/A	362	451	540	630	719	808	898	987	1076	1166	N/A	N/A
<i>Replacement Upholstery Covers</i>													

**DESCRIPTION:**

- Upholstery Frames: Steel, Plywood & Hardwood
- Seat: High Density Polyurethane Foam Over Strap Webbing
- Back: High Density Polyurethane Foam Over Plywood
- Upholstered Covers: Attached w/ Velcro / Removable For Maintenance
- Exposed Wood Legs: Solid Hardwood / Removable For Maintenance / Wallsaver Legs
- Antimicrobial Moisture Barrier Fully Encapsulates All Foam Areas
- Leather Upholstery Not Available
- Adjustable Height Leveling Glides Standard
- Lifetime Warranty

**OPTIONS:**

- Closed Arm Panels (See 1800-PL / 1800-PR Item #'s)
- Specify Exposed Wood Finish (See Page 6)

*NOTE: All Seating Configurations Are Viewed From Left To Right Facing. Please Attach A Layout Showing Seating Configuration w/ Your Order. Assembled Units Must Be Shipped In Configurations Of 3 Or Less.*

**TANDEM**

ITEM #:

SPECIFICATIONS | GRADES | LIST PRICES:

**TWO PLACE SOFA / WOOD ARMS /  
ACCEPTS TABLE ON LEFT / SEAT ON RIGHT**

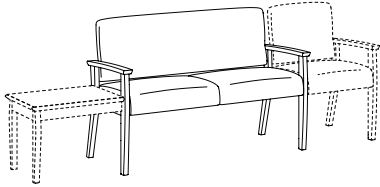

**1848-TC**

**1848-R**

**Overall:** 51.5"w 24"d 34"h      **Arm:** 25"h      **COM:** 3.5 yds.  
**Seat:** 48"w 19"d 18.5"h      **Weight:** 65 lbs.      **COL:** n/a

COM	COL	1	2	3	4	5	6	7	8	9	10	L1	L2
1936	N/A	2009	2099	2188	2277	2367	2456	2545	2635	2724	2813	N/A	N/A
<i>Open Back / Tight Seat &amp; Back / Removable Upholstery</i>													
194	N/A	362	451	540	630	719	808	898	987	1076	1166	N/A	N/A
<i>Replacement Upholstery Covers</i>													

**TWO PLACE SOFA / WOOD ARMS /  
ACCEPTS TABLE ON LEFT / RIGHT**

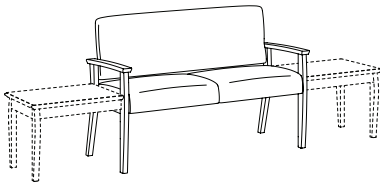

**1848-TT**

**1848-R**

**Overall:** 51.5"w 24"d 34"h      **Arm:** 25"h      **COM:** 3.5 yds.  
**Seat:** 48"w 19"d 18.5"h      **Weight:** 65 lbs.      **COL:** n/a

COM	COL	1	2	3	4	5	6	7	8	9	10	L1	L2
1936	N/A	2009	2099	2188	2277	2367	2456	2545	2635	2724	2813	N/A	N/A
<i>Open Back / Tight Seat &amp; Back / Removable Upholstery</i>													
194	N/A	362	451	540	630	719	808	898	987	1076	1166	N/A	N/A
<i>Replacement Upholstery Covers</i>													

**DESCRIPTION:**

- Upholstery Frames: Steel, Plywood & Hardwood
- Seat: High Density Polyurethane Foam Over Strap Webbing
- Back: High Density Polyurethane Foam Over Plywood
- Upholstered Covers: Attached w/ Velcro / Removable For Maintenance
- Exposed Wood Legs: Solid Hardwood / Removable For Maintenance / Wallsaver Legs
- Antimicrobial Moisture Barrier Fully Encapsulates All Foam Areas
- Leather Upholstery Not Available
- Adjustable Height Leveling Glides Standard
- Lifetime Warranty

**OPTIONS:**

- Closed Arm Panels (See 1800-PL / 1800-PR Item #'s)
- Specify Exposed Wood Finish (See Page 6)

*NOTE: All Seating Configurations Are Viewed From Left To Right Facing. Please Attach A Layout Showing Seating Configuration w/ Your Order. Assembled Units Must Be Shipped In Configurations Of 3 Or Less.*

**TANDEM**

**ITEM #: SPECIFICATIONS | GRADES | LIST PRICES:**

**TWO PLACE ADD-A-SEAT / WOOD ARMS**

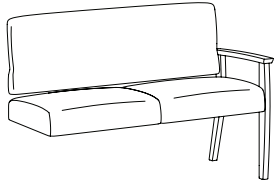

**Overall:** 49.75"w 24"d 34"h      **Arm:** 25"h      **COM:** 3.5 yds.  
**Seat:** 48"w 19"d 18.5"h      **Weight:** 62 lbs.      **COL:** n/a

COM	COL	1	2	3	4	5	6	7	8	9	10	L1	L2
-----	-----	---	---	---	---	---	---	---	---	---	----	----	----

<b>1849</b>	1684	N/A	1771	1860	1950	2039	2128	2218	2307	2396	2486	2575	N/A	N/A
-------------	------	-----	------	------	------	------	------	------	------	------	------	------	-----	-----

*Open Back / Tight Seat & Back / Removable Upholstery*

<b>1848-R</b>	194	N/A	362	451	540	630	719	808	898	987	1076	1166	N/A	N/A
---------------	-----	-----	-----	-----	-----	-----	-----	-----	-----	-----	------	------	-----	-----

*Replacement Upholstery Covers*

**TWO PLACE ADD-A-SEAT / WOOD ARMS / ACCEPTS SEAT ON RIGHT**

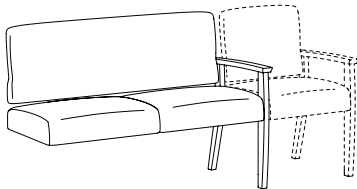

**Overall:** 49.75"w 24"d 34"h      **Arm:** 25"h      **COM:** 3.5 yds.  
**Seat:** 48"w 19"d 18.5"h      **Weight:** 62 lbs.      **COL:** n/a

COM	COL	1	2	3	4	5	6	7	8	9	10	L1	L2
-----	-----	---	---	---	---	---	---	---	---	---	----	----	----

<b>1849-C</b>	1684	N/A	1771	1860	1950	2039	2128	2218	2307	2396	2486	2575	N/A	N/A
---------------	------	-----	------	------	------	------	------	------	------	------	------	------	-----	-----

*Open Back / Tight Seat & Back / Removable Upholstery*

<b>1848-R</b>	194	N/A	362	451	540	630	719	808	898	987	1076	1166	N/A	N/A
---------------	-----	-----	-----	-----	-----	-----	-----	-----	-----	-----	------	------	-----	-----

*Replacement Upholstery Covers*

**TWO PLACE ADD-A-SEAT / WOOD ARMS / ACCEPTS TABLE ON RIGHT**

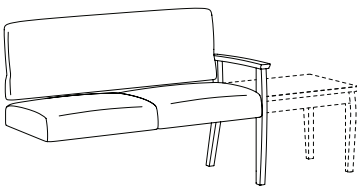

**Overall:** 49.75"w 24"d 34"h      **Arm:** 25"h      **COM:** 3.5 yds.  
**Seat:** 48"w 19"d 18.5"h      **Weight:** 62 lbs.      **COL:** n/a

COM	COL	1	2	3	4	5	6	7	8	9	10	L1	L2
-----	-----	---	---	---	---	---	---	---	---	---	----	----	----

<b>1849-T</b>	1684	N/A	1771	1860	1950	2039	2128	2218	2307	2396	2486	2575	N/A	N/A
---------------	------	-----	------	------	------	------	------	------	------	------	------	------	-----	-----

*Open Back / Tight Seat & Back / Removable Upholstery*

<b>1848-R</b>	194	N/A	362	451	540	630	719	808	898	987	1076	1166	N/A	N/A
---------------	-----	-----	-----	-----	-----	-----	-----	-----	-----	-----	------	------	-----	-----

*Replacement Upholstery Covers*

**DESCRIPTION:**

- Upholstery Frames: Steel, Plywood & Hardwood
- Seat: High Density Polyurethane Foam Over Strap Webbing
- Back: High Density Polyurethane Foam Over Plywood
- Upholstered Covers: Attached w/ Velcro / Removable For Maintenance
- Exposed Wood Legs: Solid Hardwood / Removable For Maintenance / Wallsaver Legs
- Antimicrobial Moisture Barrier Fully Encapsulates All Foam Areas
- Leather Upholstery Not Available
- Adjustable Height Leveling Glides Standard
- Lifetime Warranty

**OPTIONS:**

- EPAC-1 Black Polyester Arm Caps (Set Of 2).....\$355
- Closed Arm Panels (See 1800-PL / 1800-PR Item #'s)
- Specify Exposed Wood Finish (See Page 6)

*NOTE: All Seating Configurations Are Viewed From Left To Right Facing. Please Attach A Layout Showing Seating Configuration w/ Your Order. Assembled Units Must Be Shipped In Configurations Of 3 Or Less.*

**TANDEM**

**ITEM #: SPECIFICATIONS | GRADES | LIST PRICES:**

**TWO PLACE SOFA / URETHANE ARMS**

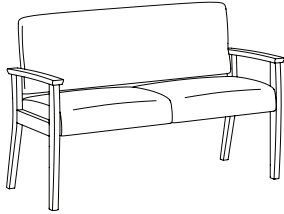

**Overall:** 51.5"w 24"d 34"h      **Arm:** 25"h      **COM:** 3.5 yds.  
**Seat:** 48"w 19"d 18.5"h      **Weight:** 65 lbs.      **COL:** n/a

COM	COL	1	2	3	4	5	6	7	8	9	10	L1	L2
1850	N/A	2031	2121	2210	2299	2389	2478	2568	2657	2746	2836	N/A	N/A
<i>Open Back / Tight Seat &amp; Back / Removable Upholstery</i>													
1848-R	N/A	362	451	540	630	719	808	898	987	1076	1166	N/A	N/A
<i>Replacement Upholstery Covers</i>													

**TWO PLACE SOFA / URETHANE ARMS / ACCEPTS SEAT ON RIGHT**

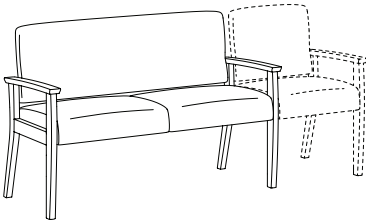

**Overall:** 51.5"w 24"d 34"h      **Arm:** 25"h      **COM:** 3.5 yds.  
**Seat:** 48"w 19"d 18.5"h      **Weight:** 65 lbs.      **COL:** n/a

COM	COL	1	2	3	4	5	6	7	8	9	10	L1	L2
1850-C	N/A	2031	2121	2210	2299	2389	2478	2568	2657	2746	2836	N/A	N/A
<i>Open Back / Tight Seat &amp; Back / Removable Upholstery</i>													
1848-R	N/A	362	451	540	630	719	808	898	987	1076	1166	N/A	N/A
<i>Replacement Upholstery Covers</i>													

**TWO PLACE SOFA / URETHANE ARMS / ACCEPTS TABLE ON RIGHT**

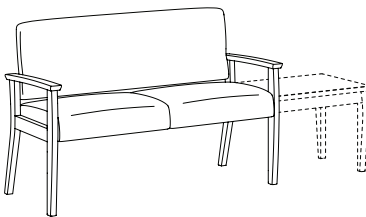

**Overall:** 51.5"w 24"d 34"h      **Arm:** 25"h      **COM:** 3.5 yds.  
**Seat:** 48"w 19"d 18.5"h      **Weight:** 65 lbs.      **COL:** n/a

COM	COL	1	2	3	4	5	6	7	8	9	10	L1	L2
1850-T	N/A	2031	2121	2210	2299	2389	2478	2568	2657	2746	2836	N/A	N/A
<i>Open Back / Tight Seat &amp; Back / Removable Upholstery</i>													
1848-R	N/A	362	451	540	630	719	808	898	987	1076	1166	N/A	N/A
<i>Replacement Upholstery Covers</i>													

**TWO PLACE SOFA / URETHANE ARMS / ACCEPTS TABLE ON LEFT**

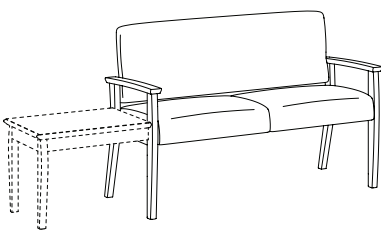

**Overall:** 51.5"w 24"d 34"h      **Arm:** 25"h      **COM:** 3.5 yds.  
**Seat:** 48"w 19"d 18.5"h      **Weight:** 65 lbs.      **COL:** n/a

COM	COL	1	2	3	4	5	6	7	8	9	10	L1	L2
1850-LT	N/A	2031	2121	2210	2299	2389	2478	2568	2657	2746	2836	N/A	N/A
<i>Open Back / Tight Seat &amp; Back / Removable Upholstery</i>													
1848-R	N/A	362	451	540	630	719	808	898	987	1076	1166	N/A	N/A
<i>Replacement Upholstery Covers</i>													

**DESCRIPTION:**

- Upholstery Frames: Steel, Plywood & Hardwood
- Seat: High Density Polyurethane Foam Over Strap Webbing
- Back: High Density Polyurethane Foam Over Plywood
- Upholstered Covers: Attached w/ Velcro / Removable For Maintenance
- Exposed Wood Legs: Solid Hardwood / Removable For Maintenance / Wallsaver Legs
- Antimicrobial Moisture Barrier Fully Encapsulates All Foam Areas
- Leather Upholstery Not Available
- Adjustable Height Leveling Glides Standard
- Lifetime Warranty

**OPTIONS:**

- EPAC-1 Black Polyester Arm Caps (Set Of 2).....\$355
- Closed Arm Panels (See 1800-PL / 1800-PR Item #'s)
- Specify Exposed Wood Finish (See Page 6)

*NOTE: All Seating Configurations Are Viewed From Left To Right Facing. Please Attach A Layout Showing Seating Configuration w/ Your Order. Assembled Units Must Be Shipped In Configurations Of 3 Or Less.*

**TANDEM**

ITEM #:

SPECIFICATIONS | GRADES | LIST PRICES:

**TWO PLACE SOFA / URETHANE ARMS /  
ACCEPTS TABLE ON LEFT / SEAT ON RIGHT**

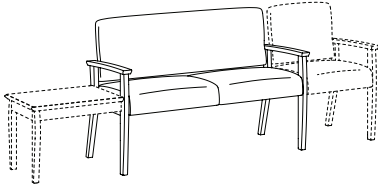

**1850-TC**

**1848-R**

<b>Overall: 51.5"w 24"d 34"h</b>		<b>Arm: 25"h</b>		<b>COM: 3.5 yds.</b>									
<b>Seat: 48"w 19"d 18.5"h</b>		<b>Weight: 65 lbs.</b>		<b>COL: n/a</b>									
COM	COL	1	2	3	4	5	6	7	8	9	10	L1	L2
1960	N/A	2031	2121	2210	2299	2389	2478	2568	2657	2746	2836	N/A	N/A
<i>Open Back / Tight Seat &amp; Back / Removable Upholstery</i>													
194	N/A	362	451	540	630	719	808	898	987	1076	1166	N/A	N/A
<i>Replacement Upholstery Covers</i>													

**TWO PLACE SOFA / URETHANE ARMS /  
ACCEPTS TABLE ON LEFT / RIGHT**

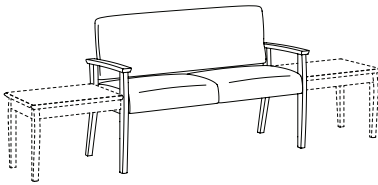

**1850-TT**

**1848-R**

<b>Overall: 51.5"w 24"d 34"h</b>		<b>Arm: 25"h</b>		<b>COM: 3.5 yds.</b>									
<b>Seat: 48"w 19"d 18.5"h</b>		<b>Weight: 65 lbs.</b>		<b>COL: n/a</b>									
COM	COL	1	2	3	4	5	6	7	8	9	10	L1	L2
1960	N/A	2031	2121	2210	2299	2389	2478	2568	2657	2746	2836	N/A	N/A
<i>Open Back / Tight Seat &amp; Back / Removable Upholstery</i>													
194	N/A	362	451	540	630	719	808	898	987	1076	1166	N/A	N/A
<i>Replacement Upholstery Covers</i>													

**DESCRIPTION:**

- Upholstery Frames: Steel, Plywood & Hardwood
- Seat: High Density Polyurethane Foam Over Strap Webbing
- Back: High Density Polyurethane Foam Over Plywood
- Upholstered Covers: Attached w/ Velcro / Removable For Maintenance
- Exposed Wood Legs: Solid Hardwood / Removable For Maintenance / Wallsaver Legs
- Antimicrobial Moisture Barrier Fully Encapsulates All Foam Areas
- Leather Upholstery Not Available
- Adjustable Height Leveling Glides Standard
- Lifetime Warranty

**OPTIONS:**

- EPAC-1 Black Polyester Arm Caps (Set Of 2).....\$355
- Closed Arm Panels (See 1800-PL / 1800-PR Item #'s)
- Specify Exposed Wood Finish (See Page 6)

*NOTE: All Seating Configurations Are Viewed From Left To Right Facing. Please Attach A Layout Showing Seating Configuration w/ Your Order. Assembled Units Must Be Shipped In Configurations Of 3 Or Less.*

**TANDEM**

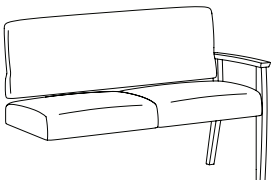
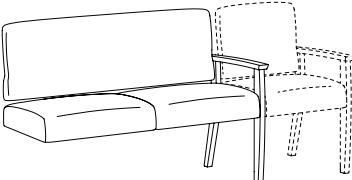
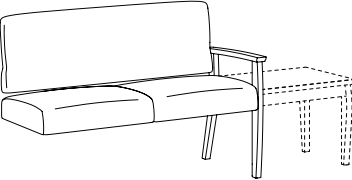
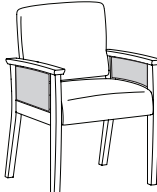
ITEM #:		SPECIFICATIONS   GRADES   LIST PRICES:													
<b>TWO PLACE ADD-A-SEAT / URETHANE ARMS</b>		<i>Overall: 49.75"w 24"d 34"h</i>		<i>Arm: 25"h</i>		<i>COM: 3.5 yds.</i>									
		<i>Seat: 48"w 19"d 18.5"h</i>		<i>Weight: 62 lbs.</i>		<i>COL: n/a</i>									
		<b>COM</b>	<b>COL</b>	<b>1</b>	<b>2</b>	<b>3</b>	<b>4</b>	<b>5</b>	<b>6</b>	<b>7</b>	<b>8</b>	<b>9</b>	<b>10</b>	<b>L1</b>	<b>L2</b>
	<b>1851</b>	1731	N/A	1815	1904	1994	2083	2172	2262	2351	2440	2530	2619	N/A	N/A
		<i>Open Back / Tight Seat &amp; Back / Removable Upholstery</i>													
	<b>1848-R</b>	194	N/A	362	451	540	630	719	808	898	987	1076	1166	N/A	N/A
		<i>Replacement Upholstery Covers</i>													
<b>TWO PLACE ADD-A-SEAT / URETHANE ARMS / ACCEPTS SEAT ON RIGHT</b>		<i>Overall: 49.75"w 24"d 34"h</i>		<i>Arm: 25"h</i>		<i>COM: 3.5 yds.</i>									
		<i>Seat: 48"w 19"d 18.5"h</i>		<i>Weight: 62 lbs.</i>		<i>COL: n/a</i>									
		<b>COM</b>	<b>COL</b>	<b>1</b>	<b>2</b>	<b>3</b>	<b>4</b>	<b>5</b>	<b>6</b>	<b>7</b>	<b>8</b>	<b>9</b>	<b>10</b>	<b>L1</b>	<b>L2</b>
	<b>1851-C</b>	1731	N/A	1815	1904	1994	2083	2172	2262	2351	2440	2530	2619	N/A	N/A
		<i>Open Back / Tight Seat &amp; Back / Removable Upholstery</i>													
	<b>1848-R</b>	194	N/A	362	451	540	630	719	808	898	987	1076	1166	N/A	N/A
		<i>Replacement Upholstery Covers</i>													
<b>TWO PLACE ADD-A-SEAT / URETHANE ARMS / ACCEPTS TABLE ON RIGHT</b>		<i>Overall: 49.75"w 24"d 34"h</i>		<i>Arm: 25"h</i>		<i>COM: 3.5 yds.</i>									
		<i>Seat: 48"w 19"d 18.5"h</i>		<i>Weight: 62 lbs.</i>		<i>COL: n/a</i>									
		<b>COM</b>	<b>COL</b>	<b>1</b>	<b>2</b>	<b>3</b>	<b>4</b>	<b>5</b>	<b>6</b>	<b>7</b>	<b>8</b>	<b>9</b>	<b>10</b>	<b>L1</b>	<b>L2</b>
	<b>1851-T</b>	1731	N/A	1815	1904	1994	2083	2172	2262	2351	2440	2530	2619	N/A	N/A
		<i>Open Back / Tight Seat &amp; Back / Removable Upholstery</i>													
	<b>1848-R</b>	194	N/A	362	451	540	630	719	808	898	987	1076	1166	N/A	N/A
		<i>Replacement Upholstery Covers</i>													
<b>CLOSED ARM PANELS</b>		<i>COM: .75 yds.</i>		<i>Weight: 10 lbs.</i>											
		<b>COM</b>	<b>COL</b>	<b>1</b>	<b>2</b>	<b>3</b>	<b>4</b>	<b>5</b>	<b>6</b>	<b>7</b>	<b>8</b>	<b>9</b>	<b>10</b>	<b>L1</b>	<b>L2</b>
	<b>1800-PL</b>	119	N/A	178	210	240	272	301	333	363	392	422	455	N/A	N/A
		<i>Left Facing Outside Arm Panel Set</i>													
	<b>1800-PR</b>	119	N/A	178	210	240	272	301	333	363	392	422	455	N/A	N/A
		<i>Right Facing Outside Arm Panel Set</i>													

**DESCRIPTION:**

- Edge Banding / Legs: Solid Maple
- Wilsonart Plastic Laminates Standard. Alternate Selections May Be Specified From Most Major Laminate Manufacturers. (Contact Factory For Availability)
- Metal Support Leg 1" - 16 Gauge Steel Leg w/ Adjustable Glide (Attaches Via 4.5" Mounting Plate) (#18SC2626 Only)
- Lifetime Warranty

**OPTIONS:**

Specify Exposed Wood Finish / Laminate (See Page 6)

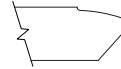

Evolve Edge Profile Standard

*NOTE: All Seating Configurations Are Viewed From Left To Right Facing. Please Attach A Layout Showing Seating Configuration w/ Your Order. Assembled Units Must Be Shipped In Configurations Of 3 Or Less.*

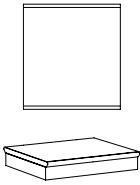
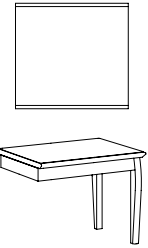
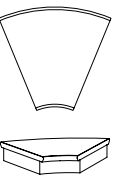
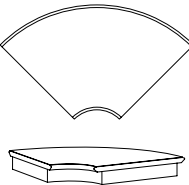
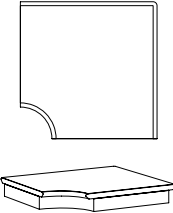
CONNECTING TABLES		ITEM #:	SPECIFICATIONS   GRADES   LIST PRICES:													
STRAIGHT DIVIDER TABLE			<b>Overall: 20"w 20"d 18"h</b>						<b>Weight: 45 lbs.</b>							
			COM	COL	1	2	3	4	5	6	7	8	9	10	L1	L2
	18C2020-L	678	High Pressure Laminate Face / Evolve Edge Profile Wood Band													
	18C2020-C	742	Solid Surface Top (Glacier White) / Evolve Edge Profile													
23" END TABLE			<b>Overall: 23"w 20"d 18"h</b>						<b>Weight: 35 lbs.</b>							
			COM	COL	1	2	3	4	5	6	7	8	9	10	L1	L2
	18E2320-L	810	High Pressure Laminate Face / Evolve Edge Profile Wood Band													
	18E2320-C	1298	Solid Surface Face (Glacier White) / Evolve Edge Profile													
45° CORNER TABLE			<b>Overall: 21"w 20"d 18"h</b>						<b>Weight: 30 lbs.</b>							
			COM	COL	1	2	3	4	5	6	7	8	9	10	L1	L2
	18RC45-L	638	High Pressure Laminate Face / Evolve Edge Profile Wood Band													
	18RC45-C	947	Solid Surface Face (Glacier White) / Evolve Edge Profile													
90° CORNER TABLE			<b>Overall: 26"w 26"d 18"h</b>						<b>Weight: 45 lbs.</b>							
			COM	COL	1	2	3	4	5	6	7	8	9	10	L1	L2
	18RC90-L	822	High Pressure Laminate Face / Evolve Edge Profile Wood Band													
	18RC90-C	1392	Solid Surface Face (Glacier White) / Evolve Edge Profile													
90° CORNER TABLE / METAL SUPPORT LEG			<b>Overall: 26"w 26"d 18"h</b>						<b>Weight: 48 lbs.</b>							
			COM	COL	1	2	3	4	5	6	7	8	9	10	L1	L2
	18SC2626-L	828	High Pressure Laminate Face / Evolve Edge Profile Wood Band													
	18SC2626-C	1701	Solid Surface Face (Glacier White) / Evolve Edge Profile													



**DESCRIPTION:**





- Edge Banding / Legs: Solid Maple
- Wilsonart Plastic Laminates Standard. Alternate Selections May Be Specified From Most Major Laminate Manufacturers. (Contact Factory For Availability)
- Lifetime Warranty

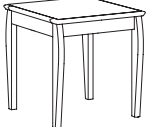
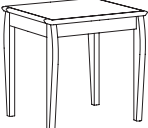

**OPTIONS:**

Specify Exposed Wood Finish / Laminate (See Page 6)



Evolve Edge Profile Standard

TABLES		ITEM #:	SPECIFICATIONS   GRADES   LIST PRICES:													
<b>24" CORNER TABLE</b>  			<b>Overall: 24"w 24"d 23"h</b>						<b>Weight: 35 lbs.</b>							
			COM	COL	1	2	3	4	5	6	7	8	9	10	L1	L2
	<b>182424-L</b>	926 <i>High Pressure Laminate Face / Evolve Edge Profile Wood Band</i>	<b>182424-C</b>	1315 <i>Solid Surface Face (Glacier White) / Evolve Edge Profile</i>												
<b>26" END TABLE</b>  			<b>Overall: 22"w 26"d 23"h</b>						<b>Weight: 38 lbs.</b>							
			COM	COL	1	2	3	4	5	6	7	8	9	10	L1	L2
	<b>182226-L</b>	1052 <i>High Pressure Laminate Face / Evolve Edge Profile Wood Band</i>	<b>182226-C</b>	1337 <i>Solid Surface Face (Glacier White) / Evolve Edge Profile</i>												
<b>42" RECTANGLE COFFEE TABLE</b>  			<b>Overall: 42"w 20"d 16"h</b>						<b>Weight: 40 lbs.</b>							
			COM	COL	1	2	3	4	5	6	7	8	9	10	L1	L2
	<b>184220-L</b>	1160 <i>High Pressure Laminate Face / Evolve Edge Profile Wood Band</i>	<b>184220-C</b>	1701 <i>Solid Surface Face (Glacier White) / Evolve Edge Profile</i>												
<b>26" ROUND END TABLE</b>  			<b>Overall: 26" Diameter 23"h</b>						<b>Weight: 28 lbs.</b>							
			COM	COL	1	2	3	4	5	6	7	8	9	10	L1	L2
	<b>1826D22-L</b>	1255 <i>High Pressure Laminate Face / Evolve Edge Profile Wood Band</i>	<b>1826D22-C</b>	1610 <i>Solid Surface Face (Glacier White) / Evolve Edge Profile</i>												
<b>34" ROUND COFFEE TABLE</b>  			<b>Overall: 34" Diameter 16"h</b>						<b>Weight: 50 lbs.</b>							
			COM	COL	1	2	3	4	5	6	7	8	9	10	L1	L2
	<b>1834D16-L</b>	1649 <i>High Pressure Laminate Face / Evolve Edge Profile Wood Band</i>	<b>1834D16-C</b>	2585 <i>Solid Surface Face (Glacier White) / Evolve Edge Profile</i>												

COVERS	OPTION #:	SPECIFICATIONS   LIST PRICES   AVAILABILITY:
<p>POLYESTER ARM CAPS</p> 	<p><b>EPAC-1</b></p> <p><i>Overall: 2.75"w 22.5"d 1.125"h</i></p> <hr/> <p><b>\$355 (Set Of 2) POLYESTER</b>  <i>Black Polyester Arm Cap (Additional Colors Available)</i></p> <p><i>Available: Facelift Evolve Guest / Tandem Collection (1822 / 1823 / 1832 / 1833 / 1850 / /1851)</i></p>	
<p>CONTRASTING COVERS</p> 	<p><i>Overall: N/A</i></p> <hr/> <p><b>CC</b> <b>\$129</b></p> <p><i>NOTE: If Two Or More Upholsteries Or Leathers Are Used On Any Piece Of Furniture, Then A Contrast Charge Will Apply Per Order. When Using Trinity Upholstery, The Higher Priced Upholstery Grade Will Be Used In Pricing, Unless It's Trinity Leather With Fabric Contrast Welt, Or COM With Trinity Contrast Welt, Then Contact Customer Service For Pricing.</i></p> <p><i>Available: Facelift Evolve Guest / Tandem Collection</i></p>	

# Facelift Evolve

---

HEALTHCARE MOTION

Effective: August 1, 2022

T R I N I T Y

**Date:**

**Page:**

**Modification:**

**Description:**

---

**DESCRIPTION:**

- Upholstery Frames: Steel, Plywood & Hardwood
- Seat: High Density Polyurethane Foam Over Strap Webbing
- Back: High Density Polyurethane Foam Over Sinuous Wire Springs
- Upholstered Covers: Attached w/ Velcro / Removable For Maintenance
- Exposed Wood Legs: Solid Hardwood / Removable For Maintenance
- Antimicrobial Moisture Barrier Fully Encapsulates All Foam Areas
- Leather Upholstery Not Available
- Lifetime Warranty

**OPTIONS:**

- Closed Arm Panels (See 1800-PL / 1800-PR Item #'s - Facelift Guest)
- Specify Exposed Wood Finish (See Page 6)

*NOTE: All Seating Configurations Are Viewed From Left To Right Facing. Please Attach A Layout Showing Seating Configuration w/ Your Order. Assembled Units Must Be Shipped In Configurations Of 3 Or Less.*

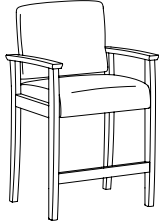
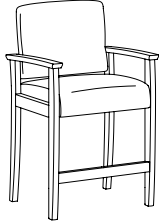
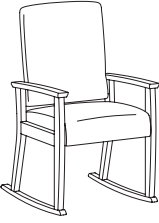
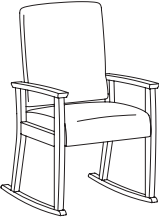
PATIENT	ITEM #:	SPECIFICATIONS   GRADES   LIST PRICES:													
		<b>Overall:</b> 23.75"w 24"d 38"h		<b>Arm:</b> 29.5"h					<b>COM:</b> 1.75 yds.						
		<b>Seat:</b> 20.25"w 19"d 24"h		<b>Weight:</b> 40 lbs.					<b>COL:</b> n/a						
		<b>COM</b>	<b>COL</b>	<b>1</b>	<b>2</b>	<b>3</b>	<b>4</b>	<b>5</b>	<b>6</b>	<b>7</b>	<b>8</b>	<b>9</b>	<b>10</b>	<b>L1</b>	<b>L2</b>
	<b>1820-H</b>	1238	N/A	1253	1294	1335	1376	1417	1459	1500	1541	1582	1624	N/A	N/A
		<i>Tight Seat &amp; Back / Removable Upholstery</i>													
	<b>1820-R</b>	131	N/A	206	247	288	330	371	412	453	495	536	577	N/A	N/A
		<i>Replacement Upholstery Covers</i>													
		<b>Overall:</b> 23.75"w 24"d 38"h		<b>Arm:</b> 29.5"h					<b>COM:</b> 1.75 yds.						
		<b>Seat:</b> 20.25"w 19"d 24"h		<b>Weight:</b> 40 lbs.					<b>COL:</b> n/a						
		<b>COM</b>	<b>COL</b>	<b>1</b>	<b>2</b>	<b>3</b>	<b>4</b>	<b>5</b>	<b>6</b>	<b>7</b>	<b>8</b>	<b>9</b>	<b>10</b>	<b>L1</b>	<b>L2</b>
	<b>1822-H</b>	1272	N/A	1286	1327	1368	1409	1450	1492	1533	1574	1615	1657	N/A	N/A
		<i>Tight Seat &amp; Back / Removable Upholstery</i>													
	<b>1820-R</b>	131	N/A	206	247	288	330	371	412	453	495	536	577	N/A	N/A
		<i>Replacement Upholstery Covers</i>													
		<b>Overall:</b> 23.5"w 28.75"d 45"h		<b>Arm:</b> 25"h					<b>COM:</b> 2.25 yds.						
		<b>Seat:</b> 20"w 19"d 18.5"h		<b>Weight:</b> 40 lbs.					<b>COL:</b> n/a						
		<b>COM</b>	<b>COL</b>	<b>1</b>	<b>2</b>	<b>3</b>	<b>4</b>	<b>5</b>	<b>6</b>	<b>7</b>	<b>8</b>	<b>9</b>	<b>10</b>	<b>L1</b>	<b>L2</b>
	<b>1824-RK</b>	1351	N/A	1387	1442	1497	1552	1607	1662	1717	1772	1827	1882	N/A	N/A
		<i>Tight Seat &amp; Back / Removable Upholstery</i>													
	<b>1824-R</b>	135	N/A	237	292	347	402	457	512	567	622	677	732	N/A	N/A
		<i>Replacement Upholstery Covers</i>													
		<i>See Available Footstools Next Page</i>													
		<b>Overall:</b> 23.5"w 28.75"d 45"h		<b>Arm:</b> 25"h					<b>COM:</b> 2.25 yds.						
		<b>Seat:</b> 20"w 19"d 18.5"h		<b>Weight:</b> 40 lbs.					<b>COL:</b> n/a						
		<b>COM</b>	<b>COL</b>	<b>1</b>	<b>2</b>	<b>3</b>	<b>4</b>	<b>5</b>	<b>6</b>	<b>7</b>	<b>8</b>	<b>9</b>	<b>10</b>	<b>L1</b>	<b>L2</b>
	<b>1825-RK</b>	1369	N/A	1404	1459	1514	1569	1624	1679	1734	1789	1844	1899	N/A	N/A
		<i>Tight Seat &amp; Back / Removable Upholstery</i>													
	<b>1824-R</b>	135	N/A	237	292	347	402	457	512	567	622	677	732	N/A	N/A
		<i>Replacement Upholstery Covers</i>													
		<i>See Available Footstools Next Page</i>													

**DESCRIPTION:**

- Upholstery Frames: Steel, Plywood & Hardwood
- Seat: High Density Polyurethane Foam Over Strap Webbing
- Back: High Density Polyurethane Foam Over Sinuous Wire Springs
- Upholstered Covers: Attached w/ Velcro / Removable For Maintenance
- Exposed Wood Legs: Solid Hardwood / Removable For Maintenance
- Antimicrobial Moisture Barrier Fully Encapsulates All Foam Areas
- Leather Upholstery Not Available
- Lifetime Warranty

**OPTIONS:**

- Closed Arm Panels (See 1800-PL / 1800-PR Item #'s - Facelift Guest)
- Specify Exposed Wood Finish (See Page 6)

*NOTE: All Seating Configurations Are Viewed From Left To Right Facing. Please Attach A Layout Showing Seating Configuration w/ Your Order. Assembled Units Must Be Shipped In Configurations Of 3 Or Less.*

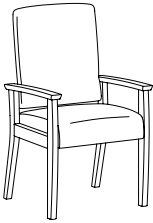
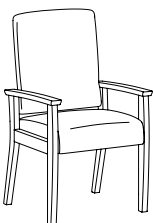
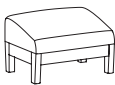
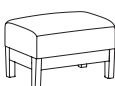
PATIENT CHAIR / FOOTSTOOL		ITEM #:	SPECIFICATIONS   GRADES   LIST PRICES:													
	<b>HIGH BACK PATIENT CHAIR / WOOD ARMS</b>		<b>Overall:</b> 23.5"w 26"d 45"h <b>Seat:</b> 20"w 19"d 18.5"h			<b>Arm:</b> 25"h <b>Weight:</b> 50 lbs.			<b>COM:</b> 2.25 yds. <b>COL:</b> n/a							
			<b>COM</b>	<b>COL</b>	<b>1</b>	<b>2</b>	<b>3</b>	<b>4</b>	<b>5</b>	<b>6</b>	<b>7</b>	<b>8</b>	<b>9</b>	<b>10</b>	<b>L1</b>	<b>L2</b>
		<b>1824</b>	1316	N/A	1341	1389	1437	1475	1533	1581	1629	1677	1726	1774	N/A	N/A
		<b>1824-R</b>	135	N/A	237	292	347	402	457	512	567	622	677	732	N/A	N/A
	<b>Headrest/Lumbar</b>	70	N/A	93	106	121	135	148	162	175	190	203	217	N/A	N/A	
See Available Footstools Below																
	<b>HIGH BACK PATIENT CHAIR / URETHANE ARMS</b>		<b>Overall:</b> 23.5"w 26"d 45"h <b>Seat:</b> 20"w 19"d 18.5"h			<b>Arm:</b> 25"h <b>Weight:</b> 50 lbs.			<b>COM:</b> 2.25 yds. <b>COL:</b> n/a							
			<b>COM</b>	<b>COL</b>	<b>1</b>	<b>2</b>	<b>3</b>	<b>4</b>	<b>5</b>	<b>6</b>	<b>7</b>	<b>8</b>	<b>9</b>	<b>10</b>	<b>L1</b>	<b>L2</b>
		<b>1825</b>	1322	N/A	1360	1415	1470	1525	1580	1635	1690	1745	1800	1855	N/A	N/A
		<b>1824-R</b>	135	N/A	237	292	347	402	457	512	567	622	677	732	N/A	N/A
	<b>Headrest/Lumbar</b>	70	N/A	93	106	121	135	148	162	175	190	203	217	N/A	N/A	
See Available Footstools Below																
	<b>OTTOMAN / FOOTSTOOL / SLOPED / STOWS UNDER ALL PATIENT &amp; GLIDER CHAIRS</b>		<b>Overall:</b> 18"w 15"d 12"h <b>Seat:</b> n/a			<b>Arm:</b> n/a <b>Weight:</b> 27 lbs.			<b>COM:</b> 1.25 yds. <b>COL:</b> n/a							
			<b>COM</b>	<b>COL</b>	<b>1</b>	<b>2</b>	<b>3</b>	<b>4</b>	<b>5</b>	<b>6</b>	<b>7</b>	<b>8</b>	<b>9</b>	<b>10</b>	<b>L1</b>	<b>L2</b>
		<b>1834</b>	360	N/A	395	422	450	477	505	532	560	587	615	642	N/A	N/A
		<b>1834-R</b>	75	N/A	126	153	181	208	236	263	291	318	346	373	N/A	N/A
	<b>OTTOMAN / FOOTSTOOL / FLAT / STOWS UNDER ALL PATIENT &amp; GLIDER CHAIRS</b>		<b>Overall:</b> 18"w 15"d 12"h <b>Seat:</b> n/a			<b>Arm:</b> n/a <b>Weight:</b> 27 lbs.			<b>COM:</b> 1.25 yds. <b>COL:</b> n/a							
			<b>COM</b>	<b>COL</b>	<b>1</b>	<b>2</b>	<b>3</b>	<b>4</b>	<b>5</b>	<b>6</b>	<b>7</b>	<b>8</b>	<b>9</b>	<b>10</b>	<b>L1</b>	<b>L2</b>
		<b>1835</b>	383	N/A	417	444	472	499	527	554	582	609	637	664	N/A	N/A
		<b>1835-R</b>	75	N/A	126	153	181	208	236	263	291	318	346	373	N/A	N/A

**DESCRIPTION:**

- Upholstery Frames: Steel, Plywood & Hardwood
- Seat: High Density Polyurethane Foam Over Sheet Webbing
- Back: High Density Polyurethane Foam Over Polypropylene Webbing
- Upholstered Covers: Attached w/ Velcro / Removable For Maintenance
- Removable Bolster Pillow For 1845 / 1846 (5" Diameter)
- Antimicrobial Moisture Barrier Fully Encapsulates All Foam Areas
- Double Needle Stitching Standard
- Metal To Metal Connections For All Hardware Assembly
- Leather Upholstery Not Available
- Lifetime Warranty

**OPTIONS:**

- EWAC-1 Solid Wood Arm Caps (Set Of 2) .....\$219
  - EUAC-1 Black Urethane Arm Caps (Set Of 2).....\$231
  - EPAC-2 Black Polyester Arm Caps (Set Of 2).....\$382
  - ILC In-Line Casters (Set Of 2).....\$57
  - LC Locking Casters (Set Of 2).....\$31
  - NLC Non-Locking Casters (Set Of 2).....\$26
  - 3LC 3" Locking Casters - #1847 Model Only (Set Of 2).....\$208
  - PM1 Power/Data Module (1-Power / 1-USB 2 Port Simplex Charger) .....\$836
- Feather Down & Polyester Pillows Available (See Page 5)  
Specify Exposed Wood Finish (See Page 6)  
Tablet Arm / Cup Holder Options (See Facelift Evolve Healthcare Options Pages)

**SLEEPOVER UNITS**      **ITEM #:**      **SPECIFICATIONS | GRADES | LIST PRICES:**

LOUNGE CHAIR / FULLY UPHOLSTERED		Overall: 33.5"w 34.5"d 33"h												Overall Length: 84"d		Arm: 24"h		COM: 6.5 yds.	
		Sleep Area: 28"w 80"d												Seat: 28"w 23"d 17.5"h		Weight: 175 lbs.		COL: n/a	
COM	COL	1	2	3	4	5	6	7	8	9	10	L1	L2						
1845	N/A	4579	4751	4923	5095	5266	5438	5610	5782	5954	6125	N/A	N/A	Tight Seat & Back / Removable Upholstery / 500 lbs. Weight Capacity					
1845-R	N/A	282	611	782	954	1126	1298	1470	1641	1813	1985	2157	N/A	N/A	Replacement Upholstery Covers				

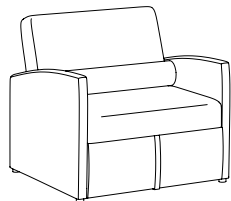

Healthcare Motion

TWO PLACE SOFA / FULLY UPHOLSTERED		Overall: 53"w 34.5"d 33"h												Overall Length: 84"d		Arm: 24"h		COM: 9 yds.	
		Sleep Area: 48"w 80"d												Seat: 48"w 23"d 17.5"h		Weight: 220 lbs.		COL: n/a	
COM	COL	1	2	3	4	5	6	7	8	9	10	L1	L2						
1846	N/A	5885	6125	6366	6606	6847	7087	7328	7568	7809	8049	N/A	N/A	Tight Seat & Back / Removable Upholstery / 500 lbs. Weight Capacity					
1846-R	N/A	336	799	1040	1280	1521	1761	2002	2242	2483	2723	2964	N/A	N/A	Replacement Upholstery Covers				

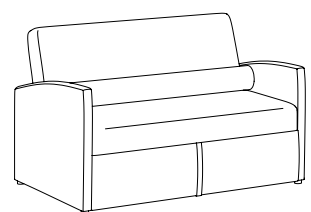

Healthcare Motion

**FOUR POSITION ADJUSTMENT FOR 1845 / 1846**

See **Replay Healthcare Motion And Revival Healthcare Motion (Page 242)** For Additional Sleepover Units.



BACK-FLIP SLEEPER SOFA		Overall: 76"w 36"d 36"h												Arm: 24.5"h		COM: 12.25 yds.		
		Sleep Area: 70"w 31"d 20"h												Weight: 235 lbs.		COL: n/a		
COM	COL	1	2	3	4	5	6	7	8	9	10	L1	L2					
1847	N/A	4539	4869	5199	5529	5859	6189	6518	6848	7178	7508	N/A	N/A	Tight Seat & Back / Removable Upholstery / 1000 lbs. Weight Capacity				
1847-R	N/A	1091	1691	2021	2351	2681	3010	3340	3670	4000	4330	4660	N/A	N/A	Replacement Upholstery Covers			

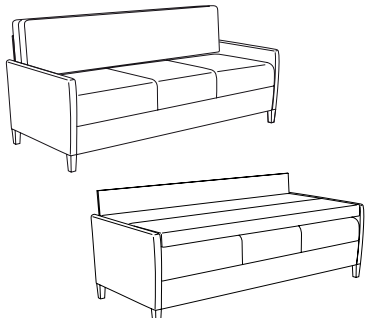







**DESCRIPTION:**

- Upholstery Frames: Steel, Plywood & Hardwood
- Seat: High Density Polyurethane Foam Over Sheet Webbing
- Back: High Density Polyurethane Foam Over Polypropylene Webbing
- Upholstered Covers: Attached w/ Velcro / Removable For Maintenance
- Antimicrobial Moisture Barrier Fully Encapsulates All Foam Areas
- Double Needle Stitching Standard
- Exposed Wood Legs: Solid Hardwood / Removable For Maintenance
- Leather Upholstery Not Available
- Lifetime Warranty

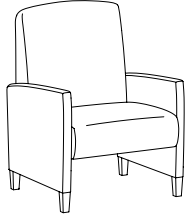
**OPTIONS:**

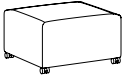
- EWAC-1 Solid Wood Arm Caps (Set Of 2) .....\$219
- EUAC-1 Black Urethane Arm Caps (Set Of 2).....\$231
- EPAC-2 Black Polyester Arm Caps (Set Of 2).....\$382
- ARL Brushed Aluminum Round Legs (Set Of 4).....\$353
- WR Wood Ring Base - Replaces Metal Base On 1854-G/1854-SG .....\$224
- PM1 Power/Data Module (1-Power / 1-USB 2 Port Simplex Charger) .....\$836

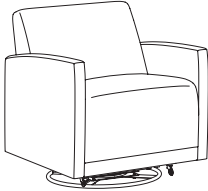
Feather Down & Polyester Pillows Available (See Page 5)  
 Specify Exposed Wood Finish (See Page 6)  
 Tablet Arm / Cup Holder Options (See Facelift Evolve Healthcare Options Pages)

PATIENT CHAIR / GLIDER		ITEM #:	SPECIFICATIONS   GRADES   LIST PRICES:													
	<b>ASYNCHRONOUS PATIENT CHAIR / FULLY UPHOLSTERED</b>		<b>Overall:</b> 25"w 33.5"d 39.25"h				<b>Arm:</b> 24.25"h				<b>COM:</b> 4.25 yds.					
			<b>Seat:</b> 21"w 20"d 18.75"h				<b>Weight:</b> 63 lbs.				<b>COL:</b> n/a					
			<b>COM</b>	<b>COL</b>	<b>1</b>	<b>2</b>	<b>3</b>	<b>4</b>	<b>5</b>	<b>6</b>	<b>7</b>	<b>8</b>	<b>9</b>	<b>10</b>	<b>L1</b>	<b>L2</b>
	<b>1852</b>		1544	N/A	1715	1842	1969	2097	2224	2351	2478	2606	2733	2860	N/A	N/A
		<i>Tight Seat &amp; Back / Removable Upholstery</i>														
	<b>1852-R</b>	211	N/A	420	529	639	749	859	969	1079	1189	1299	1409	N/A	N/A	
		<i>Replacement Upholstery Covers</i>														
																
	<b>OTTOMAN ON CASTERS / STOWS UNDER ALL PATIENT CHAIRS</b>		<b>Overall:</b> 18"w 18"d 11"h				<b>Arm:</b> n/a				<b>COM:</b> 1 yd.					
			<b>Seat:</b> n/a				<b>Weight:</b> 25 lbs.				<b>COL:</b> n/a					
			<b>COM</b>	<b>COL</b>	<b>1</b>	<b>2</b>	<b>3</b>	<b>4</b>	<b>5</b>	<b>6</b>	<b>7</b>	<b>8</b>	<b>9</b>	<b>10</b>	<b>L1</b>	<b>L2</b>
	<b>1809</b>		368	N/A	389	410	430	451	472	492	513	534	554	575	N/A	N/A
		<i>Removable Upholstery</i>														
	<b>1809-R</b>	81	N/A	118	139	159	180	201	221	242	262	283	304	N/A	N/A	
		<i>Replacement Upholstery Covers</i>														
																
	<b>LOUNGE GLIDER / FULLY UPHOLSTERED</b>		<b>Overall:</b> 27"w 32"d 35"h				<b>Arm:</b> 24"h				<b>COM:</b> 4.5 yds.					
			<b>Seat:</b> 21"w 20"d 18"h				<b>Weight:</b> 115 lbs.				<b>COL:</b> n/a					
			<b>COM</b>	<b>COL</b>	<b>1</b>	<b>2</b>	<b>3</b>	<b>4</b>	<b>5</b>	<b>6</b>	<b>7</b>	<b>8</b>	<b>9</b>	<b>10</b>	<b>L1</b>	<b>L2</b>
	<b>1854-G</b>		1821	N/A	1955	2072	2189	2305	2422	2539	2656	2773	2890	3006	N/A	N/A
		<i>Circular Metal Base / Tight Seat &amp; Back / Removable Upholstery</i>														
	<b>1854-SG</b>	1943	N/A	2070	2187	2304	2421	2538	2655	2771	2888	3005	3122	N/A	N/A	
		<i>Swivel Glider w/ Circular Metal Base / Tight Seat &amp; Back / Removable Upholstery</i>														
	<b>1854-R</b>	219	N/A	440	557	674	791	908	1025	1141	1258	1375	1492	N/A	N/A	
		<i>Replacement Upholstery Covers</i>														
																
		 <b>See Replay Healthcare Motion And Revival Healthcare Motion For Additional Patient Chairs &amp; Gliders.</b>														











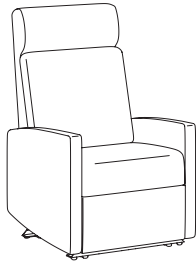

**DESCRIPTION:**

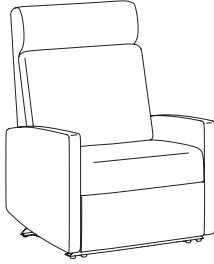
- Upholstery Frames: Steel, Plywood & Hardwood
- Seat: High Density Polyurethane Foam Over Sheet Webbing
- Back: High Density Polyurethane Foam Over Sinuous Wire Springs
- Upholstered Covers: Attached w/ Velcro / Removable For Maintenance
- Antimicrobial Moisture Barrier Fully Encapsulates All Foam Areas
- Double Needle Stitching Standard (Weltting Optional - No Charge)
- Dual-Wheel Casters: (2) Front Locking/Swivel & (2) Rear Non-Locking/Non-Swivel (1865)
- (2) Drop Down Side Trays Mounted To Black Metal Tubing (1865)
- Leather Upholstery Not Available
- Lifetime Warranty

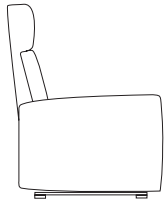
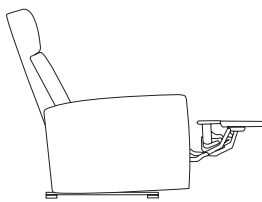
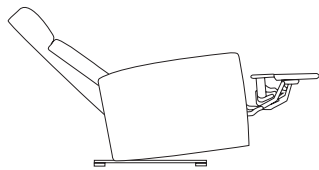
**OPTIONS:**

(See Facelift Evolve Healthcare Options Pages)

Feather Down & Polyester Pillows Available (See Page 5)

WALLSAVER / INFUSION RECLINER		ITEM #:	SPECIFICATIONS   GRADES   LIST PRICES:													
	<b>WALLSAVER RECLINER / FULLY UPHOLSTERED</b>		<b>Overall:</b> 27"w 34"d 41.5"h			<b>Arm:</b> 23"h			<b>COM:</b> 4.75 yds.							
	<b>Seat:</b> 21"w 21.5"d 18"h			<b>Weight:</b> 110 lbs.			<b>COL:</b> n/a									
				<b>COM</b>	<b>COL</b>	<b>1</b>	<b>2</b>	<b>3</b>	<b>4</b>	<b>5</b>	<b>6</b>	<b>7</b>	<b>8</b>	<b>9</b>	<b>10</b>	<b>L1</b>
	<b>1855</b>		1971	N/A	2150	2293	2436	2579	2722	2865	3009	3152	3295	3438	N/A	N/A
			<i>Tight Seat &amp; Back / Removable Upholstery / 6" Wall Proximity / 350 lb. Weight Capacity</i>													
	<b>1855-R</b>		253	N/A	487	610	734	858	981	1105	1229	1352	1476	1600	N/A	N/A
			<i>Replacement Upholstery Covers</i>													
	Healthcare Motion															
	<b>BARIATRIC WALLSAVER RECLINER / FULLY UPHOLSTERED</b>		<b>Overall:</b> 32"w 34"d 41.5"h			<b>Arm:</b> 23"h			<b>COM:</b> 5.25 yds.							
	<b>Seat:</b> 26"w 21.5"d 18"h			<b>Weight:</b> 120 lbs.			<b>COL:</b> n/a									
				<b>COM</b>	<b>COL</b>	<b>1</b>	<b>2</b>	<b>3</b>	<b>4</b>	<b>5</b>	<b>6</b>	<b>7</b>	<b>8</b>	<b>9</b>	<b>10</b>	<b>L1</b>
	<b>1855-X</b>		2031	N/A	2239	2398	2557	2716	2875	3034	3193	3352	3511	3670	N/A	N/A
			<i>Tight Seat &amp; Back / Removable Upholstery / 6" Wall Proximity / 500 lb. Weight Capacity</i>													
	<b>1855-XR</b>		259	N/A	520	657	794	932	1069	1207	1344	1482	1619	1757	N/A	N/A
			<i>Replacement Upholstery Covers</i>													
	Healthcare Motion															
	See <i>Replay Healthcare Motion And Revival Healthcare Motion For Additional Wallsaver Recliners.</i>															
																
			Upright Position 34"D	Extended Footrest Position 54.5"D	Full Recline Position 65.5"D											
	<b>INFUSION WALLSAVER RECLINER / FULLY UPHOLSTERED</b>		<b>Overall:</b> 26.25"w 34"d 46"h			<b>Arm:</b> 27"h			<b>COM:</b> 5 yds.							
	<b>Seat:</b> 21"w 20.5"d 19"h			<b>Weight:</b> 130 lbs.			<b>COL:</b> n/a									
				<b>COM</b>	<b>COL</b>	<b>1</b>	<b>2</b>	<b>3</b>	<b>4</b>	<b>5</b>	<b>6</b>	<b>7</b>	<b>8</b>	<b>9</b>	<b>10</b>	<b>L1</b>
	<b>1865</b>		2856	N/A	2991	3136	3282	3427	3573	3718	3864	4009	4155	4300	N/A	N/A
			<i>Tight Seat &amp; Back / Removable Upholstery / 350 lb. Weight Capacity</i>													
	<b>1865-R</b>		281	N/A	568	719	871	1022	1173	1324	1475	1626	1778	1929	N/A	N/A
			<i>Replacement Upholstery Covers</i>													
	Healthcare Motion															
	See <i>Replay &amp; Revival Healthcare Motion For Additional Infusion Wallsaver Recliners.</i>															
																
			Upright Position 32"D	Extended Footrest Position 52"D	Full Recline Position 64.5"D											
			Optional Central Braking Available													

**DESCRIPTION:**

- Upholstery Frames: Steel, Plywood & Hardwood
- Seat: High Density Polyurethane Foam Over Sheet Webbing
- Back: High Density Polyurethane Foam Over Sinuous Wire Springs
- Upholstered Covers: Attached w/ Velcro / Removable For Maintenance
- Antimicrobial Moisture Barrier Fully Encapsulates All Foam Areas
- Double Needle Stitching Standard (Welting Optional - No Charge)
- Rotational & Directional Locking Casters (Rear)
- Leather Upholstery Not Available
- Lifetime Warranty

**OPTIONS:**

Layflat Medical Recliner Options (See Facelift Evolve Healthcare Options Pages)  
 Feather Down & Polyester Pillows Available (See Page 5)

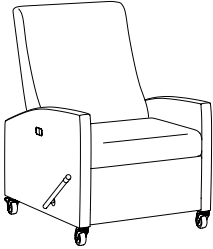
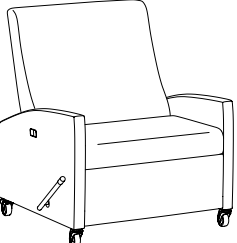
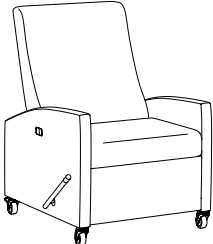
LAYFLAT MEDICAL RECLINER	ITEM #:	SPECIFICATIONS   GRADES   LIST PRICES:													
 <p>Healthcare Motion</p>	<b>LAYFLAT / TRENDELENBURG RECLINER</b>	<b>Overall:</b> 30"w 38.5"d 45"h		<b>Arm:</b> 28"h					<b>COM:</b> 5.5 yds.						
		<b>Seat:</b> 24"w 20"d 20"h		<b>Weight:</b> 175 lbs.					<b>COL:</b> n/a						
		<b>COM</b>	<b>COL</b>	<b>1</b>	<b>2</b>	<b>3</b>	<b>4</b>	<b>5</b>	<b>6</b>	<b>7</b>	<b>8</b>	<b>9</b>	<b>10</b>	<b>L1</b>	<b>L2</b>
	<b>1857-L</b>	3482	N/A	3626	3794	3961	4128	4295	4462	4629	4796	4963	5130	N/A	N/A
	<b>1857-T</b>	3617	N/A	3754	3921	4088	4255	4422	4589	4756	4923	5090	5257	N/A	N/A
	<b>1857-R</b>	285	N/A	558	703	847	991	1136	1280	1424	1569	1713	1857	N/A	N/A
		<i>Replacement Upholstery Covers</i>													
 <p>Healthcare Motion</p>	<b>BARIATRIC LAYFLAT / TRENDELENBURG RECLINER</b>	<b>Overall:</b> 35"w 38.5"d 45"h		<b>Arm:</b> 28"h					<b>COM:</b> 6 yds.						
		<b>Seat:</b> 29"w 20"d 20"h		<b>Weight:</b> 200 lbs.					<b>COL:</b> n/a						
		<b>COM</b>	<b>COL</b>	<b>1</b>	<b>2</b>	<b>3</b>	<b>4</b>	<b>5</b>	<b>6</b>	<b>7</b>	<b>8</b>	<b>9</b>	<b>10</b>	<b>L1</b>	<b>L2</b>
	<b>1857-XL</b>	3603	N/A	3773	3956	4139	4322	4505	4688	4870	5053	5236	5419	N/A	N/A
	<b>1857-XT</b>	3752	N/A	3913	4096	4279	4462	4645	4828	5010	5193	5376	5559	N/A	N/A
	<b>1857-XR</b>	291	N/A	591	749	907	1065	1224	1382	1540	1698	1856	2014	N/A	N/A
		<i>Replacement Upholstery Covers</i>													
 <p>Healthcare Motion</p>	<b>LAYFLAT GLIDER / RECLINER</b>	<b>Overall:</b> 28"w 38.5"d 45"h		<b>Arm:</b> 27"h					<b>COM:</b> 5.5 yds.						
		<b>Seat:</b> 23"w 20"d 19"h		<b>Weight:</b> 175 lbs.					<b>COL:</b> n/a						
		<b>COM</b>	<b>COL</b>	<b>1</b>	<b>2</b>	<b>3</b>	<b>4</b>	<b>5</b>	<b>6</b>	<b>7</b>	<b>8</b>	<b>9</b>	<b>10</b>	<b>L1</b>	<b>L2</b>
	<b>1857-LG</b>	4007	N/A	4155	4338	4521	4703	4886	5069	5252	5435	5618	5801	N/A	N/A
	<b>1857-LGR</b>	285	N/A	558	703	847	991	1136	1280	1424	1569	1713	1857	N/A	N/A
		<i>Replacement Upholstery Covers</i>													

 See **Replay Healthcare Motion And Revival Healthcare Motion For Additional Layflat Medical Recliners.**

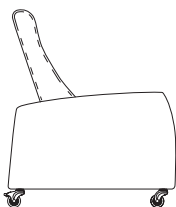

Upright Position  
38.5"D

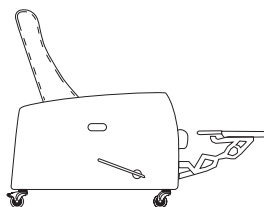

Extended Footrest Position  
57.5"D

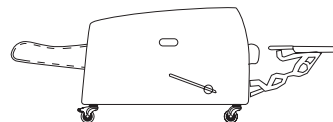



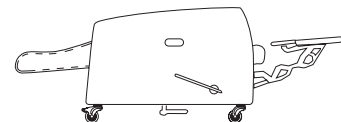





Layflat Position  
73.75"D



Trendelenburg Position  
74.75"D

ARM CAPS / TABLET ARMS	OPTION #:	SPECIFICATIONS   LIST PRICES   AVAILABILITY:
<p><b>SOLID WOOD / URETHANE / POLYESTER ARM CAPS</b> (Upholstered Arm Chairs)</p>   	<p><b>Overall:</b> 2.75"w 29"d 1.125"h</p> <p><b>EWAC-1</b> \$219 (Set Of 2) WOOD (1845 / 1846 Sleepover Lounge) - Specify Finish (1852 Asynchronous Patient Chair) - Specify Finish (1854-G Lounge Glider / 1854-SG Lounge Swivel Glider) - Specify Finish (1855 Wallsaver Recliner / 1855-X Bariatric Wallsaver Recliner) - Specify Finish (1857-L &amp; 1857-T Medical Recliners / 1857-XL &amp; 1857-XT Bariatric Medical Recliners) - Specify Finish</p> <p><b>EUAC-1</b> \$231 (Set Of 2) URETHANE (1845 / 1846 Sleepover Lounge) (1852 Asynchronous Patient Chair) (1854-G Lounge Glider / 1854-SG Lounge Swivel Glider) (1855 Wallsaver Recliner / 1855-X Bariatric Wallsaver Recliner) (1857-L &amp; 1857-T Medical Recliners / 1857-XL &amp; 1857-XT Bariatric Medical Recliners)</p> <p><b>EPAC-2</b> \$382 (Set Of 2) POLYESTER (1845 / 1846 Sleepover Lounge) (1852 Asynchronous Patient Chair) (1854-G Lounge Glider / 1854-SG Lounge Swivel Glider) (1855 Wallsaver Recliner / 1855-X Bariatric Wallsaver Recliner) (1857-L &amp; 1857-T Medical Recliners / 1857-XL &amp; 1857-XT Bariatric Medical Recliners)</p> <p><i>Black Polyester Arm Cap (Additional Colors Available)</i></p>	
<p><b>TABLET ARMS / CUP HOLDER</b></p>  <p>Laminate Tablet Arm Shown w/ Cup Holder</p>  <p>Veneer Tablet Arm Shown w/ Cup Holder</p>  <p>Solid Surface Tablet Arm Shown w/ Cup Holder</p>	<p><b>Overall:</b> 14" Diameter .75"h</p> <p><b>TA-L</b> \$440 <i>Tablet Arm With 360° Rotation - High Pressure Laminate. (Specify Laminate / Specify Left Or Right Facing Arm Location)</i></p> <p><b>TA-V</b> \$503 <i>Tablet Arm With 360° Rotation - Sunburst Cherry Veneer. (Specify Finish / Specify Left Or Right Facing Arm Location)</i></p> <p><b>TA-C</b> \$654 <i>Tablet Arm With 360° Rotation - White Solid Surface. (Available In White Only / Specify Left Or Right Facing Arm Location)</i></p> <p><b>CH-1</b> \$105 <i>Black Plastic Cup Holder (Only Available If Used With Tablet Arm)</i></p> <p><b>CH-2</b> \$157 <i>Spun Aluminum Cup Holder (Only Available If Used With Tablet Arm)</i></p> <p><b>Available:</b> <i>Facelift Evolve Healthcare Collection</i></p>	
<p><b>FOLD DOWN TABLET ARM</b></p>  	<p><b>Overall:</b> 14" Diameter .75"h</p> <p><b>FDTA-L</b> \$1056 <i>Tablet Arm With 360° Rotation - High Pressure Laminate. (Specify Laminate / Specify Left Or Right Facing Arm Location)</i></p> <p><b>FDTA-V</b> \$1108 <i>Tablet Arm With 360° Rotation - Sunburst Cherry Veneer. (Specify Finish / Specify Left Or Right Facing Arm Location)</i></p> <p><b>FDTA-C</b> \$1259 <i>Tablet Arm With 360° Rotation - White Solid Surface. (Available In White Only / Specify Left Or Right Facing Arm Location)</i></p> <p><b>Available:</b> <i>Facelift Evolve Healthcare Collection</i></p>	

TABLET ARMS / POWER / CASTERS	OPTION #:	SPECIFICATIONS   LIST PRICES   AVAILABILITY:
<p><b>DOUBLE ARTICULATING / SWIVEL TABLET ARM</b></p>  <p>ATA-L Double Articulating / Swivel Tablet Arm</p>  <p>ATA-L w/ CH-1 Black Plastic Cup Holder</p>	<p><b>Overall:</b> 14" Diameter .75"h</p> <hr/> <p><b>ATA-L</b> \$865 <i>Tablet Arm With 360° Rotation - High Pressure Laminate. (Specify Laminate / Specify Left Or Right Facing Arm Location)</i></p> <p><b>ATA-V</b> \$904 <i>Tablet Arm With 360° Rotation - Sunburst Cherry Veneer. (Specify Finish / Specify Left Or Right Facing Arm Location)</i></p> <p><b>ATA-C</b> \$1089 <i>Tablet Arm With 360° Rotation - White Solid Surface. (Available In White Only / Specify Left Or Right Facing Arm Location)</i></p> <p><b>CH-1</b> \$105 <i>Black Plastic Cup Holder (Only Available If Used With Tablet Arm)</i></p> <p><b>CH-2</b> \$157 <i>Spun Aluminum Cup Holder (Only Available If Used With Tablet Arm)</i></p> <p><b>Available:</b> <i>Facelift Evolve Healthcare Collection</i></p>	
<p><b>POWER / DATA MODULE</b></p> 	<p><b>Overall:</b> 5.25"w 1.25"d 4.25"h</p> <hr/> <p><b>PM1</b> \$836 (1-Power / 1-USB 2 Port Simplex Charger Standard) <i>Vertical / Horizontal Mount Power Module. Price Varies By Socket. Contact Customer Service For Quote. (Additional Colors Available)</i></p> <p><b>Available:</b> <i>Facelift Evolve Sleepover Lounge (1844-1845 Models)</i></p>	
<p><b>IN-LINE CASTERS</b></p> 	<p><b>Overall:</b> 2.75" Diameter 1.75"h</p> <hr/> <p><b>ILC</b> \$57 (Set Of Two) <i>Single Direction In-Line Caster (Non-Locking / Specify Wood Finish / Specify Location)</i></p> <p><b>Available:</b> <i>Facelift Evolve Sleepover Lounge (1844-1845 Models)</i></p>	
<p><b>LOCKING / NON-LOCKING CASTERS</b></p>  <p>Locking Casters</p>  <p>Non-Locking Casters</p>	<p><b>Overall:</b> 1.875"w 2.25"d 1.5"h (Locking) / 1.875"w 1.625"d 1.5"h (Non-Locking)</p> <hr/> <p><b>LC</b> \$31 (Set Of Two) <i>Locking Casters (Black Finish / Specify Location)</i></p> <p><b>NLC</b> \$26 (Set Of Two) <i>Non-Locking Casters (Black Finish / Specify Location)</i></p> <p><b>Available:</b> <i>Facelift Evolve Sleepover Lounge (1844-1845 Models)</i></p>	

CASTERS / BRAKE / LEGS / ELECTRIC / FOLD DOWN ARM	OPTION #:	SPECIFICATIONS   LIST PRICES   AVAILABILITY:
<p><b>MEDICAL LOCKING / NON-LOCKING CASTERS</b></p>  <p>Locking Casters</p>  <p>Non-Locking Casters</p>	<p><b>MLC</b></p> <p><b>MNLC</b></p>	<p><b>Overall:</b> 2.25"w 5"d 5.25"h (Locking) / 2"w 3.75"d 5.25"h (Non-Locking)</p> <hr/> <p>\$179 (Set Of Two) <i>Locking Casters - Motion &amp; Direction (Gray Finish / Specify Location)</i></p> <p>\$205 (Set Of Two) <i>Non-Locking Casters - Single Direction (Gray Finish / Specify Location)</i></p> <p><b>Available:</b> <i>Facelift Evolve Medical Recliners</i></p>
<p><b>CENTRAL BRAKING</b></p> 	<p><b>CB-1</b></p>	<p><b>Overall:</b> 7.5"w 2"d .5"h</p> <hr/> <p>\$405 (Set Of 1) <i>(White Plastic Brake w/ Lock &amp; Unlock Pedals)</i></p> <p><b>Available:</b> <i>Facelift Evolve Wallsaver &amp; Infusion Wallsaver Recliners</i></p>
<p><b>BRUSHED ALUMINUM ROUND LEGS</b></p> 	<p><b>ARL</b></p>	<p><b>Overall:</b> 2" Diameter 5"h</p> <hr/> <p>\$353 (Set Of 4) <i>(Brushed Aluminum Finish)</i></p> <p><b>Available:</b> <i>Facelift Evolve Asynchronous Patient Chair (1852 Model)</i></p>
<p><b>ELECTRIC RECLINE / BATTERY BACKUP / HEAT / MASSAGE</b></p>  <p>ER-1 Electric Recline <i>(Wallsaver Model)</i></p>  <p>ER-2/ER-3 Electric Recline <i>(Layflat Model)</i></p>  <p>HM Heat &amp; Massage <i>(All Recliner Models)</i></p>  <p>H Heat <i>(All Recliner Models)</i></p>	<p><b>ER-1</b></p> <p><b>ER-2</b></p> <p><b>ER-3</b></p> <p><b>BB</b></p> <p><b>HM</b></p> <p><b>H</b></p>	<p><b>Overall:</b> N/A</p> <hr/> <p>\$1048 Electric Recline <i>Replaces Manual Mechanism On Any Wallsaver Model - Surface Mounts On Inside Arm (Specify Left Or Right Facing)</i></p> <p>\$1084 Electric Recline <i>Replaces Manual Mechanism On Any Layflat Model - Surface Mounts On Inside Arm (Specify Left Or Right Facing)</i></p> <p>\$1474 Electric Recline <i>Replaces Manual Mechanism On Any Trendelenburg Layflat Model - Surface Mounts On Inside Arm (Specify Left Or Right Facing)</i></p> <p>\$529 Battery Backup <i>Allows Any Wallsaver, Layflat, Or Standup Electric Recliner To Be Cordless - Surface Mounts On Inside Arm (Specify Left Or Right Facing)</i></p> <p>\$1500 Heat &amp; Massage <i>Add Heat &amp; Massage To Any Wallsaver, Layflat, Or Standup Electric Recliner - Surface Mounts On Inside Arm (Specify Left Or Right Facing)</i></p> <p>\$1339 Heat <i>Add Heat Only To Any Wallsaver, Layflat, Or Standup Electric Recliner - Surface Mounts On Inside Arm (Specify Left Or Right Facing)</i></p> <p><b>Available:</b> <i>Facelift Evolve Recliners</i></p>

FOLD DOWN ARM / PUSH BAR / I.V. POLE / SIDE TRAY	OPTION #:	SPECIFICATIONS   LIST PRICES   AVAILABILITY:
<p>FOLD DOWN ARM</p> 	<p><b>FDA-1</b></p> <p><b>\$391 Per Arm</b> <i>Piano Hinged Fold Down Arm.</i></p> <p><b>Available:</b> <i>Facelift 3 Evolve Wallsaver Recliner (1855 - Right Facing Only) &amp; Layflat Medical Recliner (1857 - Right Facing Only)</i> <b>Note:</b> <i>If Two Fold Down Arms (Left &amp; Right) Are Requested On A Recliner, The Electric Wand Must Be Specified.</i></p>	
<p>PUSH BAR</p> 	<p><b>PB</b></p> <p><b>\$240</b> <i>(Black Finish)</i></p> <p><b>Available:</b> <i>Facelift Evolve Medical Recliners</i></p>	
<p>I.V. POLE</p> 	<p><b>IV</b></p> <p><b>\$471</b> <i>Height Adjustable I.V. Pole (Chrome &amp; Black Finish / Specify Left Or Right Facing Location)</i></p> <p><b>Available:</b> <i>Facelift Evolve Medical Recliners</i></p>	
<p>SIDE TRAY</p> 	<p><b>Overall:</b> <i>12.75"w 10"d 4"h (Small Side Tray) / 17"w 10"d 4"h (Large Side Tray)</i></p> <p><b>ST-1</b> <b>\$245</b> <i>Drop-Down Side Tray (Small Side Tray)</i></p> <p><b>ST-2</b> <b>\$335</b> <i>Drop-Down Side Tray (Large Side Tray)</i></p> <p><b>Available:</b> <i>Facelift Evolve Medical Recliners</i></p>	

BAG HOLDER / BUCKLE FOOTREST / OXYGEN TANK HOLDER / RING BASE	OPTION #:	SPECIFICATIONS   LIST PRICES   AVAILABILITY:
<p>BAG HOLDER / PERSONAL RESTRAINT BUCKLE</p> 	<p><b>Overall:</b> 2.19"w .38"d 2.56"h</p> <hr/> <p><b>BH</b> \$65 <i>Bag Holder (Brushed Finish / Specify Left Or Right Facing Location)</i></p> <p><b>RB</b> \$117 (Set Of 2) <i>Personal Restraint Buckle (Brushed Finish)</i></p> <p><b>Available:</b> <i>Facelift Evolve Medical Recliners</i> <i>Note: If A Medical Recliner With A Manual Mechanism Is Selected, The Standard Side Tray Location Will Be Front Right Facing</i></p>	
<p>FOOTREST</p> 	<p><b>Overall:</b> 16"w 8"d .1875"h</p> <hr/> <p><b>FR</b> \$360 <i>(Black Finish)</i></p> <p><b>Available:</b> <i>Facelift Evolve Medical Recliners</i></p>	
<p>OXYGEN TANK HOLDER</p> 	<p><b>Overall:</b> 4.75" Diameter 9.75"h</p> <hr/> <p><b>OH</b> \$238 <i>Black Metal Oxygen Tank Holder Holds a 4.375" Diameter Oxygen Tank (Not Included) (Specify Left Or Right Facing Location)</i></p> <p><b>Available:</b> <i>Facelift Evolve Medical Recliners</i></p>	
<p>LOUNGE GLIDER WOOD RING BASE</p> 	<p><b>Overall:</b> 22"dia. 3"h</p> <hr/> <p><b>WR</b> \$224 <i>Wood Ring Base replaces circular metal base (1854-G) or swivel glider w/ circular metal base (1854-SG).</i></p> <p><i>Specify Exposed Wood Finish. (See Page 6)</i></p> <p><b>Available:</b> <i>Facelift Evolve Lounge Glider</i></p>	

COVERS / SPRINGS	OPTION #:	SPECIFICATIONS   LIST PRICES   AVAILABILITY:
<p>CONTRASTING COVERS</p> 	<p><b>Overall:</b> N/A</p> <hr/> <p><b>CC</b> \$129  <i>NOTE: If Two Or More Upholsteries Or Leathers Are Used On Any Piece Of Furniture, Then A Contrast Charge Will Apply Per Order. When Using Trinity Upholstery, The Higher Priced Upholstery Grade Will Be Used In Pricing, Unless It's Trinity Leather With Fabric Contrast Welt, Or COM With Trinity Contrast Welt, Then Contact Customer Service For Pricing.</i></p> <p><b>Available:</b> <i>Facelift Evolve Healthcare Motion</i></p>	



# Facelift Evolve

---

HEALTHCARE MOTION  
Weight-Activated Medical Recliners

Effective: August 1, 2022

T R I N I T Y

**Date:**

**Page:**

**Modification:**

**Description:**

---

**DESCRIPTION:**

- Upholstery Frames: Plywood, Hardwood & Steel
- Seat: High Density Polyurethane Foam Over Sheet Webbing
- Back: High Density Polyurethane Foam Over Sinuous Wire Springs
- Upholstered Covers: Attached w/ Velcro / Removable For Maintenance
- Antimicrobial Moisture Barrier Fully Encapsulates All Foam Areas
- Double Needle Stitching Standard (Wetling Optional - No Charge)
- Rotational & Directional Locking Casters (Rear)
- Leather Upholstery Not Available
- Lifetime Warranty

**OPTIONS:**

(See Weight Activated Medical Recliner Options Pages)

Feather Down & Polyester Pillows Available (See Page 5)

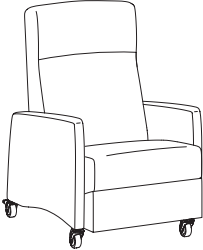
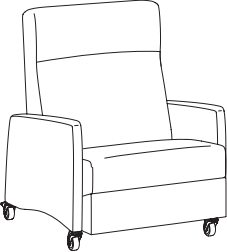
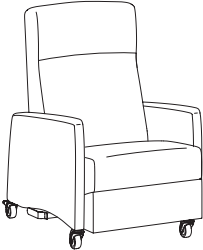
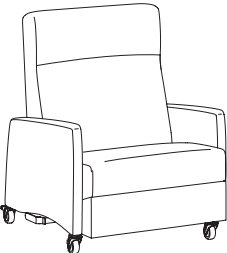
FULLY UPHOLSTERED ARM		ITEM #:	SPECIFICATIONS   GRADES   LIST PRICES:														
	<b>THREE POSITION RECLINER / UPHOLSTERED ARM</b>		<b>Overall:</b> 28.5"w 37"d 47"h <b>Seat:</b> 23.5"w 20"d 20"h		<b>Arm:</b> 26"h <b>Weight:</b> 140 lbs.		<b>COM:</b> 5.75 yds. <b>COL:</b> n/a										
			<b>COM</b>	<b>COL</b>	<b>1</b>	<b>2</b>	<b>3</b>	<b>4</b>	<b>5</b>	<b>6</b>	<b>7</b>	<b>8</b>	<b>9</b>	<b>10</b>	<b>L1</b>	<b>L2</b>	
	<b>1868</b>		2691	N/A	2894	3069	3244	3419	3594	3769	3944	4119	4294	4469	N/A	N/A	
		<i>Tight Seat &amp; Back / Removable Upholstery / 350 lb. Weight Capacity</i>															
		<b>1868-R</b>	313	N/A	598	749	900	1052	1203	1354	1505	1656	1808	1959	N/A	N/A	
		<i>Replacement Upholstery Covers</i>															
	<b>BARIATRIC THREE POSITION RECLINER / UPHOLSTERED ARM</b>		<b>Overall:</b> 33.5"w 37"d 47"h <b>Seat:</b> 28.5"w 20"d 20"h		<b>Arm:</b> 26"h <b>Weight:</b> 155 lbs.		<b>COM:</b> 5.75 yds. <b>COL:</b> n/a										
			<b>COM</b>	<b>COL</b>	<b>1</b>	<b>2</b>	<b>3</b>	<b>4</b>	<b>5</b>	<b>6</b>	<b>7</b>	<b>8</b>	<b>9</b>	<b>10</b>	<b>L1</b>	<b>L2</b>	
	<b>1868-X</b>		2799	N/A	2996	3171	3346	3521	3696	3871	4046	4221	4396	4571	N/A	N/A	
		<i>Tight Seat &amp; Back / Removable Upholstery / 500 lbs. Weight Capacity</i>															
		<b>1868-XR</b>	318	N/A	603	755	906	1057	1208	1359	1511	1662	1813	1964	N/A	N/A	
		<i>Replacement Upholstery Covers</i>															
	<b>TRENDELENBURG FOUR POSITION RECLINER / UPHOLSTERED ARM</b>		<b>Overall:</b> 28.5"w 37"d 47"h <b>Seat:</b> 23.5"w 20"d 20"h		<b>Arm:</b> 26"h <b>Weight:</b> 140 lbs.		<b>COM:</b> 5.75 yds. <b>COL:</b> n/a										
			<b>COM</b>	<b>COL</b>	<b>1</b>	<b>2</b>	<b>3</b>	<b>4</b>	<b>5</b>	<b>6</b>	<b>7</b>	<b>8</b>	<b>9</b>	<b>10</b>	<b>L1</b>	<b>L2</b>	
	<b>1858-T</b>		2920	N/A	3111	3286	3461	3636	3811	3986	4161	4336	4511	4686	N/A	N/A	
		<i>Tight Seat &amp; Back / Removable Upholstery / 350 lb. Weight Capacity</i>															
		<b>1858-TR</b>	313	N/A	598	749	900	1052	1203	1354	1505	1656	1808	1959	N/A	N/A	
		<i>Replacement Upholstery Covers</i>															
	<b>BARIATRIC TRENDELENBURG FOUR POSITION RECLINER / UPHOLSTERED ARM</b>		<b>Overall:</b> 33.5"w 37"d 47"h <b>Seat:</b> 28.5"w 20"d 20"h		<b>Arm:</b> 26"h <b>Weight:</b> 155 lbs.		<b>COM:</b> 5.75 yds. <b>COL:</b> n/a										
			<b>COM</b>	<b>COL</b>	<b>1</b>	<b>2</b>	<b>3</b>	<b>4</b>	<b>5</b>	<b>6</b>	<b>7</b>	<b>8</b>	<b>9</b>	<b>10</b>	<b>L1</b>	<b>L2</b>	
	<b>1858-XT</b>		3028	N/A	3213	3388	3563	3737	3912	4087	4262	4437	4612	4787	N/A	N/A	
		<i>Tight Seat &amp; Back / Removable Upholstery / 500 lbs. Weight Capacity</i>															
		<b>1858-XTR</b>	318	N/A	603	755	906	1057	1208	1359	1511	1662	1813	1964	N/A	N/A	
		<i>Replacement Upholstery Covers</i>															



**DESCRIPTION:**

- Upholstery Frames: Plywood, Hardwood & Steel
- Seat: High Density Polyurethane Foam Over Sheet Webbing
- Back: High Density Polyurethane Foam Over Sinuous Wire Springs
- Upholstered Covers: Attached w/ Velcro / Removable For Maintenance
- Antimicrobial Moisture Barrier Fully Encapsulates All Foam Areas
- Double Needle Stitching Standard (Wetling Optional - No Charge)
- Rotational & Directional Locking Casters (Rear)
- Leather Upholstery Not Available
- Lifetime Warranty

**OPTIONS:**

(See Weight Activated Medical Recliner Options Pages)

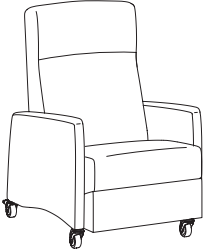
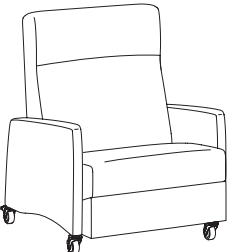
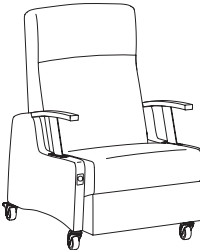
Feather Down & Polyester Pillows Available (See Page 5)

DROP-DOWN ARM		ITEM #:	SPECIFICATIONS   GRADES   LIST PRICES:													
	<b>ELECTRIC MULTI-POSITION RECLINER / UPHOLSTERED ARM</b>		<b>Overall:</b> 28.5"w 37"d 47"h <b>Seat:</b> 23.5"w 20"d 20"h		<b>Arm:</b> 26"h <b>Weight:</b> 140 lbs.					<b>COM:</b> 5.75 yds. <b>COL:</b> n/a						
			<b>COM</b>	<b>COL</b>	<b>1</b>	<b>2</b>	<b>3</b>	<b>4</b>	<b>5</b>	<b>6</b>	<b>7</b>	<b>8</b>	<b>9</b>	<b>10</b>	<b>L1</b>	<b>L2</b>
	<b>1868-E</b>		3691	N/A	3894	4069	4244	4419	4594	4769	4944	5119	5294	5469	N/A	N/A
			<i>Tight Seat &amp; Back / Removable Upholstery / 350 lb. Weight Capacity</i>													
	<b>1868-ER</b>		313	N/A	598	749	900	1052	1203	1354	1505	1656	1808	1959	N/A	N/A
			<i>Replacement Upholstery Covers</i>													
	<b>BARIATRIC ELECTRIC MULTI-POSITION RECLINER / UPHOLSTERED ARM</b>		<b>Overall:</b> 33.5"w 37"d 47"h <b>Seat:</b> 28.5"w 20"d 20"h		<b>Arm:</b> 26"h <b>Weight:</b> 155 lbs.					<b>COM:</b> 5.75 yds. <b>COL:</b> n/a						
			<b>COM</b>	<b>COL</b>	<b>1</b>	<b>2</b>	<b>3</b>	<b>4</b>	<b>5</b>	<b>6</b>	<b>7</b>	<b>8</b>	<b>9</b>	<b>10</b>	<b>L1</b>	<b>L2</b>
	<b>1868-XE</b>		3799	N/A	3996	4171	4346	4521	4696	4871	5046	5221	5396	5571	N/A	N/A
			<i>Tight Seat &amp; Back / Removable Upholstery / 500 lb. Weight Capacity</i>													
	<b>1868-XER</b>		318	N/A	603	755	906	1057	1208	1359	1511	1662	1813	1964	N/A	N/A
			<i>Replacement Upholstery Covers</i>													
	<b>THREE POSITION RECLINER / DROP-DOWN ARM / URETHANE TASK ARM CAP</b>		<b>Overall:</b> 28.5"w 37"d 47"h <b>Seat:</b> 23.5"w 20"d 20"h		<b>Arm:</b> 26"h <b>Weight:</b> 125 lbs.					<b>COM:</b> 5.5 yds. <b>COL:</b> n/a						
			<b>COM</b>	<b>COL</b>	<b>1</b>	<b>2</b>	<b>3</b>	<b>4</b>	<b>5</b>	<b>6</b>	<b>7</b>	<b>8</b>	<b>9</b>	<b>10</b>	<b>L1</b>	<b>L2</b>
	<b>1860</b>		4130	N/A	4223	4382	4541	4700	4859	5018	5177	5337	5496	5655	N/A	N/A
			<i>Tight Seat &amp; Back / Removable Upholstery / 350 lb. Weight Capacity</i>													
	<b>1860-R</b>		302	N/A	588	740	891	1042	1193	1344	1496	1647	1798	1949	N/A	N/A
			<i>Replacement Upholstery Covers</i>													
	<b>BARIATRIC THREE POSITION RECLINER / DROP-DOWN ARM / URETHANE TASK ARM CAP</b>		<b>Overall:</b> 33.5"w 37"d 47"h <b>Seat:</b> 28.5"w 20"d 20"h		<b>Arm:</b> 26"h <b>Weight:</b> 140 lbs.					<b>COM:</b> 5.75 yds. <b>COL:</b> n/a						
			<b>COM</b>	<b>COL</b>	<b>1</b>	<b>2</b>	<b>3</b>	<b>4</b>	<b>5</b>	<b>6</b>	<b>7</b>	<b>8</b>	<b>9</b>	<b>10</b>	<b>L1</b>	<b>L2</b>
	<b>1860-X</b>		4244	N/A	4363	4538	4713	4888	5063	5238	5413	5588	5763	5938	N/A	N/A
			<i>Tight Seat &amp; Back / Removable Upholstery / 500 lb. Weight Capacity</i>													
	<b>1860-XR</b>		308	N/A	594	745	896	1047	1199	1350	1501	1652	1803	1955	N/A	N/A
			<i>Replacement Upholstery Covers</i>													

## WEIGHT-ACTIVATED MEDICAL RECLINER POSITIONS:

### Fully Upholstered Arm Recliner Positions

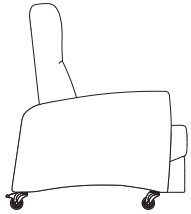

Upright Position  
28.5°D

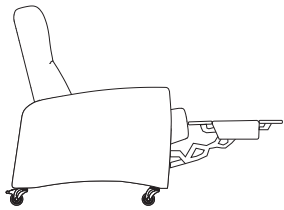

Extended Footrest Position  
55.5°D

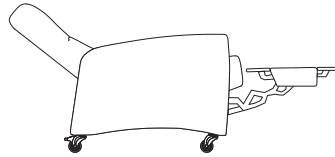

Layflat Position  
67°D

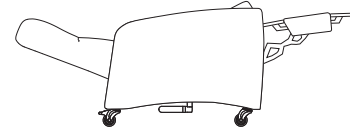

Trendelenburg Position  
69°D

### Drop-Down Arm Recliner Positions

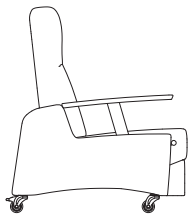

Upright Position  
28.5°D

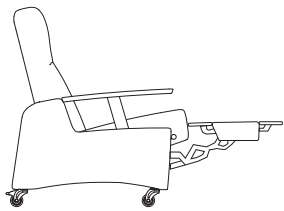

Extended Footrest Position  
55.5°D

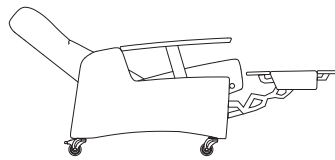

Layflat Position  
67°D

**1860 CLOSED ARM EXAMPLES:**  
 (SPECIFY LEFT OR RIGHT FACING)



**CA-W**  
 (Closed Arm Left | Drop-Down Wood Arm Right)  
 Left Facing Closed Arm  
 Note: Full Arm - \$200 Deduct



**CA-W**  
 (Drop-Down Wood Arm Left | Closed Arm Right)  
 Right Facing Closed Arm  
 Note: Full Arm - \$200 Deduct



**CA-U**  
 (Closed Arm Left | Drop-Down Urethane Arm Right)  
 Left Facing Closed Arm  
 Note: Full Arm - \$200 Deduct



**CA-U**  
 (Drop-Down Urethane Arm Left | Closed Arm Right)  
 Right Facing Closed Arm  
 Note: Full Arm - \$200 Deduct

PUSH BAR / IV / SIDE TRAY / BAG HOLDER / RESTRAINT BUCKLE	OPTION #:	SPECIFICATIONS   LIST PRICES   AVAILABILITY:
<p>PUSH BAR</p> 	<p><b>PB</b></p> <p><b>\$240</b> <i>(Black Finish)</i></p> <p><b>Available:</b> <i>Facelift Evolve Weight Activated Medical Recliners</i></p>	
<p>I.V. POLE</p> 	<p><b>IV</b></p> <p><b>\$471</b> <i>Height Adjustable I.V. Pole (Chrome / Black Finish)</i></p> <p><b>Available:</b> <i>Facelift Evolve Weight Activated Medical Recliners</i></p>	
<p>SIDE TRAY</p> 	<p><b>ST-1</b> <b>\$245</b> <i>Drop-Down Side Tray (Small Side Tray)</i></p> <p><b>ST-2</b> <b>\$335</b> <i>Drop-Down Side Tray (Large Side Tray)</i></p> <p><b>Available:</b> <i>Facelift Evolve Weight Activated Medical Recliners</i></p>	
<p>BAG HOLDER / PERSONAL RESTRAINT BUCKLE</p> 	<p><b>BH</b> <b>\$65</b> <i>Bag Holder (Brushed Finish / Specify Left Or Right Facing Location)</i></p> <p><b>RB</b> <b>\$117 (Set Of 2)</b> <i>Personal Restraint Buckle (Brushed Finish)</i></p> <p><b>Available:</b> <i>Facelift Evolve Weight Activated Medical Recliners</i></p>	

OXYGEN TANK HOLDER / ARM CAPS / CASTERS	OPTION #:	SPECIFICATIONS   LIST PRICES   AVAILABILITY:
<p>OXYGEN TANK HOLDER</p> 	<p><b>OH</b></p>	<p><b>Overall:</b> 4.75" Diameter 9.75"h</p> <hr/> <p><b>\$238</b> Black Metal Oxygen Tank Holder Holds a 4.375" Diameter Oxygen Tank (Not Included)</p> <p><b>Available:</b> Facelift Evolve Weight Activated Medical Recliners</p>
<p>SOLID WOOD / URETHANE ARM CAPS</p>  	<p><b>EWAC-1</b></p> <p><b>EUAC-1</b></p>	<p><b>Overall:</b> 2.75"w 29"d 1.125"h</p> <hr/> <p><b>\$219 (Set Of 2) WOOD</b> (Specify Finish)</p> <p><b>Available:</b> 1858 Models Only</p> <hr/> <p><b>\$231 (Set Of 2) URETHANE</b> (Black Urethane)</p> <p><b>Available:</b> 1858 Models Only</p>
<p>POLYESTER ARM CAPS</p>  	<p><b>EPAC-1</b></p> <p><b>EPAC-2</b></p>	<p><b>Overall:</b> 2.75"w 22.5"d 1.125"h (EPAC-1) / 2.75"w 29"d 1.125"h (EPAC-2)</p> <hr/> <p><b>\$379 (Set Of 2) POLYESTER</b> (1860-U / 1860-XU / 1860-TU / 1860-XTU)</p> <p>Black Polyester Arm Cap (Additional Colors Available)</p> <hr/> <p><b>\$407 (Set Of 2) POLYESTER</b> (1858 / 1858-X / 1858-T / 1858-XT) (1859-U / 1859-XU / 1859-TU / 1859-XTU) (1859N-U / 1859N-XU / 1859N-TU / 1859N-XTU)</p> <p>Black Polyester Arm Cap (Additional Colors Available)</p>
<p>MEDICAL LOCKING / NON-LOCKING CASTERS</p>   <p>Locking Casters</p> <p>Non-Locking Casters</p>	<p><b>MLC</b></p> <p><b>MNLC</b></p>	<p><b>Overall:</b> 2.25"w 5"d 5.25"h (Locking) / 2"w 3.75"d 5.25"h (Non-Locking)</p> <hr/> <p><b>\$179 (Set Of Two)</b> Locking Casters - Motion &amp; Direction (Gray Finish / Specify Location)</p> <p><b>\$205 (Set Of Two)</b> Non-Locking Casters - Single Direction (Gray Finish / Specify Location)</p> <p><b>Available:</b> Facelift Evolve Weight Activated Medical Recliners</p>



CLOSED ARMS / COVERS / SPRINGS	OPTION #:	SPECIFICATIONS   LIST PRICES   AVAILABILITY:
<p>CLOSED ARM WITH SOLID WOOD ARM CAP</p> 	<p>CA-W</p>	<p><b>Overall:</b> 2.75"w 35"d 26.25"h</p> <hr/> <p>\$200 Deduct                      Closed Arm w/ Solid Wood Arm Cap (Specify Left Or Right Facing / Specify Wood Arm Cap Finish)</p> <p><b>Available:</b> 1860 Drop-Down Arm Models Only</p>
<p>CLOSED ARM WITH URETHANE ARM CAP</p> 	<p>CA-U</p>	<p><b>Overall:</b> 2.75"w 35"d 26.25"h</p> <hr/> <p>\$200 Deduct                      Closed Arm w/ Urethane Arm Cap (Specify Left Or Right Facing)</p> <p><b>Available:</b> 1860 Drop-Down Arm Models Only</p>
<p>CONTRASTING COVERS</p> 	<p>CC</p>	<p><b>Overall:</b> N/A</p> <hr/> <p>\$129                      NOTE: If Two Or More Upholsteries Or Leathers Are Used On Any Piece Of Furniture, Then A Contrast Charge Will Apply Per Order. When Using Trinity Upholstery, The Higher Priced Upholstery Grade Will Be Used In Pricing, Unless It's Trinity Leather With Fabric Contrast Welt, Or COM With Trinity Contrast Welt, Then Contact Customer Service For Pricing.</p> <p><b>Available:</b> Facelift Evolve Weight Activated Medical Recliners</p>

# Facelift Evolve

---

LOUNGE / TANDEM

Effective: August 1, 2022

T R I N I T Y

**Date:**

**Page:**

**Modification:**

**Description:**

---

**DESCRIPTION:**

- Upholstery Frames: Steel, Plywood & Hardwood
- Seat: High Density Polyurethane Foam Over Strap Webbing
- Back: High Density Polyurethane Foam Over Sinuous Wire Springs
- Upholstered Covers: Attached w/ Velcro / Removable For Maintenance
- Exposed Wood Legs: Solid Hardwood / Removable For Maintenance
- Antimicrobial Moisture Barrier Fully Encapsulates All Foam Areas
- Leather Upholstery Not Available
- Lifetime Warranty

**OPTIONS:**

- EWAC Solid Wood Arm Caps (Set Of 2) .....\$219
- EUAC Black Urethane Arm Caps (Set Of 2).....\$231
- EPAC-2 Black Polyester Arm Caps (Set Of 2).....\$382
- ARL Brushed Aluminum Round Legs (Set Of 4).....\$353
- PM1 Power/Data Module (1-Power / 1-USB 2 Port Simplex Charger) .....\$836
- Feather Down & Polyester Pillows Available (See Page 5)
- Specify Exposed Wood Finish (See Page 6)
- Tablet Arm / Cup Holder Options (See Facelift Evolve Lounge/Tandem Options Pages)

*NOTE: All Seating Configurations Are Viewed From Left To Right Facing. Please Attach A Layout Showing Seating Configuration w/ Your Order. Assembled Units Must Be Shipped In Configurations Of 3 Or Less.*

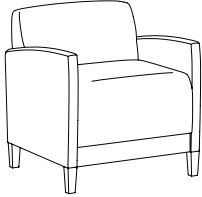
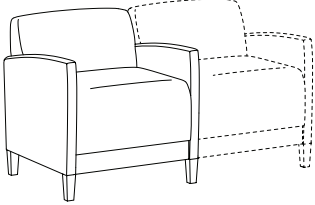
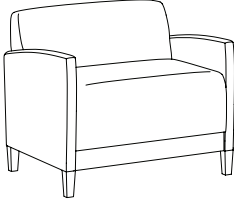
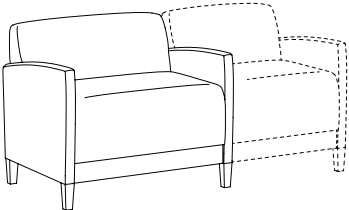
LOUNGE / TANDEM		ITEM #:	SPECIFICATIONS   GRADES   LIST PRICES:													
		1841	<b>Overall:</b> 28"w 29"d 31.5"h		<b>Arm:</b> 24.5"h		<b>COM:</b> 4.5 yds.									
			<b>Seat:</b> 23.5"w 19"d 18.5"h		<b>Weight:</b> 85 lbs.		<b>COL:</b> n/a									
			<b>COM</b>	<b>COL</b>	<b>1</b>	<b>2</b>	<b>3</b>	<b>4</b>	<b>5</b>	<b>6</b>	<b>7</b>	<b>8</b>	<b>9</b>	<b>10</b>	<b>L1</b>	<b>L2</b>
			1545	N/A	1694	1811	1928	2045	2162	2279	2395	2512	2629	2746	N/A	N/A
			<i>Tight Seat &amp; Back / Removable Upholstery</i>													
		1841-R	219	N/A	427	537	647	756	866	976	1086	1196	1306	1416	N/A	N/A
			<i>Replacement Upholstery Covers</i>													
		1841-C	<b>Overall:</b> 28"w 29"d 31.5"h		<b>Arm:</b> 24.5"h		<b>COM:</b> 4.5 yds.									
			<b>Seat:</b> 23.5"w 19"d 18.5"h		<b>Weight:</b> 85 lbs.		<b>COL:</b> n/a									
			<b>COM</b>	<b>COL</b>	<b>1</b>	<b>2</b>	<b>3</b>	<b>4</b>	<b>5</b>	<b>6</b>	<b>7</b>	<b>8</b>	<b>9</b>	<b>10</b>	<b>L1</b>	<b>L2</b>
			1545	N/A	1694	1811	1928	2045	2162	2279	2395	2512	2629	2746	N/A	N/A
			<i>Tight Seat &amp; Back / Removable Upholstery</i>													
		1841-R	219	N/A	427	537	647	756	866	976	1086	1196	1306	1416	N/A	N/A
			<i>Replacement Upholstery Covers</i>													
		1841-X	<b>Overall:</b> 34"w 29"d 31.5"h		<b>Arm:</b> 24.5"h		<b>COM:</b> 5 yds.									
			<b>Seat:</b> 29.5"w 19"d 18.5"h		<b>Weight:</b> 100 lbs.		<b>COL:</b> n/a									
			<b>COM</b>	<b>COL</b>	<b>1</b>	<b>2</b>	<b>3</b>	<b>4</b>	<b>5</b>	<b>6</b>	<b>7</b>	<b>8</b>	<b>9</b>	<b>10</b>	<b>L1</b>	<b>L2</b>
			1876	N/A	2035	2166	2296	2427	2558	2688	2819	2949	3080	3210	N/A	N/A
			<i>Tight Seat &amp; Back / Removable Upholstery / 1000 lb. Weight Capacity</i>													
		1841-XR	224	N/A	460	583	707	831	954	1078	1202	1326	1449	1573	N/A	N/A
			<i>Replacement Upholstery Covers</i>													
		1841-XC	<b>Overall:</b> 34"w 29"d 31.5"h		<b>Arm:</b> 24.5"h		<b>COM:</b> 5 yds.									
			<b>Seat:</b> 29.5"w 19"d 18.5"h		<b>Weight:</b> 100 lbs.		<b>COL:</b> n/a									
			<b>COM</b>	<b>COL</b>	<b>1</b>	<b>2</b>	<b>3</b>	<b>4</b>	<b>5</b>	<b>6</b>	<b>7</b>	<b>8</b>	<b>9</b>	<b>10</b>	<b>L1</b>	<b>L2</b>
			1876	N/A	2035	2166	2296	2427	2558	2688	2819	2949	3080	3210	N/A	N/A
			<i>Tight Seat &amp; Back / Removable Upholstery / 1000 lb. Weight Capacity</i>													
		1841-XR	224	N/A	460	583	707	831	954	1078	1202	1326	1449	1573	N/A	N/A
			<i>Replacement Upholstery Covers</i>													

**DESCRIPTION:**

- Upholstery Frames: Steel, Plywood & Hardwood
- Seat: High Density Polyurethane Foam Over Strap Webbing
- Back: High Density Polyurethane Foam Over Sinuous Wire Springs
- Upholstered Covers: Attached w/ Velcro / Removable For Maintenance
- Exposed Wood Legs: Solid Hardwood / Removable For Maintenance
- Antimicrobial Moisture Barrier Fully Encapsulates All Foam Areas
- Leather Upholstery Not Available
- Lifetime Warranty

**OPTIONS:**

- EWAC Solid Wood Arm Caps (Set Of 2) .....\$219
  - EUAC Black Urethane Arm Caps (Set Of 2).....\$231
  - EPAC-2 Black Polyester Arm Caps (Set Of 2).....\$382
  - ARL Brushed Aluminum Round Legs (Set Of 4).....\$353
  - PM1 Power/Data Module (1-Power / 1-USB 2 Port Simplex Charger) .....\$836
- Feather Down & Polyester Pillows Available (See Page 5)  
Specify Exposed Wood Finish (See Page 6)  
Tablet Arm / Cup Holder Options (See Facelift Evolve Lounge/Tandem Options Pages)

*NOTE: All Seating Configurations Are Viewed From Left To Right Facing. Please Attach A Layout Showing Seating Configuration w/ Your Order. Assembled Units Must Be Shipped In Configurations Of 3 Or Less.*

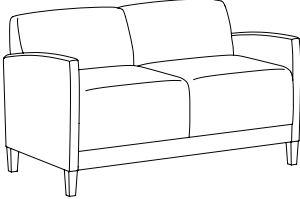
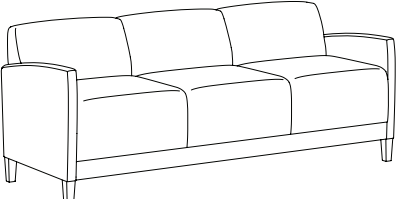
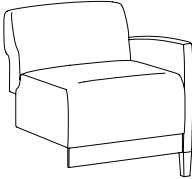
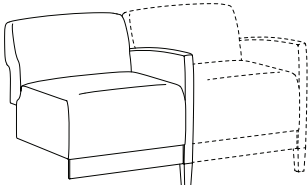
LOUNGE / TANDEM		ITEM #:	SPECIFICATIONS   GRADES   LIST PRICES:												
	<b>TWO PLACE SOFA / FULLY UPHOLSTERED</b>		<i>Overall: 52"w 29"d 31.5"h</i>				<i>Arm: 24.5"h</i>				<i>COM: 6.75 yds.</i>				
			<i>Seat: 47.5"w 19"d 18.5"h</i>				<i>Weight: 135 lbs.</i>				<i>COL: n/a</i>				
			<b>COM</b>	<b>COL</b>	<b>1</b>	<b>2</b>	<b>3</b>	<b>4</b>	<b>5</b>	<b>6</b>	<b>7</b>	<b>8</b>	<b>9</b>	<b>10</b>	<b>L1</b>
	<b>1842</b>	2411	N/A	2637	2815	2994	3173	3351	3530	3709	3887	4066	4245	N/A	N/A
		<i>Tight Seat &amp; Back / Removable Upholstery</i>													
	<b>1842-R</b>	324	N/A	664	843	1021	1200	1379	1557	1736	1915	2093	2272	N/A	N/A
		<i>Replacement Upholstery Covers</i>													
	<b>THREE PLACE SOFA / FULLY UPHOLSTERED</b>		<i>Overall: 76"w 29"d 31.5"h</i>				<i>Arm: 24.5"h</i>				<i>COM: 8.5 yds.</i>				
			<i>Seat: 71.5"w 19"d 18.5"h</i>				<i>Weight: 180 lbs.</i>				<i>COL: n/a</i>				
			<b>COM</b>	<b>COL</b>	<b>1</b>	<b>2</b>	<b>3</b>	<b>4</b>	<b>5</b>	<b>6</b>	<b>7</b>	<b>8</b>	<b>9</b>	<b>10</b>	<b>L1</b>
	<b>1843</b>	3276	N/A	3551	3778	4004	4231	4458	4685	4912	5138	5365	5592	N/A	N/A
		<i>Tight Seat &amp; Back / Removable Upholstery</i>													
	<b>1843-R</b>	418	N/A	863	1096	1330	1564	1797	2031	2265	2498	2732	2966	N/A	N/A
		<i>Replacement Upholstery Covers</i>													
	<b>FULLY UPHOLSTERED / ADD-A-SEAT</b>		<i>Overall: 26"w 29"d 31.5"h</i>				<i>Arm: 24.5"h</i>				<i>COM: 4.25 yds.</i>				
			<i>Seat: 23.5"w 19"d 18.5"h</i>				<i>Weight: 65 lbs.</i>				<i>COL: n/a</i>				
			<b>COM</b>	<b>COL</b>	<b>1</b>	<b>2</b>	<b>3</b>	<b>4</b>	<b>5</b>	<b>6</b>	<b>7</b>	<b>8</b>	<b>9</b>	<b>10</b>	<b>L1</b>
	<b>1844</b>	1262	N/A	1399	1502	1605	1708	1811	1915	2018	2121	2224	2327	N/A	N/A
		<i>Tight Seat &amp; Back / Removable Upholstery</i>													
	<b>1844-R</b>	180	N/A	349	438	527	617	706	795	885	974	1063	1153	N/A	N/A
		<i>Replacement Upholstery Covers</i>													
	<b>LOUNGE CHAIR / FULLY UPHOLSTERED / ADD-A-SEAT / ACCEPTS SEAT ON RIGHT</b>		<i>Overall: 26"w 29"d 31.5"h</i>				<i>Arm: 24.5"h</i>				<i>COM: 4.25 yds.</i>				
			<i>Seat: 23.5"w 19"d 18.5"h</i>				<i>Weight: 65 lbs.</i>				<i>COL: n/a</i>				
			<b>COM</b>	<b>COL</b>	<b>1</b>	<b>2</b>	<b>3</b>	<b>4</b>	<b>5</b>	<b>6</b>	<b>7</b>	<b>8</b>	<b>9</b>	<b>10</b>	<b>L1</b>
	<b>1844-C</b>	1262	N/A	1399	1502	1605	1708	1811	1915	2018	2121	2224	2327	N/A	N/A
		<i>Tight Seat &amp; Back / Removable Upholstery</i>													
	<b>1844-CR</b>	180	N/A	349	438	527	617	706	795	885	974	1063	1153	N/A	N/A
		<i>Replacement Upholstery Covers</i>													

**DESCRIPTION:**

- Upholstery Frames: Steel, Plywood & Hardwood
- Seat: High Density Polyurethane Foam Over Strap Webbing
- Back: High Density Polyurethane Foam Over Sinuous Wire Springs
- Upholstered Covers: Attached w/ Velcro / Removable For Maintenance
- Exposed Wood Arms: Solid Hardwood / Removable For Maintenance
- Antimicrobial Moisture Barrier Fully Encapsulates All Foam Areas
- Leather Upholstery Not Available
- Lifetime Warranty

**OPTIONS:**

- EWAC Solid Wood Arm Caps (Set Of 2) .....\$219
- EUAC Black Urethane Arm Caps (Set Of 2).....\$231
- EPAC-2 Black Polyester Arm Caps (Set Of 2).....\$382
- ARL Brushed Aluminum Round Legs (Set Of 4).....\$353
- PM1 Power/Data Module (1-Power / 1-USB 2 Port Simplex Charger) .....\$836
- Feather Down & Polyester Pillows Available (See Page 5)
- Specify Exposed Wood Finish (See Page 6)
- Tablet Arm / Cup Holder Options (See Facelift Evolve Lounge/Tandem Options Pages)

*NOTE: All Seating Configurations Are Viewed From Left To Right Facing. Please Attach A Layout Showing Seating Configuration w/ Your Order. Assembled Units Must Be Shipped In Configurations Of 3 Or Less.*

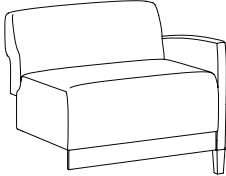
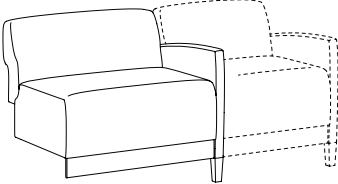
LOUNGE / TANDEM		ITEM #:	SPECIFICATIONS   GRADES   LIST PRICES:													
<b>BARIATRIC ADD-A-SEAT / FULLY UPHOLSTERED</b>  		<b>1844-X</b>          <b>1844-XR</b>	<b>Overall:</b> 32"w 29"d 31.5"h			<b>Arm:</b> 24.5"h			<b>COM:</b> 4.5 yds.							
			<b>Seat:</b> 29.5"w 19"d 18.5"h			<b>Weight:</b> 80 lbs.			<b>COL:</b> n/a							
			<b>COM</b>	<b>COL</b>	<b>1</b>	<b>2</b>	<b>3</b>	<b>4</b>	<b>5</b>	<b>6</b>	<b>7</b>	<b>8</b>	<b>9</b>	<b>10</b>	<b>L1</b>	<b>L2</b>
			1573	N/A	1693	1796	1900	2003	2106	2209	2312	2415	2518	2621	N/A	N/A
			<i>Tight Seat &amp; Back / Removable Upholstery / 1000 lb. Weight Capacity</i>													
			186	N/A	382	485	588	691	794	897	1000	1103	1206	1309	N/A	N/A
			<i>Replacement Upholstery Covers</i>													
<b>BARIATRIC ADD-A-SEAT / FULLY UPHOLSTERED / ACCEPTS SEAT ON RIGHT</b>  		<b>1844-XC</b>          <b>1844-XR</b>	<b>Overall:</b> 32"w 29"d 31.5"h			<b>Arm:</b> 24.5"h			<b>COM:</b> 4.5 yds.							
			<b>Seat:</b> 29.5"w 19"d 18.5"h			<b>Weight:</b> 80 lbs.			<b>COL:</b> n/a							
			<b>COM</b>	<b>COL</b>	<b>1</b>	<b>2</b>	<b>3</b>	<b>4</b>	<b>5</b>	<b>6</b>	<b>7</b>	<b>8</b>	<b>9</b>	<b>10</b>	<b>L1</b>	<b>L2</b>
			1573	N/A	1693	1796	1900	2003	2106	2209	2312	2415	2518	2621	N/A	N/A
			<i>Tight Seat &amp; Back / Removable Upholstery / 1000 lb. Weight Capacity</i>													
			186	N/A	382	485	588	691	794	897	1000	1103	1206	1309	N/A	N/A
			<i>Replacement Upholstery Covers</i>													

**DESCRIPTION:**

- Upholstery Frames: Steel, Plywood & Hardwood
- Seat: High Density Polyurethane Foam Over Strap Webbing
- Back: High Density Polyurethane Foam Over Sinuous Wire Springs
- Upholstered Covers: Attached w/ Velcro / Removable For Maintenance
- Exposed Wood Arms: Solid Hardwood / Removable For Maintenance
- Antimicrobial Moisture Barrier Fully Encapsulates All Foam Areas
- Leather Upholstery Not Available
- Lifetime Warranty

**OPTIONS:**

- Feather Down & Polyester Pillows Available (See Page 5)
- Specify Exposed Wood Finish (See Page 6)
- Closed Arm Panels (See Item #'s 1861-PL / 1861-PR / 1861-PC)

*NOTE: All Seating Configurations Are Viewed From Left To Right Facing. Please Attach A Layout Showing Seating Configuration w/ Your Order. Assembled Units Must Be Shipped In Configurations Of 3 Or Less.*

**OPEN ARM LOUNGE / TANDEM**

**LOUNGE CHAIR / OPEN WOOD ARMS**

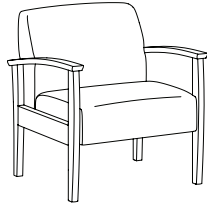

**1861**

**1861-R**

**SPECIFICATIONS | GRADES | LIST PRICES:**

**Overall:** 28.5"w 29.5"d 32"h      **Arm:** 24.5"h      **COM:** 2.5 yds.  
**Seat:** 24"w 19.5"d 18.5"h      **Weight:** 65 lbs.      **COL:** n/a

COM	COL	1	2	3	4	5	6	7	8	9	10	L1	L2
1500	N/A	1542	1604	1666	1727	1789	1851	1913	1975	2037	2099	N/A	N/A
<i>Tight Seat &amp; Back / Removable Upholstery</i>													
165	N/A	280	342	403	465	527	589	651	713	774	836	N/A	N/A
<i>Replacement Upholstery Covers</i>													

**LOUNGE CHAIR / OPEN WOOD ARMS / ACCEPTS SEAT ON RIGHT**

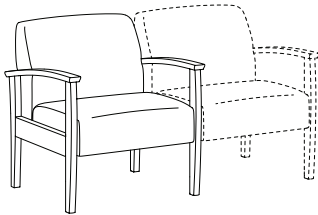

**1861-C**

**1861-R**

**Overall:** 28.5"w 29.5"d 32"h      **Arm:** 24.5"h      **COM:** 2.5 yds.  
**Seat:** 24"w 19.5"d 18.5"h      **Weight:** 65 lbs.      **COL:** n/a

COM	COL	1	2	3	4	5	6	7	8	9	10	L1	L2
1500	N/A	1542	1604	1666	1727	1789	1851	1913	1975	2037	2099	N/A	N/A
<i>Tight Seat &amp; Back / Removable Upholstery</i>													
165	N/A	280	342	403	465	527	589	651	713	774	836	N/A	N/A
<i>Replacement Upholstery Covers</i>													

**BIATRIC LOUNGE CHAIR / OPEN WOOD ARMS**

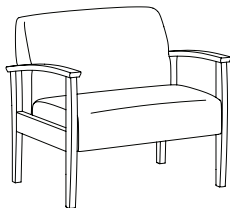

**1861-X**

**1861-XR**

**Overall:** 34.5"w 29.5"d 32"h      **Arm:** 24.5"h      **COM:** 3 yds.  
**Seat:** 30"w 19.5"d 18.5"h      **Weight:** 80 lbs.      **COL:** n/a

COM	COL	1	2	3	4	5	6	7	8	9	10	L1	L2
1808	N/A	1861	1936	2012	2088	2163	2239	2314	2390	2466	2541	N/A	N/A
<i>Tight Seat &amp; Back / Removable Upholstery / 750 lb. Weight Capacity</i>													
171	N/A	313	388	464	539	615	691	766	842	917	993	N/A	N/A
<i>Replacement Upholstery Covers</i>													

**BIATRIC LOUNGE CHAIR / OPEN WOOD ARMS / ACCEPTS SEAT ON RIGHT**

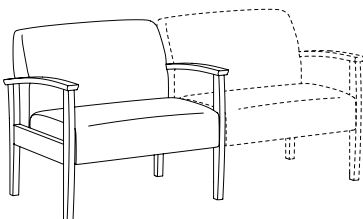

**1861-XC**

**1861-XR**

**Overall:** 34.5"w 29.5"d 32"h      **Arm:** 24.5"h      **COM:** 3 yds.  
**Seat:** 30"w 19.5"d 18.5"h      **Weight:** 80 lbs.      **COL:** n/a

COM	COL	1	2	3	4	5	6	7	8	9	10	L1	L2
1808	N/A	1861	1936	2012	2088	2163	2239	2314	2390	2466	2541	N/A	N/A
<i>Tight Seat &amp; Back / Removable Upholstery / 750 lb. Weight Capacity</i>													
171	N/A	313	388	464	539	615	691	766	842	917	993	N/A	N/A
<i>Replacement Upholstery Covers</i>													

**DESCRIPTION:**

- Upholstery Frames: Steel, Plywood & Hardwood
- Seat: High Density Polyurethane Foam Over Strap Webbing
- Back: High Density Polyurethane Foam Over Sinuous Wire Springs
- Upholstered Covers: Attached w/ Velcro / Removable For Maintenance
- Exposed Wood Arms: Solid Hardwood / Removable For Maintenance
- Antimicrobial Moisture Barrier Fully Encapsulates All Foam Areas
- Leather Upholstery Not Available
- Lifetime Warranty

**OPTIONS:**

- Feather Down & Polyester Pillows Available (See Page 5)
- Specify Exposed Wood Finish (See Page 6)
- Closed Arm Panels (See Item #'s 1861-PL / 1861-PR / 1861-PC)

*NOTE: All Seating Configurations Are Viewed From Left To Right Facing. Please Attach A Layout Showing Seating Configuration w/ Your Order. Assembled Units Must Be Shipped In Configurations Of 3 Or Less.*

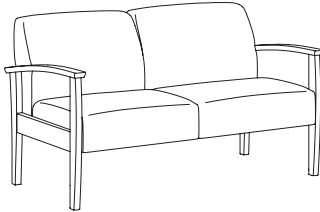
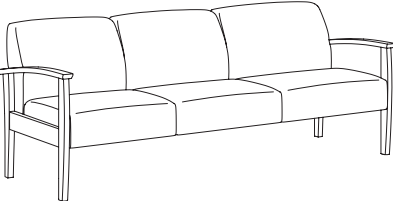
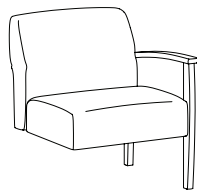
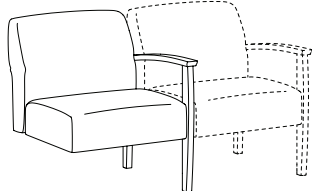
OPEN ARM LOUNGE / TANDEM		ITEM #:	SPECIFICATIONS   GRADES   LIST PRICES:													
		1862	<b>Overall:</b> 52.5"w 29.5"d 32"h			<b>Arm:</b> 24.5"h			<b>COM:</b> 4.75 yds.							
			<b>Seat:</b> 48"w 19.5"d 18.5"h			<b>Weight:</b> 140 lbs.			<b>COL:</b> n/a							
			<b>COM</b>	<b>COL</b>	<b>1</b>	<b>2</b>	<b>3</b>	<b>4</b>	<b>5</b>	<b>6</b>	<b>7</b>	<b>8</b>	<b>9</b>	<b>10</b>	<b>L1</b>	<b>L2</b>
			2340	N/A	2460	2584	2707	2831	2955	3078	3202	3326	3450	3573	N/A	N/A
			<i>Tight Seat &amp; Back / Removable Upholstery</i>													
		1862-R	256	N/A	489	613	737	860	984	1108	1232	1355	1479	1603	N/A	N/A
			<i>Replacement Upholstery Covers</i>													
		1863	<b>Overall:</b> 76.5"w 29.5"d 32"h			<b>Arm:</b> 24.5"h			<b>COM:</b> 7 yds.							
			<b>Seat:</b> 72"w 19.5"d 18.5"h			<b>Weight:</b> 180 lbs.			<b>COL:</b> n/a							
			<b>COM</b>	<b>COL</b>	<b>1</b>	<b>2</b>	<b>3</b>	<b>4</b>	<b>5</b>	<b>6</b>	<b>7</b>	<b>8</b>	<b>9</b>	<b>10</b>	<b>L1</b>	<b>L2</b>
			2910	N/A	3122	3308	3493	3679	3864	4050	4235	4421	4607	4792	N/A	N/A
			<i>Tight Seat &amp; Back / Removable Upholstery</i>													
		1863-R	332	N/A	685	871	1056	1242	1427	1613	1798	1984	2169	2355	N/A	N/A
			<i>Replacement Upholstery Covers</i>													
		1864	<b>Overall:</b> 26.5"w 29.5"d 32"h			<b>Arm:</b> 24.5"h			<b>COM:</b> 2.5 yds.							
			<b>Seat:</b> 24"w 19.5"d 18.5"h			<b>Weight:</b> 60 lbs.			<b>COL:</b> n/a							
			<b>COM</b>	<b>COL</b>	<b>1</b>	<b>2</b>	<b>3</b>	<b>4</b>	<b>5</b>	<b>6</b>	<b>7</b>	<b>8</b>	<b>9</b>	<b>10</b>	<b>L1</b>	<b>L2</b>
			1201	N/A	1259	1321	1383	1445	1507	1568	1630	1692	1754	1816	N/A	N/A
			<i>Tight Seat &amp; Back / Removable Upholstery</i>													
		1864-R	165	N/A	280	342	403	465	527	589	651	713	774	836	N/A	N/A
			<i>Replacement Upholstery Covers</i>													
		1864-C	<b>Overall:</b> 26.5"w 29.5"d 32"h			<b>Arm:</b> 24.5"h			<b>COM:</b> 2.5 yds.							
			<b>Seat:</b> 24"w 19.5"d 18.5"h			<b>Weight:</b> 60 lbs.			<b>COL:</b> n/a							
			<b>COM</b>	<b>COL</b>	<b>1</b>	<b>2</b>	<b>3</b>	<b>4</b>	<b>5</b>	<b>6</b>	<b>7</b>	<b>8</b>	<b>9</b>	<b>10</b>	<b>L1</b>	<b>L2</b>
			1201	N/A	1259	1321	1383	1445	1507	1568	1630	1692	1754	1816	N/A	N/A
			<i>Tight Seat &amp; Back / Removable Upholstery</i>													
		1864-R	165	N/A	280	342	403	465	527	589	651	713	774	836	N/A	N/A
			<i>Replacement Upholstery Covers</i>													



**DESCRIPTION:**

- Upholstery Frames: Steel, Plywood & Hardwood
- Seat: High Density Polyurethane Foam Over Strap Webbing
- Back: High Density Polyurethane Foam Over Sinuous Wire Springs
- Upholstered Covers: Attached w/ Velcro / Removable For Maintenance
- Exposed Wood Arms: Solid Hardwood / Removable For Maintenance
- Antimicrobial Moisture Barrier Fully Encapsulates All Foam Areas
- Leather Upholstery Not Available
- Lifetime Warranty

**OPTIONS:**

- Feather Down & Polyester Pillows Available (See Page 5)
- Specify Exposed Wood Finish (See Page 6)
- Closed Arm Panels (See Item #'s 1861-PL / 1861-PR / 1861-PC)

*NOTE: All Seating Configurations Are Viewed From Left To Right Facing. Please Attach A Layout Showing Seating Configuration w/ Your Order. Assembled Units Must Be Shipped In Configurations Of 3 Or Less.*

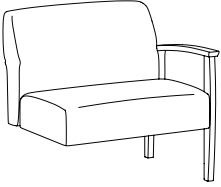
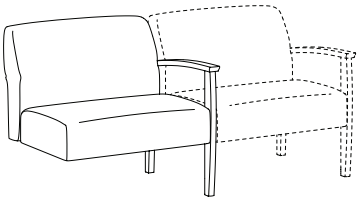
OPEN ARM LOUNGE / TANDEM		ITEM #:	SPECIFICATIONS   GRADES   LIST PRICES:														
		1864-X	<b>Overall:</b> 32.5"w 29.5"d 32"h		<b>Arm:</b> 24.5"h			<b>COM:</b> 3 yds.									
			<b>Seat:</b> 30"w 19.5"d 18.5"h		<b>Weight:</b> 75 lbs.			<b>COL:</b> n/a									
			<b>COM</b>	<b>COL</b>	<b>1</b>	<b>2</b>	<b>3</b>	<b>4</b>	<b>5</b>	<b>6</b>	<b>7</b>	<b>8</b>	<b>9</b>	<b>10</b>	<b>L1</b>	<b>L2</b>	
			1521	N/A	1589	1665	1740	1816	1891	1967	2043	2118	2194	2269	N/A	N/A	
													<i>Tight Seat &amp; Back / Removable Upholstery / 750 lb. Weight Capacity</i>				
		1864-XR	171	N/A	313	388	464	539	615	691	766	842	917	993	N/A	N/A	
													<i>Replacement Upholstery Covers</i>				
		1864-XC	<b>Overall:</b> 32.5"w 29.5"d 32"h		<b>Arm:</b> 24.5"h			<b>COM:</b> 3 yds.									
			<b>Seat:</b> 30"w 19.5"d 18.5"h		<b>Weight:</b> 75 lbs.			<b>COL:</b> n/a									
			<b>COM</b>	<b>COL</b>	<b>1</b>	<b>2</b>	<b>3</b>	<b>4</b>	<b>5</b>	<b>6</b>	<b>7</b>	<b>8</b>	<b>9</b>	<b>10</b>	<b>L1</b>	<b>L2</b>	
			1521	N/A	1589	1665	1740	1816	1891	1967	2043	2118	2194	2269	N/A	N/A	
													<i>Tight Seat &amp; Back / Removable Upholstery / 750 lb. Weight Capacity</i>				
		1864-XR	171	N/A	313	388	464	539	615	691	766	842	917	993	N/A	N/A	
													<i>Replacement Upholstery Covers</i>				

**DESCRIPTION:**

- Upholstery Frames: Steel, Plywood & Hardwood
- Seat: High Density Polyurethane Foam Over Strap Webbing
- Back: High Density Polyurethane Foam Over Sinuous Wire Springs
- Upholstered Covers: Attached w/ Velcro / Removable For Maintenance
- Exposed Wood Arms: Solid Hardwood / Removable For Maintenance
- Antimicrobial Moisture Barrier Fully Encapsulates All Foam Areas
- Leather Upholstery Not Available
- Lifetime Warranty

**OPTIONS:**

- EPAC-2 Black Polyester Arm Caps (Set Of 2).....\$382
- Feather Down & Polyester Pillows Available (See Page 5)
- Specify Exposed Wood Finish (See Page 6)
- Closed Arm Panels (See Item #'s 1861-PL / 1861-PR / 1861-PC)

*NOTE: All Seating Configurations Are Viewed From Left To Right Facing. Please Attach A Layout Showing Seating Configuration w/ Your Order. Assembled Units Must Be Shipped In Configurations Of 3 Or Less.*

**OPEN ARM LOUNGE / TANDEM**

ITEM #:

SPECIFICATIONS | GRADES | LIST PRICES:

**LOUNGE CHAIR / OPEN URETHANE ARMS**

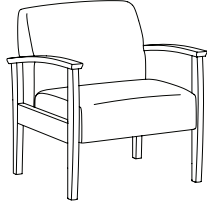

		<b>Overall:</b> 28.5"w 29.5"d 32"h		<b>Arm:</b> 24.5"h		<b>COM:</b> 2.5 yds.							
		<b>Seat:</b> 24"w 19.5"d 18.5"h		<b>Weight:</b> 65 lbs.		<b>COL:</b> n/a							
<b>COM</b>	<b>COL</b>	<b>1</b>	<b>2</b>	<b>3</b>	<b>4</b>	<b>5</b>	<b>6</b>	<b>7</b>	<b>8</b>	<b>9</b>	<b>10</b>	<b>L1</b>	<b>L2</b>
1871	N/A	1580	1642	1704	1766	1828	1890	1951	2013	2075	2137	N/A	N/A
<i>Tight Seat &amp; Back / Removable Upholstery</i>													
1871-R	N/A	280	342	403	465	527	589	651	713	774	836	N/A	N/A
<i>Replacement Upholstery Covers</i>													

**LOUNGE CHAIR / OPEN URETHANE ARMS / ACCEPTS SEAT ON RIGHT**

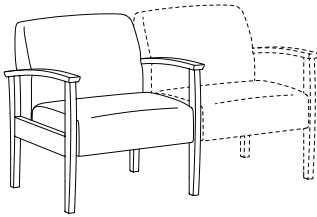

		<b>Overall:</b> 28.5"w 29.5"d 32"h		<b>Arm:</b> 24.5"h		<b>COM:</b> 2.5 yds.							
		<b>Seat:</b> 24"w 19.5"d 18.5"h		<b>Weight:</b> 65 lbs.		<b>COL:</b> n/a							
<b>COM</b>	<b>COL</b>	<b>1</b>	<b>2</b>	<b>3</b>	<b>4</b>	<b>5</b>	<b>6</b>	<b>7</b>	<b>8</b>	<b>9</b>	<b>10</b>	<b>L1</b>	<b>L2</b>
1871-C	N/A	1580	1642	1704	1766	1828	1890	1951	2013	2075	2137	N/A	N/A
<i>Tight Seat &amp; Back / Removable Upholstery</i>													
1871-R	N/A	280	342	403	465	527	589	651	713	774	836	N/A	N/A
<i>Replacement Upholstery Covers</i>													

**BIARTRIC LOUNGE CHAIR / OPEN URETHANE ARMS**

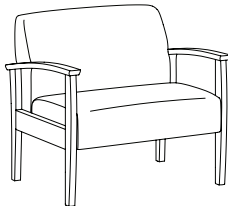

		<b>Overall:</b> 34.5"w 29.5"d 32"h		<b>Arm:</b> 24.5"h		<b>COM:</b> 3 yds.							
		<b>Seat:</b> 30"w 19.5"d 18.5"h		<b>Weight:</b> 80 lbs.		<b>COL:</b> n/a							
<b>COM</b>	<b>COL</b>	<b>1</b>	<b>2</b>	<b>3</b>	<b>4</b>	<b>5</b>	<b>6</b>	<b>7</b>	<b>8</b>	<b>9</b>	<b>10</b>	<b>L1</b>	<b>L2</b>
1871-X	N/A	1905	1980	2056	2132	2207	2283	2358	2434	2509	2585	N/A	N/A
<i>Tight Seat &amp; Back / Removable Upholstery / 750 lb. Weight Capacity</i>													
1871-XR	N/A	313	388	464	539	615	691	766	842	917	993	N/A	N/A
<i>Replacement Upholstery Covers</i>													

**BIARTRIC LOUNGE CHAIR / OPEN URETHANE ARMS / ACCEPTS SEAT ON RIGHT**

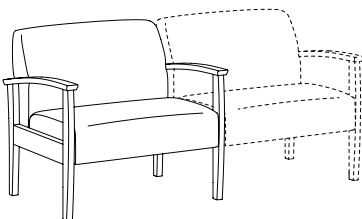

		<b>Overall:</b> 34.5"w 29.5"d 32"h		<b>Arm:</b> 24.5"h		<b>COM:</b> 3 yds.							
		<b>Seat:</b> 30"w 19.5"d 18.5"h		<b>Weight:</b> 80 lbs.		<b>COL:</b> n/a							
<b>COM</b>	<b>COL</b>	<b>1</b>	<b>2</b>	<b>3</b>	<b>4</b>	<b>5</b>	<b>6</b>	<b>7</b>	<b>8</b>	<b>9</b>	<b>10</b>	<b>L1</b>	<b>L2</b>
1871-XC	N/A	1905	1980	2056	2132	2207	2283	2358	2434	2509	2585	N/A	N/A
<i>Tight Seat &amp; Back / Removable Upholstery / 750 lb. Weight Capacity</i>													
1871-XR	N/A	313	388	464	539	615	691	766	842	917	993	N/A	N/A
<i>Replacement Upholstery Covers</i>													

**DESCRIPTION:**

- Upholstery Frames: Steel, Plywood & Hardwood
- Seat: High Density Polyurethane Foam Over Strap Webbing
- Back: High Density Polyurethane Foam Over Sinuous Wire Springs
- Upholstered Covers: Attached w/ Velcro / Removable For Maintenance
- Exposed Wood Arms: Solid Hardwood / Removable For Maintenance
- Antimicrobial Moisture Barrier Fully Encapsulates All Foam Areas
- Leather Upholstery Not Available
- Lifetime Warranty

**OPTIONS:**

- EPAC-2 Black Polyester Arm Caps (Set Of 2).....\$382
- Feather Down & Polyester Pillows Available (See Page 5)
- Specify Exposed Wood Finish (See Page 6)
- Closed Arm Panels (See Item #'s 1861-PL / 1861-PR / 1861-PC)

*NOTE: All Seating Configurations Are Viewed From Left To Right Facing. Please Attach A Layout Showing Seating Configuration w/ Your Order. Assembled Units Must Be Shipped In Configurations Of 3 Or Less.*

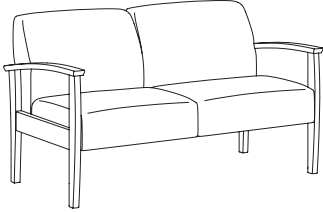
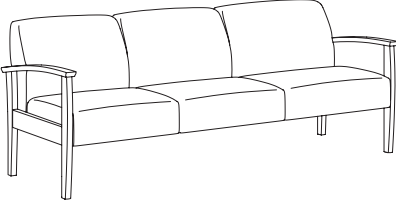
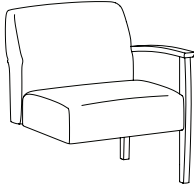
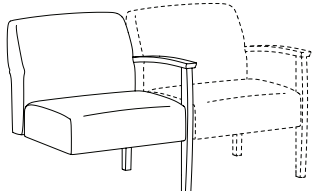
OPEN ARM LOUNGE / TANDEM		ITEM #:	SPECIFICATIONS   GRADES   LIST PRICES:													
<b>TWO PLACE SOFA / OPEN URETHANE ARMS</b>			<i>Overall: 52.5"w 29.5"d 32"h</i>			<i>Arm: 24.5"h</i>			<i>COM: 4.75 yds.</i>							
			<i>Seat: 48"w 19.5"d 18.5"h</i>			<i>Weight: 140 lbs.</i>			<i>COL: n/a</i>							
			<b>COM</b>	<b>COL</b>	<b>1</b>	<b>2</b>	<b>3</b>	<b>4</b>	<b>5</b>	<b>6</b>	<b>7</b>	<b>8</b>	<b>9</b>	<b>10</b>	<b>L1</b>	<b>L2</b>
	<b>1872</b>		2381	N/A	2498	2622	2746	2869	2993	3117	3241	3364	3488	3612	N/A	N/A
			<i>Tight Seat &amp; Back / Removable Upholstery</i>													
	<b>1872-R</b>		256	N/A	489	613	737	860	984	1108	1232	1355	1479	1603	N/A	N/A
			<i>Replacement Upholstery Covers</i>													
<b>THREE PLACE SOFA / OPEN URETHANE ARMS</b>			<i>Overall: 76.5"w 29.5"d 32"h</i>			<i>Arm: 24.5"h</i>			<i>COM: 7 yds.</i>							
			<i>Seat: 72"w 19.5"d 18.5"h</i>			<i>Weight: 180 lbs.</i>			<i>COL: n/a</i>							
			<b>COM</b>	<b>COL</b>	<b>1</b>	<b>2</b>	<b>3</b>	<b>4</b>	<b>5</b>	<b>6</b>	<b>7</b>	<b>8</b>	<b>9</b>	<b>10</b>	<b>L1</b>	<b>L2</b>
	<b>1873</b>		2956	N/A	3166	3352	3537	3723	3908	4094	4279	4465	4651	4836	N/A	N/A
			<i>Tight Seat &amp; Back / Removable Upholstery</i>													
	<b>1873-R</b>		332	N/A	685	871	1056	1242	1427	1613	1798	1984	2169	2355	N/A	N/A
			<i>Replacement Upholstery Covers</i>													
<b>ADD-A-SEAT / OPEN URETHANE ARMS</b>			<i>Overall: 26.5"w 29.5"d 32"h</i>			<i>Arm: 24.5"h</i>			<i>COM: 2.5 yds.</i>							
			<i>Seat: 24"w 19.5"d 18.5"h</i>			<i>Weight: 60 lbs.</i>			<i>COL: n/a</i>							
			<b>COM</b>	<b>COL</b>	<b>1</b>	<b>2</b>	<b>3</b>	<b>4</b>	<b>5</b>	<b>6</b>	<b>7</b>	<b>8</b>	<b>9</b>	<b>10</b>	<b>L1</b>	<b>L2</b>
	<b>1874</b>		1224	N/A	1281	1343	1405	1467	1529	1590	1652	1714	1776	1838	N/A	N/A
			<i>Tight Seat &amp; Back / Removable Upholstery</i>													
	<b>1874-R</b>		165	N/A	280	342	403	465	527	589	651	713	774	836	N/A	N/A
			<i>Replacement Upholstery Covers</i>													
<b>ADD-A-SEAT / OPEN URETHANE ARMS / ACCEPTS SEAT ON RIGHT</b>			<i>Overall: 26.5"w 29.5"d 32"h</i>			<i>Arm: 24.5"h</i>			<i>COM: 2.5 yds.</i>							
			<i>Seat: 24"w 19.5"d 18.5"h</i>			<i>Weight: 60 lbs.</i>			<i>COL: n/a</i>							
			<b>COM</b>	<b>COL</b>	<b>1</b>	<b>2</b>	<b>3</b>	<b>4</b>	<b>5</b>	<b>6</b>	<b>7</b>	<b>8</b>	<b>9</b>	<b>10</b>	<b>L1</b>	<b>L2</b>
	<b>1874-C</b>		1224	N/A	1281	1343	1405	1467	1529	1590	1652	1714	1776	1838	N/A	N/A
			<i>Tight Seat &amp; Back / Removable Upholstery</i>													
	<b>1874-R</b>		165	N/A	280	342	403	465	527	589	651	713	774	836	N/A	N/A
			<i>Replacement Upholstery Covers</i>													

**DESCRIPTION:**

- Upholstery Frames: Steel, Plywood & Hardwood
- Seat: High Density Polyurethane Foam Over Strap Webbing
- Back: High Density Polyurethane Foam Over Sinuous Wire Springs
- Upholstered Covers: Attached w/ Velcro / Removable For Maintenance
- Exposed Wood Arms: Solid Hardwood / Removable For Maintenance
- Antimicrobial Moisture Barrier Fully Encapsulates All Foam Areas
- Leather Upholstery Not Available
- Lifetime Warranty

**OPTIONS:**

- EPAC-2 Black Polyester Arm Caps (Set Of 2).....\$382
- Feather Down & Polyester Pillows Available (See Page 5)
- Specify Exposed Wood Finish (See Page 6)
- Closed Arm Panels (See Item #'s 1861-PL / 1861-PR / 1861-PC Below)

*NOTE: All Seating Configurations Are Viewed From Left To Right Facing. Please Attach A Layout Showing Seating Configuration w/ Your Order. Assembled Units Must Be Shipped In Configurations Of 3 Or Less.*

**OPEN ARM LOUNGE / TANDEM**

ITEM #:

SPECIFICATIONS | GRADES | LIST PRICES:

**BARIATRIC ADD-A-SEAT / OPEN URETHANE ARMS**

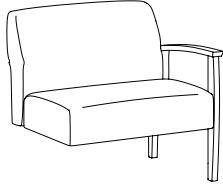

<b>Overall:</b> 32.5"w 29.5"d 32"h		<b>Arm:</b> 24.5"h		<b>COM:</b> 3 yds.									
<b>Seat:</b> 30"w 19.5"d 18.5"h		<b>Weight:</b> 75 lbs.		<b>COL:</b> n/a									
COM	COL	1	2	3	4	5	6	7	8	9	10	L1	L2
1538	N/A	1606	1681	1757	1832	1908	1984	2059	2135	2210	2286	N/A	N/A
<i>Tight Seat &amp; Back / Removable Upholstery / 750 lb. Weight Capacity</i>													
171	N/A	313	388	464	539	615	691	766	842	917	993	N/A	N/A
<i>Replacement Upholstery Covers</i>													

1874-X

1874-XR

**BARIATRIC ADD-A-SEAT / OPEN URETHANE ARMS / ACCEPTS SEAT ON RIGHT**

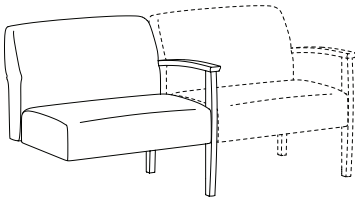

<b>Overall:</b> 32.5"w 29.5"d 32"h		<b>Arm:</b> 24.5"h		<b>COM:</b> 3 yds.									
<b>Seat:</b> 30"w 19.5"d 18.5"h		<b>Weight:</b> 75 lbs.		<b>COL:</b> n/a									
COM	COL	1	2	3	4	5	6	7	8	9	10	L1	L2
1538	N/A	1606	1681	1757	1832	1908	1984	2059	2135	2210	2286	N/A	N/A
<i>Tight Seat &amp; Back / Removable Upholstery / 750 lb. Weight Capacity</i>													
171	N/A	313	388	464	539	615	691	766	842	917	993	N/A	N/A
<i>Replacement Upholstery Covers</i>													

1874-XC

1874-XR

**CLOSED ARM PANELS**

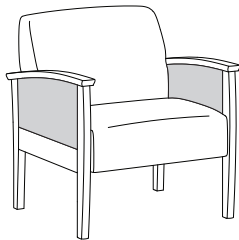





<b>COM:</b> .75 yds.		<b>Weight:</b> 10 lbs.											
COM	COL	1	2	3	4	5	6	7	8	9	10	L1	L2
149	N/A	210	240	272	301	332	363	393	424	455	485	N/A	N/A
<i>Left Facing Outside Arm Panel Set</i>													
149	N/A	210	240	272	301	332	363	393	424	455	485	N/A	N/A
<i>Right Facing Outside Arm Panel Set</i>													
149	N/A	210	240	272	301	332	363	393	424	455	485	N/A	N/A
<i>Center Arm Panel Set</i>													

1861-PL

1861-PR

1861-PC

ARM CAPS / TABLETS	OPTION #:	SPECIFICATIONS   LIST PRICES   AVAILABILITY:
<p><b>SOLID WOOD ARM CAPS</b></p> 	<p><b>EWAC</b></p>	<p><b>Overall:</b> 2.75"w 29"d 1.125"h</p> <hr/> <p>\$219 (Set Of 2) SOLID WOOD <i>(Specify Finish)</i></p> <p><b>Available:</b> <i>Facelift Evolve Fully Upholstered Lounge &amp; Tandem</i></p>
<p><b>URETHANE / POLYESTER ARM CAPS</b></p> 	<p><b>EUAC</b></p> <p><b>EPAC-2</b></p>	<p><b>Overall:</b> 2.75"w 29"d 1.125"h</p> <hr/> <p>\$231 (Set Of 2) URETHANE <i>(1841-1844 Black Urethane)</i></p> <p>\$382 (Set Of 2) POLYESTER <i>(1841-1844 / 1871-1874)</i></p> <p><i>Black Polyester Arm Cap (Additional Colors Available)</i></p> <p><b>Available:</b> <i>Facelift Evolve Fully Upholstered Lounge &amp; Tandem</i></p>
<p><b>TABLET ARMS / CUP HOLDER</b></p>  <p>Laminate Tablet Arm Shown w/ Cup Holder</p> <p>Veneer Tablet Arm Shown w/ Cup Holder</p> <p>Solid Surface Tablet Arm Shown w/ Cup Holder</p>	<p><b>TA-L</b></p> <p><b>TA-V</b></p> <p><b>TA-C</b></p> <p><b>CH-1</b></p> <p><b>CH-2</b></p>	<p><b>Overall:</b> 14" Diameter .75"h</p> <hr/> <p>\$440 <i>Tablet Arm With 360° Rotation - High Pressure Laminate. (Specify Laminate / Specify Left Or Right Facing Arm Location)</i></p> <p>\$503 <i>Tablet Arm With 360° Rotation - Sunburst Cherry Veneer. (Specify Finish / Specify Left Or Right Facing Arm Location)</i></p> <p>\$654 <i>Tablet Arm With 360° Rotation - White Solid Surface. (Available In White Only / Specify Left Or Right Facing Arm Location)</i></p> <p>\$105 <i>Black Plastic Cup Holder (Only Available If Used With Tablet Arm)</i></p> <p>\$157 <i>Spun Aluminum Cup Holder (Only Available If Used With Tablet Arm)</i></p> <p><b>Available:</b> <i>Facelift Evolve Lounge / Tandem Collection</i></p>
<p><b>FOLD DOWN TABLET ARM</b></p> 	<p><b>FDTA-L</b></p> <p><b>FDTA-V</b></p> <p><b>FDTA-C</b></p>	<p><b>Overall:</b> 14" Diameter .75"h</p> <hr/> <p>\$1056 <i>Tablet Arm With 360° Rotation - High Pressure Laminate. (Specify Laminate / Specify Left Or Right Facing Arm Location)</i></p> <p>\$1108 <i>Tablet Arm With 360° Rotation - Sunburst Cherry Veneer. (Specify Finish / Specify Left Or Right Facing Arm Location)</i></p> <p>\$1259 <i>Tablet Arm With 360° Rotation - White Solid Surface. (Available In White Only / Specify Left Or Right Facing Arm Location)</i></p> <p><b>Available:</b> <i>Facelift Evolve Lounge / Tandem Collection</i></p>

TABLETS / POWER / LEGS / COVERS	OPTION #:	SPECIFICATIONS   LIST PRICES   AVAILABILITY:
<p><b>DOUBLE ARTICULATING / SWIVEL TABLET ARM</b></p>  <p>ATA-L Double Articulating / Swivel Tablet Arm</p>  <p>ATA-L w/ CH-1 Black Plastic Cup Holder</p>	<p><b>Overall:</b> 14" Diameter .75"h</p> <hr/> <p><b>ATA-L</b> \$865 <i>Tablet Arm With 360° Rotation - High Pressure Laminate. (Specify Laminate / Specify Left Or Right Facing Arm Location)</i></p> <p><b>ATA-V</b> \$904 <i>Tablet Arm With 360° Rotation - Sunburst Cherry Veneer. (Specify Finish / Specify Left Or Right Facing Arm Location)</i></p> <p><b>ATA-C</b> \$1089 <i>Tablet Arm With 360° Rotation - White Solid Surface. (Available In White Only / Specify Left Or Right Facing Arm Location)</i></p> <p><b>CH-1</b> \$105 <i>Black Plastic Cup Holder (Only Available If Used With Tablet Arm)</i></p> <p><b>CH-2</b> \$134 <i>Spun Aluminum Cup Holder (Only Available If Used With Tablet Arm)</i></p> <p><b>Available:</b> <i>Facelift Evolve Lounge / Tandem Collection</i></p>	
<p><b>POWER / DATA MODULE</b></p> 	<p><b>Overall:</b> 5.25"w 1.25"d 4.25"h</p> <hr/> <p><b>PM1</b> \$836 (1-Power / 1-USB 2 Port Simplex Charger Standard) <i>Vertical / Horizontal Mount Power Module. Price Varies By Socket. Contact Customer Service For Quote. (Additional Colors Available)</i></p> <p><b>Available:</b> <i>Facelift Evolve Fully Upholstered Lounge</i></p>	
<p><b>BRUSHED ALUMINUM ROUND LEGS</b></p> 	<p><b>Overall:</b> 2" Diameter 5"h</p> <hr/> <p><b>ARL</b> \$353 (Set Of 4) <i>(Brushed Aluminum Finish)</i></p> <p><b>Available:</b> <i>Facelift Evolve Lounge &amp; Tandem</i></p>	
<p><b>CONTRASTING COVERS</b></p> 	<p><b>Overall:</b> N/A</p> <hr/> <p><b>CC</b> \$129 <i>NOTE: If Two Or More Upholsteries Or Leathers Are Used On Any Piece Of Furniture, Then A Contrast Charge Will Apply Per Order. When Using Trinity Upholstery, The Higher Priced Upholstery Grade Will Be Used In Pricing, Unless It's Trinity Leather With Fabric Contrast Welt, Or COM With Trinity Contrast Welt, Then Contact Customer Service For Pricing.</i></p> <p><b>Available:</b> <i>Facelift Evolve Lounge &amp; Tandem</i></p>	

# Facelift Evolve

---

FULLY UPHOLSTERED GUEST / TANDEM / TABLES

Effective: August 1, 2022

T R I N I T Y

**Date:**

**Page:**

**Modification:**

**Description:**

---



**DESCRIPTION:**

- Upholstery Frames: Steel, Plywood & Hardwood
- Seat: High Density Polyurethane Foam Over Strap Webbing
- Back: High Density Polyurethane Foam Over Plywood
- Upholstered Covers: Attached w/ Velcro / Removable For Maintenance
- Exposed Black Polyurethane Arm Caps Standard
- Exposed Black Polyester Legs Standard: Removable For Maintenance / Wallsaver Legs
- Antimicrobial Moisture Barrier Fully Encapsulates Seat & Back
- Leather Upholstery Not Available
- Adjustable Height Leveling Glides Standard
- Lifetime Warranty

**OPTIONS:**

- EPAC-1 Polyester Arm Cap (Specify Color) .....\$177 Each
- Specify Exposed Polyester Leg Finish (See Page 7)
- Table & Connecting Tables Available (See Facelift Evolve Guest/Tandem/Tables)

*NOTE: All Seating Configurations Are Viewed From Left To Right Facing. Please Attach A Layout Showing Seating Configuration w/ Your Order. Assembled Units Must Be Shipped In Configurations Of 3 Or Less.*

**GUEST / TANDEM**

ITEM #:

SPECIFICATIONS | GRADES | LIST PRICES:

**FULLY UPHOLSTERED CHAIR**

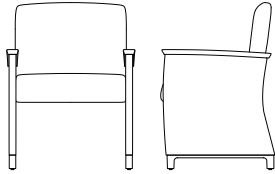

**Overall:** 23.5"w 24"d 34"h      **Arm:** 25"h      **COM:** 3.75 yds.  
**Seat:** 20"w 19"d 18.5"h      **Weight:** 55 lbs.      **COL:** n/a

COM	COL	1	2	3	4	5	6	7	8	9	10	L1	L2
1880	N/A	1529	1626	1722	1818	1914	2010	2107	2203	2299	2395	N/A	N/A
<i>Closed Back / Tight Seat &amp; Back / Removable Upholstery</i>													
1880-R	N/A	298	395	491	587	683	779	881	983	1085	1186	N/A	N/A
<i>Replacement Upholstery Covers</i>													

**FULLY UPHOLSTERED CHAIR / ACCEPTS CHAIR ON RIGHT**

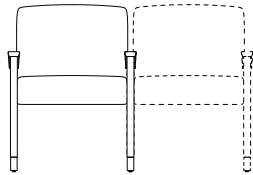

**Overall:** 23.5"w 24"d 34"h      **Arm:** 25"h      **COM:** 3.75 yds.  
**Seat:** 20"w 19"d 18.5"h      **Weight:** 55 lbs.      **COL:** n/a

COM	COL	1	2	3	4	5	6	7	8	9	10	L1	L2
1880-C	N/A	1529	1626	1722	1818	1914	2010	2107	2203	2299	2395	N/A	N/A
<i>Closed Back / Tight Seat &amp; Back / Removable Upholstery</i>													
1880-R	N/A	298	395	491	587	683	779	881	983	1085	1186	N/A	N/A
<i>Replacement Upholstery Covers</i>													

**FULLY UPHOLSTERED CHAIR / ACCEPTS TABLE ON RIGHT**

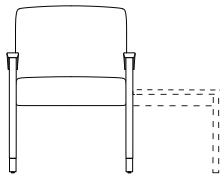

**Overall:** 23.5"w 24"d 34"h      **Arm:** 25"h      **COM:** 3.75 yds.  
**Seat:** 20"w 19"d 18.5"h      **Weight:** 55 lbs.      **COL:** n/a

COM	COL	1	2	3	4	5	6	7	8	9	10	L1	L2
1880-T	N/A	1529	1626	1722	1818	1914	2010	2107	2203	2299	2395	N/A	N/A
<i>Closed Back / Tight Seat &amp; Back / Removable Upholstery</i>													
1880-R	N/A	298	395	491	587	683	779	881	983	1085	1186	N/A	N/A
<i>Replacement Upholstery Covers</i>													

**DESCRIPTION:**

- Upholstery Frames: Steel, Plywood & Hardwood
- Seat: High Density Polyurethane Foam Over Strap Webbing
- Back: High Density Polyurethane Foam Over Plywood
- Upholstered Covers: Attached w/ Velcro / Removable For Maintenance
- Exposed Black Polyurethane Arm Caps Standard
- Exposed Black Polyester Legs Standard: Removable For Maintenance / Wallsaver Legs
- Antimicrobial Moisture Barrier Fully Encapsulates Seat & Back
- Leather Upholstery Not Available
- Adjustable Height Leveling Glides Standard
- Lifetime Warranty

**OPTIONS:**

- EPAC-1 Polyester Arm Cap (Specify Color) .....\$177 Each
- Specify Exposed Polyester Leg Finish (See Page 7)
- Table & Connecting Tables Available (See Facelift Evolve Guest/Tandem/Tables)

*NOTE: All Seating Configurations Are Viewed From Left To Right Facing. Please Attach A Layout Showing Seating Configuration w/ Your Order. Assembled Units Must Be Shipped In Configurations Of 3 Or Less.*

**TANDEM**

**ITEM #: SPECIFICATIONS | GRADES | LIST PRICES:**

**ADD-A-SEAT**

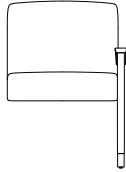

**Overall:** 21.75"w 24"d 34"h      **Arm:** 25"h      **COM:** 2.75 yds.  
**Seat:** 20"w 19"d 18.5"h      **Weight:** 50 lbs.      **COL:** n/a

COM	COL	1	2	3	4	5	6	7	8	9	10	L1	L2
1881	N/A	1095	1164	1233	1302	1370	1439	1508	1576	1645	1714	N/A	N/A
<i>Closed Back / Tight Seat &amp; Back / Removable Upholstery</i>													
1881-R	N/A	224	292	361	430	498	567	641	716	790	864	N/A	N/A
<i>Replacement Upholstery Covers</i>													

**ADD-A-SEAT / ACCEPTS SEAT ON RIGHT**

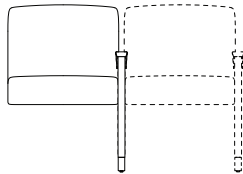

**Overall:** 21.75"w 24"d 34"h      **Arm:** 25"h      **COM:** 2.75 yds.  
**Seat:** 20"w 19"d 18.5"h      **Weight:** 50 lbs.      **COL:** n/a

COM	COL	1	2	3	4	5	6	7	8	9	10	L1	L2
1881-C	N/A	1095	1164	1233	1302	1370	1439	1508	1576	1645	1714	N/A	N/A
<i>Closed Back / Tight Seat &amp; Back / Removable Upholstery</i>													
1881-R	N/A	224	292	361	430	498	567	641	716	790	864	N/A	N/A
<i>Replacement Upholstery Covers</i>													

**ADD-A-SEAT / ACCEPTS TABLE ON RIGHT**

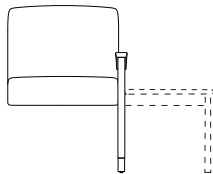

**Overall:** 21.75"w 24"d 34"h      **Arm:** 25"h      **COM:** 2.75 yds.  
**Seat:** 20"w 19"d 18.5"h      **Weight:** 50 lbs.      **COL:** n/a

COM	COL	1	2	3	4	5	6	7	8	9	10	L1	L2
1881-T	N/A	1095	1164	1233	1302	1370	1439	1508	1576	1645	1714	N/A	N/A
<i>Closed Back / Tight Seat &amp; Back / Removable Upholstery</i>													
1881-R	N/A	224	292	361	430	498	567	641	716	790	864	N/A	N/A
<i>Replacement Upholstery Covers</i>													

**DESCRIPTION:**

- Upholstery Frames: Steel, Plywood & Hardwood
- Seat: High Density Polyurethane Foam Over Strap Webbing
- Back: High Density Polyurethane Foam Over Plywood
- Upholstered Covers: Attached w/ Velcro / Removable For Maintenance
- Exposed Black Polyurethane Arm Caps Standard
- Exposed Black Polyester Legs Standard: Removable For Maintenance / Wallsaver Legs
- Antimicrobial Moisture Barrier Fully Encapsulates Seat & Back
- Leather Upholstery Not Available
- Adjustable Height Leveling Glides Standard
- Lifetime Warranty

**OPTIONS:**

- EPAC-1 Polyester Arm Cap (Specify Color) .....\$177 Each
- Specify Exposed Polyester Leg Finish (See Page 7)
- Table & Connecting Tables Available (See Facelift Evolve Guest/Tandem/Tables)

*NOTE: All Seating Configurations Are Viewed From Left To Right Facing. Please Attach A Layout Showing Seating Configuration w/ Your Order. Assembled Units Must Be Shipped In Configurations Of 3 Or Less.*

**BARIATRIC / TANDEM**

ITEM #:

SPECIFICATIONS | GRADES | LIST PRICES:

**FULLY UPHOLSTERED BARIATRIC CHAIR**

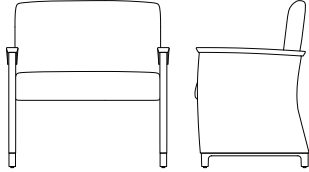

**Overall:** 33.5"w 24"d 34"h      **Arm:** 25"h      **COM:** 4.25 yds.  
**Seat:** 30"w 19"d 18.5"h      **Weight:** 65 lbs.      **COL:** n/a

COM	COL	1	2	3	4	5	6	7	8	9	10	L1	L2
1882	N/A	1830	1940	2050	2160	2270	2380	2490	2600	2710	2820	N/A	N/A
<i>Closed Back / Tight Seat &amp; Back / Removable Upholstery</i>													
1882-R	N/A	337	447	557	667	777	886	996	1106	1216	1326	N/A	N/A
<i>Replacement Upholstery Covers</i>													

**FULLY UPHOLSTERED BARIATRIC CHAIR / ACCEPTS CHAIR ON RIGHT**

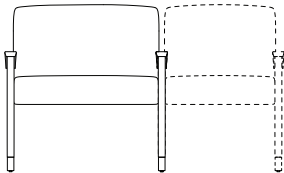

**Overall:** 33.5"w 24"d 34"h      **Arm:** 25"h      **COM:** 4.25 yds.  
**Seat:** 30"w 19"d 18.5"h      **Weight:** 65 lbs.      **COL:** n/a

COM	COL	1	2	3	4	5	6	7	8	9	10	L1	L2
1882-C	N/A	1830	1940	2050	2160	2270	2380	2490	2600	2710	2820	N/A	N/A
<i>Closed Back / Tight Seat &amp; Back / Removable Upholstery</i>													
1882-R	N/A	337	447	557	667	777	886	996	1106	1216	1326	N/A	N/A
<i>Replacement Upholstery Covers</i>													

**FULLY UPHOLSTERED BARIATRIC CHAIR / ACCEPTS TABLE ON RIGHT**

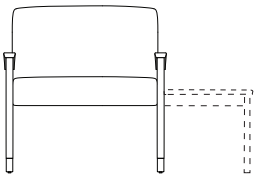

**Overall:** 33.5"w 24"d 34"h      **Arm:** 25"h      **COM:** 4.25 yds.  
**Seat:** 30"w 19"d 18.5"h      **Weight:** 65 lbs.      **COL:** n/a

COM	COL	1	2	3	4	5	6	7	8	9	10	L1	L2
1882-T	N/A	1830	1940	2050	2160	2270	2380	2490	2600	2710	2820	N/A	N/A
<i>Closed Back / Tight Seat &amp; Back / Removable Upholstery</i>													
1882-R	N/A	337	447	557	667	777	886	996	1106	1216	1326	N/A	N/A
<i>Replacement Upholstery Covers</i>													

**DESCRIPTION:**

- Upholstery Frames: Steel, Plywood & Hardwood
- Seat: High Density Polyurethane Foam Over Strap Webbing
- Back: High Density Polyurethane Foam Over Plywood
- Upholstered Covers: Attached w/ Velcro / Removable For Maintenance
- Exposed Black Polyurethane Arm Caps Standard
- Exposed Black Polyester Legs Standard: Removable For Maintenance / Wallsaver Legs
- Antimicrobial Moisture Barrier Fully Encapsulates Seat & Back
- Leather Upholstery Not Available
- Adjustable Height Leveling Glides Standard
- Lifetime Warranty

**OPTIONS:**

- EPAC-1 Polyester Arm Cap (Specify Color) .....\$177 Each
- Specify Exposed Polyester Leg Finish (See Page 7)
- Table & Connecting Tables Available (See Facelift Evolve Guest/Tandem/Tables)

*NOTE: All Seating Configurations Are Viewed From Left To Right Facing. Please Attach A Layout Showing Seating Configuration w/ Your Order. Assembled Units Must Be Shipped In Configurations Of 3 Or Less.*

**BARIATRIC / TANDEM**

ITEM #:

SPECIFICATIONS | GRADES | LIST PRICES:

**BARIATRIC ADD-A-SEAT**

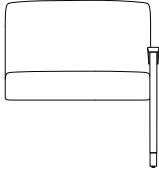

**Overall:** 31.75" w 24" d 34" h      **Arm:** 25" h      **COM:** 3.25 yds.  
**Seat:** 30" w 19" d 18.5" h      **Weight:** 62 lbs.      **COL:** n/a

COM	COL	1	2	3	4	5	6	7	8	9	10	L1	L2
1883	N/A	1392	1468	1543	1619	1695	1770	1846	1921	1997	2073	N/A	N/A
<i>Closed Back / Tight Seat &amp; Back / Removable Upholstery</i>													
1883-R	N/A	250	326	401	477	552	628	704	779	855	930	N/A	N/A
<i>Replacement Upholstery Covers</i>													

**BARIATRIC ADD-A-SEAT / ACCEPTS SEAT ON RIGHT**

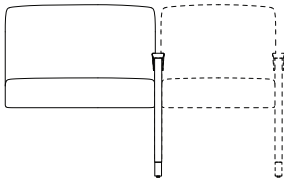

**Overall:** 31.75" w 24" d 34" h      **Arm:** 25" h      **COM:** 3.25 yds.  
**Seat:** 30" w 19" d 18.5" h      **Weight:** 62 lbs.      **COL:** n/a

COM	COL	1	2	3	4	5	6	7	8	9	10	L1	L2
1883-C	N/A	1392	1468	1543	1619	1695	1770	1846	1921	1997	2073	N/A	N/A
<i>Closed Back / Tight Seat &amp; Back / Removable Upholstery</i>													
1883-R	N/A	250	326	401	477	552	628	704	779	855	930	N/A	N/A
<i>Replacement Upholstery Covers</i>													

**BARIATRIC ADD-A-SEAT / ACCEPTS TABLE ON RIGHT**

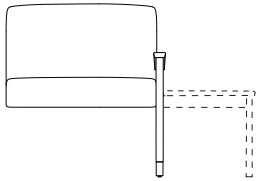

**Overall:** 31.75" w 24" d 34" h      **Arm:** 25" h      **COM:** 3.25 yds.  
**Seat:** 30" w 19" d 18.5" h      **Weight:** 62 lbs.      **COL:** n/a

COM	COL	1	2	3	4	5	6	7	8	9	10	L1	L2
1883-T	N/A	1392	1468	1543	1619	1695	1770	1846	1921	1997	2073	N/A	N/A
<i>Closed Back / Tight Seat &amp; Back / Removable Upholstery</i>													
1883-R	N/A	250	326	401	477	552	628	704	779	855	930	N/A	N/A
<i>Replacement Upholstery Covers</i>													

**DESCRIPTION:**

- Upholstery Frames: Steel, Plywood & Hardwood
- Seat: High Density Polyurethane Foam Over Strap Webbing
- Back: High Density Polyurethane Foam Over Plywood
- Upholstered Covers: Attached w/ Velcro / Removable For Maintenance
- Exposed Black Polyurethane Arm Caps Standard
- Exposed Black Polyester Legs Standard: Removable For Maintenance / Wallsaver Legs
- Antimicrobial Moisture Barrier Fully Encapsulates Seat & Back
- Leather Upholstery Not Available
- Adjustable Height Leveling Glides Standard
- Lifetime Warranty

**OPTIONS:**

EPAC-1 Polyester Arm Cap (Specify Color) .....\$177 Each

Specify Exposed Polyester Leg Finish (See Page 7)  
Table & Connecting Tables Available (See Facelift Evolve Guest/Tandem/Tables)

*NOTE: All Seating Configurations Are Viewed From Left To Right Facing. Please Attach A Layout Showing Seating Configuration w/ Your Order. Assembled Units Must Be Shipped In Configurations Of 3 Or Less.*

**GUEST / TANDEM**

ITEM #:

SPECIFICATIONS | GRADES | LIST PRICES:

**FULLY UPHOLSTERED TWO PLACE SOFA**

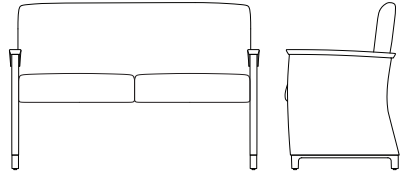

1884

1884-R

**Overall:** 51.5"w 24"d 34"h      **Arm:** 25"h      **COM:** 5.5 yds.  
**Seat:** 48"w 19"d 18.5"h      **Weight:** 75 lbs.      **COL:** n/a

COM	COL	1	2	3	4	5	6	7	8	9	10	L1	L2
2112	N/A	2285	2429	2574	2718	2862	3007	3151	3295	3440	3584	N/A	N/A
<i>Closed Back / Tight Seat &amp; Back / Removable Upholstery</i>													
152	N/A	432	577	721	865	1010	1154	1298	1443	1587	1731	N/A	N/A
<i>Replacement Upholstery Covers</i>													

**FULLY UPHOLSTERED TWO PLACE SOFA / ACCEPTS CHAIR ON RIGHT**

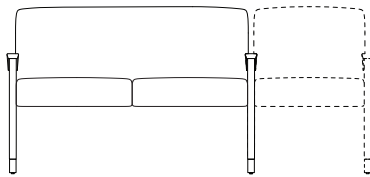

1884-C

1884-R

**Overall:** 51.5"w 24"d 34"h      **Arm:** 25"h      **COM:** 5.5 yds.  
**Seat:** 48"w 19"d 18.5"h      **Weight:** 75 lbs.      **COL:** n/a

COM	COL	1	2	3	4	5	6	7	8	9	10	L1	L2
2112	N/A	2285	2429	2574	2718	2862	3007	3151	3295	3440	3584	N/A	N/A
<i>Closed Back / Tight Seat &amp; Back / Removable Upholstery</i>													
152	N/A	432	577	721	865	1010	1154	1298	1443	1587	1731	N/A	N/A
<i>Replacement Upholstery Covers</i>													

**FULLY UPHOLSTERED TWO PLACE SOFA / ACCEPTS TABLE ON RIGHT**

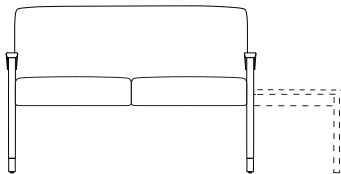

1884-T

1884-R

**Overall:** 51.5"w 24"d 34"h      **Arm:** 25"h      **COM:** 5.5 yds.  
**Seat:** 48"w 19"d 18.5"h      **Weight:** 75 lbs.      **COL:** n/a

COM	COL	1	2	3	4	5	6	7	8	9	10	L1	L2
2112	N/A	2285	2429	2574	2718	2862	3007	3151	3295	3440	3584	N/A	N/A
<i>Closed Back / Tight Seat &amp; Back / Removable Upholstery</i>													
152	N/A	432	577	721	865	1010	1154	1298	1443	1587	1731	N/A	N/A
<i>Replacement Upholstery Covers</i>													

**DESCRIPTION:**

- Upholstery Frames: Steel, Plywood & Hardwood
- Seat: High Density Polyurethane Foam Over Strap Webbing
- Back: High Density Polyurethane Foam Over Plywood
- Upholstered Covers: Attached w/ Velcro / Removable For Maintenance
- Exposed Black Polyurethane Arm Caps Standard
- Exposed Black Polyester Legs Standard: Removable For Maintenance / Wallsaver Legs
- Antimicrobial Moisture Barrier Fully Encapsulates Seat & Back
- Leather Upholstery Not Available
- Adjustable Height Leveling Glides Standard
- Lifetime Warranty

**OPTIONS:**

- EPAC-1 Polyester Arm Cap (Specify Color) .....\$177 Each
- Specify Exposed Polyester Leg Finish (See Page 7)
- Table & Connecting Tables Available (See Facelift Evolve Guest/Tandem/Tables)

*NOTE: All Seating Configurations Are Viewed From Left To Right Facing. Please Attach A Layout Showing Seating Configuration w/ Your Order. Assembled Units Must Be Shipped In Configurations Of 3 Or Less.*

**GUEST / TANDEM**

ITEM #:

SPECIFICATIONS | GRADES | LIST PRICES:

**TWO PLACE ADD-A-SEAT**

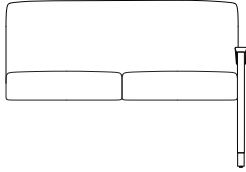

**Overall:** 49.75" w 24" d 34" h      **Arm:** 25" h      **COM:** 4.5 yds.  
**Seat:** 48" w 19" d 18.5" h      **Weight:** 72 lbs.      **COL:** n/a

COM	COL	1	2	3	4	5	6	7	8	9	10	L1	L2
1885	N/A	1166	1283	1400	1517	1634	1750	1867	1984	2101	2218	N/A	N/A
<i>Closed Back / Tight Seat &amp; Back / Removable Upholstery</i>													
1885-R	N/A	354	471	588	705	822	939	1055	1172	1289	1406	N/A	N/A
<i>Replacement Upholstery Covers</i>													

**TWO PLACE ADD-A-SEAT / ACCEPTS SEAT ON RIGHT**

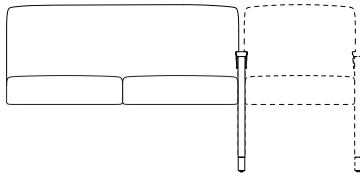

**Overall:** 49.75" w 24" d 34" h      **Arm:** 25" h      **COM:** 4.5 yds.  
**Seat:** 48" w 19" d 18.5" h      **Weight:** 72 lbs.      **COL:** n/a

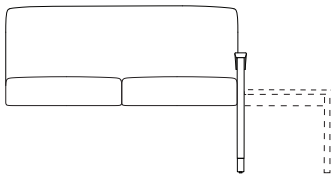

COM	COL	1	2	3	4	5	6	7	8	9	10	L1	L2
1885-C	N/A	1166	1283	1400	1517	1634	1750	1867	1984	2101	2218	N/A	N/A
<i>Closed Back / Tight Seat &amp; Back / Removable Upholstery</i>													
1885-R	N/A	354	471	588	705	822	939	1055	1172	1289	1406	N/A	N/A
<i>Replacement Upholstery Covers</i>													

**TWO PLACE ADD-A-SEAT / ACCEPTS TABLE ON RIGHT**



**Overall:** 49.75" w 24" d 34" h      **Arm:** 25" h      **COM:** 4.5 yds.  
**Seat:** 48" w 19" d 18.5" h      **Weight:** 72 lbs.      **COL:** n/a

COM	COL	1	2	3	4	5	6	7	8	9	10	L1	L2
1885-T	N/A	1166	1283	1400	1517	1634	1750	1867	1984	2101	2218	N/A	N/A
<i>Closed Back / Tight Seat &amp; Back / Removable Upholstery</i>													
1885-R	N/A	354	471	588	705	822	939	1055	1172	1289	1406	N/A	N/A
<i>Replacement Upholstery Covers</i>													

ARM CAPS / COVERS	OPTION #:	SPECIFICATIONS   LIST PRICES   AVAILABILITY:
<p data-bbox="87 178 292 210"><b>POLYESTER ARM CAPS</b></p> 	<p data-bbox="570 178 828 210"><i>Overall: 2.75"w 22.5"d 1.125"h</i></p> <hr/> <p data-bbox="570 262 844 325"><b>EPAC-1</b> \$177 Each - POLYESTER <i>Polyester Arm Cap (Specify Exposed)</i></p> <p data-bbox="570 367 974 399"><i>Available: Facelift Evolve Fully Upholstered Collection</i></p>	
<p data-bbox="87 640 292 672"><b>CONTRASTING COVERS</b></p> 	<p data-bbox="570 640 682 672"><i>Overall: N/A</i></p> <hr/> <p data-bbox="570 724 1477 829"><b>CC</b> \$129 <i>NOTE: If Two Or More Upholsteries Or Leathers Are Used On Any Piece Of Furniture, Then A Contrast Charge Will Apply Per Order. When Using Trinity Upholstery, The Higher Priced Upholstery Grade Will Be Used In Pricing, Unless It's Trinity Leather With Fabric Contrast Welt, Or COM With Trinity Contrast Welt, Then Contact Customer Service For Pricing.</i></p> <p data-bbox="570 871 974 903"><i>Available: Facelift Evolve Fully Upholstered Collection</i></p>	

# T R I N I T Y

*Established 1984*



## T R I N I T Y

---

P.O. Box 150  
Trinity, NC 27370  
T 336.472.6660 F 336.475.0037 TF 855.311.6660  
sales@trinityfurniture.com www.trinityfurniture.com