

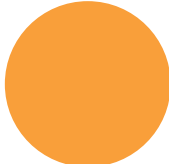

great things happen in a chair



SPEC THIS  **SPEC THAT**

PRICE LIST & SPECIFICATION GUIDE 2020

EFFECTIVE JANUARY 1, 2020



At Via Seating we have a philosophy—great things happen in a chair. It is with this vision that we set out to cultivate the perfect sitting experience. Through the creative genius of our team of engineers, ergonomists and designers across the world, we shape comfortable chairs with innovative technology at an incredible value backed by our industry-leading warranty. Our solutions translate across a variety of work and collaborative spaces. Explore our 17 categories and growing of seating including task, conference, executive, guest, lounge, outdoor, and more. Discover for yourself how great things happen in a Via Seating chair.

our commitments to you



to be innovative

Experience an extensive breadth and depth across 17 categories of seating, superior ergonomic technology and Via Seating's signature proprietary molded foam comfort.



to be easy to spec

Custom build your chair and generate a visual quote with list pricing on our easy-to-use, quick, digital spec it! builder or highly visual price book.



to be quick ship

Via Seating has more than a quick ship program. We are a quick ship company on 99% of our offerings with a 48 hour manufacture time and 1 day to ship.











































to be covered

Our industry-leading, hassle-free warranty covers the whole chair—including the foam and labor—for 12 years.















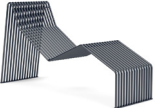































table of contents

Statement of Line	pg. 2
Products by Category	pg. 5
What's New?	pg. 6
What's Coming?	pg. 8
What's Easier to Spec?	pg. 9
Pricing, Terms & Conditions	pg. 10
48 Hour Quick Ship	pg. 11
Government Service Administration (GSA)	pg. 12
T.I.P.S. & Other Contracts	pg. 13
A Great Chair, A Great World Sustainability	pg. 14
12-year Warranty	pg. 15
Cleaning & Care Guidelines	pg. 16
Quick Ship Fabrics & Leathers; Technical Bulletins	pg. 17
COM/COL Program	pg. 18
Custom Upholstery Form (for COM/COL)	pg. 20
Custom Logo Request (Embroidery or Screen Print)	pg. 21
Proprietary Seat Foam (Backed by Via Seating's 12-Year Warranty)	pg. 22
Seat Size Selector (for Ergonomic Task, Conference & Executive Seating)	pg. 23
Fixed Arms	pg. 24
Adjustable Arms	pg. 26
Arm Caps (ie. Armrests) for Adjustable Arms	pg. 27
Control Mechanisms	pg. 28
Stool Control Mechanisms; Adjustable Headrests	pg. 30
Adjustable Lumbar Supports	pg. 31
Gaslifts (for Ergonomic Task, Conference & Executive Seating)	pg. 32
5-star swivel bases	pg. 33
Customer Service You'll Fall In Love With	pg. 34
TB133 Applications	pg. 179
Discontinued Products	pg. 180
Chair Series (see following page: Statement of Line)	























statement of line (part 1 of 3)

	pg. 35		pg. 35		pg. 35		pg. 35		pg. 35		pg. 35		pg. 41
4u mesh chairs		4u mesh task stools		4u groove chairs		4u groove task stools		4u upholstered chairs		4u upholstered task stools		Astro soft seating chairs	
	pg. 45		pg. 45		pg. 45		pg. 45		pg. 49		pg. 49		pg. 49
Brisbane low back chairs		Brisbane mid back chairs		Brisbane high back chairs		Brisbane task stools		Brisbane HD mid back chairs		Brisbane HD high back chairs		Brisbane HD swivel-caster stools	
	pg. 53		pg. 53		pg. 53		pg. 61		pg. 99		pg. 57		pg. 65
Carmel mid back chairs		Carmel high back chairs		Carmel jury chairs		Chico soft seating chairs		Chico ottomans		Chico benches		Comet soft seating chairs	
	pg. 69		pg. 69		pg. 69		pg. 73		pg. 77		pg. 77		pg. 77
Dyce mid back chairs		Dyce high back chairs		Dyce jury chairs		Edge soft seating chairs		Genie® chairs		Genie Copper Mesh® chairs		Genie® task stools	
	pg. 81		pg. 81		pg. 81		pg. 99		pg. 85				
Linate mid back chairs		Linate high back chairs		Linate jury chairs		Luna ottomans		Meteor soft seating chairs					
	pg. 89		pg. 89		pg. 89		pg. 89		pg. 91		pg. 95		pg. 95
Muvman® sit-to-stand stools		Muvman® Factory sit-to-stand stools		Muvman® Medical sit-to-stand stools		Muvman® Tall sit-to-stand stools		Orbit soft seating chairs		Oslo mid back chairs		Oslo high back chairs	
	pg. 103		pg. 103		pg. 103		pg. 103		pg. 103		pg. 103		pg. 103
Proform® Mesh mid back chairs		Proform® Mesh high back chairs		Proform® Panel mid back chairs		Proform® Panel high back chairs		Proform® Parallel mid/high back chairs		Proform® Diamond mid/high back chairs		Proform® task stools	

statement of line (part 2 of 3)

	pg. 109		pg. 109		pg. 109		pg. 113		pg. 113		pg. 113		
Reset nesting chairs		Reset light task chairs		Reset light task stools		Riva Mesh mid back chairs		Riva Mesh high back chairs		Riva Upholstered mid back chairs			
	pg. 119		pg. 119		pg. 119		pg. 119		pg. 123		pg. 123		pg. 123
Run II side/guest chairs		Run II mid back chairs		Run II mid back chairs		Run II mid back chairs		Sienna chairs		Sienna 2-seat couches		Sienna 3-seat couches	
	pg. 127		pg. 127		pg. 127		pg. 127		pg. 127		pg. 127		pg. 127
Sierra outdoor chairs		Sierra outdoor chaise lounge		Sierra outdoor couches		Sierra outdoor benches		Sierra outdoor tables		Sierra outdoor barbeques		Sierra outdoor litter bins	
	pg. 133		pg. 133		pg. 133		pg. 137		pg. 137		pg. 137		pg. 137
Spec Stools hands-free		Spec Stools hands-activated		Spec Stools tall stool		Splash stackable chairs		Splash bar/counter stools		Splash light task chairs		Splash light task stools	
	pg. 137		pg. 137		pg. 143		pg. 143		pg. 147		pg. 147		pg. 147
Splash stackable table		Splash transport carts		SplashAir stackable outdoor chairs		SplashAir stackable outdoor stools		Sutro stackable chairs		Sutro side chairs on wheels		Sutro light task chairs	
	pg. 147		pg. 147		pg. 151		pg. 151		pg. 151		pg. 151		pg. 151
Sutro light task stools		Sutro transport carts		Swopper® Classic motion chairs		Swopper® Air motion chairs		Swopper® Saddle motion chairs		Swopper® Custom motion chairs		Swopper® High motion chairs	
	pg. 153		pg. 153		pg. 153		pg. 153		pg. 153		pg. 153		
Tahoe outdoor chaise lounge		Tahoe outdoor benches		Tahoe outdoor tables		Tahoe outdoor picnic tables		Tahoe outdoor planters		Tahoe outdoor litter bins			

statement of line (part 3 of 3)

	pg. 159		pg. 159		pg. 159		pg. 159		pg. 163		pg. 163
Terra low back chairs		Terra mid back chairs		Terra high back chairs		Terra task stools		Vero mid back chairs		Vero high back chairs	
	pg. 167		pg. 167		pg. 167		pg. 167		pg. 167		pg. 167
Vista II Poly Poly stackable chairs		Vista II Poly Poly side chairs on wheels		Vista II Mesh stackable chairs		Vista II Mesh bar/counter stools		Vista II Upholstered stackable chairs		Vista II Upholstered bar/counter stools	
	pg. 167		pg. 167		pg. 167		pg. 167		pg. 171		pg. 171
Vista II Upholstered side chairs on wheels		Vista II Upholstered bariatric chairs		Voss Upholstered mid back chairs		Voss Upholstered high back chairs		Zee 4-leg stackable chairs		Zee sled stackable chairs	
	pg. 175		pg. 175		pg. 175		pg. 175		g. 175		
Zee bar/counter stools		Zee guest chairs		Zee light task chairs		Zee light task stools		Zee transport carts			

products by category

TASK/WORK CHAIRS



4u chairs	pg. 35	Run II chairs	pg. 119
Brisbane chairs	pg. 45	Swopper® chairs	pg. 151
Brisbane HD chairs	pg. 49	Terra chairs	pg. 159
Genie® chairs	pg. 77	Voss chairs	pg. 171
Proform® chairs	pg. 103		
Riva chairs	pg. 113		

LIGHT TASK CHAIRS



Reset chairs	pg. 109
Spec Stools	pg. 133
Splash chairs & tables	pg. 137
Sutro chairs	pg. 147
Zee chairs	pg. 175

TASK/WORK STOOLS



4u stools	pg. 35	Spec Stools	pg. 133
Brisbane stools	pg. 45	Splash Stools	pg. 137
Brisbane HD stools	pg. 49	Sutro stools	pg. 147
Genie® stools	pg. 77	Swopper® stools	pg. 151
Proform® stools	pg. 103	Terra stools	pg. 159
Reset stools	pg. 109	Zee stools	pg. 175
Riva stools	pg. 113		
Run II stools	pg. 119		

CONFERENCE CHAIRS



4u chairs	pg. 35	Reset chairs	pg. 109
Carmel chairs	pg. 53	Riva chairs	pg. 113
Comet chairs	pg. 65	Run II chairs	pg. 119
Dyce chairs	pg. 69	Splash chairs	pg. 137
Edge chairs	pg. 73	Sutro chairs	pg. 147
Genie® chairs	pg. 73	Vero chairs	pg. 163
Linate chairs	pg. 81	Voss chairs	pg. 171
Orbit chairs	pg. 91	Zee chairs	pg. 175
Oslo chairs	pg. 95		
Proform® chairs	pg. 103		

LOUNGE CHAIRS



Astro chairs	pg. 41	Orbit chairs	pg. 91
Benches (Chico style)	pg. 57	Ottomans	pg. 99
Chico chairs	pg. 61	(Chico & Luna style)	
Comet chair	pg. 65	Sienna chairs	pg. 123
Edge chairs	pg. 73	& couches	
Meteor chairs	pg. 85		

EXECUTIVE CHAIRS



Carmel chairs	pg. 53	Proform® chairs	pg. 103
Dyce chairs	pg. 69	Vero chairs	pg. 163
Linate chairs	pg. 80	Voss chairs	pg. 171
Oslo chairs	pg. 95		

MULTI-USE FURNITURE

(stacking, nesting, guest & more)



Reset chairs	pg. 109	Sutro chairs	pg. 147
Spec Stools	pg. 133	Vista II chairs	pg. 167
Splash chairs & tables	pg. 137	Zee chairs	pg. 175

OUTDOOR FURNITURE



Sierra collection	pg. 127
SplashAir chairs	pg. 143
Tahoe collection	pg. 153

MOTION/SIT-TO-STAND CHAIRS



Muvman® sit-to-stand	pg. 89	Swopper® chairs	pg. 151
----------------------	--------	-----------------	---------

what's new?



Enhanced Comfort Large Seats 4u

- Offered on 4u Mesh, 4u Groove & 4u Upholstered.
- 400 lb. weight capacity when paired with the 67C, 67CSS, 67CSSFT, 74C and 74C-12SS controls.

Discover more on pg. 35.
Available now.



Ballistic Brisbane Brisbane & Brisbane HD

- Uses strategically placed black ballistic nylon to protect chair against gun, safety and utility belts.
- Available on mid backs, all seats.

Discover more on pg. 45.
Available now.



Executive Diamond Stitch Carmel

- Executive diamond stitching is sewn across the headrest.
- Offered on high & mid backs.
- Recommended with leathers.

Discover more on pg. 49.
Available now.



Royal Blue Microfiber Muvman®

Muvman® is now offered with a vibrant, royal blue microfiber.

Discover more on pg. 89.
Available now.



Light Task Stool Reset

New light task stools are at a tall stool height (7" height range) & extra-tall stool height (9" height range).

Discover more on pg. 109.
Available now.



Armless chairs Reset

Armless models are standard on the nesting chair, light task chair & light task stool models.

Discover more on pg. 109.
Available now.



Magnet Grey Options Run II

Now offering magnet grey on a swivel base, multiple height adjustable arms, textured arm cap, adjustable lumbar support and on all frames.

Discover more on pg. 119.
Available now.



Guest Chair Run II

New guest chair is available as an armless model or model with black, loop arms.

Discover more on pg. 119.
Available now.

what's new?



Latest outdoor series SplashAir

- Available as a chair or stool.
- Offered with choice of arms that match the full dipped-look of the framework and shell.
- Both chair and stool are stackable.

Discover more on pg. 143.
Available now.



Sage Green Color Sutro

New sage green color is available on the poly back & poly seat of the stackable chair, 4-leg chair on wheels, light task chair & light task stool.

Discover more on pg. 147.
Available now.



Planter Tahoe

- Available in micaceous anthracite, signal white & carmine red.
- The natural-look version is available with covers in micaceous anthracite & signal white.

Discover more on pg. 153.
Available now.



Enhanced Wood Base Zee

This side/guest chair is now offered with an understructure of wooden rungs that create an intriguing aesthetic with reinforced durability.

Discover more on pg. 175.
Available now.



67C Control

Shown on a Genie® chair.

DETAILS	REPLACING	FIND IT ON
Quick adjust advanced synchro control featuring single rotation adjustments. Offers an optional +2" seat depth adjustment (SS) with an optional ergonomic 5° forward tilt adjustment (FT).	-9C, -10C, -29C, -61C & -62C	4u, Brisbane HD, Carmel mid back, Genie®, GenieFlex, Oslo mid back, Proform®, Riva, Vero & Voss mid backs.

Discover more starting with 4u on pg. 35.
Available now.



74C Control

Shown on a Proform® chair.

DETAILS	REPLACING	FIND IT ON
Auto-adjust body balance control. Offers an optional +2" seat depth adjustment (-12SS).	-66C	4u, Genie®, GenieFlex, Proform® & Vero.

Discover more starting with 4u on pg. 35.
Available now.

what's coming?



GenieFlex

Latest ergonomic task series.

- Explore GenieFlex, Via Seating's latest ergonomic task chair & stool series.
- Features an ergonomic FlexBack made of thermoplastic polyurethane (TPU), sculpted for maximum comfort and integrated lumbar support.

Discover more on online.

Available Q3.



Vista

Poly Poly

- Available as a stackable chair or a bar stool with integrated foot rest.
- Offered as an armless model or with choice of fixed, black, loop arms.
- Optional casters.

Discover more on pg. 167.

what's easier to spec?

ON SERIES	NATURE OF THE CHANGE	NOW IS	USED TO BE
4u	One code for each mesh color.	Options -01U, -02U, -03U	options -01UB, -02UB, -03UB & -01UW, -02UW, -03UW
	One code for each groove color.	Options -01UG, -02UG, -03UG, -04UG, -05UG, -06UG, -07UG	options -01UGB, -02UGB, -03UGB, -04UGB, -05UGB, -06UGB, -07UGB & -01UGW, -02UGW, -03UGW, -04UGW, -05UGW, -06UGW, -07UGW
Genie®	Optional white frames.	Option -W	models 421, 425, 428, 430
	One code for each mesh color.	Options -1G, -2G, -3G, -4G, -5G, -6G, -8G, -11G, -12G	options -1B, -2B, -3B, -4B, -5B, -6B, -8B, -11B, -12B & -1W, -2W, -3W, -4W, -5W, -6W, -8W, -11W, -12W
Proform®	One code for each mesh color.	Options -01PM, -02PM, -03PM, -04PM, -06PM, -08PM, -09PM	Options -01PMMP, -02PMMP, -03PMMP, -04PMMP, -06PMMP, -08PMMP, -09PMMP & -01PHMP, -02PHMP, -03PHMP, -04PHMP, -06PHMP, -08PHMP, -09PHMP
Riva	One code for each mesh color.	Options -01H, -02H, -03H, -04H, -06H, -08H, -09H	options -01MM, -02MM, -03MM, -04MM, -05MM, -06MM, -08MM, -09MM & -01HM, -02HM, -03HM, -04HM, -05HM, -06HM, -08HM, -09HM & -11MM, -12MM, -13MM, -14MM, -15MM, -16MM, -18MM, -19MM & -11HM, -12HM, -13HM, -14HM, -15HM, -16HM, -18HM, -19HM
	Optional fixed back.	Option -F	4M12, 4M14, 4M22, 4M24, 4M32, 4M34, 2V14, 2V24, 2V34
	Option of tailored seats or enhanced comfort seats on the mesh backs.	Option of both seats now available in the Riva series.	Tailored seats were listed in the Voss series.
Run II	One code for each mesh color.	Options -1R, -2R, -3R, -4R, -5R, -6R, -7R	options -01MR, -02MR, -03MR, -04MR, -05MR, -06MR, -07MR & -01HR, -02HR, -03HR, -04HR, -05HR, -06HR, -07HR
Sutro	Optional arm on all chair models.	Option -SA1	models 622, 632
Splash	Optional arm on all chair models.	Option -SA2	models 811, 812, 815, 816, 817, 818
SplashAir	Optional arm on all chair models.	Option -SA3	models 821, 823.

pricing, terms & conditions

PRICING

- Prices listed in this book are LIST prices including standard freight. Merchandise is sold FOB ORIGIN, with ownership transferring to the purchaser at the time of shipment, within the 48 contiguous United States.
- Prices are subject to change without notice, prior to order confirmation. List prices are subject to trade discount for qualified purchasers.
- Every effort is made to ensure that the Price List and all support documentation are up-to-date at the time of printing.

CREDIT

- Credit should be established in advance of placing an order with Via Seating to allow time for credit verification.
- A credit limit will be determined upon acceptance of satisfactory references.
- If an open account has not been established by the time of shipping, first time orders with approved credit must be accompanied by a 50% deposit with balance due 30 days upon shipment.
- New customers must contact Via Seating, or a Via Seating representative for a credit application.

TERMS

- Existing customers with approved credit; Terms are Net 30 Days.
- Past due accounts are subject to a monthly service charge of 1.5% (18% APR).
- All orders placed without approved credit must be pre-paid in full prior to production.
- First time orders with approved credit must be accompanied by a 50% deposit with balance due 30 days upon shipment.
- GSA Teaming Agreements do not override Via Seating's standard Terms.

SHIPPING & FREIGHT

- The best method of shipping is determined by Via Seating. All packaging is included.
- **STANDARD SHIPPING:** Most Via Seating chairs

ships 95% assembled (NO TOOLS REQUIRED).

- **FULLY ASSEMBLED:** 100% assembled in a box is +\$80 LIST per chair (task & executive chairs only).
- **BLANKET WRAPPED:** minimum order of 150, call chairs (call 1-800-433-6614 for more information).
- Freight is not included for smaller quantities within the multi-use category.
- See freight costs for outdoor furniture.
- Zone restrictions apply to; Alaska, Hawaii, Puerto Rico, Guam, Canada and Mexico.
- Charges are non-negotiable for any shipping costs outside of Via Seating typical shipping. Additional charges apply to orders requiring: liftgate, inside delivery, address changes, storage or holding costs and any conditions outside of those for standard shipping.
- Short shipments must be noted on the bill of lading and a copy of this must be sent to Via Seating within 5 days of delivery.

FREIGHT TERMS

- The dealer is responsible for all storage or holding costs associated with freight delivery. Charges are non-negotiable for any shipping costs outside of Via Seating typical shipping. Including storage or holding costs, re-delivery charges, and change of address after shipment.
- Expedited freight for overnight, second and third day delivery are available at an additional charge. Call your Via Seating Customer Service Specialist for a quote. Please allow 24 hours for all quotes.

CHANGES/CANCELLATIONS

- Change requests may result in a change fee.
- Changed or canceled non-stock fabric or leather orders will result in restocking charges.
- Cancelled orders already in production will result in restocking charges.
- Contact Customer Service at 1-800-433-6614 for more information.

RESELLERS & PRODUCT DISPLAY

- Prior permissions from Via Seating in writing

& signed are required to display or sell Via Seating product through any form of print or digital media including websites, in person and through any method of sale.

FREIGHT CLAIMS

- All Via Seating products are carefully inspected and securely packed prior to leaving our facility.
- All damage claims should be filed with Via Seating within five (5) days of receiving merchandise. The customer accepts responsibility for damage including concealed damage. Before accepting a shipment from the carrier, check for visible damage. Describe the visible damage on the freight carrier's delivery receipt. If damage is concealed, contact Via Seating without delay, requesting inspection. If this inspection is not obtainable, describe the damage in writing, giving the date the damaged product was received and file a claim with Via Seating. Include pictures.
- Claims must include a Returns Material Authorization (RMA) form
- Returns are not accepted without prior consent from Via Seating and must have a Returns Material Authorization number assigned by Via Seating
- Authorized returns are subject to a minimum 25% restocking charge depending on circumstances
- Shipping costs for returned merchandise are the responsibility of the customer

<https://www.viaseating.com/warranty>

EXPEDITED ORDERS

- Every effort will be made to meet our customers install/delivery dates.
- If there is a necessity to expedite production, an additional charge will be applied. Via Seating will notify the customers with details on additional charges.
- Via Seating is not responsible for costs associated with missed delivery.
- Guaranteed delivery purchases must be made to carrier.

48-hour quick ship

Via Seating is a quick ship company. Over 95% of the Via Seating offerings are on 2 day quick ship schedules. This includes our task, swivel-caster stool, heavy duty, conference, executive, management, multi-use, lounge, and motion seating offerings.

THE QUICK SHIP SCHEDULES

CODE	# MADE	DETAILS	WHAT'S INCLUDED?
20	20/48	20 chairs manufactured in 48 hours.	4u mesh back, 4u groove back, Genie®, GenieFlex, Muvman®, Riva, Run II, Spec Stools, Splash, Sutro, Swopper®, Terra, Vista II & Zee.
15	15/48	15 chairs manufactured in 48 hours.	4u upholstered back, Brisbane, Brisbane HD, Ballistic Brisbane, Terra & Voss.
10	10/48	10 chairs manufactured in 48 hours.	Carmel, Dyce, Linate, Oslo, Proform®, Vero, upholstered seats 8US, 7US & 6US, upholstered seats & backs 8USB & 6USB & upholstered backshells 20UPH, 22UBF & 22UBL.
5	5/48	5 chairs/benches/ottomans manufactured in 48 hours.	Chico, Edge, Luna, Carmel with executive diamond stitch & Proform® with executive diamond stitch.
2	2/48	2 chairs manufactured in 48 hours.	Astro, Comet, Meteor, Orbit & all upholstered arms.
1	1/48	1 chairs manufactured in 48 hours.	Sienna.

HOW IT WORKS



1 day to process your order.

Includes series with quick ship schedules using quick ship fabrics & textiles. Processed on business days by noon pacific time.



2 days (48 hours) to build it.

Number produced is based on the series & optional add-ons quick ship schedules.



1 day to process & ship it out.

Chairs are processed and shipped out on business days.

Our lead times are customized not prescribed. Your customer service specialist (1-800-433-6614) can best build your shipping schedule with you. Please call you customer service specialist for lead times on COM/COL textiles, custom colors/options, screen printing & embroidery. Quick ship schedules exclude weekends & holidays.

WHERE TO FIND THIS INFORMATION

Quick ship table at the top of each series page: **Code** next to starting list models & options:

QUICK SHIP SCHEDULES

Code is listed in the starting model. Deviations from this are listed where they occur.

CODE	# MADE	DETAILS
10	10/48	10 Chairs manufactured in 2 business days.
📞	CALL	FOR LEAD TIME: 1-800-433-6614

1. CHOOSE YOUR SEAT

SEAT SIZE →	Standard A seat.
PART #	20 2V13
STARTING LIST PRICE	\$554
IMAGE	



QR CODE

GSA terms & conditions

FSC GROUP 71

CONTRACT NUMBER: GS-28F-005CA

CONTRACT PERIOD: January 26, 2015 through January 25, 2025 Business Size: Small

CONTRACTOR/CONTRACT ADMINISTRATOR:

Via, Inc.
205 Vista Blvd
Sparks, NV 89434
Phone: 800-433-6614
Fax: 800-833-9094

On-line access to contract ordering information, terms and conditions, up-to-date pricing and the option to create an electronic delivery order is available through *GSA Advantage!*, a menu-driven database system.

The INTERNET address for GSA Advantage! is: <http://www.gsa.gov>. Worldwide Federal Supply Schedule Contract For Schedule 71 Office Furniture

For more information on ordering from Federal Supply Schedules click on the FSS Schedules button at <http://www.fss.gsa.gov>.

General Services Administration Management Services Center Acquisition Division Price list.

- 1a. **711-16: Upholstered Seating.**
Includes sofas, loveseats, lounge chairs, sleep sofas and recliners. Benches and ottomans complementing the matching sofa, loveseat or chair are also offered.
- 1b. Item number: 926 **GSA NET \$226.81** Unit: **Each.**
- 1c. Hourly rates: **Not applicable.**

- 1a. **711-18: Multipurpose Seating.**
Rotary chairs that utilize a pedestal base with casters. Stationary chairs that utilize a sled base, cantilever, "O" frame, or straight leg style. Ergonomically designed chairs that are rotary, have seat and/or back tilt, pneumatic seat height adjustment. Rotary drafting-style chairs with foot ring or footrest, with or without arms, with glides or casters.
- 1b. Item number: 931 **GSA NET \$210.43** Unit: **Each.**
- 1c. Hourly rates: **Not applicable.**

- 1a. **711-19: Stacking Chairs.**
Stacking chairs and dollies or trucks designed to support stacking chairs.
- 1b. Item number: 602 **GSA NET \$78.85** Unit: **Each.**
- 1c. Hourly rates: **Not applicable.**

2. Maximum Order. **\$300,000.00 NET**

3. Minimum Order. **\$100.00 NET**

4. Geographic coverage (delivery area). **Standard freight included to the 48 contiguous United States and the District of Columbia. Call Via Seating for shipping freight to Alaska, Hawaii, Puerto Rico and other global locations outside of the 48 contiguous United States.**

5. Point(s) of production. **Sparks, Washoe County, NV**

6. Discount from list prices or statement of net price.

Pricing Based on Via Seating 2020 Price List and Specification Guide.

\$0 to \$35,000 List **55.7% off List**

7. Quantity discounts.
\$35,001 to \$50,000 List **58.7% off List**
\$50,001 to \$75,000 List **60.7% off List**
\$75,001 to \$150,000 List **61.7% off List**
\$150,001 to \$300,000 List **62.7% off List**

8. 1.5% 15 days or NET 30 days.
Information for Ordering Offices: Prompt payment terms cannot be negotiated out of the contractual agreement in exchange for other concessions.

9a. Government purchase cards are accepted at or below the micro-purchase threshold.

9b. Government purchase cards are accepted at or above the micro-purchase threshold.

10. Foreign items. **None. TAA Compliant**

11a. Time of delivery. 45- 90 days ARO.

11b. Expedited Delivery. **Contact Factory**

11c. Overnight and 2-day delivery.

Contact Factory

11d. Urgent Requirements. **Contact Factory**

12. F.O.B. point(s). **Destination**

13a. Ordering address(es).

VIA, Inc.
205 Vista Blvd
Sparks, NV 89434
Phone: 800-433-6614
Fax: 800-833-9094
E-Mail: orders@viaseating.com

13b. Ordering procedures: For supplies and services, the ordering procedures, information on Blanket Purchase Agreements (BPA's) are found in Federal Acquisition Regulation (FAR) 8.405-3.

14. Payment address(es).

VIA, Inc.
205 Vista Blvd
Sparks, NV 89434
Phone: 800-433-6614

15. Warranty provision. **Standard Via Seating Commercial Warranty**

16. Export packing charges, if applicable. **Call for quote.**

17. Terms and Conditions of Government purchase card acceptance (any thresholds above the micro-purchase level). **Via, Inc. accepts the government commercial credit card but no additional discount for orders placed using the credit card.**

18. Terms and conditions of rental, maintenance, and repair. **N/A**

19. Terms and conditions of installation. **N/A**

20. Terms and conditions of repair parts indicating date of parts price lists and any discounts from list prices.

Contact Factory

20a. Terms and conditions for any other services.

Contact Factory

21. List of service and distribution points.

Contact Factory

22. List of participating dealers. **Please call 1-800-433-6614 for participating dealers in your area.**

23. Preventive maintenance. **Cleaning and care guidelines are available online and upon request.**

24a. Special attributes such as environmental attributes (e.g., recycled content, energy efficiency, and/or reduced pollutants). **Via, Inc. sustainability policies and programs along with BIFMA LEVEL and Clean Air certifications are available on our website at <https://www.viaseating.com/a-great-chair-a-great-world/sustainability>**

24b. If applicable, indicate that Section 508 compliance information is available on Electronic and Information Technology (EIT) supplies and services and show where full details can be found (e.g. contractor's website or other location.) The EIT standards can be found at: www.Section508.gov/. **N/A**

25. DUNS. **17-4858472**

TAX ID. **88-0226421**

Cage Code. **OY2L7**

NAICS Code. **337214**

26. Notification regarding registration in System for Award Management (SAM) database. **Registered and Current.**

Restocking Policy: The restocking fee is 25% of the net cost for items returned for other than warranty reasons. Agencies must notify contractor for authorization prior to returning items.

Cancellation Policy: No cost prior to production. After production has begun or any special-order fabrics ordered, only actual cost incurred that cannot be recovered through resale in six months will be billed to the Government.



T.I.P.S. terms & conditions

Contract Number: 180305 Furniture, Furnishings and Services (2)

Awarded to: Via, Inc. ("via seating")

Contract Period: May 25, 2018 to May 31, 2020

EDGAR COMPLIANCE: Yes.

End-user must become a member of TIPS

- Process is easy and free.
- Visit <http://tips-usa.com/newmember.cfm>
- Benefits are available to Education, Government & Non-Profit agencies.

End-user PO to be made out to Via, Inc. c/o dealer

- End-user PO to be sent to TIPS for processing (tipspo@tips-usa.com), and TIPS will forward to Via for processing (include dealer quote with PO).
- Dealer will need to be added to our "authorized

reseller" list in advance of order being placed.

- "TIPS" and Contract # must be included on PO.
- Contract #: 180305.

Discount to end-user (TIPS member):

(Includes All Via Seating products)

\$0 to \$35,000 List	45.0% off List
\$35,001 to \$50,000 List	47.0% off List
\$50,001 to \$75,000 List	49.0% off List
\$75,001 to \$150,000 List	51.0% off List
\$150,001 to \$200,000 List	53.0% off List
Over \$200,000 List	Discount negotiable.

Discount to dealer:

- Standard discount unless project warrants SPA
- Standard SPIFF rules apply
- Delivery and install to be negotiated between

dealer and end user; must be a separate line item (if applicable).

- Please request a member search for your region.
- Tariff surcharges DO NOT APPLY.

Discount from list prices or statement of net price.

Pricing Based on Via Seating 2020 Price List and Specification Guide.

More details online at: <https://viaseating.com/solutions/government/us-federal-government/national-purchasing-cooperative-tips/>

VA IDIQ terms & conditions

Contract: VHA IDIQ

Contract Period: effective November 1, 2018

Special conditions:

Must go through 1 of 9 awarded SDVOSB dealers.

Must be used for VA Health Facilities.

More details online at: <https://viaseating.com/solutions/government/us-federal-government/contracts-vha-idiq/>

Discount from list prices or statement of net price.

Pricing Based on Via Seating 2020 Price List and Specification Guide.

other contracts

Via Seating offers an extensive breadth of seating solutions on contract with a variety of purchasing groups, multi-state, state and local government coalitions and agencies. Explore these purchasing groups and contracts below.

Visit: <https://viaseating.com/solutions/government/contracts-purchasing-groups/>

great chairs
that are
consciously built



a great chair, a great world

At Via Seating we believe great things happen in a chair. We understand that to make this happen, it takes a lot more than creating a great chair. Discover how we're committed to developing a greater, more inclusive workplace, a greater, more sustainable environment, and greater, more enriched communities.



Studio V

Studio V creates modern, sophisticated and original seating solutions that are ergonomic, beautiful and sustainable. This team of engineers and designers is based in Reno, Nevada, where they develop products using a prototyping lab, the latest in 3D modeling software and a materials testing center. All Via Seating are tested through an unaffiliated third-party testing lab to ANSI/BIFMA standards. They are each tested again through our internal testing lab.



BIFMA LEVEL® 2

BIFMA's sustainability certification program for furniture.

All Via Seating products are **BIFMA LEVEL® 2** certified.



CLEAN AIR GOLD

ANSI/BIFMA e3-2014e, Sections 7.6.1, 7.6.2, 7.6.3

All Via Seating products are **CLEAN AIR GOLD** certified.



mindful MATERIALS

All Via Seating products are listed on the mindful MATERIALS Library, powered by Origin. The mM Library is a freely searchable platform where users can access product data such as BIFMA LEVEL® certifications, Clean Air certifications, LEED data and more.



Healthier Hospitals

Via Seating products meet the HH Healthy Interiors Goal for Seating (chairs, stools, sofas, benches, recliners, loungers, etc.) – Safer Chemicals Challenge, Version 2.0.



LEED Credits

Via Seating products earn points toward LEED certification. These LEED credits include those for environmentally preferable furniture, low emitting furniture, recycled content, post consumer material and for our local U.S. manufacturing location in Sparks, NV.

12 year warranty

All Via Seating products are manufactured with meticulous attention to detail to be high quality, durable and long-lasting.

VIA Inc (hereafter referred to as Via Seating) warrants to the initial purchaser, Via Seating product will be free from defects in its materials and craftsmanship found during normal single shift usages; single shift usage is five (5) days a week, eight (8) hours a day for the following warranty periods. This coverage shall be effective for the applicable time period beginning from date of original sale.

Products covered by this warranty will be either repaired or replaced at Via Seating's discretion. Product repair or replacement of any defective part is the customer's exclusive remedy for any and all product defects. Via Seating will pay for warranty repair costs pre-approved when shown to be a result of a defective part. Such payment will be made in the form of a credit to an active authorized Via Seating dealer account. The user shall be responsible for all maintenance service, which includes but not limited to: lubricating and cleaning of the product, assembly, adjustment, checking all screws every six months and performing operation checks. Only those items free of misuse and abuse will be covered. Items with alternations, unauthorized repairs, or damaged by fire, flood or other acts of God will not be covered. This warranty applies to all Via Seating products manufactured after January 1, 2017. There are no other warranties, expressed or implied, other than those specifically described here.

ANSI/BIFMA COMPLIANCE

Via Seating products- Via Seating designs and manufactures all of its products in accordance with the ANSI/BIFMA standards.

motion seating products - aeris GMBH manufactures all of these products in accordance with European DINN standards.

Outdoor furniture - Via Seating tests all outdoor furniture to ANSI/BIFMA standards.

WARRANTY PERIODS

12-YEAR WARRANTY COVERAGE

All Via Seating products are warranted for 12 years—including 24/7 use chairs—except where noted. Unless otherwise specified, Via Seating's proprietary, closed-cell cold-cured, injection molded foam is also warranted for a period of 12 years.

24/7 SHIFT APPLICATIONS

Via Seating's 24/7 shift applicable series- Brisbane HD 24/7, Genie®¹, GenieFlex including FlexBack with TPU and Vista II are all covered under Via Seating's 12 year warranty².

1 Mesh on Genie® is covered for 2 years at 24/7 use.

2 Textiles are covered for 2 years at 24/7 use.

TEN-YEAR WARRANTY COVERAGE

Vista II chairs on casters.

SIX-YEAR WARRANTY COVERAGE

All lounge series (Astro, Chico, Comet, Edge, Luna, Meteor, Orbit & Sienna), multi-use series (Splash, Sutro & Zee).

FIVE-YEAR WARRANTY COVERAGE

Via Seating quick ship leathers and fabrics, mesh (4u, Genie®, Reset, Run II, Splash, Vista II), 4u groove fabric, outdoor (Sierra, SplashAir, Tahoe), Swopper®.

THREE-YEAR WARRANTY COVERAGE

Motion seating (Muvman®).

TWO-YEAR WARRANTY COVERAGE

Knit mesh (Proform®, Riva, Voss), mechanical lumbar option.

Via Seating reserves the right to make changes in design/construction and to discontinue products without prior notice.

Via Seating reserves the right to make changes to the 12 year warranty and price book without prior notice.

WARRANTY EXCEPTIONS

(not covered under warranty)

- COM/COL textiles.
- Color-fastness or matching of colors patterns or dye lot, including; minor variations, color matches to swatches used for specification purposes and/or prior purchases.
- Products specified outside of those shown in this price list.
- Products with unauthorized repair or alteration.
- Products not used, maintained or installed in accordance with Via Seating's applicable guidelines.
- Products exposed to conditions deemed extreme (i.e. environments other than "normal commercial, indoor office" spaces) and damage from sunlight and UV rays.
- Products purchased "as is" or second hand/refurbished products.
- Products sold by unauthorized dealers.
- Variations of leather; dye lots, environment marks, scars, bites, rubs, wrinkles, stretch marks, pattern markings and minor irregularities in color, surface, grain & texture.
- Samples, floor/showroom samples, road samples.
- Damage caused by the carrier in-transit, which will be handled as a separate claim against the carrier.
- Damage caused by staining, sharp objects, imprinting from instruments and water damage.

CLAIM PROCESS

Please visit:

<https://www.viaseating.com/warranty>

A Return Material Authorization (RMA) is required to be sent with product returned to Via Seating. Send a written notification (with pictures) of the defect to Via Seating along with a copy of the original invoice in order to generate a Return Material Authorization.

cleaning & care guidelines

OVERALL CARE GUIDELINES

- We recommend that you always read the manufacturer's directions printed on all cleaning agents thoroughly before using and follow those guidelines as they are stated.
- Before using any new cleaning product test it out in an inconspicuous spot on the chair.
- If you notice a stain on your chair, try to remove it immediately. Letting it sit may cause the stain to sink into the material, making it more difficult to remove.

PLASTICS ("POLY")

- For general cleaning, gently wipe the plastic with a dry, clean, lint-free cloth lightly wet in a soap-and-water mixture.
- For any stains, wet a dry, lint-free cloth lightly in white distilled vinegar and wipe the area until the stain is gone.
- For a deeper stain, use a soft-bristle brush wet in a soap and water mixture to wipe gently at the stain. Avoid scrubbing too hard as this can create scratch marks.

MESH

- For general cleaning, gently wipe the mesh with a dry, clean, lint-free cloth.
- Vacuum up the entire back of the chair to remove any dust/dirt/crumbs that may be hidden in the mesh. Take your lint-free cloth, damp it in any water-based cleaning agent and gently dab the area where the stain is. Do not scrub across the mesh as this may cause the mesh to fray. Continue to dab at the stained area until the stain is soaked up.

FABRIC

- For best care and maintenance, we recommend first checking the fabric manufacturer's website for the best cleaning and care guidelines.
- For general cleaning, gently wipe the fabric with a dry, clean lint-free cloth.
- Vacuum up the entire back of the chair

to remove any dust/dirt/crumbs that may be hidden in the upholstery. Take your lint-free cloth, damp it in any water-based cleaning agent and gently rub the area where the stain is. Dry the upholstery with a clean lint-free cloth once you're finished.

VINYL

- For best care and maintenance, we recommend first checking the vinyl manufacturer's website for the best cleaning and care guidelines.
- For general cleaning, gently wipe the vinyl with a dry, clean lint-free cloth.
- Wet your soft-bristled brush in the warm water and mild soap mixture. Do not use detergents as this can change the look & feel of the vinyl. Moderately scrub the stain with the wet bristle brush. Wipe the loosened stain off with a lint-free cloth.

LEATHER

- For best care and maintenance, we recommend first checking the leather manufacturer's website for the best cleaning and care guidelines.
- For general cleaning, gently wipe the leather with a dry, clean lint-free cloth.
- For any stains, wet a dry, lint-free cloth lightly in a non-detergent, soap-and-water mixture. Gently dab at the impacted area. Do not scrub. Allow the area to dry naturally.

PAINTED/POLISHED METAL

- For general cleaning, gently wipe the painted or polished metal with a dry, clean lint-free cloth.
- For stains, apply a small amount of a nonabrasive cleaner to a dry, clean, lint-free cloth. Rub the stains with the wet cloth. When finished, wipe the areas with a new, dry, clean, lint-free cloth.

LAMINATED SURFACES

- For general cleaning, gently wipe the

leather with a dry, clean lint-free cloth wet in a vinegar-and-water mixture.

- For stains, completely dry the pooled liquid on the laminate surface. Leaving the stain to dry could cause warping or a deepened stain. Do not use bleach-based cleaners, waxes, oils or furniture polish as this may compromise the integrity of the laminate.
- For deep stains, wet a clean, lint-free cloth in a soap-and-water mixture, gently using this to wipe the laminate. Rub the stained area in the direction of the grain or in a circular motion when no grain is present. After stain is removed, wet a clean, lint-free cloth in a vinegar-and-water mixture, gently using this to wipe the laminate.

WOOD

- For general cleaning, gently wipe the wood with a dry, clean lint-free cloth wet lightly in warm waters. Wipe dry with a new, dry, clean, lint-free cloth.

CASTERS & GLIDES

- For general cleaning, gently clean the casters or glides with a dry, clean, lint-free cloth wet in a mild soap-and-water mixture. Always keep the floors beneath casters and glides clean as they will pick up dust, dirt and lint from the floor. Dust, dirt and lint will degrade the performance of casters and glides over time.

More cleaning and care guidelines can be found online at:

<https://viaseating.com/professional-resources/care-assembly/>

All references to commercial cleaning products and their trade names does not imply endorsement by VIA, INC (Via Seating). It also does not imply any bias against those cleaning products that were not mentioned.

quick ship fabrics & leathers

QUICK SHIP FABRICS

Visit www.viaseating.com/materials to explore the depth of Via Seating's in-stock, fabrics & leathers. Browse the wide range of our textile cards. Explore solutions including wool, faux felt, non-pvc, HHI compliant selections and much more. Don't see what you like? Explore thousands of patterns and colorways offered by our textile partners. We have made specifying their lines easy by providing extensive graded-in product charts.

GRADED IN FABRICS

Graded in fabrics are fabrics set a LIST price for use on an order. Their graded in charts can be found online.

Via Seating offers thousands of graded in textile possibilities. Not all graded in fabrics have been tested on every chair model. When specifying a graded in fabric, our customer service team can help determine with your selection.

Allow 10 business days for delivery of graded in, non-stocked fabrics and leathers, plus 4 days for receipt and check in.

technical bulletins

FLAMMABILITY STANDARD REQUIREMENTS FOR UPHOLSTERED FURNITURE

WHAT IS TB-117?

TB 117-2013, the latest CAL-117 Tech Bulletin, is a flammability standard for upholstered furniture. It mandates that, beginning January 1, 2015, all filling materials (i.e. foam) in California must meet the smolder-resistant requirements of the TB 117-2013 Resilient Filling Material Test. These test methods are intended to estimate the performance of upholstered furniture under conditions of exposure to a smoldering cigarette and the flammability resistance of the inner materials.

TB-117 APPLICATION AT VIA SEATING

All Via Seating product manufactured with Via Seating in-stock fabrics meet the requirements of California TB 117-2013.

COM & TB-117

COM fabrics are not guaranteed to pass TB 117-2013. Please contact the COM supplier directly to determine the flame-retardant nature of any COM supplied to Via Seating.

WHAT IS TB-133?

Technical Bulletin 133 is a test procedure designed to test seating furniture subjected to ignition sources that may be typical of arson, incendiary fires, or common accidental fires in public buildings. Unlike TB 117-2013, TB-133 tests the entire chair. TB 133 has been repealed by California's Bureau of Electronic and Appliance Repair, Home Furnishings and Thermal Insulation, effective January 22, 2019.

A recent change to the Boston Fire Prevention Code removes the requirement for furniture to comply with California Technical Bulletin 133 (Cal TB 133) in a fully sprinklered buildings; however, if the assembly space is not sprinkler protected, compliance with CAL TB-133 is

still required in the City of Boston.

TB-133 APPLICATION AT Via Seating

The chairs presented within this price book, unless otherwise specified, do not meet TB-133. Most Via Seating chair models can be prepared to meet the flame-retardant requirements of TB-133 and the Boston Fire Code. Via Seating does not add flame retardant chemicals to comply with TB-133, the fire resistance is accomplished by upholstering the chair with a naturally flame-retardant fabric barrier (i.e. Kevlar® or equivalent). Additionally, most plastic components (i.e. seat pan, back shell, shrouds, etc.) must be either removed or completely upholstered with a flame-retardant material.

Please note, any chair models specified to comply with TB-133 may not resemble what has been photographed and shown in marketing materials. Via Seating is not responsible for determining the requirement of TB-133 compliance. Check with your local building departments to determine if TB-133 is required on your order. To specify TB-133 on Via Seating chairs, please refer to page

COM & TB-133

Additional COM/COL is required for TB-133. Please send in COM/COL requirements for seat/back cushions and the back shell.

COM/COL program

CUSTOMER'S OWN MATERIAL (COM) | CUSTOMER'S OWN LEATHER (COL)

COM/COL ORDER PROCESS

Please send a 6" x 6" or larger textile swatch to Via Seating to test for approval. A larger sample will allow for a more thorough test of the textile. Allow 4 business days to process this test upon receipt of the material.

Once the order has been placed, fill out a "custom upholstery form" for each COM/COL textile and e-mail to info@viaseating.com. This must include your PO#. This form will help ensure correct application of your COM/COL.

All COM/COL must be shipped to:

**ATTN: FABRIC DEPARTMENT,
205 Vista Blvd, Sparks, NV 89434**

Your COM/COL received by Via Seating must be clearly marked, containing customer's name, purchase order number (PO#) and, when applicable, Via Seating order #.

Please allow 4 business days for COM/COL to be check-in at Via Seating - Subject to manufacturer's availability.

COM/COL APPROVAL PROCESS

Via Seating assumes no responsibility for the durability or tailoring quality of any COM or COL. Directional covers, in particular, may not meet your satisfaction due to the design of certain products. Please be advised that products upholstered in COM/COL are not subject to return to Via Seating. Via Seating reserves the right to reject COM fabrics that, in Via Seating's opinion, are unsuitable for its products. Via Seating can determine this within 48 hours of receipt of the COM/COL sample.

RECEIPT OF COM/COL TO VIA SEATING

Under no circumstances will Via Seating be responsible for shortages or flaws in the material or other such problems. Via Seating will not be responsible for any costs associated (e.g. return freight and/or restocking charges) with rejected COM or COL materials. In order to meet delivery deadlines, we assume that our customers are aware of any undue delays in the shipment of their ordered fabrics. Once the COM has been accepted, Via Seating assumes no responsibility for its overall appearance, flammability, normal durability, colorfastness, material defects, color inaccuracies, dye lot variations, or any other flaws related to the fabric quality after upholstered on a Via Seating product. If you have doubts of the ultimate appearance of a certain covering, please order a sample chair upholstered in the specific COM or COL.

COM/COL WARRANTY STATEMENT

All COM & COL textiles applied to Via Seating product orders will not be covered under Via Seating's warranty. Any warranty claims need to be made directly to the original vendor of the textile. Via Seating recommends that the purchaser thoroughly test any COM & COL with all cleaning agents that will be used on it prior to using.

COM/COL EXCESS YARDAGE

Excess COM/COL will be recycled at the discretion of Via Seating, unless direction for the additional fabric/leather is given by the customer at the time the order is placed. If the additional COM/COL needs to be returned to the customer, they must contact Via Seating's customer service team at **1-800-433-6614 (press 1 for customer service)** or by e-mailing info@viaseating.com. Any returned COM/COL will be paid for by the customer.

COM calculation

BREAKING DOWN HOW TO CALCULATE TOTAL CUSTOMER'S OWN MATERIAL (COM) NEEDED PER ORDER

COM YARDAGE LISTED IN PRICE BOOK

COM yardage requirements shown in the Via Seating price book are based on non-directional textiles with a width of 54". Fabrics less than 54" wide or those requiring matching stripes, prints, or matching large pattern designs will require additional material.

COM WIDTH & REPEAT TABLE

FABRIC WIDTH	NON-DIRECTIONAL FABRIC	PATTERNS CONTAINING STRIPES, PLAIDS OR PATTERNS WITH REPEATS			
		2" - 14" REPEAT: ADD FABRIC	15" - 24" REPEAT: ADD FABRIC	25" - 27" REPEAT: ADD FABRIC	28" - 36" REPEAT: ADD FABRIC
54"	0%	10%	15%	20%	25%
50"	10%	20%	25%	30%	35%
48"	15%	25%	30%	35%	45%
45"	40%	50%	55%	60%	65%
36"	50%	60%	65%	70%	75%

We will be happy to supply yardage requirement quotes for large quantities of material where economies may be realized. Please contact Via Seating customer service for a requirement quote. Call **1-800-433-6614 (press 1 for customer service)** or by e-mailing **info@viaseating.com**.

STEPS FOR CALCULATING YOUR COM

STEP 1: TOTAL NUMBER OF YOUR MODELS

Set how many of an model you will order.

STEP 2: COM FOR YOUR MODEL

Find the COM yardage requirement for your model. This information is listed in the BASE MODEL table in each series. Also see COM/COL information by different seat size options, upholstered arms and seat/back multi-use additions on the series' pricing page.

STEP 3: DETERMINE WIDTH & REPEAT

Make adjustments to the yardage based on your textile's width & repeat. The width is the distance from one selvage edge to the other. The repeat is the length between the first and additional appearance of the same element within a design. Select your multiplier based on width and repeat using the "COM WIDTH & REPEAT TABLE". This amount needs to be added to the total yardage sent.

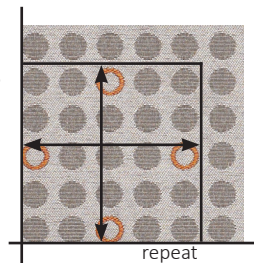

STEP 4: ROUND TOTAL YARDAGE

Round to the nearest half yard. This is the total amount of COM yardage that needs to be sent to Via Seating.

example of total yardage for an order

50 run II mesh mid back chairs
(model #971)

971 only has a seat COM of
1.0 yd per seat.

50 chairs x 1.0 yd = 50.0 yd

width is 54"
repeat is 15"
multiplier is 15%

50 yd + (50 yd x 15%) = 57.5 yd

57.5 yd total will need to be shipped
to cover the seats on 50 run II mesh
mid back chairs (#971)

COM/COL custom upholstery form

This form is also required for all orders including customer's own material (COM) and customer's own leather (COL). One form is required for each COM/COL (ie. custom upholstery).

All COM/COL received must be clearly marked, containing customer's name and purchase order number (PO#). COM/COL must be shipped to **ATTN: FABRIC DEPARTMENT, 205 Vista Blvd, Sparks, NV 89434.**

date	
------	--

CUSTOMER CONTACT INFO

dealer		account number	
address		city/state/zip	
dealer contact		phone number	
e-mail address			

ORDER INFO

PO #		seating model #	
textile pattern		textile colorway	
textile mill		total COM or COL sent	

TEXTILE DETAILS

Is there a desired top & bottom to the application of your textile? (circle one)	yes no	Is your textile a stripe or two-color plaid? (circle one)	yes no	Is there a pattern or repeat? (circle one)	yes no
--	----------	---	----------	--	----------

DIRECTION OF TEXTILE

We want to ensure that your textile lays correctly on the chair. Please indicate the direction of application below:

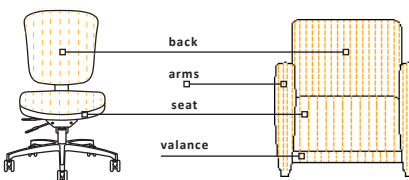
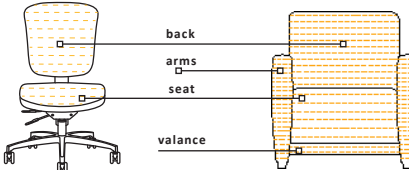
<p>check one direction for all that apply:</p> <p><input type="checkbox"/> textile non-directional (no nap/pattern is flippable)</p> <p>back (ottoman sides): <input type="checkbox"/> vertical or non-railroaded <input type="checkbox"/> horizontal or railroaded</p> <p>seat (ottoman top): <input type="checkbox"/> vertical or non-railroaded <input type="checkbox"/> horizontal or railroaded</p> <p>arms: <input type="checkbox"/> vertical or non-railroaded <input type="checkbox"/> horizontal or railroaded</p> <p>valance: <input type="checkbox"/> vertical or non-railroaded <input type="checkbox"/> horizontal or railroaded</p> <p>vertical "non-railroaded" "up the roll"</p>  <p>horizontal "railroaded"</p> 	<p>Please attach an example of your textile here, including a large enough example if there is a pattern or a repeat. Please include a high-res .JPG or similar if e-mailing this form, indicating the top & bottom of the textile of the image.</p>	<p style="text-align: center;">top</p> <hr/> <p style="text-align: center;">bottom</p>
--	--	--

Please find details online at www.viaseating.com/materials/COM. For help, please contact our customer service team at 1-800-433-6614 (press 1 for customer service).

Important note: you will receive an acknowledgment by e-mail upon receipt of your COM/COL textile(s). Any leftover COM/COL material will be recycled after 90 days from when your order ships.

custom logo request

Via Seating offers multiple solutions for displaying a customer's logo on Via Seating chairs. Please use this form for requesting custom logos in embroidery, vinyl printing or mesh printing. Send this form, an .EPS or .SVG file of the logo at 300 dpi or greater and a list of each PMS color for each thread required to info@viaseating.com subject "logo application request". There will be a set-up charge to create a digitized file at an extended lead time. Via Seating cannot confirm all custom application of all logos will work on all seating solutions without first testing the model, location and application type.

Note, logos are trademarked material. Via Seating will not obtain permission to use any copyrighted logos. Before Via Seating, will work with custom logos on our product, you must first obtain express permission of the holder for use of the copyrighted or trademarked logo.

date	
------	--

CUSTOMER CONTACT INFO

dealer		account number	
address		city/state/zip	
dealer contact		phone number	
e-mail address			

ORDER INFO

PO #		seating model #	
textile pattern		textile colorway	
textile mill			
Is this for a bid?	yes no	Do you need a sample before going to production?	yes no

TYPE

application (circle one)	embroidery vinyl printing mesh printing
--------------------------	---

LOGO PLACEMENT INFORMATION

We want to ensure that your logo is placed correctly on the chair. Please indicate the direction of application below:

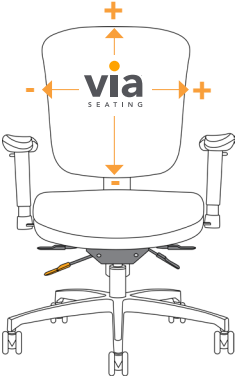
<p>check all that apply: placement on chair: <input type="checkbox"/> front of chair <input type="checkbox"/> back of chair vertical offset from center of chair (must be at least 1 inch from top/bottom) horizontal offset from center of chair (must be at least 1 inch from sides)</p>  <p>front of chair fill in + or - for each:</p> <table border="1"> <tr> <td>vertical</td> <td>+</td> <td></td> <td>-</td> <td></td> </tr> <tr> <td>horizontal</td> <td>+</td> <td></td> <td>-</td> <td></td> </tr> </table> <p>back of chair fill in + or - for each:</p> <table border="1"> <tr> <td>vertical</td> <td>+</td> <td></td> <td>-</td> <td></td> </tr> <tr> <td>horizontal</td> <td>+</td> <td></td> <td>-</td> <td></td> </tr> </table>	vertical	+		-		horizontal	+		-		vertical	+		-		horizontal	+		-		<p>Please attach an example of the logo/graphic here or include an example in a .EPS or .SVG form to info@viaseating.com, subject "custom embroidery request".</p>	<p>top</p> <hr/>
	vertical	+		-																		
horizontal	+		-																			
vertical	+		-																			
horizontal	+		-																			
	<hr/> <p>bottom</p>																					

For help, please contact our customer service team at 1-800-433-6614 (press 1 for customer service).



proprietary foam technology

Via Seating chairs use closed-cell, cold-cured foam that is injection-molded into strategically contoured seat molds—owned by Via Seating. This proprietary process maximizes on lasting comfort, durability and ergonomic support. Via Seating foam is fully covered under the 12 year warranty.

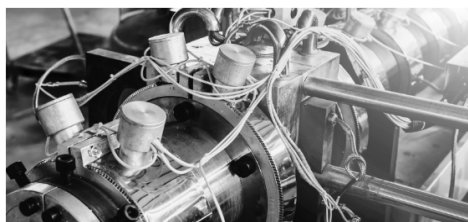

injection-molded foam

Via Seating foam is sculpted to provide body balance technology built directly in the cushioning of the seat and back. It is injected into an engineered mold at controlled, differing rates, which creates strategic, multi-density levels within each cushion. This process builds a subtle seat contour that maximizes support exactly where it is needed—where body weight is most concentrated. The outer edges by contrast, are made softer and in a waterfall slope so that the seat does not restrict circulation where the legs extend out over the edge of the seat.



closed-cell cold-cured technology

Closed-Cell refers to the fact that the foam has a smooth outer skin that is kind to fabric. It does not rasp on the upholstery from the inside. The foam does not absorb moisture. It protects the foam over time and does not break down. The comfort of Via Seating foam has the same comfort 12 years later.

Cold-Cured refers to the consistency in size of the air cells within the foam. The foam is one single, contoured and resilient piece of foam. It is not layered foam.



expertly tested & durable

Via Seating uses a resistance factor test and measurement of density to assess the durability and quality of its foam.

Density/volume weight gives an indication of the foam's ability to resist weight and not "bottom out". Good foam must provide resistance in direct proportion to the amount of pressure applied. This unit of measurement does not necessarily translate into hardness but rather the feeling of support you receive when you sit on the foam.

Via Seating foam has an average density or volume of **3 pounds per cubic foot** (48 kg/m³). Standard flat foam, by comparison, has a single volume weight between 1.9-2.25 pounds per cubic foot (30 to 40 kg/m³). The greater density of Via Seating foam makes it best-suited for office ergonomic seating.

Does not include AERIS motion seating products.

seat size selection guide

This reference chart helps select seat size cushions for task, conference, executive & management seating series. Height and weight are key indicators of suitable seat choice. The B-size seat cushion is designed to fit a broad range of individuals, especially when a seat slide for seat depth adjustment is being used.

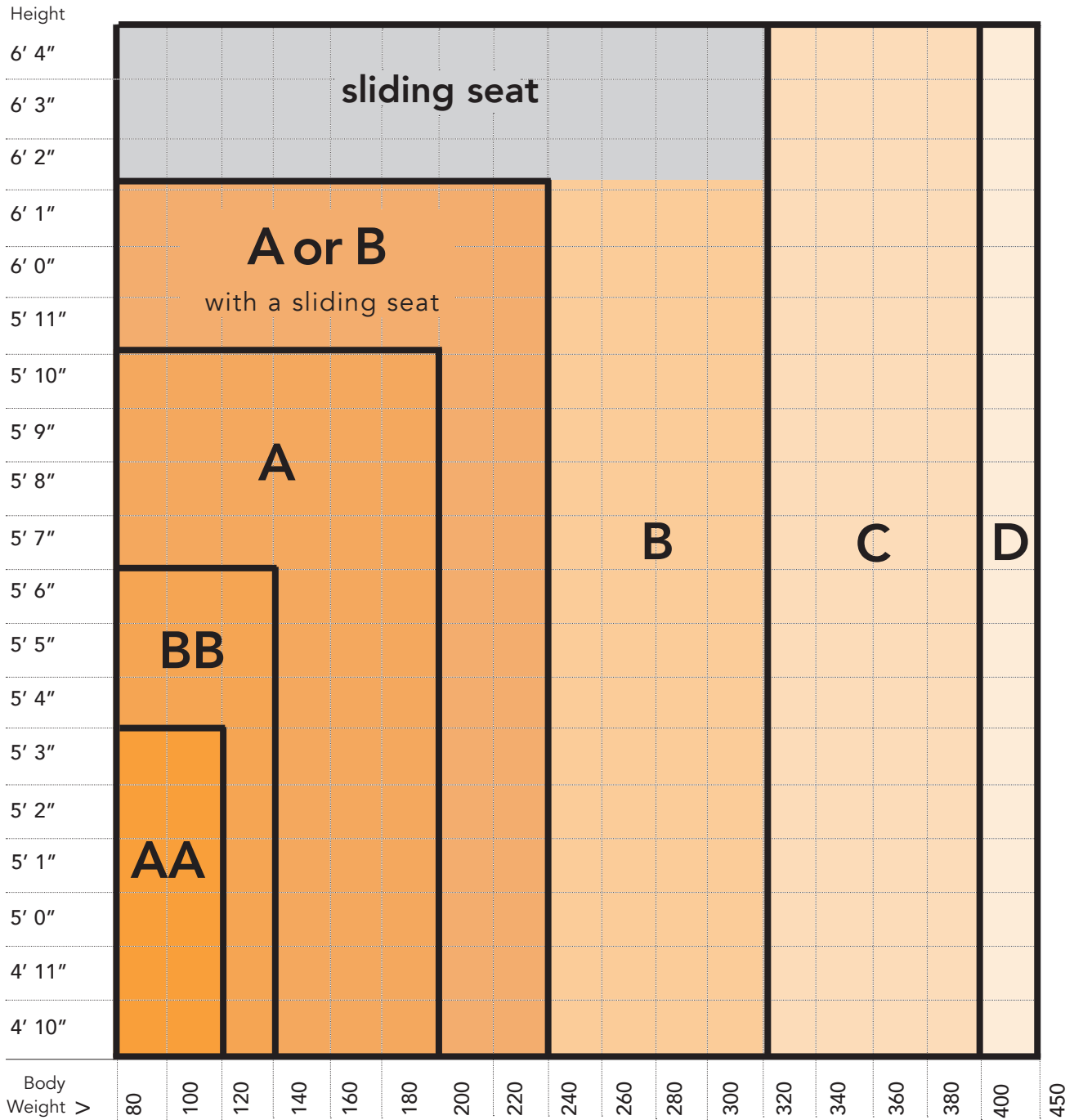

For assistance with selection, please contact:

Via Seating CUSTOMER SERVICE

1-800-433-6614









fixed arms (part 1 of 2)

0A: a note on armless seating models





Unless otherwise indicated as containing a fixed, integrated arm, all Via Seating chairs start as armless models. Armless chairs and swivel-caster stools have many benefits. Armless versions of chairs are the least expensive, save on space and allow for greater ease of movement in and out of the chair. Armless models on task-work, conference, Via Seating's execu-task and management seating solutions, however, do not provide the most ergonomic sitting experience. To improve comfortability and user support for long-term sitting and task work, see arm options available on each task-work, conference, Via Seating's execu-task and management series.

Motion seating solutions (Muvman® & Swopper®) were designed with patented and highly tested, supportive technology that provides an ergonomic, task-applicable, armless sitting experience.

OPEN & CANTILEVER ARMS

PART #	IMAGE	DETAILS	OFFERED ON SERIES	PART #	IMAGE	DETAILS	OFFERED ON SERIES
2A		Black polyurethane classic open arm.	Dyce & Linate.	4A		Black polyurethane classic open arm with a fully upholstered pad.	Dyce & Linate.
13A		Black polyurethane classic cantilever arm.	Linate & Oslo.	14A		Fully upholstered classic cantilever arm with a polyurethane interior.	Linate & Oslo.
80A		Black polyurethane executive "C" shape arm.	Carmel, Dyce, Linate, Oslo & Voss.	90A		Fully upholstered executive "C" shape arm with a polyurethane interior.	Carmel, Dyce, Linate, Oslo & Voss.
96A		Black polyurethane contemporary cantilever arm.	Proform® & Vero.	97A		Polished aluminum contemporary cantilever arm with a black polyurethane cap.	Proform® & Vero.

LOOP ARMS

PART #	IMAGE	DETAILS	OFFERED ON SERIES	PART #	IMAGE	DETAILS	OFFERED ON SERIES
31A		Black polyurethane Run II loop arm.	Run II	54A		Polished aluminum fixed loop arm.	Proform® & Vero.
55A		Polished aluminum fixed loop arm with a black polyurethane cap.	Proform® & Vero.	59A		Black polyurethane fixed loop arm.	Proform® & Vero.
61A		Polished aluminum fixed loop arm with a fully upholstered polyurethane cap.	Proform® & Vero.				

fixed arms (part 2 of 2)







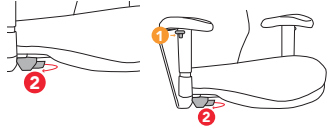
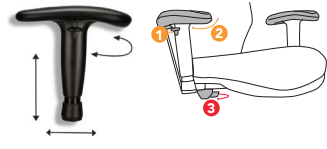
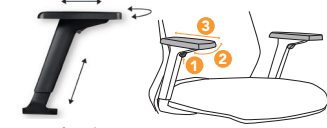
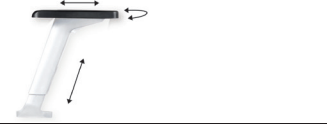

PANEL & WING ARMS

PART #	IMAGE	DETAILS	OFFERED ON SERIES	PART #	IMAGE	DETAILS	OFFERED ON SERIES
7A		Fully upholstered arm.	Linate.	12A		Fully upholstered wing arm.	Oslo.
17A		Fully upholstered traditional arm.	Oslo.	48A		Fully upholstered panel arm.	Vero.

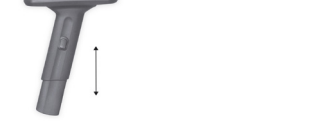
PART #	IMAGE	DETAILS	OFFERED ON SERIES
46A		Black polyurethane fixed conference arm with permanent, fixed cap.	4u, Genie® & GenieFlex.

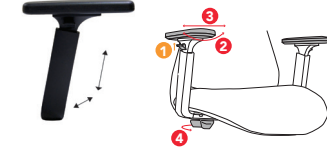
adjustable arms

Includes adjustable arm caps (ie. armrests) & adjustable arm width brackets.



PART #	DETAILS	CONTROL	INSTRUCTIONS	OFFERED ON SERIES
10A	Black nylon straight upright height adjustable arm.		<p>1 Arm height adjustment- While pressing the button located below the armrest, use your hand to raise and lower the arm height.</p> <p>2 Optional arm width adjustment (add -20AB)- Push the switch located beneath the arm forward. Use your hand to grasp the arm and adjust out to desired width away from seat. Each arm adjusts separately. When finished making adjustments, push the switch back to its original position.</p>	Brisbane, Proform® & Terra.
18A	Black nylon full function arm with arm width adjustment included.		<p>1 Arm height adjustment- While pressing the button located below the armrest, use your hand to raise and lower the arm height.</p> <p>2 Arm cap rotation- Grasp and lift arm cap to turn left or right, rotating a max of 15° each way.</p> <p>3 Included arm width adjustment (-20AB) - Push the switch located beneath the arm forward. Use your hand to grasp the arm and adjust out to desired width away from seat. Each arm adjusts separately. When finished making adjustments, push the switch back to its original position.</p>	Brisbane, Riva & Terra.
33A	Black nylon 4u arm with forward tilt and 6 way adjustment.		<p>1 Arm height adjustment- While pressing the button located below the armrest, use your hand to raise and lower the arm height.</p> <p>2 Arm cap rotation- Grasp and lift arm cap to turn left or right, rotating a max of 15° each way.</p>	Unique to 4u paired with a black frame.
35A	White nylon 4u arm with forward tilt and 6 way adjustment.		<p>3 Arm cap slide- Grasp and slide arm cap forward or backward, sliding forward a max of 2.5”.</p>	Unique to 4u paired with a white frame.
38A	Black nylon basic height adjustable arm.		<p>1 Arm height adjustment- While pressing the button located below the armrest, use your hand to raise and lower the arm height.</p> <p>2 Optional arm width adjustment (add -19AB)- Push the switch located beneath the arm forward. Use your hand to grasp the arm and adjust out to desired width away from seat. Each arm adjusts separately. When finished making adjustments, push the switch back to its original position.</p>	4u, Brisbane, Genie®, GenieFlex, Proform®, Riva, Run II, & Voss.
38AG	Magnet grey nylon basic height adjustable arm.			Unique to magnet grey frames as seen on GenieFlex & Run II.
39A	Black nylon height adjustable arm with roll back feature.		<p>1 Arm height adjustment- While pressing the button located below the armrest, use your hand to raise and lower the arm height.</p> <p>2 Roll back arm feature- while pressing and holding the small button toward the top front on the silver circle, grasp the arm and roll back to horizontal position. repeat to lift back to upright position.</p>	4u, Brisbane, Brisbane HD, Genie®, GenieFlex, Proform®, Run II, Terra & Voss.
51A	Black polyurethane arm with optional 8-way adjustments.		<p>1 Arm height adjustment- While pressing the button located below the armrest, use your hand to raise and lower the arm height.</p> <p>2 Optional arm cap rotation (add 18R & 20R)- Grasp arm cap and turn left or right to rotate a max of 15° each way.</p> <p>3 Optional arm cap slide (add 18R & 20R)- Grasp arm cap and slide forward or back (1.5”).</p>	Featured as the preferred, ergonomic, height adjustable arm for all task, conference & executive series.
51AG	Magnet grey polyurethane arm with optional 8-way adjustments.		<p>4 Optional arm width adjustment (add -19AB)- Push the switch located beneath the arm forward. Use your hand to grasp the arm and adjust out to desired width away from seat. Each arm adjusts separately. When finished making adjustments, push the switch back to its original position.</p>	Unique to magnet grey frames as seen on GenieFlex & Run II.
52A	White polyurethane arm with optional 8-way adjustments.		<p>Note: Static caps (18S & 18R) are standard with the 51A, 51AG, 52A & 53A. 4D adjustable caps (18R & 20R) are optional.</p>	Unique to white frames as seen on 4u & Genie®.
53A	Polished aluminum arm with optional 8-way adjustments.			Upgraded version of the preferred height adjustable arm.

arm caps for adjustable arms



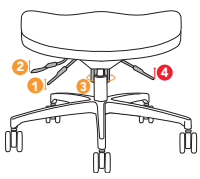
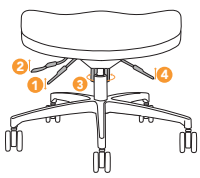

PART #	1	3	4	5	6	8	10	10G	12	18S	18R	20S	20R
STATIC?	✓	✓	✓	✓	✓	✓	✓	✓	✓	✓		✓	
FRONT/BACK											✓		✓
ROTATING											✓		✓
OPTIONAL UPHOLSTERY												✓	✓
DIMENSIONS													
LENGTH	9.5"	9.8"	10.5"	10.6"	9.3"	12.5"	9.2"	9.2"	9.3"	10.3"	10.3"	9.9"	9.9"
WIDTH	3.2"	3.0"	4.1"	4.1"	3.0"	3.25"	3.8"	3.8"	3.1"	3.5"	3.5"	3.7"	3.7"
CAP IS USABLE ON HEIGHT ADJUSTABLE ARMS:													
10A	✓	✓	✓	✓	✓	✓			✓				
18A	✓	✓	✓	✓	✓	✓			✓				
38A	✓	✓	✓	✓	✓	✓	✓		✓				
38AG	✓	✓	✓	✓	✓	✓	✓	✓					
39A	✓	✓	✓	✓	✓				✓				
51A										✓	✓	✓	✓
51AG										✓	✓	✓	✓
52A										✓	✓	✓	✓
53A										✓	✓	✓	✓
STANDARD ARM CAP BY SERIES & APPLICABLE ARM:													
4u						38A, 39A							51A, 52A, 53A
Brisbane				10A, 18A, 39A									51A, 53A
Brisbane HD				39A									51A, 53A
Carmel													51A, 53A
Dyce													51A, 53A
Genie®	38A, 39A											51A, 52A, 53A	
GenieFlex	38A, 39A											51A, 52A, 53A	
Linate													51A, 53A
Oslo													51A, 53A
Proform®										10A, 38A, 39A			51A, 53A
Riva			18A, 38A, 39A										51A, 53A
Run II					39A		38A	38AG					51A, 51AG, 53A
Terra		10A, 18A, 39A											51A, 53A
Vero													51A, 53A
Voss						38A, 39A							51A, 53A

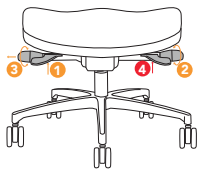
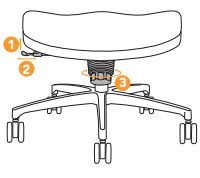
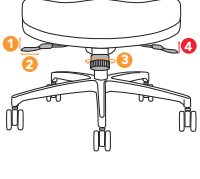

control mechanisms (part 1 of 2)

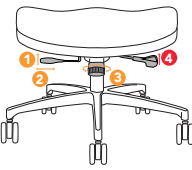
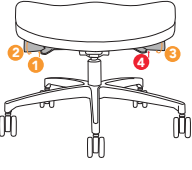
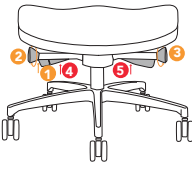
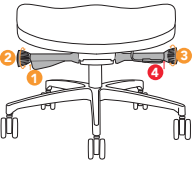
PART #	DETAILS	CONTROL	INSTRUCTIONS	OFFERED ON SERIES
3C	Active back control. -12SS With seat slide.		<ol style="list-style-type: none"> 1 Seat height adjustment- Adjust the seat height by lifting your weight out of the chair and pulling up on the paddle. Proper seat height is realized when the top of your legs are somewhat parallel to the floor. 2 Back lock adjustment (5 position)- Pull lever upward and shift your weight forward or back to desired angle. Release lever to lock. To free float the back, pull lever upward until locked. 3 Back/recline tension adjustment- Rotate knob right to increase tilt tension. Rotate knob left to decrease tilt tension. 4 Optional seat slider (add -12SS)- Pull up on paddle while shifting your weight forward to move your seat forward or backward to move your seat back. 	Brisbane & Terra.
5C	Advanced ergo control. -12SS With seat slide.		<ol style="list-style-type: none"> 1 Seat height adjustment- Adjust the seat height by lifting your weight out of the chair and pulling up on the paddle. Proper seat height is realized when the top of your legs are somewhat parallel to the floor. 2 Back lock adjustment (5 position)- Pull lever upward and shift your weight forward or back to desired angle. Release lever to lock. To free float the back, pull lever upward until locked. 3 Back/recline tension adjustment- Rotate knob right to increase tilt tension. Rotate knob left to decrease tilt tension. 4 Back tilt adjustment- Adjusts from 6° forward to 3° back. Pull lever upward to lock. Shift your weight forward or backward to desired weight angle. Release lever to lock. To free float the seat, pull lever upward until locked. 5 Optional seat slider (add -12SS)- Pull up on paddle while shifting your weight forward to move your seat forward or backward to move your seat back. 	Brisbane & Terra.
6C	Bio-sync ergo control. -12SS With seat slide.		<ol style="list-style-type: none"> 1 Seat height adjustment- Adjust the seat height by lifting your weight out of the chair and pulling up on the paddle. Proper seat height is realized when the top of your legs are somewhat parallel to the floor. 2 Back lock adjustment (6 position)- Pull lever upward and shift your weight forward or back to desired angle. Release lever to lock. To free float the back, pull lever upward until locked. 3 Back/recline tension adjustment- Rotate knob right to increase tilt tension. Rotate knob left to decrease tilt tension. 4 Optional seat slider (add -12SS)- Pull up on paddle while shifting your weight forward to move your seat forward or backward to move your seat back. 	Brisbane & Terra.
9CH 10CH	Synchro with side tension adjustment and a heavy-duty spring. 10CH With seat slide.		<ol style="list-style-type: none"> 1 Seat height adjustment- Adjust the seat height by lifting your weight out of the chair and pulling up on the paddle. Proper seat height is realized when the top of your legs are somewhat parallel to the floor. 2 Back lock adjustment (5 position)- Tilt the seat back to desired angle and twist a quarter turn. To unlock, twist the other way and lean back. 3 Back/recline tension adjustment- Pull paddle knob out. Turn right to tighten or left to loosen the back tension. 4 Optional seat slider (use control -10CH)- Pull up on paddle while shifting your weight forward to move your seat forward or backward to move your seat back. 	High backs in series Carmel, Linatè, Oslo & Voss.
11C	Single position knee-tilt control for single shells. Note: Seat and back tilt as a unit.		<ol style="list-style-type: none"> 1 Seat height adjustment- Adjust the seat height by lifting your weight out of the chair and pulling up on the paddle. Proper seat height is realized when the top of your legs are somewhat parallel to the floor. 2 Back lock adjustment (single position)- Use the same paddle as you use for the seat height adjustment. To lock the chair in an upright position, shift your weight forward until the chair is in an upright position, then push lever in. To rock (free float) shift your weight forward and pull the lever out. 3 Back/recline tension adjustment- Rotate knob clockwise to increase tilt tension. Rotate knob counter clockwise to decrease tilt tension. 	Carmel, Dyce, & Linatè.
12C 13C	Single position knee-tilt control for split shells. 13C With seat slide. Note: Seat and back tilt as a unit.		<ol style="list-style-type: none"> 1 Seat height adjustment- Adjust the seat height by lifting your weight out of the chair and pulling up on the paddle. Proper seat height is realized when the top of your legs are somewhat parallel to the floor. 2 Back lock adjustment (single position)- Use the same paddle you used for the seat height adjustment. To lock the chair in an upright position, shift your weight forward until the chair is in an upright position, then push lever in. To rock (free float) shift your weight forward and pull the lever out. 3 Back/recline tension adjustment- Rotate knob right to increase tilt tension. Rotate knob left to decrease tilt tension. 4 Optional seat slider (use control -13C)- Pull up on paddle while shifting your weight forward to move your seat forward or backward to move your seat back. 	Oslo mid backs & Voss.

control mechanisms (part 2 of 2)

PART #	DETAILS	CONTROL	INSTRUCTIONS	OFFERED ON SERIES
25C 26C	Swivel tilt conference control. 26C With seat slide. Note: Seat and back tilt as a unit.		<p>1 Seat height adjustment- Adjust the seat height by lifting your weight out of the chair and pulling up on the paddle. Proper seat height is realized when the top of your legs are somewhat parallel to the floor.</p> <p>2 Back lock adjustment (single position)- Use the same paddle you used for the seat height adjustment. To lock the chair in an upright position, shift your weight forward until the chair is in an upright position, then push lever in. To rock (free float) shift your weight forward and pull the lever out.</p> <p>3 Back/recline tension adjustment- Rotate knob right to increase tilt tension. Rotate knob left to decrease tilt tension.</p> <p>4 Optional seat slider (use control -26C)- Pull up on paddle while shifting your weight forward to move your seat forward or backward to move your seat back.</p>	Genie®, GenieFlex, Proform® & Riva.
64C 65C	Synchro with side tension adjustment. 65C With seat slide. Note: Seat and back move in a 2:1 ratio.		<p>1 Seat height adjustment- Adjust the seat height by lifting your weight out of the chair and pulling up on the paddle. Proper seat height is realized when the top of your legs are somewhat parallel to the floor.</p> <p>2 Back tension adjustment- Rotate knob right to increase tilt tension. Rotate knob left to decrease tilt tension.</p> <p>3 Back tilt lock adjustment (3 position)- Rotate knob right to lock in position. Rotate knob left to unlock and free float. Use own back tension to push against back of chair and release back from chair to find desired position.</p> <p>4 Optional seat slider (use control -65C)- Pull up on paddle while shifting your weight forward to move your seat forward or backward to move your seat back.</p>	Run II.
67C	Quick adjust advanced synchro control featuring single rotation adjustments. 67CSS With seat slide. 67CSS-FT With ergonomic forward tilt adjustment.		<p>1 Seat height adjustment- Adjust the seat height by lifting your weight out of the chair and pulling up on the paddle. Proper seat height is realized when the top of your legs are somewhat parallel to the floor.</p> <p>2 Back tension adjustment- Rotate knob right to increase tilt tension. Rotate knob left to decrease tilt tension.</p> <p>3 Single rotation back tilt lock adjustment (5 position)- Tilt the seat back to desired angle and twist slightly. To unlock, twist the other way, leaning back to unlock. The turn is smooth. All tilt lock angles can be reached within a single turn of the handle.</p> <p>4 Optional seat slider (add SS)- Push down on the paddle while shifting your weight forward to move your seat forward. Shift backward to move your seat back.</p> <p>5 Optional forward tilt adjustment (add -FT)- Push the paddle in the down position and lean back in the chair. You will hear a click when the forward tilt mechanism has turned on. Sit in your normal position to use the forward tilt feature. To turn off the forward tilt feature, push the paddle in the up position and lean back in the chair. You will hear a click when the forward tilt mechanism has turned off.</p> <p>Note: When the chair is in the 2 most forward positions of the back tilt lock, the forward tilt adjustment cannot be engaged. To engage/turn on the forward tilt adjustment and switch the back tilt lock adjustment to the neutral position.</p>	4u, Brisbane HD, Carmel mid back, Genie®, GenieFlex, Proform®, Riva, Oslo mid back, Vero & Voss mid backs.
68C	Enhanced body balance control with dynamic fine-tuning. -12SS With seat slide. Note: Seat & back move at a 3:1 ratio.		<p>1 Seat height adjustment- Adjust the seat height by lifting your weight out of the chair and pulling up on the paddle. Proper seat height is realized when the top of your legs are somewhat parallel to the floor.</p> <p>2 Single rotation back tilt lock adjustment (5 position)- Tilt the seat back to desired angle and twist slightly. To unlock, twist the other way, leaning back to unlock.</p> <p>3 Back/recline tension adjustment- Rotate knob right to increase tilt tension. Rotate knob left to decrease tilt tension.</p> <p>4 Optional seat slider (add -12SS)- Pull up on paddle while shifting your weight forward to move your seat forward or backward to move your seat back.</p>	4u, Genie®, GenieFlex, Proform® & Vero.
74C	Auto-adjust body balance control. -12SS With seat slider.		<p>1 Seat height adjustment- Adjust the seat height by lifting your weight out of the chair and pulling up on the paddle. Proper seat height is realized when the top of your legs are somewhat parallel to the floor.</p> <p>2 Back lock adjustment (3 position)- Use the same paddle as you use for the seat height adjustment. To lock the chair in an upright position, shift your weight forward until the chair is in an upright position, then push the button in. To rock (free float) shift your weight forward and push the button again.</p> <p>3 Optional seat slider (add -12SS)- Pull up on paddle while shifting your weight forward to move your seat forward or backward to move your seat back.</p>	4u, Genie®, GenieFlex, Proform® & Vero.

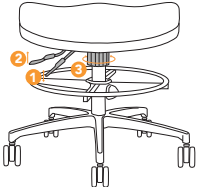
stool control mechanisms

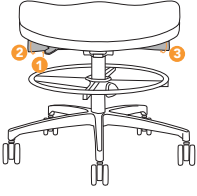

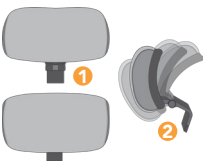
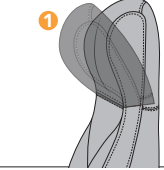
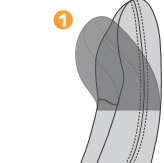

PART #	DETAILS	CONTROL	INSTRUCTIONS	OFFERED ON SERIES
3C	Active back control for stools. -11DR Stool kit. -11XDR Extra-tall stool kit.		<p>1 Seat height adjustment - Adjust the seat height by lifting your weight out of the chair and pulling up on the paddle. Proper seat height is realized when the top of your legs are somewhat parallel to the floor.</p> <p>2 Back lock adjustment (5 position) - Pull lever upward and shift your weight forward or back to desired angle. Release lever to lock. To free float the back, pull lever upward until locked.</p> <p>3 back/recline tension adjustment - Rotate knob right to increase tilt tension. Rotate knob left to decrease tilt tension.</p>	Brisbane, Brisbane HD & Terra.
35C	Auto-adjust body balance control for stools. -11DR Stool kit. -11XDR Extra-tall stool kit.		<p>1 Seat height adjustment - Adjust the seat height by lifting your weight out of the chair and pulling up on the paddle. Proper seat height is realized when the top of your legs are somewhat parallel to the floor.</p> <p>2 Back lock adjustment (single position) - Use the same paddle as you use for the seat height adjustment. To lock the chair in an upright position, shift your weight forward until the chair is in an upright position, then push the button in. To rock (free float) shift your weight forward and push the button again.</p>	4u, Genie®, GenieFlex, Proform® & Riva.
64CS	Synchro control with side tension adjustment for stools. -11DR Stool kit. -11XDR Extra-tall stool kit. note: Seat and back move in a 2:1 ratio.		<p>1 Seat height adjustment - Adjust the seat height by lifting your weight out of the chair and pulling up on the paddle. Proper seat height is realized when the top of your legs are somewhat parallel to the floor.</p> <p>2 Back tension adjustment - Rotate knob right to increase tilt tension. Rotate knob left to decrease tilt tension.</p> <p>3 Back tilt lock adjustment (3 position) - Rotate knob right to lock in position. Rotate knob left to unlock and free float. Use own back tension to push against back of chair and release back from chair to find desired position.</p>	Run II, all seat sizes.

adjustable headrests

PART #	DETAILS	HEADREST	INSTRUCTIONS	OFFERED ON SERIES
HDR1	Intuitive articulating, height adjustable headrest. This is optional.		<p>1 Height adjustment - Grasp the headrest on both sides and lift or lower it. The headrest has 2.5" of height adjustment from the starting position. This allows the headrest to be correctly positioned for differently sized individuals.</p> <p>2 Angle adjustment - Grasp the headrest on both sides and adjust forward or back to your desired position. The headrest tilts 5° forward & 40° back from the starting, upright position.</p>	Brisbane mid backs & Brisbane HD mid backs.
	Intuitive articulating headrest. This is integrated.		<p>1 Position adjustment - Grasp the headrest on both sides and adjust forward or back to your desired position. The headrest tilts 35° from the starting, upright position.</p>	Oslo high backs.
	Intuitive articulating headrest. This is integrated.		<p>1 Position adjustment - Grasp the headrest on both sides and adjust forward or back to your desired position. The headrest tilts 30° from the starting, upright position.</p>	Voss high backs.

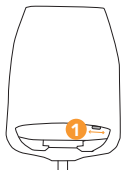
adjustable lumbar supports

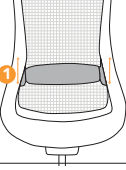
Explore Via Seating's ergonomic, adjustable lumbar support options below. These adjustable lumbar supports provide various levels of adjustments aimed at optimizing support and promoting better posture throughout the day. Adjustable lumbar supports are available on task-work, conference, execu-task and management series. Many Via Seating chairs have neutral spine support engineered into the architecture of the back itself. The adjustable lumbar support options extend the range of this support to accommodate a variety of differently sized individuals.

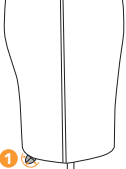
PART #	DETAILS	ADJUSTABLE LUMBAR	INSTRUCTIONS	OFFERED ON SERIES
LS4B LS4W	Optional 4u mesh & groove adjustable lumbar support. -LS4B Black finish. -LS4W White finish.		1 Lumbar position adjustment- From the seated position, use a hand to make adjustments by engaging the small, black lumbar adjustment lever. Slide the lever up to move the lumbar support up. Slide the lever down to move the adjustable lumbar support down. slide up = lumbar up slide down = lumbar down	4u mesh backs & groove backs.
	4u integrated adjustable lumbar support.		1 Lumbar depth adjustment- From the seated position, use your right hand to make adjustments by engaging the small, black lumbar adjustment bar. Slide the small bar to the left to move the adjustable lumbar support up. Slide the small bar to the right to move the adjustable lumbar support down. The travel range is 2.5". slide left = more lumbar support slide right = less lumbar support	4u upholstered backs.
12LUM	Optional mechanical lumbar support.		1 Lumbar depth adjustment- Turn the knob clockwise (forward toward front of chair) to increase lumbar support, pushing the lumbar cushion forward into the back. Turn the knob counter-clockwise (backward toward back of chair) to decrease lumbar support, moving the lumbar cushion away from the back. This adjustment is made from a seated position. clockwise = more lumbar support counter-clockwise = less lumbar support	Brisbane, Brisbane HD, Carmel, Linate, Riva upholstered backs & Terra.
LS1	Genie® optional adjustable lumbar support.		1 Lumbar position adjustment- From a seated position, reach behind to the back and grasp the tabs on either side of the lumbar. Squeeze and lift the lumbar support up or down. lift up = lumbar up lift down = lumbar down	Genie®.
LR2 LR2G	Run II optional adjustable lumbar support.		1 lumbar position adjustment- From the seated position, use a hand to make adjustments by engaging the small, black lumbar adjustment lever. Slide the lever up to move the lumbar support up. Slide the lever down to move the adjustable lumbar support down. slide up = lumbar up slide down = lumbar down	Run II.
13AIR	Voss optional adjustable lumbar support.		1 lumbar depth adjustment- From the seated position, grasp air ball located at base of back. Tighten valve and pump with hand to increase lumbar support. Release valve to reduce lumbar support. Tighten & pump = increase lumbar support release pump = reduce lumbar support	Voss.

gas lifts/cylinders

STARTING POSITION	Shown in black.
FULLY EXTENDED	Shown in grey.



PART #	G1	G2	G3A	G4	G5	G6
DETAILS	Shortest chair lift.	Standard lift for soft seating with swivel bases.	Standard lift for task, conference & executive.	Tallest chair lift.	Stool lift (11DR).	Extra-tall stool lift (11XDR).
WORKS WITH BASE	13BB, 18BB, 18GB, 18WB, 18PB & 18BA.	13BB, 18BB, 18GB, 18WB, 18PB & 18BA.	13BB, 18BB, 18GB, 18WB, 18PB & 18BA.	13BB, 18BB, 18GB, 18WB, 18PB & 18BA.	18BB, 18GB, 18WB, 18PB & 18BA.	18BB, 18GB, 18WB, 18PB & 18BA.
NOTES	Cannot be used with 3C, 5C & 6C. Works with all other controls.	Cannot be used with 3C, 5C & 6C. Works with all other controls.	Works with all controls.	Works with all controls.	Only works with 3C, 35C & 64CS. Does not work with bases 13BB.	Only works with 3C, 35C & 64CS. Does not work with bases 13BB.
RANGE OF TRAVEL	2.6"	2.9"	4.8"	5.5"	7.0"	9.5"

GASLIFTS WORK ON THE FOLLOWING SERIES (NOTE: STANDARD LIFT FOR CHAIRS IS SHOWN WITH A STAR ★ SYMBOL.)

4u	✓	✓	★	✓	✓	✓
Brisbane			★	✓	✓	✓
Brisbane HD	✓	✓	★	✓	✓	✓
Carmel	✓	✓	★	✓		
Comet	✓	★				
Dyce	✓	✓	★	✓		
Eclipse	✓	✓	★	✓	✓	✓
Edge	✓	★				
Genie®	✓	✓	★	✓	✓	✓
GenieFlex	✓	✓	★	✓	✓	✓
Linate	✓	✓	★	✓		
Onda	✓	✓	★	✓	✓	✓
Orbit	✓	★				
Oslo	✓	✓	★	✓		
Proform®	✓	✓	★	✓	✓	✓
Reset	✓	✓	★	✓	✓	✓
Riva	✓	✓	★	✓	✓	✓
Run II	✓	✓	★	✓	✓	✓
Spec Stools	✓	✓	★	✓	✓	✓
Splash	✓	✓	★	✓	✓	✓
Sutro	✓	✓	★	✓	✓	✓
Terra			★	✓	✓	✓
Vero	✓	✓	★	✓	✓	✓
Voss	✓	✓	★	✓		
Zee	✓	✓	★	✓	✓	✓

A Note on seat heights.

- Seat heights differ between configurations. These heights are impacted by framework, controls, seat wood, foam, casters/glides & other factors. See each series page online under the drawings section to find seat height dimensions true to specific model configurations.
- Jury base **20JRY** & hands-free Spec Stool **1401** use unique gaslifts not included on this chart. Lounge gas lifts are not included on this chart.

5-star swivel bases

These bases are used across multiple series for the following applications: task, task stool, light task, light task stool, conference, executive and management seating. Each base is designed to work with both casters and glides options. On select series and where noted below, these bases are used for heavy-duty, 24/7 use & multi-shift use.



PART #	18BB	18PB	18BA	18GB	18WB	13BB
DETAILS	Black polyurethane base.	Polished aluminum base.	Brushed aluminum base.	Magnet grey polyurethane base.	White polyurethane base.	Black high-crown polyurethane base.
WORKS WITH STOOL KIT	11DR & 11XDR.	11DR & 11XDR.	11DR & 11XDR.	11DR & 11XDR.	11DR & 11XDR.	None.
WORKS WITH CASTERS/GLIDES	16HP, 16HP-SL1, 16SCG, 16SCG-SL1 & 16GL.	16HP, 16HP-SL1, 16SCG, 16SCG-SL1 & 16GL.	16HP, 16HP-SL1, 16SCG, 16SCG-SL1 & 16GL.	16HP, 16HP-SL1, 16SCG, 16SCG-SL1 & 16GL.	16HP, 16HP-SL1, 16SCG, 16SCG-SL1 & 16GL.	16HP, 16HP-SL1, 16SCG, 16SCG-SL1 & 16GL.
HEAVY-DUTY	✓	✓	✓	✓	✓	
24/7 MULTI-SHIFT	✓	✓	✓	✓	✓	
RANGE OF TRAVEL	See gaslifts. Note, exact height ranges are determined by a combination of factors including framework, controls, seat wood, foam & other factors.					

BASES WORK ON THE FOLLOWING SERIES (NOTE: STANDARD BASE FOR CHAIRS IS SHOWN WITH A STAR ★ SYMBOL.)

4u	★ (black frame)	✓	✓		★ (white frame)	
Brisbane	★	✓	✓			
Brisbane HD	★	✓	✓			
Carmel	★	✓	✓			
Comet	★	✓	✓			
Dyce	★	✓	✓			
Eclipse	★	✓	✓			
Edge	★	✓	✓			
Genie®	★ (black frame)	✓	✓		★ (white frame)	
GenieFlex	★ (black frame)	✓	✓	★ (grey frame)		
Linate	★	✓	✓			
Orbit	★	✓	✓			
Onda	★	✓	✓			
Oslo	★	✓	✓			
Proform®	★	✓	✓			
Reset	★ (black frame)	✓	✓	★ (grey frame)		does not work
Riva	★	✓	✓			
Run II	★ (black frame)	✓	✓	★ (grey frame)		
Spec Stools	✓	✓	✓			★ (model 1416)
Splash	✓	✓	✓			★
Sutro	✓	✓	✓			★
Terra	★	✓	✓			
Vero	★	✓	✓			
Voss	★	✓	✓			
Zee	✓	✓	✓			★

customer service you'll fall in love with

Have a question? Need support? We are happy to help! Look below to find your dedicated support and call or email us now. Or explore our online resources here: <https://viaseating.com/customer-service/>

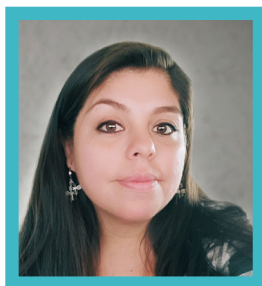
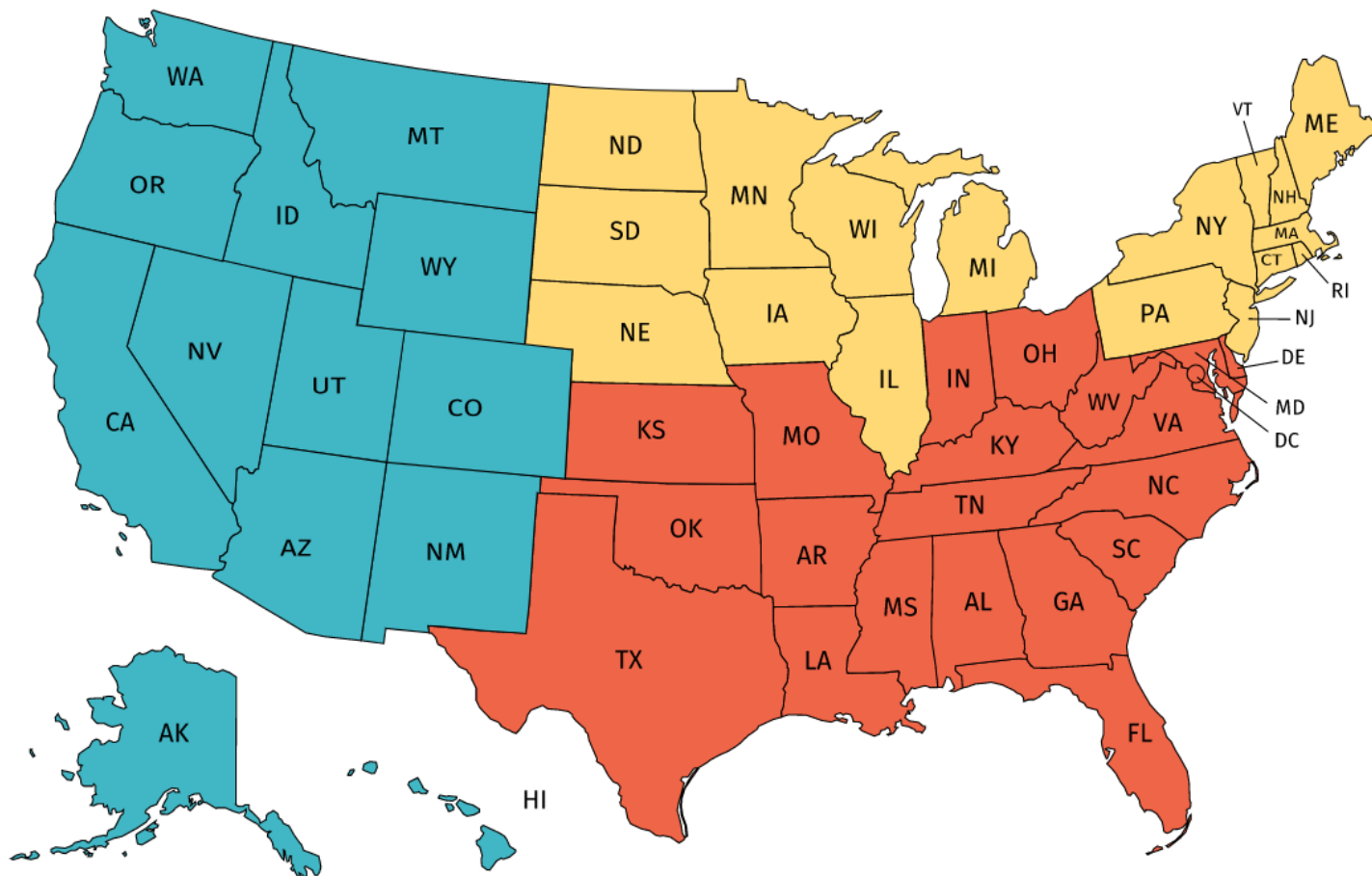

Nicole Bice
Customer Service Specialist
Western U.S., Mexico,
South America
775.398.3306
CSWest@viaseating.com



Ashley Wright
Customer Service Specialist
Southern U.S., Canada
775.398.3328
CSSouth@viaseating.com



Amanda Kamachi
Customer Service Specialist
Northern U.S., Canada
775.398.3327
CSNorth@viaseating.com

Order entry & details: orders@viaseating.com

Warranty: warranty@viaseating.com | <https://viaseating.com/warranty/>



featured image: 780-W-35C-11DR-35A0-18BA-16SCG-03U-GR 1 (MOMENTUM HUE CURRANT)

features

Breadth of Line: available as a mid back chair or task stool with mesh, upholstery or groove fabric.

Mesh Back: 4-way elastomeric stretch mesh in monochromatic solid colors or Via Seating’s exclusive biocidal, self-sanitizing copper striped mesh. Offered with optional adjustable lumbar.

Upholstered Back: sleek upholstered back version with integrated, adjustable lumbar.

Groove Back: provides an incredibly comfortable hybrid between mesh and upholstered back.

Seats: offering two distinct seat styles—original slim line design with seat pan and new extra comfort seat with extra height in the cushioning of the seat.

Arms: multiple height and width adjustable options and a fixed, conference arm.

Control Mechanisms: controls include latest quick adjust advanced synchro (no endless turning of the handle to adjust your backrest to your level of comfort) with choice of an optional 2.5” seat depth adjustment & an optional +3° forward tilt adjustment & body balance technology.

Via Seating’s comfort foam: a proprietary blend of high-density, injection-molded, closed-cell, cold-cured foam so durable and lasting it is backed by Via Seating’s 12 year warranty.

SPEC IT! ONLINE CHAIR BUILDER
Yes.
QUICK SHIP MANUFACTURING TIME
10-15 chairs/48 hours.
HIGHEST WEIGHT CAPACITY
400 lb.
WARRANTY
12 years, 5 years for mesh.
BIFMA LEVEL
Yes, LEVEL 2.
HEALTHIER HOSPITALS INITIATIVE (HHI)
Yes.
MINDFUL MATERIALS
Yes.
GSA (CONTRACT #: GS-28F-005CA)
Yes, SIN# 711-18.



design by S.I. Design

In 1996 Lorenzo founded S.I. Design in Pádova, Italy with designers Emanuele Bertolini and Mauro Naletto. S.I. specializes in furniture design, particularly for offices and communal spaces. Today, their team of eight focuses on design and technical assistance in product development utilizing advanced modeling programs.



LOWEST PRICED MODEL: \$622













GSA SIN #: 711-16 | MANUFACTURED IN U.S.A.

QUICK SHIP SCHEDULES

Code is listed in the starting model. Deviations from this are listed where they occur.

CODE	# MADE	DETAILS
15	15/48	15 Chairs manufactured in 48 hours.
10	10/48	10 Chairs manufactured in 48 hours.
📞	CALL	FOR LEAD TIME: 1-800-433-6614

1. CHOOSE YOUR STARTING LIST BASE MODEL.

SEAT TYPE		Original slim line style seat.		Enhanced comfort style seat.	
BACK TYPE ↓	SEAT SIZE →	Medium seat.	Large seat.	Medium seat.	Large seat.
Mesh back.	PART #	15 780	15 781	15 782	15 783
	STARTING LIST PRICE	\$622	\$705	\$659	\$793
	IMAGE				
	STARTING MODEL #	780-B-74C-0A-18BB-16HP-01U-GR A	781-B-74C-0A-18BB-16HP-01U-GR A	782-B-74C-0A-18BB-16HP-01U-GR A	783-B-74C-0A-18BB-16HP-01U-GR A
	COM COL SEAT	0.75 yd 6 sq ft	0.75 yd 6 sq ft	1 yd 8.4 sq ft	1 yd 9 sq ft
Groove back.	PART #	15 785	15 786	15 787	15 788
	STARTING LIST PRICE	\$664	\$747	\$701	\$835
	IMAGE				
	STARTING MODEL #	785-B-74C-0A-18BB-16HP-01UG-GR A	786-B-74C-0A-18BB-16HP-01UG-GR A	787-B-74C-0A-18BB-16HP-01UG-GR A	788-B-74C-0A-18BB-16HP-01UG-GR A
	COM COL SEAT	0.75 yd 6 sq ft	0.75 yd 6 sq ft	1 yd 8.4 sq ft	1 yd 9 sq ft
Upholstered back.	PART #	10 770	10 771	10 772	10 773
	STARTING LIST PRICE	\$745	\$829	\$749	\$916
	IMAGE				
	STARTING MODEL #	770-B-74C-0A-18BB-16HP-GR A	771-B-74C-0A-18BB-16HP-GR A	772-B-74C-0A-18BB-16HP-GR A	773-B-74C-0A-18BB-16HP-GR A
	COM COL SEAT	0.75 yd 6 sq ft	0.75 yd 6 sq ft	1 yd 8.4 sq ft	1 yd 9 sq ft
	COM COL BACK	0.77 yd 6.5 sq ft	0.77 yd 6.5 sq ft	0.77 yd 6.5 sq ft	0.77 yd 6.5 sq ft
	COM COL CHAIR	1.75 yd 13 sq ft	1.75 yd 13 sq ft	1.75 yd 13 sq ft	1.75 yd 13 sq ft

2. CHOOSE YOUR FRAME COLOR.

PART#	-B			-W		
PRICE	+\$0			+\$55		
IMAGE						
AS SEEN ON BACK TYPE	Mesh back.	Groove back.	Upholstered back.	Mesh back.	Groove back.	Upholstered back.
DETAILS	Standard Black.			White.		

FIND MORE OPTIONS ON THE FOLLOWING PAGE. →

2. CHOOSE YOUR CONTROL MECHANISM.

DO YOU WANT A CHAIR? SELECT YOUR CONTROL.

2a. ADD SEAT SLIDE?

2b. ADD FORWARD TILT?

USE ON	USE WITH	PART#	PRICE	DETAILS	GASLIFT	PART #	PRICE	DETAILS	PART #	PRICE	DETAILS	MAX WEIGHT
Chairs.	All seats.	-74C	+\$0	Auto-adjust body balance control.	G3A: 4.8" travel.	-12SS	+\$91	Slide the seat +2" forward.	n/a	n/a	n/a	300 lb. on slim line seats.
	All seats.	-67C	+\$4	Quick adjust advanced synchro control featuring single rotation adjustments.	G3A: 4.8" travel.	n/a	n/a	n/a	n/a	n/a	400 lb. on enhanced comfort seats.	
	All seats.	-67CSS	+\$95	Quick adjust advanced synchro control featuring single rotation adjustments with a seat slide.	G3A: 4.8" travel.		+\$0	Included. Slide the seat +2.5" forward.	-FT	+\$42		+3° of a forward tilt.
	All seats.	-68C	+\$127	Enhanced body balance control with dynamic fine-tuning.	G3A: 4.8" travel.	-12SS	+\$91	Slide the seat +2" forward.	n/a	n/a	n/a	300 lb.
NOTE	Discontinuing options 61C, 62C & 66C are best replaced by the latest ergonomic technology 67C, 67CSS & 74C, respectively. More details pg. 180.											

DO YOU WANT A STOOL? SELECT YOUR CONTROL AND HEIGHT RANGE.

USE ON	USE WITH	PART#	PRICE	DETAILS	GASLIFT	MAX WEIGHT
Stools.	Medium seats.	-35C-11DR	+\$220	Auto-adjust body balance control for stools.	G5: 7.0" travel.	300 lb.
		-35C-11XDR	+\$220	Adds a polished foot ring and extended gas lift with stool height ranges. Available on all bases.	G6: 9.5" travel.	300 lb.



4. CHOOSE YOUR ARM TYPE.

DO YOU WANT AN ARMLESS CHAIR?

















PART#	PRICE	IMAGE	DETAILS
-0A	+\$0		Armless chairs are standard.

DO YOU WANT TO ADD AN ADJUSTABLE ARM?

4a. CHOOSE YOUR ARM CAP.



4b. ADD AN UPHOLSTERED CAP?

4c. ADD ADJUSTABLE WIDTH?

PART#	PRICE	IMAGE	DETAILS	PART #	PRICE	IMAGE	DETAILS	PART#	PRICE	PART#	PRICE	DETAILS
-33A	+\$127		Black nylon 4u arm with forward tilt and 6 way adjustment.		+\$0		Black nylon permanent 4D rotating cap.	n/a	n/a	n/a	n/a	n/a
-35A	+\$178		White nylon 4u arm with forward tilt and 6 way adjustment.		+\$0		Black nylon permanent 4D rotating cap.	n/a	n/a	n/a	n/a	n/a
-38A	+\$55		Black nylon basic height adjustable arm.	6	+\$0		Standard fixed cap.	n/a	n/a	-19AB	+\$33	Brackets can adjust the width between arms by 2" per side.
-39A	+\$111		Black nylon height adjustable arm with roll back feature.	6	+\$0		Standard fixed cap.	n/a	n/a	n/a	n/a	
-51A	+\$89		Black polyurethane arm with optional 8-way adjustments.	20S	+\$0		Standard fixed cap.	U	+\$ your textile grade price found in step 9.	-19AB	+\$33	Brackets can adjust the width between arms by 2" per side.
				20R	+\$42		4D rotating cap.					
-52A	+\$116		White polyurethane arm with optional 8-way adjustments.	20S	+\$0		Standard fixed cap.					
				20R	+\$42		4D rotating cap.					
-53A	+\$150		Polished aluminum arm with optional 8-way adjustments.	20S	+\$0		Standard fixed cap.					
				20R	+\$42		4D rotating cap.					





DO YOU WANT TO ADD A FIXED ARM?

4a. CHOOSE YOUR ARM CAP.



PART#	PRICE	IMAGE	DETAILS	PART#	PRICE	IMAGE	DETAILS
-46A	+\$84		Black polyurethane fixed conference arm with fixed cap.		+\$0		Black polyurethane permanent fixed cap.

FIND MORE OPTIONS ON THE FOLLOWING PAGE. →

5. CHOOSE YOUR 5-STAR SWIVEL BASE.





PART#	PRICE	IMAGE	DETAILS
-18BB	+\$0		Black nylon base. Standard with black frames.
-18WB	+\$0		White nylon base. Standard with white frames.
-18PB	+\$114		Polished aluminum base.
-18BA	+\$114		Brushed aluminum base.

5a. CHOOSE YOUR CASTERS OR GLIDES.

USE WITH	PART#	PRICE	IMAGE	DETAILS	PART#	PRICE	DETAILS
All bases.	-16HP	+\$0		Standard black finish casters are for use on soft/carpeted floors.	-SL1	+\$29	This feature locks the casters only when you are not sitting in the chair.
All bases.	-16SCG	+\$29		Grey finish casters are for use on both hard floors & soft/carpeted floors.	-SL2	+\$29	
All bases.	-16GL	+\$29		Black finish glides are for use on all floor types.	n/a	n/a	n/a

5b. ADD SAFETY-BRAKE CASTERS?

6. DO YOU WANT TO ADD ADJUSTABLE LUMBAR SUPPORT?

PART#	-LS4B			-LS4W		
PRICE	+\$66			+\$66		
IMAGE			Adjustable lumbar at NO UPCHARGE is integrated into 4u upholstered backs.			Adjustable lumbar at NO UPCHARGE is integrated into 4u upholstered backs.
ON BACK TYPE	Mesh back.	Groove back.	Upholstered.	Mesh back.	Groove back.	Upholstered.
DETAILS	Black. Option with black frames.			White. Option with white frames.		

7. CHOOSE YOUR MESH COLOR.

USE ON	PART#	-01U	-02U	-03U	-13U	-14U
 Mesh back chairs.	PRICE	+\$0	+\$0	+\$0	+\$139	+\$139
	IMAGE				 NEW!	 NEW!
	DETAILS	Standard black.	Stardust.	Graphite.	Copper Striped.	Black Copper Striped.

8. CHOOSE YOUR GROOVE COLOR.

USE ON	PART#	-01UG	-02UG	-03UG	-04UG	-05UG	-06UG	-07UG
 Groove back chairs.	PRICE	+\$0	+\$0	+\$0	+\$0	+\$0	+\$0	+\$0
	IMAGE							
	DETAILS	Standard black.	Dark grey.	Light grey.	Taupe.	Red.	Blue.	Green.

9. ADD YOUR TEXTILE GRADE(S).

PART #	PRICE (DEPENDS ON FABRIC GRADE SELECTED)										DETAILS
	A	B	1/COM	2	3/COL	4	5	6	7	8	
All chairs.	+\$0	+\$13	+\$42	+\$60	+\$90	+\$121	+\$156	+\$195	+\$238	+\$284	All chairs.
U	+\$31	+\$31	+\$31	+\$31	+\$31	+\$31	+\$63	+\$63	+\$63	+\$63	Upholstered caps on arms 51A, 52A & 53A .
NOTE	Must include mill, pattern and colorway listed after your grade choice in your model #. For COM/COL see pg. 18. We are happy to supply yardage requirement quotes for large quantity chair orders, as material economies may be realized. Please call 1-800-433-6614 or email your customer service manager for assistance.										

9a. DO YOU WANT TWO-TONE UPHOLSTERY? IF YES, PLEASE LIST YOUR TEXTILES IN THIS ORDER:

UPHOLSTERY LAYOUT	USE WITH	ORDER	DETAILS TO ADD TO YOUR MODEL #	IMPORTANT NOTES
	All chairs.	1	SEAT (MILL PATTERN COLORWAY)	Seat textile will be applied to a selected 20SU or 20RU upholstered arm caps.
	Upholstered back chairs.	2	BACK (MILL PATTERN COLORWAY)	Back textile will be applied to backrest.

FIND A QUOTING GUIDE ON THE FOLLOWING PAGE. →

BUILD YOUR MODEL

STEP #	INSTRUCTIONS	PART #	LIST PRICE
1	STARTING LIST BASE MODEL.		
2	CONTROL OPTION.		
2a	SEAT SLIDE OPTION.		
2b	FORWARD TILT OPTION.		
3	FRAME COLOR.		
4	ARM OPTION.		
4a	ARM CAP OPTION.		
4b	UPHOLSTERED CAP OPTION.		
4c	ADJUSTABLE ARM WIDTH BRACKET OPTION.		
5	BASE OPTION.		
5a	CASTER/GLIDE OPTION.		
5b	SAFETY-BRAKE CASTER OPTION.		
6	MESH & GROOVE BACKS: ADJUSTABLE LUMBAR OPTION.		
7	MESH BACKS: MESH COLOR.		
8	GROOVE BACKS: GROOVE COLOR.		
UPHOLSTERY OPTION: CHOOSE 9 OR 9a, CHOOSING HIGHEST GRADE FOR LIST PRICE.			
9	SINGLE TEXTILE STANDARD: ADD GRADE, THEN ADD: - (MILL PATTERN COLORWAY)		
	UPHOLSTERED BACKS: TWO-TONE UPHOLSTERY OPTION: ADD GRADE, THEN ADD: - SEAT (MILL PATTERN COLORWAY) - BACK (MILL PATTERN COLORWAY)		
PACKAGING:			
10	STANDARD SHIPPING: CHAIRS SHIP 95% ASSEMBLED. NO TOOLS REQUIRED.		
	CHAIRS SHIP FULLY ASSEMBLED OPTION (ADD PART # -FA AND LIST PRICE \$80/CHAIR).		
	BLANKET WRAPPED OPTION: MINIMUM ORDER OF 150, ADD PART # -BW AND CALL FOR LIST PRICING 1-800-433-6614.		
FINAL MODEL NUMBER & TOTAL LIST:			

OR SPEC IT THE EASY WAY

via Design your perfect chair on our online builder: Spec It!
SPEC IT! <http://www.viaseating.com/specit>



specified model #:

780-W-35C-11DR-35A0-18BA-16SCG-03U-GR 1
(MOMENTUM HUE CURRANT)

FAQ

1. Can the **33A**, **35A** & the **46A** arms take different caps?

No, these arm caps (ie. arm rests) are permanent. The **33A** & **35A** has a 4D rotating cap, custom to those arms. The **46A** has a fixed cap.

2. Can the forward tilt feature on the **67CSS** go on the **67C**?

No. The **67CSS-FT** is Via Seating's latest full function ergonomic control option delivering both a 3° forward tilt and a 2.5" seat slide.

DIMENSIONS & FINISHES

Dimensions and finishes can be found online. Studio V, Via Seating's engineering design team, continuously updates and works with its partners to update Via Seating products to the latest industry advances and to customer feedback. Dimensions, finishes & resources are made available online to allow for real-time updates with the most current data.



QR CODE

Find 4u information at viaseating.com/series/4u-chairs or scan the QR code to the right →

Astro

solutions: motion-lounge, lounge, collaborative, lobby, executive guest



featured image: 930-72C-33BLK-SR-GR 7 (MAHARAM COLLINE 108)

features

Breadth of Line: soft seating chair and ottomans (Chico & Luna, pg. 99).

Designer Shape: high profile back for privacy and support, with a cradling sit.

Upholstery: option to upholster the seat and back in two different textiles.

Control Mechanisms: choices include motion-lounge rock (back-and-forth rocking movement), sway (side-to-side swaying movement) & 360 degree swivel.

Bases: gorgeous polished or black matte 4-leg base signature to the Astro series.

Via Seating's comfort foam: a proprietary blend of high-density, injection-molded, closed-cell, cold-cured foam so durable and lasting it is backed by Via Seating's 12 year warranty.

SPEC IT! ONLINE CHAIR BUILDER
Yes.
QUICK SHIP MANUFACTURING TIME
2 chairs/48 hours.
HIGHEST WEIGHT CAPACITY
300 lb.
WARRANTY
6 years.
BIFMA LEVEL
Yes, LEVEL 2.
HEALTHIER HOSPITALS INITIATIVE (HHI)
Yes.
MINDFUL MATERIALS
Yes.
GSA (CONTRACT #: GS-28F-005CA)
Yes, SIN# 711-16.



design by Studio V

Studio V creates modern, sophisticated and original seating solutions that are ergonomic, beautiful and sustainable. This team of engineers, sustainability experts and designers is based in Reno, Nevada. Studio V develops products using a prototyping lab, the latest in 3D modeling software and a materials testing center.



LOWEST PRICED MODEL: \$1,515

GSA SIN #: 711-16 | MANUFACTURED IN U.S.A.

QUICK SHIP SCHEDULES

Code is listed in the starting model. Deviations from this are listed where they occur.

CODE	# MADE	DETAILS
2	2/48	2 Chairs manufactured in 48 hours.
☎	CALL	FOR LEAD TIME: 1-800-433-6614

1. CHOOSE YOUR STARTING LIST BASE MODEL.

PART #	2 930
STARTING LIST PRICE	\$1,515
IMAGE	
STARTING MODEL #	930-69C-33POL-SO-GR A
COM COL SEAT ONLY	1.25 yd 12 sq ft
COM COL BACK ONLY	2.75 yd 48 sq ft
COM COL WHOLE CHAIR	3.5 yd 60 sq ft

2. DO YOU WANT A FIXED SEAT?

PART #	☎ -FXD
PRICE	+\$157
DETAILS	The standard seat is a clean out and removable velcro-attached seat. Upcharge is for a permanent, fixed seat.

3. CHOOSE YOUR CONTROL MECHANISM ("MOTION-LOUNGE EXPERIENCE").

USE WITH	PART#	PRICE	DETAILS	MAX WEIGHT
All bases.	-69C	+\$0	360 degree swivel.	300 lb.
	-70C	+\$157	Rocking with 360 degree swivel.	300 lb.
	-72C	+\$314	Rocking & swaying with 360 degree swivel.	300 lb.

4. CHOOSE YOUR LOUNGE BASE WITH FIXED HEIGHT.

PART#	PRICE	IMAGE	DETAILS	MATERIAL
-33POL	+\$0		Astro's signature 4-leg fixed-height base with a polished finish.	Aluminum.
-33BLK	+\$0		Astro's signature 4-leg fixed-height base with a powder-coated matte black finish.	Aluminum.

4a. LOUNGE BASES: CHOOSE YOUR GAS LIFT FUNCTIONALITY.

PART#	PRICE	DETAILS	NOTE
-SO	+\$0	Non return-to-center.	Cylinder color matches base finish.
-SR	+\$26	Return-to-center.	
-SF	+\$26	Fixed (no swivel).	

5. DO YOU WANT TO ADD EMPHASIZED STITCH?

PART #	-CTS
PRICE	+\$0
IMAGE SHOWING CONTRASTING STITCH LINES BOLDED	
NOTE	Standard thread color is a tonal match to the textile(s) selected.

5a. CHOOSE YOUR EMPHASIZED STITCH THREAD COLOR.

PART#	-03	-05	-04	-06	-07	-09	-08	-10
PRICE	+\$0	+\$0	+\$0	+\$0	+\$0	+\$0	+\$0	+\$0
IMAGE								
DETAILS	Black thread.	Grey thread.	White thread.	Cream thread.	Chocolate thread.	Blue thread.	Red thread.	Yellow thread.

6. ADD YOUR TEXTILE GRADE(S).

PART #	PRICE (DEPENDS ON FABRIC GRADE SELECTED)										DETAILS
	A	B	1/COM	2	3/COL	4	5	6	7	8	
930	+\$0	+\$101	+\$210	+\$362	+\$525	+\$701	+\$939	+\$1203	+\$1635	+\$2134	Astro chair.
NOTE	Must include mill, pattern and colorway listed after your grade choice in your model #. For COM/COL see pg. 18. We are happy to supply yardage requirement quotes for large quantity chair orders, as material economies may be realized. Please call 1-800-433-6614 or email your customer service manager for assistance.										

6a. DO YOU WANT TWO-TONE UPHOLSTERY? IF YES, PLEASE LIST YOUR TEXTILES IN THIS ORDER:

UPHOLSTERY LAYOUT	ORDER	DETAILS TO ADD TO YOUR MODEL #	IMPORTANT NOTES	PRICING NOTE
	1	SEAT (MILL PATTERN COLORWAY)	Includes seat.	Two-tone upholstery uses the highest grade of the two textiles.
	2	BACK (MILL PATTERN COLORWAY)	Includes front & back side of backrest or, in other words, all upholstered parts, but the seat.	

FIND A QUOTING GUIDE ON THE FOLLOWING PAGE. →

BUILD YOUR MODEL

STEP #	INSTRUCTIONS	PART #	LIST PRICE
1	STARTING LIST BASE MODEL.		
2	SEAT OPTION: REMOVABLE OR FIXED.		
3	CONTROL OPTION.		
4	BASE OPTION.		
4a	CYLINDER OPTION.		
5	EMPHASIZED STITCH OPTION.		
5a	EMPHASIZED STITCH THREAD COLOR.		
UPHOLSTERY OPTION: CHOOSE 5 OR 5a, CHOOSING HIGHEST GRADE FOR LIST PRICE.			
6	SINGLE TEXTILE STANDARD: ADD GRADE, THEN ADD: - (MILL PATTERN COLORWAY)		
	TWO-TONE UPHOLSTERY OPTION: ADD GRADE, THEN ADD: - SEAT (MILL PATTERN COLORWAY) - BACK (MILL PATTERN COLORWAY)		
PACKAGING:			
7	STANDARD SHIPPING: CHAIRS SHIP FULLY ASSEMBLED.		
FINAL MODEL NUMBER & TOTAL LIST:			

OR SPEC IT THE EASY WAY

via Design your perfect chair on our online builder: Spec It!
SPEC IT! <http://www.viaseating.com/specit>



specified model #: 930-72C-33BLK-SR-GR 7
(MAHARAM COLLINE 108)

FAQ

1. Can I apply my own thread color in the Emphasized Stitch program?

Yes. Please note, lead time on chairs with custom thread colors can take up to 6 weeks from time of order confirmation depending on the complexity and availability of the thread color specified. Conditions may apply. Please contact 1-800-433-6614 for more information.

2. Can I get a permanent, fixed seat?

Yes. Please see option 2.

3. What is the best way to maximize on my motion-lounge experience?

For maximum comfort, Via Seating recommends pairing the motion experience: rocking with 360 degree swivel (**70C**) and rocking & swaying with 360 degree swivel (**72C**) with a lounge ottoman. Find ottomans on **pg. 99**.

DIMENSIONS & FINISHES

Dimensions and finishes can be found online. Studio V, Via Seating's engineering design team, continuously updates and works with its partners to update Via Seating products to the latest industry advances and to customer feedback. Dimensions, finishes & resources are made available online to allow for real-time updates with the most current data.



QR CODE

Find Astro information at viaseating.com/series/astro-chair or scan the QR code to the right →

Brisbane

solutions: ergonomic task chair & stool



featured image: 2803-5C-18A5-18BB-16HP-12LUM-GR A (MOMENTUM ORIGIN IRON)

features

Breadth of Line: available as high, mid and low back chairs.

Seats: offering five seat sizes—petite to extra-large.

Ballistic Brisbane: featuring Ballistic Brisbane, which uses strategically placed ballistic nylon to protect chair against gun, safety and utility belts.

Arms: multiple height adjustable arms including an arm with a roll back feature.

Control Mechanisms: controls include active back and bio-sync options.

Bases: five-star swivel bases available in black nylon, polished aluminum and brushed aluminum.

Via Seating's comfort foam: a proprietary blend of high-density, injection-molded, closed-cell, cold-cured foam so durable and lasting it is backed by Via Seating's 12 year warranty.

SPEC IT! ONLINE CHAIR BUILDER
Yes.
QUICK SHIP MANUFACTURING TIME
15 chairs/48 hours.
MAX WEIGHT RANGE
350 lb.
WARRANTY
12 years including Ballistic Brisbane.
BIFMA LEVEL
Yes, LEVEL 2.
HEALTHIER HOSPITALS INITIATIVE (HHI)
Yes.
MINDFUL MATERIALS
Yes.
GSA (CONTRACT #: GS-28F-005CA)
Yes, SIN# 711-18.



design by Studio V

Studio V creates modern, sophisticated and original seating solutions that are ergonomic, beautiful and sustainable. This team of engineers, sustainability experts and designers is based in Reno, Nevada. Studio V develops products using a prototyping lab, the latest in 3D modeling software and a materials testing center.



Brisbane

LOWEST PRICED MODEL: \$761









GSA SIN #: 711-18 | MANUFACTURED IN U.S.A.

QUICK SHIP SCHEDULES

Code is listed in the starting model. Deviations from this are listed where they occur.

CODE	# MADE	DETAILS
15	15/48	15 chairs manufactured in 48 hours.
10	10/48	10 chairs manufactured in 48 hours.
📞	CALL	FOR LEAD TIME: 1-800-433-6614

1. CHOOSE YOUR STARTING LIST BASE MODEL.

BACK TYPE ↓	SEAT SIZE →	Standard A seat.	Medium B seat.	Large C seat.
Low back.	PART #	15 1801	15 2801	15 3001
	STARTING LIST PRICE	\$761	\$842	\$932
	IMAGE			
	STARTING MODEL #	1801-3C-0A-18BB-16HP-GR A	2801-3C-0A-18BB-16HP-GR A	3001-3C-0A-18BB-16HP-GR A
	COM COL CHAIR	0.75 yd 11.1 sq ft	0.75 yd 14.5 sq ft	1 yd 13.5 sq ft
Mid back.	PART #	15 1803	15 2803	15 3003
	STARTING LIST PRICE	\$811	\$892	\$982
	IMAGE			
	STARTING MODEL #	1803-3C-0A-18BB-16HP-GR A	2803-3C-0A-18BB-16HP-GR A	3003-3C-0A-18BB-16HP-GR A
	COM COL CHAIR	0.75 yd 12.9 sq ft	0.75 yd 14.5 sq ft	1 yd 15.6 sq ft
High back.	PART #	15 1805	15 2805	15 3005
	STARTING LIST PRICE	\$876	\$957	\$1,047
	IMAGE			
	STARTING MODEL #	1805-3C-0A-18BB-16HP-GR A	2805-3C-0A-18BB-16HP-GR A	3005-3C-0A-18BB-16HP-GR A
	COM COL CHAIR	1.5 yd 19 sq ft	1.5 yd 19.76 sq ft	1.75 yd 21 sq ft

2. DO YOU WANT TO ADD A PETITE SEAT (-1" DEPTH)?

SEAT SIZE	AA petite seat.	BB petite seat.	n/a
PART #	1PTT-	1PTT-	
PRICE	+\$69	+\$69	

3. CHOOSE YOUR CONTROL MECHANISM.

DO YOU WANT A CHAIR? SELECT YOUR CONTROL.

USE ON	USE WITH	PART#	PRICE	DETAILS	GASLIFT	PART #	PRICE	DETAILS	MAX WEIGHT
Chairs.	All seats.	-3C	+\$0	Active back control.	G3A: 4.8" travel.	-12SS	+\$91	Slide the seat +2" forward.	350 lb.
		-5C	+\$75	Advanced ergo control.	G3A: 4.8" travel.				300 lb.
		-6C	+\$101	Bio-sync ergo control.	G3A: 4.8" travel.				300 lb.

3a. ADD SEAT SLIDE?

DO YOU WANT A STOOL? SELECT YOUR CONTROL AND HEIGHT RANGE.

USE ON	USE WITH	PART#	PRICE	DETAILS	GASLIFT	MAX WEIGHT
Stools.	• Low & Mid backs with AA, A, BB & B seats.	-3C-11DR	+\$156	Active back control for stools.	G5: 7.0" travel.	300 lb.
		-3C-11XDR	+\$156	Adds a polished foot ring and extended gas lift with stool height ranges. Available on all bases.	G6: 9.5" travel.	300 lb.



FIND MORE OPTIONS ON THE FOLLOWING PAGE. →

4. CHOOSE YOUR ARM TYPE.















DO YOU WANT AN ARMLESS CHAIR?

PART#	PRICE	IMAGE	DETAILS
-0A	+\$0		Armless chairs are standard.

DO YOU WANT TO ADD AN ADJUSTABLE ARM?

4a. CHOOSE YOUR ARM CAP.







4b. ADD AN UPHOLSTERED CAP? 4c. ADD ADJUSTABLE WIDTH?

PART#	PRICE	IMAGE	DETAILS	PART#	PRICE	IMAGE	DETAILS	PART#	PRICE	PART#	PRICE	DETAILS
-10A	+\$89		Black nylon straight upright height adjustable arm.	5	+\$0		Standard fixed cap.	n/a	n/a	-20AB	+\$33	Brackets can adjust the width between arms by 2" per side. Included on 18A.
				6	+\$0		Preferred fixed cap.					
-18A	+\$121		Black nylon full function arm with arm width adjustment included.	5	+\$0		Standard fixed cap.	n/a	n/a	-20AB	+\$0	
				6	+\$0		Preferred fixed cap.					
-39A	+\$111		Black nylon height adjustable arm with roll back feature.	5	+\$0		Standard fixed cap.	n/a	n/a	n/a	n/a	n/a
				6	+\$0		Preferred fixed cap.					
-51A	+\$89		Black polyurethane arm with optional 8-way adjustments.	20S	+\$0		Standard fixed cap.	U	+\$ your textile grade price found in step 10.	-19AB	+\$33	Brackets can adjust the width between arms by 2" per side.
				20R	+\$42		4D rotating cap.					
-53A	+\$150		Polished aluminum arm with optional 8-way adjustments.	20S	+\$0		Standard fixed cap.					
				20R	+\$42		4D rotating cap.					

5. CHOOSE YOUR 5-STAR SWIVEL BASE.

5a. CHOOSE YOUR CASTERS OR GLIDES.

5b. ADD SAFETY-BRAKE CASTERS?



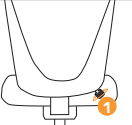

PART#	PRICE	IMAGE	DETAILS	PART#	PRICE	IMAGE	DETAILS	PART#	PRICE	DETAILS
-18BB	+\$0		Standard black nylon base.	-16HP	+\$0		Black finish casters are for use on soft/carpeted floors.	-SL1	+\$29	This feature locks the casters only when you are not sitting in the chair.
-18PB	+\$114		Polished aluminum base.	-16SCG	+\$29		Grey finish casters are for use on both hard floors & soft/carpeted floors.	-SL2	+\$29	
-18BA	+\$114		Brushed aluminum base.	-16GL	+\$29		Black finish glides are for use on all floor types.	n/a	n/a	

6. DO YOU WANT TO ADD AN ADJUSTABLE LUMBAR SUPPORT?

PART#	PRICE	IMAGE	DETAILS
-12LUM	+\$114		Mechanical, internal lumbar support, which is adjusted by turning a dial. Clockwise = more support Counter-clockwise = less support

7. DO YOU WANT TO ADD A HEADREST?

8. DO YOU WANT TO MAKE IT "BALLISTIC BRISBANE"?

USE WITH	PART#	PRICE	IMAGE	DETAILS	USE WITH	PART#	PRICE	IMAGE	DETAILS
 Mid backs only.	 .HDR1	+\$200 + Add grade price from step 10.		This optional headrest allows you to adjust the position vertically by 2.5" of travel and tilt it from 5° forward to 40° rearward.	 Mid backs only.	 -BALL1	GR 3		Ballistic Brisbane nylon protects your seat from safety, gun & utility belts. Pattern: half-moon nylon on back of seat, half-moon nylon on bottom of the back, nylon down sides of the back and seat. Available on mid backs.

9. DO YOU WANT TO ADD UPHOLSTERY TO THE BACK OF THE CHAIR (IE. "BACK SHELL")?

PART#	PRICE	IMAGE	DETAILS	NOTE
			Standard plastic backshell.	Upholstered shells match the overall chair upholstery by default.
	¹⁰ -22UBF		An upholstered backshell for fabrics & vinyls.	
	¹⁰ -22UBL		An upholstered backshell for leathers.	

FIND MORE OPTIONS & A QUOTING GUIDE ON THE FOLLOWING PAGE. →

10. ADD YOUR TEXTILE GRADE(S).

PART #	PRICE (DEPENDS ON FABRIC GRADE SELECTED)										DETAILS
	A	B	1/COM	2	3/COL	4	5	6	7	8	
1801 & 2801	+\$0	+\$15	+\$31	+\$66	+\$100	+\$115	+\$166	+\$202	+\$321	+\$491	Low back, A & B seats.
1803, 2803, 1805, 2805 & 3001	+\$0	+\$16	+\$33	+\$66	+\$102	+\$135	+\$186	+\$254	+\$389	+\$582	Low back, C seat; Mid back A & B seats; High back, A & B seats.
3003 & 3005	+\$0	+\$18	+\$36	+\$87	+\$121	+\$188	+\$252	+\$322	+\$511	+\$739	Mid back, C seat; High back C seat.
U	+\$31	+\$31	+\$31	+\$31	+\$31	+\$31	+\$63	+\$63	+\$63	+\$63	Upholstered caps on arms 51A, 52A & 53A .
HDR1	+\$0	+\$0	+\$0	+\$0	+\$0	+\$0	+\$31	+\$31	+\$31	+\$31	Headrest.
NOTE	Must include mill, pattern and colorway listed after your grade choice in your model #. For COM/COL see pg. 18. We are happy to supply yardage requirement quotes for large quantity chair orders, as material economies may be realized. Please call 1-800-433-6614 or email your customer service manager for assistance. For Heavy Duty (HD) & 24/7 use applicable textiles, please check with the mill/manufacturer.										

BUILD YOUR MODEL

STEP #	INSTRUCTIONS	PART #	LIST PRICE
1	STARTING LIST BASE MODEL.		
2	PETITE SEAT OPTION.		
3	CONTROL OPTION.		
3a	SEAT SLIDE OPTION.		
4	ARM OPTION.		
4a	ARM CAP OPTION.		
4b	UPHOLSTERED CAP OPTION.		
4c	ADJUSTABLE WIDTH BRACKET OPTION.		
5	BASE OPTION.		
5a	CASTER/GLIDE OPTION.		
5b	SAFETY-BRAKE CASTER OPTION.		
6	ADJUSTABLE LUMBAR OPTION.		
7	HEADREST OPTION.		
8	BALLISTIC BRISBANE OPTION.		
9	UPHOLSTERED BACKSHELL OPTION.		
UPHOLSTERY OPTION:			
10	SINGLE TEXTILE STANDARD: ADD GRADE, THEN ADD:		
	- (MILL PATTERN COLORWAY)		
PACKAGING:			
11	STANDARD SHIPPING: CHAIRS SHIP 95% ASSEMBLED. NO TOOLS REQUIRED.		
	CHAIRS SHIP FULLY ASSEMBLED OPTION (ADD PART # -FA AND LIST PRICE \$80/CHAIR).		
	BLANKET WRAPPED OPTION: MINIMUM ORDER OF 150, ADD PART # -BW AND CALL FOR LIST PRICING 1-800-433-6614.		
FINAL MODEL NUMBER & TOTAL LIST:			

OR SPEC IT THE EASY WAY

via Design your perfect chair on our online builder: Spec It!
SPEC IT! <http://www.viaseating.com/specit>



specified model #:
 2803-5C-18A5-18BB-16HP-12LUM-GR A
 (MOMENTUM ORIGIN IRON)

FAQ

1. Can I place a logo on my chair?

Yes, logos can be applied by embroidery on fabric, vinyl or leather. These logos must be placed at least 2" away from the edges of the seat, back and all stitch lines. Extended lead time on chairs with logos is 4-6 weeks. Please see pg. 20.

DIMENSIONS & FINISHES

Dimensions and finishes can be found online. Studio V, Via Seating's engineering design team, continuously updates and works with its partners to update Via Seating products to the latest industry advances and to customer feedback. Dimensions, finishes & resources are made available online to allow for real-time updates with the most current data.

Find Brisbane information at viaseating.com/series/brisbane-chairs or scan the QR code to the right →



QR CODE

Brisbane HD

solutions: ergonomic task chair & stool, conference, heavy-duty, 24/7, multi-shift



featured image: 1503-67CSS-39A5-18BB-16HP-HDR1-GR 1 (MOMENTUM HUE NIGHT)

features

Breadth of Line: available as high and mid backs.

Seats: offering six seat sizes—petite to extra-large—with a 450 lb weight rating on the extra-large (D) seat.

Ballistic Brisbane: featuring Ballistic Brisbane, which uses strategically placed ballistic nylon to protect chair against gun, safety and utility belts.

Arms: multiple height adjustable arms including an arm with a roll back feature.

Control Mechanisms: controls include latest quick adjust advanced synchro (no endless turning of the handle to adjust your backrest to your level of comfort) with choice of an optional 2.5" seat depth adjustment & an optional +3° forward tilt adjustment.

Bases: five-star swivel bases available in black nylon, polished aluminum and brushed aluminum.

Via Seating's comfort foam: a proprietary blend of high-density, injection-molded, closed-cell, cold-cured foam so durable and lasting it is backed by Via Seating's 12 year warranty.

SPEC IT! ONLINE CHAIR BUILDER
Yes.
QUICK SHIP MANUFACTURING TIME
15 chairs/48 hours.
MAX WEIGHT RANGE
450 lb.
WARRANTY
12 years including HD 24/7 chairs & Ballistic Brisbane.
BIFMA LEVEL
Yes, LEVEL 2.
HEALTHIER HOSPITALS INITIATIVE (HHI)
Yes.
MINDFUL MATERIALS
Yes.
GSA (CONTRACT #: GS-28F-005CA)
Yes, SIN# 711-18.



design by Studio V

Studio V creates modern, sophisticated and original seating solutions that are ergonomic, beautiful and sustainable. This team of engineers, sustainability experts and designers is based in Reno, Nevada. Studio V develops products using a prototyping lab, the latest in 3D modeling software and a materials testing center.



Brisbane HD

HEAVY DUTY (HD) 24/7 USE OPTIONS

Code is listed in the starting model to the right of the quick ship code.

CODE	DETAILS
	For use in 24/7 & HD applications.

QUICK SHIP SCHEDULES

Code is listed in the starting model. Deviations from this are listed where they occur.

CODE	# MADE	DETAILS
15/48	15 Chairs manufactured in 48 hours.	
10/48	10 Chairs manufactured in 48 hours.	
CALL	FOR LEAD TIME: 1-800-433-6614	

LOWEST PRICED MODEL: \$882

GSA SIN #: 711-18 | MANUFACTURED IN U.S.A.

1. CHOOSE YOUR STARTING LIST BASE MODEL. SELECT BASE SIZE & SEAT SIZE TO FIND YOUR MODEL #.

BACK TYPE	SEAT SIZE →	Standard A seat.	Medium B seat.	Large C seat.	Heavy-duty D seat.
Mid back.	PART #	1303	1503	1603	1703
	STARTING LIST PRICE	\$882	\$963	\$1,054	\$1,264
	IMAGE				
	STARTING MODEL #	1303-67C-0A-18BB-16HP-GR A	1503-67C-0A-18BB-16HP-GR A	1603-67C-0A-18BB-16HP-GR A	1703-67C-0A-18BB-16HP-GR A
	COM COL BACK	0.75 yd 6.43 sq ft	0.75 yd 6.43 sq ft	0.75 yd 6.43 sq ft	0.75 yd 6.43 sq ft
	COM COL SEAT	0.75 yd 5.88 sq ft	0.75 yd 8.4 sq ft	1 yd 9 sq ft	1 yd 9.5 sq ft
	COM COL CHAIR	0.75 yd 12.9 sq ft	0.75 yd 14.5 sq ft	1 yd 15.6 sq ft	1.25 yd 15.75 sq ft
	High back.	PART #	1305	1505	1605
STARTING LIST PRICE		\$948	\$1,029	\$1,120	\$1,330
IMAGE					
STARTING MODEL #		1305-67C-0A-18BB-16HP-GR A	1505-67C-0A-18BB-16HP-GR A	1605-67C-0A-18BB-16HP-GR A	1705-67C-0A-18BB-16HP-GR A
COM COL BACK		1.25 yd 15.5 sq ft	1.25 yd 15.5 sq ft	1.25 yd 15.5 sq ft	1.25 yd 15.5 sq ft
COM COL SEAT		0.75 yd 5.88 sq ft	0.75 yd 8.4 sq ft	1 yd 9 sq ft	1 yd 9.5 sq ft
COM COL CHAIR		1.5 yd 19 sq ft	1.5 yd 19.76 sq ft	1.75 yd 21 sq ft	1.75 yd 20.85 sq ft

2. DO YOU WANT TO ADD A PETITE SEAT (-1" DEPTH)?

SEAT SIZE	AA petite seat	BB petite seat	n/a	n/a
PART #	1PTT-	1PTT-		
PRICE	+\$69	+\$69		

3. CHOOSE YOUR CONTROL MECHANISM.

DO YOU WANT A CHAIR? SELECT YOUR CONTROL.

2a. ADD SEAT SLIDE?

2b. ADD FORWARD TILT?

USE ON	USE WITH	PART#	PRICE	DETAILS	GASLIFT	PART #	PRICE	DETAILS	PART #	PRICE	DETAILS	MAX WEIGHT
Chairs.	All seats.	-67C	+\$0	Quick adjust advanced synchro control featuring single rotation adjustments.	G3A: 4.8" travel.	n/a	n/a	n/a	n/a	n/a	n/a	350 lb. A/B seats. 400 lb. C seats. 450 lb. D seats.
		-67CSS	+\$91	Quick adjust advanced synchro control with seat depth adjustment.	G3A: 4.8" travel.		+\$0	Slide the seat +2.5" forward.	-FT	+\$42	+3° of a forward tilt.	
NOTE	Discontinuing options 61C & 62C are best replaced by the latest ergonomic technology 67C & 67CSS , respectively. More details pg. 180.											

DO YOU WANT A STOOL? SELECT YOUR CONTROL AND HEIGHT RANGE.

USE ON	USE WITH	PART#	PRICE	DETAILS	GASLIFT	MAX WEIGHT
Stools.	• Mid backs with AA, A, BB & B seats.	-3C-11DR	+\$156	Active back control for stools.	G5: 7.0" travel.	300 lb.
		-3C-11XDR	+\$156	Adds a polished foot ring and extended gas lift with stool height ranges. Available on all bases.	G6: 9.5" travel.	300 lb.

FIND MORE OPTIONS ON THE FOLLOWING PAGE. →

4. CHOOSE YOUR ARM TYPE.

→ DO YOU WANT AN ARMLESS CHAIR?

PART#	PRICE	IMAGE	DETAILS
-0A	+\$0		Armless chairs are standard.

→ DO YOU WANT TO ADD AN ADJUSTABLE ARM?

4a. CHOOSE YOUR ARM CAP.

4b. ADD AN UPHOLSTERED CAP?

4c. ADD ADJUSTABLE WIDTH?

PART#	PRICE	IMAGE	DETAILS	PART#	PRICE	IMAGE	DETAILS	PART#	PRICE	PART#	PRICE	DETAILS
-39A	+\$111		Black nylon height adjustable arm with roll back feature.	5	+\$0		Standard fixed cap.	n/a	n/a	n/a	n/a	n/a
				6	+\$0		Preferred fixed cap.					
-51A	+\$89		Black polyurethane arm with optional 8-way adjustments.	20S	+\$0		Standard fixed cap.	U	+\$ your textile grade price found in step 10.	-19AB	+\$33	Brackets can adjust the width between arms by 2" per side.
				20R	+\$42		4D rotating cap.					
-53A	+\$150		Polished aluminum arm with optional 8-way adjustments.	20S	+\$0		Standard fixed cap.					
				20R	+\$42		4D rotating cap.					

5. CHOOSE YOUR 5-STAR SWIVEL BASE.

5a. CHOOSE YOUR CASTERS OR GLIDES.

5b. ADD SAFETY-BRAKE CASTERS?

PART#	PRICE	IMAGE	DETAILS
-18BB	+\$0		Standard black nylon base.
-18PB	+\$114		Polished aluminum base.
-18BA	+\$114		Brushed aluminum base.

PART#	PRICE	IMAGE	DETAILS
-16HP	+\$0		Black finish casters are for use on soft/carpeted floors.
-16SCG	+\$29		Grey finish casters are for use on both hard floors & soft/carpeted floors.
-16GL	+\$29		Black finish glides are for use on all floor types.

PART#	PRICE	DETAILS
-SL1	+\$29	This feature locks the casters only when you are not sitting in the chair.
-SL2	+\$29	
n/a	n/a	

6. DO YOU WANT TO ADD AN ADJUSTABLE LUMBAR SUPPORT?

PART#	PRICE	IMAGE	DETAILS
-12LUM	+\$114		Mechanical, internal lumbar support, which is adjusted by turning a dial. Clockwise = more support Counter-clockwise = less support

7. DO YOU WANT TO ADD A HEADREST?

USE WITH	PART#	PRICE	IMAGE	DETAILS
	-HDR1	+\$200 + Add grade price from step 10.		This optional headrest allows you to adjust the position vertically by 2.5" of travel and tilt it from 5° forward to 40° rearward.

8. DO YOU WANT TO MAKE IT "BALLISTIC BRISBANE"?

USE WITH	PART#	PRICE	IMAGE	DETAILS
	-BALL1	GR 3		Ballistic Brisbane nylon protects your seat from safety, gun & utility belts. Pattern: half-moon nylon on back of seat, half-moon nylon on bottom of the back, nylon down sides of the back and seat. Available on mid backs.

9. DO YOU WANT TO ADD UPHOLSTERY TO THE BACK OF THE CHAIR (IE. "BACK SHELL")?

PART#	PRICE	IMAGE	DETAILS	NOTE
	+\$0		Standard plastic backshell.	Upholstered shells match the overall chair upholstery by default. See step 10a to specify a different textile or leather on the backshell.
-22UBF	+\$152		An upholstered backshell for fabrics & vinyls.	
-22UBL	+\$180		An upholstered backshell for leathers.	

FIND MORE OPTIONS & A QUOTING GUIDE ON THE FOLLOWING PAGE. →

10. ADD YOUR TEXTILE GRADE(S).

PART #	PRICE (DEPENDS ON FABRIC GRADE SELECTED)										DETAILS
	A	B	1/COM	2	3/COL	4	5	6	7	8	
1303, 1305, 1503 & 1505	+\$0	+\$19	+\$34	+\$69	+\$103	+\$137	+\$187	+\$255	+\$393	+\$591	A & B seat chairs.
1603, 1605, 1703 & 1705	+\$0	+\$19	+\$34	+\$86	+\$120	+\$187	+\$255	+\$322	+\$512	+\$739	C & D seat chairs.
U	+\$31	+\$31	+\$31	+\$31	+\$31	+\$31	+\$63	+\$63	+\$63	+\$63	Upholstered caps on arms 51A, 52A & 53A .
HDR1	+\$0	+\$0	+\$0	+\$0	+\$0	+\$0	+\$31	+\$31	+\$31	+\$31	Headrest.
NOTE	Must include mill, pattern and colorway listed after your grade choice in your model #. For COM/COL see pg. 18. We are happy to supply yardage requirement quotes for large quantity chair orders, as material economies may be realized. Please call 1-800-433-6614 or email your customer service manager for assistance. For Heavy Duty (HD) & 24/7 use applicable textiles, please check with the mill/manufacturer.										

10a. DO YOU WANT TO USE MULTIPLE TEXTILES ON YOUR CHAIR? IF YES, PLEASE LIST YOUR TEXTILES IN THIS ORDER:

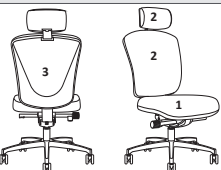
UPHOLSTERY LAYOUT	ORDER	DETAILS TO ADD TO YOUR MODEL #	IMPORTANT NOTES
	1	SEAT (PATTERN COLORWAY)	Seat textile will be applied to a selected 20SU or 20RU arm cap.
	2	BACK (PATTERN COLORWAY)	Back textile will be applied to a selected headrest.
	3	BACKSHELL (PATTERN COLOWAY)	Must select 22UBF or 22UBL from Step 9.

BUILD YOUR MODEL

STEP #	INSTRUCTIONS	PART #	LIST PRICE
1	STARTING LIST BASE MODEL.		
2	PETITE SEAT OPTION.		
3	CONTROL OPTION.		
3a	SEAT SLIDE OPTION.		
3b	FORWARD TILT OPTION.		
4	ARM OPTION.		
4a	ARM CAP OPTION.		
4b	UPHOLSTERED CAP OPTION.		
4c	ADJUSTABLE ARM WIDTH BRACKET OPTION.		
5	BASE OPTION.		
5a	CASTER/GLIDE OPTION.		
5b	SAFETY-BRAKE CASTER OPTION.		
6	ADJUSTABLE LUMBAR OPTION.		
7	HEADREST OPTION.		
8	BALLISTIC BRISBANE OPTION.		
9	UPHOLSTERED BACKSHELL OPTION.		
UPHOLSTERY OPTION: CHOOSE 4 OR 4a, CHOOSING HIGHEST GRADE FOR LIST PRICE.			
10	SINGLE TEXTILE STANDARD: ADD GRADE, THEN ADD: - (MILL PATTERN COLORWAY)		
10a	TWO-TONE UPHOLSTERY OPTION: ADD GRADE, THEN ADD: - SEAT (MILL PATTERN COLORWAY) - BACK (MILL PATTERN COLORWAY)		
PACKAGING:			
11	STANDARD SHIPPING: CHAIRS SHIP 95% ASSEMBLED. NO TOOLS REQUIRED.		
	CHAIRS SHIP FULLY ASSEMBLED OPTION (ADD PART # -FA AND LIST PRICE \$80/CHAIR).		
	BLANKET WRAPPED OPTION: MINIMUM ORDER OF 150, ADD PART # -BW AND CALL FOR LIST PRICING 1-800-433-6614.		
FINAL MODEL NUMBER & TOTAL LIST:			

OR SPEC IT THE EASY WAY

via Design your perfect chair on our online builder: Spec It!
SPEC IT! <http://www.viaseating.com/specit>



specified model #:
 1503-67CSS-39A5-18BB-16HP-HDR1-GR 1
 (MOMENTUM HUE NIGHT)

DIMENSIONS & FINISHES

Dimensions and finishes can be found online. Studio V, Via Seating’s engineering design team, continuously updates and works with its partners to update Via Seating products to the latest industry advances and to customer feedback. Dimensions, finishes & resources are made available online to allow for real-time updates with the most current data.



QR CODE

Find Brisbane HD information at viaseating.com/series/brisbane-hd-247-chairs/ or scan the QR code to the right →

Carmel

solutions: executive, management, conference, execu-task, jury seating



featured image: 6901-67CSS-53A20SU-19AB-18PB-16SCG-EDS-CTSC (GOLD)-GR 6 (VIA SEATING VIA LEATHER SLATE 93)

features

Breadth of Line: available as a high back, mid back and a jury chair.

Backrest: high or mid backs available in split or single shell forms. Optional fixed back on split shells.

Stitching: unique, tuxedo-style stitching with choice of adding executive diamond stitching to the headrests.

Arms: choices include ergonomic 8D adjustable arms or executive "C" shape fixed arms in black polyurethane or upholstery.

Control Mechanisms: controls include latest quick adjust advanced synchro (no endless turning of the handle to adjust your backrest to your level of comfort) with choice of an optional 2.5" seat depth adjustment and an optional +3° forward tilt adjustment.

Bases: five-star swivel bases available in black nylon, polished aluminum and brushed aluminum.

Via Seating's comfort foam: a proprietary blend of high-density, injection-molded, closed-cell, cold-cured foam so durable and lasting it is backed by Via Seating's 12 year warranty.

SPEC IT! ONLINE CHAIR BUILDER
Yes.
QUICK SHIP MANUFACTURING TIME
10 chairs/48 hours.
HIGHEST WEIGHT CAPACITY
350 lb.
WARRANTY
12 years.
BIFMA LEVEL
Yes, LEVEL 2.
HEALTHIER HOSPITALS INITIATIVE (HHI)
Yes.
MINDFUL MATERIALS
Yes.
GSA (CONTRACT #: GS-28F-005CA)
Yes, SIN# 711-18.



design by Studio V

Studio V creates modern, sophisticated and original seating solutions that are ergonomic, beautiful and sustainable. This team of engineers, sustainability experts and designers is based in Reno, Nevada. Studio V develops products using a prototyping lab, the latest in 3D modeling software and a materials testing center.



Carmel

LOWEST PRICED MODEL: \$986





GSA SIN #: 711-18 | MANUFACTURED IN U.S.A.

QUICK SHIP SCHEDULES

Code is listed in the starting model. Deviations from this are listed where they occur.

CODE	# MADE	DETAILS
10	10/48	10 chairs manufactured in 48 hours.
5	5/48	2 chairs manufactured in 48 hours.
2	2/48	2 chairs manufactured in 48 hours.
📞	CALL	FOR LEAD TIME: 1-800-433-6614

1. CHOOSE YOUR STARTING LIST BASE MODEL.

BACK TYPE	Mid back.		High back.	
SHELL TYPE	Single back standard.	Split back option.	Single back standard.	Split back option.
PART #	10 6901		10 6903	
STARTING LIST PRICE	\$986	Add a synchro control option found in step 2.	\$1,150	Add a synchro control option found in step 2.
IMAGE				
STARTING MODEL #	6901-11C-0A-18BB-16HP-GR A	6901-67C-0A-18BB-16HP-GR A	6903-11C-0A-18BB-16HP-GR A	6903-67C-0A-18BB-16HP-GR A
COM COL CHAIR	2 yd 29.25 sq ft	2 yd 29.25 sq ft	2 yd 31.72 sq ft	2 yd 31.72 sq ft

2. DO YOU WANT AN ADJUSTABLE HEIGHT BACK?

PART #	-RB	NEW!
STARTING PRICE	+\$150	
DETAILS	Adjustable height option on split back chairs. Standard backs are fixed.	

3. CHOOSE YOUR CONTROL MECHANISM.

3a. ADD SEAT SLIDE?

3b. ADD FORWARD TILT?

3c. ADD A SHORTER ADJUSTMENT HANDLE?

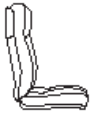
USE ON	USE WITH	PART#	PRICE	DETAILS	PART #	PRICE	DETAILS	PART #	PRICE	DETAILS	PART #	PRICE	DETAILS	MAX WEIGHT
 Single back: Back & seat are connected.	All backs.	-11C	+\$0	Single position knee tilt control.	n/a	n/a	n/a	n/a	n/a	n/a	-1CRC	+\$0	Shortened conference adjustment handle.	300 lb.
 Split back: Back & seat are separate.	High backs only.	-9CH	+\$168	Synchro control with heavy-duty spring tension.	n/a	n/a	n/a	n/a	n/a	n/a	n/a	n/a	n/a	350 lb.
		-10CH	+\$260	Synchro control with heavy-duty spring tension and a seat slide.		+\$0	Included.	n/a	n/a	n/a	n/a	n/a	n/a	n/a
	Mid backs only.	-67C	+\$195	Quick adjust advanced synchro control featuring single rotation adjustments.	n/a	n/a	n/a	n/a	n/a	n/a	n/a	n/a	n/a	350 lb.
		-67CSS	+\$286	Quick adjust advanced synchro control with a seat depth adjustment.		+\$0	Included. Slide the seat +2.5" forward.	-FT	+\$42	+3° of a forward tilt.	n/a	n/a	n/a	350 lb.

NOTE Discontinuing options 9C & 10C (mid backs) & 29C are best replaced by 67C & 67CSS (mid backs) & 9CH/10CH (high backs), respectively. More details pg. 180.

4. DO YOU WANT YOUR CHAIR TO BE ON A JURY BASE?

USE WITH BACK	USE WITH CONTROL	PART#	PRICE	IMAGE	DETAILS	MAX WEIGHT
Single shell mid back.	11C	-20JRY	+\$306		control 11C: single position knee tilt gas lift: <ul style="list-style-type: none"> Height adjustable with 360 degree swivel. No weight return-to-center. No weight return-to-max-height. base: 12" diameter die-casted aluminum, black finish.	300 lb.

FIND MORE OPTIONS ON THE FOLLOWING PAGE. →

5. CHOOSE YOUR ARM TYPE.

→ DO YOU WANT AN ARMLESS CHAIR?







USE WITH	PART#	PRICE	IMAGE	DETAILS
All backs.	-0A	+\$0		Armless chairs are standard.

DO YOU WANT TO ADD AN ADJUSTABLE ARM?

5a. CHOOSE YOUR ARM CAP.



5b. ADD AN UPHOLSTERED CAP?

5c. ADD ADJUSTABLE WIDTH?

PART#	PRICE	IMAGE	DETAILS	PART #	PRICE	IMAGE	DETAILS	PART#	PRICE	PART#	PRICE	DETAILS
-51A	+\$89		Black polyurethane arm with optional 8-way adjustments.	20S	+\$0		Standard fixed cap.	U	+\$ your textile grade price found in step 10.	-19AB	+\$33	Brackets can adjust the width between arms by 2" per side.
				20R	+\$42		4D rotating cap.					
-53A	+\$150		Polished aluminum arm with optional 8-way adjustments.	20S	+\$0		Standard fixed cap.					
				20R	+\$42		4D rotating cap.					

→ DO YOU WANT TO ADD A FIXED ARM?







5d. ADD UPHOLSTERY ON SELECT ARMS.

PART#	PRICE	IMAGE	DETAILS	TEXTILE GRADE PRICE	ARM COM COL
-80A	+\$216		Black polyurethane executive "C" shape arm.	n/a	n/a
2 -90A	+\$297		Fully upholstered executive "C" shape arm with a polyurethane interior.	+\$ your textile grade price from step 10.	add 1.25 yd 8 sq ft

6. CHOOSE YOUR 5-STAR SWIVEL BASE.



6a. CHOOSE YOUR CASTERS OR GLIDES.

6b. ADD SAFETY-BRAKE CASTERS?

PART#	PRICE	IMAGE	DETAILS	PART#	PRICE	IMAGE	DETAILS	PART#	PRICE	DETAILS
-18BB	+\$0		Standard black nylon base.	-16HP	+\$0		Black finish casters are for use on soft/carpeted floors.	-SL1	+\$29	This feature locks the casters only when you are not sitting in the chair.
-18PB	+\$114		Polished aluminum base.	-16SCG	+\$29		Grey finish casters are for use on both hard floors & soft/carpeted floors.	-SL2	+\$29	
-18BA	+\$114		Brushed aluminum base.	-16GL	+\$29		Black finish glides are for use on all floor types.	n/a	n/a	



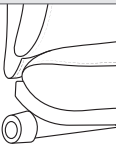





7. DO YOU WANT TO ADD AN ADJUSTABLE LUMBAR SUPPORT?

8. DO YOU WANT TO ADD A DIAMOND STITCH PATTERN ON YOUR HEADREST?

PART#	PRICE	IMAGE	DETAILS	PART#	PRICE	IMAGE	DETAILS
-12LUM	+\$114		Mechanical, internal lumbar support, which is adjusted by turning a dial. Clockwise = more support Counter-clockwise = less support	5 -EDS	+\$200		Executive diamond stitch (EDS) is available on the mid & high back models. It is placed across the front of the headrest. EDS is best paired with leathers. For testing on fabrics & vinyl, please contact your customer service specialist.

9. DO YOU WANT TO ADD EMPHASIZED STITCH?

9a. CHOOSE YOUR EMPHASIZED STITCH THREAD COLOR.

PART #	-CTS	PART#	-03	-05	-04	-06	-07	-09	-08	-10	☎ -CCT
PRICE	+\$0	PRICE	+\$0	+\$0	+\$0	+\$0	+\$0	+\$0	+\$0	+\$0	CALL 1-800-433-6614
IMAGE SHOWING CONTRASTING STITCH LINES BOLDED		IMAGE									Lead time on chairs with custom thread colors can take up to 6 weeks from time of order confirmation depending on the availability of the thread color specified. Conditions may apply.
NOTE	Standard thread color is a tonal match to the textile(s) selected.	DETAILS	Black thread.	Grey thread.	White thread.	Cream thread.	Chocolate thread.	Blue thread.	Red thread.	Yellow thread.	

10. ADD YOUR TEXTILE GRADE(S).

PART #	PRICE (DEPENDS ON FABRIC GRADE SELECTED)										DETAILS
	A	B	1/COM	2	3/COL	4	5	6	7	8	
6901	+\$0	+\$28	+\$80	+\$121	+\$189	+\$271	+\$365	+\$487	+\$633	+\$822	Mid back.
6903	+\$0	+\$33	+\$86	+\$127	+\$194	+\$276	+\$371	+\$492	+\$640	+\$828	High back.
U	+\$31	+\$31	+\$31	+\$31	+\$31	+\$31	+\$63	+\$63	+\$63	+\$63	Upholstered caps on arms 51A, 52A & 53A.
90A	+\$0	+\$2	+\$4	+\$8	+\$10	+\$18	+\$22	+\$30	+\$41	+\$52	Fully upholstered arm.
NOTE	Must include mill, pattern and colorway listed after your grade choice in your model #. For COM/COL see pg. 18. We are happy to supply yardage requirement quotes for large quantity chair orders, as material economies may be realized. Please call 1-800-433-6614 or email your customer service manager for assistance.										

FIND A QUOTING GUIDE ON THE FOLLOWING PAGE. →

BUILD YOUR MODEL

STEP #	INSTRUCTIONS	PART #	LIST PRICE
1	STARTING LIST BASE MODEL.		
2	FIXED BACK OPTION (ADJUSTABLE IS STANDARD).		
3	CONTROL OPTION.		
3a	SEAT SLIDE OPTION.		
3b	FORWARD TILT OPTION.		
3c	SHORTER CONFERENCE HANDLE OPTION.		
4	JURY CHAIR OPTION.		
5	ARM OPTION.		
5a	ARM CAP OPTION.		
5b	UPHOLSTERED CAP OPTION.		
5c	ADJUSTABLE WIDTH BRACKET OPTION.		
5d	ARM UPHOLSTERY OPTION.		
6	BASE OPTION.		
6a	CASTER/GLIDE OPTION.		
6b	SAFETY-BRAKE CASTER OPTION.		
7	ADJUSTABLE LUMBAR SUPPORT OPTION.		
8	DIAMOND STITCHING ON HEADREST OPTION.		
9	EMPHASIZED STITCH OPTION.		
9a	EMPHASIZED STITCH THREAD COLOR.		
UPHOLSTERY:			
10	SINGLE TEXTILE STANDARD: ADD GRADE, THEN ADD:		
	- (MILL PATTERN COLORWAY)		
PACKAGING:			
11	STANDARD SHIPPING: CHAIRS SHIP 95% ASSEMBLED. NO TOOLS REQUIRED.		
	CHAIRS SHIP FULLY ASSEMBLED OPTION (ADD PART # -FA AND LIST PRICE \$80/CHAIR).		
	BLANKET WRAPPED OPTION: MINIMUM ORDER OF 150, ADD PART # -BW AND CALL FOR LIST PRICING 1-800-433-6614.		
FINAL MODEL NUMBER & TOTAL LIST:			

OR SPEC IT THE EASY WAY

via Design your perfect chair on our online builder: Spec It!
SPEC IT! <http://www.viaseating.com/specit>



specified model #:

6901-67CSS-53A20SU-19AB-18PB-16SCG-EDS-CTSC (CUSTOM GOLD)-GR 6 (VIA SEATING VIA LEATHER SLATE 93)

FAQ

1. Can I apply my own thread color in the Emphasized Stitch program?

Yes. Please note, lead time on chairs with custom thread colors can take up to 6 weeks from time of order confirmation depending on the complexity and availability of the thread color specified. Conditions may apply. Please contact 1-800-433-6614 for more information.

2. Can the forward tilt feature on the 67CSS go on the 67C?

No. The 67CSS-FT is Via Seating's latest full function ergonomic control option delivering both a 3° forward tilt and a 2.5" seat slide.

2. Can the high back synchro controls go on the mid backs? And vice-versa?

No. The 67C, 67CSS & 67CSSFT were designed for the mid back models. The 9CH & 10CH were designed to utilize a heavy-duty spring tension to support higher weight capacities on high back models.

DIMENSIONS & FINISHES

Dimensions and finishes can be found online. Studio V, Via Seating's engineering design team, continuously updates and works with its partners to update Via Seating products to the latest industry advances and to customer feedback. Dimensions, finishes & resources are made available online to allow for real-time updates with the most current data.



QR CODE

Find Carmel information at viaseating.com/series/carmel-chairs or scan the QR code to the right →

benches (Chico)

solutions: lounge, collaborative, lobby



featured image: 976-3POL-GR 7 SEAT 1 (MOMENTUM OATH CHARCOAL), SEAT 2 (MOMENTUM TROVE QUARRY), SEAT 3 (MOMENTUM OATH CHARCOAL)

features

Breadth of Line: 40" and 60" long low-profile benches.

Designer Shape: contemporary design meets European style delivering sleek, open shapes.

Upholstery: unique upholstery options including the ability to upholster the wedge shapes in different textiles.

Bases: offers brushed and polished on the loop bases.

Via Seating's comfort foam: a proprietary blend of high-density, injection-molded, closed-cell, cold-cured foam so durable and lasting it is backed by Via Seating's 12 year warranty.

SPEC IT! ONLINE CHAIR BUILDER
Yes.
QUICK SHIP MANUFACTURING TIME
5 benches/48 hours.
HIGHEST WEIGHT CAPACITY
2000 lb.
WARRANTY
6 year warranty.
BIFMA LEVEL
Yes, LEVEL 2.
HEALTHIER HOSPITALS INITIATIVE (HHI)
Yes.
MINDFUL MATERIALS
Yes.
GSA (CONTRACT #: GS-28F-005CA)
Yes, SIN# 711-16.



design by Hindenes, Berg & Knudsen

Studio KBH is made up of designers Steinar Hindenes, Anders Berg, Petter Knudsen. The trio were all educated at Bergen Academy of Art and Design. KBH mainly works with furniture, product and interior designs, but is also involved in a series of project based design initiatives. In partnership with manufacturers, they aim to create material and production driven objects with a distinct character.



benches (Chico)

LOWEST PRICED MODEL: \$2,038



GSA SIN #: 711-16 | MANUFACTURED IN U.S.A.

QUICK SHIP SCHEDULES



Code is listed in the starting model. Deviations from this are listed where they occur.

CODE	# MADE	DETAILS
5	5/48	5 Chairs manufactured in 48 hours.
☎	CALL	FOR LEAD TIME: 1-800-433-6614

1. CHOOSE YOUR STARTING LIST BASE MODEL.

BENCH LENGTH	40 inch long bench	60 inch long bench
PART #	5 974	5 976
STARTING LIST PRICE	\$2,038	\$2,289
IMAGE		
DETAILS	Chico style	Chico style
STARTING MODEL #	974-3BRU-GR A	976-3BRU-GR A
COM COL LEFT SEAT	1.5 yd 9 sq ft	1.5 yd 9 sq ft
COM COL MIDDLE SEAT	n/a	0.60 yd 9 sq ft
COM COL RIGHT SEAT	1.5 yd 9 sq ft	1.5 yd 9 sq ft
COM COL WHOLE BENCH	1.5 yd 23 sq ft	2 yd 32 sq ft
MAX WEIGHT	1000 lb.	2000 lb.

2. CHOOSE YOUR FIXED BASE.

PART#	PRICE	IMAGE	DETAILS	MATERIAL
-3BRU	+\$0		Loop legs with a brushed finish.	Steel.
-3POL	+\$192		Loop legs with a polished finish.	Steel.

3. DO YOU WANT TO ADD EMPHASIZED STITCH?

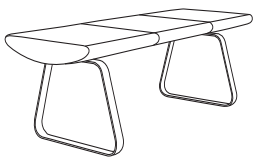
PART #	-CTS
PRICE	+\$0
IMAGE SHOWING CONTRASTING STITCH LINES BOLDED	
NOTE	Standard thread color is a tonal match to the textile(s) selected.

3a. CHOOSE YOUR EMPHASIZED STITCH THREAD COLOR.

PART#	-03	-05	-04	-06	-07	-09	-08	-10
PRICE	+\$0	+\$0	+\$0	+\$0	+\$0	+\$0	+\$0	+\$0
IMAGE								
DETAILS	Black thread.	Grey thread.	White thread.	Cream thread.	Chocolate thread.	Blue thread.	Red thread.	Yellow thread.

4. ADD YOUR TEXTILE GRADE(S).

PART #	PRICE (DEPENDS ON FABRIC GRADE SELECTED)										DETAILS
	A	B	1/COM	2	3/COL	4	5	6	7	8	
974	+\$0	+\$105	+\$216	+\$373	+\$543	+\$726	+\$974	+\$1247	+\$1696	+\$2213	40" bench.
976	+\$0	+\$120	+\$248	+\$427	+\$621	+\$831	+\$1114	+\$1425	+\$1940	+\$2530	60" bench.
NOTE	Must include mill, pattern and colorway listed after your grade choice in your model #. For COM/COL see pg. 18. We are happy to supply yardage requirement quotes for large quantity chair orders, as material economies may be realized. Please call 1-800-433-6614 or email your customer service manager for assistance.										

FIND MORE OPTIONS ON THE FOLLOWING PAGE. →

4a. 974 BENCH: DO YOU WANT FOUR-TONE UPHOLSTERY? IF YES, PLEASE LIST YOUR TEXTILES IN THIS ORDER:

UPHOLSTERY LAYOUT	ORDER	DETAILS TO ADD TO YOUR MODEL #	IMPORTANT NOTES	PRICING NOTE
	1	LEFT SEAT (MILL PATTERN COLORWAY)	Includes the top & bottom of the left seat.	Four-tone upholstery uses the highest grade of the two textiles.
	2	RIGHT SEAT (MILL PATTERN COLORWAY)	Includes the top & bottom of the right seat.	
	3	WEDGE LEFT (MILL PATTERN COLORWAY)	Includes the left wedge.	
	4	WEDGE RIGHT (MILL PATTERN COLORWAY)	Includes the right wedge.	

4b. 976 BENCH: DO YOU WANT FIVE-TONE UPHOLSTERY? IF YES, PLEASE LIST YOUR TEXTILES IN THIS ORDER:

UPHOLSTERY LAYOUT	ORDER	DETAILS TO ADD TO YOUR MODEL #	IMPORTANT NOTES	PRICING NOTE
	1	LEFT SEAT (MILL PATTERN COLORWAY)	Includes the top & bottom of the left seat.	Four-tone upholstery uses the highest grade of the two textiles.
	2	MIDDLE SEAT (MILL PATTERN COLORWAY)	Includes the top & bottom of the middle seat.	
	3	RIGHT SEAT (MILL PATTERN COLORWAY)	Includes the top & bottom of the right seat.	
	4	WEDGE LEFT (MILL PATTERN COLORWAY)	Includes the left wedge.	
	5	WEDGE RIGHT (MILL PATTERN COLORWAY)	Includes the right wedge.	

BUILD YOUR MODEL

STEP #	INSTRUCTIONS	PART #	LIST PRICE
1	STARTING LIST BASE MODEL.		
2	BASE OPTION.		
3	EMPHASIZED STITCH OPTION.		
3a	EMPHASIZED STITCH THREAD COLOR.		
UPHOLSTERY OPTION: CHOOSE 3, 3a, 3b or 3c, CHOOSING HIGHEST GRADE FOR LIST PRICE.			
4	SINGLE TEXTILE STANDARD: ADD GRADE, THEN ADD: - (MILL PATTERN COLORWAY)		
4a	974 THREE-TONE UPHOLSTERY: ADD GRADE, THEN ADD: - LEFT SEAT (MILL PATTERN COLORWAY) - RIGHT SEAT (MILL PATTERN COLORWAY)		
	976 FOUR-TONE UPHOLSTERY: ADD GRADE, THEN ADD: - LEFT SEAT (MILL PATTERN COLORWAY) - MIDDLE SEAT (MILL PATTERN COLORWAY) - RIGHT SEAT (MILL PATTERN COLORWAY)		
PACKAGING:			
5	STANDARD SHIPPING: BENCHES SHIP FULLY ASSEMBLED.		
FINAL MODEL NUMBER & TOTAL LIST:			

OR SPEC IT THE EASY WAY



specified model #:
 976-3POL-GR 7
 LEFT SEAT (MOMENTUM OATH CHARCOAL)
 MIDDLE SEAT (MOMENTUM TROVE QUARRY),
 RIGHT SEAT (MOMENTUM OATH CHARCOAL)

FAQ

1. Can I apply my own thread color in the Emphasized Stitch program?

Yes. Please note, lead time on chairs with custom thread colors can take up to 6 weeks from time of order confirmation depending on the complexity and availability of the thread color specified. Conditions may apply. Please contact 1-800-433-6614 for more information.

DIMENSIONS & FINISHES

Dimensions and finishes can be found online. Studio V, Via Seating’s engineering design team, continuously updates and works with its partners to update Via Seating products to the latest industry advances and to customer feedback. Dimensions, finishes & resources are made available online to allow for real-time updates with the most current data.



QR CODE

Find Chico Bench information at viaseating.com/series/chico-benches/ or scan the QR code to the right →

Chico

solutions: lounge, collaborative, lobby, executive guest

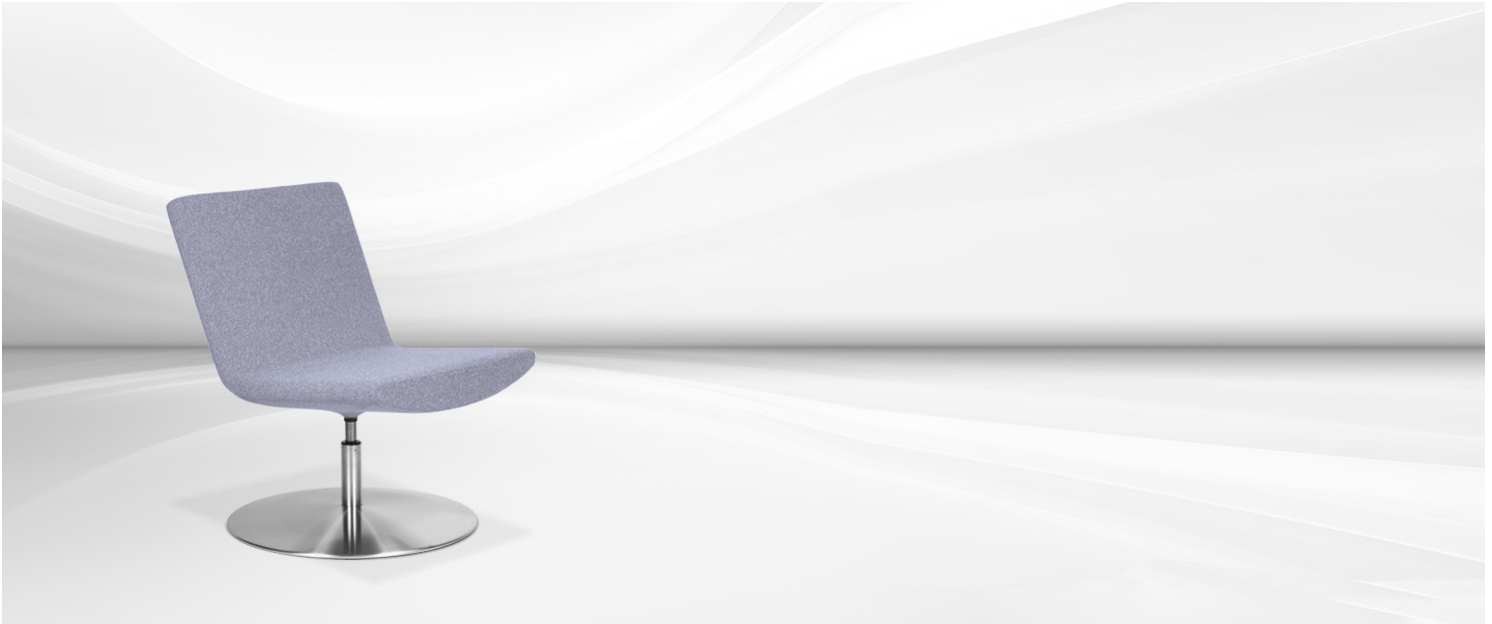

featured image: 945-69C-3DISK-SO-GR 4 (MAHARAM MESSENGER OYSTER)

features

Breadth of Line: soft seating chair, benches (pg. 57) and ottomans (Chico & Luna, pg. 99).

Designer Shape: contemporary design meets European style delivering sleek, open shapes.

Upholstery: unique upholstery options including the ability to upholster the wedge shapes in different textiles.

Bases: offered a variety of finishes including polished, brushed, matte black, silver and wood.

Via Seating's comfort foam: a proprietary blend of high-density, injection-molded, closed-cell, cold-cured foam so durable and lasting it is backed by Via Seating's 12 year warranty.

SPEC IT! ONLINE CHAIR BUILDER
Yes.
QUICK SHIP MANUFACTURING TIME
5 chairs/48 hours.
HIGHEST WEIGHT CAPACITY
300 lb.
WARRANTY
6 years.
BIFMA LEVEL
Yes, LEVEL 2.
HEALTHIER HOSPITALS INITIATIVE (HHI)
Yes.
MINDFUL MATERIALS
Yes.
GSA (CONTRACT #: GS-28F-005CA)
Yes, SIN# 711-16.



design by Hindenes, Berg & Knudsen

Studio KBH is made up of designers Steinar Hindenes, Anders Berg, Petter Knudsen. The trio were all educated at Bergen Academy of Art and Design. KBH mainly works with furniture, product and interior designs, but is also involved in a series of project based design initiatives. In partnership with manufacturers, they aim to create material and production driven objects with a distinct character.



Chico Chair

STARTING LIST PRICE: \$1,118

GSA SIN #: 711-16 | MANUFACTURED IN U.S.A.

QUICK SHIP SCHEDULES

Code is listed in the starting model. Deviations from this are listed where they occur.

CODE	# MADE	DETAILS
5	5/48	5 Chairs manufactured in 48 hours.
📞	CALL	FOR LEAD TIME: 1-800-433-6614

1. CHOOSE YOUR STARTING LIST BASE MODEL.





PART #	5 945
STARTING LIST PRICE	\$1,118
IMAGE	
STARTING MODEL #	945-69C-33POL-SO-GR A
COM COL SEAT & BACK	1.3 yd 19 sq ft
COM COL FRONT WEDGE	0.15 yd 3 sq ft*
COM COL WHOLE CHAIR	1.5 yd 22 sq ft*

2. CHOOSE YOUR CONTROL MECHANISM ("MOTION-LOUNGE EXPERIENCE").

USE WITH	PART#	PRICE	DETAILS	MAX WEIGHT
33POL, 33BLK, 3DISK, 4WAL & 4OAK	-69C	+\$0	360 degree swivel.	300 lb

3. CHOOSE YOUR BASE TYPE.



DO YOU WANT A LOUNGE BASE WITH FIXED HEIGHT AND OPTIONAL SWIVEL?

PART#	PRICE	IMAGE	DETAILS	MATERIAL
-33POL	+\$0		4-leg fixed-height base with a polished finish.	Aluminum.
-33BLK	+\$0		4-leg fixed-height base with a powder-coated matte black finish.	Aluminum.
-3DISK	+\$234		Disk base with a brushed finish.	Steel.
-4WAL NEW!	+\$176		High profile 4-leg fixed-height wood base with a walnut wood finish.	Wood.
-4OAK NEW!	+\$176		High profile 4-leg fixed-height wood base with an oak wood finish.	Wood.

3a. CHOOSE YOUR GAS LIFT FUNCTIONALITY.

PART#	PRICE	DETAILS	NOTE
-SO	+\$0	Non return-to-center.	Cylinder color matches base finish.
-SR	+\$26	Return-to-center.	
-SF	+\$26	Fixed (no swivel).	
-SO	+\$0	Non return-to-center.	Option -SR ready now.
-SR	+\$26	Return-to-center.	
-SF	+\$26	Fixed (no swivel).	
-SO	+\$0	Non return-to-center.	Option -SR ready now.
-SR	+\$26	Return-to-center.	
-SO	+\$0	Non return-to-center.	Option -SR ready now.
-SR	+\$26	Return-to-center.	

DO YOU WANT A COMPLETELY FIXED LOUNGE BASE (NO MOTION)?



PART#	PRICE	IMAGE	DETAILS	MATERIAL	MAX WEIGHT
-21XB	+\$78		Wire frame fixed-height x base with a matte black finish.	Steel.	300 lb.
-21XS	+\$121		Wire frame fixed-height x base with a powder-coated silver finish.	Steel.	300 lb.
NOTE	Does not include a control mechanism from step 2.				

3b. DO YOU WANT TO ADD A FELT GLIDE?

PART#	PRICE	DETAILS
-FELT	+\$20	Felt glides.
-FELT	+\$20	Felt glides. NEW!

FIND MORE OPTIONS ON THE FOLLOWING PAGE. →

DO YOU WANT A COMPLETELY FIXED LOUNGE BASE (NO MOTION)?

PART#	PRICE	IMAGE	DETAILS	MATERIAL	NOTE	MAX WEIGHT
-5WAL NEW!	+\$176		Low profile 4-leg fixed-height wood base with a walnut wood finish.	Wood.	Does not include a control mechanism from step 3. New bases ready October. Pre-order now.	300 lb.
-5OAK NEW!	+\$176		Low profile 4-leg fixed-height wood base with an oak wood finish.	Wood.		300 lb.

4. DO YOU WANT TO ADD EMPHASIZED STITCH?

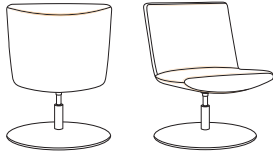
PART #	-CTS
PRICE	+\$0
IMAGE SHOWING CONTRASTING STITCH LINES BOLDED	
NOTE	Standard thread color is a tonal match to the textile(s) selected.

4a. CHOOSE YOUR EMPHASIZED STITCH THREAD COLOR.

PART#	-03	-05	-04	-06	-07	-09	-08	-10
PRICE	+\$0	+\$0	+\$0	+\$0	+\$0	+\$0	+\$0	+\$0
IMAGE								
DETAILS	Black thread.	Grey thread.	White thread.	Cream thread.	Chocolate thread.	Blue thread.	Red thread.	Yellow thread.

5. ADD YOUR TEXTILE GRADE(S).

PART #	PRICE (DEPENDS ON FABRIC GRADE SELECTED)										DETAILS
	A	B	1/COM	2	3/COL	4	5	6	7	8	
945	+\$0	+\$67	+\$138	+\$238	+\$347	+\$464	+\$623	+\$797	+\$1084	+\$1415	Chico chair.
NOTE	Must include mill, pattern and colorway listed after your grade choice in your model #. For COM/COL see pg. 18. We are happy to supply yardage requirement quotes for large quantity chair orders, as material economies may be realized. Please call 1-800-433-6614 or email your customer service manager for assistance.										

5a. DO YOU WANT TWO-TONE UPHOLSTERY? IF YES, PLEASE LIST YOUR TEXTILES IN THIS ORDER:

UPHOLSTERY LAYOUT	ORDER	DETAILS TO ADD TO YOUR MODEL #	IMPORTANT NOTES	PRICING NOTE
	1	SEAT & BACK (MILL PATTERN COLORWAY)	Includes the front & back side of the backrest & the seat.	Two-tone upholstery uses the highest grade of the two textiles.
	2	WEDGE SHAPES (MILL PATTERN COLORWAY)	Includes the front & top wedges shape only.	

BUILD YOUR MODEL

STEP #	INSTRUCTIONS	PART #	LIST PRICE
1	FINAL MODEL NUMBER & TOTAL LIST:		
2	CONTROL OPTION.		
3	BASE OPTION.		
3a	CYLINDER OPTION.		
3b	FELT GLIDE OPTION.		
4	EMPHASIZED STITCH OPTION.		
4a	EMPHASIZED STITCH THREAD COLOR.		
UPHOLSTERY OPTION: CHOOSE 4 OR 4a, CHOOSING HIGHEST GRADE FOR LIST PRICE.			
5	SINGLE TEXTILE STANDARD: ADD GRADE, THEN ADD: - (MILL PATTERN COLORWAY)		
	TWO-TONE UPHOLSTERY OPTION: ADD GRADE, THEN ADD: - SEAT (MILL PATTERN COLORWAY) - BACK (MILL PATTERN COLORWAY)		
PACKAGING:			
6	STANDARD SHIPPING: CHAIRS SHIP FULLY ASSEMBLED.		
FINAL MODEL NUMBER & TOTAL LIST:			

OR SPEC IT THE EASY WAY

via Design your perfect chair on our online builder: Spec It!
SPEC IT! <http://www.viaseating.com/specit>



specified model #:
945-69C-3DISK-SO-GR 4
(MAHARAM MESSENGER OYSTER)

FAQ

1. Can I apply my own thread color in the Emphasized Stitch program?

Yes. Please note, lead time on chairs with custom thread colors can take up to 6 weeks from time of order confirmation depending on the complexity and availability of the thread color specified. Conditions may apply. Please contact 1-800-433-6614 for more information.

2. Can I apply my own color to any of the Chico bases?

Yes. Minimums apply. Additional pricing and conditions apply. Please contact 1-800-433-6614 for more information.

DIMENSIONS & FINISHES

Dimensions and finishes can be found online. Studio V, Via Seating's engineering design team, continuously updates and works with its partners to update Via Seating products to the latest industry advances and to customer feedback. Dimensions, finishes & resources are made available online to allow for real-time updates with the most current data.

Find Chico information at viaseating.com/series/chico-chair or scan the QR code to the right →



QR CODE

Comet

solutions: motion-lounge, lounge, collaborative, lobby, executive guest, conference



featured image: chair 925-69C-3DISK-SO-GR 6 (ARC COM ELEVADO CARIBBEAN) & ottoman 926-2DISK-SR-GR 6 (ARC COM, ELEVADO CARIBBEAN)

features

Breadth of Line: soft seating chair and ottomans (Chico & Luna, pg. 99).

Designer Shape: high profile back for privacy and support, with a cradling sit.

Upholstery: option to upholster the seat and back in two different textiles.

Control Mechanisms: choices include motion-lounge rock (back-and-forth rocking movement) & 360 degree swivel.

Bases: a variety of lovely polished, brushed, matte black and silver bases including 5-star swivel conference bases.

Via Seating's comfort foam: a proprietary blend of high-density, injection-molded, closed-cell, cold-cured foam so durable and lasting it is backed by Via Seating's 12 year warranty.

SPEC IT! ONLINE CHAIR BUILDER
Yes.
QUICK SHIP MANUFACTURING TIME
2 chairs/48 hours.
HIGHEST WEIGHT CAPACITY
300 lb.
WARRANTY
6 years.
BIFMA LEVEL
Yes, LEVEL 2.
HEALTHIER HOSPITALS INITIATIVE (HHI)
Yes.
MINDFUL MATERIALS
Yes.
GSA (CONTRACT #: GS-28F-005CA)
Yes, SIN# 711-16.



design by Studio V

Studio V creates modern, sophisticated and original seating solutions that are ergonomic, beautiful and sustainable. This team of engineers, sustainability experts and designers is based in Reno, Nevada. Studio V develops products using a prototyping lab, the latest in 3D modeling software and a materials testing center.



Comet

LOWEST PRICED MODEL: \$1,019

GSA SIN #: 711-16 | MANUFACTURED IN U.S.A.

QUICK SHIP SCHEDULES

Code is listed in the starting model. Deviations from this are listed where they occur.

CODE	# MADE	DETAILS
2	2/48	2 Chairs manufactured in 48 hours.
☎	CALL	FOR LEAD TIME: 1-800-433-6614

1. CHOOSE YOUR STARTING LIST BASE MODEL.

PART #	2 925
STARTING LIST PRICE	\$1,019
	
STARTING MODEL #	925-69C-18BB-GR A
COM COL SEAT ONLY	0.75 yd 10 sq ft
COM COL BACK ONLY	2.25 yd 44 sq ft
COM COL WHOLE CHAIR	2.75 yd 50 sq ft

2. DO YOU WANT A FIXED SEAT?



PART #	-FXD
PRICE	+\$157
DETAILS	The standard seat is a clean out and removable velcro attached seat. Upcharge is for a permanent, fixed seat.

3. CHOOSE YOUR CONTROL MECHANISM ("MOTION-LOUNGE EXPERIENCE").



USE WITH	PART#	PRICE	DETAILS	MAX WEIGHT
All bases.	-69C	+\$0	360 degree swivel.	300 lb.
33POL, 33BLK & 3DISK	-70C	+\$157	Rocking with 360 degree swivel.	300 lb.

4. CHOOSE YOUR BASE TYPE.



DO YOU WANT A 5-STAR SWIVEL BASE WITH ADJUSTABLE HEIGHT?

PART#	PRICE	IMAGE	DETAILS	MATERIAL
-18BB	+\$0		Standard black swivel base with height adjustment handle.	Nylon.
-18PB	+\$114		Polished aluminum swivel base with height adjustment handle.	Aluminum.
-18BA	+\$114		Brushed aluminum swivel base with height adjustment handle.	Aluminum.

4a. SWIVEL BASES: CHOOSE YOUR CASTERS OR GLIDES.

PART#	PRICE	IMAGE	DETAILS
-16HP	+\$0		Black finish casters are for use on soft/carpeted floors.
-16SCG	+\$29		Grey finish casters are for use on both hard floors & soft/carpeted floors.
-16GL	+\$29		Black finish glides are for use on all floor types.

DO YOU WANT A LOUNGE BASE WITH FIXED HEIGHT AND OPTIONAL SWIVEL?

PART#	PRICE	IMAGE	DETAILS	MATERIAL
-33POL	+\$187		4-leg fixed-height base with a polished finish.	Aluminum.
-33BLK	+\$187		4-leg fixed-height base with a powder-coated matte black finish.	Aluminum.
-3DISK	+\$421		Disk base with a brushed finish.	Steel.

4b. LOUNGE BASES: CHOOSE YOUR GAS LIFT FUNCTIONALITY.

PART#	PRICE	DETAILS	NOTE
-SO	+\$0	Non return-to-center.	Cylinder color matches base finish.
-SR	+\$26	Return-to-center.	
-SF	+\$26	Fixed (no swivel).	

FIND MORE OPTIONS ON THE FOLLOWING PAGE. →

5. DO YOU WANT TO ADD EMPHASIZED STITCH?

PART #	-CTS
PRICE	+\$0
IMAGE SHOWING CONTRASTING STITCH LINES BOLDDED	
NOTE	Standard thread color is a tonal match to the textile(s) selected.

5a. CHOOSE YOUR EMPHASIZED STITCH THREAD COLOR.

PART#	-03	-05	-04	-06	-07	-09	-08	-10
PRICE	+\$0	+\$0	+\$0	+\$0	+\$0	+\$0	+\$0	+\$0
IMAGE								
DETAILS	Black thread.	Grey thread.	White thread.	Cream thread.	Chocolate thread.	Blue thread.	Red thread.	Yellow thread.

6. ADD YOUR TEXTILE GRADE(S).

PART #	PRICE (DEPENDS ON FABRIC GRADE SELECTED)										DETAILS
	A	B	1/COM	2	3/COL	4	5	6	7	8	
925	+\$0	+\$72	+\$147	+\$254	+\$369	+\$493	+\$660	+\$845	+\$1150	+\$1500	Comet chair.
NOTE	Must include mill, pattern and colorway listed after your grade choice in your model #. For COM/COL see pg. 18. We are happy to supply yardage requirement quotes for large quantity chair orders, as material economies may be realized. Please call 1-800-433-6614 or email your customer service manager for assistance.										

6a. DO YOU WANT TWO-TONE UPHOLSTERY? IF YES, PLEASE LIST YOUR TEXTILES IN THIS ORDER:

UPHOLSTERY LAYOUT	ORDER	DETAILS TO ADD TO YOUR MODEL #	IMPORTANT NOTES	PRICING NOTE
	1	SEAT (MILL PATTERN COLORWAY)	Includes seat.	Two-tone upholstery uses the highest grade of the two textiles.
	2	BACK (MILL PATTERN COLORWAY)	Includes front & back side of backrest or, in other words, all upholstered parts, but the seat.	

BUILD YOUR MODEL

STEP #	INSTRUCTIONS	PART #	LIST PRICE
1	STARTING LIST BASE MODEL.		
2	SEAT OPTION: REMOVABLE OR FIXED.		
3	CONTROL OPTION.		
4	BASE OPTION.		
4a	CYLINDER OPTION.		
5	EMPHASIZED STITCH OPTION.		
5a	EMPHASIZED STITCH THREAD COLOR.		
UPHOLSTERY OPTION: CHOOSE 5 OR 5a, CHOOSING HIGHEST GRADE FOR LIST PRICE.			
6	SINGLE TEXTILE STANDARD: ADD GRADE, THEN ADD: - (MILL PATTERN COLORWAY)		
	TWO-TONE UPHOLSTERY OPTION: ADD GRADE, THEN ADD: - SEAT (MILL PATTERN COLORWAY)		
6a	- BACK (MILL PATTERN COLORWAY)		
PACKAGING:			
7	STANDARD SHIPPING: CHAIRS SHIP FULLY ASSEMBLED.		
FINAL MODEL NUMBER & TOTAL LIST:			

OR SPEC IT THE EASY WAY

via Design your perfect chair on our online builder: Spec It!
SPEC IT! <http://www.viaseating.com/specit>



specified model #:
925-69C-3DISK-SO-GR 6 (ARC COM ELEVADO CARIBBEAN)

FAQ

1. Can I apply my own thread color in the Emphasized Stitch program?

Yes. Please note, lead time on chairs with custom thread colors can take up to 6 weeks from time of order confirmation depending on the complexity and availability of the thread color specified. Conditions may apply. Please contact 1-800-433-6614 for more information.

2. What is the best way to maximize on my motion-lounge experience?

For maximum comfort, Via Seating recommends pairing the motion experience: rocking with 360 degree swivel (**70C**) with a lounge ottoman. Find ottomans on **pg. 99**.

3. Can I get a fixed seat?

Yes. Please see option 2.

DIMENSIONS & FINISHES

Dimensions and finishes can be found online. Studio V, Via Seating's engineering design team, continuously updates and works with its partners to update Via Seating products to the latest industry advances and to customer feedback. Dimensions, finishes & resources are made available online to allow for real-time updates with the most current data.

Find Comet information at viaseating.com/series/comet-chair or scan the QR code to the right →



QR CODE

Dyce

solutions: executive, management, conference, execu-task, jury seating



featured image: 5301-11C-4A-18PB-16HP-GR 5 (VIA SEATING VIA LEATHERS BLACK 75)

features

Breadth of Line: available as high backs, mid backs and a jury chair.

Stitching: distinguished stitching on the front and back.

Arms: choices include ergonomic 8D adjustable arms or executive "C" shape fixed arms in black polyurethane or upholstery.

Control Mechanisms: utilizes a single position knee tilt control.

Bases: five-star swivel bases available in black nylon, polished aluminum and brushed aluminum.

Via Seating's comfort foam: a proprietary blend of high-density, injection-molded, closed-cell, cold-cured foam so durable and lasting it is backed by Via Seating's 12 year warranty.

SPEC IT! ONLINE CHAIR BUILDER
Yes.
QUICK SHIP MANUFACTURING TIME
10 chairs/48 hours.
HIGHEST WEIGHT CAPACITY
300 lb.
WARRANTY
12 years.
BIFMA LEVEL
Yes, LEVEL 2.
HEALTHIER HOSPITALS INITIATIVE (HHI)
Yes.
MINDFUL MATERIALS
Yes.
GSA (CONTRACT #: GS-28F-005CA)
Yes, SIN# 711-18.



design by Studio V

Studio V creates modern, sophisticated and original seating solutions that are ergonomic, beautiful and sustainable. This team of engineers, sustainability experts and designers is based in Reno, Nevada. Studio V develops products using a prototyping lab, the latest in 3D modeling software and a materials testing center.



LOWEST PRICED MODEL: \$1,094



GSA SIN #: 711-18 | MANUFACTURED IN U.S.A.

QUICK SHIP SCHEDULES

Code is listed in the starting model. Deviations from this are listed where they occur.

CODE	# MADE	DETAILS
10	10/48	10 Chairs manufactured in 48 hours.
2	2/48	2 Chairs manufactured in 48 hours.
📞	CALL	FOR LEAD TIME: 1-800-433-6614

1. CHOOSE YOUR STARTING LIST BASE MODEL.

BACK TYPE	Mid back.	High back.
PART #	10 5301	10 5303
STARTING LIST PRICE	\$1,094	\$1,293
IMAGE		
STARTING MODEL #	5301-11C-0A-18BB-16HP-GR A	5303-11C-0A-18BB-16HP-GR A
COM COL CHAIR	1.5 yd 20.8 sq ft	1.75 yd 24.5 sq ft

2. CHOOSE YOUR CONTROL MECHANISM.

2a. ADD A SHORTER ADJUSTMENT HANDLE?

PART#	PRICE	DETAILS	PART #	PRICE	DETAILS	MAX WEIGHT
-11C	+\$0	Single position knee tilt control.	-1CRC	+\$0	Shortened conference adjustment handle.	300 lb.

3. DO YOU WANT YOUR CHAIR TO BE ON A JURY BASE?

USE WITH BACK	PART#	PRICE	IMAGE	DETAILS	MAX WEIGHT
Mid back only.	-20JRY	+\$306		control 11C: single position knee tilt gas lift: <ul style="list-style-type: none"> Height adjustable with 360 degree swivel. No weight return-to-center. No weight return-to-max-height. base: 12" diameter die-casted aluminum, black finish.	300 lb.

4. CHOOSE YOUR ARM TYPE.

DO YOU WANT AN ARMLESS CHAIR?





PART#	PRICE	IMAGE	DETAILS
-0A	+\$0		Armless chairs are standard.

DO YOU WANT TO ADD AN ADJUSTABLE ARM?

4a. CHOOSE YOUR ARM CAP.

4b. ADD AN UPHOLSTERED CAP?

4c. ADD ADJUSTABLE WIDTH?

PART#	PRICE	IMAGE	DETAILS	PART #	PRICE	IMAGE	DETAILS	PART#	PRICE	PART#	PRICE	DETAILS
-51A	+\$89		Black polyurethane arm with optional 8-way adjustments.	20S	+\$0		Standard fixed cap.	U	+\$ your textile grade price found in step 6.	-19AB	+\$33	Brackets can adjust the width between arms by 2" per side.
				20R	+\$42		4D rotating cap.					
-53A	+\$150		Polished aluminum arm with optional 8-way adjustments.	20S	+\$0		Standard fixed cap.					
				20R	+\$42		4D rotating cap.					

FIXED ARM OPTIONS ON FOLLOWING PAGE. →

DO YOU WANT TO ADD A FIXED ARM?

4d. ADD UPHOLSTERY ON SELECT ARMS.

PART#	PRICE	IMAGE	DETAILS	TEXTILE GRADE PRICE	ARM COM COL
-2A	+\$116		Black polyurethane classic open arm.	n/a	n/a
2 -4A	+\$148		Black polyurethane classic open arm with a fully upholstered polyurethane cap.	+\$ your textile grade price from step 6.	add 0.75 yd 1.6 sq ft
-80A	+\$216		Black polyurethane executive "C" shape arm.	n/a	n/a
2 -90A	+\$297		Fully upholstered executive "C" shape arm with a polyurethane interior.	+\$ your textile grade price from step 6.	add 1.25 yd 8 sq ft

5. CHOOSE YOUR 5-STAR SWIVEL BASE.

5a. CHOOSE YOUR CASTERS OR GLIDES.

5b. ADD SAFETY-BRAKE CASTERS?

PART#	PRICE	IMAGE	DETAILS
-18BB	+\$0		Standard black nylon base.
-18PB	+\$114		Polished aluminum base.
-18BA	+\$114		Brushed aluminum base.

PART#	PRICE	IMAGE	DETAILS
-16HP	+\$0		Black finish casters are for use on soft/carpeted floors.
-16SCG	+\$29		Grey finish casters are for use on both hard floors & soft/carpeted floors.
-16GL	+\$29		Black finish glides are for use on all floor types.

PART#	PRICE	DETAILS
-SL1	+\$29	This feature locks the casters only when you are not sitting in the chair.
-SL2	+\$29	
n/a	n/a	

6. ADD YOUR TEXTILE GRADE(S).

PART #	PRICE (DEPENDS ON FABRIC GRADE SELECTED)										DETAILS
	A	B	1/COM	2	3/COL	4	5	6	7	8	
5301	+\$0	+\$19	+\$33	+\$98	+\$162	+\$230	+\$324	+\$431	+\$651	+\$919	Mid back.
5303	+\$0	+\$23	+\$49	+\$115	+\$179	+\$245	+\$339	+\$445	+\$668	+\$932	High back.
U	+\$31	+\$31	+\$31	+\$31	+\$31	+\$31	+\$63	+\$63	+\$63	+\$63	Upholstered caps on arms 51A, 52A & 53A.
4A	+\$0	+\$0	+\$0	+\$0	+\$0	+\$0	+\$34	+\$34	+\$34	+\$34	Open arm with upholstered cap.
90A	+\$0	+\$2	+\$4	+\$8	+\$10	+\$18	+\$22	+\$30	+\$41	+\$52	Fully upholstered arm.
NOTE	Must include mill, pattern and colorway listed after your grade choice in your model #. For COM/COL see pg. 18. We are happy to supply yardage requirement quotes for large quantity chair orders, as material economies may be realized. Please call 1-800-433-6614 or email your customer service manager for assistance.										

BUILD YOUR MODEL

STEP #	INSTRUCTIONS	PART #	LIST PRICE
1	STARTING LIST BASE MODEL.		
2	CONTROL OPTION.		
2a	SHORTER CONFERENCE HANDLE OPTION.		
3	JURY CHAIR OPTION.		
4	ARM OPTION.		
4a	ARM CAP OPTION.		
4b	UPHOLSTERED CAP OPTION.		
4c	ADJUSTABLE WIDTH BRACKET OPTION.		
5	BASE OPTION.		
5a	CASTER/GLIDE OPTION.		
5b	SAFETY-BRAKE CASTER OPTION.		
UPHOLSTERY OPTION: CHOOSE 4 OR 4a, CHOOSING HIGHEST GRADE FOR LIST PRICE.			
6	SINGLE TEXTILE STANDARD: ADD GRADE, THEN ADD:		
	- (MILL PATTERN COLORWAY)		
PACKAGING:			
7	STANDARD SHIPPING: CHAIRS SHIP 95% ASSEMBLED. NO TOOLS REQUIRED.		
	CHAIRS SHIP FULLY ASSEMBLED OPTION (ADD PART # -FA AND LIST PRICE \$80/CHAIR).		
	BLANKET WRAPPED OPTION: MINIMUM ORDER OF 150, ADD PART # -BW AND CALL FOR LIST PRICING 1-800-433-6614.		
FINAL MODEL NUMBER & TOTAL LIST:			

OR SPEC IT THE EASY WAY

via Design your perfect chair on our online builder: Spec It!
SPEC IT! <http://www.viaseating.com/specit>



specified model #:
5301-11C-4A-18PB-16HP-GR 5
(VIA SEATING VIA LEATHERS BLACK 75)

DIMENSIONS & FINISHES

Dimensions and finishes can be found online. Studio V, Via Seating's engineering design team, continuously updates and works with its partners to update Via Seating products to the latest industry advances and to customer feedback. Dimensions, finishes & resources are made available online to allow for real-time updates with the most current data.

Find Dyce information at viaseating.com/series/dyce-chairs or scan the QR code to the right →



QR CODE

Edge

solutions: lounge, collaborative, lobby, executive guest, conference



featured image: 928-69C-4WAL-SR-GR 1 SEAT (MAHARAM, PEBBLE WOOL MULTI WHISPER), INNER BACK(MAHARAM PEBBLE WOOL MULTI WHISPER) OUTER BACK (MOMENTUM'S TRI-KES, ZEN

features

Breadth of Line: soft seating chair and ottomans (Chico & Luna, pg. 99).

Designer Shape: sleek design, with multi-upholstery options across the seat, interior of the back & exterior of the back.

Control Mechanisms: choices include 360 degree swivel.

Bases: features Edge's signature high-profile 4-leg walnut or oak finish wood base, low-profile 4-leg wood bases and a variety of lovely polished, brushed, matte black and silver bases including 5-star swivel conference base options.

Via Seating's comfort foam: a proprietary blend of high-density, injection-molded, closed-cell, cold-cured foam so durable and lasting it is backed by Via Seating's 12 year warranty.

SPEC IT! ONLINE CHAIR BUILDER
Yes.
QUICK SHIP MANUFACTURING TIME
5 chairs/48 hours.
HIGHEST WEIGHT CAPACITY
400 lb.
WARRANTY
6 years.
BIFMA LEVEL
Yes, LEVEL 2.
HEALTHIER HOSPITALS INITIATIVE (HHI)
Yes.
MINDFUL MATERIALS
Yes.
GSA (CONTRACT #: GS-28F-005CA)
Yes, SIN# 711-16.



design by Studio V

Studio V creates modern, sophisticated and original seating solutions that are ergonomic, beautiful and sustainable. This team of engineers, sustainability experts and designers is based in Reno, Nevada. Studio V develops products using a prototyping lab, the latest in 3D modeling software and a materials testing center.



LOWEST PRICED MODEL: \$887

GSA SIN #: 711-16 | MANUFACTURED IN U.S.A.

QUICK SHIP SCHEDULES

Code is listed in the starting model. Deviations from this are listed where they occur.

CODE	# MADE	DETAILS
5	5/48	5 Chairs manufactured in 48 hours.
📞	CALL	FOR LEAD TIME: 1-800-433-6614

1. CHOOSE YOUR STARTING LIST BASE MODEL.

PART #	5 985
STARTING LIST PRICE	\$887
IMAGE	
STARTING MODEL #	985-69C-18BB-16HP-GR A
COM COL SEAT ONLY	1 yd 7 sq ft •
COM COL INNER BACK ONLY	2 yd 14 sq ft •
COM COL OUTER BACK ONLY	1.25 yd 16 sq ft •
COM COL WHOLE CHAIR	2.25 yd 35 sq ft •

2. DO YOU WANT A FIXED SEAT?



PART #	-FXD
PRICE	+\$157
DETAILS	The standard seat is a clean out and removable velcro attached seat. Upcharge is for a permanent, fixed seat.

3. CHOOSE YOUR CONTROL MECHANISM ("MOTION-LOUNGE EXPERIENCE").



USE WITH	PART#	PRICE	DETAILS	MAX WEIGHT
18BB, 18PB, 18BA, 33POL, 33BLK & 3DISK	-69C	+\$0	360 degree swivel.	400 lb.

4. CHOOSE YOUR BASE TYPE.





DO YOU WANT A 5-STAR SWIVEL BASE WITH ADJUSTABLE HEIGHT?

PART#	PRICE	IMAGE	DETAILS	MATERIAL
-18BB	+\$0		Standard black swivel base with height adjustment handle.	Nylon.
-18PB	+\$114		Polished aluminum swivel base with height adjustment handle.	Aluminum.
-18BA	+\$114		Brushed aluminum swivel base with height adjustment handle.	Aluminum.

4a. SWIVEL BASES: CHOOSE YOUR CASTERS OR GLIDES.

PART#	PRICE	IMAGE	DETAILS
-16HP	+\$0		Black finish casters are for use on soft/carpeted floors.
-16SCG	+\$29		Grey finish casters are for use on both hard floors & soft/carpeted floors.
-16GL	+\$29		Black finish glides are for use on all floor types.

DO YOU WANT A LOUNGE BASE WITH FIXED HEIGHT AND OPTIONAL SWIVEL?

PART#	PRICE	IMAGE	DETAILS	MATERIAL
-33POL	+\$187		4-leg fixed-height base with a polished finish.	Aluminum.
-33BLK	+\$187		4-leg fixed-height base with a powder-coated matte black finish.	Aluminum.
-3DISK	+\$421		Disk base with a brushed finish.	Steel.
-4WAL	+\$363		High profile 4-leg fixed-height wood base with a walnut wood finish.	Wood.
-4OAK	+\$363		High profile 4-leg fixed-height wood base with an oak wood finish.	Wood.





NEW!

4b. CHOOSE YOUR GAS LIFT FUNCTIONALITY.

PART#	PRICE	DETAILS	NOTE
-SO	+\$0	Non return-to-center.	Cylinder color matches base finish.
-SR	+\$26	Return-to-center.	
-SF	+\$26	Fixed (no swivel).	
-SO	+\$0	Non return-to-center.	Option -SR ready now.
-SR	+\$26	Return-to-center.	
-SF	+\$26	Fixed (no swivel).	
-SO	+\$0	Non return-to-center.	Option -SR ready now.
-SR •	+\$26	Return-to-center.	

FIND MORE OPTIONS ON THE FOLLOWING PAGE. ➔

→ DO YOU WANT A COMPLETELY FIXED LOUNGE BASE (NO MOTION)?

PART#	PRICE	IMAGE	DETAILS	MATERIAL	NOTE	MAX WEIGHT
-21XB	+\$265		Wire frame fixed-height x base with a matte black finish.	Steel.	Does not include a control mechanism from step 3.	300 lb.
-21XS	+\$308		Wire frame fixed-height x base with a powder-coated silver finish.	Steel.		300 lb.
-SWAL	+\$363		Low profile 4-leg fixed-height wood base with a walnut wood finish.	Wood.	Does not include a control mechanism from step 3. New bases ready October. Pre-order now.	300 lb.
-5OAK	+\$363		Low profile 4-leg fixed-height wood base with an oak wood finish.	Wood.		300 lb.
NOTE	Does not include a control mechanism from step 3.					

4c. DO YOU WANT TO ADD A FELT GLIDE?

PART#	PRICE	DETAILS
-FELT	+\$20	Felt glides.
-FELT	+\$20	Felt glides. NEW!

5. DO YOU WANT TO ADD EMPHASIZED STITCH?

PART #	-CTS
PRICE	+\$0
IMAGE SHOWING CONTRASTING STITCH LINES BOLDED	
NOTE	Standard thread color is a tonal match to the textile(s) selected.

5a. CHOOSE YOUR EMPHASIZED STITCH THREAD COLOR.

PART#	-03	-05	-04	-06	-07	-09	-08	-10
PRICE	+\$0	+\$0	+\$0	+\$0	+\$0	+\$0	+\$0	+\$0
IMAGE								
DETAILS	Black thread.	Grey thread.	White thread.	Cream thread.	Chocolate thread.	Blue thread.	Red thread.	Yellow thread.

6. ADD YOUR TEXTILE GRADE(S).

PART #	PRICE (DEPENDS ON FABRIC GRADE SELECTED)										DETAILS
	A	B	1/COM	2	3/COL	4	5	6	7	8	
985	+\$0	+\$53	+\$110	+\$189	+\$276	+\$369	+\$494	+\$632	+\$860	+\$1122	Edge chair.
NOTE	Must include mill, pattern and colorway listed after your grade choice in your model #. For COM/COL see pg. 18. We are happy to supply yardage requirement quotes for large quantity chair orders, as material economies may be realized. Please call 1-800-433-6614 or email your customer service manager for assistance.										

6a. DO YOU WANT THREE-TONE UPHOLSTERY? IF YES, PLEASE LIST YOUR TEXTILES IN THIS ORDER:

UPHOLSTERY LAYOUT	ORDER	DETAILS TO ADD TO YOUR MODEL #	IMPORTANT NOTES	PRICING NOTE
	1	SEAT (MILL PATTERN COLORWAY)	Includes seat.	Three-tone upholstery uses the highest grade of the three textiles.
	2	INNER BACK (MILL PATTERN COLORWAY)	Includes inside of the chair back, arms & lip beneath the seat.	
	3	OUTER BACK (PATTERN COLORWAY)	Includes outside of the chair back & arms.	

FIND A QUOTING GUIDE ON THE FOLLOWING PAGE. →

BUILD YOUR MODEL

STEP #	INSTRUCTIONS	PART #	LIST PRICE
1	STARTING LIST BASE MODEL.		
2	SEAT OPTION: REMOVABLE OR FIXED.		
3	CONTROL OPTION.		
4	BASE OPTION.		
4a	CASTERS OR GLIDES OPTION.		
4b	CYLINDER OPTION.		
4c	FELT GLIDE OPTION.		
5	EMPHASIZED STITCH OPTION.		
5a	EMPHASIZED STITCH THREAD COLOR.		
UPHOLSTERY OPTION: CHOOSE 4 OR 4a, CHOOSING HIGHEST GRADE FOR LIST PRICE.			
6	SINGLE TEXTILE STANDARD: ADD GRADE, THEN ADD: - (MILL PATTERN COLORWAY)		
	THREE-TONE UPHOLSTERY OPTION: ADD GRADE, THEN ADD: - SEAT (MILL PATTERN COLORWAY) - INNER BACK (MILL PATTERN COLORWAY) - OUTER BACK (MILL PATTERN COLORWAY)		
PACKAGING:			
7	STANDARD SHIPPING: CHAIRS SHIP FULLY ASSEMBLED.		
FINAL MODEL NUMBER & TOTAL LIST:			

OR SPEC IT THE EASY WAY

via Design your perfect chair on our online builder: Spec It!
SPEC IT! <http://www.viaseating.com/specit>



specified model #:

928-69C-4WAL-SR-GR 1
SEAT (MAHARAM, PEBBLE WOOL MULTI WHISPER),
INNER BACK (MAHARAM PEBBLE WOOL MULTI WHISPER)
OUTER BACK (MOMENTUM'S TRI-KES, ZEN UHR-ZN GALENA)

FAQ

1. Can I apply my own thread color in the Emphasized Stitch program?

Yes. Please note, lead time on chairs with custom thread colors can take up to 6 weeks from time of order confirmation depending on the complexity and availability of the thread color specified. Conditions may apply. Please contact 1-800-433-6614 for more information.

2. Can I apply my own color to any of the bases?

Yes. Minimums apply. Additional pricing and conditions apply. Please contact 1-800-433-6614 for more information.

3. Can I get a fixed seat?

Yes. Please see option 2.

DIMENSIONS & FINISHES

Dimensions and finishes can be found online. Studio V, Via Seating's engineering design team, continuously updates and works with its partners to update Via Seating products to the latest industry advances and to customer feedback. Dimensions, finishes & resources are made available online to allow for real-time updates with the most current data.

Find Edge information at viaseating.com/series/edge-chair or scan the QR code to the right →



QR CODE



featured image: 405-W-67CSS-FT-52A18R-19AB-18PB-16SCG-NSP-GR 4 (MOMENTUM FAUX FELT FLANNEL)

features

Breadth of Line: available as a mid back chair or task stool in a black or white frame.

Seats: offering six seat sizes—petite to extra-large—with an all in one look and reaching a 350 lb weight rating. Optional stitch-work or seamless seats for infection prevention & easy clean up.

Mesh: offering choices in standard, high-performance, 4-way elastomeric mesh or biocidal, first-to-market, patent-pending, Genie Copper Mesh® in natural copper and black copper, perfect for healthcare environments as well as improving hygiene in shared desk situations.

Arms: multiple height and width adjustable options and a fixed, conference arm.

Control Mechanisms: controls include latest quick adjust advanced synchro (no endless turning of the handle to adjust your backrest to your level of comfort) with choice of an optional 2.5" seat depth adjustment and an optional +3° forward tilt adjustment.

Bases: five-star swivel bases available in black nylon, polished aluminum and brushed aluminum.

Via Seating's comfort foam: a proprietary blend of high-density, injection-molded, closed-cell, cold-cured foam so durable and lasting it is backed by Via Seating's 12 year warranty.

SPEC IT! ONLINE CHAIR BUILDER
Yes.
QUICK SHIP MANUFACTURING TIME
20 chairs/48 hours.
MAX WEIGHT RANGE
400 lb.
WARRANTY
12 years including HD 24/7 chairs, 5 years for mesh.
BIFMA LEVEL
Yes, LEVEL 2.
HEALTHIER HOSPITALS INITIATIVE (HHI)
Yes.
MINDFUL MATERIALS
Yes.
GSA (CONTRACT #: GS-28F-005CA)
Yes, SIN# 711-18.



design by Henner Jahns

Henner Jahns, founder and lead designer of Gecco Vision (est. 1997), specializes in creating tailor-made office furniture. His company focuses on cultivating a vision into reality. The small design team is seen as an advantage, allowing each member to really focus on the development of something new. The result is numerous, award-winning, seating solutions that stand out.



LOWEST PRICED MODEL: \$686

GSA SIN #: 711-18 | MANUFACTURED IN U.S.A.

HEAVY DUTY (HD) 24/7 USE OPTIONS

Code is listed in the starting model to the right of the quick ship code.

CODE	DETAILS
20	For use in 24/7 & HD applications.

QUICK SHIP SCHEDULES

Code is listed in the starting model. Deviations from this are listed where they occur.

CODE	# MADE	DETAILS
20	20/48	20 Chairs manufactured in 48 hours.
10	10/48	10 Chairs manufactured in 48 hours.
	CALL	FOR LEAD TIME: 1-800-433-6614

1. CHOOSE YOUR STARTING LIST BASE MODEL.

SEAT SIZE	Standard A seat.	Medium B seat.	Heavy-duty large C seat.	Heavy-duty extra-large D seat.
PART #	20 401	20 405	20 408	20 410
STARTING LIST PRICE	\$686	\$752	\$923	\$1,206
IMAGE				
STARTING MODEL #	401-B-25C-0A-18BB-16HP-1G-GR A	405-B-25C-0A-18BB-16HP-1G-GR A	408-B-25C-0A-18BB-16HP-1G-GR A	410-B-25C-0A-18BB-16HP-1G-GR A
COM COL SEAT	1 yd 9 sq ft •	1 yd 9 sq ft •	1 yd 9 sq ft	1 yd 9 sq ft •

2. DO YOU WANT TO ADD A PETITE SEAT (-1" DEPTH)?

SEAT SIZE	AA petite seat.	BB petite seat.	n/a	n/a
PART #	1PTG-	1PTG-		
PRICE	+\$69	+\$69		

3. CHOOSE YOUR FRAME COLOR.

PART#	-B	-W	NOTE
PRICE	+\$0	+\$55	White frames were formerly specified as separate model numbers:
IMAGE			<ul style="list-style-type: none"> 421 (A seat) 425 (B seat) 428 (C seat) 430 (D seat)
DETAILS	Standard Black.	White.	These were consolidated into a frame color selection for easier specification.

4. CHOOSE YOUR CONTROL MECHANISM.

DO YOU WANT A CHAIR? SELECT YOUR CONTROL.

3a. ADD SEAT SLIDE?

3b. ADD FORWARD TILT?

USE ON	USE WITH	PART#	PRICE	DETAILS	GASLIFT	PART #	PRICE	DETAILS	PART #	PRICE	DETAILS	MAX WEIGHT
Chairs.	A, B, C seats.	-25C	+\$0	Swivel tilt conference control.	G3A: 4.8" travel.	n/a	n/a	n/a	n/a	n/a	n/a	300 lb.
	A, B, C seats.	-26C	+\$91	Swivel tilt conference control with seat depth adjustment.	G3A: 4.8" travel.		+\$0	Included.	n/a	n/a	n/a	300 lb.
	All seats.	-67C	+\$65	Quick adjust advanced synchro control featuring single rotation adjustments.	G3A: 4.8" travel.	n/a	n/a	n/a	n/a	n/a	n/a	350 lb. A & B seats. 400 lb. C & D seats.
	All seats.	-67CSS	+\$156	Quick adjust advanced synchro control with seat depth adjustment.	G3A: 4.8" travel.		+\$0	Included. Slide the seat +2.5" forward.	-FT	+\$42	+3° of forward tilt.	
	A, B, C seats.	-68C	+\$127	Enhanced body balance control with dynamic fine-tuning.	G3A: 4.8" travel.	-12SS	+\$91	Slide the seat +2" forward.	n/a	n/a	n/a	300 lb.
	All seats.	-74C	+\$61	Auto-adjust body balance control.	G3A: 4.8" travel.	-12SS	+\$91		n/a	n/a	n/a	350 lb. A & B seats. 400 lb. C & D seats.

NOTE: Discontinuing options **61C**, **62C** & **66C** are best replaced by the latest ergonomic technology **67C**, **67CSS** & **74C**, respectively. More details pg. 180.

DO YOU WANT A STOOL? SELECT YOUR CONTROL AND HEIGHT RANGE.

USE ON	USE WITH	PART#	PRICE	DETAILS	GASLIFT	MAX WEIGHT
Stools.	A & B seats.	-35C-11DR	+\$220	Auto-adjust body balance control for stools.	G5: 7.0" travel.	300 lb.
		-35C-11XDR	+\$220	Adds a polished foot ring and extended gas lift with stool height ranges. Available on all bases.	G6: 9.5" travel.	300 lb.

FIND MORE OPTIONS ON THE FOLLOWING PAGE. →

5. CHOOSE YOUR ARM TYPE.

DO YOU WANT AN ARMLESS CHAIR?

USE WITH	PART#	PRICE	IMAGE	DETAILS
All seats.	-0A	+\$0		Armless chairs are standard.

DO YOU WANT TO ADD AN ADJUSTABLE ARM?

5a. CHOOSE YOUR ARM CAP.

5b. ADD UPHOLSTERED CAP? 5c. ADD ADJUSTABLE WIDTH?

USE WITH	PART#	PRICE	IMAGE	DETAILS	PART#	PRICE	IMAGE	DETAILS	PART#	PRICE	PART#	PRICE	DETAILS
A, B, C seats.	-38A	+\$55		Black nylon basic height adjustable arm.	1	+\$0		Standard fixed cap.	n/a	n/a	-19AB	+\$33	Brackets can adjust the width between arms by 2" per side.
					6	+\$0		Preferred fixed cap.					
All seats.	-39A	+\$111		Black nylon height adjustable arm with roll back feature.	1	+\$0		Standard fixed cap.	n/a	n/a	n/a	n/a	Brackets can adjust the width between arms by 2" per side.
					6	+\$0		Preferred fixed cap.					
All seats.	-51A	+\$89		Black polyurethane arm with optional 8-way adjustments.	18S	+\$0		Standard fixed cap.	U	+\$ your textile grade price found in step 9. Please note, the upholstered cap only uses the 20S & 20R caps.	-19AB	+\$33	Brackets can adjust the width between arms by 2" per side.
					18R	+\$42		4D rotating cap.					
All seats.	-52A	+\$116		White polyurethane arm with optional 8-way adjustments.	18S	+\$0		Standard fixed cap.	U	+\$ your textile grade price found in step 9. Please note, the upholstered cap only uses the 20S & 20R caps.	-19AB	+\$33	Brackets can adjust the width between arms by 2" per side.
					18R	+\$42		4D rotating cap.					
All seats.	-53A	+\$150		Polished aluminum arm with optional 8-way adjustments.	18S	+\$0		Standard fixed cap.	U	+\$ your textile grade price found in step 9. Please note, the upholstered cap only uses the 20S & 20R caps.	-19AB	+\$33	Brackets can adjust the width between arms by 2" per side.
					18R	+\$42		4D rotating cap.					

DO YOU WANT TO ADD A FIXED ARM?

5a. CHOOSE YOUR ARM CAP.

USE WITH	PART#	PRICE	IMAGE	DETAILS	PART#	PRICE	IMAGE	DETAILS
A, B, C seats.	-46A	+\$84		Black polyurethane fixed conference arm with fixed cap.		+\$0		Black polyurethane permanent fixed cap.

6. CHOOSE YOUR 5-STAR SWIVEL BASE.

6a. CHOOSE YOUR CASTERS OR GLIDES.

6b. ADD SAFETY-BRAKE CASTERS?

PART#	PRICE	IMAGE	DETAILS
-18BB	+\$0		Black nylon base. Standard with black frames.
-18WB	+\$0		White nylon base. Standard with white frames.
-18PB	+\$114		Polished aluminum base.
-18BA	+\$114		Brushed aluminum base.

USE WITH	PART#	PRICE	IMAGE	DETAILS	PART#	PRICE	DETAILS
All bases.	-16HP	+\$0		Standard black finish casters are for use on soft/carpeted floors.	-SL1	+\$29	This feature locks the casters only when you are not sitting in the chair.
All bases.	-16SCG	+\$29		Grey finish casters are for use on both hard floors & soft/carpeted floors.	-SL2	+\$29	
All bases.	-16GL	+\$29		Black finish glides are for use on all floor types.	n/a	n/a	n/a

7. DO YOU WANT TO ADD AN ADJUSTABLE LUMBAR SUPPORT?

8. CHOOSE YOUR STITCHWORK STYLE FOR VINYL TEXTILES.

PART#	-LS1	DETAILS
PRICE	+\$76	Black finish. This optional height adjustable lumbar allows you to raise or lower the position of the lumbar support. Simply grasp and squeeze the tabs on the left & right of the lumbar. Lift or lower the support to achieve an optimal lumbar position.
IMAGE		

PART#	-NSP	-BBS	-SBS	STANDARDS NOTE
PRICE	+\$0	+\$0	+\$0	-NSP is standard with pattern SILVERTEX. Please call for approval on other vinyls. -BBS & -SBS are standard on all other vinyls.
IMAGE				
DETAILS	Seamless stitch pattern designed for infection prevention & easy clean up.	Baseball stitch pattern for AA, A, B & BB seats.	Side-band stitch pattern for C & D seats.	

9. CHOOSE YOUR MESH COLOR.

PART#	-1G	-2G	-3G	-4G	-5G	-6G	-8G	-11G	-12G
PRICE	+\$0	+\$0	+\$0	+\$0	+\$0	+\$0	+\$0	+\$139	+\$139
IMAGE									
DETAILS	Black.	Silver.	Blue.	Orange.	Green.	Cardinal red.	Coffee.	Black copper.	Natural copper.

FIND A QUOTING GUIDE ON THE FOLLOWING PAGE. →

10. ADD YOUR TEXTILE GRADE(S).

PART #	PRICE (DEPENDS ON FABRIC GRADE SELECTED)										DETAILS
	A	B	1/COM	2	3/COL	4	5	6	7	8	
All chairs.	+\$0	+\$13	+\$49	+\$71	+\$106	+\$156	+\$205	+\$281	+\$368	+\$472	All chairs.
U	+\$31	+\$31	+\$31	+\$31	+\$31	+\$31	+\$63	+\$63	+\$63	+\$63	Upholstered caps on arms 51A, 52A & 53A.
NOTE	Must include mill, pattern and colorway listed after your grade choice in your model #. For COM/COL see pg. 18. We are happy to supply yardage requirement quotes for large quantity chair orders, as material economies may be realized. Please call 1-800-433-6614 or email your customer service manager for assistance.										

BUILD YOUR MODEL

STEP #	INSTRUCTIONS	PART #	LIST PRICE
1	STARTING LIST BASE MODEL.		
2	PETITE SEAT OPTION.		
3	FRAME COLOR.		
4	CONTROL OPTION.		
4a	SEAT SLIDE OPTION.		
4b	FORWARD TILT OPTION.		
5	ARM OPTION.		
5a	ARM CAP OPTION.		
5b	UPHOLSTERED CAP OPTION.		
5c	ADJUSTABLE WIDTH BRACKET OPTION.		
6	BASE OPTION.		
6a	CASTER/GLIDE OPTION.		
6b	SAFETY-BRAKE CASTER OPTION.		
7	LUMBAR SUPPORT OPTION.		
8	VINYL TEXTILES ONLY: SEAT STITCHWORK PATTERN.		
9	MESH COLOR.		
UPHOLSTERY OPTION:			
10	SINGLE TEXTILE STANDARD: ADD GRADE, THEN ADD: - (MILL PATTERN COLORWAY)		
PACKAGING:			
11	STANDARD SHIPPING: CHAIRS SHIP 95% ASSEMBLED. NO TOOLS REQUIRED.		
	CHAIRS SHIP FULLY ASSEMBLED OPTION (ADD PART # -FA AND LIST PRICE \$80/CHAIR).		
	BLANKET WRAPPED OPTION: MINIMUM ORDER OF 150, ADD PART # -BW AND CALL FOR LIST PRICING 1-800-433-6614.		
FINAL MODEL NUMBER & TOTAL LIST:			

OR SPEC IT THE EASY WAY

via SPEC IT! Design your perfect chair on our online builder: Spec It!
<http://www.viaseating.com/specit>



specified model #:
 405-W-67CSS-FT-52A18R-19AB-18PB-16SCG-GR 4
 (MOMENTUM FAUX FELT FLANNEL)

FAQ

1. Can I place a logo on my chair?

No, screen print logos cannot be added to the Genie® mesh.

2. What are the HD 24/7 use options for the Genie® series?

Please see HEAVY DUTY (HD) 24/7 USE OPTIONS as indicated by the symbol . For applicable fabrics, please check with the mill/manufacturer.

DIMENSIONS & FINISHES

Dimensions and finishes can be found online. Studio V, Via Seating’s engineering design team, continuously updates and works with its partners to update Via Seating products to the latest industry advances and to customer feedback. Dimensions, finishes & resources are made available online to allow for real-time updates with the most current data.

Find Genie® information at viaseating.com/series/genie-chairs or scan the QR code to the right →



QR CODE

Linate

solutions: executive, management, conference, execu-task, jury seating



featured image: 5503-10CH-13A-18PB-16SCG-GR 6 (VIA SEATING VIA LEATHERS BLACK 95)

features

Breadth of Line: available as high backs, mid backs and a jury chair.

Backrest: high backs available in split or single shell forms, mid backs available in single shells.

Stitching: distinguished stitching on the front and back.

Arms: choices include ergonomic 8D adjustable arms or executive “C” shape fixed arms in black polyurethane or upholstery.

Control Mechanisms: controls include single position knee tilt & synchro controls.

Bases: five-star swivel bases available in black nylon, polished aluminum and brushed aluminum.

Via Seating’s comfort foam: a proprietary blend of high-density, injection-molded, closed-cell, cold-cured foam so durable and lasting it is backed by Via Seating’s 12 year warranty.

SPEC IT! ONLINE CHAIR BUILDER
Yes.
QUICK SHIP MANUFACTURING TIME
10 chairs/48 hours.
HIGHEST WEIGHT CAPACITY
350 lb.
WARRANTY
12 years.
BIFMA LEVEL
Yes, LEVEL 2.
HEALTHIER HOSPITALS INITIATIVE (HHI)
Yes.
MINDFUL MATERIALS
Yes.
GSA (CONTRACT #: GS-28F-005CA)
Yes, SIN# 711-18.



design by Studio V & Ed Abadie (aba design)

Via Seating’s quintessential execu-task series Linate & Oslo were designed in a collaboration between Studio V and Ed Abadie (ABA Design). These chairs feature Via Seating’s comfort foam, an automobile-inspired, lasting steel framework and hand-manufactured fine stitch work.



Linate

LOWEST PRICED MODEL: \$1,116



GSA SIN #: 711-18 | MANUFACTURED IN U.S.A.

QUICK SHIP SCHEDULES

Code is listed in the starting model. Deviations from this are listed where they occur.

CODE	# MADE	DETAILS
10	10/48	10 Chairs manufactured in 48 hours.
2	2/48	2 Chairs manufactured in 48 hours.
📞	CALL	FOR LEAD TIME: 1-800-433-6614

1. CHOOSE YOUR STARTING LIST BASE MODEL.



BACK TYPE	Mid back.	High back.		
SHELL TYPE	Single back standard.	Single back standard.	Split back option.	
PART #	10 5501	10 5503		
STARTING LIST PRICE	\$1,116	\$1,512	Add a synchro control option found in step 2.	
IMAGE				
STARTING MODEL #	5501-11C-0A-18BB-16HP-GR A	5503-11C-0A-18BB-16HP-GR A	5503-67C-0A-18BB-16HP-GR A	
COM COL CHAIR	1.75 yd 25 sq ft	2.25 yd 31.6 sq ft		

2. CHOOSE YOUR CONTROL MECHANISM.

2a. ADD SEAT SLIDE?



2b. ADD FORWARD TILT?

2c. ADD A SHORTER ADJUSTMENT HANDLE?

USE ON	USE WITH	PART#	PRICE	DETAILS	PART #	PRICE	DETAILS	PART #	PRICE	DETAILS	PART #	PRICE	DETAILS	MAX WEIGHT
 Single back: Back & seat are connected.	All backs.	-11C	+\$0	Single position knee tilt control.	n/a	n/a	n/a	n/a	n/a	n/a	-1CRC	+\$0	Shortened conference adjustment handle.	300 lb.
 Split back: Back & seat are separate.	High backs only.	-9CH	+\$169	Synchro control heavy-duty spring tension.	n/a	n/a	n/a	n/a	n/a	n/a	n/a	n/a	n/a	350 lb.
		-10CH	+\$260	Synchro control with heavy-duty spring tension and a seat slide.		+\$0	Included.	n/a	n/a	n/a	n/a	n/a	n/a	350 lb.

NOTE Discontinuing options 9C & 10C are best replaced by 9CH & 10CH (high backs), which feature a heavy-duty spring tension. More details pg. 180.

3. DO YOU WANT YOUR CHAIR TO BE ON A JURY BASE?

USE WITH BACK	USE WITH CONTROL	PART#	PRICE	IMAGE	DETAILS	MAX WEIGHT
 Single shell mid back.	11C	-20JRY	+\$306		control 11C: single position knee tilt gas lift: <ul style="list-style-type: none"> Height adjustable with 360 degree swivel. No weight return-to-center. No weight return-to-max-height. base: 12" diameter die-casted aluminum, black finish.	300 lb.

4. CHOOSE YOUR ARM TYPE.

DO YOU WANT AN ARMLESS CHAIR?





PART#	PRICE	IMAGE	DETAILS
-0A	+\$0		Armless chairs are standard.

DO YOU WANT TO ADD AN ADJUSTABLE ARM?

4a. CHOOSE YOUR ARM CAP.

4b. ADD AN UPHOLSTERED CAP?

4c. ADD ADJUSTABLE WIDTH?

PART#	PRICE	IMAGE	DETAILS	PART #	PRICE	IMAGE	DETAILS	PART#	PRICE	PART#	PRICE	DETAILS
-51A	+\$89		Black polyurethane arm with optional 8-way adjustments.	20S	+\$0		Standard fixed cap.	U	+\$ your textile grade price found in step 7.	-19AB	+\$33	Brackets can adjust the width between arms by 2" per side.
				20R	+\$42		4D rotating cap.					
-53A	+\$150		Polished aluminum arm with optional 8-way adjustments.	20S	+\$0		Standard fixed cap.					
				20R	+\$42		4D rotating cap.					

FIND FIXED ARMS ON THE FOLLOWING PAGE. →

→ DO YOU WANT TO ADD A FIXED ARM?

4d. ADD UPHOLSTERY ON SELECT ARMS.

USE WITH	PART#	PRICE	IMAGE	DETAILS	TEXTILE GRADE PRICE	ARM COM COL
Single shell backs only.	-2A	+\$116		Black polyurethane classic open arm.	n/a	n/a
Single shell backs only.	2 -4A	+\$148		Black polyurethane classic open arm with a fully upholstered polyurethane cap.	+\$ your textile grade price from step 7.	add 0.75 yd 1.6 sq ft
All backs.	2 -7A	+\$333		Fully upholstered arm with a wood interior.	+\$ your textile grade price from step 7.	add 1 yd 15.9 sq ft •
All backs.	-13A	+\$144		Black polyurethane classic cantilever arm.	n/a	n/a
All backs.	2 -14A	+\$322		Fully upholstered classic cantilever arm with a polyurethane interior.	+\$ your textile grade price from step 7.	add 0.75 yd 6.76 sq ft
All backs.	-80A	+\$216		Black polyurethane executive "C" shape arm.	n/a	n/a
All backs.	2 -90A	+\$297		Fully upholstered executive "C" shape arm with a polyurethane interior.	+\$ your textile grade price from step 7.	add 1.25 yd 8 sq ft

5. CHOOSE YOUR 5-STAR SWIVEL BASE.

5a. CHOOSE YOUR CASTERS OR GLIDES.

5b. ADD SAFETY-BRAKE CASTERS?

PART#	PRICE	IMAGE	DETAILS
-18BB	+\$0		Standard black nylon base.
-18PB	+\$114		Polished aluminum base.
-18BA	+\$114		Brushed aluminum base.

PART#	PRICE	IMAGE	DETAILS	PART#	PRICE	DETAILS
-16HP	+\$0		Black finish casters are for use on soft/carpeted floors.	-SL1	+\$29	This feature locks the casters only when you are not sitting in the chair.
-16SCG	+\$29		Grey finish casters are for use on both hard floors & soft/carpeted floors.	-SL2	+\$29	
-16GL	+\$29		Black finish glides are for use on all floor types.	n/a	n/a	

6. DO YOU WANT TO ADD AN ADJUSTABLE LUMBAR SUPPORT?

PART#	PRICE	IMAGE	DETAILS
-12LUM	+\$114		Mechanical, internal lumbar support, which is adjusted by turning a dial. Clockwise = more support Counter-clockwise = less support

7. ADD YOUR TEXTILE GRADE(S).

PART #	PRICE (DEPENDS ON FABRIC GRADE SELECTED)										DETAILS
	A	B	1/COM	2	3/COL	4	5	6	7	8	
5501	+\$0	+\$24	+\$87	+\$123	+\$186	+\$272	+\$357	+\$494	+\$644	+\$827	Mid back.
5503	+\$0	+\$28	+\$99	+\$141	+\$211	+\$310	+\$408	+\$564	+\$734	+\$946	High back.
U	+\$31	+\$31	+\$31	+\$31	+\$31	+\$31	+\$63	+\$63	+\$63	+\$63	Upholstered caps on arms 51A, 52A & 53A.
4A	+\$0	+\$0	+\$0	+\$0	+\$0	+\$0	+\$34	+\$34	+\$34	+\$34	Upholstered cap on arm 4A.
7A	+\$0	+\$14	+\$48	+\$69	+\$105	+\$156	+\$204	+\$281	+\$368	+\$474	Fully upholstered arm.
14A	+\$0	+\$9	+\$23	+\$35	+\$54	+\$77	+\$101	+\$125	+\$152	+\$182	Fully upholstered arm.
90A	+\$0	+\$2	+\$4	+\$8	+\$10	+\$18	+\$22	+\$30	+\$41	+\$52	Fully upholstered arm.
NOTE	Must include mill, pattern and colorway listed after your grade choice in your model #. For COM/COL see pg. 18. We are happy to supply yardage requirement quotes for large quantity chair orders, as material economies may be realized. Please call 1-800-433-6614 or email your customer service manager for assistance.										

FIND A QUOTING GUIDE ON THE FOLLOWING PAGE. →

BUILD YOUR MODEL

STEP #	INSTRUCTIONS	PART #	LIST PRICE
1	STARTING LIST BASE MODEL.		
2	CONTROL OPTION.		
2a	SEAT SLIDE OPTION.		
2b	FORWARD TILT OPTION.		
2c	SHORTER CONFERENCE HANDLE OPTION.		
3	JURY CHAIR OPTION.		
4	ARM OPTION.		
4a	ARM CAP OPTION.		
4b	UPHOLSTERED CAP OPTION.		
4c	ADJUSTABLE WIDTH BRACKET OPTION.		
5	BASE OPTION.		
5a	CASTER/GLIDE OPTION.		
5b	SAFETY-BRAKE CASTER OPTION.		
6	ADJUSTABLE LUMBAR SUPPORT OPTION.		
UPHOLSTERY:			
7	SINGLE TEXTILE STANDARD: ADD GRADE, THEN ADD: - (MILL PATTERN COLORWAY)		
PACKAGING:			
8	STANDARD SHIPPING: CHAIRS SHIP 95% ASSEMBLED.		
	CHAIRS SHIP FULLY ASSEMBLED OPTION (ADD PART # -FA AND LIST PRICE \$80/CHAIR).		
	BLANKET WRAPPED OPTION: MINIMUM ORDER OF 150, ADD PART # -BW AND CALL FOR LIST PRICING 1-800-433-6614.		
FINAL MODEL NUMBER & TOTAL LIST:			

OR SPEC IT THE EASY WAY

via Design your perfect chair on our online builder: Spec It!
SPEC IT! <http://www.viaseating.com/specit>



specified model #:
5503-10CH-13A-18PB-16SCG-GR 6
(VIA SEATING VIA LEATHERS BLACK 95)

FAQ

1. Can I place a logo on my chair?

Yes, logos can be applied by embroidery on fabric or screen print on mesh & vinyl. These logos must be placed at least 2" away from the edges of the seat or back. Extended lead time on chairs with logos is 4-6 weeks. Please see **pg. 20**.

DIMENSIONS & FINISHES

Dimensions and finishes can be found online. Studio V, Via Seating's engineering design team, continuously updates and works with its partners to update Via Seating products to the latest industry advances and to customer feedback. Dimensions, finishes & resources are made available online to allow for real-time updates with the most current data.

Find Linate information at viaseating.com/series/linate-chairs or scan the QR code to the right →



QR CODE

Meteor

solutions: motion-lounge, lounge, collaborative, lobby, executive guest



featured image: 927-72C-33BLK-SO-GR 7 (MAHARAM COLLINE 108)

features

Breadth of Line: soft seating chair and ottomans (Chico & Luna, pg. 99).

Designer Shape: high profile back for privacy and support, with a cradling sit.

Upholstery: option to upholster the seat and back in two different textiles.

Control Mechanisms: choices include motion-lounge rock (back-and-forth rocking movement), sway (side-to-side swaying movement) & 360 degree swivel.

Bases: a variety of lovely wood, polished, matte black and silver bases including 4-leg fixed height bases with optional swivel and return-to-center.

Via Seating's comfort foam: a proprietary blend of high-density, injection-molded, closed-cell, cold-cured foam so durable and lasting it is backed by Via Seating's 12 year warranty.

SPEC IT! ONLINE CHAIR BUILDER
Yes.
QUICK SHIP MANUFACTURING TIME
2 chairs/48 hours.
HIGHEST WEIGHT CAPACITY
300 lb.
WARRANTY
6 years.
BIFMA LEVEL
Yes, LEVEL 2.
HEALTHIER HOSPITALS INITIATIVE (HHI)
Yes.
MINDFUL MATERIALS
Yes.
GSA (CONTRACT #: GS-28F-005CA)
Yes, SIN# 711-16.



design by Studio V

Studio V creates modern, sophisticated and original seating solutions that are ergonomic, beautiful and sustainable. This team of engineers, sustainability experts and designers is based in Reno, Nevada. Studio V develops products using a prototyping lab, the latest in 3D modeling software and a materials testing center.



Meteor

LOWEST PRICED MODEL: \$1,306

GSA SIN #: 711-16 | MANUFACTURED IN U.S.A.

QUICK SHIP SCHEDULES

Code is listed in the starting model. Deviations from this are listed where they occur.

CODE	# MADE	DETAILS
2	2/48	2 Chairs manufactured in 48 hours.
☎	CALL	FOR LEAD TIME: 1-800-433-6614

1. CHOOSE YOUR STARTING LIST BASE MODEL.

PART #	2 927
STARTING LIST PRICE	\$1,306
IMAGE	
STARTING MODEL #	927-69C-33POL-SO-GR A
COM COL SEAT ONLY	1 yd 7 sq ft •
COM COL BACK ONLY	2 yd 35 sq ft •
COM COL WHOLE CHAIR	3 yd 42 sq ft •

2. DO YOU WANT A FIXED SEAT?



PART #	☎ -FXD
PRICE	+\$157
DETAILS	The Standard seat is a clean out and removable velcro attached seat. Upcharge is for a permanent, fixed seat.

3. CHOOSE YOUR CONTROL MECHANISM ("MOTION-LOUNGE EXPERIENCE").

USE WITH	PART#	PRICE	DETAILS	MAX WEIGHT
33POL, 33BLK & 3DISK	-69C	+\$0	360 degree swivel.	300 lb.
	-70C	+\$157	Rocking with 360 degree swivel.	300 lb.
	-72C	+\$314	Rocking & swaying with 360 degree swivel.	300 lb.

4. CHOOSE YOUR BASE TYPE.





DO YOU WANT A LOUNGE BASE WITH FIXED HEIGHT AND OPTIONAL SWIVEL?

PART#	PRICE	IMAGE	DETAILS	MATERIAL
-33POL	+\$0		4-leg fixed-height base with a polished finish.	Aluminum.
-33BLK	+\$0		4-leg fixed-height base with a powder-coated matte black finish.	Aluminum.
-3DISK	+\$234		Disk base with a brushed finish.	Steel.

4a. CHOOSE YOUR GAS LIFT FUNCTIONALITY.

PART#	PRICE	DETAILS	NOTE
-SO	+\$0	Non return-to-center.	Cylinder color matches base finish.
-SR	+\$26	Return-to-center.	
-SF	+\$26	Fixed (no swivel).	

DO YOU WANT A COMPLETELY FIXED LOUNGE BASE (NO MOTION)?

PART#	PRICE	IMAGE	DETAILS	MATERIAL	NOTE	MAX WEIGHT
-21XB	+\$78		Wire frame fixed-height x base with a matte black finish.	Steel.	Does not include a control mechanism from step 3.	300 lb.
-21XS	+\$121		Wire frame fixed-height x base with a powder-coated silver finish.	Steel.		300 lb.
-5WAL NEW!	+\$176		Low profile 4-leg fixed-height wood base with a walnut wood finish.	Wood.	Does not include a control mechanism from step 3. New bases ready October. Pre-order now.	300 lb.
-5OAK NEW!	+\$176		Low profile 4-leg fixed-height wood base with an oak wood finish.	Wood.		300 lb.

4b. DO YOU WANT TO ADD A FELT GLIDE?

PART#	PRICE	DETAILS
-FELT	+\$20	Felt glides.
-FELT	+\$20	Felt glides. NEW!

FIND MORE OPTIONS ON THE FOLLOWING PAGE. →

5. DO YOU WANT TO ADD EMPHASIZED STITCH?

PART #	-CTS
PRICE	+\$0
IMAGE SHOWING CONTRASTING STITCH LINES BOLDED	
NOTE	Standard thread color is a tonal match to the textile(s) selected.

5a. CHOOSE YOUR EMPHASIZED STITCH THREAD COLOR.

PART#	-03	-05	-04	-06	-07	-09	-08	-10
PRICE	+\$0	+\$0	+\$0	+\$0	+\$0	+\$0	+\$0	+\$0
IMAGE								
DETAILS	Black thread.	Grey thread.	White thread.	Cream thread.	Chocolate thread.	Blue thread.	Red thread.	Yellow thread.

6. ADD YOUR TEXTILE GRADE(S).

PART #	PRICE (DEPENDS ON FABRIC GRADE SELECTED)										DETAILS
	A	B	1/COM	2	3/COL	4	5	6	7	8	
927	+\$0	+\$78	+\$162	+\$279	+\$405	+\$542	+\$727	+\$931	+\$1267	+\$1652	Meteor chair.
NOTE	Must include mill, pattern and colorway listed after your grade choice in your model #. For COM/COL see pg. 18. We are happy to supply yardage requirement quotes for large quantity chair orders, as material economies may be realized. Please call 1-800-433-6614 or email your customer service manager for assistance.										

6a. DO YOU WANT TWO-TONE UPHOLSTERY? IF YES, PLEASE LIST YOUR TEXTILES IN THIS ORDER:

UPHOLSTERY LAYOUT	ORDER	DETAILS TO ADD TO YOUR MODEL #	IMPORTANT NOTES	PRICING NOTE
	1	SEAT (MILL PATTERN COLORWAY)	Includes seat.	Two-tone upholstery uses the highest grade of the two textiles.
	2	BACK (MILL PATTERN COLORWAY)	Includes front & back side of backrest or, in other words, all upholstered parts, but the seat.	

BUILD YOUR MODEL

STEP #	INSTRUCTIONS	PART #	LIST PRICE
1	STARTING LIST BASE MODEL.		
2	SEAT OPTION: REMOVABLE OR FIXED.		
3	CONTROL OPTION.		
4	BASE OPTION.		
4a	CYLINDER OPTION.		
4b	FELT GLIDE OPTION.		
5	EMPHASIZED STITCH OPTION.		
5a	EMPHASIZED STITCH THREAD COLOR.		
UPHOLSTERY OPTION: CHOOSE 4 OR 4a, CHOOSING HIGHEST GRADE FOR LIST PRICE.			
6	SINGLE TEXTILE STANDARD: ADD GRADE, THEN ADD: - (MILL PATTERN COLORWAY)		
	TWO-TONE UPHOLSTERY OPTION: ADD GRADE, THEN ADD: - SEAT (MILL PATTERN COLORWAY)		
6a	- BACK (MILL PATTERN COLORWAY)		
PACKAGING:			
7	STANDARD SHIPPING: CHAIRS SHIP FULLY ASSEMBLED.		
FINAL MODEL NUMBER & TOTAL LIST:			

OR SPEC IT THE EASY WAY

via Design your perfect chair on our online builder: Spec It!
SPEC IT! <http://www.viaseating.com/specit>



specified model #:
927-69C-33BLK-SO-GR 7 (MAHARAM COLLINE 108)

FAQ

1. Can I apply my own thread color in the Emphasized Stitch program?

Yes. Please note, lead time on chairs with custom thread colors can take up to 6 weeks from time of order confirmation depending on the complexity and availability of the thread color specified. Conditions may apply. Please contact 1-800-433-6614 for more information.

2. Can I apply my own color to any of the bases?

Yes. Minimums apply. Additional pricing and conditions apply. Please contact 1-800-433-6614 for more information.

3. What is the best way to maximize on my motion-lounge experience?

For maximum comfort, Via Seating recommends pairing the motion experience: rocking with 360 degree swivel (**70C**) and rocking & swaying with 360 degree swivel (**72C**) with a lounge ottoman. Find ottomans on **pg. 99**.

4. Can I get a fixed seat?

Yes. Please see option 2.

DIMENSIONS & FINISHES

Dimensions and finishes can be found online. Studio V, Via Seating's engineering design team, continuously updates and works with its partners to update Via Seating products to the latest industry advances and to customer feedback. Dimensions, finishes & resources are made available online to allow for real-time updates with the most current data.

Find Meteor information at viaseating.com/series/meteor-chair or scan the QR code to the right →



QR CODE



featured image: MUVMAN-BK-BLACK

features

Breadth of Line: available as a sit-to-stand chair, high sit-to-stand chair, factory sit-to-stand chair or medical sit-to-stand chair.

Seats: available in custom upholstery, Muvman® microfiber and Muvman® Factory black vinyl.

Easy Height Adjustment: Sit or perch on Muvman® with easy. Muvman®'s height adjustment offers 10 inches of travel, lifting the seat up to 33 inches off the ground. To adjust, simply click the buttons located on the left and right side beneath the seat.

Smooth Sideways Movement: Muvman® delivers a wide, hands-free sideways reach. This increases the radius of action and optimizes natural posture at the same time.

Ergonomic Forward Tilt: Muvman®'s 3D joint located close to the ground in the MUVZONE allows for a comfortable, hip-opening, hands-free tilt forward of the Muvman® chair as the user shifts forward. This built-in 4 degree tilt as the user shifts forward, keeps the back in straight, optimal spinal alignment, keeps the chest lifted to enable deep breath and keeps blood circulation stimulated.

SPEC IT! ONLINE CHAIR BUILDER
Yes.
QUICK SHIP MANUFACTURING TIME
20 chairs/48 hours.
MAX WEIGHT RANGE
265 lb.
WARRANTY
3 years.
BIFMA LEVEL
Yes, LEVEL 2.
HEALTHIER HOSPITALS INITIATIVE (HHI)
Yes.
MINDFUL MATERIALS
Yes.
GSA (CONTRACT #: GS-28F-005CA)
No, offered on open market.



design by Henner Jahns

Henner Jahns, founder and lead designer of Gecco Vision (est. 1997), specializes in creating tailor-made office furniture. His company focuses on cultivating a vision into reality. The small design team is seen as an advantage, allowing each member to really focus on the development of something new. The result is numerous, award-winning, seating solutions that stand out.



reddot design award
winner 2011



LOWEST PRICED MODEL: \$959

NOT ON CONTRACT WITH GSA (OPEN MARKET) | MANUFACTURED IN GERMANY

QUICK SHIP SCHEDULES



Code is listed in the starting model. Deviations from this are listed where they occur.

CODE	# MADE	DETAILS
20	20/48	20 Chairs manufactured in 48 hours.
☎	CALL	FOR LEAD TIME: 1-800-433-6614

1. CHOOSE YOUR STARTING LIST BASE MODEL.

PART #	20 MUVMAN	20 MUVMAN_TALL	20 MUVMAN_MEDICAL
STARTING LIST PRICE	\$959	\$999	\$1,059
IMAGE & DIMENSIONS			
STARTING MODEL #	MUVMAN-BK-BLACK	MUVMAN_TALL-BK	MUVMANMEDBLK-GR 1
MAX WEIGHT	265 lb.	265 lb.	265 lb.

2. CHOOSE YOUR BASE FINISH.

PART#	-BK	-GR
PRICE	+\$0	+\$0
IMAGE		
DETAILS	Black base. Includes a dust cover when paired with a factory black vinyl BKV seat.	Grey base.

3. CHOOSE YOUR MICROFIBER OR VINYL SEAT COLOR.

FOR MODEL	USE WITH	All bases.	All bases.	All bases.	All bases.	-BK only
 MUVMAN only	PART#	-BLACK	-GREY	-GREEN	-BLUE	-BKV
	PRICE	+\$0	+\$0	+\$0	+\$0	+\$0
	IMAGE					
	DETAILS	Black microfiber.	Grey microfiber.	Green microfiber.	Royal blue microfiber.	Factory black vinyl.
	EXTENDED DETAILS	Microfiber: 88% polyester, 12% polyurethane. Easy to clean, breathable and hard-wearing. 100,000 Martindale rub				

4. CHOOSE YOUR TEXTILE.

FOR MODEL	PART#	☎ -GR 1	☎ -GR 5
 MUVMAN_MEDICAL only	PRICE	+\$0	+\$205
	APPROVED TEXTILES (MILL PATTERN)	<ul style="list-style-type: none"> MOMENTUM MILLENNIUM SPRADLING SILVERTEX 	<ul style="list-style-type: none"> MAHARAM LARIAT MAHARAM MEDIUM

BUILD YOUR MODEL

STEP #	INSTRUCTIONS	PART #	LIST PRICE
1	STARTING LIST BASE MODEL.		
2	BASE COLOR OPTION.		
3	MUVMAN ONLY: SEAT COLOR OPTION.		
4	MUVMAN_MEDICAL ONLY: ADD GRADE, THEN ADD: - (MILL PATTERN COLORWAY)		

PACKAGING:	
5	STANDARD SHIPPING: CHAIRS SHIP FULLY ASSEMBLED.
FINAL MODEL NUMBER & TOTAL LIST:	

OR SPEC IT THE EASY WAY

via SPEC IT!
Design your perfect chair on our online builder: Spec It!
<http://www.viaseating.com/specit>



featured model #: MUVMAN-GR-BLUE

Orbit

solutions: motion-lounge, lounge, collaborative, lobby, executive guest



featured image: 928-21XB-GR 4 (MOMENTUM FAUX FELT LAGOON)

features

Breadth of Line: soft seating chair and ottomans (Chico & Luna, pg. 83).

Designer Shape: stylish round shape with integrated arms.

Upholstery: option to upholster the seat and back in two different textiles.

Control Mechanisms: choices include motion-lounge rock (back-and-forth rocking movement), sway (side-to-side swaying movement) & 360 degree swivel.

Bases: gorgeous wood, polished or black matte 4-leg base, 5-star swivel bases, a polished disk base and fixed x-bases in black and silver finishes.

Via Seating's comfort foam: a proprietary blend of high-density, injection-molded, closed-cell, cold-cured foam so durable and lasting it is backed by Via Seating's 12 year warranty.

SPEC IT! ONLINE CHAIR BUILDER
Yes.
QUICK SHIP MANUFACTURING TIME
2 chairs/48 hours.
HIGHEST WEIGHT CAPACITY
300 lb.
WARRANTY
6 years.
BIFMA LEVEL
Yes, LEVEL 2.
HEALTHIER HOSPITALS INITIATIVE (HHI)
Yes.
MINDFUL MATERIALS
Yes.
GSA (CONTRACT #: GS-28F-005CA)
Yes, SIN# 711-16.



design by Studio V

Studio V creates modern, sophisticated and original seating solutions that are ergonomic, beautiful and sustainable. This team of engineers, sustainability experts and designers is based in Reno, Nevada. Studio V develops products using a prototyping lab, the latest in 3D modeling software and a materials testing center.



LOWEST PRICED MODEL: \$1,019

GSA SIN #: 711-16 | MANUFACTURED IN U.S.A.

QUICK SHIP SCHEDULES

Code is listed in the starting model. Deviations from this are listed where they occur.

CODE	# MADE	DETAILS
2	2/48	2 Chairs manufactured in 48 hours.
📞	CALL	FOR LEAD TIME: 1-800-433-6614

1. CHOOSE YOUR STARTING LIST BASE MODEL.

PART #	2 928
STARTING LIST PRICE	\$1,019
IMAGE	
STARTING MODEL #	928-69C-18BB-16HP-GR A
COM COL SEAT ONLY	1 yd 9 sq ft •
COM COL BACK ONLY	1.75 yd 28 sq ft •
COM COL WHOLE CHAIR	2.75 yd 37 sq ft •

2. DO YOU WANT A FIXED SEAT?



PART #	-FXD
PRICE	+\$157
DETAILS	The Standard seat is a clean out and removable velcro attached seat. Upcharge is for a permanent, fixed seat.

3. CHOOSE YOUR CONTROL MECHANISM ("MOTION-LOUNGE EXPERIENCE").



USE WITH	PART#	PRICE	DETAILS	MAX WEIGHT
18BB, 18PB, 18BA, 33POL, 33BLK & 3DISK	-69C	+\$0	360 degree swivel.	300 lb.
33POL, 33BLK & 3DISK	-70C	+\$157	Rocking with 360 degree swivel.	300 lb.

4. CHOOSE YOUR BASE TYPE.

DO YOU WANT A 5-STAR SWIVEL BASE WITH ADJUSTABLE HEIGHT?

PART#	PRICE	IMAGE	DETAILS	MATERIAL
-18BB	+\$0		Standard black swivel base with height adjustment handle.	Nylon.
-18PB	+\$114 •		Polished aluminum swivel base with height adjustment handle.	Aluminum.
-18BA	+\$114 •		Brushed aluminum swivel base with height adjustment handle.	Aluminum.

4a. SWIVEL BASES: CHOOSE YOUR CASTERS OR GLIDES.

PART#	PRICE	IMAGE	DETAILS
-16HP	+\$0		Black finish casters are for use on soft/carpeted floors.
-16SCG	+\$29		Grey finish casters are for use on both hard floors & soft/carpeted floors.
-16GL	+\$29		Black finish glides are for use on all floor types.

DO YOU WANT A LOUNGE BASE WITH FIXED HEIGHT AND OPTIONAL SWIVEL?

PART#	PRICE	IMAGE	DETAILS	MATERIAL
-33POL	+\$187		4-leg fixed-height base with a polished finish.	Aluminum.
-33BLK	+\$187		4-leg fixed-height base with a powder-coated matte black finish.	Aluminum.
-3DISK	+\$421		Disk base with a brushed finish.	Steel.





4b. CHOOSE YOUR GAS LIFT FUNCTIONALITY.

PART#	PRICE	DETAILS	NOTE
-SO	+\$0	Non return-to-center.	Cylinder color matches base finish.
-SR	+\$26	Return-to-center.	
-SF	+\$26	Fixed (no swivel).	
-SO	+\$0	Non return-to-center.	Cylinder color matches base finish.
-SR	+\$26	Return-to-center.	
-SF	+\$26	Fixed (no swivel).	
-SO	+\$0	Non return-to-center.	Cylinder color matches base finish.
-SR	+\$26	Return-to-center.	
-SF	+\$26	Fixed (no swivel).	

FIND MORE OPTIONS ON THE FOLLOWING PAGE. →

DO YOU WANT A COMPLETELY FIXED LOUNGE BASE (NO MOTION)?

4c. DO YOU WANT TO ADD A FELT GLIDE?

PART#	PRICE	IMAGE	DETAILS	MATERIAL	NOTE	MAX WEIGHT
-21XB	+\$265		Wire frame fixed-height x base with a matte black finish.	Steel.	Does not include a control mechanism from step 3.	300 lb.
-21XS	+\$308		Wire frame fixed-height x base with a powder-coated silver finish.	Steel.		300 lb.
-5WAL	+\$363		Low profile 4-leg fixed-height wood base with a walnut wood finish.	Wood.	Does not include a control mechanism from step 3. New bases ready October. Pre-order now.	300 lb.
-5OAK	+\$363		Low profile 4-leg fixed-height wood base with an oak wood finish.	Wood.		300 lb.
NOTE	Does not include a control mechanism from step 3.					

PART#	PRICE	DETAILS
-FELT	+\$20	Felt glides.
-FELT	+\$20	Felt glides. NEW!

5. DO YOU WANT TO ADD EMPHASIZED STITCH?

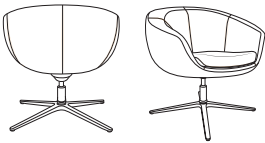
PART #	-CTS
PRICE	+\$0
IMAGE SHOWING CONTRASTING STITCH LINES BOLDED	
NOTE	Standard thread color is a tonal match to the textile(s) selected.

5a. CHOOSE YOUR EMPHASIZED STITCH THREAD COLOR.

PART#	-03	-05	-04	-06	-07	-09	-08	-10
PRICE	+\$0	+\$0	+\$0	+\$0	+\$0	+\$0	+\$0	+\$0
IMAGE								
DETAILS	Black thread.	Grey thread.	White thread.	Cream thread.	Chocolate thread.	Blue thread.	Red thread.	Yellow thread.

6. ADD YOUR TEXTILE GRADE(S).

PART #	PRICE (DEPENDS ON FABRIC GRADE SELECTED)										DETAILS
	A	B	1/COM	2	3/COL	4	5	6	7	8	
928	+\$0	+\$62	+\$127	+\$219	+\$319	+\$426	+\$572	+\$732	+\$995	+\$1298	Orbit chair.
NOTE	Must include mill, pattern and colorway listed after your grade choice in your model #. For COM/COL see pg. 18. We are happy to supply yardage requirement quotes for large quantity chair orders, as material economies may be realized. Please call 1-800-433-6614 or email your customer service manager for assistance.										

6a. DO YOU WANT TWO-TONE UPHOLSTERY? IF YES, PLEASE LIST YOUR TEXTILES IN THIS ORDER:

UPHOLSTERY LAYOUT	ORDER	DETAILS TO ADD TO YOUR MODEL #	IMPORTANT NOTES	PRICING NOTE
	1	SEAT (MILL PATTERN COLORWAY)	Includes seat.	Two-tone upholstery uses the highest grade of the two textiles.
	2	BACK (MILL PATTERN COLORWAY)	Includes front & back side of backrest or, in other words, all upholstered parts, but the seat.	

FIND A QUOTING GUIDE ON THE FOLLOWING PAGE. →

BUILD YOUR MODEL

STEP #	INSTRUCTIONS	PART #	LIST PRICE
1	STARTING LIST BASE MODEL.		
2	SEAT OPTION: REMOVABLE OR FIXED.		
3	CONTROL OPTION.		
4	BASE OPTION.		
4a	CASTERS OR GLIDES OPTION.		
4b	CYLINDER OPTION.		
4c	FELT GLIDE OPTION.		
5	EMPHASIZED STITCH OPTION.		
5a	EMPHASIZED STITCH THREAD COLOR.		
UPHOLSTERY OPTION: CHOOSE 4 OR 4a, CHOOSING HIGHEST GRADE FOR LIST PRICE.			
6	SINGLE TEXTILE STANDARD: ADD GRADE, THEN ADD: - (MILL PATTERN COLORWAY)		
	TWO-TONE UPHOLSTERY OPTION: ADD GRADE, THEN ADD: - SEAT (MILL PATTERN COLORWAY) - BACK (MILL PATTERN COLORWAY)		
PACKAGING:			
7	STANDARD SHIPPING: CHAIRS SHIP FULLY ASSEMBLED.		
FINAL MODEL NUMBER & TOTAL LIST:			

OR SPEC IT THE EASY WAY

via Design your perfect chair on our online builder: Spec It!
SPEC IT! <http://www.viaseating.com/specit>

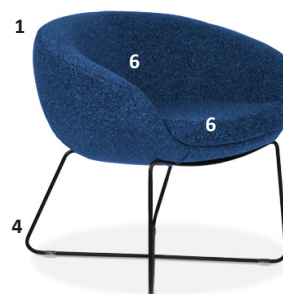

specified model #:

928-21XB-GR 4 (MOMENTUM FAUX FELT LAGOON)

FAQ

1. Can I apply my own thread color in the Emphasized Stitch program?

Yes. Please note, lead time on chairs with custom thread colors can take up to 6 weeks from time of order confirmation depending on the complexity and availability of the thread color specified. Conditions may apply. Please contact 1-800-433-6614 for more information.

2. Can I apply my own color to any of the bases?

Yes. Minimums apply. Additional pricing and conditions apply. Please contact 1-800-433-6614 for more information.

3. What is the best way to maximize on my motion-lounge experience?

For maximum comfort, Via Seating recommends pairing the motion experience: rocking with 360 degree swivel (**70C**) with a lounge ottoman. Find ottomans on **pg. 99**.

4. Can I get a fixed seat?

Yes. Please see option 2.

DIMENSIONS & FINISHES

Dimensions and finishes can be found online. Studio V, Via Seating's engineering design team, continuously updates and works with its partners to update Via Seating products to the latest industry advances and to customer feedback. Dimensions, finishes & resources are made available online to allow for real-time updates with the most current data.

Find Orbit information at viaseating.com/series/orbit-chair or scan the QR code to the right →



QR CODE

Oslo

solutions: executive, management, conference, execu-task



featured image: 7103-10CH-17A-18PB-16SCG-GR 8 (VIA SEATING VIA LEATHERS BLACK 293)

features

Breadth of Line: available as high or mid backs.

Stitching: captivating saddle stitch lines in traditional tuxedo styles.

Arms: choices include ergonomic 8D adjustable arms or executive “C” shape fixed arms in black polyurethane or upholstery.

Control Mechanisms: controls include latest quick adjust advanced synchro (no endless turning of the handle to adjust your backrest to your level of comfort) with choice of an optional 2.5” seat depth adjustment & an optional +3° forward tilt adjustment.

Bases: five-star swivel bases available in black nylon, polished aluminum and brushed aluminum.

Via Seating’s comfort foam: a proprietary blend of high-density, injection-molded, closed-cell, cold-cured foam so durable and lasting it is backed by Via Seating’s 12 year warranty.

SPEC IT! ONLINE CHAIR BUILDER
Yes.
QUICK SHIP MANUFACTURING TIME
10 chairs/48 hours.
HIGHEST WEIGHT CAPACITY
400 lb.
WARRANTY
12 years.
BIFMA LEVEL
Yes.
HEALTHIER HOSPITALS INITIATIVE (HHI)
Yes.
MINDFUL MATERIALS
Yes.
GSA (CONTRACT #: GS-28F-005CA)
Yes, SIN# 711-18.



design by Studio V & Ed Abadie (aba design)

Via Seating’s quintessential execu-task series Linate & Oslo were designed in a collaboration between Studio V and Ed Abadie (ABA Design). These chairs feature Via Seating’s comfort foam, an automobile-inspired, lasting steel framework and hand-manufactured fine stitch work.



Oslo “big & tall”

LOWEST PRICED MODEL: \$1,283



GSA SIN #: 711-18 | MANUFACTURED IN U.S.A.

QUICK SHIP SCHEDULES

Code is listed in the starting model. Deviations from this are listed where they occur.

CODE	# MADE	DETAILS
10	10/48	10 Chairs manufactured in 48 hours.
2	2/48	2 Chairs manufactured in 48 hours.
📞	CALL	FOR LEAD TIME: 1-800-433-6614

1. CHOOSE YOUR STARTING LIST BASE MODEL.

BACK TYPE	Mid back.	High back.
PART #	10 7101	10 7103
STARTING LIST PRICE	\$1,283	\$2,448
IMAGE		
STARTING MODEL #	7101-12C-0A-18BB-16HP-GR A	7103-12C-0A-18BB-16HP-GR A
COM COL CHAIR	2.3 yd 32 sq ft	2.5 yd 39.5 sq ft

2. CHOOSE YOUR CONTROL MECHANISM.







USE WITH	PART#	PRICE	DETAILS	2a. ADD SEAT SLIDE?			2b. ADD FORWARD TILT?			2c. ADD A SHORTER ADJUSTMENT HANDLE?			MAX WEIGHT
				PART #	PRICE	DETAILS	PART #	PRICE	DETAILS	PART #	PRICE	DETAILS	
High back only.	-9CH	+\$0	Synchro control with heavy-duty spring tension.	n/a	n/a	n/a	n/a	n/a	n/a	n/a	n/a	n/a	400 lb.
	-10CH	+\$91	Synchro control with heavy-duty spring tension and a seat slide.		+\$0	Included.	n/a	n/a	n/a	n/a	n/a	n/a	400 lb.
Mid back only.	-12C	+\$0	Single position knee tilt control.	n/a	n/a	n/a	n/a	n/a	n/a	-1CRC	+\$0	Shortened conference adjustment handle.	275 lb.
	-13C	+\$91	Single position knee tilt control and a seat slide.		+\$0	Included.							275 lb.
	-67C	+\$91	Quick adjust advanced synchro control featuring single rotation adjustments.	n/a	n/a	n/a	n/a	n/a	n/a	n/a	n/a	n/a	350 lb.
	-67CSS	+\$182	Quick adjust advanced synchro control featuring single rotation adjustments and a seat slide.		+\$0	Included. Slide the seat +2.5" forward.	-FT	+\$42	+3° of a forward tilt.	n/a	n/a	n/a	350 lb.
NOTE	Discontinuing options 9C & 10C (mid backs) are best replaced by 67C & 67CSS (mid backs), respectively. More details pg. 180.												

3. CHOOSE YOUR ARM TYPE.

DO YOU WANT AN ARMLESS CHAIR?

PART#	PRICE	IMAGE	DETAILS
-0A	+\$0		Armless chairs are standard.

DO YOU WANT TO ADD AN ADJUSTABLE ARM?

PART#	PRICE	IMAGE	DETAILS	3a. CHOOSE YOUR ARM CAP.				3b. ADD AN UPHOLSTERED CAP?		3c. ADD ADJUSTABLE WIDTH?		
				PART #	PRICE	IMAGE	DETAILS	PART#	PRICE	PART#	PRICE	DETAILS
-51A	+\$89		Black polyurethane arm with optional 8-way adjustments.	20S	+\$0		Standard fixed cap.	U	+\$ your textile grade price found in step 5.	-19AB	+\$33	Brackets can adjust the width between arms by 2" per side.
				20R	+\$42		4D rotating cap.					
-53A	+\$150		Polished aluminum arm with optional 8-way adjustments.	20S	+\$0		Standard fixed cap.					
				20R	+\$42		4D rotating cap.					

FIXED ARM OPTIONS ON THE FOLLOWING PAGE. →

DO YOU WANT TO ADD A FIXED ARM?

3d. ADD UPHOLSTERY ON SELECT ARMS.

PART#	PRICE	IMAGE	DETAILS	TEXTILE GRADE PRICE	ARM COM COL
2 -12A	+\$471		Fully upholstered wing arm with a wood interior.	+\$ your textile grade price from step 5.	add 1.15 yd 9.4 sq ft
-13A	+\$144		Black polyurethane classic cantilever arm.	n/a	n/a
2 -14A	+\$322		Fully upholstered classic cantilever arm with a polyurethane interior.	+\$ your textile grade price from step 5.	add 0.75 yd 6.76 sq ft
2 -17A	+\$377		Fully upholstered traditional arm with a wood interior.	+\$ your textile grade price from step 5.	add 1 yd 11.44 sq ft
-80A	+\$216		Black polyurethane executive "C" shape arm.	n/a	n/a
2 -90A	+\$297		Fully upholstered executive "C" shape arm with a polyurethane interior.	+\$ your textile grade price from step 5.	add 1.25 yd 8 sq ft

4. CHOOSE YOUR 5-STAR SWIVEL BASE.

4a. CHOOSE YOUR CASTERS OR GLIDES.

4b. ADD SAFETY-BRAKE CASTERS?

PART#	PRICE	IMAGE	DETAILS
-18BB	+\$0		Standard black nylon base.
-18PB	+\$114		Polished aluminum base.
-18BA	+\$114		Brushed aluminum base.

PART#	PRICE	IMAGE	DETAILS
-16HP	+\$0		Black finish casters are for use on soft/carpeted floors.
-16SCG	+\$29		Grey finish casters are for use on both hard floors & soft/carpeted floors.
-16GL	+\$29		Black finish glides are for use on all floor types.

PART#	PRICE	DETAILS
-SL1	+\$29	This feature locks the casters only when you are not sitting in the chair.
-SL2	+\$29	
n/a	n/a	

5. ADD YOUR TEXTILE GRADE(S).

PART #	PRICE (DEPENDS ON FABRIC GRADE SELECTED)										DETAILS
	A	B	1/COM	2	3/COL	4	5	6	7	8	
7101	+\$0	+\$16	+\$31	+\$102	+\$178	+\$253	+\$336	+\$451	+\$699	+\$1013	Mid back.
7103	+\$0	+\$18	+\$33	+\$165	+\$265	+\$426	+\$687	+\$870	+\$1227	+\$1829	High back.
U	+\$31	+\$31	+\$31	+\$31	+\$31	+\$31	+\$63	+\$63	+\$63	+\$63	Upholstered caps on arms 51A, 52A & 53A.
12A	+\$0	+\$15	+\$35	+\$54	+\$80	+\$114	+\$149	+\$185	+\$226	+\$267	Fully upholstered arm.
14A	+\$0	+\$9	+\$23	+\$35	+\$54	+\$77	+\$101	+\$125	+\$152	+\$182	Fully upholstered arm.
17A	+\$0	+\$9	+\$23	+\$35	+\$54	+\$77	+\$101	+\$125	+\$152	+\$182	Fully upholstered arm.
90A	+\$0	+\$2	+\$4	+\$8	+\$10	+\$18	+\$22	+\$30	+\$41	+\$52	Fully upholstered arm.
NOTE	Must include mill, pattern and colorway listed after your grade choice in your model #. For COM/COL see pg. 18. We are happy to supply yardage requirement quotes for large quantity chair orders, as material economies may be realized. Please call 1-800-433-6614 or email your customer service manager for assistance.										

FIND A QUOTING GUIDE ON THE FOLLOWING PAGE. →

BUILD YOUR MODEL

STEP #	INSTRUCTIONS	PART #	LIST PRICE
1	STARTING LIST BASE MODEL.		
2	CONTROL OPTION.		
2a	SEAT SLIDE OPTION.		
2b	FORWARD TILT OPTION.		
2c	SHORTER CONFERENCE HANDLE OPTION.		
3	ARM OPTION.		
3a	ARM CAP OPTION.		
3b	UPHOLSTERED CAP OPTION.		
3c	ADJUSTABLE WIDTH BRACKET OPTION.		
3d	ARM UPHOLSTERY OPTION.		
4	BASE OPTION.		
4a	CASTER/GLIDE OPTION.		
4b	SAFETY-BRAKE CASTER OPTION.		
UPHOLSTERY:			
5	SINGLE TEXTILE STANDARD: ADD GRADE, THEN ADD:		
	- (MILL PATTERN COLORWAY)		
PACKAGING:			
6	STANDARD SHIPPING: CHAIRS SHIP FULLY ASSEMBLED.		
	CHAIRS SHIP FULLY ASSEMBLED OPTION (ADD PART # -FA AND LIST PRICE \$80/CHAIR).		
	BLANKET WRAPPED OPTION: MINIMUM ORDER OF 150, ADD PART # -BW AND CALL FOR LIST PRICING 1-800-433-6614.		
FINAL MODEL NUMBER & TOTAL LIST:			

OR SPEC IT THE EASY WAY

via[®] Design your perfect chair on our online builder: Spec It!
SPEC IT! <http://www.viaseating.com/specit>



specified model #:

7103-10CH-17A-18PB-16SCG-GR 8

(VIA SEATING VIA LEATHERS BLACK 293)

FAQ

1. Can I place a logo on my chair?

Yes, logos can be applied by embroidery on fabric or screen print on mesh & vinyl. These logos must be placed at least 2" away from the edges of the seat or back. Extended lead time on chairs with logos is 4-6 weeks. Please see **pg. 20**.

DIMENSIONS & FINISHES

Dimensions and finishes can be found online. Studio V, Via Seating's engineering design team, continuously updates and works with its partners to update Via Seating products to the latest industry advances and to customer feedback. Dimensions, finishes & resources are made available online to allow for real-time updates with the most current data.

Find Oslo information at viaseating.com/series/oslo-chairs or scan the QR code to the right →



QR CODE

ottomans

solutions: lounge, collaborative, lobby



featured image: Luna 926-2DISK-SR-GR 4 (MOMENTUM FAUX FELT STONE) | Chico 955-2DISK-SR-GR 4 (MAHARAM MESSENGER LUMINE)

features

Breadth of Line: soft seating ottomans Luna & Chico. Both pair beautifully with Astro, Chico chair, Comet, Edge, Meteor and Orbit chairs.

Upholstery: option to upholster the top and the sides in different textiles.

Bases: a variety of lovely polished, brushed and matte black bases.

Via Seating's comfort foam: a proprietary blend of high-density, injection-molded, closed-cell, cold-cured foam so durable and lasting it is backed by Via Seating's 12 year warranty.

SPEC IT! ONLINE CHAIR BUILDER
Yes, Chico & Luna.
QUICK SHIP MANUFACTURING TIME
5 ottomans/48 hours.
HIGHEST WEIGHT CAPACITY
300 lb.
WARRANTY
6 years.
BIFMA LEVEL
Yes, LEVEL 2.
HEALTHIER HOSPITALS INITIATIVE (HHI)
Yes.
MINDFUL MATERIALS
Yes.
GSA (CONTRACT #: GS-28F-005CA)
Yes, SIN# 711-16.



design by Studio V

Studio V creates modern, sophisticated and original seating solutions that are ergonomic, beautiful and sustainable. This team of engineers, sustainability experts and designers is based in Reno, Nevada. Studio V develops products using a prototyping lab, the latest in 3D modeling software and a materials testing center.



ottomans

LOWEST PRICED MODEL: \$512



GSA SIN #: 711-16 | MANUFACTURED IN U.S.A.

QUICK SHIP SCHEDULES



Code is listed in the starting model. Deviations from this are listed where they occur.

CODE	# MADE	DETAILS
5	5/48	5 ottomans manufactured in 48 hours.
☎	CALL	FOR LEAD TIME: 1-800-433-6614

1. CHOOSE YOUR STARTING LIST BASE MODEL.

PART #	5 926	5 955
STARTING LIST PRICE	\$512	\$627
IMAGE		
DETAILS	Luna style	Chico style
STARTING MODEL #	926-26POL-SR-GR A	955-26POL-SR-GR A
MAX WEIGHT	300 lb.	300 lb.
COM COL TOP	0.50 yd 8 sq ft	0.60 yd 9 sq ft
COM COL SIDES	0.80 yd 13 sq ft	0.15 yd 2.2 sq ft
COM COL OTTOMAN	1 yd 9 sq ft	0.8 yd 9 sq ft

2. CHOOSE YOUR LOUNGE FIXED HEIGHT BASE.

PART#	PRICE	IMAGE (LUNA CHICO)	DETAILS	MATERIAL
-26POL	+\$0		4-leg fixed-height base with a polished finish.	Aluminum.
-26BLK	+\$0		4-leg fixed-height base with a powder-coated matte black finish.	Aluminum.
-2DISK	+\$134		Disk base with a brushed finish.	Steel.

2a. CHOOSE YOUR GAS LIFT FUNCTIONALITY.

PART#	PRICE	DETAILS	NOTE
-SR	+\$0	Return-to-center.	Cylinder color matches base finish.
-SF	+\$26	Fixed (no swivel).	matches base finish.

3. DO YOU WANT TO ADD EMPHASIZED STITCH?

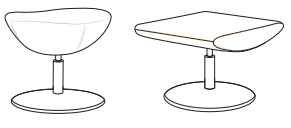
PART #	-CTS
PRICE	+\$0
IMAGE SHOWING CONTRASTING STITCH LINES BOLDED	
NOTE	Standard thread color is a tonal match to the textile(s) selected.



3a. CHOOSE YOUR EMPHASIZED STITCH THREAD COLOR.

PART#	-03	-05	-04	-06	-07	-09	-08	-10
PRICE	+\$0	+\$0	+\$0	+\$0	+\$0	+\$0	+\$0	+\$0
IMAGE								
DETAILS	Black thread.	Grey thread.	White thread.	Cream thread.	Chocolate thread.	Blue thread.	Red thread.	Yellow thread.

4. ADD YOUR TEXTILE GRADE(S).

PART #	PRICE (DEPENDS ON FABRIC GRADE SELECTED)										DETAILS
	A	B	1/COM	2	3/COL	4	5	6	7	8	
926	+\$0	+\$30	+\$63	+\$109	+\$159	+\$212	+\$284	+\$364	+\$495	+\$647	Luna ottoman.
955	+\$0	+\$38	+\$77	+\$134	+\$194	+\$260	+\$349	+\$447	+\$608	+\$793	Chico ottoman.
NOTE	Must include mill, pattern and colorway listed after your grade choice in your model #. For COM/COL see pg. 18. We are happy to supply yardage requirement quotes for large quantity chair orders, as material economies may be realized. Please call 1-800-433-6614 or email your customer service manager for assistance.										

4a. DO YOU WANT TWO-TONE UPHOLSTERY? IF YES, PLEASE LIST YOUR TEXTILES IN THIS ORDER:

UPHOLSTERY LAYOUT	ORDER	DETAILS TO ADD TO YOUR MODEL #	IMPORTANT NOTES
	1	TOP (MILL PATTERN COLORWAY)	Top of the ottoman or "seat".
	2	Chico: WEDGES (MILL PATTERN COLORWAY) Luna: SIDES (MILL PATTERN COLORWAY)	Includes the sides on the Luna ottoman and the front & back wedge on the Chico ottoman.

FIND MORE OPTIONS ON THE FOLLOWING PAGE. →

BUILD YOUR MODEL

STEP #	INSTRUCTIONS	PART #	LIST PRICE
1	STARTING LIST BASE MODEL.		
2	BASE OPTION.		
2a	CYLINDER OPTION.		
UPHOLSTERY OPTION: CHOOSE 4 OR 4a, CHOOSING HIGHEST GRADE FOR LIST PRICE.			
3	SINGLE TEXTILE STANDARD: ADD GRADE, THEN ADD: - (MILL PATTERN COLORWAY)		
	TWO-TONE UPHOLSTERY OPTION: ADD GRADE, THEN ADD: - SEAT (MILL PATTERN COLORWAY) - BACK (MILL PATTERN COLORWAY)		
3a			
4	EMPHASIZED STITCH OPTION.		
4a	EMPHASIZED STITCH THREAD COLOR.		
PACKAGING:			
5	STANDARD SHIPPING: CHAIRS SHIP FULLY ASSEMBLED. WHEN ORDERED WITH A CHAIR, THE OTTOMAN WILL SHIP IN THE SAME BOX AS THE CHAIR.		
FINAL MODEL NUMBER & TOTAL LIST:			

OR SPEC IT THE EASY WAY

via Design your perfect chair on our online builder: Spec It!
SPEC IT! <http://www.viaseating.com/specit>

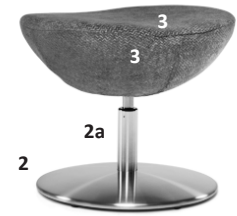

specified model #:

926-2DISK-SR-GR 4 (MOMENTUM FAUX FELT STONE)

FAQ

1. Can I apply my own thread color in the Emphasized Stitch program?

Yes. Please note, lead time on chairs with custom thread colors can take up to 6 weeks from time of order confirmation depending on the complexity and availability of the thread color specified. Conditions may apply. Please contact 1-800-433-6614 for more information.

DIMENSIONS & FINISHES

Dimensions and finishes can be found online. Studio V, Via Seating's engineering design team, continuously updates and works with its partners to update Via Seating products to the latest industry advances and to customer feedback. Dimensions, finishes & resources are made available online to allow for real-time updates with the most current data.

Find Ottomans information at <https://viaseating.com/seating/ottomans/> or scan the QR code to the right →



QR CODE



featured image: 171-67CSS-97A-18PB-16SCG-GR 5 (ULTRAFABRICS PROMESSA[®] ORIGINAL COCOA)

features

Breadth of Line: available as an high and mid backs in mesh and upholstery.

Stitching Patterns: mesh with parallel stitch lines, upholstered with panel stitch lines, upholstered with parallel stitch lines & upholstered with diamond stitch lines.

Arms: featuring sleek, fixed cantilever arms available in polished versions with an optional black cap and multiple adjustable arms including an ergonomic 8D adjustable arm.

Control Mechanisms: controls include latest quick adjust advanced synchro (no endless turning of the handle to adjust your backrest to your level of comfort) with choice of an optional 2.5" seat depth adjustment & an optional +3° forward tilt adjustment & body balance technology.

Bases: five-star swivel bases available in black nylon, polished aluminum and brushed aluminum.

Via Seating's comfort foam: a proprietary blend of high-density, injection-molded, closed-cell, cold-cured foam so durable and lasting it is backed by Via Seating's 12 year warranty.

SPEC IT! ONLINE CHAIR BUILDER
Yes.
QUICK SHIP MANUFACTURING TIME
5-10 chairs/48 hours.
HIGHEST WEIGHT CAPACITY
300 lb.
WARRANTY
12 years, 2 years for mesh.
BIFMA LEVEL
No.
HEALTHIER HOSPITALS INITIATIVE (HHI)
No.
MINDFUL MATERIALS
No.
GSA (CONTRACT #: GS-28F-005CA)
Yes, SIN# 711-18.



design by Studio V

Studio V creates modern, sophisticated and original seating solutions that are ergonomic, beautiful and sustainable. This team of engineers, sustainability experts and designers is based in Reno, Nevada. Studio V develops products using a prototyping lab, the latest in 3D modeling software and a materials testing center.



LOWEST PRICED MODEL: \$680













GSA SIN #: 711-18 | MANUFACTURED IN U.S.A.

QUICK SHIP SCHEDULES

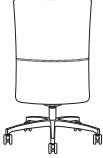
Code is listed in the starting model. Deviations from this are listed where they occur.

CODE	# MADE	DETAILS
10	10/48	10 chairs manufactured in 48 hours.
5	5/48	5 chairs manufactured in 48 hours.
2	2/48	2 chairs manufactured in 48 hours.
📞	CALL	FOR LEAD TIME: 1-800-433-6614

1. CHOOSE YOUR STARTING LIST BASE MODEL.

BACK TYPE →		Mesh.		Upholstered.	
STITCH PATTERN ↓	BACK SIZE →	Mid back.	High back.	Mid back.	High back.
Parallel stitch.  	PART #	10 151	10 152	10 171	10 172
	STARTING LIST PRICE	\$680	\$707	\$876	\$935
	IMAGE				
	STARTING MODEL #	151-25C-0A-18BB-16HP-01PM-11MG-GR A	152-25C-0A-18BB-16HP-01PM-11MG-GR A	171-25C-0A-18BB-16HP-01PM-11MG-GR A	172-25C-0A-18BB-16HP-01PM-11MG-GR A
	COM COL BACK	n/a	n/a	1 yd 13.27 sq ft	1 yd 14.3 sq ft
	COM COL SEAT	0.75 yd 7.2 sq ft	0.75 yd 7.2 sq ft	0.75 yd 7.2 sq ft	0.75 yd 7.2 sq ft
	COM COL CHAIR	0.75 yd 7.2 sq ft	0.75 yd 7.2 sq ft	1.5 yd 20.35 sq ft	1.5 yd 21.8 sq ft
	STITCHING DETAILS	Horizontal: 7 front & 6 back.	Horizontal: 8 front & 6 back.	Horizontal: 6 front (all), 8 back (vinyl & leather), 7 front 8 back (fabric).	Horizontal: 8 front & 8 back.
Panel stitch.  	PART #	n/a		10 161	10 162
	STARTING LIST PRICE			\$876	\$935
	IMAGE				
	STARTING MODEL #			161-25C-0A-18BB-16HP-GR A	162-25C-0A-18BB-16HP-GR A
	COM COL BACK			1 yd 12.6 sq ft	1 yd 13.6 sq ft
	COM COL SEAT			0.75 yd 7.2 sq ft	0.75 yd 7.2 sq ft
	COM COL CHAIR			1.75 yd 20.3 sq ft	2 yd 21.42 sq ft
	STITCHING DETAILS			Horizontal: 1 front & 1 back.	Horizontal: 1 front & 1 back.
Diamond stitch.  	PART #	n/a		5 181	5 182
	STARTING LIST PRICE			\$930	\$990
	IMAGE				
	STARTING MODEL #			181-25C-0A-18BB-16HP-GR 5 LEATHERS ONLY	182-25C-0A-18BB-16HP-GR 5 LEATHERS ONLY
	COL CHAIR			1.5 yd 20.35 sq ft	1.5 yd 21.8 sq ft
	STITCHING DETAILS			Executive diamond pattern.	Executive diamond pattern.

2. DO YOU WANT A FIXED CHAIR BACK?

PART #	F
STARTING PRICE	+\$0
DETAILS	Fixed back option. Standard chair has a height adjustable back feature.

FIND MORE OPTIONS ON THE FOLLOWING PAGE. →

3. CHOOSE YOUR CONTROL MECHANISM.

→ **DO YOU WANT A CHAIR? SELECT YOUR CONTROL.**

3a. ADD SEAT SLIDE?

3b. ADD FORWARD TILT?

USE ON	USE WITH	PART#	PRICE	DETAILS	GASLIFT	PART #	PRICE	DETAILS	PART #	PRICE	DETAILS	MAX WEIGHT
Chairs.	All seats.	-25C	+\$0	Swivel tilt conference control.	G3A: 4.8" travel.	n/a	n/a	n/a	n/a	n/a	n/a	300 lb.
	All seats.	-26C	+\$91	Swivel tilt conference control with seat depth adjustment.	G3A: 4.8" travel.		+\$0	Included.	n/a	n/a	n/a	300 lb.
	All seats.	-67C	+\$65	Quick adjust advanced synchro control featuring single rotation adjustments.	G3A: 4.8" travel.	n/a	n/a	n/a	n/a	n/a	n/a	300 lb.
	All seats.	-67CSS	+\$156	Quick adjust advanced synchro control with seat depth adjustment.	G3A: 4.8" travel.		+\$0	Included.	FT	+\$42	+3° of a forward tilt.	300 lb.
	All seats.	-68C	+\$127	Enhanced body balance control with dynamic fine-tuning.	G3A: 4.8" travel.	-12SS	+\$91	Slide the seat +2.5" forward.	n/a	n/a	n/a	300 lb.
	All seats.	-74C	+\$61	Auto-adjust body balance control.	G3A: 4.8" travel.	-12SS	+\$91		n/a	n/a	n/a	300 lb.

NOTE Discontinuing options 61C, 62C & 66C are best replaced by the latest ergonomic technology 67C, 67CSS & 74C, respectively. More details pg. 180.

→ **DO YOU WANT A STOOL? SELECT YOUR CONTROL AND HEIGHT RANGE.**

USE ON	USE WITH	PART#	PRICE	DETAILS	GASLIFT	MAX WEIGHT	
Stools.	Mid backs.	-35C-11DR	+\$220	Auto-adjust body balance control for stools.		G5: 7.0" travel.	300 lb.
		-35C-11XDR	+\$220	Adds a polished foot ring and extended gas lift with stool height ranges. Available on all bases.		G6: 9.5" travel.	300 lb.

4. CHOOSE YOUR ARM TYPE.

→ **DO YOU WANT AN ARMLESS CHAIR?**















PART#	PRICE	IMAGE	DETAILS
-0A	+\$0		Armless chairs are standard.

→ **DO YOU WANT TO ADD AN ADJUSTABLE ARM?**

4a. CHOOSE YOUR ARM CAP.

4b. ADD AN UPHOLSTERED CAP?







4c. ADD ADJUSTABLE WIDTH?

PART#	PRICE	IMAGE	DETAILS	PART #	PRICE	IMAGE	DETAILS	PART#	PRICE	PART#	PRICE	DETAILS
-10A	+\$89		Black nylon straight upright height adjustable arm.	12	+\$0		Standard fixed cap.	n/a	n/a	-20AB	+\$33	Brackets can adjust the width between arms by 2" per side.
				6	+\$0		Preferred fixed cap.					
-38A	+\$55		Black polyurethane basic height adjustable arm.	12	+\$0		Standard fixed cap.	n/a	n/a	-19AB	+\$33	Brackets can adjust the width between arms by 2" per side.
				6	+\$0		Preferred fixed cap.					
-39A	+\$111		Black nylon height adjustable arm with roll back feature.	12	+\$0		Standard fixed cap.	n/a	n/a	n/a	n/a	n/a
				6	+\$0		Preferred fixed cap.					
-51A	+\$89		Black polyurethane arm with optional 8-way adjustments.	20S	+\$0		Standard fixed cap.	U	+\$ your textile grade price found in step 8.	-19AB	+\$33	Brackets can adjust the width between arms by 2" per side.
				20R	+\$42		4D rotating cap.					
-53A	+\$150		Polished aluminum arm with optional 8-way adjustments.	20S	+\$0		Standard fixed cap.					
				20R	+\$42		4D rotating cap.					

FIXED ARM OPTIONS ON FOLLOWING PAGE. →

DO YOU WANT TO ADD A FIXED ARM?



4d. ADD UPHOLSTERY ON SELECT ARMS.



PART#	PRICE	IMAGE	DETAILS	TEXTILE GRADE PRICE	ARM COM COL
-54A	+\$188		Polished aluminum fixed loop arm.	n/a	n/a
-55A	+\$227		Polished aluminum fixed loop arm with a black polyurethane cap.	n/a	n/a
-59A	+\$129		Black polyurethane fixed loop arm.	n/a	n/a
2 -61A	+\$260		Polished aluminum fixed loop arm with a fully upholstered polyurethane cap.	+\$ your textile grade price from step 8.	add 0.75 yd 1.6 sq ft
-96A	+\$166		Black polyurethane contemporary cantilever arm.	n/a	n/a
-97A	+\$227		Polished aluminum contemporary cantilever arm with a black polyurethane cap.	n/a	n/a

5. CHOOSE YOUR 5-STAR SWIVEL BASE.

5a. CHOOSE YOUR CASTERS OR GLIDES.

5b. ADD SAFETY-BRAKE CASTERS?









PART#	PRICE	IMAGE	DETAILS
-18BB	+\$0		Standard black nylon base.
-18PB	+\$114		Polished aluminum base.
-18BA	+\$114		Brushed aluminum base.

PART#	PRICE	IMAGE	DETAILS
-16HP	+\$0		Black finish casters are for use on soft/carpeted floors.
-16SCG	+\$29		Grey finish casters are for use on both hard floors & soft/carpeted floors.
-16GL	+\$29		Black finish glides are for use on all floor types.

PART#	PRICE	DETAILS
-SL1	+\$29	This feature locks the casters only when you are not sitting in the chair.
-SL2	+\$29	
n/a	n/a	

6. CHOOSE YOUR MESH COLOR.



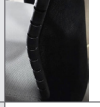



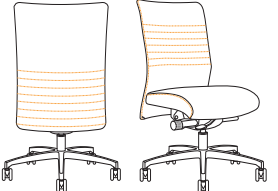
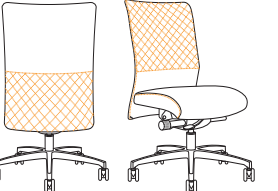

6a. STANDARD MESH GUARDS.

USE WITH	PART#	-01PM	-02PM	-03PM	-04PM	-06PM	-08PM	-09PM	PART#	-11MG
 Mesh back chairs.	PRICE	+\$0	+\$0	+\$0	+\$0	+\$0	+\$0	+\$0	PRICE	+\$0
	IMAGE								IMAGE	
	DETAILS	Standard black.	Blue.	Graphite.	Cardinal red.	Lime green.	Orange.	Dark chocolate.	DETAILS	These guards come standard at NO UPCHARGE on knit mesh backs.

7. DO YOU WANT TO ADD CONTRASTING STITCH?

PART #	-CTS
PRICE	+\$0
WORKS ON	Panel stitch, models 161 & 162 Parallel stitch, models 171 & 172 Diamond stitch, models 181 & 182
IMAGE SHOWING CONTRASTING STITCH LINES IN ORANGE	  
CONDITIONS	Works best with leathers. Works on select fabrics & vinyls.

7a. CHOOSE YOUR EMPHASIZED STITCH THREAD COLOR.

PART#	-03	-05	-04	-06	-07	-09	-08	-10
PRICE	+\$0	+\$0	+\$0	+\$0	+\$0	+\$0	+\$0	+\$0
IMAGE								
DETAILS	Black thread.	Grey thread.	White thread.	Cream thread.	Chocolate thread.	Blue thread.	Red thread.	Yellow thread.

FIND MORE OPTIONS ON THE FOLLOWING PAGE. →

8. ADD YOUR TEXTILE GRADE(S).

PART #	PRICE (DEPENDS ON FABRIC GRADE SELECTED)										DETAILS
	A	B	1/COM	2	3/COL	4	5	6	7	8	
151 & 152	+\$0	+\$11	+\$38	+\$54	+\$79	+\$116	+\$155	+\$213	+\$276	+\$355	Mesh mid backs & high backs.
161, 171 & 181	+\$0	+\$29	+\$100	+\$142	+\$213	+\$311	+\$410	+\$565	+\$735	+\$946	Upholstered mid backs.
162, 172 & 182	+\$0	+\$31	+\$111	+\$159	+\$238	+\$349	+\$460	+\$634	+\$826	+\$1064	Upholstered high backs.
U	+\$31	+\$31	+\$31	+\$31	+\$31	+\$31	+\$63	+\$63	+\$63	+\$63	Upholstered caps on arms 51A, 52A & 53A .
61A	+\$0	+\$0	+\$0	+\$0	+\$0	+\$0	+\$33	+\$33	+\$33	+\$33	Polished loop arm with upholstered cap.
NOTE	Must include mill, pattern and colorway listed after your grade choice in your model #: For COM/COL see pg. 18. We are happy to supply yardage requirement quotes for large quantity chair orders, as material economies may be realized. Please call 1-800-433-6614 or email your customer service manager for assistance. Executive diamond stitch (181 & 182) is best paired with leathers. For testing on fabrics & vinyl, please contact your customer service manager.										

8a. DO YOU WANT TO USE MULTIPLE TEXTILES ON YOUR CHAIR? IF YES, PLEASE LIST YOUR TEXTILES IN THIS ORDER:

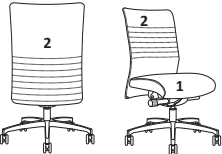
UPHOLSTERY LAYOUT	USE WITH	ORDER	DETAILS TO ADD TO YOUR MODEL #	IMPORTANT NOTES
	Panel stitch models: 161 & 162	1	SEAT (PATTERN COLORWAY)	Seat textile will be applied to a selected 20SU or 20RU arm cap and 61A .
	Parallel stitch models: 171 & 172	2	BACK (PATTERN COLORWAY)	

BUILD YOUR MODEL

STEP #	INSTRUCTIONS	PART #	LIST PRICE
1	STARTING LIST BASE MODEL.		
2	FIXED BACK OPTION (ADJUSTABLE IS STANDARD).		
3	CONTROL OPTION.		
3a	SEAT SLIDE OPTION.		
3b	FORWARD TILT OPTION.		
3c	STOOL KIT OPTION.		
4	ARM OPTION.		
4a	ARM CAP OPTION.		
4b	UPHOLSTERED CAP OPTION.		
4c	ADJUSTABLE WIDTH BRACKET OPTION.		
4d	ARM UPHOLSTERY OPTION.		
5	BASE OPTION.		
5a	CASTER/GLIDE OPTION.		
5b	SAFETY-BRAKE CASTER OPTION.		
6	MESH COLOR.		
6a	MESH GUARDS (STANDARD ON MESH).		
7	EMPHASIZED STITCH OPTION.		
7a	EMPHASIZED STITCH THREAD COLOR.		
UPHOLSTERY OPTION: CHOOSE 8 OR 8a, CHOOSING HIGHEST GRADE FOR LIST PRICE.			
8	SINGLE TEXTILE STANDARD: ADD GRADE, THEN ADD: - (MILL PATTERN COLORWAY)		
8a	UPHOLSTERED BACKS: TWO-TONE UPHOLSTERY OPTION: ADD GRADE, THEN ADD:		
	- SEAT (MILL PATTERN COLORWAY)		
	- BACK (MILL PATTERN COLORWAY)		

PACKAGING:			
9	STANDARD SHIPPING: CHAIRS SHIP 95% ASSEMBLED. NO TOOLS REQUIRED.		
	CHAIRS SHIP FULLY ASSEMBLED OPTION (ADD PART # -FA AND LIST PRICE \$80/CHAIR).		
	BLANKET WRAPPED OPTION: MINIMUM ORDER OF 150, ADD PART # -BW AND CALL FOR LIST PRICING 1-800-433-6614.		

FINAL MODEL NUMBER & TOTAL LIST:		
----------------------------------	--	--

OR SPEC IT THE EASY WAY

via Design your perfect chair on our online builder: Spec It!
SPEC IT! <http://www.viaseating.com/specit>



specified model #:
171-67CSS-97A-18PB-16SCG-GR 5
(ULTRAFABRICS PROMESSA® ORIGINAL COCOA)

FAQ

1. Can I place a logo on my chair?

Yes, logos can be applied by embroidery on select fabric/vinyl/leather. These logos must be placed at least 2" away from the edges and all stitch lines of the seat or back. Extended lead time on chairs with logos is 4-6 weeks. Please see **pg. 20**.

2. Do the panel, parallel & diamond stitch patterns work with any fabrics & vinyls (ie. anything other than leathers)?

Yes! Please view our materials library at viaseating.com/materials/ for approved fabrics & vinyls. To test COM/COL, please call your customer service specialist at 1-800-433-6614 (press 1).

3. Can the forward tilt feature on the **67CSS** go on the **67C**?

No. The **67CSS-FT** is Via Seating's latest full function ergonomic control option delivering both a 3° forward tilt and a 2.5" seat slide.

DIMENSIONS & FINISHES

Dimensions and finishes can be found online. Studio V, Via Seating's engineering design team, continuously updates and works with its partners to update Via Seating products to the latest industry advances and to customer feedback. Dimensions, finishes & resources are made available online to allow for real-time updates with the most current data.



QR CODE

Find Proform® information at viaseating.com/series/proform-chairs or scan the QR code to the right →

Reset

solutions: multi-use, nesting, side/guest, light task chair & stool



featured images: nesting chair 350-DG-RA1G-16HP-2RE-GR 4 (MAHARAM MEDIUM SCULPTURE) & nested group 350-DG-RA1G-16HP-2RE-GR 1 (MOMENTUM FUSE LUNAR)

features

Breadth of Line: nesting chair, light task chair and light task stool.

Flex Back: Reset's framework allows for a comfortable 22 degrees of flex back at the hip. The smooth and supportive flex feature allows the back to relax and lifts the chest enabling deep breath.

Mesh: offering choices in standard, high-performance, 4-way elastomeric mesh or biocidal, first-to-market, patent-pending, copper mesh in natural copper and black copper, perfect for healthcare environments as well as improving hygiene in shared desk situations.

Arms: armless or choice of integrated, fixed arms in black or magnet grey finishes.

Bases: five-star swivel bases available in black nylon, magnet grey nylon, polished aluminum and brushed aluminum. The 4-leg nesting chair is available in a black or magnet grey finish.

Via Seating's comfort foam: a proprietary blend of high-density, injection-molded, closed-cell, cold-cured foam in the seat so durable and lasting, it is backed by Via Seating's 12 year warranty.

SPEC IT! ONLINE CHAIR BUILDER
Yes.
QUICK SHIP MANUFACTURING TIME
20 chairs/48 hours.
HIGHEST WEIGHT CAPACITY
300 lb.
WARRANTY
12 years, 5 years for mesh.
BIFMA LEVEL
Yes, LEVEL 2.
HEALTHIER HOSPITALS INITIATIVE (HHI)
Yes.
MINDFUL MATERIALS
Yes.
GSA (CONTRACT #: GS-28F-005CA)
Yes, SIN# 711-18.



design by Studio V

Studio V creates modern, sophisticated and original seating solutions that are ergonomic, beautiful and sustainable. This team of engineers, sustainability experts and designers is based in Reno, Nevada. Studio V develops products using a prototyping lab, the latest in 3D modeling software and a materials testing center.



Reset

LOWEST PRICED MODEL: \$496



GSA SIN #: 711-19 | MANUFACTURED IN U.S.A.

QUICK SHIP SCHEDULES



Code is listed in the starting model. Deviations from this are listed where they occur.

CODE	# MADE	DETAILS
20	20/48	20 Chairs manufactured in 48 hours.
📞	CALL	FOR LEAD TIME: 1-800-433-6614

1. CHOOSE YOUR STARTING LIST BASE MODEL.

CHAIR TYPE	Nesting 4-leg chair.	Light task chair.
PART #	20 350	20 352
STARTING LIST PRICE	\$496	\$588
IMAGE		
STARTING MODEL #	350-B-0A-16HP-01RE-GR A	352-B-0A-18BB-16HP-01RE-GR A
SHIPS	4 per box.	1 per box.
COM COL SEAT	0.75 yd 8.4 sq ft	0.75 yd 8.4 sq ft
MAX WEIGHT	300 lb.	300 lb.

2. CHOOSE YOUR FRAME FINISH.



PART#	-B	-DG
PRICE	+\$0	+\$31
IMAGE		
DETAILS	Standard matte black.	Magnet grey.

3. CHOOSE YOUR ARM TYPE.





DO YOU WANT AN ARMLESS CHAIR?

PART#	PRICE	IMAGE	DETAILS
-0A	+\$0		Armless chairs are standard.

DO YOU WANT TO ADD AN FIXED ARM?





USE WITH	PART#	PRICE	IMAGE	DETAILS
-B standard black frame only.	-RA1B	+\$21		Matte black polyurethane loop arm. Arm is fixed to frame.
-G magnet grey frame only.	-RA1G	+\$21		Matte magnet grey loop arm. Arm is fixed to frame.

4. CHOOSE YOUR LIGHT TASK 5-STAR SWIVEL BASE.

FOR MODEL	PART#	PRICE	IMAGE	DETAILS
 352 only.	-18BB	+\$0		26" black nylon base. Standard option for black frames.
	-18GB	+\$0		26" magnet grey nylon base. Standard option for magnet grey frames.
	-18PB	+\$114		26" polished aluminum base.
	-18BA	+\$114		26" brushed aluminum base.



FIND MORE OPTIONS ON THE FOLLOWING PAGE. →

4a. CHOOSE YOUR CASTERS OR GLIDES.

USE WITH	PART#	PRICE	IMAGE	DETAILS	PART#	PRICE	DETAILS
 350 & 352.	-16HP	+\$0		Standard black finish casters are for use on soft/carpeted floors.	-SL1	+\$29	This feature locks the casters only when you are not sitting in the chair.
	-16SCG	+\$29		Grey finish casters are for use on both hard floors & soft/carpeted floors.	-SL2	+\$29	
	-16GL	+\$29		Black finish glides are for use on all floor types.	n/a	n/a	n/a

4b. ADD SAFETY-BRAKE CASTERS?

4c. DO YOU WANT TO MAKE YOUR CHAIR A LIGHT TASK STOOL?

USE WITH	FOR BASES	PART #	PRICE	IMAGE	STOOL KIT OPTION
 352 only.	18BB, 18GB, 18PB, 18BA only.	-11DR	+\$156		Tall stool kit (extended gas lift & a footring footrest) gives 7 in of vertical travel.
		-11XDR	+\$156		Extra-tall stool kit (extended gas lift & a footring footrest) gives 9 in of vertical travel.

5. CHOOSE YOUR MESH COLOR.

PART#	-01RE	-02RE	-03RE	-04RE	-05RE	-06RE	-08RE	-11RE	-12RE
PRICE	+\$0	+\$0	+\$0	+\$0	+\$0	+\$0	+\$0	+\$43	+\$43
IMAGE									
DETAILS	Black.	Silver.	Blue.	Orange.	Green.	Cardinal red.	Coffee.	Black copper.	Natural copper.

6. ADD YOUR TEXTILE GRADE(S).

PART #	PRICE (DEPENDS ON FABRIC GRADE SELECTED)										DETAILS
	A	B	1/COM	2	3/COL	4	5	6	7	8	
All chairs.	+\$0	+\$31	+\$65	+\$112	+\$162	+\$216	+\$289	+\$370	+\$503	+\$655	All chairs.
NOTE	Must include mill, pattern and colorway listed after your grade choice in your model #. For COM/COL see pg. 18. We are happy to supply yardage requirement quotes for large quantity chair orders, as material economies may be realized. Please call 1-800-433-6614 or email your customer service manager for assistance.										

BUILD YOUR MODEL

STEP #	INSTRUCTIONS	PART #	LIST PRICE
1	STARTING LIST BASE MODEL.		
2	FRAME FINISH OPTION.		
3	ARM OPTION.		
4	BASE OPTION.		
4a	CASTER/GLIDE OPTION.		
4b	SAFETY-BRAKE CASTER OPTION.		
4c	STOOL KIT OPTION.		
5	MESH COLOR OPTION.		
UPHOLSTERY:			
6	SINGLE TEXTILE STANDARD: ADD GRADE, THEN ADD: - (MILL PATTERN COLORWAY)		
PACKAGING:			
7	STANDARD SHIPPING: MODEL 350 CHAIRS SHIP FULLY ASSEMBLED. MODEL 352 CHAIRS SHIP 95% ASSEMBLED. NO TOOLS REQUIRED.		
	MODEL 352 : CHAIRS SHIP FULLY ASSEMBLED OPTION (ADD PART # -FA AND LIST PRICE \$80/CHAIR).		
	BLANKET WRAPPED OPTION: MINIMUM ORDER OF 150, ADD PART # -BW AND CALL FOR LIST PRICING 1-800-433-6614.		
FINAL MODEL NUMBER & TOTAL LIST:			

OR SPEC IT THE EASY WAY

via Design your perfect chair on our online builder: Spec It!
SPEC IT! <http://www.viaseating.com/specit>



featured model #:
 350-DG-RA1G-16HP-2RE-GR 4
 (MAHARAM MEDIUM SCULPTURE)

FAQ

1. Can I place a logo on my chair?

Yes, logos can be applied by embroidery on fabric or screen print on mesh & vinyl. These logos must be placed at least 2" away from the edges of the seat or back. Extended lead time on chairs with logos is 4-6 weeks. Please see **pg. 20**.

DIMENSIONS & FINISHES

Dimensions and finishes can be found online. Studio V, Via Seating's engineering design team, continuously updates and works with its partners to update Via Seating products to the latest industry advances and to customer feedback. Dimensions, finishes & resources are made available online to allow for real-time updates with the most current data.

Find Reset information at viaseating.com/series/reset-chairs or scan the QR code to the right →



QR CODE



featured image: 4R12-67CSS-18A4-18BB-16HP-03H-11MG-GR A (MOMENTUM ORIGIN IRON)

features

Breadth of Line: high back and mid backs with fixed and ratchet, mesh and upholstered backs.

Seats: offering three seat sizes: standard to large. Mesh backs are available with tailored seats featuring a distinct stitch line down the center or enhanced comfort seats.

Arms: ergonomic adjustable height arm featuring a sleek, textured large cap and optional arm width adjustment available in black or magnet grey finish including a unique roll-back arm.

Control Mechanisms: full function ergonomic synchro control mechanism with easy to use side tension adjustment.

Bases: five-star swivel bases available in black nylon, polished aluminum and brushed aluminum.

Via Seating's comfort foam: a proprietary blend of high-density, injection-molded, closed-cell, cold-cured foam so durable and lasting it is backed by Via Seating's 12 year warranty.

SPEC IT! ONLINE CHAIR BUILDER
Yes.
QUICK SHIP MANUFACTURING TIME
20 chairs/48 hours.
HIGHEST WEIGHT CAPACITY
300 lb.
WARRANTY
12 years, 2 years for mesh.
BIFMA LEVEL
Yes, LEVEL 2.
HEALTHIER HOSPITALS INITIATIVE (HHI)
Yes.
MINDFUL MATERIALS
Yes.
GSA (CONTRACT #: GS-28F-005CA)
Yes, SIN# 711-18.



design by Studio V

Studio V creates modern, sophisticated and original seating solutions that are ergonomic, beautiful and sustainable. This team of engineers, sustainability experts and designers is based in Reno, Nevada. Studio V develops products using a prototyping lab, the latest in 3D modeling software and a materials testing center.



Riva

LOWEST PRICED MODEL: \$579













GSA SIN #: 711-18 | MANUFACTURED IN U.S.A.

QUICK SHIP SCHEDULES

Code is listed in the starting model. Deviations from this are listed where they occur.

CODE	# MADE	DETAILS
20	20/48	20 Chairs manufactured in 48 hours.
10	10/48	10 Chairs manufactured in 48 hours.
2	2/48	2 Chairs manufactured in 48 hours.
📞	CALL	FOR LEAD TIME: 1-800-433-6614

1. CHOOSE YOUR STARTING LIST BASE MODEL.

BACK TYPE ↓	BACK SIZE ↓	SEAT SIZE →	Standard A seat.		Medium B seat.		Large C seat.						
		SEAT STYLE →	Enhanced comfort.		Enhanced comfort.		Enhanced comfort.						
Upholstered chair.	Mid back.	PART #	20 3403		20 3603		20 3803						
		STARTING LIST PRICE	\$579		\$670		\$761						
		IMAGE											
		STARTING MODEL #	3403-25C-0A-18BB-16HP-01H-GR A		3603-25C-0A-18BB-16HP-01H-GR A		3803-25C-0A-18BB-16HP-01H-GR A						
		COM COL CHAIR	1 yd 14.17 sq ft		1 yd 16.1 sq ft		1 yd 16.1 sq ft						
Mesh chair.	Mid back.	SEAT STYLE →	Tailored.		Enhanced comfort.		Tailored.		Enhanced comfort.				
		PART #	20 2R12		20 4R12		20 2R22		20 4R22				
		STARTING LIST PRICE	\$713		\$718		\$769		\$786				
		IMAGE											
		STARTING MODEL #	2R12-25C-0A-18BB-16HP-01H-11MG-GR A		4R12-25C-0A-18BB-16HP-01H-11MG-GR A		2R22-25C-0A-18BB-16HP-01H-11MG-GR A		4R22-25C-0A-18BB-16HP-01H-11MG-GR A		2R32-25C-0A-18BB-16HP-01H-11MG-GR A		
		COM COL CHAIR	0.75 yd 8.6 sq ft		0.75 yd 7.25 sq ft		0.75 yd 8.2 sq ft		0.75 yd 8.4 sq ft		0.75 yd 8.6 sq ft		
	High back.		PART #	20 2R14		20 4R14		20 2R24		20 4R24			
			STARTING LIST PRICE	\$849		\$854		\$905		\$922			
			IMAGE										
			STARTING MODEL #	2R14-25C-0A-18BB-16HP-01H-11MG-GR A		4R14-25C-0A-18BB-16HP-01H-11MG-GR A		2R24-25C-0A-18BB-16HP-01H-11MG-GR A		4R24-25C-0A-18BB-16HP-01H-11MG-GR A		2R34-25C-0A-18BB-16HP-01H-11MG-GR A	
			COM COL CHAIR	0.75 yd 8.6 sq ft		0.75 yd 7.25 sq ft		0.75 yd 8.2 sq ft		0.75 yd 8.4 sq ft		0.75 yd 8.6 sq ft	

2. DO YOU WANT A FIXED MESH BACK?

USE ON	PART #	-F
	STARTING PRICE	+\$0
	DETAILS	Fixed mesh back option. Standard mesh back chair has a height adjustable back feature.
	Mesh back chairs.	

FIND MORE OPTIONS ON THE FOLLOWING PAGE. →

3. CHOOSE YOUR CONTROL MECHANISM.

→ DO YOU WANT A CHAIR? SELECT YOUR CONTROL.

3a. ADD SEAT SLIDE?

3b. ADD FORWARD TILT?

USE ON	USE WITH	PART#	PRICE	DETAILS	GASLIFT	PART #	PRICE	DETAILS	PART #	PRICE	DETAILS	MAX WEIGHT
Chairs.	All seats.	-25C	+\$0	Swivel tilt conference control.	G3A: 4.8" travel.	n/a	n/a	n/a	n/a	n/a	n/a	300 lb.
	All seats.	-26C	+\$91	Swivel tilt conference control with seat depth adjustment.	G3A: 4.8" travel.		+\$0	Included. +/- 2.0"	n/a	n/a	n/a	300 lb.
	All seats.	-67C	+\$65	Quick adjust advanced synchro control featuring single rotation adjustments.	G3A: 4.8" travel.	n/a	n/a	n/a	n/a	n/a	n/a	300 lb.
	All seats.	-67CSS	+\$156	Quick adjust advanced synchro control with seat depth adjustment.	G3A: 4.8" travel.		+\$0	Included. +/- 2.5"	Ⓜ -FT	+\$42	+3° of a forward tilt.	300 lb.
NOTE	Discontinuing options 61C & 62C are best replaced by the latest ergonomic technology 67C & 67CSS, respectively. More details pg. 180.											

→ DO YOU WANT A STOOL? SELECT YOUR CONTROL AND HEIGHT RANGE.

USE ON	USE WITH	PART#	PRICE	DETAILS	GASLIFT	MAX WEIGHT	
Stools.	• Mid backs with A & B seats.	-35C-11DR	+\$220	Auto-adjust body balance control for stools.		G5: 7.0" travel.	300 lb.
		-35C-11XDR	+\$220	Adds a polished foot ring and extended gas lift with stool height ranges. Available on all bases.		G6: 9.5" travel.	300 lb.

4. CHOOSE YOUR ARM TYPE.

→ DO YOU WANT AN ARMLESS CHAIR?















PART#	PRICE	IMAGE	DETAILS
-0A	+\$0		Armless chairs are standard.

→ DO YOU WANT TO ADD AN ADJUSTABLE ARM?

4a. CHOOSE YOUR ARM CAP.



4b. ADD AN UPHOLSTERED CAP?

4c. ADD ADJUSTABLE WIDTH?

PART#	PRICE	IMAGE	DETAILS	PART #	PRICE	IMAGE	DETAILS	PART#	PRICE	PART#	PRICE	DETAILS
-18A	+\$121		Black nylon full function arm with arm width adjustment included.	4	+\$0		Standard fixed cap.	n/a		-20AB	+\$0	Brackets can adjust the width between arms by 2" per side. Included on arm 18A.
				6	+\$0		Preferred fixed cap.					
-38A	+\$55		Black nylon basic height adjustable arm.	4	+\$0		Standard fixed cap.	n/a	n/a	-19AB	+\$33	
				6	+\$0		Preferred fixed cap.					
-39A	+\$111		Black nylon height adjustable arm with roll back feature.	4	+\$0		Standard fixed cap.	n/a	n/a	n/a	n/a	
				6	+\$0		Preferred fixed cap.					
-51A	+\$89		Black polyurethane arm with optional 8-way adjustments.	20S	+\$0		Standard fixed cap.	U	+\$ your textile grade price found in step 9.	-19AB	+\$33	Brackets can adjust the width between arms by 2" per side.
				20R	+\$42		4D rotating cap.					
-53A	+\$150		Polished aluminum arm with optional 8-way adjustments.	20S	+\$0		Standard fixed cap.					
				20R	+\$42		4D rotating cap.					



→ DO YOU WANT TO ADD A FIXED ARM?

3d. ADD UPHOLSTERY ON SELECT ARMS.



PART#	PRICE	IMAGE	DETAILS	TEXTILE GRADE PRICE	ARM COM COL
-80A	+\$216		Black polyurethane executive "C" shape arm.	n/a	n/a
② -90A	+\$297		Fully upholstered executive "C" shape arm with a polyurethane interior.	+\$ your textile grade price from step 9.	add 1.25 yd 8 sq ft

FIND MORE OPTIONS ON THE FOLLOWING PAGE. →

5. CHOOSE YOUR 5-STAR SWIVEL BASE.

PART#	PRICE	IMAGE	DETAILS
-18BB	+\$0		Standard black nylon base.
-18PB	+\$114		Polished aluminum base.
-18BA	+\$114		Brushed aluminum base.

5a. CHOOSE YOUR CASTERS OR GLIDES.

PART#	PRICE	IMAGE	DETAILS
-16HP	+\$0		Black finish casters are for use on soft/carpeted floors.
-16SCG	+\$29		Grey finish casters are for use on both hard floors & soft/carpeted floors.
-16GL	+\$29		Black finish glides are for use on all floor types.

5b. ADD SAFETY-BRAKE CASTERS?

PART#	PRICE	DETAILS
-SL1	+\$29	This feature locks the casters only when you are not sitting in the chair.
-SL2	+\$29	
n/a	n/a	

6. CHOOSE YOUR MESH COLOR.

USE WITH	PART#	-01H	 -02H	-03H	 -04H	 -06H	 -08H	 -09H	PART#	-11MG
 Mesh back chairs.	PRICE	+\$0	+\$0	+\$0	+\$0	+\$0	+\$0	+\$0	PRICE	+\$0
	IMAGE								IMAGE	
	DETAILS	Standard black.	Blue.	Graphite.	Cardinal red.	Lime green.	Orange.	Dark chocolate.	DETAILS	These guards come standard at NO UPCHARGE on knit mesh backs.

6a. STANDARD MESH GUARDS.

7. DO YOU WANT TO ADD ADJUSTABLE LUMBAR SUPPORT?

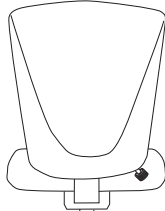
USE WITH	PART#	PRICE	IMAGE	DETAILS
 Upholstered back chairs.	-12LUM	+\$114		Mechanical, internal lumbar support, which is adjusted by turning a dial. Clockwise = more support Counter-clockwise = less support

8. DO YOU WANT TO ADD UPHOLSTERY TO THE BACK OF THE CHAIR (IE. "BACK SHELL")?

USE WITH	PART#	PRICE	10 -22UBF	10 -22UBL	NOTE
 Upholstered back chairs.	PRICE	+\$0	+\$152	+\$180	Upholstered shells match the overall chair upholstery by default.
	DETAILS	Standard plastic backshell.	An upholstered backshell for fabrics & vinyls.	An upholstered backshell for leathers.	

9. ADD YOUR TEXTILE GRADE(S).

PART #	PRICE (DEPENDS ON FABRIC GRADE SELECTED)										DETAILS
	A	B	1/COM	2	3/COL	4	5	6	7	8	
4R12 & 4R14	+\$0	+\$11	+\$36	+\$54	+\$85	+\$118	+\$160	+\$213	+\$278	+\$361	Mesh backs, Tailored A seats.
2R12 & 2R14	+\$0	+\$22	+\$46	+\$86	+\$139	+\$222	+\$358	+\$478	+\$595	+\$711	Mesh backs, Enhanced Comfort A seats.
4R22, 4R24, 4R32 & 4R34	+\$0	+\$17	+\$47	+\$71	+\$111	+\$158	+\$213	+\$283	+\$371	+\$481	Mesh backs, Tailored B & C seats.
2R32, 4R32, 2R34 & 4R34	+\$0	+\$26	+\$56	+\$102	+\$164	+\$261	+\$412	+\$548	+\$686	+\$831	Mesh backs, Enhanced Comfort B & C seats.
3403, 3603 & 3803	+\$0	+\$17	+\$47	+\$71	+\$111	+\$158	+\$213	+\$283	+\$371	+\$481	Upholstered mid backs, all seats.
U	+\$31	+\$31	+\$31	+\$31	+\$31	+\$31	+\$63	+\$63	+\$63	+\$63	Upholstered caps on arms 51A, 52A & 53A.
90A	+\$0	+\$2	+\$4	+\$8	+\$10	+\$18	+\$22	+\$30	+\$41	+\$52	Executive "C" shape arm.
NOTE	Must include mill, pattern and colorway listed after your grade choice in your model #. For COM/COL see pg. 18. We are happy to supply yardage requirement quotes for large quantity chair orders, as material economies may be realized. Please call 1-800-433-6614 or email your customer service manager for assistance.										

BUILD YOUR MODEL

STEP #	INSTRUCTIONS	PART #	LIST PRICE
1	STARTING LIST BASE MODEL.		
2	FIXED BACK OPTION (ADJUSTABLE IS STANDARD).		
3	CONTROL OPTION.		
3a	SEAT SLIDE OPTION.		
3b	FORWARD TILT OPTION.		
3c	STOOL KIT OPTION.		
3d	SHORTER CONFERENCE HANDLE OPTION.		
4	ARM OPTION.		
4a	ARM CAP OPTION.		
4b	UPHOLSTERED CAP OPTION.		
4c	ADJUSTABLE WIDTH BRACKET OPTION.		
4d	ARM UPHOLSTERY OPTION.		
5	BASE OPTION.		
5a	CASTER/GLIDE OPTION.		
5b	SAFETY-BRAKE CASTER OPTION.		
6	MESH COLOR.		
6a	MESH GUARDS (STANDARD ON MESH).		
7	ADJUSTABLE LUMBAR SUPPORT OPTION.		
UPHOLSTERY:			
8	SINGLE TEXTILE STANDARD: ADD GRADE, THEN ADD: - (MILL PATTERN COLORWAY)		

PACKAGING:			
9	STANDARD SHIPPING: CHAIRS SHIP 95% ASSEMBLED. NO TOOLS REQUIRED.		
	CHAIRS SHIP FULLY ASSEMBLED OPTION (ADD PART # -FA AND LIST PRICE \$80/CHAIR).		
	BLANKET WRAPPED OPTION: MINIMUM ORDER OF 150, ADD PART # -BW AND CALL FOR LIST PRICING 1-800-433-6614.		

FINAL MODEL NUMBER & TOTAL LIST:		
----------------------------------	--	--

OR SPEC IT THE EASY WAY

via
SPEC IT! Design your perfect chair on our online builder: Spec It!
<http://www.viaseating.com/specit>



specified model #:

4R12-67CSS-18A4-18BB-16HP-03H-11MG-GR A (MOMENTUM ORIGIN IRON)

FAQ

1. Can I place a logo on my chair?

Yes, logos can be applied by embroidery on fabric, vinyl and leather. These logos must be placed at least 2" away from the edges of the seat, back and stitch lines. Extended lead time on chairs with logos is 4-6 weeks. Please see [pg. 20](#).

DIMENSIONS & FINISHES

Dimensions and finishes can be found online. Studio V, Via Seating's engineering design team, continuously updates and works with its partners to update Via Seating products to the latest industry advances and to customer feedback. Dimensions, finishes & resources are made available online to allow for real-time updates with the most current data.

Find Riva information at viaseating.com/series/riva-chairs/ or scan the QR code to the right →



QR CODE

Run II

solutions: ergonomic task chair & stool, conference, side/guest



featured image: 971-64C-DG-38AG10G-18GB-16SCG-02R GR 6 (MAHARAM PEPPER ACHIOTE)

features

Breadth of Line: high back, mid back, task stool and side/guest chair.

Mesh: available in multiple monochromatic & colorful solid mesh, Run II exclusive patchwork mesh and Via Seating's exclusive biocidal, self-sanitizing copper striped mesh.

Seats: offering two seat size options on the high and mid backs: standard medium and large.

Arms: ergonomic adjustable height arm featuring a sleek, textured large cap and optional arm width adjustment available in black or magnet grey finish including a unique roll-back arm.

Control Mechanisms: full function ergonomic synchro control mechanism with easy to use side tension adjustment.

Bases: five-star swivel bases available in black nylon, polished aluminum and brushed aluminum.

Via Seating's comfort foam: a proprietary blend of high-density, injection-molded, closed-cell, cold-cured foam so durable and lasting it is backed by Via Seating's 12 year warranty.

SPEC IT! ONLINE CHAIR BUILDER
Yes.
QUICK SHIP MANUFACTURING TIME
20 chairs/48 hours.
HIGHEST WEIGHT CAPACITY
300 lb.
WARRANTY
12 years, 5 years for mesh.
BIFMA LEVEL
Yes, LEVEL 2.
HEALTHIER HOSPITALS INITIATIVE (HHI)
Yes.
MINDFUL MATERIALS
Yes.
GSA (CONTRACT #: GS-28F-005CA)
Yes, SIN# 711-18.



design by Studio V

Studio V creates modern, sophisticated and original seating solutions that are ergonomic, beautiful and sustainable. This team of engineers, sustainability experts and designers is based in Reno, Nevada. Studio V develops products using a prototyping lab, the latest in 3D modeling software and a materials testing center.



Run II

LOWEST PRICED MODEL: \$475

GSA SIN #: 711-18 | MANUFACTURED IN U.S.A.





QUICK SHIP SCHEDULES

Code is listed in the starting model. Deviations from this are listed where they occur.



CODE	# MADE	DETAILS
20	20/48	20 Chairs manufactured in 48 hours.
☎	CALL	FOR LEAD TIME: 1-800-433-6614

0. CHOOSE YOUR BACK TYPE.

1. CHOOSE YOUR SEAT SIZE.

SEAT SIZE ↓	CHAIR TYPE →	Guest chair.	Mid back.	High back.
Medium seat.	PART #	20 931	20 971	20 981
	STARTING PRICE	\$475	\$533	\$586
	STARTING MODEL IMAGE			
	STARTING MODEL #	931-B-0A-1R-GR A	971-64C-B-0A-18BB-16HP-1R-GR A	981-64C-B-0A-18BB-16HP-1R-GR A
	COM COL SEAT	1 yd 9 sq ft +	1 yd 9 sq ft +	1 yd 9 sq ft
	MAX WEIGHT	300 lb.	300 lb.	300 lb.
	Large seat.	PART #	n/a	20 972
STARTING PRICE			\$607	\$660
STARTING MODEL IMAGE				
STARTING MODEL #			972-64C-B-0A-18BB-16HP-1R-GR A	982-64C-B-0A-18BB-16HP-1R-GR A
COM COL SEAT			1 yd 9 sq ft +	1 yd 9 sq ft
MAX WEIGHT			300 lb.	300 lb.

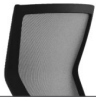
2. CHOOSE YOUR FRAME COLOR.

PART#	PRICE	IMAGE	DETAILS
-B	+\$0		Standard black.
-DG	+\$57		Magnet grey.

3. CHOOSE YOUR CONTROL MECHANISM.

DO YOU WANT A CHAIR? SELECT YOUR CONTROL.

3a. ADD SEAT SLIDE?

USE ON	FOR	USE WITH	PART#	PRICE	DETAILS	GASLIFT	PART #	PRICE	DETAILS	MAX WEIGHT	
	Mid & high backs.	Chairs.	All seats.	-64C	+\$0	Synchro control with side tension adjustment.	G3A: 4.8" travel.	n/a	n/a	n/a	300 lb.
			All seats.	-65C	+\$91	Synchro control with side tension adjustment and seat slide. Slides the seat +2 in forward.	G3A: 4.8" travel.		+\$0	Included.	300 lb.

DO YOU WANT A STOOL? SELECT YOUR CONTROL AND HEIGHT RANGE.

USE ON	USE ON	USE WITH	PART#	PRICE	DETAILS	GASLIFT	MAX WEIGHT
	•Mid backs.	Stools.	All seats.	-64CS-11DR	+\$156	Auto-adjust body balance control for stools.	G5: 7.0" travel.
				-64CS-11XDR	+\$156	Adds a polished foot ring and extended gas lift with stool height ranges. Available on all bases.	G6: 9.5" travel.

FIND MORE OPTIONS ON THE FOLLOWING PAGE. →

4. CHOOSE YOUR ARM TYPE.

DO YOU WANT AN ARMLESS CHAIR?















USE ON	PART#	PRICE	IMAGE	DETAILS
All chairs.	-0A	+\$0		Armless chairs are standard.

DO YOU WANT TO ADD AN ADJUSTABLE ARM?



4a. CHOOSE YOUR ARM CAP.

4b. ADD AN UPHOLSTERED CAP?

4c. ADD ADJUSTABLE WIDTH?

USE ON	PART#	PRICE	IMAGE	DETAILS	PART #	PRICE	IMAGE	DETAILS	PART#	PRICE	PART#	PRICE	DETAILS
971, 972, 981 & 982 only.	-38A	+\$55		Black nylon basic height adjustable arm.	10	+\$0		Standard fixed cap, black finish.	n/a	n/a	-19AB	+\$33	Brackets can adjust the width between arms by 2" per side.
	-38AG	+\$55		Magnet grey nylon basic height adjustable arm.	10G	+\$0		Standard fixed cap, grey finish.					
	-39A	+\$111		Black nylon height adjustable arm with roll back feature.	6	+\$0		Standard fixed cap.	n/a	n/a	n/a	n/a	n/a
	-51A	+\$89		Black polyurethane arm with optional 8-way adjustments.	20S	+\$0		Standard fixed cap.	U	+\$ your textile grade price found in step 8.	-19AB	+\$33	Brackets can adjust the width between arms by 2" per side.
		-51AG		+\$116	White polyurethane arm with optional 8-way adjustments.	20R	+\$42				4D rotating cap.		
		-51AG	+\$116	White polyurethane arm with optional 8-way adjustments.	20S	+\$0		Standard fixed cap.					
				20R	+\$42		4D rotating cap.						
	-53A	+\$150		Polished aluminum arm with optional 8-way adjustments.	20S	+\$0		Standard fixed cap.					
					20R	+\$42		4D rotating cap.					





DO YOU WANT TO ADD A FIXED ARM?



USE ON	PART#	PRICE	IMAGE	DETAILS
931 only.	-30A	+\$63		Black nylon fixed loop guest chair arm.
	-30AG	+\$63		Magnet grey nylon fixed loop guest chair arm.
971, 972, 981 & 982 only.	-31A	+\$66		Black nylon fixed loop conference arm.

5. CHOOSE YOUR 5-STAR SWIVEL BASE.



5a. CHOOSE YOUR CASTERS OR GLIDES.

5b. ADD SAFETY-BRAKE CASTERS?

PART#	PRICE	IMAGE	DETAILS
-18BB	+\$0		Black nylon base. Standard with black frames.
-18GB	+\$0		Magnet grey nylon base. Standard with grey frames.
-18PB	+\$114		Polished aluminum base.
-18BA	+\$114		Brushed aluminum base.

USE WITH	PART#	PRICE	IMAGE	DETAILS	PART#	PRICE	DETAILS
All bases.	-16HP	+\$0		Standard black finish casters are for use on soft/carpeted floors.	-SL1	+\$29	This feature locks the casters only when you are not sitting in the chair.
All bases.	-16SCG	+\$29		Grey finish casters are for use on both hard floors & soft/carpeted floors.	-SL2	+\$29	
All bases.	-16GL	+\$29		Black finish glides are for use on all floor types.	n/a	n/a	n/a

6. DO YOU WANT TO ADD AN ADJUSTABLE LUMBAR SUPPORT?

USE ON	PART#	PRICE	IMAGE	COLOR	DETAILS
-B frames only.	-LR2	+\$76		Black.	This optional height adjustable lumbar allows you to raise or lower the position of the lumbar support. Simply lift or lower the lever on the back of the lumbar to position the lumbar for optimal support.
-DG frames only.	-LR2G	+\$76		Magnet grey.	

FIND A QUOTING GUIDE ON THE FOLLOWING PAGE. →

7. CHOOSE YOUR MESH COLOR.

PART#	-1R	-2R	-3R	-4R	-5R	-6R	-7R	-8R	-13R	-14R
PRICE	+\$0	+\$0	+\$0	+\$0	+\$0	+\$43	+\$43	+\$43	+\$139	+\$139
IMAGE										
DETAILS	Standard black.	Grey.	Blue.	Red.	Green.	Blue patchwork.	Orange patchwork.	Grey patchwork.	Copper Striped.	Black Copper Striped.

8. ADD YOUR TEXTILE GRADE(S).

PART #	DETAILS	PRICE (DEPENDS ON FABRIC GRADE SELECTED)									
		A	B	1/COM	2	3/COL	4	5	6	7	8
All chairs.	All chairs.	+\$0	+\$22	+\$44	+\$71	+\$98	+\$125	+\$153	+\$208	+\$274	+\$366
U	Upholstered caps on arms 51A, 51AG & 53A.	+\$31	+\$31	+\$31	+\$31	+\$31	+\$31	+\$63	+\$63	+\$63	+\$63
NOTE	Must include mill, pattern and colorway listed after your grade choice in your model #. For COM/COL see pg. 18. We are happy to supply yardage requirement quotes for large quantity chair orders, as material economies may be realized. Please call 1-800-433-6614 or email your customer service for assistance.										

BUILD YOUR MODEL

STEP #	INSTRUCTIONS	PART #	LIST PRICE
1	STARTING LIST BASE MODEL (BACK & SEAT SIZE).		
2	FRAME COLOR OPTION.		
3	CONTROL OPTION.		
3a	SEAT SLIDE OPTION.		
4	ARM OPTION.		
4a	ARM CAP OPTION.		
4b	UPHOLSTERED CAP OPTION.		
4c	ADJUSTABLE WIDTH BRACKET OPTION.		
5	BASE OPTION.		
5a	CASTER/GLIDE OPTION.		
5b	SAFETY-BRAKE CASTER OPTION.		
6	LUMBAR SUPPORT OPTION.		
7	MESH COLOR.		
UPHOLSTERY OPTION:			
8	SINGLE TEXTILE STANDARD: ADD GRADE, THEN ADD: - (MILL PATTERN COLORWAY)		
PACKAGING:			
9	STANDARD SHIPPING: CHAIRS SHIP 95% ASSEMBLED. NO TOOLS REQUIRED.		
	CHAIRS SHIP FULLY ASSEMBLED OPTION (ADD PART # -FA AND LIST PRICE \$80/CHAIR).		
	BLANKET WRAPPED OPTION: MINIMUM ORDER OF 150, ADD PART # -BW AND CALL FOR LIST PRICING 1-800-433-6614.		
FINAL MODEL NUMBER & TOTAL LIST:			

OR SPEC IT THE EASY WAY



specified model #:

971-64C-DG-38AG10G-18GB-16SCG-02R GR 6
(MAHARAM PEPPER ACHIOTE)

FAQ

1. Can I place a logo on my chair?

Yes, logos can be applied by embroidery on fabric, vinyl and leather. These logos must be placed at least 2" away from the edges of the seat, back and stitch lines. Extended lead time on chairs with logos is 4-6 weeks. Please see pg. 20.

DIMENSIONS & FINISHES

Dimensions and finishes can be found online. Studio V, Via Seating's engineering design team, continuously updates and works with its partners to update Via Seating products to the latest industry advances and to customer feedback. Dimensions, finishes & resources are made available online to allow for real-time updates with the most current data.

Find Run II information at viaseating.com/series/run-ii-chairs or scan the QR code to the right →



QR CODE

Sienna

solutions: lounge, collaborative, lobby, executive guest, modular



featured image: 95-RSL-TBR-9BF-GR 1 SEAT (CF STINSON, STAPLE TEMPEST), BACK (MOMENTUM, HUE CHAR), ARMS (CF STINSON STAPLE TEMPEST)

features

Breadth of Line: chairs and couches.

Upholstery: option to upholster the seat, back and arms in three different textiles.

Arms: available as club or universal style, option of including a black or natural maple finish, permanent arm tablet.

Feet: available as black or natural maple finish. Casters are available on the single seat chair with universal arms.

Via Seating's comfort foam: a proprietary blend of high-density, injection-molded, closed-cell, cold-cured foam so durable and lasting it is backed by Via Seating's 12 year warranty.

Modular Builds: available upon request, special conditions apply.

SPEC IT! ONLINE CHAIR BUILDER
Yes.
QUICK SHIP MANUFACTURING TIME
1 chairs/48 hours.
HIGHEST WEIGHT CAPACITY
900 lb.
WARRANTY
6 years.
BIFMA LEVEL
Yes, LEVEL 2.
HEALTHIER HOSPITALS INITIATIVE (HHI)
Yes.
MINDFUL MATERIALS
Yes.
GSA (CONTRACT #: GS-28F-005CA)
No, available on open market.



design by Studio V

Studio V creates modern, sophisticated and original seating solutions that are ergonomic, beautiful and sustainable. This team of engineers, sustainability experts and designers is based in Reno, Nevada. Studio V develops products using a prototyping lab, the latest in 3D modeling software and a materials testing center.



Sienna

LOWEST PRICED MODEL: \$1,868







AVAILABLE ON OPEN MARKET | MANUFACTURED IN U.S.A.

QUICK SHIP SCHEDULES

Code is listed in the starting model. Deviations from this are listed where they occur.



CODE	# MADE	DETAILS
1	1/48	1 Chairs manufactured in 48 hours.
☎	CALL	FOR LEAD TIME: 1-800-433-6614

1. CHOOSE YOUR STARTING LIST BASE MODEL.





ARM TYPE ↓	SEATING SIZE →	Single chair.	Double couch.	Triple couch.
Club shaped arm.	PART #	1 95-RSL	1 95-RSSL	1 95-RSSSL
	STARTING LIST PRICE	\$1,868	\$2,620	\$3,373
	IMAGE			
	STARTING MODEL #	95-RSL-9BF-GR A	95-RSSL-9BF-GR A	95-RSSSL-9BF-GR A
	COM COL ALL SEATS	1.25 yd 12 sq ft	2 yd 24 sq ft	2.5 yd 36 sq ft
	COM COL ALL BACKS	2 yd 19.5 sq ft	2.75 yd 39 sq ft	3.75 yd 58.5 sq ft
	COM COL ALL ARMS	2 yd 34.6 sq ft	2 yd 34.6 sq ft	2 yd 34.6 sq ft
	COM COL WHOLE	4 yd 66.1 sq ft	5.75 yd 97.6 sq ft	7.5 yd 129.1 sq ft
MAX WEIGHT	300 lb	300 lb per seat.	300 lb per seat.	
Universal shaped arm.	PART #	1 95-USU	1 95-USSU	1 95-USSSU
	STARTING LIST PRICE	\$1,983	\$2,736	\$3,488
	IMAGE			
	STARTING MODEL #	95-USU-9BF-GR A	95-USSU-9BF-GR A	95-USSSU-9BF-GR A
	COM COL ALL SEATS	1.25 yd 12 sq ft	2 yd 24.4 sq ft	2.5 yd 36 sq ft
	COM COL ALL BACKS	2 yd 19.5 sq ft	2.75 yd 37.8 sq ft	3.75 yd 58.5 sq ft
	COM COL ALL ARMS	1.25 yd 35.5 sq ft	1.25 yd 35.5 sq ft	1.25 yd 35.5 sq ft
	COM COL WHOLE	3 yd 66.8 sq ft	4.75 yd 98 sq ft	7.75 yd 129.36 sq ft
MAX WEIGHT	300 lb	300 lb per seat.	300 lb per seat.	
NOTE	The standard seat is sewn to the chair/couch.			

2. DO YOU WANT TO ADD A TABLET ARM?

2a. CHOOSE TO PLACE THE TABLET ON THE LEFT OR RIGHT ARM.

PART#	PRICE	IMAGE	DETAILS	PART #	PRICE	DETAILS	NOTE
-TB	+\$248		Permanent, pivoting, wood, tablet arm in a matte black finish. Rotates 360 degrees.	L	+\$0	Placed on the left arm.	Multiple tablet arms can be specified on a single model. To include a left and right tablet arm list the left tablet arm followed by the right tablet arm. For example, -TBL-TBR.
				R	+\$0	Placed on the right arm.	
-TM	+\$248		Permanent, pivoting, wood, tablet arm in a maple wood finish. Rotates 360 degrees.	L	+\$0	Placed on the left arm.	
				R	+\$0	Placed on the right arm.	

3. CHOOSE YOUR FEET FINISH OR CASTERS.

FOR MODEL	PART#	PRICE	IMAGE	DETAILS
All models.	-9BF	+\$0		Permanent wood feet in a matte black finish.
All models.	-9MF	+\$0		Permanent wood feet in a maple finish.
 95-USU only.	-9CST	+\$214		Casters. Push down on the lever on each caster to lock the casters in a forward-position (no rotating). It is not recommended that these be retrofitted onto existing chairs.

FIND MORE OPTIONS ON THE FOLLOWING PAGE. →

4. DO YOU WANT TO ADD EMPHASIZED STITCH?

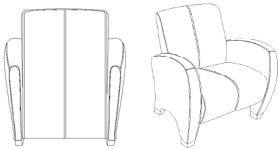
PART #	-CTS
PRICE	+\$0
IMAGE SHOWING CONTRASTING STITCH LINES BOLDED	
NOTE	Standard thread color is a tonal match to the textile(s) selected.

4a. CHOOSE YOUR EMPHASIZED STITCH THREAD COLOR.

PART#	-03	-05	-04	-06	-07	-09	-08	-10
PRICE	+\$0	+\$0	+\$0	+\$0	+\$0	+\$0	+\$0	+\$0
IMAGE								
DETAILS	Black thread.	Grey thread.	White thread.	Cream thread.	Chocolate thread.	Blue thread.	Red thread.	Yellow thread.

5. ADD YOUR TEXTILE GRADE(S).

PART #	PRICE (DEPENDS ON FABRIC GRADE SELECTED)										DETAILS
	A	B	1/COM	2	3/COL	4	5	6	7	8	
95-RSL & 95-USU	+\$0	+\$71	+\$247	+\$352	+\$531	+\$776	+\$1023	+\$1411	+\$1835	+\$2364	Single chair with club or universal arms.
95-RSSL & 95-USSU	+\$0	+\$113	+\$395	+\$565	+\$846	+\$1241	+\$1638	+\$2258	+\$2935	+\$3782	Double couch with club or universal arms.
95-RSSSL & 95-USSSU	+\$0	+\$157	+\$544	+\$777	+\$1165	+\$1709	+\$2253	+\$3106	+\$4038	+\$5201	Triple couch with club or universal arms.
NOTE	Must include mill, pattern and colorway listed after your grade choice in your model #. For COM/COL see pg. 18. We are happy to supply yardage requirement quotes for large quantity chair orders, as material economies may be realized. Please call 1-800-433-6614 or email your customer service manager for assistance.										

5a. DO YOU WANT THREE-TONE UPHOLSTERY? IF YES, PLEASE LIST YOUR TEXTILES IN THIS ORDER:

UPHOLSTERY LAYOUT	ORDER	DETAILS TO ADD TO YOUR MODEL #	IMPORTANT NOTES	PRICING NOTE
	1	SEAT (MILL PATTERN COLORWAY)	Includes seat.	Two-tone upholstery uses the highest grade of the two textiles.
	2	BACK (MILL PATTERN COLORWAY)	Includes front & back side of backrest or, in other words, all upholstered parts, but the seat.	

BUILD YOUR MODEL

STEP #	INSTRUCTIONS	PART #	LIST PRICE
1	STARTING LIST BASE MODEL.		
2	TABLET ARM OPTION.		
2a	LEFT OR RIGHT TABLET ARM(S).		
3	FEET/CASTERS OPTION.		
4	EMPHASIZED STITCH OPTION.		
4a	EMPHASIZED STITCH THREAD COLOR.		
UPHOLSTERY OPTION: CHOOSE 5 OR 5a, CHOOSING HIGHEST GRADE FOR LIST PRICE.			
5	SINGLE TEXTILE STANDARD: ADD GRADE, THEN ADD: - (MILL PATTERN COLORWAY)		
	TWO-TONE UPHOLSTERY OPTION: ADD GRADE, THEN ADD: - SEAT (MILL PATTERN COLORWAY)		
5a	- SEAT (MILL PATTERN COLORWAY)		
	- BACK (MILL PATTERN COLORWAY)		
PACKAGING:			
5	STANDARD SHIPPING: CHAIRS SHIP FULLY ASSEMBLED.		
FINAL MODEL NUMBER & TOTAL LIST:			

OR SPEC IT THE EASY WAY

via Design your perfect chair on our online builder: Spec It!
SPEC IT! <http://www.viaseating.com/specit>



featured model #:
95-RSL-TBR-9BF-GR 1
SEAT (CF STINSON, STAPLE TEMPEST),
BACK (MOMENTUM, HUE CHAR),
ARMS (CF STINSON STAPLE TEMPEST)

FAQ

1. Can I apply my own thread color in the Emphasized Stitch program?

Yes. Please note, lead time on chairs with custom thread colors can take up to 6 weeks from time of order confirmation depending on the complexity and availability of the thread color specified. Conditions may apply. Please contact 1-800-433-6614 for more information.

2. Can I build my own custom configuration?

Yes. Please call 1-800-433-6614 for more information.

DIMENSIONS & FINISHES

Dimensions and finishes can be found online. Studio V, Via Seating's engineering design team, continuously updates and works with its partners to update Via Seating products to the latest industry advances and to customer feedback. Dimensions, finishes & resources are made available online to allow for real-time updates with the most current data.



QR CODE

Find Meteor information at viaseating.com/series/sienna-seating or scan the QR code to the right →

DIMENSIONS & FINISHES

Dimensions and finishes can be found online. Studio V, Via Seating's engineering design team, continuously updates and works with its partners to update Via Seating products to the latest industry advances and to customer feedback. Dimensions, finishes and other resources are made available online to allow for real-time updates with the most current data.

Find Sienna information at viaseating.com/series/sienna-chairs



featured image: XBC15-4

features

Breadth of Line: chairs, couches, benches, a chaise lounge, litter bins, tables and a functional barbecue.

Structure: 18 mm tubular structure made of hot-dip galvanized, steel.

Finishes: epoxy powder coat glossy finishes create a dipped look across the surfaces and frames.

Stabilization: designed to be bolted to the ground.

For use in: outdoor environment including those with extreme heat, humidity & salt water air.

SPEC IT! ONLINE CHAIR BUILDER
Yes.
LEAD TIME
14 weeks from Italy.
MAX WEIGHT RANGE
2500 lb.
WARRANTY
5 years including extreme weather environments
BIFMA LEVEL
Yes, LEVEL 2.
HEALTHIER HOSPITALS INITIATIVE (HHI)
Yes.
MINDFUL MATERIALS
Yes.
GSA (CONTRACT #: GS-28F-005CA)
No, available on open market.



design by Basaglia & Rota Nodari

Alberto Basaglia and Natalia Rota Nodari met while studying at the Politecnico of Milan where they both graduated in architecture. Shortly after, they founded their studio, BASAGLIA ROTA NODARI. These Italian designers aim to transcend the typical image of the Italian designer. The pair achieve this by capturing beauty in equal measure with the technical aspects of their creations. Their visions manifest into award-winning, lovely furniture that captivates and stands the test of time.





Sierra

LOWEST PRICED MODEL: \$1,109

NOT ON CONTRACT WITH GSA (OPEN MARKET) | MANUFACTURED IN ITALY

LEAD TIME





Code is listed in the starting model. Deviations from this are listed where they occur.

CODE	DETAILS
	14 weeks, shipped from Italy.
	FOR LEAD TIME: 1-800-433-6614

1. DO YOU WANT TO ADD A SINGLE SEAT?

PART #	LIST PRICE	DETAILS
→XCUBE	\$1,109	This single outdoor seat is made of 13 tubes of hot-dip galvanized, steel. It is designed to be bolted to the ground. MAX WEIGHT: 2500 lb.



2. CHOOSE YOUR GLOSSY EPOXY POWDER-COAT COLOR.

PART#	-1	-2	-3	-4	-5
PRICE	+\$0	+\$0	+\$0	+\$0	+\$0
IMAGE					
DETAILS	Jet black.	Micaeous anthracite.	Signal white.	Carmine red.	Mint green.

1. DO YOU WANT TO ADD A CHAISE LOUNGE?

PART #	LIST PRICE	DETAILS
→XLC16	\$2,448	Rest back into this outdoor chaise lounge made of 15 tubes of hot-dip galvanized, steel. It is designed to be bolted to the ground. MAX WEIGHT: 2500 lb.

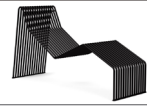
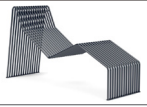
2. CHOOSE YOUR GLOSSY EPOXY POWDER-COAT COLOR.

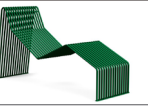
PART#	-1	-2	-3	-4	-5
PRICE	+\$0	+\$0	+\$0	+\$0	+\$0
IMAGE					
DETAILS	Jet black.	Micaeous anthracite.	Signal white.	Carmine red.	Mint green.

1. DO YOU WANT TO ADD A CLUB CHAIR?

PART #	LIST PRICE	DETAILS
→XCLUB	\$3,702	Enjoy this club-style chair made of 15 tubes (seat) and 5 tubes (per arm) of hot-dip galvanized, steel. It is designed to be bolted to the ground. MAX WEIGHT: 2500 lb.





2. CHOOSE YOUR GLOSSY EPOXY POWDER-COAT COLOR.

PART#	-1	-2	-3	-4	-5
PRICE	+\$0	+\$0	+\$0	+\$0	+\$0
IMAGE					
DETAILS	Jet black.	Micaeous anthracite.	Signal white.	Carmine red.	Mint green.

1. DO YOU WANT TO ADD AN OUTDOOR COUCH?

PART #	LIST PRICE	DETAILS
→XCOUCH	\$8,911	Enjoy this club arm couch made of 15 tubes (each seat) and 5 tubes (per arm) of hot-dip galvanized, steel. It is designed to be bolted to the ground. MAX WEIGHT: 2500 lb.

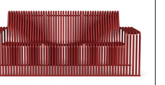



2. CHOOSE YOUR GLOSSY EPOXY POWDER-COAT COLOR.

PART#	-1	-2	-3	-4	-5
PRICE	+\$0	+\$0	+\$0	+\$0	+\$0
IMAGE					
DETAILS	Jet black.	Micaeous anthracite.	Signal white.	Carmine red.	Mint green.

1. DO YOU WANT TO ADD A BARBECUE?

PART #	LIST PRICE	DETAILS
→XBBQ	\$3,213	This functional barbecue is made of bent tubes of hot-dip galvanized, steel. It has a removal steel liner and is theft-proof. It is designed to be bolted to the ground. MAX WEIGHT: 2500 lb.

2. CHOOSE YOUR GLOSSY EPOXY POWDER-COAT COLOR.

PART#	-1	-2	-3	-4	-5
PRICE	+\$0	+\$0	+\$0	+\$0	+\$0
IMAGE					
DETAILS	Jet black.	Micaeous anthracite.	Signal white.	Carmine red.	Mint green.

FIND MORE OPTIONS ON THE FOLLOWING PAGE. →





1. DO YOU WANT TO ADD SKATE GUARDS?

PART #	LIST PRICE	IMAGE	DETAILS
→ UT15	\$115		Skate guards prevent skaters from riding/grinding their skateboard wheels on the furniture. These pieces are easily installed onto the Sierra models. Sold in a pair of 2. Instructions are available online.

1. DO YOU WANT TO ADD A FLAT BENCH?

PART #	LIST PRICE	DETAILS
→ XFS20	\$2,295	This flat bench is made of 13 tubes of hot-dip galvanized, steel. It is designed to be bolted to the ground. MAX WEIGHT: 2500 lb.





2. CHOOSE YOUR GLOSSY EPOXY POWDER-COAT COLOR.

PART#	-1	-2	-3	-4	-5
PRICE	+\$0	+\$0	+\$0	+\$0	+\$0
IMAGE					
DETAILS	Jet black.	Micaceous anthracite.	Signal white.	Carmine red.	Mint green.

1. DO YOU WANT TO ADD A FLAT BENCH WITH BACKREST?

PART #	LIST PRICE	DETAILS
→ XBS20	\$3,060	This flat bench is made of 13 tubes (seat) & 11 tubes (backrest) of hot-dip galvanized, steel. It is designed to be bolted to the ground. MAX WEIGHT: 2500 lb.

2. CHOOSE YOUR GLOSSY EPOXY POWDER-COAT COLOR.

PART#	-1	-2	-3	-4	-5
PRICE	+\$0	+\$0	+\$0	+\$0	+\$0
IMAGE					
DETAILS	Jet black.	Micaceous anthracite.	Signal white.	Carmine red.	Mint green.

1. DO YOU WANT TO ADD A CURVED BENCH?

PART #	LIST PRICE	DETAILS
→ XFC15	\$2,678	This curved bench is made of 13 tubes of hot-dip galvanized, steel. The shape allows the bench to be placed in convex or concave shapes. It is designed to be bolted to the ground. MAX WEIGHT: 2500 lb.

2. CHOOSE YOUR GLOSSY EPOXY POWDER-COAT COLOR.

PART#	-1	-2	-3	-4	-5
PRICE	+\$0	+\$0	+\$0	+\$0	+\$0
IMAGE					
DETAILS	Jet black.	Micaceous anthracite.	Signal white.	Carmine red.	Mint green.

1. DO YOU WANT TO ADD A CURVED BENCH, CONCAVE BACKREST?

PART #	LIST PRICE	DETAILS
→ XBC15	\$3,978	This curved bench is made of 13 tubes of hot-dip galvanized, steel. The shape allows the bench to be placed in concave shapes. It is designed to be bolted to the ground. MAX WEIGHT: 2500 lb.



2. CHOOSE YOUR GLOSSY EPOXY POWDER-COAT COLOR.

PART#	-1	-2	-3	-4	-5
PRICE	+\$0	+\$0	+\$0	+\$0	+\$0
IMAGE					
DETAILS	Jet black.	Micaceous anthracite.	Signal white.	Carmine red.	Mint green.

1. DO YOU WANT TO ADD A CURVED BENCH, CONVEX BACKREST?

PART #	LIST PRICE	DETAILS
→ XBX15	\$3,978	This curved bench is made of 13 tubes of hot-dip galvanized, steel. The shape allows the bench to be placed in convex shapes. It is designed to be bolted to the ground. MAX WEIGHT: 2500 lb.



2. CHOOSE YOUR GLOSSY EPOXY POWDER-COAT COLOR.





PART#	-1	-2	-3	-4	-5
PRICE	+\$0	+\$0	+\$0	+\$0	+\$0
IMAGE					
DETAILS	Jet black.	Micaceous anthracite.	Signal white.	Carmine red.	Mint green.

FIND MORE OPTIONS ON THE FOLLOWING PAGE. →

1. DO YOU WANT TO ADD A TABLE?

PART #	LIST PRICE	DETAILS
→XTV20	\$3,060	This table is made of 11 tubes (legs) a solid, flat sheet (middle of table surface) and 5 exposed tubes (either side of table surface) of hot-dip galvanized, steel. It is designed to be bolted to the ground. MAX WEIGHT: 2500 lb.

2. CHOOSE YOUR GLOSSY EPOXY POWDER-COAT COLOR.

PART#	-1	-2	-3	-4	-5
PRICE	+\$0	+\$0	+\$0	+\$0	+\$0
IMAGE					
DETAILS	Jet black.	Micaceous anthracite.	Signal white.	Carmine red.	Mint green.

1. DO YOU WANT TO ADD A LITTER BIN?

→ DO YOU WANT IT TO BE FREE-STANDING?

→ DO YOU WANT AN OPEN TOP?

PART #	LIST PRICE	DETAILS
→XBBO1	\$1,683	This litter bin has a single bin, an open top and is free-standing. GALLON CAPACITY: 17 gallons/bin.

2. CHOOSE YOUR GLOSSY EPOXY POWDER-COAT COLOR.

PART#	-2	-3
PRICE	+\$0	+\$0
IMAGE		
DETAILS	Micaceous anthracite.	Signal white.

→ DO YOU WANT A CLOSED TOP?

PART #	LIST PRICE	DETAILS
→XBBC1	\$1,683	This litter bin has a single bin, a closed top and is free-standing. GALLON CAPACITY: 17 gallons/bin.

2. CHOOSE YOUR GLOSSY EPOXY POWDER-COAT COLOR.

PART#	-2
PRICE	+\$0
IMAGE	
DETAILS	Micaceous anthracite.

→ DO YOU WANT IT TO BE BOLTED TO THE GROUND?

→ DO YOU WANT A SINGLE BIN?

PART #	LIST PRICE	DETAILS
→XSBP1	\$1,913	This litter bin has a single bin with an open top and is designed to be bolted to the ground. GALLON CAPACITY: 8 gallons/bin.

2. CHOOSE YOUR GLOSSY EPOXY POWDER-COAT COLOR.

PART#	-2
PRICE	+\$0
IMAGE	
DETAILS	Micaceous anthracite.

→ DO YOU WANT A DOUBLE BIN?

PART #	LIST PRICE	DETAILS
→XDBP2	\$3,341	This litter bin has two bins with open tops and is designed to be bolted to the ground. GALLON CAPACITY: 8 gallons/bin.

2. CHOOSE YOUR GLOSSY EPOXY POWDER-COAT COLOR.

PART#	-2
PRICE	+\$0
IMAGE	
DETAILS	Micaceous anthracite.

→ DO YOU WANT A TRIPLE BIN?

PART #	LIST PRICE	DETAILS
→XTBP3	\$4,590	This litter bin has a single bin with an open top and is designed to be bolted to the ground. GALLON CAPACITY: 8 gallons/bin.

2. CHOOSE YOUR GLOSSY EPOXY POWDER-COAT COLOR.

PART#	-2
PRICE	+\$0
IMAGE	
DETAILS	Micaceous anthracite.





FIND MORE OPTIONS ON THE FOLLOWING PAGE. →

CUSTOM MODULAR SEATING

1. DO YOU WANT TO ADD A MODULAR SEAT?

PART #	LIST PRICE	DETAILS
→XSM	\$1,607	This modular seat is made of bent tubes of hot-dip galvanized, steel. It can be connected to arms on either side or additional modular seats. It is designed to be bolted to the ground. MAX WEIGHT: 2500 lb.





2. CHOOSE YOUR GLOSSY EPOXY POWDER-COAT COLOR.

PART#	-1	-2	-3	-4	-5
PRICE	+\$0	+\$0	+\$0	+\$0	+\$0
IMAGE					
DETAILS	Jet black.	Micaeous anthracite.	Signal white.	Carmine red.	Mint green.



1. DO YOU WANT TO ADD A MODULAR ARM?

PART #	LIST PRICE	DETAILS
→XSM	\$918	This modular arm is made of bent tubes of hot-dip galvanized, steel. It can be connected to arms on either side or additional modular seats. It is designed to be bolted to the ground. MAX WEIGHT: 2500 lb.

2. CHOOSE YOUR GLOSSY EPOXY POWDER-COAT COLOR.

PART#	-1	-2	-3	-4	-5
PRICE	+\$0	+\$0	+\$0	+\$0	+\$0
IMAGE					
DETAILS	Jet black.	Micaeous anthracite.	Signal white.	Carmine red.	Mint green.

1. DO YOU NEED BRACKETS TO CONNECT MODULAR PIECES?

PART#	PRICE	IMAGE	DETAILS
XB1	+\$134		Small, general fixing bracket (x2), anthracite color.
XB2	+\$168		Large bracket for connecting middle arms, anthracite color.

EXAMPLES OF MODULAR BUILDS:

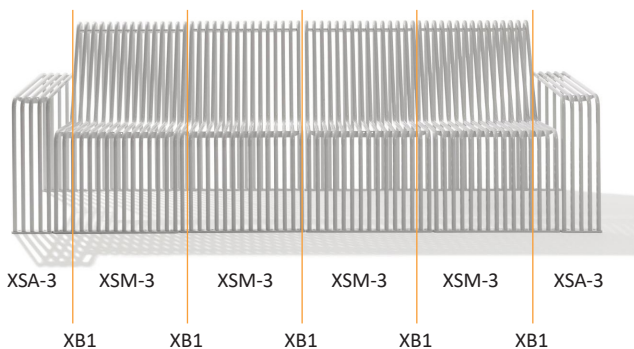

models ordered separately:
XSA-3 (x2), XSM-3 (x4), XB1 (x5)

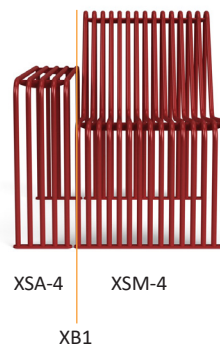

models ordered separately:
XSA-3 (x1), XSM-3 (x1), XB1 (x1)



IMPORTANT CUSTOMIZATION NOTES:

- Custom colors for the epoxy powder-coats are based on minimum quantities. Call for conditions and pricing. Extended lead times will apply.
- Custom outdoor modular configurations are prepared to order. Parts consist of arms, seats and connecting brackets, which are each ordered separately.
- Please call **1-800-433-6614** or e-mail **info@viaseating.com** for assistance with custom builds.

FIND A QUOTING GUIDE ON THE FOLLOWING PAGE. →

BUILD YOUR MODEL

STEP #	INSTRUCTIONS	PART #	LIST PRICE
1	STARTING LIST BASE MODEL.		
2	MODEL COLOR.		
PACKAGING:			
3	STANDARD SHIPPING: MOST MODELS SHIP WITH SOME ASSEMBLY REQUIRED.		
FINAL MODEL NUMBER & TOTAL LIST:			

OR SPEC IT THE EASY WAY

via Design your perfect model on our online builder: Spec It!
SPEC IT! <http://www.viaseating.com/specit>

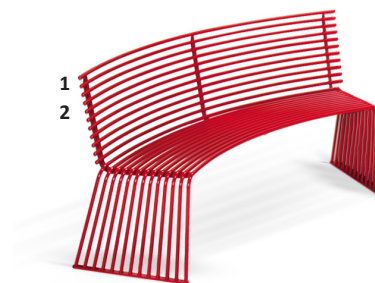

featured model #: XBC15-4

FREIGHT COST CHART

Freight costs are shown in **NET** pricing for most locations throughout the U.S. See cost/unit and total cost of freight by order quantity. For order quantities over 20 or for additional freight related questions, please call 1-800-433-6614. For total freight costs of orders to Canada, South America, Mexico, Hawaii or Alaska, please call 1-800-433-6614.

order quantity	1	2	3	4	5	6	7	8	9	10 +
cost/unit	\$500	\$325	\$283	\$300	\$270	\$250	\$243	\$213	\$189	\$185
total cost	\$500	\$650	\$850	\$1,200	\$1,350	\$1,500	\$1,700	\$1,700	\$1,700	\$1,850

FAQ

1. Where do Sierra models ship from?

Sierra models ship directly from Italy. These chairs are on a 14 week lead time.

2. Can these models be produced in custom colors?

Yes, Sierra models can be produced in custom colors identified by the customer. There is a longer waiting time and additional process requirements for custom colors. Please call 1-800-433-6614 or email info@viaseating.com for more information.

3. Where can I find assembly instructions?

General assembly instructions/recommendations and assembly instructions for specific models are available online. Please find these at the links below.

DIMENSIONS & FINISHES

Dimensions and finishes can be found online. Studio V, Via Seating's engineering design team, continuously updates and works with its partners to update Via Seating products to the latest industry advances and to customer feedback. Dimensions, finishes & resources are made available online to allow for real-time updates with the most current data.



QR CODE

Find Sierra information at viaseating.com/series/sierra-collection or scan the QR code to the right →

Spec Stools

solutions: multi-use, caregiver/physician/surgeon stool, compact seating, training



featured image: 1401-15SPEC-GR 1 (SPRADLING SILVERTEX SKYLIGHT)

features

Breadth of Line: stools at regular, tall and extra-tall heights.

Compact Footprint: a spacious seat is balanced atop a compact design.

Seamless Upholstery: supports infection prevention and easy clean up.

Easy Adjustments: available with a hands-free or hand-activated height adjustment ring.

Casters & Glides: offering a variety of black and grey soft carpet and hard floor casters and black glides. Casters offer the option of a safety-brake feature.

SPEC IT! ONLINE CHAIR BUILDER
Yes.
QUICK SHIP MANUFACTURING TIME
20 chairs/48 hours.
HIGHEST WEIGHT CAPACITY
300 lb.
WARRANTY
12 years.
BIFMA LEVEL
Yes, LEVEL 2.
HEALTHIER HOSPITALS INITIATIVE (HHI)
Yes.
MINDFUL MATERIALS
Yes.
GSA (CONTRACT #: GS-28F-005CA)
Yes, SIN# 711-18.



design by Studio V

Studio V creates modern, sophisticated and original seating solutions that are ergonomic, beautiful and sustainable. This team of engineers, sustainability experts and designers is based in Reno, Nevada. Studio V develops products using a prototyping lab, the latest in 3D modeling software and a materials testing center.



Spec Stools

LOWEST PRICED MODEL: \$514



GSA SIN #: 711-18 | MANUFACTURED IN U.S.A.

QUICK SHIP SCHEDULES





Code is listed in the starting model. Deviations from this are listed where they occur.

CODE	# MADE	DETAILS
20	20/48	20 Chairs manufactured in 48 hours.
☎	CALL	FOR LEAD TIME: 1-800-433-6614







1. CHOOSE YOUR STARTING LIST BASE MODEL.

TYPE OF HEIGHT ADJUSTMENT →	Stool with a hand-activated height adjustment.	Stool with a hands-free height adjustment.
PART #	20 1416	20 1401
STARTING LIST PRICE	\$514	\$706
STARTING MODEL IMAGE		
STARTING MODEL #	1416-13BB-16HP-GR A	1401-15SPEC-GR A
COM COL SEAT	0.75 yd 11 sq ft	0.75 yd 11 sq ft
MAX WEIGHT	300 lb.	300 lb.



2. CHOOSE YOUR 5-STAR SWIVEL BASE.

USE WITH	PART#	PRICE	IMAGE	DETAILS
 1416 only.	-13BB	+\$0		Standard black nylon high-crown base with a mindfully compact footprint.
	-18BB	+\$0		Black nylon base. Standard for light task stools.
	-18PB	+\$114		Polished aluminum base.
	-18BA	+\$114		Brushed aluminum base.

2a. CHOOSE YOUR CASTERS OR GLIDES.

FOR MODEL	PART#	PRICE	IMAGE	DETAILS	2b. ADD SAFETY-BRAKE CASTERS?		
 1416 only.	-16HP	+\$0		Black finish casters are for use on soft/carpeted floor.	-SL1	+\$29	This feature locks the casters only when you are not sitting in the chair.
	-16SCG	+\$29		Grey finish casters are for use on both hard floor & soft/carpeted floor.	-SL2	+\$29	
	-16GL	+\$29		Black finish glides are for use on all floor types.	n/a	n/a	n/a
 1401 only.	-15SPEC	+\$0		Black finish for hard floor with safety-lock feature. This feature locks the casters only when you are not sitting in the chair.	n/a	n/a	Feature is included.
	-15NWB	+\$29		Black finish for soft/carpeted floor with safety-lock feature. This feature locks the casters only when you are not sitting in the chair.	n/a	n/a	Feature is included.

2c. DO YOU WANT TO ADD A STOOL KIT?

FOR MODEL	FOR BASES	PART #	PRICE	IMAGE	STOOL KIT OPTION
 1416 only.	18BB, 18PB, 18BA only.	-11DR	+\$149		Tall stool kit (extended gas lift & a footring footrest) gives 7" of vertical travel.
		-11XDR	+\$149		Extra-tall stool kit (extended gas lift & a footring footrest) gives 9" of vertical travel.

3. ADD YOUR TEXTILE GRADE(S).

PART #	PRICE (DEPENDS ON FABRIC GRADE SELECTED)										DETAILS
	A	B	1/COM	2	3/COL	4	5	6	7	8	
1416	+\$0	+\$13	+\$28	+\$56	+\$73	+\$101	+\$147	+\$177	+\$283	+\$428	Stool with a hand-activated height adjustment.
1401	+\$0	+\$13	+\$28	+\$56	+\$73	+\$101	+\$147	+\$177	+\$283	+\$428	Stool with a hands-free height adjustment.
NOTE	Must include mill, pattern and colorway listed after your grade choice in your model #. For COM/COL see pg. 18. We are happy to supply yardage requirement quotes for large quantity chair orders, as material economies may be realized. Please call 1-800-433-6614 or email your customer service manager for assistance.										

BUILD YOUR MODEL

STEP #	INSTRUCTIONS	PART #	LIST PRICE
1	STARTING LIST BASE MODEL.		
2	BASE OPTION.		
2a	CASTER OR GLIDE OPTION.		
3	STOOL WITH FOOT-RING OPTION.		
UPHOLSTERY OPTION: CHOOSE 4 OR 4a, CHOOSING HIGHEST GRADE FOR LIST PRICE.			
4	SINGLE TEXTILE STANDARD: ADD GRADE, THEN ADD: - (MILL PATTERN COLORWAY)		
PACKAGING:			
5	STANDARD SHIPPING: CHAIRS SHIP 95% ASSEMBLED.		
	CHAIRS SHIP FULLY ASSEMBLED OPTION (ADD PART # -FA AND LIST PRICE \$80 /CHAIR).		
	BLANKET WRAPPED OPTION: MINIMUM ORDER OF 150, ADD PART # -BW AND CALL FOR LIST PRICING 1-800-433-6614.		
FINAL MODEL NUMBER & TOTAL LIST:			

OR SPEC IT THE EASY WAY

via Design your perfect chair on our online builder: Spec It!
SPEC IT! <http://www.viaseating.com/specit>



featured model #:
1401-15SPEC-GR 1 (SPRADLING SILVERTEX SKYLIGHT)

DIMENSIONS & FINISHES

Dimensions and finishes can be found online. Studio V, Via Seating's engineering design team, continuously updates and works with its partners to update Via Seating products to the latest industry advances and to customer feedback. Dimensions, finishes & resources are made available online to allow for real-time updates with the most current data.

Find Spec Stools information at viaseating.com/series/spec-stools or scan the QR code to the right →



QR CODE

Splash



solutions: multi-use, stacking, side/guest, bar & counter stool, light task chair & stool



featured image: 801-C-08-8US-GR 7 (MOMENTUM'S TRI-KES BALEN CORDOVAN)

features

Breadth of Line: available as a stackable side/guest chair, a bar or counter height stool, a light task chair, a light task stool and a stackable table.

Backs: available as poly, mesh or upholstered backs.

Seats: available as poly or upholstered seats.

Arms: choice of armless or with an arm. The armrest that matches the chair's poly color.

Frames: choice of matte black or chrome frame.

Stackable Options: both the chairs and desks are stackable on or off the optional high-density stacking carts.

SPEC IT! ONLINE CHAIR BUILDER
Yes.
QUICK SHIP MANUFACTURING TIME
20 chairs/48 hours.
HIGHEST WEIGHT CAPACITY
275 lb.
WARRANTY
6 years, 5 years for mesh.
BIFMA LEVEL
Yes, LEVEL 2.
HEALTHIER HOSPITALS INITIATIVE (HHI)
Yes.
MINDFUL MATERIALS
Yes.
GSA (CONTRACT #: GS-28F-005CA)
Yes, SIN# 711-19.



design by Basaglia & Rota Nodari

Alberto Basaglia and Natalia Rota Nodari met while studying at the Politecnico of Milan where they both graduated in architecture. Shortly after, they founded their studio, BASAGLIA ROTA NODARI. These Italian designers aim to transcend the typical image of the Italian designer. The pair achieve this by capturing beauty in equal measure with the technical aspects of their creations. Their visions manifest into award-winning, lovely furniture that captivates and stands the test of time.



Splash

STARTING LIST PRICE: \$178









GSA SIN #: 711-19 | MANUFACTURED IN U.S.A.

QUICK SHIP SCHEDULES





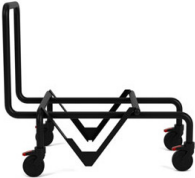

Code is listed in the starting model. Deviations from this are listed where they occur.

CODE	# MADE	DETAILS
20	20/48	20 Chairs manufactured in 48 hours.
10	10/48	10 Chairs manufactured in 48 hours.
📞	CALL	FOR LEAD TIME: 1-800-433-6614.

1. CHOOSE YOUR STARTING LIST BASE MODEL.

BACK TYPE ↓	CHAIR TYPE →	Stackable sled base chair.	Sled base stool.	Light task chair.
Poly back.	PART #	20 801	20 807	20 805
	STARTING LIST PRICE	\$256	\$381	\$465
	STARTING MODEL IMAGE			
	STARTING MODEL #	801-B-01-0A	807-B-01-0A	805-B-01-0A-13BB-16HP
	STACKS	20 poly only / 15 upholstered on the floor.	n/a	n/a
	MAX WEIGHT	275 lb.	275 lb.	275 lb.
	Mesh back.	PART #	20 802	20 808
STARTING LIST PRICE		\$277	\$402	\$486
STARTING MODEL IMAGE				
STARTING MODEL #		802-B-01-0A-1S	808-B-01-0A-1S	806-B-01-0A-13BB-16HP-1S
STACKS		20 poly only / 15 upholstered on the floor.	n/a	n/a
MAX WEIGHT		275 lb.	275 lb.	275 lb.
Other models.		TYPE →	High-density stacking transport cart	
	DETAILS	Used for chairs.		Used for desks.
	PART #	20 800C	20 800D	20 809-C-01-03T
	STARTING LIST PRICE	\$730	\$835	\$585
	STARTING MODEL IMAGE			
	STARTING MODEL #	800C	800D	809-C-01-03T
	STACKS	40 high poly only / 25 high upholstered chair models 801 & 802 only.	40 high poly only / 25 high upholstered desk model 809 only.	10 desks on the floor.
MAX WEIGHT	520 lb.	520 lb.	250 lb.	

2. CHOOSE YOUR FRAME FINISH.

PART#	-B			-C		
PRICE	+\$0			+\$23		
IMAGE						
ON CHAIR TYPE	Stackable chair.	Bar/counter stool.	Light task chair.	Stackable chair.	Bar/counter stool.	Light task chair.
DETAILS	Standard matte black sled base & frame.			Polished chrome sled base frame.		Polished chrome frame with a height adjustable control.

FIND MORE OPTIONS ON THE FOLLOWING PAGE. →

3. CHOOSE YOUR SHELL COLOR.

+ MORE OPTIONS FOR POLY BACKS ONLY

PART#	FOR MODELS	-01	-02	-03	FOR MODELS	-04	-05	-07	-08
PRICE		+\$0	+\$0	+\$0		+\$0	+\$0	+\$0	+\$0
IMAGE									
DETAILS	All chairs.	Standard jet black.	Window grey.	Signal white.	801, 805, 807 only.	Cobalt blue.	Sand.	Carmine red.	Dark grey.

4. CHOOSE YOUR ARM TYPE.

DO YOU WANT AN ARMLESS CHAIR?

PART#	PRICE	IMAGE	DETAILS
-0A	+\$0		Armless chairs are standard.

DO YOU WANT TO ADD A FIXED ARM?

4a. CHOOSE ARM CAP COLOR.

PART#	PRICE	DETAILS	USE WITH POLY COLOR	WITH -01	WITH -02	WITH -03	WITH -04	WITH -05	WITH -07	WITH -08
			PART#	S01	S02	S03	S04	S05	S07	S08
-SA2	+\$42	Straight fixed arm with a poly cap. Cannot be retrofitted onto existing frames. Arm frame finish matches selection in step 2. Poly cap color matches	PRICE	+\$0	+\$0	+\$0	+\$0	+\$0	+\$0	+\$0
			IMAGE							
			DETAILS	Standard jet black.	Window grey.	Signal white.	Cobalt blue.	Sand.	Carmine red.	Dark grey.

5. CHOOSE YOUR 5-STAR SWIVEL BASE.

USE WITH	PART#	PRICE	IMAGE	DETAILS
	-13BB	+\$0		Standard black nylon high-crown base with a mindfully compact footprint.
	-18BB	+\$0		Black nylon base. Standard for light task stools.
	-18PB	+\$114		Polished aluminum base.
	-18BA	+\$114		Brushed aluminum base.

805 & 806 only.

5a. CHOOSE YOUR CASTERS OR GLIDES.

5b. ADD SAFETY-BRAKE CASTERS?

USE WITH	PART#	PRICE	IMAGE	DETAILS	PART#	PRICE	DETAILS
	-16HP	+\$0		Standard black finish casters are for use on soft/carpeted floors.	-SL1	+\$29	This feature locks the casters only when you are not sitting in the chair.
	-16SCG	+\$29		Grey finish casters are for use on both hard floors & soft/carpeted floors.	-SL2	+\$29	
	-16GL	+\$29		Black finish glides are for use on all floor types.	n/a	n/a	n/a
	-FELT	+\$20		Felt glides for sled bases.	n/a	n/a	n/a

805 & 806 only.

801, 802, 807, 808 & 809 only.









5c. DO YOU WANT TO MAKE YOUR CHAIR A LIGHT TASK STOOL?

USE WITH	FOR BASES	PART #	PRICE	IMAGE	STOOL KIT OPTION
	18BB, 18PB, 18BA only.	-11DR	+\$156		Tall stool kit (extended gas lift & a footing footrest) gives 7" of vertical travel.
		-11XDR	+\$156		Extra-tall stool kit (extended gas lift & a footing footrest) gives 9" of vertical travel.

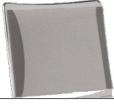
805 & 806 only.

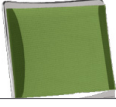

FIND MORE OPTIONS ON THE FOLLOWING PAGE. →

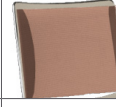
6. CHOOSE YOUR MESH COLOR.



FOR MODELS	PART#	-1S	-2S	-3S	-4S	-5S	-6S	-8S	-11S	-12S
 802, 806, 808 only.	PRICE	+\$0	+\$0	+\$0	+\$0	+\$0	+\$0	+\$0	+\$43 *	+\$43 *
	IMAGE									
	DETAILS	Standard black.	Silver.	Blue.	Orange.	Green.	Cardinal red.	Coffee.	Black copper.	Natural copper.

7. DO YOU WANT TO ADD A TABLET ARM?



7a. CHOOSE TO PLACE THE TABLET ON THE LEFT OR RIGHT ARM.

PART#	PRICE	IMAGE	DETAILS	PART #	PRICE	DETAILS	NOTE
-81TABB	+\$136		Vertically rotatable tablet arm with a black surface and black sides.	L	+\$0	Placed on the left arm.	Can only be specified on one side. Tablet arms can be retrofitted onto existing frames. Chairs with tablet arms do not stack. See series Eclipse for chairs with tablet arms that do stack.
				R	+\$0	Placed on the right arm.	
-81TABW	+\$136		Vertically rotatable tablet arm with a black surface and black sides.	L	+\$0	Placed on the left arm.	
				R	+\$0	Placed on the right arm.	



8. DO YOU WANT TO ADD A BOOK RACK?

FOR MODELS	PART#	-81BOOKC
 801, 802, 807 & 808 only.	PRICE	+\$105
	IMAGE	
	DETAILS	Chrome book rack.
	NOTE	Book racks can be retrofitted onto existing frames.

9. DO YOU WANT TO ADD GANGING BRACKETS?

FOR MODELS	PART#	-81GNCS	NOTE
 801 & 802 only.	PRICE	+\$28	If you would like more than one ganging bracket, please list total number of ganging brackets needed. For example, an order of 10 chairs may have 5 ganging brackets needed. Ganged chairs do not stack.
	IMAGE		
	DETAILS	Removable ganging brackets.	

10. DO YOU WANT TO ADD UPHOLSTERY? IF YES, SELECT BY YOUR TEXTILE GRADE(S).

PART #	IMAGE	DETAILS	COM COL	PRICE (DEPENDS ON FABRIC GRADE SELECTED)									
				A	B	1/COM	2	3/COL	4	5	6	7	8
10 -8US		Optional upholstered seat.	0.75 yd 3.9 sq ft	+\$57	+\$84	+\$110	+\$136	+\$162	+\$188	+\$214	+\$240	+\$266	+\$293
10 -8USB		Optional upholstered seat & back.	1.5 yd 7.8 sq ft	+\$100	+\$146	+\$192	+\$238	+\$283	+\$329	+\$375	+\$421	+\$466	+\$512
NOTE	Must include mill, pattern and colorway listed after your grade choice in your model #. For COM/COL see pg. 18. We are happy to supply yardage requirement quotes for large quantity chair orders, as material economies may be realized. Please call 1-800-433-6614 or email your customer service manager for assistance.												

10a. DO YOU WANT TO USE MULTIPLE TEXTILES ON YOUR CHAIR? IF YES, PLEASE LIST YOUR TEXTILES IN THIS ORDER:

UPHOLSTERY LAYOUT	ORDER	DETAILS TO ADD TO YOUR MODEL #	IMPORTANT NOTES	PRICING NOTE
	1	SEAT (MILL PATTERN COLORWAY)	Includes seat.	Two-tone upholstery uses the highest grade of the two textiles.
	2	BACK (MILL PATTERN COLORWAY)	Includes back.	

FIND A QUOTING GUIDE ON THE FOLLOWING PAGE. →

BUILD YOUR SPLASH MODEL.

STEP #	CHOICE	PART #	LIST PRICE
1	STARTING LIST BASE MODEL.		
2	FRAME FINISH.		
3	SHELL COLOR.		
4	ARM OPTION.		
5	LIGHT TASK BASE OPTION.		
5a	LIGHT TASK CASTER/GLIDE OPTION.		
5b	LIGHT TASK SAFETY-BRAKE CASTER OPTION.		
5c	LIGHT TASK STOOL KIT OPTION.		
6	MESH COLOR OPTION.		
7	TABLET ARM OPTION.		
8	BOOK RACK OPTION.		
9	GANGING BRACKET OPTION.		
UPHOLSTERY OPTION: CHOOSE 8 OR 8a, CHOOSING HIGHEST GRADE FOR LIST PRICE.			
10	SINGLE TEXTILE STANDARD: ADD 8US OR 8USB , GRADE, THEN ADD: - (MILL PATTERN COLORWAY)		
	TWO-TONE UPHOLSTERY OPTION: ADD 8US OR 8USB , GRADE, THEN ADD: - SEAT (MILL PATTERN COLORWAY)		
10a	- BACK (MILL PATTERN COLORWAY)		
PACKAGING OPTIONS:			
11	STANDARD SHIPPING: MOST CHAIRS SHIP FULLY ASSEMBLED, EXCEPT MODEL 805 & 806 CHAIRS SHIP 95% ASSEMBLED. NO TOOLS REQUIRED.		
	<u>SINGLE CHAIRS</u> : FOR A SINGLE CHAIR ORDER, ADD PART # -SC AND LIST PRICE \$63 .		

SPEC IT THE EASY WAY

via Design your perfect chair on our online builder: Spec It!
SPEC IT! <http://www.viaseating.com/specit>



featured model #:
801-C-08-8US-GR 7 (TRI-KES BALEN CORDOVAN)

FAQ

1. Can I place a logo on my chair?

Yes, logos can be applied by embroidery on fabric, vinyl and leather. These logos must be placed at least 2" away from the edges of the seat, back and stitch lines. Extended lead time on chairs with logos is 4-6 weeks. Please see [pg. 20](#).

1. Can I get a left-handed tablet?

Yes, tablets are available for right-handed or left-handed use. Please reach out for more details.

DIMENSIONS & FINISHES

Dimensions and finishes can be found online. Studio V, Via Seating's engineering design team, continuously updates and works with its partners to update Via Seating products to the latest industry advances and to customer feedback. Dimensions, finishes & resources are made available online to allow for real-time updates with the most current data.

Find Splash information at viaseating.com/series/splash-collection or scan the QR code to the right →



QR CODE

Splash Air (busy)

solutions: outdoor seating, stackable chair & stool



featured image: 820-0A-2

features

Breadth of Line: stackable chair and stackable stool.

Design: strategic holes in the back & seat increase breathability in the sit & prevent stagnation of water.

Materials: made of printed-aluminum monocoque run through a machine that winds the sheet to the rebar.

Durability: for use outdoors.

Frame: dipped-look in jet black, micaceous anthracite, signal white & carmine red.

Arms: option of armless or arm version on chair & stool.

Lifting: easy-grab handle with durable, light-weight frames.

SPEC IT! ONLINE CHAIR BUILDER
Yes.
QUICK SHIP MANUFACTURING TIME
14 weeks from Italy.
HIGHEST WEIGHT CAPACITY
275 lb.
WARRANTY
5 years.
BIFMA LEVEL
Yes, LEVEL 2.
HEALTHIER HOSPITALS INITIATIVE (HHI)
Yes.
MINDFUL MATERIALS
Yes.
GSA (CONTRACT #: GS-28F-005CA)
No, available on open market.



design by Basaglia & Rota Nodari

Alberto Basaglia and Natalia Rota Nodari met while studying at the Politecnico of Milan where they both graduated in architecture. Shortly after, they founded their studio, BASAGLIA ROTA NODARI. These Italian designers aim to transcend the typical image of the Italian designer. The pair achieve this by capturing beauty in equal measure with the technical aspects of their creations. Their visions manifest into award-winning, lovely furniture that captivates and stands the test of time.





Splash Air

LOWEST PRICED MODEL: \$495





NOT ON CONTRACT WITH GSA (OPEN MARKET) | MANUFACTURED IN ITALY

LEAD TIME





Code is listed in the starting model. Deviations from this are listed where they occur.

CODE	DETAILS
	14 weeks, shipped from Italy.
	FOR LEAD TIME: 1-800-433-6614

1. CHOOSE YOUR STARTING LIST BASE MODEL.

CHAIR TYPE	Stackable armless chair.	Stackable armless bar/counter stool.
PART #	 820	 822
STARTING LIST PRICE	\$495	\$685
IMAGE		
STARTING MODEL #	820-1	822-1
STACKS	15 high on floor.	15 high on floor.
MINIMUM ORDER QUANTITY ¹	10 chair minimum.	10 stool minimum.
SHIPS	Fully assembled in box.	Fully assembled in box.
MAX WEIGHT	275 lb.	275 lb.
NOTE 1	The minimum order quantity allows for the chairs to ship with freight included in the LIST pricing (ie. no additional cost for freight).	

2. CHOOSE YOUR DIPPED-COLOR LOOK.

PART#	-1	-2	-3	-4
PRICE	+\$0	+\$0	+\$0	+\$0
IMAGE				
COLORS	Jet black.	Micaceous anthracite.	Signal white.	Carmine red.
DETAILS	Application is a glossy epoxy powder-coat across the entire chair shell, framework & optional arm.			

3. CHOOSE YOUR ARM TYPE

DO YOU WANT AN ARMLESS CHAIR?

PART#	PRICE	IMAGE	DETAILS
-0A	+\$0		Armless chairs are standard.

DO YOU WANT TO ADD A FIXED ARM?

4a. CHOOSE ARM CAP COLOR.

PART#	PRICE	DETAILS	USE WITH COLOR	WITH -1	WITH -2	WITH -3	WITH -4
-SA3	+\$68	Straight fixed arm. Cannot be retrofitted onto existing frames. Arm matches dipped-color look selected in step 2.	PRICE	+\$0	+\$0	+\$0	+\$0
	IMAGE						
	DETAILS		Jet black.	Micaceous anthracite.	Signal white.	Carmine red.	

FIND A QUOTING GUIDE ON THE FOLLOWING PAGE. →

BUILD YOUR MODEL

STEP #	INSTRUCTIONS	PART #	LIST PRICE
1	STARTING LIST BASE MODEL.		
2	CHAIR & FRAME COLOR.		
3	ARM OPTION.		

PACKAGING:

4	STANDARD SHIPPING: CHAIRS SHIP FULLY ASSEMBLED.		
---	---	--	--

FINAL MODEL NUMBER & TOTAL LIST:

--	--	--	--

OR SPEC IT THE EASY WAY

via
SPEC IT! Design your perfect chair on our online builder: Spec It!
<http://www.viaseating.com/specit>

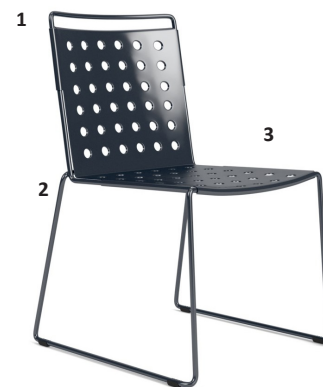

featured model #: 820-0A-3

FAQ

1. Where do SplashAir chairs ship from?

SplashAir chairs ship directly from Italy. These chairs are on a 14 week lead time. 10 chair/stool minimum.

1. Can SplashAir be used in the same extreme weather conditions as the Tahoe & Sierra collections?

SplashAir is designed for typical outdoor weather environments. SplashAir has a light-weight frame. It is not recommended that SplashAir be used in the same salt-weather and extreme wind/weather conditions that the Sierra and Tahoe series are designed to endure.

2. Can arms be retrofitted onto existing frame?

No, arms cannot be retrofitted onto existing frames.

3. Can these chairs be produced in custom colors?

Yes, SplashAir models can be produced in custom colors identified by the customer. There is a longer waiting time and additional process requirements for custom colors. Please call 1-800-433-6614 or email info@viaseating.com for more information.

4. Can these chairs be produced in the mint green of the Sierra & Tahoe series?

Yes, however, this is not a general offering. Minimums apply. Please call 1-800-433-6614 or email info@viaseating.com for more information.

DIMENSIONS & FINISHES

Dimensions and finishes can be found online. Studio V, Via Seating's engineering design team, continuously updates and works with its partners to update Via Seating products to the latest industry advances and to customer feedback. Dimensions, finishes & resources are made available online to allow for real-time updates with the most current data.



QR CODE

Find SplashAir information at viaseating.com/series/splashair-chairs or scan the QR code to the right →

Sutro



solutions: multi-use, stacking, side/guest, bar & counter stool, light task chair & stool

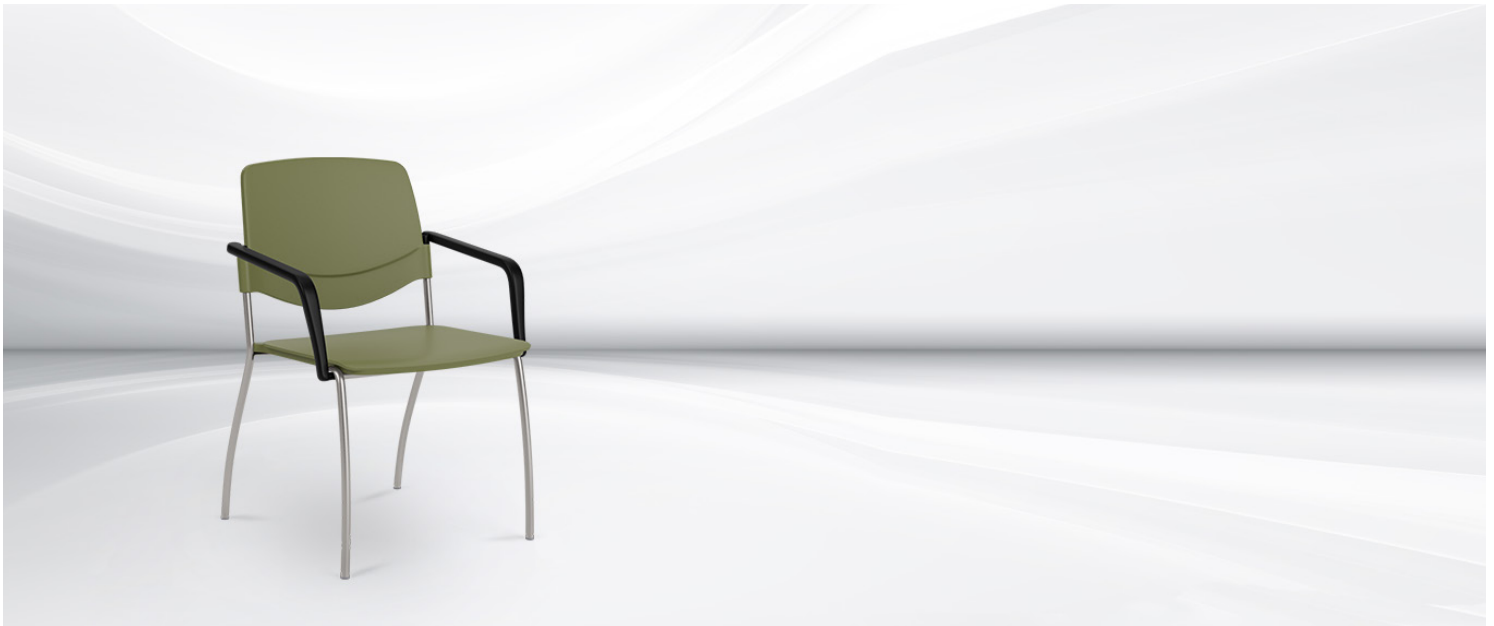

featured image: 602-S-09-SA1

features

Breadth of Line: available as a stackable side/guest chair, a side/guest chair on wheels, a light task chair and a light task stool.

Designer Shape: signature curve on chair back makes gripping and transporting this light-weight chair easy.

Arms: choice of armless or the addition of a black arm.

Frames: choice of matte black or silver frame. Both feature matching glides.

Stackable Options: the 4-leg side/guest chairs are stackable with option of stacking on a transport cart.

Upholstery: available with an optional upholstered back and seat.

SPEC IT! ONLINE CHAIR BUILDER
Yes.
QUICK SHIP MANUFACTURING TIME
20 chairs/48 hours.
HIGHEST WEIGHT CAPACITY
400 lb.
WARRANTY
6 years.
BIFMA LEVEL
Yes, LEVEL 2.
HEALTHIER HOSPITALS INITIATIVE (HHI)
Yes.
MINDFUL MATERIALS
Yes.
GSA (CONTRACT #: GS-28F-005CA)
Yes, SIN# 711-19.



design by Diemmebi R&D

Diemmebi R&D's team of designers and engineers develop practical furniture that go hand-in-hand with evolving approaches to collective and domestic spaces. Inspiration starts with the Diemmebi R&D creative team by defining the quality, form and function of each product. The results are captivating, award-winning pieces.



Sutro

LOWEST PRICED MODEL: \$178



GSA SIN #: 711-19 | MANUFACTURED IN U.S.A.

QUICK SHIP SCHEDULES





Code is listed in the starting model. Deviations from this are listed where they occur.

CODE	# MADE	DETAILS
20	20/48	20 Chairs manufactured in 48 hours.
10	10/48	10 Chairs manufactured in 48 hours.
📞	CALL	FOR LEAD TIME: 1-800-433-6614.





1. CHOOSE YOUR STARTING LIST BASE MODEL.

MODEL	Stackable 4-leg chair.	Light task chair.	Stacking transport cart for chairs in a polished finish with red handle and wheels caps.
PART #	20 602	20 612	20 600C
STARTING LIST PRICE	\$178	\$366	\$303
IMAGE			
STARTING MODEL #	602-B-01-0A	612-B-01-0A-13BB-16HP	600C
STACKS	8 poly seat & back only, 6 upholstered seat & back on the floor.	n/a	8 poly seat / 6 upholstered seat of 602, 5 poly seat / 5 upholstered seat of 602-SA1.
SHIPS	3 regular per box. 2 upholstered per box.	3 regular per box. 2 upholstered per box.	1 per box.
MAX WEIGHT	400 lb.	275 lb.	127.5 lb.

2. CHOOSE YOUR FRAME FINISH.

PART#	-B		-S	
PRICE	+\$0		+\$43	
IMAGE				
ON CHAIR TYPE	Stackable chair.	Light task chair.	Stackable chair.	Light task chair.
DETAILS	Standard matte black 4-leg base and frame.	Standard matte black frame and black height adjustable control.	Powder-coated silver 4-leg base and frame.	Powder-coated silver frame and chrome height adjustable control.

3. CHOOSE YOUR SHELL COLOR.

PART#	-01	-02	-03	-09
PRICE	+\$0	+\$0	+\$0	+\$20
IMAGE				
DETAILS	Standard jet black.	Window grey.	Signal white.	Sage green.

4. CHOOSE YOUR ARM TYPE.

DO YOU WANT AN ARMLESS CHAIR?





PART#	PRICE	IMAGE	DETAILS
-0A	+\$0		Armless chairs are standard.

DO YOU WANT TO ADD AN FIXED ARM?

PART#	PRICE	IMAGE	DETAILS
-SA1	+\$56		Matte black polyurethane loop arm. Arm is fixed to frame.





FIND MORE OPTIONS ON THE FOLLOWING PAGE. →

5. CHOOSE YOUR 5-STAR SWIVEL BASE.



USE WITH	PART#	PRICE	IMAGE	DETAILS
 612 only.	-13BB	+\$0		Standard black nylon high-crown base with a mindfully compact footprint.
	-18BB	+\$0		Black nylon base. Standard for light task stools.
	-18PB	+\$114		Polished aluminum base.
	-18BA	+\$114		Brushed aluminum base.

5a. CHOOSE YOUR CASTERS OR GLIDES.

5b. ADD SAFETY-BRAKE CASTERS?



USE WITH	PART#	PRICE	IMAGE	DETAILS	PART#	PRICE	DETAILS
 612 only.	-16HP	+\$0		Standard black finish casters are for use on soft/carpeted floors.	-SL1	+\$29	This feature locks the casters only when you are not sitting in the chair.
	-16SCG	+\$29		Grey finish casters are for use on both hard floors & soft/carpeted floors.	-SL2	+\$29	
	-16GL	+\$29		Black finish glides are for use on all floor types.	n/a	n/a	n/a

5c. DO YOU WANT TO MAKE YOUR CHAIR A LIGHT TASK STOOL?



USE WITH	FOR BASES	PART #	PRICE	IMAGE	STOOL KIT OPTION
 612 only.	18BB, 18PB, 18BA only.	-11DR	+\$156		Tall stool kit (extended gas lift & a footring footrest) gives 7 in of vertical travel.
		-11XDR	+\$156		Extra-tall stool kit (extended gas lift & a footring footrest) gives 9 in of vertical travel.

6. MAKE YOUR CHAIR A MOBILE CHAIR (CHAIR ON WHEELS)?

7. DO YOU WANT TO ADD GANGING BRACKETS?

FOR USE WITH	PART#	PRICE	IMAGE	DETAILS	MAX WEIGHT	FOR USE WITH	PART#	-21GNG	NOTE	
 602 only.	-WH	+\$76		These optional casters have a black finish. Casters cannot be retrofitted onto existing frames. Chairs with casters cannot be stacked.	350 lb	 602 only.		PRICE	+\$28	If you would like more than one ganging bracket, please list total number of ganging brackets needed. For example, an order of 10 chairs may have 5 ganging brackets needed. Gangered chairs do not stack.
								DETAILS	Removable ganging brackets.	

8. DO YOU WANT TO ADD UPHOLSTERY? IF YES, ADD THE PART # AND SELECT YOUR TEXTILE GRADE(S).

PART #	IMAGE	DETAILS	COM COL	PRICE (DEPENDS ON FABRIC GRADE SELECTED)									
				A	B	1/COM	2	3/COL	4	5	6	7	8
10 -6US		Optional upholstered seat.	0.75 yd 3.9 sq ft	+\$57	+\$84	+\$110	+\$136	+\$162	+\$188	+\$214	+\$240	+\$266	+\$293
10 -6USB		Optional upholstered seat & back.	1.5 yd 7.8 sq ft	+\$100	+\$146	+\$192	+\$238	+\$283	+\$329	+\$375	+\$421	+\$466	+\$512
NOTE	Must include mill, pattern and colorway listed after your grade choice in your model #. For COM/COL see pg. 18. We are happy to supply yardage requirement quotes for large quantity chair orders, as material economies may be realized. Please call 1-800-433-6614 or email your customer service manager for assistance.												

8a. DO YOU WANT TWO-TONE UPHOLSTERY? IF YES, PLEASE LIST YOUR TEXTILES IN THIS ORDER:

UPHOLSTERY LAYOUT	ORDER	DETAILS TO ADD TO YOUR MODEL #	IMPORTANT NOTES	PRICING NOTE
	1	SEAT (MILL PATTERN COLORWAY)	Includes seat.	Two-tone upholstery uses the highest grade of the two textiles.
	2	BACK (MILL PATTERN COLORWAY)	Includes back.	

FIND A QUOTING GUIDE ON THE FOLLOWING PAGE. →

BUILD YOUR MODEL.

STEP #	CHOICE	PART #	LIST PRICE
1	STARTING LIST BASE MODEL.		
2	FRAME FINISH.		
3	SHELL COLOR.		
4	ARM OPTION.		
5	LIGHT TASK BASE OPTION.		
5a	LIGHT TASK CASTER/GLIDE OPTION.		
5b	LIGHT TASK SAFETY-BRAKE CASTER OPTION.		
5c	LIGHT TASK STOOL KIT OPTION.		
6	<u>4-LEG CHAIRS</u> : CASTER OPTION.		
7	GANGING BRACKET OPTION.		
UPHOLSTERY OPTION: CHOOSE 8 OR 8a, CHOOSING HIGHEST GRADE FOR LIST PRICE.			
8	SINGLE TEXTILE STANDARD: ADD 6US OR 6USB , GRADE, THEN ADD: - (MILL PATTERN COLORWAY)		
	TWO-TONE UPHOLSTERY OPTION: ADD 6US OR 6USB , GRADE, THEN ADD: - SEAT (MILL PATTERN COLORWAY)		
8a	- BACK (MILL PATTERN COLORWAY)		
PACKAGING OPTIONS:			
9	STANDARD SHIPPING: MODEL 602 CHAIRS SHIP FULLY ASSEMBLED. MODEL 612 CHAIRS SHIP 95% ASSEMBLED. NO TOOLS REQUIRED.		
	<u>SINGLE CHAIRS</u> : FOR A SINGLE CHAIR ORDER, ADD PART # -SC AND LIST PRICE \$63 .		

OR SPEC IT THE EASY WAY

via Design your perfect chair on our online builder: Spec It!
SPEC IT! <http://www.viaseating.com/specit>



featured model #: 602-S-09-SA1

FAQ

1. Can I place a logo on my chair?

Yes, logos can be applied by embroidery on fabric, vinyl or leather. These logos must be placed at least 2" away from the edges of the seat, back and all stitch lines. Extended lead time on chairs with logos is 4-6 weeks. Please see [pg. 20](#).

DIMENSIONS & FINISHES

Dimensions and finishes can be found online. Studio V, Via Seating's engineering design team, continuously updates and works with its partners to update Via Seating products to the latest industry advances and to customer feedback. Dimensions, finishes & resources are made available online to allow for real-time updates with the most current data.

Find Sutro information at viaseating.com/series/sutro-collection or scan the QR code to the right →



QR CODE

Swopper®

solutions: motion, sit-to-stand, task, stool, training, lab seating



featured image: SWUS_CLASSIC-A-GR 4 (FAUX FELT CHARCOAL)

features

Breadth of Line: available as a motion chair or high motion chair.

Easy Height Adjustment: Swopper® can be easily adjusted up and down allowing it to work in harmony with a variety of work environments. Use with standard desks, counters and sit-to-stand desks.

Flexible Sideways Movement: Swopper® delivers a wide sideways reach. This increases the radius of action and optimizes natural posture at the same time. It encourages shifting positions and playful movement, which activates the blood circulation, in turn increasing internal resources for better concentration.

Ergonomic Forward Tilt: Swopper®'s 3D joint located close to the ground allows for a comfortable, hip-opening, hands-free tilt forward of the Swopper® chair as the user shifts forward.

SPEC IT! ONLINE CHAIR BUILDER
Yes.
QUICK SHIP MANUFACTURING TIME
20 chairs/48 hours.
MAX WEIGHT RANGE
265 lb.
WARRANTY
5 years.
BIFMA LEVEL
Yes, LEVEL 2.
HEALTHIER HOSPITALS INITIATIVE (HHI)
Yes.
MINDFUL MATERIALS
Yes.
GSA (CONTRACT #: GS-28F-005CA)
Yes, SIN# 711-18.



design by Henner Jahns

Henner Jahns, founder and lead designer of Gecco Vision (est. 1997), specializes in creating tailor-made office furniture. His company focuses on cultivating a vision into reality. The small design team is seen as an advantage, allowing each member to really focus on the development of something new. The result is numerous, award-winning, seating solutions that stand out.



LOWEST PRICED MODEL: \$959



GSA SIN #: 711-18 | MANUFACTURED IN GERMANY

QUICK SHIP SCHEDULES

Code is listed in the starting model. Deviations from this are listed where they occur.

CODE	# MADE	DETAILS
20	20/48	20 Chairs produced in 48 hours.
📞	CALL	FOR LEAD TIME: 1-800-433-6614

1. CHOOSE YOUR STARTING LIST BASE MODEL.

PART #	20 SWUS_CLASSIC	20 SWUS_HIGH
STARTING PRICE	\$1,078	\$1,278
IMAGE & DIMENSIONS		
STARTING MODEL #	SWUS_CLASSIC-A-10SW	SWUS_HIGH-A-GR 1
COM COL SEAT	0.75 yd 1.25 sq ft	0.75 yd 1.25 sq ft
MAX WEIGHT	265 lb	265 lb

2. CHOOSE YOUR BASE FINISH.

USE WITH	All chairs.	CUSTOM
PART#	-A	-T
PRICE	+\$0	+\$26
IMAGE		
DETAILS	Anthracite.	Titanium.

2a. DO YOU WANT TO ADD ROLLERS?

USE WITH	CUSTOM	n/a on titanium
PART#	-R	NOTE
PRICE	+\$89	Rollers can not be retrofitted onto existing bases. Height with rollers is 22.5"–28.0"
IMAGE		
DETAILS	Black rollers.	

3. ADD YOUR TEXTILE GRADE(S).

FOR USE ON	DETAILS	PRICE (DEPENDS ON FABRIC GRADE SELECTED)							
		1/COM	2	3/COL	4	5	6	7	8
 CUSTOM & HIGH	Includes chair seats.	+\$0	+\$15	+\$41	+\$70	+\$105	+\$151	+\$206	+\$276
NOTE	Must include mill, pattern and colorway listed after your grade choice in your model #. For COM/COL see pg. 18. We are happy to supply yardage requirement quotes for large quantity chair orders, as material economies may be realized. Please call 1-800-433-6614 or email your customer service manager for assistance.								

BUILD & PRICE YOUR MODEL

STEP #	INSTRUCTIONS	PART #	LIST PRICE
1	STARTING LIST BASE MODEL.		
2	BASE COLOR OPTION.		
2a	ROLLERS OPTION.		
5	ADD GRADE, THEN ADD: - (MILL PATTERN COLORWAY)		
PACKAGING:			
5	STANDARD SHIPPING: CHAIRS SHIP FULLY ASSEMBLED.		
FINAL MODEL NUMBER & TOTAL LIST:			



featured model #: SWUS_CLASSIC-A-GR 4
(FAUX FELT CHARCOAL)

DISCONTINUATIONS •

- SWUS_AIR
- SWUS_SADDLE
- SWUS_CLASSIC

For help with alternates, please contact customer service at 1-800-433-6614 or <https://viaseating.com/contact-us/customer-service-contact/>

Tahoe (ventiquattrore.H24)

solutions: outdoor furniture, tables



featured image: TBN20-2N

features

Breadth of Line: chairs, benches, a chaise lounge, litter bins, tables and a planter.

Structure: hot-dip galvanized steel framework with aluminum stave surfaces.

Finishes: polyester powder coat embossed color finishes for the framework and polyester powder coat embossed color finishes or heat transfer film for a natural ash wood grain effect on table tops, litter bin sides, seats and backrests

Stabilization: designed to be free-standing or bolted to the ground.

For use in: outdoor environment including those with extreme heat, humidity & salt water air.

SPEC IT! ONLINE CHAIR BUILDER
Yes.
QUICK SHIP MANUFACTURING TIME
14 weeks from Italy.
MAX WEIGHT RANGE
2500 lb.
WARRANTY
5 years including extreme weather environments.
BIFMA LEVEL
Yes, LEVEL 2.
HEALTHIER HOSPITALS INITIATIVE (HHI)
Yes.
MINDFUL MATERIALS
Yes.
GSA (CONTRACT #: GS-28F-005CA)
No, available on open market.



design by Basaglia & Rota Nodari

Alberto Basaglia and Natalia Rota Nodari met while studying at the Politecnico of Milan where they both graduated in architecture. Shortly after, they founded their studio, BASAGLIA ROTA NODARI. These Italian designers aim to transcend the typical image of the Italian designer. The pair achieve this by capturing beauty in equal measure with the technical aspects of their creations. Their visions manifest into award-winning, lovely furniture that captivates and stands the test of time.





Tahoe

LOWEST PRICED MODEL: \$1,575

NOT ON CONTRACT WITH GSA (OPEN MARKET) | MANUFACTURED IN ITALY

LEAD TIME

Code is listed in the starting model. Deviations from this are listed where they occur.





CODE	DETAILS
	14 weeks, shipped from Italy.
	FOR LEAD TIME: 1-800-433-6614

1. DO YOU WANT A CHAISE LOUNGE?

DO YOU WANT THE DIPPED-COLOR LOOK?

PART #	LIST PRICE	DETAILS
~TCH15	\$3,938	This chaise lounge features an embossed dipped look in a polyester powder coat across the seat and hot-dip galvanized steel loop frame. MAX WEIGHT: 2500 lb

2. CHOOSE YOUR EMBOSSED EPOXY POWDER-COAT COLOR.

PART#	-2	-3	-4	-5
PRICE	+\$0			
IMAGE				
DETAILS	Micaceous anthracite.	Signal white.	Carmine red.	Mint green.

DO YOU WANT THE NATURAL WOOD LOOK?

PART #	LIST PRICE	DETAILS
~TCN15	\$4,350	This chaise lounge features a heat transfer film natural ash wood grain effect on the surfaces and a anthracite or white finish on the hot-dip galvanized steel framework. MAX WEIGHT: 2500 lb

2. CHOOSE YOUR EPOXY POWDER-COAT FRAME COLOR.

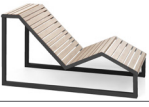
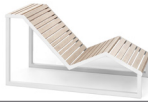
PART#	-2N	-3N
PRICE	+\$0	
IMAGE		
DETAILS	Micaceous anthracite.	Signal white.

1. DO YOU WANT A PLANTER?

DO YOU WANT THE DIPPED-COLOR LOOK?

PART #	LIST PRICE	DETAILS
~TGC15	\$1,575	This planter features an embossed dipped look in an polyester powder coat down the sides and the hot-dip galvanized steel cover. MAX WEIGHT: 2500 lb

2. CHOOSE YOUR EMBOSSED EPOXY POWDER-COAT COLOR.

PART#	-2	-3	-4	-5
PRICE	+\$0			
IMAGE				
DETAILS	Micaceous anthracite.	Signal white.	Carmine red.	Mint green.

DO YOU WANT THE NATURAL WOOD LOOK?

PART #	LIST PRICE	DETAILS
~TGN15	\$1,950	This planter features a heat transfer film natural ash wood grain effect on the sides and a anthracite or white finish on the hot-dip galvanized steel cover. MAX WEIGHT: 2500 lb

2. CHOOSE YOUR EPOXY POWDER-COAT FRAME COLOR.

PART#	-2N	-3N
PRICE	+\$0	
IMAGE		
DETAILS	Micaceous anthracite.	Signal white.

FIND MORE OPTIONS ON THE FOLLOWING PAGE. →

1. DO YOU WANT A FLAT BACKLESS BENCH?

DO YOU WANT THE DIPPED-COLOR LOOK?

PART #	LIST PRICE	DETAILS
~TFC15	\$1,989	This flat bench features a embossed dipped look in a polyester powder coat across the seat and hot-dip galvanized steel loop frame. MAX WEIGHT: 2500 lb



2. CHOOSE YOUR Embossed EPOXY POWDER-COAT COLOR.

PART#	-1	-2	-3	-4	-5
PRICE	+\$0	+\$0	+\$0	+\$0	+\$0
IMAGE					
DETAILS	Jet black.	Micaeous anthracite.	Signal white.	Carmine red.	Mint green.

DO YOU WANT THE NATURAL WOOD GRAIN LOOK?

PART #	LIST PRICE	DETAILS
~TFN15	\$2,219	This flat bench features a heat transfer film natural ash wood grain effect on the seat and a hot-dip galvanized steel loop frame. MAX WEIGHT: 2500 lb

2. CHOOSE YOUR EPOXY POWDER-COAT FRAME COLOR.





PART#	-2N	-3N
PRICE	+\$0	+\$0
IMAGE		
DETAILS	Micaeous anthracite.	Signal white.

1. DO YOU WANT A FLAT BENCH WITH A BACKREST?

DO YOU WANT THE DIPPED-COLOR LOOK?

PART #	LIST PRICE	DETAILS
~TBC20	\$2,678	This flat bench with backrest features an embossed dipped look in a polyester powder coat across the seat and hot-dip galvanized steel loop frame. MAX WEIGHT: 2500 lb



2. CHOOSE YOUR Embossed EPOXY POWDER-COAT COLOR.

PART#	-1	-2	-3	-4	-5
PRICE	+\$0	+\$0	+\$0	+\$0	+\$0
IMAGE					
DETAILS	Jet black.	Micaeous anthracite.	Signal white.	Carmine red.	Mint green.

DO YOU WANT THE NATURAL WOOD GRAIN LOOK?

PART #	LIST PRICE	DETAILS
~TBN20	\$3,213	This flat bench with backrest features a heat transfer film natural ash wood grain effect on the seat and a hot-dip galvanized steel loop frame. MAX WEIGHT: 2500 lb

2. CHOOSE YOUR EPOXY POWDER-COAT FRAME COLOR.





PART#	-2N	-3N
PRICE	+\$0	+\$0
IMAGE		
DETAILS	Micaeous anthracite.	Signal white.

1. DO YOU WANT A DOUBLE SEAT BENCH WITH A BACKREST?

2. DO YOU WANT THE DIPPED-COLOR LOOK?

PART #	LIST PRICE	DETAILS
~TBC15	\$3,290	This double seat bench features a embossed dipped look in a polyester powder coat across the seat and hot-dip galvanized steel loop frame. MAX WEIGHT: 2500 lb



2. CHOOSE YOUR Embossed EPOXY POWDER-COAT COLOR.

PART#	-1	-2	-3	-4	-5
PRICE	+\$0	+\$0	+\$0	+\$0	+\$0
IMAGE					
DETAILS	Jet black.	Micaeous anthracite.	Signal white.	Carmine red.	Mint green.

DO YOU WANT THE NATURAL WOOD GRAIN LOOK?

PART #	LIST PRICE	DETAILS
~TBN15	\$3,978	This double seat bench with backrest features a heat transfer film natural ash wood grain effect on the seat and a hot-dip galvanized steel loop frame. MAX WEIGHT: 2500 lb

2. CHOOSE YOUR EPOXY POWDER-COAT FRAME COLOR.

PART#	-2N	-3N
PRICE	+\$0	+\$0
IMAGE		
DETAILS	Micaeous anthracite.	Signal white.





FIND MORE OPTIONS ON THE FOLLOWING PAGE. →

1. DO YOU WANT A TABLE?

DO YOU WANT THE DIPPED-COLOR LOOK?

PART #	LIST PRICE	DETAILS
~TTC25	\$2,792	This table features an embossed dipped look in a polyester powder coat across the surfaces and hot-dip galvanized steel loop frame. MAX WEIGHT: 2500 lb



2. CHOOSE YOUR Embossed EPOXY POWDER-COAT COLOR.

PART#	-1	-2	-3	-4	-5
PRICE	+\$0				
IMAGE					
DETAILS	Jet black.	Micaeous anthracite.	Signal white.	Carmine red.	Mint green.

DO YOU WANT THE NATURAL WOOD GRAIN LOOK?

PART #	LIST PRICE	DETAILS
~TTN25	\$3,366	This table features a heat transfer film natural ash wood grain effect on the seat and a hot-dip galvanized steel loop frame. MAX WEIGHT: 2500 lb

2. CHOOSE YOUR EPOXY POWDER-COAT FRAME COLOR.



PART#	-2N	-3N
PRICE	+\$0	
IMAGE		
DETAILS	Micaeous anthracite.	Signal white.

1. DO YOU WANT A PICNIC TABLE?

DO YOU WANT THE DIPPED-COLOR LOOK?

PART #	LIST PRICE	DETAILS
~TPC15	\$4,950	This picnic table with backless benches features an embossed dipped look in a polyester powder-coat across the surfaces and hot-dip galvanized steel loop frame. MAX WEIGHT: 2500 lb



2. CHOOSE YOUR Embossed EPOXY POWDER-COAT COLOR.

PART#	-2	-3	-4
PRICE	+\$0		
IMAGE			
DETAILS	Micaeous anthracite.	Signal white.	Carmine red.

DO YOU WANT THE NATURAL WOOD GRAIN LOOK?

PART #	LIST PRICE	DETAILS
~TPN15	\$6,000	This picnic table with backless seats features a heat transfer film natural ash wood grain effect on the seat and a hot-dip galvanized steel loop frame. MAX WEIGHT: 2500 lb

2. CHOOSE YOUR EPOXY POWDER-COAT FRAME COLOR.



PART#	-2N	-3N
PRICE	+\$0	
IMAGE		
DETAILS	Micaeous anthracite.	Signal white.

1. DO YOU WANT A LITTER BIN?

DO YOU WANT THE DIPPED-COLOR LOOK?

PART #	LIST PRICE	DETAILS
~TLC15	\$2,775	This open top litter bin features an embossed dipped look in a polyester powder coat down the sides and the hot-dip galvanized steel cover. GALLON CAPACITY: 17 gallons/bin.



2. CHOOSE YOUR Embossed EPOXY POWDER-COAT COLOR.

PART#	-2	-3	-4
PRICE	+\$0		
IMAGE			
DETAILS	Micaeous anthracite.	Signal white.	Carmine red.

DO YOU WANT THE NATURAL WOOD GRAIN LOOK?

PART #	LIST PRICE	DETAILS
~TLN15	\$3,150	This open litter bin features a heat transfer film natural ash wood grain effect on the sides and a anthracite or white finish on the hot-dip galvanized steel cover. GALLON CAPACITY: 17 gallons/bin.

2. CHOOSE YOUR EPOXY POWDER-COAT FRAME COLOR.

PART#	-2N	-3N
PRICE	+\$0	
IMAGE		
DETAILS	Micaeous anthracite.	Signal white.

FIND A QUOTING GUIDE ON THE FOLLOWING PAGE. →

BUILD YOUR MODEL

STEP #	INSTRUCTIONS	PART #	LIST PRICE
1	STARTING LIST BASE MODEL.		
2	MODEL/FRAME COLOR.		
PACKAGING:			
3	STANDARD SHIPPING: MOST MODELS SHIP WITH SOME ASSEMBLY REQUIRED.		
FINAL MODEL NUMBER & TOTAL LIST:			

OR SPEC IT THE EASY WAY

via Design your perfect model on our online builder: Spec It!
SPEC IT! <http://www.viaseating.com/specit>



featured model #: TBN20-2N

FREIGHT COST CHART

Freight costs are shown in **NET** pricing for most locations throughout the U.S. See cost/unit and total cost of freight by order quantity. For total freight costs of orders outside of the contiguous United States (such as Canada, South America, Mexico, Hawaii or Alaska), please call 1-800-433-6614. The product will be delivered directly to the job site. Clearly defined delivery instructions need to be included on the PO.

order quantity	1	2	3	4	5	6	7	8	9	10 +
cost/unit	\$500	\$325	\$283	\$300	\$270	\$250	\$243	\$213	\$189	\$185
total cost	\$500	\$650	\$850	\$1,200	\$1,350	\$1,500	\$1,700	\$1,700	\$1,700	\$1,850

FAQ

1. Where do Tahoe models ship from?

Tahoe models ship directly from Italy to the job site. These chairs are on a 14 week lead time.

2. Can these models be produced in custom colors?

Yes, Tahoe models can be produced in custom colors identified by the customer. There is a longer waiting time and additional process requirements for custom colors. Please call 1-800-433-6614 or email info@viaseating.com for more information.

3. Where can I find assembly instructions?

General assembly instructions/recommendations and assembly instructions for specific models are available online. Please find these at the links below.

DIMENSIONS & FINISHES

Dimensions and finishes can be found online. Studio V, Via Seating's engineering design team, continuously updates and works with its partners to update Via Seating products to the latest industry advances and to customer feedback. Dimensions, finishes & resources are made available online to allow for real-time updates with the most current data.

Find Tahoe information at viaseating.com/series/tahoe-collection or scan the QR code to the right →



QR CODE

Terra

solutions: ergonomic task chair & stool



featured image: 115-5C-10A3-18BB-16HP-GR A (MOMENTUM ORIGIN JET)

features

Breadth of Line: available as an upholstered high, mid and low back.

Seats: offering five seat sizes: petite to large.

Arms: multiple height adjustable arms including an arm with a roll back feature.

Control Mechanisms: controls include active back and bio-sync options.

Bases: five-star swivel bases available in black nylon, polished aluminum and brushed aluminum.

Via Seating's comfort foam: a proprietary blend of high-density, injection-molded, closed-cell, cold-cured foam so durable and lasting it is backed by Via Seating's 12 year warranty.

SPEC IT! ONLINE CHAIR BUILDER
Yes.
QUICK SHIP MANUFACTURING TIME
15 chairs/48 hours.
HIGHEST WEIGHT CAPACITY
300 lb.
WARRANTY
12 years, 2 years for mesh.
BIFMA LEVEL
Yes, LEVEL 2.
HEALTHIER HOSPITALS INITIATIVE (HHI)
Yes.
MINDFUL MATERIALS
Yes.
GSA (CONTRACT #: GS-28F-005CA)
Yes, SIN# 711-18.



design by Studio V

Studio V creates modern, sophisticated and original seating solutions that are ergonomic, beautiful and sustainable. This team of engineers, sustainability experts and designers is based in Reno, Nevada. Studio V develops products using a prototyping lab, the latest in 3D modeling software and a materials testing center.



Terra

STARTING LIST PRICE: \$642









GSA SIN #: 711-18 | MANUFACTURED IN U.S.A.

QUICK SHIP SCHEDULES

Code is listed in the starting model. Deviations from this are listed where they occur.

CODE	# MADE	DETAILS
15	15/48	15 Chairs manufactured in 48 hours.
10	10/48	10 Chairs manufactured in 48 hours.
☎	CALL	FOR LEAD TIME: 1-800-433-6614

1. CHOOSE YOUR STARTING LIST BASE MODEL.

BACK TYPE ↓	SEAT SIZE →	Standard A seat.	Medium B seat.	Large C seat.
Low back.	PART #	15 114	15 115	15 116
	STARTING LIST PRICE	\$642	\$723	\$792
	IMAGE			
	STARTING MODEL #	114-3C-0A-18BB-16HP-GR A	115-3C-0A-18BB-16HP-GR A	116-3C-0A-18BB-16HP-GR A
	COM COL CHAIR	0.75 yd 12.23 sq ft	0.75 yd 12.9 sq ft	1 yd 14.5 sq ft
Mid back.	PART #	15 124	15 125	15 126
	STARTING LIST PRICE	\$673	\$754	\$844
	IMAGE			
	STARTING MODEL #	124-3C-0A-18BB-16HP-GR A	125-3C-0A-18BB-16HP-GR A	126-3C-0A-18BB-16HP-GR A
	COM COL CHAIR	0.75 yd 16.18 sq ft	0.75 yd 14.75 sq ft	1 yd 15.25 sq ft
High back.	PART #	15 134	15 135	15 136
	STARTING LIST PRICE	\$727	\$809	\$899
	IMAGE			
	STARTING MODEL #	134-3C-0A-18BB-16HP-GR A	135-3C-0A-18BB-16HP-GR A	136-3C-0A-18BB-16HP-GR A
	COM COL CHAIR	1 yd 14.5 sq ft	1 yd 16 sq ft	1 yd 17.25 sq ft

2. DO YOU WANT TO ADD A PETITE SEAT (-1" DEPTH)?

SEAT SIZE	AA petite seat.	BB petite seat.	n/a
PART #	1PTT-	1PTT-	
PRICE	+\$69	+\$69	

3. CHOOSE YOUR CONTROL MECHANISM.

DO YOU WANT A CHAIR? SELECT YOUR CONTROL.

USE ON	USE WITH	PART#	PRICE	DETAILS	GASLIFT	PART #	PRICE	DETAILS	MAX WEIGHT
Chairs.	All seats.	-3C	+\$0	Active back control.	G3A: 4.8" travel.	-12SS	+\$91	Slide the seat +2" forward.	350 lb.
		-5C	+\$75	Advanced ergo control.	G3A: 4.8" travel.				300 lb.
		-6C	+\$101	Bio-sync ergo control.	G3A: 4.8" travel.				300 lb.

3a. ADD SEAT SLIDE?

DO YOU WANT A STOOL? SELECT YOUR CONTROL AND HEIGHT RANGE.

USE ON	USE WITH	PART#	PRICE	DETAILS	GASLIFT	MAX WEIGHT
Stools.	+Mid backs with AA, A, BB & B seats.	-3C-11DR	+\$156	Active back control for stools.	G5: 7.0" travel.	300 lb.
		-3C-11XDR	+\$156	Adds a polished foot ring and extended gas lift with stool height ranges. Available on all bases.	G6: 9.5" travel.	300 lb.



FIND MORE OPTIONS ON THE FOLLOWING PAGE. →

4. CHOOSE YOUR ARM TYPE.

→ DO YOU WANT AN ARMLESS CHAIR?















PART#	PRICE	IMAGE	DETAILS
-0A	+\$0		Armless chairs are standard.

→ DO YOU WANT TO ADD AN ADJUSTABLE ARM?

4a. CHOOSE YOUR ARM CAP.

4b. ADD AN UPHOLSTERED CAP?



4c. ADD ADJUSTABLE WIDTH?



PART#	PRICE	IMAGE	DETAILS	PART #	PRICE	IMAGE	DETAILS	PART#	PRICE	PART#	PRICE	DETAILS
-10A	+\$89		Black nylon straight upright height adjustable arm.	3	+\$0		Standard fixed cap.	n/a	n/a	-20AB	+\$33	Brackets can adjust the width between arms by 2" per side. Included on 18A.
				6	+\$0		Preferred fixed cap.					
-18A	+\$121		Black nylon full function arm.	3	+\$0		Standard fixed cap.	n/a	n/a	-20AB	+\$0	
				6	+\$0		Preferred fixed cap.					
-39A	+\$111		Black nylon height adjustable arm with roll back feature.	3	+\$0		Standard fixed cap.	n/a	n/a	n/a	n/a	n/a
				6	+\$0		Preferred fixed cap.					
-51A	+\$89		Black polyurethane arm with optional 8-way adjustments.	20S	+\$0		Standard fixed cap.	U	+\$ your textile grade price found in step 8.	-19AB	+\$33	Brackets can adjust the width between arms by 2" per side.
				20R	+\$42		4D rotating cap.					
-53A	+\$150		Polished aluminum arm with optional 8-way adjustments.	20S	+\$0		Standard fixed cap.	U	+\$ your textile grade price found in step 8.	-19AB	+\$33	Brackets can adjust the width between arms by 2" per side.
				20R	+\$42		4D rotating cap.					

5. CHOOSE YOUR 5-STAR SWIVEL BASE.

5a. CHOOSE YOUR CASTERS OR GLIDES.

5b. ADD SAFETY-BRAKE CASTERS?

PART#	PRICE	IMAGE	DETAILS
-18BB	+\$0		Standard black nylon base.
-18PB	+\$114		Polished aluminum base.
-18BA	+\$114		Brushed aluminum base.



PART#	PRICE	IMAGE	DETAILS
-16HP	+\$0		Black finish casters are for use on soft/carpeted floors.
-16SCG	+\$29		Grey finish casters are for use on both hard floors & soft/carpeted floors.
-16GL	+\$29		Black finish glides are for use on all floor types.

PART#	PRICE	DETAILS
-SL1	+\$29	This feature locks the casters only when you are not sitting in the chair.
-SL2	+\$29	
n/a	n/a	

6. DO YOU WANT TO ADD AN ADJUSTABLE LUMBAR SUPPORT?

PART#	PRICE	IMAGE	DETAILS
-12LUM	+\$114		Mechanical, internal lumbar support, which is adjusted by turning a dial. Clockwise = more support Counter-clockwise = less support

7. DO YOU WANT TO ADD UPHOLSTERY TO THE BACK OF THE CHAIR (IE. "BACK SHELL")?

PART#	PRICE	IMAGE	DETAILS
			Standard plastic backshell.
10 -22UBF	+\$152		An upholstered backshell for fabrics & vinyls.
10 -22UBL	+\$180		An upholstered backshell for leathers.
NOTE: Upholstered shells match the overall chair upholstery by default.			

8. ADD YOUR TEXTILE GRADE(S).

PART #	PRICE (DEPENDS ON FABRIC GRADE SELECTED)										DETAILS
	A	B	1/COM	2	3/COL	4	5	6	7	8	
All chairs.	+\$0	+\$15	+\$33	+\$64	+\$97	+\$114	+\$162	+\$194	+\$296	+\$420	All chairs.
U	+\$31	+\$31	+\$31	+\$31	+\$31	+\$31	+\$63	+\$63	+\$63	+\$63	Upholstered caps on arms 51A, 52A & 53A.
NOTE	Must include mill, pattern and colorway listed after your grade choice in your model #. For COM/COL see pg. 18. We are happy to supply yardage requirement quotes for large quantity chair orders, as material economies may be realized. Please call 1-800-433-6614 or email your customer service manager for assistance.										

FIND A QUOTING GUIDE ON THE FOLLOWING PAGE. →

BUILD YOUR MODEL

STEP #	INSTRUCTIONS	PART #	LIST PRICE
1	STARTING LIST BASE MODEL.		
2	PETITE SEAT OPTION.		
3	CONTROL OPTION.		
3a	SEAT SLIDE OPTION.		
3b	FORWARD TILT OPTION.		
3c	STOOL KIT OPTION.		
4	ARM OPTION.		
4a	ARM CAP OPTION.		
4b	UPHOLSTERED CAP OPTION.		
4c	ADJUSTABLE WIDTH BRACKET OPTION.		
5	BASE OPTION.		
5a	CASTER/GLIDE OPTION.		
5b	SAFETY-BRAKE CASTER OPTION.		
6	ADJUSTABLE LUMBAR OPTION.		
7	UPHOLSTERED BACKSHELL OPTION.		
UPHOLSTERY OPTION:			
8	SINGLE TEXTILE STANDARD: ADD GRADE, THEN ADD:		
	- (MILL PATTERN COLORWAY)		
PACKAGING:			
9	STANDARD SHIPPING: CHAIRS SHIP 95% ASSEMBLED. NO TOOLS REQUIRED.		
	CHAIRS SHIP FULLY ASSEMBLED OPTION (ADD PART # -FA AND LIST PRICE \$80 /CHAIR).		
	BLANKET WRAPPED OPTION: MINIMUM ORDER OF 150, ADD PART # -BW AND CALL FOR LIST PRICING 1-800-433-6614.		
FINAL MODEL NUMBER & TOTAL LIST:			

OR SPEC IT THE EASY WAY

via Design your perfect chair on our online builder: Spec It!
SPEC IT! <http://www.viaseating.com/specit>



specified model #:

115-5C-10A3-18BB-16HP-GR A
(MOMENTUM ORIGIN JET)

FAQ

1. Can I place a logo on my chair?

Yes, logos can be applied by embroidery on fabric, vinyl or leather. These logos must be placed at least 2" away from the edges of the seat, back and all stitch lines. Extended lead time on chairs with logos is 4-6 weeks. Please see [pg. 20](#).

DIMENSIONS & FINISHES

Dimensions and finishes can be found online. Studio V, Via Seating's engineering design team, continuously updates and works with its partners to update Via Seating products to the latest industry advances and to customer feedback. Dimensions, finishes & resources are made available online to allow for real-time updates with the most current data.

Find Terra information at viaseating.com/series/terra-chairs or scan the QR code to the right →



QR CODE

Vero

solutions: executive, management, conference, execu-task



featured image: 875-68C-55A-18PB-16SCG-GR 4 (MOMENTUM SOLACE NICKEL)

features

Breadth of Line: available as an upholstered high and mid back.

Design: distinct horizontal lines with cushions strategically placed for ergonomic comfort.

Arms: featuring sleek, fixed loops available in black matte or polished versions with black and upholstered cap options. Also offers an ergonomic 8D adjustable arm for execu-task applications.

Control Mechanisms: controls include latest quick adjust advanced synchro (no endless turning of the handle to adjust your backrest to your level of comfort) with choice of an optional 2.5" seat depth adjustment & an optional +3° forward tilt adjustment & body balance technology.

Bases: five-star swivel bases available in black nylon, polished aluminum and brushed aluminum.

Via Seating's comfort foam: a proprietary blend of high-density, injection-molded, closed-

SPEC IT! ONLINE CHAIR BUILDER
Yes.
QUICK SHIP MANUFACTURING TIME
10 chairs/48 hours.
HIGHEST WEIGHT CAPACITY
400 lb.
WARRANTY
12 years.
BIFMA LEVEL
Yes, LEVEL 2.
HEALTHIER HOSPITALS INITIATIVE (HHI)
Yes.
MINDFUL MATERIALS
Yes.
GSA (CONTRACT #: GS-28F-005CA)
Yes, SIN# 711-18.



design by Orlandini Design

Orlandini Design was founded by Paolo Orlandini. With his team of young designers, Paolo combines his 40 years of experience with a fresh, acute attention to new trends. Their style is a mixture of "formal cleaning" and "programmed personalization", producing original, forward thinking products standing the test of time.



LOWEST PRICED MODEL: \$1,037



GSA SIN #: 711-18 | MANUFACTURED IN U.S.A.

QUICK SHIP SCHEDULES

Code is listed in the starting model. Deviations from this are listed where they occur.

CODE	# MADE	DETAILS
10	10/48	10 Chairs manufactured in 48 hours.
2	2/48	2 Chairs manufactured in 48 hours.
📞	CALL	FOR LEAD TIME: 1-800-433-6614

1. CHOOSE YOUR STARTING LIST BASE MODEL.

BACK SIZE	Mid back.	High back.
PART #	10 873	10 875
STARTING LIST PRICE	\$1,037	\$1,147
IMAGE		
STARTING MODEL #	873-74C-0A-18BB-16HP-GR A	875-74C-0A-18BB-16HP-GR A
COM COL CHAIR	1.25 yd 24.5 sq ft	1.4 yd 33 sq ft

2. DO YOU WANT A FIXED CHAIR BACK?

PART #	F
STARTING PRICE	+\$0
DETAILS	Fixed back option. Standard chair has a height adjustable back feature.

3. CHOOSE YOUR CONTROL MECHANISM.

USE ON	USE WITH	PART#	PRICE	DETAILS	GASLIFT	3a. ADD SEAT SLIDE?			3b. ADD FORWARD TILT?			MAX WEIGHT
						PART #	PRICE	DETAILS	PART #	PRICE	DETAILS	
Chairs.	All seats.	-74C	+\$0	Auto-adjust body balance control.	G3A: 4.8" travel.	-12SS	+\$91	Slide the seat +2" forward.	n/a	n/a	n/a	400 lb.
	All seats.	-67C	+\$4	Quick adjust advanced synchro control featuring single rotation adjustments.	G3A: 4.8" travel.	n/a	n/a	n/a	n/a	n/a	n/a	400 lb.
	All seats.	-67CSS	+\$95	Quick adjust advanced synchro control featuring single rotation adjustments with a seat slide.	G3A: 4.8" travel.		+\$0	Included. Slide the seat +2" forward.	-FT	+\$42	+3° of a forward tilt.	400 lb.
	All seats.	-68C	+\$127	Enhanced body balance control with dynamic fine-tuning.	G3A: 4.8" travel.	-12SS	+\$91	Slide the seat +2.5" forward.	n/a	n/a	n/a	400 lb.
NOTE	Discontinuing options 61C, 62C & 66C are best replaced by the latest ergonomic technology 67C, 67CSS & 74C, respectively. More details pg. 180.											

4. CHOOSE YOUR ARM TYPE.

DO YOU WANT AN ARMLESS CHAIR?





PART#	PRICE	IMAGE	DETAILS
-0A	+\$0		Armless chairs are standard.

DO YOU WANT TO ADD AN ADJUSTABLE ARM?

4a. CHOOSE YOUR ARM CAP.

4b. ADD AN UPHOLSTERED CAP?







4c. ADD ADJUSTABLE WIDTH?

PART#	PRICE	IMAGE	DETAILS	PART #	PRICE	IMAGE	DETAILS	PART#	PRICE	PART#	PRICE	DETAILS
-51A	+\$89		Black polyurethane arm with optional 8-way adjustments.	20S	+\$0		Standard fixed cap.	U	+\$ your textile grade price found in step 6.	-19AB	+\$33	Brackets can adjust the width between arms by 2" per side.
				20R	+\$42							
-53A	+\$150		Polished aluminum arm with optional 8-way adjustments.	20S	+\$0		Standard fixed cap.					
				20R	+\$42							

FIXED ARM OPTIONS ON FOLLOWING PAGE. →

DO YOU WANT TO ADD A FIXED ARM?



3d. ADD UPHOLSTERY ON SELECT ARMS.



PART#	PRICE	IMAGE	DETAILS	TEXTILE GRADE PRICE	ARM COM COL
2 -48A	+\$410		Fully upholstered modern panel arm with a wood interior.	+\$ your textile grade price from step 6.	add 0.72 yd 9 sq ft
-54A	+\$188		Polished aluminum fixed loop arm.	n/a	n/a
-55A	+\$227		Polished aluminum fixed loop arm with a black polyurethane cap.	n/a	n/a
-59A	+\$129		Black polyurethane fixed loop arm.	n/a	n/a
2 -61A	+\$260		Polished aluminum fixed loop arm with a fully upholstered polyurethane cap.	+\$ your textile grade price from step 6.	add 0.75 yd 1.6 sq ft
-96A	+\$166		Black polyurethane contemporary cantilever arm.	n/a	n/a
-97A	+\$227		Polished aluminum contemporary cantilever arm with a black polyurethane cap.	n/a	n/a

5. CHOOSE YOUR 5-STAR SWIVEL BASE.

5a. CHOOSE YOUR CASTERS OR GLIDES.

5b. ADD SAFETY-BRAKE CASTERS?

PART#	PRICE	IMAGE	DETAILS
-18BB	+\$0		Standard black nylon base.
-18PB	+\$114		Polished aluminum base.
-18BA	+\$114		Brushed aluminum base.

PART#	PRICE	IMAGE	DETAILS
-16HP	+\$0		Black finish casters are for use on soft/carpeted floors.
-16SCG	+\$29		Grey finish casters are for use on both hard floors & soft/carpeted floors.
-16GL	+\$29		Black finish glides are for use on all floor types.

PART#	PRICE	DETAILS
-SL1	+\$29	This feature locks the casters only when you are not sitting in the chair.
-SL2	+\$29	
n/a	n/a	

6. ADD YOUR TEXTILE GRADE(S).

PART #	PRICE (DEPENDS ON FABRIC GRADE SELECTED)										DETAILS
	A	B	1/COM	2	3/COL	4	5	6	7	8	
873	+\$0	+\$38	+\$116	+\$186	+\$272	+\$379	+\$493	+\$633	+\$842	+\$1095	Mid back.
875	+\$0	+\$42	+\$127	+\$205	+\$299	+\$417	+\$543	+\$698	+\$927	+\$1204	High back.
U	+\$31	+\$31	+\$31	+\$31	+\$31	+\$31	+\$63	+\$63	+\$63	+\$63	Upholstered caps on arms 51A , 52A & 53A .
48A	+\$0	+\$13	+\$33	+\$64	+\$98	+\$143	+\$198	+\$265	+\$347	+\$444	Fully upholstered arm.
61A	+\$0	+\$0	+\$0	+\$0	+\$0	+\$0	+\$33	+\$33	+\$33	+\$33	Fully upholstered cap on arm.
NOTE	Must include mill, pattern and colorway listed after your grade choice in your model #. For COM/COL see pg. 18. We are happy to supply yardage requirement quotes for large quantity chair orders, as material economies may be realized. Please call 1-800-433-6614 or email your customer service manager for assistance.										

6a. DO YOU WANT TO USE MULTIPLE TEXTILES ON YOUR CHAIR? IF YES, PLEASE LIST YOUR TEXTILES IN THIS ORDER:

UPHOLSTERY LAYOUT	USE WITH	ORDER	DETAILS TO ADD TO YOUR MODEL #	IMPORTANT NOTES
	873 & 875	1	SEAT (MILL PATTERN COLORWAY)	Seat textile will be applied to a selected 20SU or 20RU arm cap and 61A .
	873 & 875	2	BOTTOM PANEL (MILL PATTERN COLORWAY)	n/a
	873 & 875	3	MIDDLE PANEL (MILL PATTERN COLORWAY)	n/a
	875	4	TOP PANEL (MILL PATTERN COLORWAY)	n/a

FIND A QUOTING GUIDE ON THE FOLLOWING PAGE. →

BUILD YOUR MODEL

STEP #	INSTRUCTIONS	PART #	LIST PRICE
1	STARTING LIST BASE MODEL.		
2	FIXED BACK OPTION (STANDARD BACK IS HEIGHT ADJUSTABLE).		
3	CONTROL OPTION.		
3a	SEAT SLIDE OPTION.		
3b	FORWARD TILT OPTION.		
4	ARM OPTION.		
4a	ARM CAP OPTION.		
4b	UPHOLSTERED CAP OPTION.		
4c	ADJUSTABLE ARM WIDTH BRACKET OPTION.		
4d	ARM UPHOLSTERY OPTION.		
5	BASE OPTION.		
5a	CASTER/GLIDE OPTION.		
5b	SAFETY-BRAKE CASTER OPTION.		
UPHOLSTERY OPTION: CHOOSE 6 OR 6a, CHOOSING HIGHEST GRADE FOR LIST PRICE.			
6	SINGLE TEXTILE STANDARD: ADD GRADE, THEN ADD: - (MILL PATTERN COLORWAY)		
	FOUR-TONE UPHOLSTERY OPTION: ADD GRADE, THEN ADD: - SEAT (MILL PATTERN COLORWAY)		
6a	- BOTTOM PANEL (MILL PATTERN COLORWAY)		
	- MIDDLE PANEL (MILL PATTERN COLORWAY)		
	- TOP PANEL (MILL PATTERN COLORWAY)		
PACKAGING:			
7	STANDARD SHIPPING: CHAIRS SHIP 95% ASSEMBLED. NO TOOLS REQUIRED.		
	CHAIRS SHIP FULLY ASSEMBLED OPTION (ADD PART # -FA AND LIST PRICE \$80/CHAIR).		
	BLANKET WRAPPED OPTION: MINIMUM ORDER OF 150, ADD PART # -BW AND CALL FOR LIST PRICING 1-800-433-6614.		
FINAL MODEL NUMBER & TOTAL LIST:			

OR SPEC IT THE EASY WAY

via Design your perfect chair on our online builder: Spec It!
SPEC IT! <http://www.viaseating.com/specit>



specified model #:

875-68C-55A-18PB-16SCG-GR 4
(MOMENTUM SOLACE NICKEL)

FAQ

1. Can I place a logo on my chair?

Yes, logos can be applied by embroidery on fabric, vinyl or leather. These logos must be placed at least 2" away from the edges of the seat, back and any stitch lines. Extended lead time on chairs with logos is 4-6 weeks. Please see **pg. 20**.

2. Is the seat slider included on any controls?

The seat slider is included on the **67CSS** control. The seat slider is optional on the **68C** & **74C** controls.

DIMENSIONS & FINISHES

Dimensions and finishes can be found online. Studio V, Via Seating's engineering design team, continuously updates and works with its partners to update Via Seating products to the latest industry advances and to customer feedback. Dimensions, finishes & resources are made available online to allow for real-time updates with the most current data.



QR CODE

Find Vero information at viaseating.com/series/vero-chairs or scan the QR code to the right →

Vista II

solutions: multi-use, stacking, side/guest, bar & counter stool



featured image: 312-S-49A-5V-GR 5 (MAHARAM LARIAT CUCUMBER)

features

Breadth of Line: available as a stackable side/guest chair, a side/guest chair on wheels, a 4-leg bar or counter height stool and a bariatric chair.

Backs: features a designer cut out shape that is poly, mesh or upholstered. This shape assists with movement and allows for easy cleaning.

Arms: choice of armless or the addition of a black or grey arm.

Frames: choice of matte black or silver frame. Both feature matching glides.

Via Seating's comfort foam: a proprietary blend of high-density, injection-molded, closed-cell, cold-cured foam so durable and lasting it is backed by Via Seating's 12 year warranty.

SPEC IT! ONLINE CHAIR BUILDER
Yes.
QUICK SHIP MANUFACTURING TIME
5-20 chairs/48 hours.
HIGHEST WEIGHT CAPACITY
500 lb.
WARRANTY
12 years, 5 years for mesh.
BIFMA LEVEL
Yes, LEVEL 2. ¹
HEALTHIER HOSPITALS INITIATIVE (HHI)
Yes.
MINDFUL MATERIALS
Yes.
GSA (CONTRACT #: GS-28F-005CA)
Yes, SIN# 711-19.

1. NOTE New product Vista II Poly Poly is being assessed for BIFMA LEVEL certification under a separate certification.



design by Studio V

Studio V creates modern, sophisticated and original seating solutions that are ergonomic, beautiful and sustainable. This team of engineers, sustainability experts and designers is based in Reno, Nevada. Studio V develops products using a prototyping lab, the latest in 3D modeling software and a materials testing center.



Vista II

LOWEST PRICED MODEL: \$287







GSA SIN #: 711-19 | MANUFACTURED IN U.S.A.

QUICK SHIP SCHEDULES



Code is listed in the starting model. Deviations from this are listed where they occur.

CODE	# MADE	DETAILS
20	20/48	20 Chairs manufactured in 48 hours.
10	10/48	10 Chairs manufactured in 48 hours.
5	5/48	5 Chairs manufactured in 48 hours.
📞	CALL	FOR LEAD TIME: 1-800-433-6614.

1. CHOOSE YOUR STARTING LIST BASE MODEL.

BACK TYPE ↓	CHAIR TYPE →	Armless chair.	Armless stool.	Armless bariatric chair.
Poly Poly. <u>Important note:</u> Available now.	PART #	20 330	20 331	n/a
	STARTING LIST PRICE	\$287	\$337	
	IMAGE			
	STARTING MODEL #	330-B-B-0A	331-B-B-0A	
	STACKS	2 high on floor.	n/a	
	SHIPS	2 per box.	1 per box.	
	MAX WEIGHT	500 lb.	350 lb.	
Mesh back.	PART #	20 312	20 313	n/a
	STARTING LIST PRICE	\$343	\$395	
	IMAGE			
	STARTING MODEL #	312-B-0A-01V-GR A	313-B-0A-01V-GR A	
	STACKS	2 high on floor.	n/a	
	SHIPS	2 per box.	1 per box.	
	COM COL CHAIR	0.75 yd 6.7 sq ft	0.75 yd 6.7 sq ft	
Upholstered back.	PART #	20 302	20 303	5 307
	STARTING LIST PRICE	\$380	\$509	\$919
	IMAGE			
	STARTING MODEL #	302-B-0A-GR A	303-B-0A-GR A	307-B-0A-GR A
	STACKS	2 high on floor.	n/a	n/a
	SHIPS	2 per box.	1 per box.	1 per box.
	COM COL SEAT ONLY	0.75 yd 6.7 sq ft	0.75 yd 6.7 sq ft	0.75 yd 9 sq ft
	COM COL BACK ONLY	0.75 yd 5.8 sq ft	0.75 yd 5.8 sq ft	1.5 yd 16.38 sq ft
	COM COL WHOLE CHAIR	0.75 yd 12.9 sq ft	0.75 yd 12.9 sq ft	2.25 yd 25.22 sq ft
	MAX WEIGHT	500 lb.	350 lb.	500 lb.

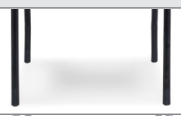
2. CHOOSE YOUR FRAME FINISH.

PART#	PRICE	IMAGE	DETAILS
-B	+\$0		Matte black frame with a black glide.
-S	+\$45		Powder-coat silver frame with a grey glide.

FIND MORE OPTIONS ON THE FOLLOWING PAGE. →

3. CHOOSE YOUR POLY COLOR.



PART#	-B
PRICE	+\$0
IMAGE	
DETAILS	Standard black.

4. CHOOSE YOUR ARM TYPE.

→ **DO YOU WANT AN ARMLESS CHAIR?**

PART#	PRICE	IMAGE	DETAILS
-0A	+\$0		Armless chairs are standard.

→ **DO YOU WANT TO ADD A FIXED ARM?**

PART#	PRICE	IMAGE	DETAILS
-32A	+\$65		Matte black polyurethane loop arm fixed to frame.
-49A	+\$65		Matte grey polyurethane loop arm fixed to frame.





5. DO YOU WANT A MOBILE SIDE CHAIR (CHAIR ON WHEELS)?

USE WITH	PART#	PRICE	IMAGE	DETAILS	MAX WEIGHT
 Chairs 302, 312 & 330.	-WH	+\$76		These casters have a black finish. Casters cannot be retrofitted onto existing models.	350 lb.

6. CHOOSE YOUR MESH COLOR.

USE WITH	PART#	-01V	-02V	 -03V	 -04V	 -05V	 -06V	 -08V	 -11V	 -12V
 Mesh backs 312 & 313.	PRICE	+\$0	+\$0	+\$0	+\$0	+\$0	+\$0	+\$0	+\$43	+\$43
	IMAGE									
	DETAILS	Standard black.	Silver.	Blue.	Orange.	Green.	Cardinal red.	Coffee.	Black copper.	Natural copper.



7. DO YOU WANT TO ADD UPHOLSTERY TO THE BACK OF THE BACKREST?

USE WITH	PART#	 -20UPH	NOTES
 Chairs 302 & 303.	PRICE	+\$0	Upholstered shells match the overall chair upholstery.
	IMAGE	 	Bariatric chair 307 always has an upholstered back.
	DETAILS	Standard backshell is a smooth, black plastic.	An upholstered backshell for applying fabrics or vinyls. Add .4 yd to COM on 302 & 303.

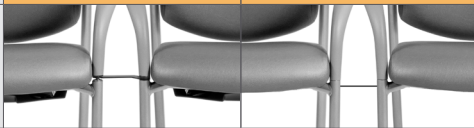
8. DO YOU WANT TO ADD GANGING BRACKETS?

PART#	-33GNR	-32GNP	NOTES
PRICE	+\$73	+\$73	<ul style="list-style-type: none"> Chairs can be gangered to other chairs and bariatric chairs. Chairs or bariatric chairs can't be gangered to stools. Stools can be gangered to stools.
IMAGE			
DETAILS	Unlockable latch, permanent chair ganging brackets. Chairs can be unlocked and moved. Mounts beneath arms.	Fixed, permanent ganging brackets. Mounts under the seats in place of the seat pans. Brackets to be installed on site.	

9. POLY POLY: DO YOU WANT TO ADD UPHOLSTERY? IF YES, ADD THE PART # AND SELECT YOUR TEXTILE GRADE.

PART #	IMAGE	DETAILS	COM COL	PRICE (DEPENDS ON FABRIC GRADE SELECTED)									
				A	B	1/COM	2	3/COL	4	5	6	7	8
 -9US		Optional upholstered seat.	0.76 yd 6.7 sq ft	+\$57	+\$78	+\$101	+\$131	+\$166	+\$202	+\$252	+\$307	+\$396	+\$499

10. ADD YOUR TEXTILE GRADE(S).

PART #	PRICE (DEPENDS ON FABRIC GRADE SELECTED)										DETAILS
	A	B	1/COM	2	3/COL	4	5	6	7	8	
312 & 313	+\$0	+\$21	+\$44	+\$74	+\$109	+\$145	+\$195	+\$250	+\$339	+\$442	Mesh back chairs.
302, 303 & 307	+\$0	+\$25	+\$88	+\$124	+\$186	+\$272	+\$361	+\$494	+\$644	+\$828	Upholstered back chairs.
NOTE	Must include mill, pattern and colorway listed after your grade choice in your model #. For COM/COL see pg. 18. We are happy to supply yardage requirement quotes for large quantity chair orders, as material economies may be realized. Please call 1-800-433-6614 or email your customer service manager for assistance.										

FIND MORE OPTIONS ON THE FOLLOWING PAGE. →

10a. DO YOU WANT TWO-TONE ON YOUR UPHOLSTERED BACK CHAIR? IF YES, PLEASE LIST YOUR TEXTILES IN THIS ORDER:

UPHOLSTERY LAYOUT	ORDER	DETAILS TO ADD TO YOUR MODEL #	IMPORTANT NOTES ON APPLICATIONS OF TEXTILES
	1	SEAT (MILL PATTERN COLORWAY)	Seat textile will be applied to the seat.
	2	BACK (MILL PATTERN COLORWAY)	Back textile will be applied to the front & optional upholstered back of the backrest (ie. "backshell"). On model 307, the backshell is always upholstered.

BUILD YOUR MODEL

STEP #	INSTRUCTIONS	PART #	LIST PRICE
1	STARTING LIST BASE MODEL.		
2	FRAME FINISH.		
3	<u>POLY POLY SHELL COLOR.</u>		
4	ARM OPTION.		
5	<u>CHAIRS CASTER OPTION.</u>		
6	MESH COLOR.		
7	UPHOLSTERED BACKSHELL OPTION.		
8	GANGING BRACKETS OPTION.		
9	<u>POLY POLY UPHOLSTERED SEAT OPTION.</u>		
UPHOLSTERY OPTION: CHOOSE 8 OR 8a, CHOOSING HIGHEST GRADE FOR LIST PRICE.			
10	SINGLE TEXTILE STANDARD: ADD GRADE, THEN ADD: - (MILL PATTERN COLORWAY)		
	TWO-TONE UPHOLSTERY OPTION: ADD GRADE, THEN ADD: - SEAT (MILL PATTERN COLORWAY) - BACK (MILL PATTERN COLORWAY)		
PACKAGING OPTIONS:			
11	STANDARD SHIPPING: CHAIRS SHIP FULLY ASSEMBLED.		
	SINGLE CHAIR ORDERS: FOR 302, 312 & 330 ADD PART # -SC AND LIST PRICE \$63.		

OR SPEC IT THE EASY WAY.

via Design your perfect chair on our online builder: Spec It!
SPEC IT! <http://www.viaseating.com/specit>



featured model #:
 312-S-49A-5V-GR 5 (MAHARAM LARIAT CUCUMBER)

FAQ

1. Can I place a logo on my chair?

Yes, logos can be applied by embroidery on fabric, vinyl or leather. These logos must be placed at least 2" away from the edges of the back and all stitch lines. Embroidery can be applied to the front or an upholstered backshell. Extended lead time on chairs with logos is 4-6 weeks. Please see pg. 20.

DIMENSIONS & FINISHES

Dimensions and finishes can be found online. Studio V, Via Seating's engineering design team, continuously updates and works with its partners to update Via Seating products to the latest industry advances and to customer feedback. Dimensions, finishes & resources are made available online to allow for real-time updates with the most current data.

Find Sutro information at viaseating.com/series/vista-ii-chairs or scan the QR code to the right →



QR CODE



featured image: 2V25-10C-90A-18BB-16HP-GR 6 (VIA SEATING VIA LEATHERS BLACK 95)

features

Breadth of Line: available as high and mid upholstered back.

Headrest: upholstered high back features a stylish, adjustable headrest.

Stitching: distinguished stitching on the front and back.

Arms: choices include ergonomic 8D adjustable arms or executive “C” shape fixed arms in black polyurethane or upholstery.

Control Mechanisms: controls include latest quick adjust advanced synchro (no endless turning of the handle to adjust your backrest to your level of comfort) with choice of an optional 2.5” seat depth adjustment & an optional +3° forward tilt adjustment.

Bases: five-star swivel bases available in black nylon, polished aluminum and brushed aluminum.

Via Seating’s comfort foam: a proprietary blend of high-density, injection-molded, closed-cell, cold-cured foam so durable and lasting it is backed by Via Seating’s 12 year warranty.

SPEC IT! ONLINE CHAIR BUILDER
Yes.
QUICK SHIP MANUFACTURING TIME
15 chairs/48 hours.
HIGHEST WEIGHT CAPACITY
300 lb.
WARRANTY
12 years, 2 years for mesh.
BIFMA LEVEL
Yes, LEVEL 2.
HEALTHIER HOSPITALS INITIATIVE (HHI)
Yes.
MINDFUL MATERIALS
Yes.
GSA (CONTRACT #: GS-28F-005CA)
Yes, SIN# 711-18.



design by Studio V

Studio V creates modern, sophisticated and original seating solutions that are ergonomic, beautiful and sustainable. This team of engineers, sustainability experts and designers is based in Reno, Nevada. Studio V develops products using a prototyping lab, the latest in 3D modeling software and a materials testing center.



LOWEST PRICED MODEL: \$1,456





GSA SIN #: 711-18 | MANUFACTURED IN U.S.A.

QUICK SHIP SCHEDULES

Code is listed in the starting model. Deviations from this are listed where they occur.

CODE	# MADE	DETAILS
15	15/48	15 Chairs manufactured in 48 hours.
2	2/48	2 Chairs manufactured in 48 hours.
📞	CALL	FOR LEAD TIME: 1-800-433-6614

1. CHOOSE YOUR STARTING LIST BASE MODEL.

BACK TYPE ↓	SEAT SIZE →	Medium seat.	Large seat.
Mid back.	PART #	15 2V27	15 2V37
	STARTING LIST PRICE	\$1,456	\$1,571
	IMAGE		
	STARTING MODEL #	2V27-12C-0A-18BB-16GP-GR A	2V37-12C-0A-18BB-16GP-GR A
	COM COL CHAIR	1.75 yd 23.3 sq ft	1.75 yd 22.9 sq ft
High back.	PART #	15 2V25	15 2V35
	STARTING LIST PRICE	\$1,533	\$1,623
	IMAGE		
	STARTING MODEL #	2V25-12C-0A-18BB-16GP-GR A	2V35-12C-0A-18BB-16GP-GR A
	COM COL CHAIR	1.75 yd 24.2 sq ft	1.75 yd 24.4 sq ft

2. CHOOSE YOUR CONTROL MECHANISM.

USE WITH	PART#	PRICE	DETAILS	2a. ADD SEAT SLIDE?			2b. ADD FORWARD TILT?			2c. ADD A SHORTER ADJUSTMENT HANDLE?			MAX WEIGHT
				PART #	PRICE	DETAILS	PART #	PRICE	DETAILS	PART #	PRICE	DETAILS	
All backs.	-12C	+\$0	Single position knee tilt control.	n/a	n/a	n/a	n/a	n/a	n/a	-1CRC	+\$0	Shortened conference adjustment handle.	275 lb.
	13C	+\$91	Single position knee tilt control and a seat slide.		+\$0	Included. +/- 2".	n/a	n/a	n/a				275 lb.
High backs only.	-9CH	+\$65	Synchro control with heavy-duty spring tension.	n/a	n/a	n/a	n/a	n/a	n/a	n/a	n/a	n/a	300 lb.
	-10CH	+\$156	Synchro control with heavy-duty spring tension and a seat slide.		+\$0	Included. +/- 2".	n/a	n/a	n/a	n/a	n/a	n/a	300 lb.
Mid backs only.	-67C	+\$91	Quick adjust advanced synchro control featuring single rotation adjustments.	n/a	n/a	n/a	n/a	n/a	n/a	n/a	n/a	n/a	350 lb.
	-67CSS	+\$182	Quick adjust advanced synchro control featuring single rotation adjustments and a seat slide.		+\$0	Included. Slide the seat +2.5 in forward.	-FT	+\$42	+3° of a forward tilt.	n/a	n/a	n/a	350 lb.

NOTE Discontinuing options 9C & 10C are best replaced by the latest ergonomic technology 67C & 67CSS, respectively. More details pg. 180.

FIND MORE OPTIONS ON THE FOLLOWING PAGE. →

3. CHOOSE YOUR ARM TYPE.

DO YOU WANT AN ARMLESS CHAIR?













PART#	PRICE	IMAGE	DETAILS
-0A	+\$0		Armless chairs are standard.

DO YOU WANT TO ADD AN ADJUSTABLE ARM?

3a. CHOOSE YOUR ARM CAP.



3b. ADD AN UPHOLSTERED CAP?

3c. ADD ADJUSTABLE WIDTH?

PART#	PRICE	IMAGE	DETAILS	PART #	PRICE	IMAGE	DETAILS	PART#	PRICE	PART#	PRICE	DETAILS
-38A	+\$55		Black nylon basic height adjustable arm.	8	+\$0		Standard fixed cap.	n/a	n/a	-19AB	+\$33	Brackets can adjust the width between arms by 2" per side.
				6	+\$0		Preferred fixed cap.					
-39A	+\$111		Black nylon height adjustable arm with roll back feature.	8	+\$0		Standard fixed cap.	n/a	n/a	n/a	n/a	
				6	+\$0		Preferred fixed cap.					
-51A	+\$89		Black polyurethane arm with optional 8-way adjustments.	20S	+\$0		Standard fixed cap.	U	+\$ your textile grade price found in step 6.	-19AB	+\$33	Brackets can adjust the width between arms by 2" per side.
				20R	+\$42		4D rotating cap.					
-53A	+\$150		Polished aluminum arm with optional 8-way adjustments.	20S	+\$0		Standard fixed cap.					
				20R	+\$42		4D rotating cap.					

DO YOU WANT TO ADD A FIXED ARM?



3d. ADD UPHOLSTERY ON SELECT ARMS.



PART#	PRICE	IMAGE	DETAILS	TEXTILE GRADE PRICE	ARM COM COL
-80A	+\$216		Black polyurethane executive "C" shape arm.	n/a	n/a
2 -90A	+\$297		Fully upholstered executive "C" shape arm with a polyurethane interior.	+\$ your textile grade price from step 6.	add 1.25 yd 8 sq ft

4. CHOOSE YOUR 5-STAR SWIVEL BASE.

5a. CHOOSE YOUR CASTERS OR GLIDES.

5b. ADD SAFETY-BRAKE CASTERS?

PART#	PRICE	IMAGE	DETAILS
-18BB	+\$0		Standard black nylon base.
-18PB	+\$114		Polished aluminum base.
-18BA	+\$114		Brushed aluminum base.

PART#	PRICE	IMAGE	DETAILS
-16HP	+\$0		Black finish casters are for use on soft/carpeted floors.
-16SCG	+\$29		Grey finish casters are for use on both hard floors & soft/carpeted floors.
-16GL	+\$29		Black finish glides are for use on all floor types.

PART#	PRICE	DETAILS
-SL1	+\$29	This feature locks the casters only when you are not sitting in the chair.
-SL2	+\$29	
n/a	n/a	

5. DO YOU WANT TO ADD ADJUSTABLE LUMBAR SUPPORT?

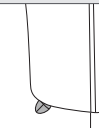
PART#	PRICE	IMAGE	DETAILS
-13AIR	+\$82		Air ball, internal lumbar support, which is adjusted by pumping the valve. Tighten & pump = increase lumbar support Release = reduce lumbar support

6. ADD YOUR TEXTILE GRADE(S).

PART #	PRICE (DEPENDS ON FABRIC GRADE SELECTED)										DETAILS
	A	B	1/COM	2	3/COL	4	5	6	7	8	
2V27 & 2V37	+\$0	+\$46	+\$99	+\$187	+\$306	+\$424	+\$794	+\$1055	+\$1317	+\$1578	Upholstered mid backs, all seats.
2V25 & 2V35	+\$0	+\$53	+\$115	+\$190	+\$317	+\$520	+\$854	+\$1142	+\$1430	+\$1716	Upholstered high backs, all seats.
U	+\$31	+\$31	+\$31	+\$31	+\$31	+\$31	+\$63	+\$63	+\$63	+\$63	Upholstered caps on arms 51A & 53A.
90A	+\$0	+\$2	+\$4	+\$8	+\$10	+\$18	+\$22	+\$30	+\$41	+\$52	Fully upholstered arm.
NOTE	Must include mill, pattern and colorway listed after your grade choice in your model #. For COM/COL see pg. 18. We are happy to supply yardage requirement quotes for large quantity chair orders, as material economies may be realized. Please call 1-800-433-6614 or email your customer service manager for assistance.										

FIND A QUOTING GUIDE ON THE FOLLOWING PAGE. →

BUILD YOUR MODEL

STEP #	INSTRUCTIONS	PART #	LIST PRICE
1	STARTING LIST BASE MODEL.		
2	CONTROL OPTION.		
2a	SEAT SLIDE OPTION.		
2b	FORWARD TILT OPTION.		
2c	STOOL KIT OPTION.		
2d	SHORTER CONFERENCE HANDLE OPTION.		
3	ARM OPTION.		
3a	ARM CAP OPTION.		
3b	UPHOLSTERED CAP OPTION.		
3c	ADJUSTABLE WIDTH BRACKET OPTION.		
3d	ARM UPHOLSTERY OPTION.		
4	BASE OPTION.		
4a	CASTER/GLIDE OPTION.		
4b	SAFETY-BRAKE CASTER OPTION.		
5	ADJUSTABLE LUMBAR SUPPORT OPTION.		
UPHOLSTERY:			
6	SINGLE TEXTILE STANDARD: ADD GRADE, THEN ADD: - (MILL PATTERN COLORWAY)		
PACKAGING:			
7	STANDARD SHIPPING: CHAIRS SHIP 95% ASSEMBLED. NO TOOLS REQUIRED.		
	CHAIRS SHIP FULLY ASSEMBLED OPTION (ADD PART # -FA AND LIST PRICE \$80/CHAIR).		
	BLANKET WRAPPED OPTION: MINIMUM ORDER OF 150, ADD PART # -BW AND CALL FOR LIST PRICING 1-800-433-6614.		
FINAL MODEL NUMBER & TOTAL LIST:			

OR SPEC IT THE EASY WAY

via
SPEC IT! Design your perfect chair on our online builder: Spec It!
<http://www.viaseating.com/specit>



specified model #:
2V25-10CH-90A-18BB-16HP-GR 6
(VIA SEATING VIA LEATHERS BLACK 95)

FAQ

1. Can I place a logo on my Voss chair?

Yes, logos can be applied by embroidery on fabric, vinyl & leather. These logos must be placed at least 2" away from the edges of the seat, back and any stitch lines. Extended lead time on chairs with logos is 4-6 weeks. Please see **pg. 20**.

1. Is there a mesh back version of Voss?

The Riva series offers high & mid backs, which use the Voss-style seat. This style is called the "tailored seat". These options can be found in the Riva series on **pg. 113**.

DIMENSIONS & FINISHES

Dimensions and finishes can be found online. Studio V, Via Seating's engineering design team, continuously updates and works with its partners to update Via Seating products to the latest industry advances and to customer feedback. Dimensions, finishes & resources are made available online to allow for real-time updates with the most current data.



QR CODE

Find Voss information at viaseating.com/series/voss-collection or scan the QR code to the right →

solutions: multi-use, stacking, side/guest, bar & counter stool, light task chair & stool



featured image: 761-N-03Z

features

Breadth of Line: available as stackable side/guest chairs, a 4-leg bar or counter height stool, a designer side/guest chair on a 4-leg wood frame, a light task chair and a light task stool.

Designer Shape: sculpted shell curves around the body, providing a welcoming poly seat with integrated arms.

Stackable Options: both the 4-leg and sled base side/guest chairs are stackable with option of stacking on a transport cart.

Upholstery: available with an optional upholstered seat.

SPEC IT! ONLINE CHAIR BUILDER
Yes.
QUICK SHIP MANUFACTURING TIME
10-20 chairs/48 hours.
HIGHEST WEIGHT CAPACITY
400 lb.
WARRANTY
6 years.
BIFMA LEVEL
Yes, LEVEL 2.
HEALTHIER HOSPITALS INITIATIVE (HHI)
Yes.
MINDFUL MATERIALS
Yes.
GSA (CONTRACT #: GS-28F-005CA)
Yes, SIN# 711-19.

design by GREY ID



Industrial design does not end in the talent of a single designer but encompasses the skills of young creative professionals working in the various disciplines of industrial planning: from concept to development, to provide support to the different stages of product engineering; they are dealing with the correct ways of communicating their projects both in terms of design and exhibitions. This is the perspective of GREY ID.



LOWEST PRICED MODEL: \$303











GSA SIN #: 711-19 | MANUFACTURED IN U.S.A.

QUICK SHIP SCHEDULES







Code is listed in the starting model. Deviations from this are listed where they occur.

CODE	# MADE	DETAILS
20	20/48	20 Chairs manufactured in 48 hours.
10	10/48	10 Chairs manufactured in 48 hours.
📞	CALL	FOR LEAD TIME: 1-800-433-6614.

1. CHOOSE YOUR STARTING LIST BASE MODEL.





PART #	STARTING PRICE	IMAGE	DETAILS	MODEL #	STACKS	MAX WEIGHT	PART #	-B	-C	-S
20 731	\$350		Stackable chair on a 4-leg base.	731-B-01Z	9 poly seat and 7 upholstered seat on the floor.	300 lb.	PRICE	+\$0	+\$43	+\$43
20 721	\$415		Stackable chair on a sled base.	721-B-01Z		400 lb.	IMAGE			
20 751	\$565		Barstool on a 4-leg base with an integrated footrest.	751-B-01Z	n/a	300 lb.	DETAILS	Black frame with matching black glides.	Chrome frame with neutral glides.	Powder-coated silver finish frame with neutral glides.
20 761	\$517		Guest/side chair on a modern wood base.	761-N-01Z	n/a	300 lb.	PART #	-N		
							PRICE	+\$0		
							IMAGE			
							DETAILS	Beech wood frame with felt glides beneath the legs.		
20 741	\$458		Light task chair.	741-B-01Z	n/a	300 lb.	PART #	-C		
							PRICE	+\$0		
							IMAGE			
							DETAILS	Chrome mechanism with height adjustment & 360 degree swivel.		
20 600C	\$303		Stacking transport cart for chairs in a polished finish with red handle and wheels caps.	600C	*8 poly seat and 6 upholstered seat on the cart.	127.5 lb.	n/a			

3. CHOOSE YOUR SHELL COLOR.

PART#	-01Z	-02Z	-03Z	-04Z	-05Z	-06Z	-07Z
PRICE	+\$0	+\$0	+\$0	+\$0	+\$0	+\$0	+\$0
IMAGE							
DETAILS	Black shell.	Dark grey shell.	White shell.	Blue shell.	Orange shell.	Green shell.	Red shell.





FIND MORE OPTIONS ON THE FOLLOWING PAGE. →

4. CHOOSE YOUR 5-STAR SWIVEL BASE.



USE WITH	PART#	PRICE	IMAGE	DETAILS
 741 only.	-13BB	+\$0		Standard black nylon high-crown base with a mindfully compact footprint.
	-18BB	+\$0		Black nylon base. Standard for light task stools.
	-18PB	+\$114		Polished aluminum base.
	-18BA	+\$114		Brushed aluminum base.

4a. CHOOSE YOUR CASTERS OR GLIDES.

4b. ADD SAFETY-BRAKE CASTERS?

USE WITH	PART#	PRICE	IMAGE	DETAILS	PART#	PRICE	DETAILS
 741 only.	-16HP	+\$0		Standard black finish casters are for use on soft/carpeted floors.	-SL1	+\$29	This feature locks the casters only when you are not sitting in the chair.
	-16SCG	+\$29		Grey finish casters are for use on both hard floors & soft/carpeted floors.	-SL2	+\$29	
	-16GL	+\$29		Black finish glides are for use on all floor types.	n/a	n/a	n/a

4c. DO YOU WANT TO MAKE YOUR CHAIR A LIGHT TASK STOOL?

USE WITH	FOR BASES	PART #	PRICE	IMAGE	STOOL KIT OPTION
 741 only.	18BB, 18PB, 18BA only.	-11DR	+\$156		Tall stool kit (extended gas lift & a footring footrest) gives 7 in of vertical travel.
		-11XDR	+\$156		Extra-tall stool kit (extended gas lift & a footring footrest) gives 9 in of vertical travel.

5. DO YOU WANT TO ADD UPHOLSTERY? IF YES, ADD THE PART # AND SELECT YOUR TEXTILE GRADE.

PART #	IMAGE	DETAILS	COM COL	PRICE (DEPENDS ON FABRIC GRADE SELECTED)									
				A	B	1/COM	2	3/COL	4	5	6	7	8
10 -7US*		Optional upholstered seat.	0.75 yd 4 sq ft	+\$57	+\$84	+\$110	+\$136	+\$162	+\$188	+\$214	+\$240	+\$266	+\$293

BUILD YOUR MODEL

STEP #	CHOICE	PART #	LIST PRICE
1	STARTING LIST BASE MODEL.		
2	FRAME FINISH.		
3	SHELL COLOR.		
4	LIGHT TASK BASE OPTION.		
4a	LIGHT TASK CASTER/GLIDE OPTION.		
4b	LIGHT TASK SAFETY-BRAKE CASTER OPTION.		
4c	LIGHT TASK STOOL KIT OPTION.		
UPHOLSTERY:			
5	SINGLE TEXTILE STANDARD: ADD GRADE, THEN ADD: - (MILL PATTERN COLORWAY)		
PACKAGING OPTIONS:			
6	STANDARD SHIPPING: MOST CHAIRS SHIP FULLY ASSEMBLED, EXCEPT MODEL 741 CHAIRS SHIP 95% ASSEMBLED. NO TOOLS REQUIRED. SINGLE CHAIRS: FOR A SINGLE CHAIR ORDER, ADD PART # -SC AND LIST PRICE \$63.		

OR SPEC IT THE EASY WAY.

via Design your perfect chair on our online builder: Spec It!
SPEC IT! <http://www.viaseating.com/specit>



specified model #: 761-N-03Z

DIMENSIONS & FINISHES

Dimensions and finishes can be found online. Studio V, Via Seating's engineering design team, continuously updates and works with its partners to update Via Seating products to the latest industry advances and to customer feedback. Dimensions, finishes & resources are made available online to allow for real-time updates with the most current data.

Find Zee information at viaseating.com/series/zee-collection or scan the QR code to the right →



QR CODE

TB133 application

TB-133 APPLICATION AT Via Seating

The chairs presented within this price book, unless otherwise specified, do not meet TB-133. Most Via Seating chair models can be prepared to meet the flame-retardant requirements of TB-133 and the Boston Fire Code. Via Seating does not add flame retardant chemicals to comply with TB-133, the fire resistance is accomplished by upholstering the chair with a naturally flame-retardant fabric barrier (i.e. Kevlar® or equivalent). Additionally, most plastic components (i.e. seat pan, back shell, shrouds, etc.) must be either removed or completely upholstered with a flame-retardant material.

Please note, any chair models specified to comply with TB-133 may not resemble what has been photographed and shown in marketing materials. Via Seating is not responsible for determining the requirement of TB-133 compliance. Check with your local building departments to determine if TB-133 is required on your order.

COM & TB-133

Additional COM/COL is required for TB-133. Please send in COM/COL requirements for seat/back cushions and the back shell.

SERIES	PART#	PRICE	DETAILS	PART#	PRICE	
4u	21TB133T	+\$114	Fire rated protection process.			
Astro	21TB133E	+\$196	Fire rated protection process.			
Brisbane	21TB133T	+\$114	Fire rated protection process. Must spec 22UBF or 22UBL .			
Brisbane HD	21TB133T	+\$114	Fire rated protection process. Must spec 22UBF or 22UBL . Can spec TB133 FRBSU on mid back models.	TB133 FRBSU	+\$155	Fire retardant plastic back shell on mid back models only.
Carmel	21TB133E	+\$196	Fire rated protection process.			
Comet	21TB133T	+\$114	Fire rated protection process.			
Dyce	21TB133E	+\$196	Fire rated protection process.			
Edge	21TB133T	+\$114	Fire rated protection process.			
Genie®	21TB133T	+\$114	Fire rated protection process.			
Linate	21TB133E	+\$196	Fire rated protection process.			
Orbit	21TB133T	+\$114	Fire rated protection process.			
Oslo	21TB133E	+\$196	Fire rated protection process.			
Proform®	21TB133E	+\$196	Fire rated protection process.			
Reset	21TB133T	+\$114	Fire rated protection process.			
Riva	21TB133T	+\$114	Fire rated protection process.			
Run II	21TB133T	+\$114	Fire rated protection process.			
Sienna single chair	21TB133 S	+\$179	Fire rated protection process.			
Sienna double couch	21TB133 SS	+\$357	Fire rated protection process.			
Sienna triple couch	21TB133 SSS	+\$536	Fire rated protection process.			
Spec Stools	21TB133T	+\$114	Fire rated protection process.			
Splash	21TB133T	+\$114	Fire rated protection process. Must spec 8US or 8USB .			
Sutro	21TB133T	+\$114	Fire rated protection process. Must spec 6US or 6USB .			
Terra	21TB133T	+\$114	Fire rated protection process.			
Vista II	21TB133T	+\$114	Fire rated protection process. Must spec 20UPH .			
Vista II #307	TB133B	+\$218	Fire rated protection process for bariatric chairs.			
Voss	21TB133E	+\$196	Fire rated protection process.			
Zee	21TB133T	+\$196	Fire rated protection process. Must spec 7US .			

what has discontinued

WHILE SUPPLIES LAST, LISTING SUGGESTED ALTERNATIVES

SERIES & SPECIFIC CHAIRS

WHILE SUPPLIES LAST	RECOMMENDED ALTERNATE
3Dee® chairs.	Swopper® chairs.
Bergen series.	Carmel, Dyce, Linate, Oslo & Vero series. These recommended high back models are design-forward with custom features crafted to fit client needs.
Essex series.	
Heathrow series.	Oslo high back. The “Big & Tall” Oslo series has been upgraded to handle the same 400 lb weight capacities as Heathrow.
Oyo® chairs.	Muvman® and Swopper® chairs.
Regola series.	Lounge lines.
Riva High backs.	Brisbane & Brisbane HD High Backs.
Vero Low Back.	Vero Mid Back.
Vista Classic series.	Vista II series. The Vista II was designed as an upgraded version of the Vista Classic series.
Voss Full Scale High Backs	Voss High Backs
Voss Mid Scale Mid Backs	Voss Mid Backs

Please note there has been a change to the Voss mesh backs. These chairs belong in the Riva series. Please find them in the Riva series as “tailored seat” options. Their model numbers have not changed.

CONTROL MECHANISMS

NEW	REPLACED BY	DETAILS
-9C	-67C	Quick adjust advanced synchro control featuring single rotation adjustments. Offers an optional +2” seat depth adjustment (SS) with an optional ergonomic 5° forward tilt adjustment (-FT). On executive high backs, see -9CH & -10CH , which includes a heavy-duty spring tension.
-10C	-67CSS	
-29C	-67CSS	
-61C	-67C	
-62C	-67CSS	
-66C	-74C	Auto-adjust body balance control. Offers an optional +2” seat depth adjustment (-12SS).

COLORS

WHILE SUPPLIES LAST	RECOMMENDED ALTERNATE
Muvman® light blue microfiber.	Muvman® royal blue microfiber.

Please call Customer Service for availability & alternates for the while supplies last items above.

Eclipse

solutions: multi-use, stacking, side/guest, light task chair & stool



featured image: 640-C-03-0A

features

Breadth of Line: available as a stackable side/guest chair with a v-leg, an executive guest chair on a wood base, a light task chair & a light task stool.

Seats: available as poly or upholstered seats.

Arms: choice of armless or with a loop arm. The armrest matches the chair's poly color.

Frames: matte black, chrome, polished aluminum, brushed aluminum and beech wood depending on frame type selected.

Stackable Options: v-leg base chairs are stackable on or off the optional stacking cart. Chairs stack with optional arms, optional upholstered seats and optional arm tablets.

SPEC IT! ONLINE CHAIR BUILDER
No, pending.
QUICK SHIP MANUFACTURING TIME
20/48 hours.
HIGHEST WEIGHT CAPACITY
300 lb.
WARRANTY
6 years.
BIFMA LEVEL
No, pending.
HEALTHIER HOSPITALS INITIATIVE (HHI)
No, pending.
MINDFUL MATERIALS
No, pending.
GSA (CONTRACT #: GS-28F-005CA)
No, available on open market.

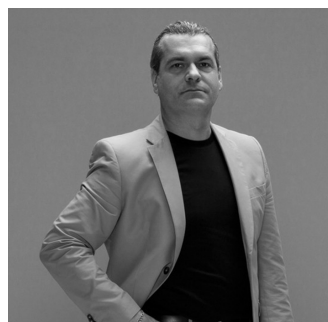

design by Angelo Pinaffo

Angelo Pinaffo was born in Padua in 1966. He studied at the State Institute of Art "Pietro Selvatico" in Padua & the University of Architecture in Venice (IUAV) in "Architectural Design" course of study. Pinaffo's constant search for simplicity and great attention to detail, aims to reach an aesthetical and technical originality among form and function. This award-winning designer cultivates product from idea to the development, industrialization and its complete realization.

Eclipse

STARTING LIST PRICE: \$298

GSA: OPEN MARKET | MANUFACTURED IN U.S.A.

PRODUCTION READY: OCTOBER

QUICK SHIP SCHEDULES

Code is listed in the starting model. Deviations from this are listed where they occur.

CODE	# MADE	DETAILS
20	20/48	20 Chairs manufactured in 48 hours.
10	10/48	10 Chairs manufactured in 48 hours.
📞	CALL	FOR LEAD TIME: 1-800-433-6614.

1. CHOOSE YOUR STARTING LIST BASE MODEL.

PART #	STARTING PRICE	IMAGE	DETAILS	MODEL #	STACKS	SHIPS	MAX WEIGHT	PART #	-B	-C
20 640	\$298		Stackable chair on a v-leg base.	640-B-01-0A	15 high on the floor.	2 per box.	300 lb.	PRICE	+\$0	+\$50
								IMAGE		
								DETAILS	Black frame with matching black glides.	Chrome frame with black glides.
20 643	\$583		Guest/side chair on a modern wood base.	643-N-01-0A	n/a	1 per box.	300 lb.	PART #	-N	
								PRICE	+\$0	
								IMAGE		
								DETAILS	Beech wood frame with black glides.	
20 646	\$473		Light task chair.	646-01-0A-18BB-16HP	n/a	1 per box.	275 lb.	n/a		
20 640C	\$150		Stacking transport cart for chairs. Stacks model 640 only.	640C	15 high on the cart.	1 per box.	180 lb.	n/a		

2. CHOOSE YOUR FRAME FINISH.

3. CHOOSE YOUR SHELL COLOR.

PART#	-01	-02	-03	-10	-11	-12
PRICE	+\$0	+\$0	+\$0	+\$0	+\$0	+\$0
IMAGE						
DETAILS	Standard black.	Window grey.	Signal white.	Cherry red.	Dark mint.	Linen.

4. CHOOSE YOUR ARM TYPE.

DO YOU WANT AN ARMLESS CHAIR?

PART#	PRICE	IMAGE	DETAILS
-0A	+\$0		Armless chairs are standard.





DO YOU WANT TO ADD A FIXED ARM?

4a. CHOOSE ARM CAP COLOR.

FOR MODELS	PART#	PRICE	DETAILS	USE WITH COLOR	WITH -01	WITH -02	WITH -03	WITH -10	WITH -11	WITH -12
	-SA4B	+\$80	Black fixed arm with a poly, shell color matching cap.	PART#	S01	S02	S03	S10	S11	S12
				PRICE	+\$0	+\$0	+\$0	+\$0	+\$0	+\$0
				IMAGE						
	-SA4C	+\$80	Chrome fixed arm with a poly, shell color matching cap.	DETAILS	Standard black.	Window grey.	Signal white.	Cherry red.	Dark mint.	Linen.





FIND MORE OPTIONS ON THE FOLLOWING PAGE. →

5. CHOOSE YOUR 5-STAR SWIVEL BASE.



USE WITH	PART#	PRICE	IMAGE	DETAILS
 646 only.	-18BB	+\$0		Black nylon base. Standard for light task stools.
	-18PB	+\$114		Polished aluminum base.
	-18BA	+\$114		Brushed aluminum base.

5a. CHOOSE YOUR CASTERS OR GLIDES.



5b. ADD SAFETY-BRAKE CASTERS?

USE WITH	PART#	PRICE	IMAGE	DETAILS	PART#	PRICE	DETAILS
 646 only.	-16HP	+\$0		Standard black finish casters are for use on soft/carpeted floors.	-SL1	+\$29	This feature locks the casters only when you are not sitting in the chair.
	-16SCG	+\$29		Grey finish casters are for use on both hard floors & soft/carpeted floors.	-SL2	+\$29	
	-16GL	+\$29		Black finish glides are for use on all floor types.	n/a	n/a	n/a



5c. DO YOU WANT TO MAKE YOUR CHAIR A LIGHT TASK STOOL?

USE WITH	FOR BASES	PART #	PRICE	IMAGE	STOOL KIT OPTION
 646 only.	18BB, 18PB, 18BA only.	-11DR	+\$156		Tall stool kit (extended gas lift & a footring footrest) gives 7 in of vertical travel.
		-11XDR	+\$156		Extra-tall stool kit (extended gas lift & a footring footrest) gives 9 in of vertical travel.



6. DO YOU WANT TO ADD A TABLET ARM?

PART#	-6TABB-R	 -6TABB-L	NOTE
PRICE	+\$115	+\$115	Tablet folds down and off to the side, completely freeing up the armrest. Chairs with tablet arms <u>do</u> stack. Tablet can be retrofitted onto existing arms.
IMAGE			
DETAILS	Right return tablet arm with a black surface and sides.	Left return tablet arm with a black surface and sides.	

7. DO YOU WANT TO ADD GANGING BRACKETS?

FOR MODELS	PART#	-64GNG	-64AGNG	NOTE
 640 only.	PRICE	+\$40	+\$40	If you would like more than one ganging bracket, please list total number of ganging brackets needed. For example, an order of 10 chairs may have 5 ganging brackets needed. Ganged chairs do not stack.
	IMAGE			
	DETAILS	Removable ganging brackets for frames.	Removable ganging brackets for arms.	

8. DO YOU WANT TO ADD UPHOLSTERY? IF YES, SELECT BY YOUR TEXTILE GRADE(S).

PART #	IMAGE	DETAILS	COM COL	PRICE (DEPENDS ON FABRIC GRADE SELECTED)									
				A	B	1/COM	2	3/COL	4	5	6	7	8
 -5US		Optional upholstered seat.	Call customer service at 1-800-433-6614.	+\$57	+\$84	+\$110	+\$136	+\$162	+\$188	+\$214	+\$240	+\$266	+\$293
NOTE	Must include mill, pattern and colorway listed after your grade choice in your model #. For COM/COL see pg. 18. We are happy to supply yardage requirement quotes for large quantity chair orders, as material economies may be realized. Please call 1-800-433-6614 or email your customer service manager for assistance.												

FIND A QUOTING GUIDE ON THE FOLLOWING PAGE. →

BUILD YOUR ECLIPSE MODEL.

STEP #	CHOICE	PART #	LIST PRICE
1	STARTING LIST BASE MODEL.		
2	FRAME FINISH.		
3	SHELL COLOR.		
4	ARM OPTION.		
4a	ARM CAP COLOR.		
5	LIGHT TASK BASE OPTION.		
5a	LIGHT TASK CASTER/GLIDE OPTION.		
5b	LIGHT TASK SAFETY-BRAKE CASTER OPTION.		
5c	LIGHT TASK STOOL KIT OPTION.		
6	TABLET ARM OPTION.		
7	GANGING BRACKET OPTION.		
UPHOLSTERY:			
8	SINGLE TEXTILE STANDARD: ADD GRADE, THEN ADD:		
	- (MILL PATTERN COLORWAY)		
PACKAGING OPTIONS:			
9	STANDARD SHIPPING: CHAIRS SHIP FULLY ASSEMBLED. EXCEPTIONS ARE: <ul style="list-style-type: none"> LIGHT TASK CHAIRS & STOOS SHIP 95% ASSEMBLED. NO TOOLS REQUIRED. STACKING CART SHIPS WITH SOME ASSEMBLY REQUIRED. 		
	<u>SINGLE CHAIRS</u> : FOR A SINGLE CHAIR ORDER, ADD PART # -SC AND LIST PRICE \$63 .		



specified model #: 640-C-03-0A

DIMENSIONS & FINISHES

Dimensions and finishes can be found online. Studio V, Via Seating's engineering design team, continuously updates and works with its partners to update Via Seating products to the latest industry advances and to customer feedback. Dimensions, finishes & resources are made available online to allow for real-time updates with the most current data.

Find Eclipse information at viaseating.com/series/eclipse-collection or scan the QR code to the right →



QR CODE

Eclipse Wired

solutions: outdoor seating, stackable chair & stool



NEW!



featured image: 649-1

features

Breadth of Line: stackable outdoor chair.

Design: strategic lines in the back & seat increase breathability in the sit & prevent stagnation of water.

Durability: for use outdoors.

Frame: dipped-look in jet black, micaceous anthracite, signal white & carmine red.

Upholstered Seat: option of an upholstered seat, able to be specified with outdoor textiles.

Lifting: easy-grab handle with durable, light-weight frames.

SPEC IT! ONLINE CHAIR BUILDER
Yes.
QUICK SHIP MANUFACTURING TIME
14 weeks from Italy.
HIGHEST WEIGHT CAPACITY
275 lb.
WARRANTY
5 years.
BIFMA LEVEL
No, pending.
HEALTHIER HOSPITALS INITIATIVE (HHI)
No, pending.
MINDFUL MATERIALS
No, pending.
GSA (CONTRACT #: GS-28F-005CA)
No, available on open market.

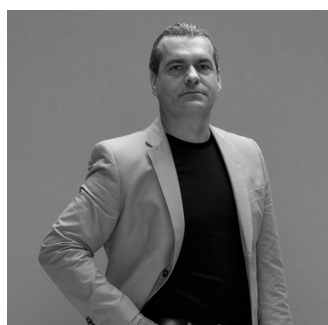

design by Angelo Pinaffo

Angelo Pinaffo was born in Padua in 1966. He studied at the State Institute of Art "Pietro Selvatico" in Padua & the University of Architecture in Venice (IUAV) in "Architectural Design" course of study. Pinaffo's constant search for simplicity and great attention to detail, aims to reach an aesthetical and technical originality among form and function. This award-winning designer cultivates product from idea to the development, industrialization and its complete realization.

Eclipse Wired



LOWEST PRICED MODEL: \$500

NOT ON CONTRACT WITH GSA (OPEN MARKET) | MANUFACTURED IN ITALY

PRODUCTION READY: OCTOBER

LEAD TIME





Code is listed in the starting model. Deviations from this are listed where they occur.

CODE	DETAILS
	14 weeks, shipped from Italy.
	FOR LEAD TIME: 1-800-433-6614

1. CHOOSE YOUR STARTING LIST BASE MODEL.

CHAIR TYPE	Stackable armless chair.
PART #	649
STARTING LIST PRICE	\$500
IMAGE	
STARTING MODEL #	820-1
STACKS	15 high on floor.
MINIMUM ORDER QUANTITY ¹	10 chair minimum.
SHIPS	Fully assembled in box.
MAX WEIGHT	275 lb.
NOTE 1	The minimum order quantity allows for the chairs to ship with freight included in the LIST pricing (ie. no additional cost for freight).

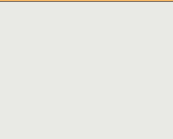
2. CHOOSE YOUR DIPPED-COLOR LOOK.

PART#	-1	-2	-3	-4
PRICE	+\$0	+\$0	+\$0	+\$0
IMAGE				
COLORS	Standard jet black.	Micaceous anthracite.	Signal white.	Carmine red.

For optional upholstered seat **-\$US**, textile options call 1-800-433-6614.

BUILD YOUR MODEL

STEP #	INSTRUCTIONS	PART #	LIST PRICE
1	STARTING LIST BASE MODEL.		
2	FINISH COLOR.		
PACKAGING:			
3	STANDARD SHIPPING: CHAIRS SHIP FULLY ASSEMBLED.		
FINAL MODEL NUMBER & TOTAL LIST:			



featured model #: 649-1

DIMENSIONS & FINISHES

Dimensions and finishes can be found online. Studio V, Via Seating's engineering design team, continuously updates and works with its partners to update Via Seating products to the latest industry advances and to customer feedback. Dimensions, finishes & resources are made available online to allow for real-time updates with the most current data.

Find SplashAir information at viaseating.com/series/eclipsewired-collection or scan the QR code to the right →



QR CODE

Genie Flex

solutions: task chair & stool, conference



featured image: 441-DG-67CSS-51AG18S-18GB-16SCG-GR 1 (SPRADLING SILVERTEX STERLING)

features

Breadth of Line: available as a mid back chair or task stool in a black or magnet grey frame.

Seats: offering six seat sizes—petite to extra-large—all in one look & at a 400 lb weight rating.

Intuitive Flex Back: strategically manufactured thermoplastic polyurethane (TPU) that is soft yet supportive. It provides active stretch and resistance creating multi-dimensional intuitive movement with superior support. This TPU is 100% recyclable, bleach-cleanable, chlorine-free and uses no plasticizers.

Arms: multiple height and width adjustable options and a fixed, conference arm.

Control Mechanisms: controls include latest quick adjust advanced synchro (no endless turning of the handle to adjust your backrest to your level of comfort) with choice of an optional 2.5" seat depth adjustment & an optional +3° forward tilt adjustment & body balance technology.

Bases: five-star swivel bases available in black or grey nylon & polished or brushed aluminum.

Via Seating's comfort foam: a proprietary blend of high-density, injection-molded, closed-cell, cold-cured foam so durable and lasting it is backed by Via Seating's 12 year warranty.

SPEC IT! ONLINE CHAIR BUILDER
No, pending.
QUICK SHIP MANUFACTURING TIME
20 chairs/48 hours.
HIGHEST WEIGHT CAPACITY
400 lb.
WARRANTY
12 years including HD 24/7.
BIFMA LEVEL
Yes, LEVEL 2.
HEALTHIER HOSPITALS INITIATIVE (HHI)
No, pending.
MINDFUL MATERIALS
No, pending.
GSA (CONTRACT #: GS-28F-005CA)
No, pending. Open market.



design by Studio V

Studio V creates modern, sophisticated and original seating solutions that are ergonomic, beautiful and sustainable. This team of engineers, sustainability experts and designers is based in Reno, Nevada. Studio V develops products using a prototyping lab, the latest in 3D modeling software and a materials testing center.



Genie Flex

STARTING LIST PRICE: \$695

GSA: OPEN MARKET | MANUFACTURED IN U.S.A.

PRODUCTION READY: OCTOBER

HEAVY DUTY (HD) 24/7 USE OPTIONS

Code is listed in the starting model to the right of the quick ship code.

CODE	DETAILS
20	For use in 24/7 & HD applications.

QUICK SHIP SCHEDULES

Code is listed in the starting model. Deviations from this are listed where they occur.

CODE	# MADE	DETAILS
20	20/48	20 Chairs manufactured in 48 hours.
10	10/48	10 Chairs manufactured in 48 hours.
	CALL	FOR LEAD TIME: 1-800-433-6614

1. CHOOSE YOUR STARTING LIST BASE MODEL.

SEAT SIZE	Standard A seat.	Medium B seat.	Heavy-duty large C seat.	Heavy-duty extra-large D seat.
PART #	440	441	442	443
STARTING LIST PRICE	\$695	\$761	\$866	\$978
IMAGE				
STARTING MODEL #	440-B-74C-0A-18BB-16HP-FB-GR A	441-B-74C-0A-18BB-16HP-FB-GR A	442-B-74C-0A-18BB-16HP-FB-GR A	443-B-74C-0A-18BB-16HP-FB-GR A
COM COL SEAT	1 yd 9 sq ft	1 yd 9 sq ft	1 yd 9 sq ft	1 yd 9 sq ft

2. DO YOU WANT TO ADD A PETITE SEAT (-1" DEPTH)?

SEAT SIZE	AA petite seat.	BB petite seat.	n/a	n/a
PART #	1PTG-	1PTG-		
PRICE	+\$69	+\$69		

3. CHOOSE YOUR FRAME COLOR.

PART#	PRICE	IMAGE	DETAILS
-B	+\$0		Standard black.
-DG	+\$57		Magnet grey.

4. CHOOSE YOUR CONTROL MECHANISM.

DO YOU WANT A CHAIR? SELECT YOUR CONTROL.

4a. ADD SEAT SLIDE?

4b. ADD FORWARD TILT?

USE ON	USE WITH	PART#	PRICE	DETAILS	GASLIFT	PART #	PRICE	DETAILS	PART #	PRICE	DETAILS	MAX WEIGHT
	All seats.	-74C	+\$0	Auto-adjust body balance control.	G3A: 4.8" travel.	-12SS	+\$91	Slide the seat +2.5" forward.	n/a	n/a	n/a	350 lb. A & B seats. 400 lb. C & D seats.
	All seats.	-67C	+\$4	Quick adjust advanced synchro control featuring single rotation adjustments.	G3A: 4.8" travel.	n/a	n/a	n/a	n/a	n/a	n/a	350 lb. A & B seats. 400 lb. C & D seats.
	All seats.	-67CSS	+\$95	Quick adjust advanced synchro control with seat depth adjustment.	G3A: 4.8" travel.		+\$0	Included. Slide the seat +2.5" forward.	-FT	+\$42	+3° of a forward tilt.	350 lb. A & B seats. 400 lb. C & D seats.

DO YOU WANT A STOOL? SELECT YOUR CONTROL AND HEIGHT RANGE.

USE ON	USE WITH	PART#	PRICE	DETAILS	GASLIFT	MAX WEIGHT
Stools.	A & B seats.	-35C-11DR	+\$220	Auto-adjust body balance control for stools.	G5: 7.0" travel.	300 lb.
		-35C-11XDR	+\$220	Adds a polished foot ring and extended gas lift with stool height ranges. Available on all bases.	G6: 9.5" travel.	300 lb.

FIND MORE OPTIONS ON THE FOLLOWING PAGE. →

5. CHOOSE YOUR ARM TYPE.

DO YOU WANT AN ARMLESS CHAIR?



















USE WITH	PART#	PRICE	IMAGE	DETAILS
All seats.	-0A	+\$0		Armless chairs are standard.

DO YOU WANT TO ADD AN ADJUSTABLE ARM?

5a. CHOOSE YOUR ARM CAP.



5b. ADD AN UPHOLSTERED CAP?

5c. ADD ADJUSTABLE WIDTH?

USE WITH	PART#	PRICE	IMAGE	DETAILS	PART #	PRICE	IMAGE	DETAILS	PART#	PRICE	PART#	PRICE	DETAILS
A, B, C seats.	-38A	+\$55		Black nylon basic height adjustable arm.	1	+\$0		Standard fixed cap.	n/a	n/a	-19AB	+\$33	Brackets can adjust the width between arms by 2" per side.
					6	+\$0		Preferred fixed cap.					
A, B, C seats.	-38AG	+\$55		Grey nylon basic height adjustable arm.	1	+\$0		Standard fixed cap.	n/a	n/a	-19AB	+\$33	Brackets can adjust the width between arms by 2" per side.
					6	+\$0		Preferred fixed cap.					
All seats.	-39A	+\$111		Black nylon height adjustable arm with roll back feature.	1	+\$0		Standard fixed cap.	n/a	n/a	n/a	n/a	n/a
					6	+\$0		Preferred fixed cap.					
All seats.	-51A	+\$89		Black polyurethane arm with optional 8-way adjustments.	18S	+\$0		Standard fixed cap.	U	+\$ your textile grade price found in step 8.	-19AB	+\$33	Brackets can adjust the width between arms by 2" per side.
					18R	+\$42		4D rotating cap.					
All seats.	-51AG	+\$116		Grey polyurethane arm with optional 8-way adjustments.	18S	+\$0		Standard fixed cap.	U	+\$ your textile grade price found in step 8.	-19AB	+\$33	Brackets can adjust the width between arms by 2" per side.
					18R	+\$42		4D rotating cap.					
All seats.	-53A	+\$150		Polished aluminum arm with optional 8-way adjustments.	18S	+\$0		Standard fixed cap.	U	+\$ your textile grade price found in step 8.	-19AB	+\$33	Brackets can adjust the width between arms by 2" per side.
					18R	+\$42		4D rotating cap.					

DO YOU WANT TO ADD A FIXED ARM?

5a. CHOOSE YOUR ARM CAP.

USE WITH	PART#	PRICE	IMAGE	DETAILS	PART#	PRICE	IMAGE	DETAILS
A, B, C seats.	-46A	+\$84		Black polyurethane fixed conference arm with fixed cap.		+\$0		Black polyurethane permanent fixed cap.

6. CHOOSE YOUR 5-STAR SWIVEL BASE.

6a. CHOOSE YOUR CASTERS OR GLIDES.



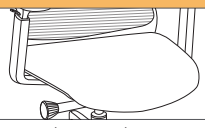
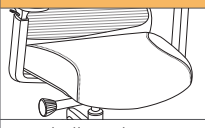
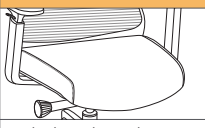

6b. ADD SAFETY-BRAKE CASTERS?

PART#	PRICE	IMAGE	DETAILS	USE WITH	PART#	PRICE	IMAGE	DETAILS	PART#	PRICE	DETAILS
-18BB	+\$0		Black nylon base. Standard with black frames.	All bases.	-16HP	+\$0		Standard black finish casters are for use on soft/carpeted floors.	-SL1	+\$29	This feature locks the casters only when you are not sitting in the chair.
-18GB	+\$0		Magnet grey nylon base. Standard with grey frames.	All bases.	-16SCG	+\$29		Grey finish casters are for use on both hard floors & soft/carpeted floors.	-SL2	+\$29	
-18PB	+\$114		Polished aluminum base.	All bases.	-16GL	+\$29		Black finish glides are for use on all floor types.	n/a	n/a	n/a
-18BA	+\$114		Brushed aluminum base.								

7. CHOOSE YOUR STITCHWORK STYLE FOR VINYL TEXTILES.

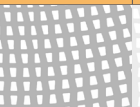
PART#	-NSP	-BBS	-SBS	STANDARDS NOTE
PRICE	+\$0	+\$0	+\$0	-NSP is standard with pattern SILVERTEX. Please call for approval on other vinyls. -BBS & -SBS are standard on all other vinyls.
IMAGE				
DETAILS	Seamless stitch pattern designed for infection prevention & easy clean up.	Baseball stitch pattern for AA, A, B & BB seats.	Side-band stitch pattern for C & D seats.	

8. CHOOSE YOUR FLEX BACK TPU COLOR.

PART#	-FB	-FG	-FW	-FO	-FR
PRICE	+\$0	+\$54	+\$54	+\$54	+\$54
IMAGE					
DETAILS	Black.	Grey.	White.	Green.	Red.

FIND MORE OPTIONS ON THE FOLLOWING PAGE. →

9. ADD YOUR TEXTILE GRADE(S).

PART #	PRICE (DEPENDS ON FABRIC GRADE SELECTED)										DETAILS
	A	B	1/COM	2	3/COL	4	5	6	7	8	
All chairs.	+\$0	+\$13	+\$49	+\$71	+\$106	+\$156	+\$205	+\$281	+\$368	+\$472	All chairs.
U	+\$31	+\$31	+\$31	+\$31	+\$31	+\$31	+\$63	+\$63	+\$63	+\$63	Upholstered caps on arms 51A , 52A & 53A .
NOTE	Must include mill, pattern and colorway listed after your grade choice in your model #. For COM/COL see pg. 18. We are happy to supply yardage requirement quotes for large quantity chair orders, as material economies may be realized. Please call 1-800-433-6614 or email your customer service manager for assistance.										

BUILD YOUR MODEL

STEP #	INSTRUCTIONS	PART #	LIST PRICE
1	STARTING LIST BASE MODEL (SEAT SIZE).		
2	PETITE SEAT OPTION.		
3	FRAME COLOR OPTION.		
4	CONTROL OPTION.		
4a	SEAT SLIDE OPTION.		
4b	FORWARD TILT OPTION.		
4c	STOOL KIT OPTION.		
5	ARM OPTION.		
5a	ARM CAP OPTION.		
5b	UPHOLSTERED CAP OPTION.		
5c	ADJUSTABLE WIDTH BRACKET OPTION.		
6	BASE OPTION.		
6a	CASTER/GLIDE OPTION.		
6b	SAFETY-BRAKE CASTER OPTION.		
7	SAMLESS SEAT OR SEAT STITCH PATTERN.		
8	TPU FLEX BACK COLOR.		
UPHOLSTERY OPTION:			
9	SINGLE TEXTILE STANDARD: ADD GRADE, THEN ADD: - (MILL PATTERN COLORWAY)		
PACKAGING:			
10	STANDARD SHIPPING: CHAIRS SHIP 95% ASSEMBLED. NO TOOLS REQUIRED.		
	CHAIRS SHIP FULLY ASSEMBLED OPTION (ADD PART # -FA AND LIST PRICE \$80/CHAIR).		
	BLANKET WRAPPED OPTION: MINIMUM ORDER OF 150, ADD PART # -BW AND CALL FOR LIST PRICING 1-800-433-6614.		



specified model #: 441-DG-67CSS-51AG18S-18GB-16SCG-GR 1 (SPRADLING SILVERTEX STERLING)

FAQ

1. What are the HD 24/7 use options for the GenieFlex series?

Please see HEAVY DUTY (HD) 24/7 USE OPTIONS as indicated by the symbol . For applicable fabrics, please check with the mill/manufacturer.

DIMENSIONS & FINISHES

Dimensions and finishes can be found online. Studio V, Via Seating’s engineering design team, continuously updates and works with its partners to update Via Seating products to the latest industry advances and to customer feedback. Dimensions, finishes & resources are made available online to allow for real-time updates with the most current data.



QR CODE

Find Eclipse information at via seating.com/series/genieflex-chairs or scan the QR code to the right →

Nebula

solutions: lounge, collaborative, lobby



NEW!



featured image: 935-55XS-GR 4 SEAT(MOMENTUM, FAUX FELT POOL), BACK (MOMENTUM, FAUX FELT STONE)

features

Breadth of Line: soft seating sofa. Nebula pairs beautifully with Astro, Chico, Comet, Edge, Luna, Meteor and Orbit soft seating.

Designer Shape: unique curved shape forms a spacious seat.

Upholstery: option to upholster the seat and back in two different textiles.

Bases: gorgeous black matte or silver wire frame base.

Via Seating's comfort foam: a proprietary blend of high-density, injection-molded, closed-cell, cold-cured foam so durable and lasting it is backed by Via Seating's 12 year warranty.

SPEC IT! ONLINE CHAIR BUILDER
Yes.
QUICK SHIP MANUFACTURING TIME
4 weeks lead time Aug-Nov.
HIGHEST WEIGHT CAPACITY
500 lb.
WARRANTY
6 years.
BIFMA LEVEL
Yes.
HEALTHIER HOSPITALS INITIATIVE (HHI)
No, pending.
MINDFUL MATERIALS
No, pending.
GSA (CONTRACT #: GS-28F-005CA)
No, pending. Open market.



design by Studio V

Studio V creates modern, sophisticated and original seating solutions that are ergonomic, beautiful and sustainable. This team of engineers, sustainability experts and designers is based in Reno, Nevada. Studio V develops products using a prototyping lab, the latest in 3D modeling software and a materials testing center.



Nebula

STARTING LIST PRICE: \$1,975

GSA: OPEN MARKET | MANUFACTURED IN U.S.A.

PRODUCTION READY: OCTOBER

QUICK SHIP SCHEDULES



Code is listed in the starting model. Deviations from this are listed where they occur.

CODE	# MADE	DETAILS
☎	CALL	4 WEEKS LEAD TIME AUGUST- NOVEMBER. CALL FOR DETAILS 1-800-433-6614.

1. CHOOSE YOUR STARTING LIST BASE MODEL.

PART #	☎ 935
STARTING LIST PRICE	\$1,975
IMAGE	 Note: Standard seat is fixed.
STARTING MODEL #	935-55XB-GR A
COM COL SEAT ONLY	1.25 yd 15.5 sq ft
COM COL BACK ONLY	4.5 yd 59.5 sq ft
COM COL WHOLE CHAIR	5.25 yd 75 sq ft

2. CHOOSE YOUR BASE.

PART#	PRICE	IMAGE	DETAILS	MATERIAL	MAX WEIGHT	PART#	PRICE	DETAILS
☎ -55XB	+\$0		Wire frame fixed-height x base with a matte black finish.	Steel.	500 lb.	-FELT	+\$20	Felt glides.
☎ -55XS	+\$52		Wire frame fixed-height x base with a powder-coated silver finish.	Steel.	500 lb.	-FELT	+\$20	Felt glides.

2a. DO YOU WANT TO ADD A FELT GLIDE?

3. DO YOU WANT TO ADD EMPHASIZED STITCH?

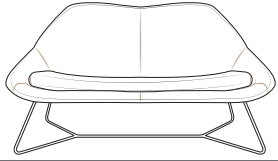
PART #	-CTS
PRICE	+\$0
IMAGE SHOWING CONTRASTING STITCH LINES BOLDED	
NOTE	Standard thread color is a tonal match to the textile(s) selected.

3a. CHOOSE YOUR EMPHASIZED STITCH THREAD COLOR.

PART#	-03	-05	-04	-06	-07	-09	-08	-10
PRICE	+\$0	+\$0	+\$0	+\$0	+\$0	+\$0	+\$0	+\$0
IMAGE								
DETAILS	Black thread.	Grey thread.	White thread.	Cream thread.	Chocolate thread.	Blue thread.	Red thread.	Yellow thread.

4. ADD YOUR TEXTILE GRADE(S).

PART #	PRICE (DEPENDS ON FABRIC GRADE SELECTED)										DETAILS
	A	B	1/COM	2	3/COL	4	5	6	7	8	
935	+\$0	+\$156	+\$324	+\$558	+\$810	+\$1084	+\$1454	+\$1862	+\$2534	+\$3304	Nebula sofa.
NOTE	Must include mill, pattern and colorway listed after your grade choice in your model #. For COM/COL see pg. 18. We are happy to supply yardage requirement quotes for large quantity chair orders, as material economies may be realized. Please call 1-800-433-6614 or email your customer service manager for assistance.										

4a. DO YOU WANT TWO-TONE UPHOLSTERY? IF YES, PLEASE LIST YOUR TEXTILES IN THIS ORDER:

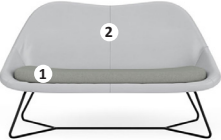
UPHOLSTERY LAYOUT	ORDER	DETAILS TO ADD TO YOUR MODEL #	IMPORTANT NOTES	PRICING NOTE
	1	SEAT (MILL PATTERN COLORWAY)	Includes seat.	Two-tone upholstery uses the highest grade of the two textiles.
	2	BACK (MILL PATTERN COLORWAY)	Includes front & back side of backrest or, in other words, all upholstered parts, but the seat.	

FIND A QUOTING GUIDE ON THE FOLLOWING PAGE. →

BUILD YOUR MODEL

STEP #	INSTRUCTIONS	PART #	LIST PRICE
1	STARTING LIST BASE MODEL.		
2	BASE OPTION.		
2a	FELT GLIDE OPTION.		
3	EMPHASIZED STITCH OPTION.		
3a	EMPHASIZED STITCH THREAD COLOR.		
UPHOLSTERY OPTION: CHOOSE 4 OR 4a, CHOOSING HIGHEST GRADE FOR LIST PRICE.			
4	SINGLE TEXTILE STANDARD: ADD GRADE, THEN ADD: - (MILL PATTERN COLORWAY)		
	TWO-TONE UPHOLSTERY OPTION: ADD GRADE, THEN ADD: - SEAT (MILL PATTERN COLORWAY) - BACK (MILL PATTERN COLORWAY)		
PACKAGING:			
5	STANDARD SHIPPING: CHAIRS SHIP FULLY ASSEMBLED.		
	PLEASE NOTE: FOR SHIPMENTS TO LOCATIONS WITHOUT A SHIPPING/RECEIVING DOCK, AN ADDITIONAL \$80 NET UPCHARGE PER REQUIRED TRUCK WITH A LIFT GATE WILL BE APPLIED TO THE ORDER.		
FINAL MODEL NUMBER & TOTAL LIST:			

OR SPEC IT THE EASY WAY

via Design your perfect chair on our online builder: Spec It!
SPEC IT! <http://www.viaseating.com/specit>



specified model #: 935-55XS-GR 4
SEAT(MOMENTUM, FAUX FELT POOL),
BACK (MOMENTUM, FAUX FELT STONE)

FAQ

1. Can I apply my own thread color in the Emphasized Stitch program?

Yes. Please note, lead time on chairs with custom thread colors can take up to 6 weeks from time of order confirmation depending on the complexity and availability of the thread color specified. Conditions may apply. Please contact 1-800-433-6614 for more information.

2. Can I apply my own color to any of the Nebula bases?

Yes. Minimums apply. Additional pricing, lead time and conditions apply. Please contact 1-800-433-6614 for more information.

DIMENSIONS & FINISHES

Dimensions and finishes can be found online. Studio V, Via Seating's engineering design team, continuously updates and works with its partners to update Via Seating products to the latest industry advances and to customer feedback. Dimensions, finishes and other resources are made available online to allow for real-time updates with the most current data.

Find Orbit information at viaseating.com/series/nebula-sofa

Muir

solutions: lounge, collaborative, lobby, executive guest



NEW!



featured image: 937-4MS-GR 1 (MOMENTUM HUE CHAR)

features

Breadth of Line: soft seating chair.

Designer Shape: pleasant curve with thick, comfortable cushioning.

Bases: gorgeous black matte or silver wire frame base.

Via Seating's comfort foam: a proprietary blend of high-density, injection-molded, closed-cell, cold-cured, durable and lasting foam.

SPEC IT! ONLINE CHAIR BUILDER
Yes.
QUICK SHIP MANUFACTURING TIME
4 weeks lead time Oct-Jan.
HIGHEST WEIGHT CAPACITY
300 lb.
WARRANTY
6 years.
BIFMA LEVEL
No, pending.
HEALTHIER HOSPITALS INITIATIVE (HHI)
No, pending.
MINDFUL MATERIALS
No, pending.
GSA (CONTRACT #: GS-28F-005CA)
No, pending. Open market.



design by Studio V

Studio V creates modern, sophisticated and original seating solutions that are ergonomic, beautiful and sustainable. This team of engineers, sustainability experts and designers is based in Reno, Nevada. Studio V develops products using a prototyping lab, the latest in 3D modeling software and a materials testing center.

Muir

STARTING LIST PRICE: \$890

GSA: OPEN MARKET | MANUFACTURED IN U.S.A.

PRODUCTION READY: OCTOBER

QUICK SHIP SCHEDULES



Code is listed in the starting model. Deviations from this are listed where they occur.

CODE	# MADE	DETAILS
☎	CALL	4 WEEKS LEAD TIME AUGUST- NOVEMBER. CALL FOR DETAILS 1-800-433-6614.

1. CHOOSE YOUR STARTING LIST BASE MODEL.

PART #	☎ 937
STARTING LIST PRICE	\$890
IMAGE	
STARTING MODEL #	937-4MB-GR A
COM COL WHOLE CHAIR	1.5 yd 25 sq ft

2. CHOOSE YOUR BASE.

PART#	PRICE	IMAGE	DETAILS	MATERIAL	MAX WEIGHT
☎ -4MB	+\$0		Wire frame fixed-height base with a matte black finish.	Steel.	300 lb.
☎ -4MS	+\$52		Wire frame fixed-height base with a silver finish.	Steel.	300 lb.

2a. DO YOU WANT TO ADD A FELT GLIDE?

PART#	PRICE	DETAILS
-FELT	+\$20	Felt glides.
-FELT	+\$20	Felt glides.

3. ADD YOUR TEXTILE GRADE(S).

PART #	PRICE (DEPENDS ON FABRIC GRADE SELECTED)										DETAILS
	A	B	1/COM	2	3/COL	4	5	6	7	8	
937	+\$0	+\$70	+\$140	+\$210	+\$280	+\$410	+\$540	+\$670	+\$800	+\$930	Muir chair.
NOTE	Must include mill, pattern and colorway listed after your grade choice in your model #. For COM/COL see pg. 18. We are happy to supply yardage requirement quotes for large quantity chair orders, as material economies may be realized. Please call 1-800-433-6614 or email your customer service manager for assistance.										

BUILD YOUR MODEL

STEP #	INSTRUCTIONS	PART #	LIST PRICE
1	STARTING LIST BASE MODEL.		
2	BASE OPTION.		
2a	FELT GLIDE OPTION.		
3	SINGLE TEXTILE STANDARD: ADD GRADE, THEN ADD: - (MILL PATTERN COLORWAY)		
PACKAGING:			
4	STANDARD SHIPPING: CHAIRS SHIP FULLY ASSEMBLED.		
FINAL MODEL NUMBER & TOTAL LIST:			



specified model #: 937-4MS-GR 1
(MOMENTUM, HUE CHAR)

DIMENSIONS & FINISHES

Dimensions and finishes can be found online. Studio V, Via Seating's engineering design team, continuously updates and works with its partners to update Via Seating products to the latest industry advances and to customer feedback. Dimensions, finishes and other resources are made available online to allow for real-time updates with the most current data.

Find Muir information at viaseating.com/series/muir-chair

Onda

solutions: executive, management, conference, ergonomic task chair & stool



featured image: 203-OG-67CSS-FT-ONA1-27GB-16OG-130

features

Breadth of Line: available as an high and mid mesh back.

Lumbar: integrated, adjustable lumbar support.

Mesh: flocked mesh with a soft hand available in 7 colors, featuring two Via original, biocidal, self-sanitizing copper colors (black and copper stripped mesh).

Arms: featuring optional 6D height adjustable arms with integrated, pivoting, arm caps in a black or light grey finish.

Control Mechanisms: controls include latest quick adjust advanced synchro (no endless turning of the handle to adjust your backrest to your level of comfort) with choice of an optional 2.5" seat depth adjustment & an optional +3° forward tilt adjustment & body balance technology.

Bases: featuring a custom, high-profile, five-star swivel base in a black or light grey finish matching the framework for a flawless, dipped-look.

Casters: Optional black or light grey open-design, all surface (including hard floor) reverse locking safety casters.

SPEC IT! ONLINE CHAIR BUILDER
Yes.
QUICK SHIP MANUFACTURING TIME
10 chairs/48 hours.
HIGHEST WEIGHT CAPACITY
300 lb.
WARRANTY
12 years, 5 years for mesh.
BIFMA LEVEL
No, pending.
HEALTHIER HOSPITALS INITIATIVE (HHI)
No, pending.
MINDFUL MATERIALS
No, pending.
GSA (CONTRACT #: GS-28F-005CA)
No, available on open market.



design by Studio V

Studio V creates modern, sophisticated and original seating solutions that are ergonomic, beautiful and sustainable. This team of engineers, sustainability experts and designers is based in Reno, Nevada. Studio V develops products using a prototyping lab, the latest in 3D modeling software and a materials testing center.

LOWEST PRICED MODEL: \$850

GSA: OPEN MARKET | MANUFACTURED IN U.S.A.



PRODUCTION READY: 4TH QUARTER

QUICK SHIP SCHEDULES



Code is listed in the starting model. Deviations from this are listed where they occur.

CODE	# MADE	DETAILS
10	10/48	10 Chairs manufactured in 48 hours.
📞	CALL	FOR LEAD TIME: 1-800-433-6614

1. CHOOSE YOUR STARTING LIST BASE MODEL.

BACK SIZE	Mid back.	High back.
PART #	10 201	10 203
STARTING LIST PRICE	\$850	\$900
IMAGE		
STARTING MODEL #	201-OB-74C-0A-18BB-16HP	203-OB-74C-0A-18BB-16HP

2. CHOOSE YOUR FRAME COLOR.

PART#	-OB	-OG
PRICE	+\$0	+\$75
IMAGE		
DETAILS	Standard dipped look black.	Dipped look light grey.

3. CHOOSE YOUR CONTROL MECHANISM.

DO YOU WANT A CHAIR? SELECT YOUR CONTROL.

3a. ADD SEAT SLIDE?

3b. ADD FORWARD TILT?

USE ON	USE WITH	PART#	PRICE	DETAILS	GASLIFT	PART #	PRICE	DETAILS	PART #	PRICE	DETAILS	MAX WEIGHT
Chairs.	All backs.	-74C	+\$0	Auto-adjust body balance control.	G3A: 4.8" travel.	-12SS	+\$91	Slide the seat +2" forward.	n/a	n/a	n/a	300 lb.
		-67CSS	+\$95	Quick adjust advanced synchro control with seat depth adjustment.	G3A: 4.8" travel.		+\$0	Included. Slide the seat +2.5" forward.	-FT	+\$42	+3° of a forward tilt.	300 lb.

DO YOU WANT A STOOL? SELECT YOUR CONTROL AND HEIGHT RANGE.



USE ON	USE WITH	PART#	PRICE	DETAILS	GASLIFT	MAX WEIGHT
Stools.	Mid back.	-35C-11DR	+\$220	Auto-adjust body balance control for stools.	 G5: 7.0" travel.	300 lb.
		-35C-11XDR	+\$220	Adds a polished foot ring and extended gas lift with stool height ranges. Available on all bases.	G6: 9.5" travel.	300 lb.

4. CHOOSE YOUR ARM TYPE.

DO YOU WANT AN ARMLESS CHAIR?





USE WITH	PART#	PRICE	IMAGE	DETAILS
All backs.	-0A	+\$0		Armless chairs are standard.

DO YOU WANT TO ADD AN ADJUSTABLE ARM?





USE WITH	PART#	PRICE	IMAGE	DETAILS
All backs.	-ONA1	+\$55		6D black height adjustable arm with integrated, pivoting, black arm caps.
All backs.	-ONA2	+\$55		6D grey height adjustable arm with integrated, pivoting, grey arm caps.

FIND MORE OPTIONS ON THE FOLLOWING PAGE. →

5. CHOOSE YOUR 5-STAR SWIVEL BASE.





PART#	PRICE	IMAGE	DETAILS
-18BB	+\$0		Black nylon base. Standard with black frames.
-18PB	+\$114		Polished aluminum base.
-18BA	+\$114		Brushed aluminum base.
-27BB	+\$50		High profile dipped black nylon signature Onda base.
-27GB	+\$50		High profile dipped grey nylon signature Onda base.

5a. CHOOSE YOUR CASTERS OR GLIDES.

USE WITH	PART#	PRICE	IMAGE	DETAILS	PART#	PRICE	DETAILS
18BB, 18PB & 18BA only.	-16HP	+\$0		Standard black finish casters are for use on soft/carpeted floors.	-SL1	+\$29	This feature locks the casters only when you are not sitting in the chair.
	-16SCG	+\$29		Grey finish casters are for use on both hard floors & soft/carpeted floors.	-SL2	+\$29	
	-16GL	+\$29		Black finish glides are for use on all floor types.	n/a	n/a	n/a
27BB only.	-16OB	+\$0		Black open-design, all surface (including hard floor) reverse locking safety casters.		+\$0	Included.
27GB only.	-16OG	+\$0		Grey open-design, all surface (including hard floor) reverse locking safety casters.		+\$0	Included.

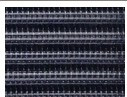
5b. ADD SAFETY-BRAKE CASTERS?

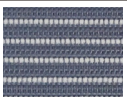
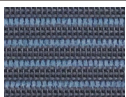
6. CHOOSE YOUR MESH COLOR.

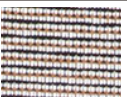
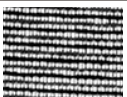
PART#	10	20	30	40	50	110	130
PRICE	+\$0	+\$0	+\$0	+\$0	+\$0	+\$139	+\$139
IMAGE							
DETAILS	Black.	Nickel.	Silver.	Sky Blue.	Red.	Copper Stripped.	Black Copper Stripped.

BUILD YOUR MODEL

STEP #	INSTRUCTIONS	PART #	LIST PRICE
1	STARTING LIST BASE MODEL.		
2	FRAME COLOR.		
3	CONTROL OPTION.		
3a	SEAT SLIDE OPTION.		
3b	FORWARD TILT OPTION.		
4	ARM OPTION.		
5	BASE OPTION.		
5a	CASTER/GLIDE OPTION.		
5b	SAFETY-BRAKE CASTER OPTION.		
6	MESH COLOR.		

PACKAGING:			
7	STANDARD SHIPPING: CHAIRS SHIP 95% ASSEMBLED. NO TOOLS REQUIRED.		
	CHAIRS SHIP FULLY ASSEMBLED OPTION (ADD PART # -FA AND LIST PRICE \$80/CHAIR).		
	BLANKET WRAPPED OPTION: MINIMUM ORDER OF 150, ADD PART # -BW AND CALL FOR LIST PRICING 1-800-433-6614.		

FINAL MODEL NUMBER & TOTAL LIST:		
----------------------------------	--	--



specified model #:

203-OG-67CSS-FT-ONA1-27GB-16OG-130

FAQ

1. Can I specify the 67C control without a seat slide (i.e. the SS option).?

No, the 67C does not mount up to the Onda chairs. For a control option without a seat slide, please see the -74C control.

DIMENSIONS & FINISHES

Dimensions and finishes can be found online. Studio V, Via Seating's engineering design team, continuously updates and works with its partners to update Via Seating products to the latest industry advances and to customer feedback. Dimensions, finishes & resources are made available online to allow for real-time updates with the most current data.



QR CODE

Find Onda information at viaseating.com/series/onda-chairs or scan the QR code to the right →

page look up by model

MODEL #	PAGE #	MODEL #	PAGE #	MODEL #	PAGE #	MODEL #	PAGE #	MODEL #	PAGE #
114	pg. 159	741	pg. 175	972	pg. 119	2R12	pg. 113	TBN15	pg. 153
115	pg. 159	751	pg. 175	974	pg. 57	2R14	pg. 113	TBN20	pg. 153
116	pg. 159	761	pg. 175	976	pg. 57	2R22	pg. 113	TCH15	pg. 153
124	pg. 159	770	pg. 35	981	pg. 119	2R24	pg. 113	TCN15	pg. 153
125	pg. 159	771	pg. 35	982	pg. 119	2R32	pg. 113	TFC15	pg. 153
126	pg. 159	772	pg. 35	985	pg. 73	2R34	pg. 113	TFN15	pg. 153
134	pg. 159	780	pg. 35	1303	pg. 49	2V25	pg. 171	TGC15	pg. 153
135	pg. 159	781	pg. 35	1305	pg. 49	2V27	pg. 171	TGN15	pg. 153
136	pg. 159	782	pg. 35	1401	pg. 133	2V35	pg. 171	TLC15	pg. 153
151	pg. 103	783	pg. 35	1416	pg. 133	2V37	pg. 171	TLN15	pg. 153
152	pg. 103	784	pg. 35	1503	pg. 49	4R12	pg. 113	TPC15	pg. 153
161	pg. 103	785	pg. 35	1505	pg. 49	4R14	pg. 113	TPN15	pg. 153
162	pg. 103	786	pg. 35	1603	pg. 49	4R22	pg. 113	TTC25	pg. 153
171	pg. 103	787	pg. 35	1605	pg. 49	4R24	pg. 113	TTN25	pg. 153
172	pg. 103	788	pg. 35	1703	pg. 49	4R32	pg. 113	XBBC1	pg. 127
181	pg. 103	801	pg. 137	1705	pg. 49	4R34	pg. 113	XBBO1	pg. 127
182	pg. 103	802	pg. 137	1801	pg. 45	600C	pg. 322	XBBQ	pg. 127
302	pg. 167	805	pg. 137	1803	pg. 45	600C	pg. 322	XBC15	pg. 127
303	pg. 167	806	pg. 137	1805	pg. 45	880C	pg. 137	XBS20	pg. 127
307	pg. 167	807	pg. 137	2801	pg. 45	880D	pg. 137	XBX15	pg. 127
312	pg. 167	808	pg. 137	2803	pg. 45	95-RSL	pg. 123	XCLUB	pg. 127
313	pg. 167	809	pg. 137	2805	pg. 45	95-RSSL	pg. 123	XCOUCH	pg. 127
350	pg. 109	820	pg. 143	3001	pg. 45	95-RSSSL	pg. 123	XCUBE	pg. 127
352	pg. 109	822	pg. 143	3003	pg. 45	95-USSSU	pg. 123	XDBP2	pg. 127
401	pg. 77	871	pg. 163	3005	pg. 45	95-USSU	pg. 123	XFC15	pg. 127
405	pg. 77	873	pg. 163	3403	pg. 113	95-USU	pg. 123	XFS20	pg. 127
408	pg. 77	875	pg. 163	3603	pg. 113	MUVMAN	pg. 89	XLC16	pg. 127
410	pg. 77	925	pg. 65	3803	pg. 113	MUVMAN_MEDICAL	pg. 89	XSA	pg. 127
440	available online	926	pg. 99	5301	pg. 69	MUVMAN_TALL	pg. 89	XSBP1	pg. 127
441		927	pg. 85	5303	pg. 69	SWUS_AIR	pg. 151	XSM	pg. 127
442		928	pg. 91	5501	pg. 81	SWUS_CLASSIC	pg. 151	XTBP3	pg. 127
443		930	pg. 41	5503	pg. 81	SWUS_CUSTOM	pg. 151	XTV20	pg. 127
602	pg. 147	931	pg. 119	6901	pg. 53	SWUS_SADDLE-S	pg. 151		
612	pg. 147	945	pg. 61	6903	pg. 53	SWUS-HIGH	pg. 151		
721	pg. 175	955	pg. 99	7101	pg. 95	TBC15	pg. 153		
731	pg. 175	971	pg. 119	7103	pg. 95	TBC20	pg. 153		



great things happen in a chair



VIA SEATING

205 VISTA BOULEVARD

SPARKS, NEVADA 89434

775.331.6001 | 800.433.6614

VIASEATING.COM