

## **NOTICE TO AUTHORIZED USERS OF AWARD #23295 - Furniture, All Types (Except Hospital Room and Patient Handling)**

This pricelist/catalog **may** contain items that are not within the Scope of the Contract Award and/or not within this Contractor's approved furniture Categories. All Authorized Users are strongly encouraged to review the Scope of the Award and the Contractor's Category Matrix prior to selecting items for purchase under the Contract. Per Solicitation Section 4.5 (D) - Procurement Instructions for Authorized Users: When placing orders under this Award, the Authorized User should follow and be familiar with the terms and conditions governing the Contract and are responsible for determining that the product(s) they intend to purchase fit within the scope of the Award.

References to other government contracts that may be included in a Contractor's pricelist/catalog, including any additional terms or conditions, are void under the OGS Award and should be disregarded. Only OGS' Terms and Conditions, including those within a Contractor's posted Contractor Information and Supplemental Information sheet, are valid under the Contract.

Additionally, Authorized Users are reminded that where discrepancies exist between Price List documents, the lowest price shall prevail (see Section 5.3 Price).

All orders must be placed with the Contractor, or the Contractor's OGS approved Authorized Reseller listed on the OGS website under the Award. Orders placed with a reseller not approved by OGS are not considered contract orders and therefore are not subject to the same terms and conditions of the OGS Award.

Authorized Users should contact the OGS Contract Manager listed on the Award with any questions pertaining to this pricelist/catalog.

## **NYS Price List Effective 3/3/26**

# PRICE GUIDE MARCH 2026



# MATERIALS & FINISHES

## Selecting Product Finishes

When specifying a product, please make note of all finish choices underneath the model number (or applicable options with finishes, such as arm caps). See product pages for material availability on each product series.

### Urethane Finishes

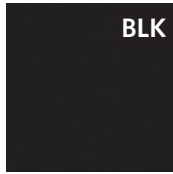

Black



Carbon



Taupe



Titanium

### Solid Surface Finishes\*

#### Group 1



Antarctica  
*from Corian®*



Bisque  
*from Corian®*

#### Group 2

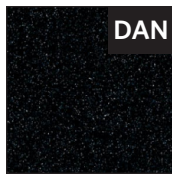

Deep Anthracite  
*from Corian®*



Deep Cloud  
*from Corian®*

**\*Note**

Additional metal & solid surface finishes are available. Please contact customer service for a quote.

### Metal Finishes\*



Silver Frost



Pewter

### TSR1/TSL1 Adjustable Side Trays

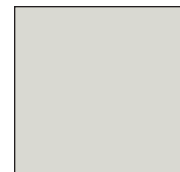

Made of phenolic material.

### Thermofoil Finishes

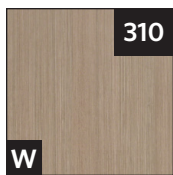

Aria

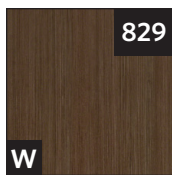

Baroque

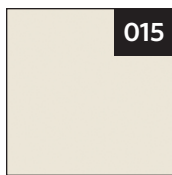

Bisque

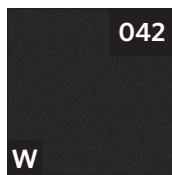

Black

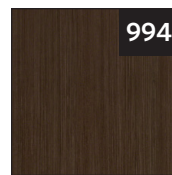

Coffee



Crystal White

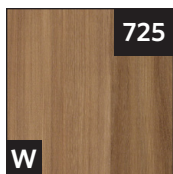

Elm

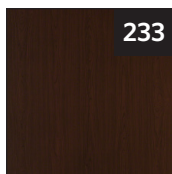

Espresso

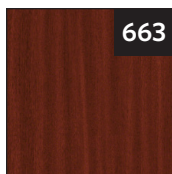

Mahogany

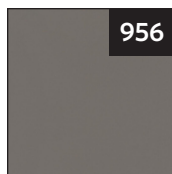

Matte Stone

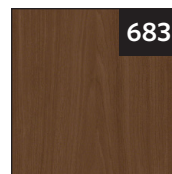

Walnut



Northern Grey

#### Wood Leg Finishes

**W** Finishes marked with this symbol are also available as a wood finish (applicable on wood legs and feet).

#### Folding Tray Table Finish

Northern Grey 548 is standard. Add \$149 list for other thermofoil finishes above.

\*Digital images shown may vary from actual color, and from screen to screen. For precise matching, please request a physical finish sample.

# CONTENTS

## REFERENCE

Finishes	2
Contents	3
Ordering & Shipping	4
Service	5
Warranty	6
GSA	7
GPO Contracts	8
CAL	9
UL	9
Certifications	10
Moisture Barriers	11
COM	11



## PRODUCTS

<b>Public Area Seating</b>	<b>16</b>	<b>Recliners</b>	<b>96</b>
Visitor		350 Series	98
Kadia Mod Metal Visitor	17	450 Series	114
Kenzley Visitor	26	Durable® Series Recliners	118
Koncert Metal Visitor	35	Durable® 550 Series	119
Koncert   Kadia Occasional Tables	42	Options Guide	130
Koncert   Kadia Mod Hip Chair	43	Durable® 650 Series	134
Metal Lounge		Durable® 750 Series	154
Kadia Mod Metal Lounge	46	Durable® Power Series	164
Koncert Metal Lounge	52	Durable® Exam Lift Series	175
Upholstered Lounge		<b>Sleep Series</b>	<b>182</b>
Kadia Mod Upholstered Lounge	57	Sleep Chairs	183
Kenzley Upholstered Lounge	63	Sofa & Bench	
Koncert Upholstered Lounge	66	Oxley Sleep Sofa	187
Assymble Modular Lounge	72	Oxley Sleep Bench	189
Cascade Lounge	82	Max Sleep Sofa	190
Behavioral Health	89	Kenzley Sleep Sofa	194
		EZ Rest	198

## ORDER INFORMATION

### Purchasing

All prices shown in this price book are list prices in US Dollars. Prices are subject to change without notice. The customer's purchase order must include complete information or order will be held from production until all information is provided. The customer bears sole responsibility for order correctness. Orders are subject to Knú, LLC's terms and conditions, regardless of the terms and conditions set forth on the buyer's/customer's purchase order forms. All customer orders must receive credit approval before the order can be entered into production.

Mail, Fax, or E-mail Purchase Orders To  
Knú, LLC DBA La-Z-Boy Healthcare | Knú Comfort  
P.O. Box 9, Ferdinand, IN 47532  
Phone: 812.367.2068 | Fax: 812.367.2493  
E-mail: orders@getknu.com

### Payment Terms

Terms are NET 30 days from shipment. If an invoice is not paid in full, within the terms, a monthly finance charge will be assessed at a rate of 1.5% per month or the highest amount permitted by applicable state law. The customer will be liable for any collection and/or attorney fees incurred in the collection of past due accounts.

### Selling Information

Distribution of this price list does not in itself constitute an offer to sell. Orders may only be placed by customers authorized by Knú, LLC management.

### Order Acknowledgment

The customer will receive an order acknowledgement by e-mail or fax. Upon receipt of this acknowledgement it is the customer's responsibility to check the accuracy of the order and notify customer service of any errors. Once an order is acknowledged, Knú, LLC will be responsible for shipping exactly the items acknowledged at the prices acknowledged. No changes may be made once an order has been placed into production. The order will be shipped upon completion of production. Every effort will be made to ship orders within the acknowledged ship dates. Acknowledged ship dates, however, are contingent upon conditions beyond our control. We cannot make promises for delivery dates as service by transportation companies varies from destination to destination.

### Order Cancellations

Cancellations must be communicated via email or fax to customer service and not to the sales representative. A cancellation penalty will apply. After an order is acknowledged and placed into production, cancellations cannot be accepted.

## SHIPPING

### Packaging

All prices include packaging. Assembled chairs are normally shipped one per carton unless otherwise specified. All of our packaging and cartons meet or exceed ICC specifications.

### Freight Terms & Conditions

See program details where freight is 2% of the list price total of the order, to the continental U.S. destination designated on the Purchase Order (customer's or dealer's dock or warehouse) and does not include home delivery. Customers must select a delivery location for their orders, and designate that default location on the purchase order. When a Knú, LLC customer/dealer warehouse is selected as the default delivery location, Knú, LLC pays freight cost to the default delivery location only, and no further. The customer is responsible for all charges from this point, and title and risk of loss to the product transfers to the customer upon delivery to the default location.

Knú, LLC utilizes freight carriers that are dedicated furniture specialists. For all deliveries, it is understood that Knú, LLC or its agents are making a dock delivery only, and any further work of truck unloading, delivery beyond the dock, installation, and/or removal of packaging is not authorized or paid for by Knú, LLC. Docks at the selected delivery location must be equipped to handle a 53' trailer. Home delivery is not included and must be negotiated prior to order placement. For all deliveries, whether to the customer location or drop shipment, any circumstances that result in the delay of our carrier (including unsuitable receiving facilities, or facilities not open or available), will result in service charges applied at the rate of \$75 per hour. Where re-delivery is necessary because of these circumstances, the full cost of re-delivery will be charged.

International shipments, shipments into Puerto Rico, and shipments into the states of Hawaii and Alaska are freight prepaid to the port of exit. Please call Customer Service for a quote on special packing for overseas container shipments. Knú, LLC reserves the right to select the most appropriate F.O.B. point, carrier, and routing on all shipments, domestic and international.

All Knú, LLC products are carefully inspected and properly packaged by trained personnel before leaving the factory. The transportation company assumes full responsibility for safe delivery upon acceptance of the shipment. All shipments are delivered to the freight company in good condition. If a shipment is received that has visible damage, product shortages

or if delivery has been delayed by the freight company the following steps must be taken:

1. Before signing for the merchandise, make notations of all visible damage and/or shortages on the Bill of Lading. The delivering freight company may not accept responsibility for damage and/or shortages if proper notification of the alleged problem is not given when signing for the merchandise. If visual damage is not apparent, sign the delivery receipt "no visual damage". This will allow recourse for a concealed damage claim. Claims for freight damage, concealed or otherwise, must be reported to Knú, LLC, and filed with the freight company within five (5) days of the original delivery date.
2. Do not refuse merchandise damaged in transit. The delivering freight company (not Knú, LLC) is responsible for damage to goods which occur in transit or storage. However, Knú, LLC will handle and process the claim with the freight carrier.
3. Failure to report damage claims to Knú, LLC within five (5) days may constitute acceptance of the merchandise and a waiver of any damage, errors, or shortages discovered upon subsequent inspection.
4. If a claim is filed you must retain all shipping cartons and packing material for inspection by the carrier agent.

## Freight Program

On standard production orders, freight is invoiced in the amount of 2% of the List total. Orders with a List total of \$4,000 or less are also subject to a \$250 Shipping and Handling Fee. Knú, LLC also reserves the right to implement a fuel surcharge or adjust the freight program as deemed necessary or appropriate.

## Storage Policy

Upon written notice, Knú | La-Z-Boy will provide storage, once an order is completed, for up to five (5) calendar days at no charge. Any order requiring storage beyond five (5) calendar days will be subject to a storage fee.

## SERVICE

### Return Merchandise

No returns of merchandise will be accepted without written authorization from Knú corporate office customer service. Before a return of merchandise is authorized, Knú factory sales representative reserves the right to inspect the furniture in question. Any item(s) that has been approved for return must be returned properly packed and in the original factory carton. All freight charges for returned product are the responsibility of the customer. Unauthorized returns will not be accepted and will be returned to customer freight collect. Upon receipt, all returned merchandise will be thoroughly inspected and the results compared to the reason given for the return stated on the authorization form. Any discrepancies, such as additional

damage, signs of usage, missing parts, etc., will result in an adjustment to the amount of the credit issued.

### Customer Satisfaction

Our goal at Knú, LLC is to ensure that our customers are completely satisfied with our products. If a problem arises with La-Z-Boy Healthcare | Knú Comfort after the warranty period, Knú, LLC will make its best effort to satisfy the customer in a manner that is fair to all concerned.

## IMPORTANT NOTES

1. COM orders must contain the fabric supplier name, pattern name, and color name of the pattern you wish to order.
2. Utilizing COM textiles may extend lead time by 1-2 weeks. Please note that lead time on COM orders begins when all material is received.
3. Directional covers, such as stripes, patterns, and plaids may not meet your satisfaction due to contoured shapes and tufting on some furniture styles. Should one of these designs be selected, we will do our best to manufacture the furniture to meet your satisfaction. However, such orders are not subject to return.
4. Textiles listed are supplied by the fabric suppliers and not all colors of the textile listed may be available.
5. Once an order for cut yardage is acknowledged, adjustments or cancellations will result in a restocking fee for the purchase price of the fabric.
6. Not all textiles are available in CAL 133.
7. Non-Warranty Service Orders: Please Call Customer Service for Pricing. (812.367.2068/phone)

## LIMITED LIFETIME WARRANTY

Knú, LLC dba La-Z-Boy Healthcare | Knú Comfort warrants the products it manufactures against defects in material and workmanship under normal use and service for the expected useful life of the product from the date of shipment. This limited warranty is valid only to the original purchaser using the product for its intended purpose, provided the product is covered in its original cover. This warranty does not apply to expected changes resulting from normal wear and tear, use and aging of the product. Specifically excluded from this limited warranty are defects and damage resulting from abuse, neglect, misuse, or excessive use. Product alteration, substitution of components or materials, improper cleaning or repair, and installation and handling damages are also not covered by this warranty. All other express or implied warranties made by agents, dealers, sales representatives or any other representatives, including any warranty of merchantability or fitness for a particular purpose, are hereby excluded.

There are no representations as to the capacity or performance of the products sold hereunder except as set forth in the price book or quotation specifications, if any, and such representations are expressly conditioned upon the correctness of the data furnished by purchaser and upon the products being properly installed and maintained.

Knú, LLC's sole obligation shall be to repair any defective product or product component covered under this warranty, including shipping and labor, during the warranty period. In no event shall Knú, LLC be liable for any consequential or incidental damages, including lost profits or revenues incurred by the purchaser with respect to any goods furnished by Knú, LLC. Expenses incurred by purchaser in repairing or replacing Knú, LLC's product must be pre-approved in writing by Knú, LLC.

Knú, LLC offers no warranty on the following product components or characteristics: all forms of upholstery, including fabric, vinyl and leather, as well as wood grain, color and texture. Knú, LLC offers no warranty on COM, COL, or any other special order fabric used at the request of the Purchaser.

Warranties offered by cover suppliers to Knú, LLC, if any, are hereby assigned to Purchaser.

In the event a product has to be returned to the factory for verification of a defect and/or repair, it must be pre-approved in writing by Knú, LLC, freight pre-paid, and include a copy of the original invoice with the date and name of original purchaser.

Knú, LLC hereby assigns to the original owner any and all warranties offered by its component suppliers. To the extent the terms of these warranties differ from the terms of the Limited Warranty, the terms of the suppliers' component warranties shall apply. However, Knú, LLC does not guarantee that the component supplier will comply with any terms of the warranty of such supplier.

KNÚ, LLC WILL NOT BE LIABLE FOR ANY CONSEQUENTIAL OR INCIDENTAL DAMAGES INCLUDING ANY LOSS, EXPENSE, OR DAMAGE OTHER THAN TO THE PRODUCT ITSELF THAT MAY RESULT FROM A DEFECT IN THE PRODUCT. SOME STATES DO NOT ALLOW FOR THE EXCLUSION OR LIMITATION OF CONSEQUENTIAL AND INCIDENTAL DAMAGES, SO THE ABOVE LIMITATION OR EXCLUSION MAY NOT APPLY.

KNÚ, LLC MAKES NO IMPLIED WARRANTIES OF MERCHANTABILITY OR FITNESS FOR A PARTICULAR PURPOSE. THESE AND ALL OTHER IMPLIED WARRANTIES ARE SPECIFICALLY DISCLAIMED. SOME STATES DO NOT ALLOW AN EXCLUSION OR LIMITATION ON HOW LONG AN IMPLIED WARRANTY LASTS, SO THE ABOVE LIMITATIONS OR EXCLUSIONS MAY NOT APPLY.

THIS WARRANTY GIVES YOU, THE ORIGINAL PURCHASER, SPECIFIC LEGAL RIGHTS AND YOU MAY ALSO HAVE OTHER RIGHTS THAT VARY FROM STATE TO STATE. EXCEPT FOR SUCH OTHER RIGHTS, THE REMEDIES PROVIDED UNDER THIS WARRANTY STATE THE LIMIT OF KNÚ, LLC'S RESPONSIBILITIES.



U.S. General Services Administration  
 GSA Contract #: GS-28F-0008V  
 Contract Period: 12/3/08 - 12/2/2028  
 Price List Effective Date: 03/03/2026  
 Knú, LLC. DBA: La-Z-Boy Healthcare & Knú Comfort  
 Website: www.getknu.com | www.lzbcontract.com

- 1. Special Item Number (SIN): 339113H Healthcare Furniture  
 OLM Order-Level Materials  
 33721 Office Furniture\*  
*\*Includes Installation Services: 15% of the net price of the purchase order up to \$150,000. All orders over \$150,000 will be determined on a case-by-case basis.*
- 2. Delivery Time: 5 weeks ARO (35 Days ARO)
- 3. Point of Production: 1300 North Broad Street, Leland, MS 38756
- 4. FOB Terms: FOB Origin, Freight Prepay, Plus a \$100 handling fee for all orders less than \$1,500.00 Net  
 International shipments, shipments into Puerto Rico, and shipments into the states of Hawaii and Alaska are freight prepaid to the port of exit. Please call Customer Service for a quote on special packing for overseas container shipments
- 5. Prompt Payment Terms: Net 30
- 6. Minimum Order: \$100 Net
- 7. Maximum Order: \$200,000 Net
- 8. Warranty: Standard Commercial Warranty
- 9A. Ordering Address: Knú, LLC | DBA / La-Z-Boy Healthcare & Knú Comfort  
 P.O. Box 9, Ferdinand, IN 47532
- 9B. Remit to Address: Knú, LLC | DBA / La-Z-Boy Healthcare & Knú Comfort  
 1597 Momentum Place, Chicago, IL 60689
- 10. Credit Cards Accepted: Visa, MasterCard, Discover, and American Express
- 11. Return Policy/Restocking Fee: No returns of merchandise will be accepted without written authorization from Knú, LLC.  
 If authorized, the customer will pay all freight charges and a 30% (Net Price) restocking fee will be assessed.
- 12. Cancellation Policy: No charge prior to production. After production has begun, only actual costs that the contractor can demonstrate will be charged.
- 13. Rental, Maintenance, Repair: N/A
- 14. Repair Parts: See Warranty
- 15. List of Participating Dealers: Contact Customer Service
- 16. Dealer Registration: The name of the dealer must appear on the GSA Purchase Order.
- 17. GSA Customer Service: E-Mail: gsales@getknu.com | Phone: 812-367-0136 | Fax: 812-367-2493
- 18. DUNS Number: 197589893  
 FED ID Number: 20-2599789  
 Cage Code Number: 4CDQ5
- 19. GSA Discount: 61.2% Off List



# HEALTHTRUST®

Contract #: HPG-22449  
Contract Period: 09/01/2017-11/30/2027  
FED ID #: 20-2599789  
HealthTrust Member Pricing: Price Guide effective 3/3/2026. Must use current fabric grades at time of order.  
Freight Fee: 2% of List  
Customer Service: 812-367-2068 or customerservice@getknu.com  
NOTES: La-Z-Boy® Healthcare | Knú Comfort® sells dealer and dealer invoices end-user directly.

---



Contract #: PP-FA-2017  
Contract Period: 01/01/2024 - 04/30/2029  
FED ID #: 20-2599789  
Premier Member Pricing: Price Guide effective 3/3/2026. Must use current fabric grades at time of order.  
Freight Fee: 2% of List  
Customer Service: 812-367-2068 or customerservice@getknu.com  
NOTES: La-Z-Boy® Healthcare | Knú Comfort® sells dealer and dealer invoices end-user directly.

---

*For information on state and other contracts, please visit [getknu.com/resources/company-resources/contracts/](https://getknu.com/resources/company-resources/contracts/)*

## CAL 117 | CAL 133

All Knú, LLC standard upholstered seating and the filling materials used in the construction of our seating, either meet or exceed the flammability requirements of CAL 117-2013.

Knú, LLC will manufacture its seating when requested by a customer to meet or exceed the flammability requirements of the repealed California Technical Bulletin 133. If you do not need actual certification, the product can be upholstered using Fire Resistant Foam and the Fire Resistant Barrier for an additional unit cost based on the fabric yardage requirements of the specified product. Please contact customer service for pricing and lead times.

When sending in COM to have CAL 133 compliant material added, Knú, LLC will need an additional yardage amount equal to either 5% of the total yardage, or 1 yard, whichever is the greatest.

## UL Listing

All electrical components used in Knú, LLC products are UL listed. A UL listing for an entire Knú, LLC product can be obtained at an additional charge. Please contact customer service for pricing and lead times.

**Note:** Knú, LLC makes no recommendations or representations regarding whether CAL 133 certification or UL listing is required for the lawful use of Knú, LLC products. It is the sole responsibility of the customer to ascertain and comply with the laws, ordinances, regulations and codes of their particular jurisdiction that apply to their use of Knú, LLC products.

## GREENGUARD Gold Certification [www.greenguard.org](http://www.greenguard.org)



GREENGUARD Gold Certification (formerly known as GREENGUARD Children & Schools Certification) offers stricter certification criteria, considers safety factors to account for sensitive individuals (such as children and the elderly), and ensures that a product is acceptable for use in environments such as schools and healthcare facilities. It is referenced by both The Collaborative for High Performance Schools (CHPS) and the Leadership in Energy and Environmental Design (LEED) Building Rating System.

## level® Certification [www.levelcertified.org](http://www.levelcertified.org)



BIFMA's e3 Furniture Sustainability Standard is a voluntary, multi-attribute standard that measures the degree of sustainability of furniture. This standard evaluates product and company environmental attributes and compliance systems in a wide range of elements, including Materials, Energy & Atmosphere, Human & Ecosystem Health, and Social Responsibility.

## Additional Sustainability Information

For additional information on our environmental commitment and a full sustainability report, please visit [getknu.com/resources/company-resources/sustainability/](http://getknu.com/resources/company-resources/sustainability/)

**Moisture Barrier Options**

Moisture barriers that are designed to prevent liquid penetration to the foam and other filling materials are available on most items at an additional charge. Moisture barriers are applied between the upholstery cover and filling materials. The following list price upcharge will apply to each surface on which the protective barriers may be applied.

<b>Part Number/Description .....</b>	<b>List Price</b>
MBB Chair/Recliner Back.....	59
MBS Chair/Recliner Seat.....	59
MB2B Bariatric Chair/Bariatric Recliner Back.....	89
MB2S Bariatric Chair/Bariatric Recliner Seat .....	89
MB3B Loveseat Back .....	119
MB3S Loveseat Seat.....	119
MB4B Sofa/Sleep Sofa Back .....	179
MB4S Sofa/Sleep Sofa Seat .....	179
MB5B Sleep Chair Back .....	59
MB5SE Sleep Chair Seat and Extensions .....	179*

\*List per seat

**Dillon / Carson Pricing Grade**

Upholstered product pricing grade "Dillon/Carson" is exclusive to products specified with the textiles Dillon by Culp Contract or Carson CV by Momentum Textiles & Wallcovering.

**Dillon - Culp Contract**

Content: 100% Polyurethane  
 Backing: 70% Polyester / 30% Cotton  
 For full specs, available colorways, & cleaning info, visit [www.culpcontract.com](http://www.culpcontract.com)

**Carson CV - Momentum Textiles & Wallcovering**

Content: 100% Clean Vinyl/Phthalate Free  
 Backing: Polyester  
 For full specs, available colorways, & cleaning info, visit [www.momentumtextilesandwalls.com](http://www.momentumtextilesandwalls.com)

**Repeating/Matching Textile Patterns**

Specified textiles that have a minimal matching pattern or are specified in a way that an exact match may not be necessary nor applicable, will be applied to maximize yield and prevent excessive wasting of material. If a Specific Matching Pattern is required, please contact Customer Service for a project specific quote.

**COM (Customer's Own Material)**

All Knú, LLC seating styles are available in COM. Prices are listed in the column containing the Grade of COM. Yardage requirements are based on non-directional 54" wide (between selvage edges) fabric. All fabrics must be backed with an appropriate type backing. Do not send wall coverings or drapery fabrics. COM material must be shipped from fabric supplier in continuous yardage. Knú, LLC cannot accept individual pieces of the same fabric.

Please complete the COM form and ship form along with the fabric sample for approval prepaid to:  
 Knú Design Center  
 ATTN: COM Department  
 824 W 23rd St  
 Ferdinand, IN 47532

Once COM fabric has been approved send COM yardage to:  
 Knú, LLC DBA La-Z-Boy Healthcare | Knú Comfort  
 ATTN: COM Department  
 Dock 14  
 4502 State Rd 66, Cannelton, IN 47520

Please send purchase order to:  
 Knú, LLC DBA La-Z-Boy Healthcare | Knú Comfort  
 P.O. Box 9, Ferdinand, IN 47532  
 Fax: 812-367-2493  
 E-mail: [orders@getknu.com](mailto:orders@getknu.com)

Knú, LLC must receive the purchase order prior to receiving the COM yardage. Lead time does not begin until COM yardage has been received by the COM Department at Cannelton, IN.

Please attach a sample of your material to the COM form and indicate the direction it is to be applied. Unless otherwise directed, all COM will be applied up the roll with no pattern. Since some fabrics are reversible, please attach the fabric such that the exposed side is facing outward. Knú, LLC does not warrant COM fabrics.

Refer to individual product pages for standard COM yardage requirements. For fabrics with railroads or repeats please refer to the Textile Pattern Repeats chart on the following page.

When sending in COM to have CAL133 backing added, Knú, LLC will need an additional yardage amount equal to either 5% of the total yardage, or 1 yard, whichever is the greatest.

When COM is accepted, Knú, LLC assumes no responsibility for the appearance, behavior, or durability of the COM. Knú, LLC will inspect all COM fabrics upon receipt at the plant, but will not be held responsible for variations of dye lots, wear, fading, pattern matches, and/or flaws.

**NOTE:** Utilizing COM textiles may extend lead time by 1-2 weeks. Please note that lead time on COM orders begins when all material is received.

**Textile Pattern Repeats**

Specified textiles that have a repeating pattern will be applied in a non-matching layout to increase yield. If a matching application is preferred, please contact customer service to request a quote. Use the below to figure additional COM yardage required.

The chart below represents a patterned fabric being selected with a repeat. When a multiple repeat is present, the calculation for the yardage needed is determined by adding the vertical and horizontal measurements together and then referring to the chart for the extra yardage required. For example, on a guest chair a 4" vertical repeat and a 5" horizontal repeat requires 18.5% additional COM yardage if the pattern is directed across the roll, or 23.5% if the pattern is directed up the roll.

**RR**  
**Across the Roll**  
**Railroaded**

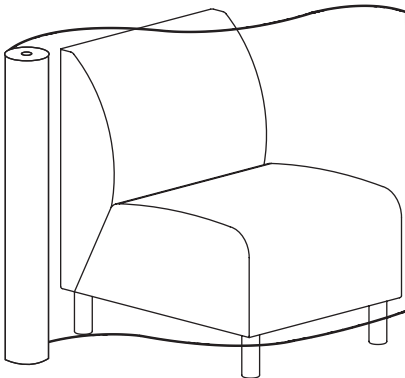

**UR**  
**Up the Roll**

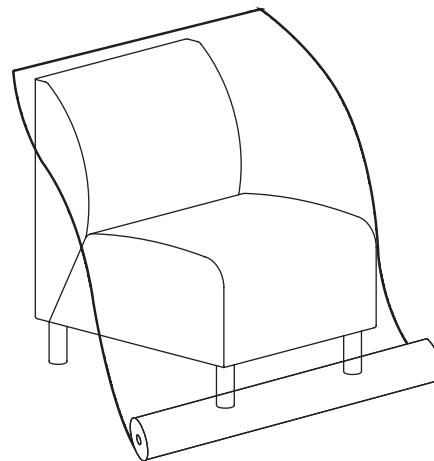

**Guest/Visitor & Tandem Seating**

Repeat (in inches)	Cut Across The Roll (RR)	Cut Up The Roll (UR)	2-Way <i>Call for quote</i>
¼" - 3"	Add 7.5%	Add 12.5%	
3 ¼" - 6"	Add 16.5%	Add 20%	
6 ¼" - 9"	Add 18.5%	Add 23.5%	
9 ¼" - 12"	Add 23%	Add 28%	
12 ¼" - 15"	Add 25%	Add 30%	
15 ¼" - 33"	Add 35%	Add 40%	

**Upholstered Lounge/Tandem Seating & Sleep Chairs/Sleep Sofas**

Repeat (in inches)	Cut Across The Roll (RR)	Cut Up The Roll (UR)	2-Way <i>Call for quote</i>
¼" - 3"	Add 8%	Add 13%	
3 ¼" - 6"	Add 17.5%	Add 22.5%	
6 ¼" - 9"	Add 18.5%	Add 23.5%	
9 ¼" - 15"	Add 20%	Add 25%	
15 ¼" - 21"	Add 30%	Add 35%	
21 ¼" - 33"	Add 35%	Add 40%	

**Recliners & Gliders**

Repeat (in inches)	Cut Across The Roll (RR)	Cut Up The Roll (UR)	2-Way <i>Call for quote</i>
¼" - 3"	Add 9%	Add 14%	
3 ¼" - 9"	Add 13.5%	Add 17%	
9 ¼" - 15"	Add 20%	Add 25%	
15 ¼" - 21"	Add 25%	Add 30%	
21 ¼" - 33"	Add 30%	Add 35%	

# COM Form

(Entire form must be filled out. Please include only one material per form.)



<b>Dealer Name:</b>		<b>Fabric Supplier:</b>		
<b>Address:</b>		<b>Pattern Name &amp; Number:</b>	<b>Total Yardage Being Provided:</b>	
<b>City/State/Zip:</b>				
<b>Contact Name:</b>		<b>Pattern Repeat (in inches)</b> <i>*Order will not be processed w/out this information.</i>		
<b>Telephone:</b>		None:	Vertical:	Horizontal:
<b>Dealer Account #:</b>		<b>Purchase Order #:</b>		

Quantity	Model Number	Textile Supplier/Textile Color Name/Number	Finish	Tag

**Attach fabric sample below, face side up in the direction it is to be applied to the chair.**

**\*Please Note: COM material must be shipped in continuous yardage from the fabric supplier. We cannot accept piece mill yardage or individual pieces of the same fabric.**

**\*Fabric must be tagged with the PO# and dealer name.**

**\*Fabric will be applied according to supplier recommendation unless otherwise instructed.**

**\*Add 1 yard or 5% (whichever is the greater of the 2) if CAL133 will be added to COM.**

**Ship This Form with Sample To:**  
 Knú, LLC  
 DBA/La-Z-Boy Contract Furniture  
 Attention: COM Department  
 P.O. BOX 9  
 824 W 23<sup>rd</sup> Street  
 Ferdinand, IN 47532

**Send Purchase Order To:**  
 Knú, LLC  
 DBA/La-Z-Boy Contract Furniture  
 P.O. Box 9  
 Ferdinand, IN 47532  
 Fax: 812.367.2493  
 customerservice@getknu.com

**Ship COM Yardage To:**  
 Knú, LLC  
 ATTN: COM Department  
 Dock 14  
 4502 State Rd 66  
 Cannelton, IN 47520

# INDEX BY MODEL NUMBER

AS10N.....	73	E3167.....	136	ECE17N0.....	106	KAM10U.....	18
AS10NC.....	73	E4017.....	139	ECF01N0.....	101	KAM12J.....	19
AS12AF.....	74	E4062.....	147	ECH02N0.....	105	KAM12U.....	19
AS12AJ.....	74	E4067.....	144	EZ6833.....	200	KAM20IBLJ.....	21
AS12AU.....	74	E4117.....	139	EZ7633.....	200	KAM20IBLU.....	21
AS12LF.....	74	E4125.....	125	GANG BRKT KOT.....	25	KAM20IBRJ.....	22
AS12LJ.....	74	E4127.....	128	GANG BRKT KOT.....	34	KAM20IBRU.....	22
AS12LU.....	74	E4162.....	147	GANG BRKT KOT.....	41	KAM20IJ.....	21
AS12RF.....	75	E4167.....	144	GOTO0.....	102	KAM20IU.....	21
AS12RJ.....	75	EB1037.....	155	H5017.....	141	KAM20J.....	20
AS12RU.....	75	EB1062.....	160	H5037.....	157	KAM20U.....	20
AS20N.....	73	EB1067.....	158	H5047.....	150	KAM30IBCJ.....	23
AS22AF.....	75	EB1137.....	155	H5057.....	162	KAM30IBCU.....	23
AS22AJ.....	75	EB1162.....	160	H5117.....	141	KAM30IBLJ.....	23
AS22AU.....	75	EB1167.....	158	H5137.....	157	KAM30IBLU.....	23
AS22LF.....	76	EB4037.....	156	H5147.....	150	KAM30IBRJ.....	24
AS22LJ.....	76	EB4062.....	161	H5157.....	162	KAM30IBRU.....	24
AS22LU.....	76	EB4067.....	159	HC5017.....	141	KAM30IJ.....	22
AS22RF.....	76	EB4137.....	156	HC5037.....	157	KAM30IU.....	22
AS22RJ.....	76	EB4162.....	161	HC5047.....	150	KAS10A.....	83
AS22RU.....	76	EB4167.....	159	HC5057.....	162	KAS10BA.....	84
AS30N.....	73	EBC1037.....	155	HC5117.....	141	KAS10BF.....	84
AS32AF.....	77	EBC1062.....	160	HC5137.....	157	KAS10F.....	83
AS32AJ.....	77	EBC1067.....	158	HC5147.....	150	KAS13A.....	83
AS32AU.....	77	EBC1137.....	155	HC5157.....	162	KAS13BA.....	84
AS32LF.....	77	EBC1162.....	160	K0017.....	99	KAS13BF.....	84
AS32LJ.....	77	EBC1167.....	158	K0107.....	115	KAS13F.....	83
AS32LU.....	77	EBC4037.....	156	K0167.....	116	KAS18A.....	85
AS32RF.....	78	EBC4062.....	161	K1017.....	138	KAS18F.....	85
AS32RJ.....	78	EBC4067.....	159	K1042.....	151	KAS20A.....	85
AS32RU.....	78	EBC4137.....	156	K1047.....	149	KAS20F.....	85
AS90IC.....	79	EBC4162.....	161	K1062.....	146	KAS23A.....	86
AS90OC.....	79	EBC4167.....	159	K1067.....	143	KAS23F.....	86
ASB2424.....	79	EC1017.....	138	K1117.....	138	KAS28A.....	86
ASB2448.....	79	EC1042.....	151	K1125.....	124	KAS28F.....	86
ASB2472.....	80	EC1047.....	149	K1127.....	127	KAS30A.....	87
ASB3024.....	80	EC1062.....	146	K1142.....	151	KAS30F.....	87
ASB3048.....	80	EC1067.....	143	K1147.....	149	KAS33A.....	87
ASB3072.....	80	EC1117.....	138	K1162.....	146	KAS33F.....	87
AST10.....	81	EC1125.....	124	K1167.....	143	KAS38A.....	88
AST15.....	81	EC1125L.....	126	K1716.....	102	KAS38F.....	88
AST90.....	81	EC1125R.....	126	K3017.....	135	KB1037.....	155
E0740.....	184	EC1127.....	127	K3062.....	137	KB1062.....	160
E0742.....	184	EC1127L.....	129	K3067.....	136	KB1067.....	158
E0840.....	184	EC1127R.....	129	K3117.....	135	KB1137.....	155
E0940.....	184	EC1142.....	151	K3162.....	137	KB1162.....	160
E1017.....	138	EC1147.....	149	K3167.....	136	KB1167.....	158
E1042.....	151	EC1162.....	146	K7033.....	196	KBC1037.....	155
E1047.....	149	EC1167.....	143	K7833.....	196	KBC1062.....	160
E1062.....	146	EC1304.....	103	KAL12BJ.....	47	KBC1067.....	158
E1067.....	143	EC1306.....	100	KAL12BU.....	47	KBC1137.....	155
E1117.....	138	EC2017.....	142	KAL12J.....	47	KBC1162.....	160
E1125.....	124	EC2062.....	148	KAL12U.....	47	KBC1167.....	158
E1125L.....	126	EC2067.....	145	KAL24IBLJ.....	49	KBCZP37.....	169
E1125R.....	126	EC2117.....	142	KAL24IBLU.....	49	KBCZP62.....	171
E1127.....	127	EC2125.....	130	KAL24IBRJ.....	49	KBCZP67.....	170
E1127L.....	129	EC2125L.....	131	KAL24IBRU.....	49	KCIPO4.....	104
E1127R.....	129	EC2125R.....	131	KAL24IJ.....	48	KC7X18.....	179
E1142.....	151	EC2127.....	132	KAL24IU.....	48	KC7X62.....	181
E1147.....	149	EC2127L.....	133	KAL24J.....	48	KC7X67.....	180
E1162.....	146	EC2127R.....	133	KAL24U.....	48	KC8L04.....	113
E1167.....	143	EC2162.....	148	KAL36IBCJ.....	50	KC8L14.....	113
E1716.....	102	EC2167.....	145	KAL36IBCU.....	50	KC8P04.....	112
E2017.....	142	EC3017.....	135	KAL36IBLJ.....	51	KC8P14.....	112
E2062.....	148	EC3062.....	137	KAL36IBLU.....	51	KC1017.....	138
E2067.....	145	EC3067.....	136	KAL36IBRJ.....	51	KC1042.....	151
E2117.....	142	EC3117.....	135	KAL36IBRU.....	51	KC1047.....	149
E2125.....	130	EC3162.....	137	KAL36IJ.....	50	KC1062.....	146
E2125L.....	131	EC3167.....	136	KAL36IU.....	50	KC1067.....	143
E2125R.....	131	EC4017.....	139	KAM10BHIPJ.....	45	KC1117.....	138
E2127.....	132	EC4062.....	147	KAM10BHIPU.....	45	KC1125.....	124
E2127L.....	133	EC4067.....	144	KAM10BHJ.....	20	KC1127.....	127
E2127R.....	133	EC4117.....	139	KAM10BHU.....	20	KC1142.....	151
E2162.....	148	EC4125.....	125	KAM10BJ.....	19	KC1147.....	149
E2167.....	145	EC4127.....	128	KAM10BU.....	19	KC1162.....	146
E3017.....	135	EC4162.....	147	KAM10HIPJ.....	44	KC1167.....	143
E3062.....	137	EC4167.....	144	KAM10HIPU.....	44	KC1304.....	103
E3067.....	136	ECD00N0.....	109	KAM10HJ.....	18	KC1306.....	100
E3117.....	135	ECD17N0.....	108	KAM10HU.....	18	KC3017.....	135
E3162.....	137	ECE00N0.....	107	KAM10J.....	18	KC3062.....	137

# INDEX BY MODEL NUMBER

KC3067	136	KMC1127R	129	KOU20	67	R1125	124
KC3117	135	KMC1162	146	KOU20I	68	R1125L	126
KC3162	137	KMC1167	143	KOU20IBL	69	R1125R	126
KC3167	136	KMC3017	135	KOU20IBR	69	R1127	127
KC8004	110	KMC3062	137	KOU20IT	68	R1127L	129
KC8006	111	KMC3067	136	KOU20T	68	R1127R	129
KC8014	110	KMC3117	135	KOU29	92	R1142	151
KC8016	111	KMC3162	137	KOU29I	93	R1147	149
KCD00NO	109	KMC3167	136	KOU30	69	R1162	146
KCD17N0	108	KMCZL17	172	KOU30I	70	R1167	143
KCE00NO	107	KMCZL62	174	KOU30IBC	70	R1716	102
KCE17N0	106	KMCZL67	173	KOU30IBL	70	R1740	185
KCF01NO	101	KMCZP17	165	KOU30IBR	71	R1742	185
KCH02NO	105	KMCZP62	167	KOU39	93	R1840	185
KCZL17	172	KMCZP67	166	KOU39I	93	R1940	185
KCZL62	174	KMCZX17	176	KOU90T	71	R3017	135
KCZL67	173	KMCZX62	178	KTC07	25	R3062	137
KCZP17	165	KMCZX67	177	KTC07	34	R3067	136
KCZP62	167	KMU10	58	KTC07	41	R3117	135
KCZP67	166	KMU10B	58	KTE07L	25	R3162	137
KCZX17	176	KMU19	94	KTE07L	34	R3167	136
KCZX62	178	KMU19-M	94	KTE07R	41	RB1037	155
KCZX67	177	KMU20	58	KTE07R	25	RB1062	160
KL1017	140	KMU20I	59	KTE07R	34	RB1067	158
KL1117	140	KMU20IBL	60	KTE07R	41	RB1137	155
KLC1017	140	KMU20IBR	60	KT107	25	RB1162	160
KLC1117	140	KMU20IT	59	KT107	34	RB1167	158
KLCZP17	168	KMU20T	59	KT107	41	RBC1037	155
KM1017	138	KMU29	94	KZE07L	196	RBC1062	160
KM1062	146	KMU29I	95	KZE07R	196	RBC1067	158
KM1067	143	KMU30	60	KZT10BHJ	29	RBC1137	155
KM1117	138	KMU30I	61	KZT10BHU	29	RBC1162	160
KM1125	124	KMU30IBC	61	KZT10BJ	28	RBC1167	158
KM1125L	126	KMU30IBL	61	KZT10BU	28	RBCZP37	169
KM1125R	126	KMU30IBR	62	KZT10HJ	27	RBCZP62	171
KM1127	127	KMU39	95	KZT10HU	27	RBCZP67	170
KM1127L	129	KMU39I	95	KZT10J	27	RC7X18	179
KM1127R	129	KOL12BU	53	KZT10U	27	RC7X62	181
KM1162	146	KOL12U	53	KZT12J	28	RC7X67	180
KM1167	143	KOL24IBLU	54	KZT12U	28	RC1017	138
KM1217	153	KOL24IBRU	54	KZT20IBLJ	30	RC1042	151
KM1740	186	KOL24IU	54	KZT20IBLU	30	RC1047	149
KM1742	186	KOL24U	53	KZT20IBRJ	31	RC1062	146
KM1840	186	KOL36IBCU	55	KZT20IBRU	31	RC1067	143
KM1940	186	KOL36IBLU	55	KZT20IJ	30	RC1117	138
KM3017	135	KOL36IBRU	56	KZT20IU	30	RC1125	124
KM3062	137	KOL36IU	55	KZT20J	29	RC1125L	126
KM3067	136	KOT00	24	KZT20U	29	RC1125R	126
KM3117	135	KOT00	40	KZT30IBCU	32	RC1127	127
KM3162	137	KOT10BHIPU	45	KZT30IBCU	32	RC1127L	129
KM3167	136	KOT10BHU	37	KZT30IBLJ	32	RC1127R	129
KM3217	152	KOT10BU	37	KZT30IBLU	32	RC1142	151
KMB1037	155	KOT10HIPU	44	KZT30IBRJ	33	RC1147	149
KMB1062	160	KOT10HU	36	KZT30IBRU	33	RC1162	146
KMB1067	158	KOT10U	36	KZT30IJ	31	RC1167	143
KMB1137	155	KOT12U	36	KZT30IU	31	RC1304	103
KMB1162	160	KOT19U	90	KZU10	64	RC1306	100
KMB1167	158	KOT19UM	90	KZU10B	65	RC3017	135
KMB1237	163	KOT20IBLU	38	KZU10BH	65	RC3062	137
KMBC1037	155	KOT20IBRU	38	KZU10H	64	RC3067	136
KMBC1062	160	KOT20IU	38	KZU12	64	RC3117	135
KMBC1067	158	KOT20U	37	KZU20	65	RC3162	137
KMBC1137	155	KOT24R	42	M0107	117	RC3167	136
KMBC1162	160	KOT29IU	91	N70XXXUF	192	RCD00NO	109
KMBC1167	158	KOT29U	90	N78XXXUF	192	RCD17N0	108
KMBCZP37	169	KOT30IBCU	39	OC2176UF	188	RCE00NO	107
KMBCZP62	171	KOT30IBLU	39	ON2076HPUF	189	RCE17N0	106
KMBCZP67	170	KOT30IBRU	40	ON2076UF	189	RCF01NO	101
KMC7X18	179	KOT30IU	39	ON2176UF	188	RCH02NO	105
KMC7X62	181	KOT36R	42	OO2176UF	188	RCZL17	172
KMC7X67	180	KOT39IU	91	OW2176UF	188	RCZL62	174
KMC1017	138	KOT2020	42	PT	25	RCZL67	173
KMC1062	146	KOT2420	42	PT	34	RCZP17	165
KMC1067	143	KOT3636	42	PT	41	RCZP62	167
KMC1117	138	KOT4820	42	R1017	138	RCZP67	166
KMC1125	124	KOU10	67	R1042	151	RCZX17	176
KMC1125L	126	KOU10B	67	R1047	149	RCZX62	178
KMC1125R	126	KOU15T	71	R1062	146	RCZX67	177
KMC1127	127	KOU19	92	R1067	143		
KMC1127L	129	KOU19-M	92	R1117	138		

# PUBLIC AREA SEATING

## Visitor

Kadia Mod Metal Visitor	17
Kenzley Visitor	26
Konzert Metal Visitor	35
Konzert   Kadia Occasional Tables	42
Konzert   Kadia Hip Chair	43

## Metal Lounge

Kadia Mod Metal Lounge	46
Konzert Metal Lounge	52

## Upholstered Lounge

Kadia Mod Upholstered Lounge	57
Kenzley Upholstered Lounge	63
Konzert Upholstered Lounge	66
Assymble Modular Lounge	72
Kascade Lounge	82
Behavioral Health	89





**General Product Information**

- Passive Flex Back
- Seat clean-out
- Wall-saver leg design
- Adjustable glides
- 16 gauge steel frame
- Arms connected by heavy steel rails
- Molded seat foam on 21" seats
- Back foam: 1.7 density foam that meets CAL 117 Fire Standards
- Comfort webbing in seats
- Field replaceable components

**To Order, Specify**

- Model Number
- Textile
- Finish
- Options

**Available Options**

FRAME OPTIONS *See pg 2 for finishes*  
 \*Default 540 Pewter finish. 211 Silver Frost available at no charge.

ARM CAP OPTIONS *See pg 2 for finishes*

- U Urethane Standard on specified models
- J Solid Surface Standard on specified models

**ADDITIONAL FEATURES & OPTIONS**

- CAL CAL TB133 *See pg 9*
- Z Multi Cover *Use Pricing for Highest Grade*
- MB Moisture Barrier *See pg 11*

**KAM10 - Guest Chair**

**Dimensions**

Overall			Seat		
W	D	H	W	D	H
24.5	29.5	33.25	20.75	19.5	18.25
			Back H	Arm H	
			15	25.5	

COM: 1.7 yds  
 Wt Cap: 550 lb  
 Unit Weight: 45 lb

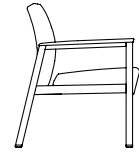
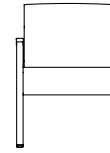

**KAM10U with Urethane Arm Caps**

COM	Dillon	Carson	A <sub>5</sub>	B <sub>6</sub>	C <sub>7</sub>	D <sub>8</sub>	E <sub>9</sub>	F <sub>10</sub>	G <sub>11</sub>	H <sub>12</sub>	I <sub>13</sub>
1,519	1,539	1,569	1,599	1,659	1,729	1,769	1,839	1,899	1,989	2,139	

**KAM10J with Solid Surface Arm Caps** (Add \$50 List per arm cap for Group 2 solid surface finish)

COM	Dillon	Carson	A <sub>5</sub>	B <sub>6</sub>	C <sub>7</sub>	D <sub>8</sub>	E <sub>9</sub>	F <sub>10</sub>	G <sub>11</sub>	H <sub>12</sub>	I <sub>13</sub>
2,139	2,159	2,199	2,259	2,299	2,339	2,379	2,449	2,529	2,609	2,679	

**KAM10H - High Back Guest Chair**

**Dimensions**

Overall			Seat		
W	D	H	W	D	H
24.5	29.5	45.5	20.75	19	18.25
			Back H	Arm H	
			26.75	25.5	

COM: 2.2 yds  
 Wt Cap: 550 lb  
 Unit Weight: 50 lb

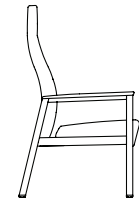
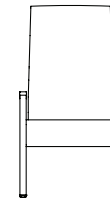

**KAM10HU with Urethane Arm Caps**

COM	Dillon	Carson	A <sub>5</sub>	B <sub>6</sub>	C <sub>7</sub>	D <sub>8</sub>	E <sub>9</sub>	F <sub>10</sub>	G <sub>11</sub>	H <sub>12</sub>	I <sub>13</sub>
1,779	1,789	1,809	1,839	1,889	1,959	2,009	2,079	2,119	2,229	2,389	

**KAM10HJ with Solid Surface Arm Caps** (Add \$50 List per arm cap for Group 2 solid surface finish)

COM	Dillon	Carson	A <sub>5</sub>	B <sub>6</sub>	C <sub>7</sub>	D <sub>8</sub>	E <sub>9</sub>	F <sub>10</sub>	G <sub>11</sub>	H <sub>12</sub>	I <sub>13</sub>
2,389	2,399	2,449	2,509	2,539	2,579	2,589	2,699	2,749	2,869	2,929	

**KAM12 - Guest Chair - 24" Seat**

**Dimensions**

Overall			Seat		
W	D	H	W	D	H
27.25	29.5	33.25	24	19.5	18.25
			Back H	Arm H	
			15	25.5	

COM: 1.8 yds  
 Wt Cap: 550 lb  
 Unit Weight: 50 lb

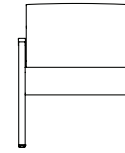

**KAM12U with Urethane Arm Caps**

COM	Dillon	Carson	A <sub>5</sub>	B <sub>6</sub>	C <sub>7</sub>	D <sub>8</sub>	E <sub>9</sub>	F <sub>10</sub>	G <sub>11</sub>	H <sub>12</sub>	I <sub>13</sub>
1,609	1,629	1,699	1,729	1,749	1,809	1,849	1,919	1,969	2,049	2,219	

**KAM12J with Solid Surface Arm Caps** (Add \$50 List per arm cap for Group 2 solid surface finish)

COM	Dillon	Carson	A <sub>5</sub>	B <sub>6</sub>	C <sub>7</sub>	D <sub>8</sub>	E <sub>9</sub>	F <sub>10</sub>	G <sub>11</sub>	H <sub>12</sub>	I <sub>13</sub>
2,219	2,249	2,279	2,339	2,369	2,429	2,439	2,509	2,569	2,809	2,849	

**KAM10B - Bariatric Guest Chair**

**Dimensions**

Overall			Seat		
W	D	H	W	D	H
33.5	29.5	33.25	29.5	19.5	18.25
			Back H	Arm H	
			15	25.5	

COM: 2.7 yds  
 Wt Cap: 750 lb  
 Unit Weight: 65 lb

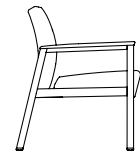
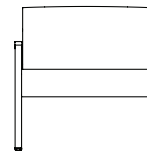

**KAM10BU with Urethane Arm Caps**

COM	Dillon	Carson	A <sub>5</sub>	B <sub>6</sub>	C <sub>7</sub>	D <sub>8</sub>	E <sub>9</sub>	F <sub>10</sub>	G <sub>11</sub>	H <sub>12</sub>	I <sub>13</sub>
1,819	1,849	1,919	2,009	2,039	2,159	2,249	2,349	2,389	2,559	2,819	

**KAM10BJ with Solid Surface Arm Caps** (Add \$50 List per arm cap for Group 2 solid surface finish)

COM	Dillon	Carson	A <sub>5</sub>	B <sub>6</sub>	C <sub>7</sub>	D <sub>8</sub>	E <sub>9</sub>	F <sub>10</sub>	G <sub>11</sub>	H <sub>12</sub>	I <sub>13</sub>
2,489	2,519	2,549	2,649	2,719	2,799	2,879	2,959	3,039	3,259	3,359	

**KAM10BH - High Back Bariatric Guest Chair**

**Dimensions**

Overall			Seat		
W	D	H	W	D	H
33.25	29.5	45	29.5	19	18.25
			Back H	Arm H	
			26.75	25.5	

COM: 3.4 yds  
 Wt Cap: 750 lb  
 Unit Weight: 72 lb

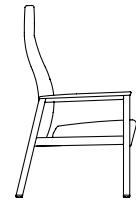
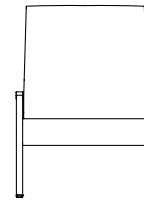

**KAM10BHU with Urethane Arm Caps**

COM	Dillon	Carson	A <sub>5</sub>	B <sub>6</sub>	C <sub>7</sub>	D <sub>8</sub>	E <sub>9</sub>	F <sub>10</sub>	G <sub>11</sub>	H <sub>12</sub>	I <sub>13</sub>
2,279	2,419	2,519	2,609	2,649	2,799	2,939	3,059	3,099	3,309	3,589	

**KAM10BHJ with Solid Surface Arm Caps** (Add \$50 List per arm cap for Group 2 solid surface finish)

COM	Dillon	Carson	A <sub>5</sub>	B <sub>6</sub>	C <sub>7</sub>	D <sub>8</sub>	E <sub>9</sub>	F <sub>10</sub>	G <sub>11</sub>	H <sub>12</sub>	I <sub>13</sub>
2,929	3,069	3,139	3,299	3,319	3,469	3,549	3,719	3,749	3,809	3,869	

**KAM20 - 2 Seat Guest Chair**

**Dimensions**

Overall			Seat		
W	D	H	W	D	H
45.5	29.5	33.25	42	19.5	18.25
			Back H	Arm H	
			15	25.5	

COM: 2.9 yds  
 Wt Cap: 750 lb  
 Unit Weight: 79 lb

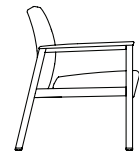
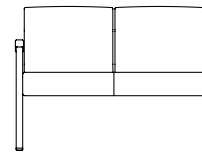

**KAM20U with Urethane Arm Caps**

COM	Dillon	Carson	A <sub>5</sub>	B <sub>6</sub>	C <sub>7</sub>	D <sub>8</sub>	E <sub>9</sub>	F <sub>10</sub>	G <sub>11</sub>	H <sub>12</sub>	I <sub>13</sub>
2,419	2,489	2,539	2,609	2,659	2,789	2,899	2,979	3,079	3,169	3,439	

**KAM20J with Solid Surface Arm Caps** (Add \$50 List per arm cap for Group 2 solid surface finish)

COM	Dillon	Carson	A <sub>5</sub>	B <sub>6</sub>	C <sub>7</sub>	D <sub>8</sub>	E <sub>9</sub>	F <sub>10</sub>	G <sub>11</sub>	H <sub>12</sub>	I <sub>13</sub>
3,079	3,129	3,159	3,299	3,329	3,439	3,499	3,579	3,589	3,699	3,819	

**KAM20I - 2 Seat Guest Chair with Intervening Arm**

**Dimensions**

Overall			Seat		
W	D	H	W	D	H
47	29.5	33.25	20.75	19.5	18.25
			Back H	Arm H	
			15	25.5	

COM: 3 yds  
 Wt Cap: 1000 lb  
 Unit Weight: 82 lb

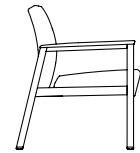
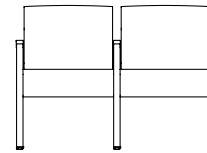

**KAM20IU with Urethane Arm Caps**

COM	Dillon	Carson	A <sub>5</sub>	B <sub>6</sub>	C <sub>7</sub>	D <sub>8</sub>	E <sub>9</sub>	F <sub>10</sub>	G <sub>11</sub>	H <sub>12</sub>	I <sub>13</sub>
2,739	2,779	2,839	2,899	2,969	3,059	3,199	3,279	3,309	3,459	3,749	

**KAM20IJ with Solid Surface Arm Caps** (Add \$50 List per arm cap for Group 2 solid surface finish)

COM	Dillon	Carson	A <sub>5</sub>	B <sub>6</sub>	C <sub>7</sub>	D <sub>8</sub>	E <sub>9</sub>	F <sub>10</sub>	G <sub>11</sub>	H <sub>12</sub>	I <sub>13</sub>
3,699	3,759	3,799	3,889	3,989	4,049	4,129	4,199	4,239	4,259	4,379	

**KAM20IBL - 2 Seat Left 29.5" Bariatric Guest Chair with Intervening Arm**

**Dimensions**

Overall			Seat		
W	D	H	W	D	H
58	29.5	33.25	20.75	19.5	18.25
			Back H	Arm H	
			15	25.5	

COM: 3.4 yds  
 Wt Cap: 1000 lb  
 Unit Weight: 87 lb

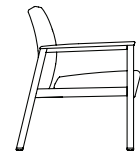
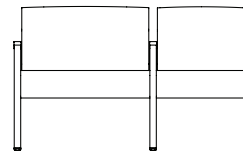

**KAM20IBLU with Urethane Arm Caps**

COM	Dillon	Carson	A <sub>5</sub>	B <sub>6</sub>	C <sub>7</sub>	D <sub>8</sub>	E <sub>9</sub>	F <sub>10</sub>	G <sub>11</sub>	H <sub>12</sub>	I <sub>13</sub>
3,119	3,139	3,219	3,309	3,339	3,479	3,649	3,749	3,829	3,899	4,219	

**KAM20IBLJ with Solid Surface Arm Caps** (Add \$50 List per arm cap for Group 2 solid surface finish)

COM	Dillon	Carson	A <sub>5</sub>	B <sub>6</sub>	C <sub>7</sub>	D <sub>8</sub>	E <sub>9</sub>	F <sub>10</sub>	G <sub>11</sub>	H <sub>12</sub>	I <sub>13</sub>
4,099	4,119	4,149	4,319	4,369	4,459	4,569	4,669	4,759	4,849	5,099	

**KAM20IBR - 2 Seat Right 29.5" Bariatric Guest Chair with Intervening Arm**

**Dimensions**

Overall			Seat		
W	D	H	W	D	H
58	29.5	33.25	20.75	19.5	18.25
			Back H	Arm H	
			15	25.5	

COM: 3.4 yds  
 Wt Cap: 1000 lb  
 Unit Weight: 87 lb

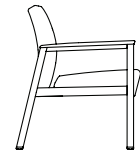
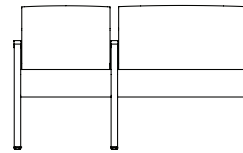

**KAM20IBRU with Urethane Arm Caps**

COM	Dillon	Carson	A <sub>5</sub>	B <sub>6</sub>	C <sub>7</sub>	D <sub>8</sub>	E <sub>9</sub>	F <sub>10</sub>	G <sub>11</sub>	H <sub>12</sub>	I <sub>13</sub>
3,119	3,139	3,219	3,309	3,339	3,479	3,649	3,749	3,829	3,899	4,219	

**KAM20IBRJ with Solid Surface Arm Caps** (Add \$50 List per arm cap for Group 2 solid surface finish)

COM	Dillon	Carson	A <sub>5</sub>	B <sub>6</sub>	C <sub>7</sub>	D <sub>8</sub>	E <sub>9</sub>	F <sub>10</sub>	G <sub>11</sub>	H <sub>12</sub>	I <sub>13</sub>
4,099	4,119	4,149	4,319	4,369	4,459	4,569	4,669	4,759	4,849	5,099	

**KAM30I - 3 Seat Guest Chair with Intervening Arms**

**Dimensions**

Overall			Seat		
W	D	H	W	D	H
69.5	29.5	33.25	20.75	19.5	18.25
			Back H	Arm H	
			15	25.5	

COM: 4.4 yds  
 Wt Cap: 1000 lb  
 Unit Weight: 120 lb

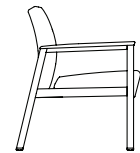
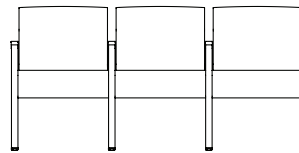

**KAM30IU with Urethane Arm Caps**

COM	Dillon	Carson	A <sub>5</sub>	B <sub>6</sub>	C <sub>7</sub>	D <sub>8</sub>	E <sub>9</sub>	F <sub>10</sub>	G <sub>11</sub>	H <sub>12</sub>	I <sub>13</sub>
3,669	3,709	3,829	3,919	3,989	4,189	4,409	4,469	4,509	4,739	5,209	

**KAM30IJ with Solid Surface Arm Caps** (Add \$50 List per arm cap for Group 2 solid surface finish)

COM	Dillon	Carson	A <sub>5</sub>	B <sub>6</sub>	C <sub>7</sub>	D <sub>8</sub>	E <sub>9</sub>	F <sub>10</sub>	G <sub>11</sub>	H <sub>12</sub>	I <sub>13</sub>
4,959	5,009	5,099	5,229	5,349	5,479	5,649	5,699	5,769	6,099	6,289	

**KAM30IBC - 3 Seat Center 29.5" Bariatric Guest Chair with Intervening Arms**

**Dimensions**

Overall			Seat		
W	D	H	W	D	H
78.25	29.5	33.25	20.75	19.5	18.25
			Back H	Arm H	
			15	25.5	

COM: 4.6 yds  
 Wt Cap: 1000 lb  
 Unit Weight: 127 lb

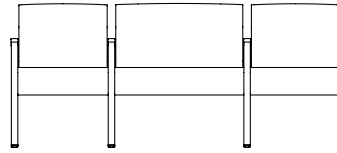

**KAM30IBCU with Urethane Arm Caps**

COM	Dillon	Carson	A <sub>5</sub>	B <sub>6</sub>	C <sub>7</sub>	D <sub>8</sub>	E <sub>9</sub>	F <sub>10</sub>	G <sub>11</sub>	H <sub>12</sub>	I <sub>13</sub>
4,239	4,319	4,409	4,559	4,679	4,889	5,029	5,189	5,319	5,529	5,729	

**KAM30IB CJ with Solid Surface Arm Caps** (Add \$50 List per arm cap for Group 2 solid surface finish)

COM	Dillon	Carson	A <sub>5</sub>	B <sub>6</sub>	C <sub>7</sub>	D <sub>8</sub>	E <sub>9</sub>	F <sub>10</sub>	G <sub>11</sub>	H <sub>12</sub>	I <sub>13</sub>
5,569	5,609	5,679	5,889	6,039	6,189	6,269	6,399	6,499	6,599	6,709	

**KAM30IBL - 3 Seat Left 29.5" Bariatric Guest Chair with Intervening Arms**

**Dimensions**

Overall			Seat		
W	D	H	W	D	H
78.25	29.5	33.25	20.75	19.5	18.25
			Back H	Arm H	
			15	25.5	

COM: 4.6 yds  
 Wt Cap: 1000 lb  
 Unit Weight: 127 lb

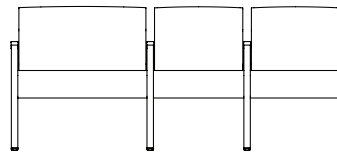

**KAM30IBLU with Urethane Arm Caps**

COM	Dillon	Carson	A <sub>5</sub>	B <sub>6</sub>	C <sub>7</sub>	D <sub>8</sub>	E <sub>9</sub>	F <sub>10</sub>	G <sub>11</sub>	H <sub>12</sub>	I <sub>13</sub>
4,239	4,319	4,409	4,559	4,679	4,889	5,029	5,189	5,319	5,529	5,729	

**KAM30IBLJ with Solid Surface Arm Caps** (Add \$50 List per arm cap for Group 2 solid surface finish)

COM	Dillon	Carson	A <sub>5</sub>	B <sub>6</sub>	C <sub>7</sub>	D <sub>8</sub>	E <sub>9</sub>	F <sub>10</sub>	G <sub>11</sub>	H <sub>12</sub>	I <sub>13</sub>
5,569	5,609	5,679	5,889	6,039	6,189	6,269	6,399	6,499	6,599	6,709	

**KAM30IBR - 3 Seat Right 29.5" Bariatric Guest Chair with Intervening Arms**

**Dimensions**

Overall			Seat		
W	D	H	W	D	H
78.25	29.5	33.25	20.75	19.5	18.25
			Back H	Arm H	
			15	25.5	

COM: 4.6 yds  
 Wt Cap: 1000 lb  
 Unit Weight: 127 lb

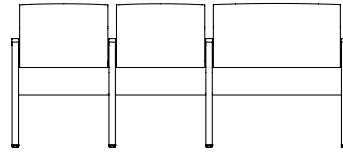

**KAM30IBRU with Urethane Arm Caps**

COM	Dillon/Carson	A <sub>5</sub>	B <sub>6</sub>	C <sub>7</sub>	D <sub>8</sub>	E <sub>9</sub>	F <sub>10</sub>	G <sub>11</sub>	H <sub>12</sub>	I <sub>13</sub>
4,239	4,319	4,409	4,559	4,679	4,889	5,029	5,189	5,319	5,529	5,729

**KAM30IBRJ with Solid Surface Arm Caps (Add \$50 List per arm cap for Group 2 solid surface finish)**

COM	Dillon/Carson	A <sub>5</sub>	B <sub>6</sub>	C <sub>7</sub>	D <sub>8</sub>	E <sub>9</sub>	F <sub>10</sub>	G <sub>11</sub>	H <sub>12</sub>	I <sub>13</sub>
5,569	5,609	5,679	5,889	6,039	6,189	6,269	6,399	6,499	6,599	6,709

**KOT00 - K-Series Ottoman**

**Dimensions**

Overall		
W	D	H
19	18.5	12

COM: 1.2 yds  
 Unit Weight: 12 lb

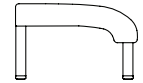
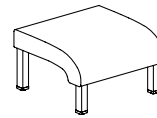

**KOT00**

COM	Dillon/Carson	A <sub>5</sub>	B <sub>6</sub>	C <sub>7</sub>	D <sub>8</sub>	E <sub>9</sub>	F <sub>10</sub>	G <sub>11</sub>	H <sub>12</sub>	I <sub>13</sub>
989	999	1,029	1,059	1,069	1,139	1,199	1,229	1,249	1,299	1,349

**KTC07 - Corner Ganging Table with Thermofoil Top**

<b>Dimensions</b>	Overall			<b>Unit Weight:</b> 32 lb	<b>Price</b> 1,209
	W	D	H		
	37	16	15		

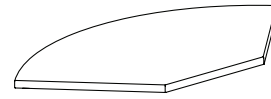

**KTE07L - Left End Ganging Table (facing) with Thermofoil Top**

<b>Dimensions</b>	Overall			<b>Unit Weight:</b> 32 lb	<b>Price</b> 989
	W	D	H		
	15.5	20	15		

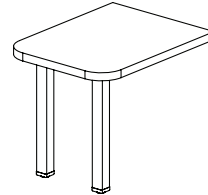

**KTE07R - Right End Ganging Table (facing) with Thermofoil Top**

<b>Dimensions</b>	Overall			<b>Unit Weight:</b> 32 lb	<b>Price</b> 989
	W	D	H		
	15.5	20	15		

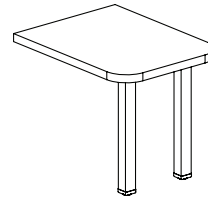

**KTI07 - Intervening Ganging Table with Thermofoil Top**

<b>Dimensions</b>	Overall			<b>Unit Weight:</b> 17 lb	<b>Price</b> 829
	W	D	H		
	15.5	20	15		

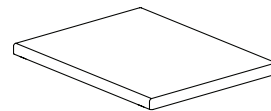

**PT - Undermount Power**

<b>Dimensions</b>	Overall			<b>Unit Weight:</b> 2 lb	<b>Price</b> 289
	W	D	H		
	9	12	2.25		

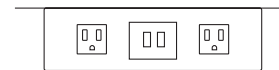

**GANG BRKT KOT - Ganging Bracket**

<b>Dimensions</b>	Overall			<b>Unit Weight:</b> 4 lb	<b>Price</b> 79
	W	D	H		
	11	0.25	3.5		

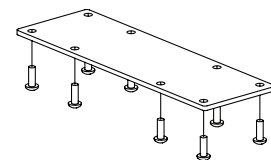

**To Order, Specify**

- Model Number
- Finish



**General Product Information**

- Passive Flex Back
- Seat clean-out
- Wall-saver leg design
- Adjustable glides
- 14 gauge steel frame
- Arms connected by heavy steel rails
- Molded seat foam on 21" seats
- Back foam: 1.7 density foam that meets CAL 117 Fire Standards
- Comfort webbing in seats
- Field replaceable components

**To Order, Specify**

- Model Number
- Textile
- Finish
- Options

**Available Options**

<p><b>FRAME OPTIONS</b> <span style="float: right;"><i>See pg 2 for finishes</i></span></p> <p><i>*Default 540 Pewter finish. 211 Silver Frost available at no charge.</i></p>		<p><b>ADDITIONAL FEATURES &amp; OPTIONS</b></p>	
<p><b>ARM CAP OPTIONS</b> <span style="float: right;"><i>See pg 2 for finishes</i></span></p>		CAL	CAL TB133 <span style="float: right;"><i>See pg 9</i></span>
U	Urethane <span style="float: right;"><i>Standard on specified models</i></span>	Z	Multi Cover <span style="float: right;"><i>Use Pricing for Highest Grade</i></span>
J	Solid Surface <span style="float: right;"><i>Standard on specified models</i></span>	MB	Moisture Barrier <span style="float: right;"><i>See pg 11</i></span>

**KZT10 - Guest Chair**

**Dimensions**

Overall			Seat		
W	D	H	W	D	H
24	29.25	33.25	21	20	18
			Back H	Arm H	
			15	25.25	

COM: 1.7 yds  
 Wt Cap: 550 lb  
 Unit Weight: 50 lb



**KZT10U with Urethane Arm Caps**

COM	Dillon	Carson	A <sub>5</sub>	B <sub>6</sub>	C <sub>7</sub>	D <sub>8</sub>	E <sub>9</sub>	F <sub>10</sub>	G <sub>11</sub>	H <sub>12</sub>	I <sub>13</sub>
1,519	1,539	1,569	1,599	1,659	1,729	1,769	1,839	1,899	1,989	2,139	

**KZT10J with Solid Surface Arm Caps** (Add \$50 List per arm cap for Group 2 solid surface finish)

COM	Dillon	Carson	A <sub>5</sub>	B <sub>6</sub>	C <sub>7</sub>	D <sub>8</sub>	E <sub>9</sub>	F <sub>10</sub>	G <sub>11</sub>	H <sub>12</sub>	I <sub>13</sub>
2,139	2,159	2,199	2,259	2,299	2,339	2,379	2,449	2,529	2,609	2,679	

**KZT10H - High Back Guest Chair**

**Dimensions**

Overall			Seat		
W	D	H	W	D	H
24	29.25	44.75	21	20	18
			Back H	Arm H	
			27.25	25.25	

COM: 2.2 yds  
 Wt Cap: 550 lb  
 Unit Weight: 55 lb

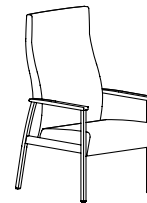

**KZT10HU with Urethane Arm Caps**

COM	Dillon	Carson	A <sub>5</sub>	B <sub>6</sub>	C <sub>7</sub>	D <sub>8</sub>	E <sub>9</sub>	F <sub>10</sub>	G <sub>11</sub>	H <sub>12</sub>	I <sub>13</sub>
1,779	1,789	1,809	1,839	1,889	1,959	2,009	2,079	2,119	2,229	2,389	

**KZT10HJ with Solid Surface Arm Caps** (Add \$50 List per arm cap for Group 2 solid surface finish)

COM	Dillon	Carson	A <sub>5</sub>	B <sub>6</sub>	C <sub>7</sub>	D <sub>8</sub>	E <sub>9</sub>	F <sub>10</sub>	G <sub>11</sub>	H <sub>12</sub>	I <sub>13</sub>
2,389	2,399	2,449	2,509	2,539	2,579	2,589	2,699	2,749	2,869	2,929	

**KZT12 - Guest Chair - 24" Seat**

**Dimensions**

Overall			Seat		
W	D	H	W	D	H
27.25	29.25	33.25	24	20	18
			Back H	Arm H	
			15	25.25	

COM: 1.8 yds  
 Wt Cap: 550 lb  
 Unit Weight: 54 lb

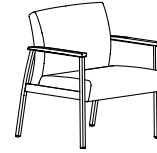

**KZT12U with Urethane Arm Caps**

COM	Dillon	Carson	A <sub>5</sub>	B <sub>6</sub>	C <sub>7</sub>	D <sub>8</sub>	E <sub>9</sub>	F <sub>10</sub>	G <sub>11</sub>	H <sub>12</sub>	I <sub>13</sub>
1,609	1,629	1,699	1,729	1,749	1,809	1,849	1,919	1,969	2,049	2,219	

**KZT12J with Solid Surface Arm Caps** (Add \$50 List per arm cap for Group 2 solid surface finish)

COM	Dillon	Carson	A <sub>5</sub>	B <sub>6</sub>	C <sub>7</sub>	D <sub>8</sub>	E <sub>9</sub>	F <sub>10</sub>	G <sub>11</sub>	H <sub>12</sub>	I <sub>13</sub>
2,219	2,249	2,279	2,339	2,369	2,429	2,439	2,509	2,569	2,809	2,849	

**KZT10B - Bariatric Guest Chair**

**Dimensions**

Overall			Seat		
W	D	H	W	D	H
33.25	29.25	33.25	30	20	18
			Back H	Arm H	
			15	25.25	

COM: 2.7 yds  
 Wt Cap: 750 lb  
 Unit Weight: 60 lb

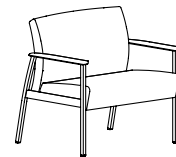

**KZT10BU with Urethane Arm Caps**

COM	Dillon	Carson	A <sub>5</sub>	B <sub>6</sub>	C <sub>7</sub>	D <sub>8</sub>	E <sub>9</sub>	F <sub>10</sub>	G <sub>11</sub>	H <sub>12</sub>	I <sub>13</sub>
1,819	1,849	1,919	2,009	2,039	2,159	2,249	2,349	2,389	2,559	2,819	

**KZT10BJ with Solid Surface Arm Caps** (Add \$50 List per arm cap for Group 2 solid surface finish)

COM	Dillon	Carson	A <sub>5</sub>	B <sub>6</sub>	C <sub>7</sub>	D <sub>8</sub>	E <sub>9</sub>	F <sub>10</sub>	G <sub>11</sub>	H <sub>12</sub>	I <sub>13</sub>
2,489	2,519	2,549	2,649	2,719	2,799	2,879	2,959	3,039	3,259	3,359	

**KZT10BH - High Back Bariatric Guest Chair**

**Dimensions**

Overall			Seat		
W	D	H	W	D	H
33.25	29.25	44.75	30	20	18
			Back H	Arm H	
			27.25	25.25	

COM: 3.4 yds  
 Wt Cap: 750 lb  
 Unit Weight: 67 lb

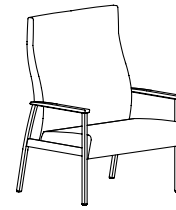

**KZT10BHU with Urethane Arm Caps**

COM	Dillon	Carson	A <sub>5</sub>	B <sub>6</sub>	C <sub>7</sub>	D <sub>8</sub>	E <sub>9</sub>	F <sub>10</sub>	G <sub>11</sub>	H <sub>12</sub>	I <sub>13</sub>
2,279	2,419	2,519	2,609	2,649	2,799	2,939	3,059	3,099	3,309	3,589	

**KZT10BHJ with Solid Surface Arm Caps** (Add \$50 List per arm cap for Group 2 solid surface finish)

COM	Dillon	Carson	A <sub>5</sub>	B <sub>6</sub>	C <sub>7</sub>	D <sub>8</sub>	E <sub>9</sub>	F <sub>10</sub>	G <sub>11</sub>	H <sub>12</sub>	I <sub>13</sub>
2,929	3,069	3,139	3,299	3,319	3,469	3,549	3,719	3,749	3,809	3,869	

**KZT20 - 2 Seat Guest Chair**

**Dimensions**

Overall			Seat		
W	D	H	W	D	H
45	29.25	33.25	42	20	18
			Back H	Arm H	
			15	25.25	

COM: 2.9 yds  
 Wt Cap: 750 lb  
 Unit Weight: 86 lb

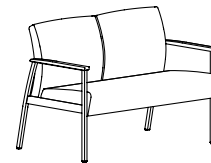

**KZT20U with Urethane Arm Caps**

COM	Dillon	Carson	A <sub>5</sub>	B <sub>6</sub>	C <sub>7</sub>	D <sub>8</sub>	E <sub>9</sub>	F <sub>10</sub>	G <sub>11</sub>	H <sub>12</sub>	I <sub>13</sub>
2,419	2,489	2,539	2,609	2,659	2,789	2,899	2,979	3,079	3,169	3,439	

**KZT20J with Solid Surface Arm Caps** (Add \$50 List per arm cap for Group 2 solid surface finish)

COM	Dillon	Carson	A <sub>5</sub>	B <sub>6</sub>	C <sub>7</sub>	D <sub>8</sub>	E <sub>9</sub>	F <sub>10</sub>	G <sub>11</sub>	H <sub>12</sub>	I <sub>13</sub>
3,079	3,129	3,159	3,299	3,329	3,439	3,499	3,579	3,589	3,699	3,819	

**KZT20I - 2 Seat Guest Chair with Intervening Arm**

**Dimensions**

Overall			Seat				
W	D	H	W	D	H		
47	29.25	33.25	21	20	18		
			Back H	Arm H			
			15	25.25			

COM: 3 yds  
 Wt Cap: 1000 lb  
 Unit Weight: 89 lb

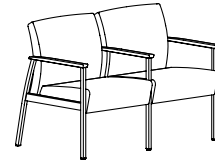

**KZT20IU with Urethane Arm Caps**

COM	Dillon	Carson	A <sub>5</sub>	B <sub>6</sub>	C <sub>7</sub>	D <sub>8</sub>	E <sub>9</sub>	F <sub>10</sub>	G <sub>11</sub>	H <sub>12</sub>	I <sub>13</sub>
2,739	2,779	2,839	2,899	2,969	3,059	3,199	3,279	3,309	3,459	3,749	

**KZT20IJ with Solid Surface Arm Caps** (Add \$50 List per arm cap for Group 2 solid surface finish)

COM	Dillon	Carson	A <sub>5</sub>	B <sub>6</sub>	C <sub>7</sub>	D <sub>8</sub>	E <sub>9</sub>	F <sub>10</sub>	G <sub>11</sub>	H <sub>12</sub>	I <sub>13</sub>
3,699	3,759	3,799	3,889	3,989	4,049	4,129	4,199	4,239	4,259	4,379	

**KZT20IBL - 2 Seat Left 29.5" Bariatric Guest Chair with Intervening Arm**

**Dimensions**

Overall			Seat				
W	D	H	W	D	H		
55.5	29.25	33.25	21	20	18		
			Back H	Arm H			
			15	25.25			

COM: 3.4 yds  
 Wt Cap: 1000 lb  
 Unit Weight: 110 lb

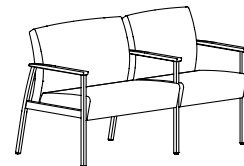

**KZT20IBLU with Urethane Arm Caps**

COM	Dillon	Carson	A <sub>5</sub>	B <sub>6</sub>	C <sub>7</sub>	D <sub>8</sub>	E <sub>9</sub>	F <sub>10</sub>	G <sub>11</sub>	H <sub>12</sub>	I <sub>13</sub>
3,119	3,139	3,219	3,309	3,339	3,479	3,649	3,749	3,829	3,899	4,219	

**KZT20IBLJ with Solid Surface Arm Caps** (Add \$50 List per arm cap for Group 2 solid surface finish)

COM	Dillon	Carson	A <sub>5</sub>	B <sub>6</sub>	C <sub>7</sub>	D <sub>8</sub>	E <sub>9</sub>	F <sub>10</sub>	G <sub>11</sub>	H <sub>12</sub>	I <sub>13</sub>
4,099	4,119	4,149	4,319	4,369	4,459	4,569	4,669	4,759	4,849	5,099	

**KZT20IBR - 2 Seat Right 29.5" Bariatric Guest Chair with Intervening Arm**

**Dimensions**

Overall			Seat				
W	D	H	W	D	H		
55.5	29.25	33.25	21	20	18		
			Back H	Arm H			
			15	25.25			

COM: 3.4 yds  
 Wt Cap: 1000 lb  
 Unit Weight: 110 lb

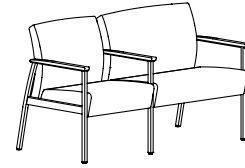

**KZT20IBRU with Urethane Arm Caps**

COM	Dillon	Carson	A <sub>5</sub>	B <sub>6</sub>	C <sub>7</sub>	D <sub>8</sub>	E <sub>9</sub>	F <sub>10</sub>	G <sub>11</sub>	H <sub>12</sub>	I <sub>13</sub>
3,119	3,139	3,219	3,309	3,339	3,479	3,649	3,749	3,829	3,899	4,219	

**KZT20IBRJ with Solid Surface Arm Caps** (Add \$50 List per arm cap for Group 2 solid surface finish)

COM	Dillon	Carson	A <sub>5</sub>	B <sub>6</sub>	C <sub>7</sub>	D <sub>8</sub>	E <sub>9</sub>	F <sub>10</sub>	G <sub>11</sub>	H <sub>12</sub>	I <sub>13</sub>
4,099	4,119	4,149	4,319	4,369	4,459	4,569	4,669	4,759	4,849	5,099	

**KZT30I - 3 Seat Guest Chair with Intervening Arms**

**Dimensions**

Overall			Seat				
W	D	H	W	D	H		
69	29.25	33.25	21	20	18		
			Back H	Arm H			
			15	25.25			

COM: 4.4 yds  
 Wt Cap: 1000 lb  
 Unit Weight: 100 lb

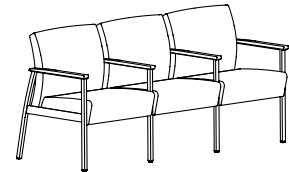

**KZT30IU with Urethane Arm Caps**

COM	Dillon	Carson	A <sub>5</sub>	B <sub>6</sub>	C <sub>7</sub>	D <sub>8</sub>	E <sub>9</sub>	F <sub>10</sub>	G <sub>11</sub>	H <sub>12</sub>	I <sub>13</sub>
3,669	3,709	3,829	3,919	3,989	4,189	4,409	4,469	4,509	4,739	5,209	

**KZT30IJ with Solid Surface Arm Caps** (Add \$50 List per arm cap for Group 2 solid surface finish)

COM	Dillon	Carson	A <sub>5</sub>	B <sub>6</sub>	C <sub>7</sub>	D <sub>8</sub>	E <sub>9</sub>	F <sub>10</sub>	G <sub>11</sub>	H <sub>12</sub>	I <sub>13</sub>
4,959	5,009	5,099	5,229	5,349	5,479	5,649	5,699	5,769	6,099	6,289	

**KZT30IBC - 3 Seat Center 29.5" Bariatric Guest Chair with Intervening Arms**

**Dimensions**

Overall			Seat				
W	D	H	W	D	H		
78	29.25	33.25	21	20	18		
			Back H	Arm H			
			15	25.25			

COM: 4.6 yds  
 Wt Cap: 1000 lb  
 Unit Weight: 136 lb

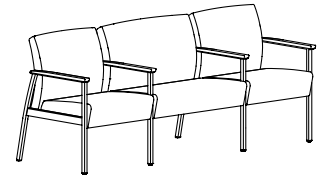

**KZT30IBCU with Urethane Arm Caps**

COM	Dillon	Carson	A <sub>5</sub>	B <sub>6</sub>	C <sub>7</sub>	D <sub>8</sub>	E <sub>9</sub>	F <sub>10</sub>	G <sub>11</sub>	H <sub>12</sub>	I <sub>13</sub>
4,239	4,319	4,409	4,559	4,679	4,889	5,029	5,189	5,319	5,529	5,729	

**KZT30IBCU with Solid Surface Arm Caps (Add \$50 List per arm cap for Group 2 solid surface finish)**

COM	Dillon	Carson	A <sub>5</sub>	B <sub>6</sub>	C <sub>7</sub>	D <sub>8</sub>	E <sub>9</sub>	F <sub>10</sub>	G <sub>11</sub>	H <sub>12</sub>	I <sub>13</sub>
5,569	5,609	5,679	5,889	6,039	6,189	6,269	6,399	6,499	6,599	6,709	

**KZT30IBL - 3 Seat Left 29.5" Bariatric Guest Chair with Intervening Arms**

**Dimensions**

Overall			Seat				
W	D	H	W	D	H		
78	29.25	33.25	21	20	18		
			Back H	Arm H			
			15	25.25			

COM: 4.6 yds  
 Wt Cap: 1000 lb  
 Unit Weight: 136 lb

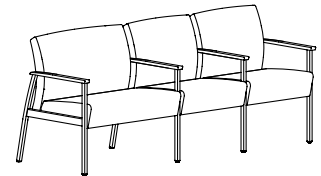

**KZT30IBLU with Urethane Arm Caps**

COM	Dillon	Carson	A <sub>5</sub>	B <sub>6</sub>	C <sub>7</sub>	D <sub>8</sub>	E <sub>9</sub>	F <sub>10</sub>	G <sub>11</sub>	H <sub>12</sub>	I <sub>13</sub>
4,239	4,319	4,409	4,559	4,679	4,889	5,029	5,189	5,319	5,529	5,729	

**KZT30IBLU with Solid Surface Arm Caps (Add \$50 List per arm cap for Group 2 solid surface finish)**

COM	Dillon	Carson	A <sub>5</sub>	B <sub>6</sub>	C <sub>7</sub>	D <sub>8</sub>	E <sub>9</sub>	F <sub>10</sub>	G <sub>11</sub>	H <sub>12</sub>	I <sub>13</sub>
5,569	5,609	5,679	5,889	6,039	6,189	6,269	6,399	6,499	6,599	6,709	

**KZT30IBR - 3 Seat Right 29.5" Bariatric Guest Chair with Intervening Arms**

**Dimensions**

Overall			Seat		
W	D	H	W	D	H
78	29.25	33.25	21	20	18
			Back H	Arm H	
			15	25.25	

COM: 4.6 yds  
 Wt Cap: 1000 lb  
 Unit Weight: 136 lb

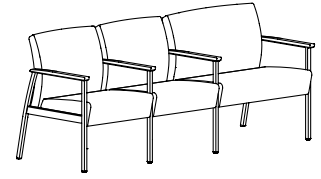

**KZT30IBRU with Urethane Arm Caps**

COM	Dillon	Carson	A <sub>5</sub>	B <sub>6</sub>	C <sub>7</sub>	D <sub>8</sub>	E <sub>9</sub>	F <sub>10</sub>	G <sub>11</sub>	H <sub>12</sub>	I <sub>13</sub>
4,239	4,319	4,409	4,559	4,679	4,889	5,029	5,189	5,319	5,529	5,729	

**KZT30IBRJ with Solid Surface Arm Caps** (Add \$50 List per arm cap for Group 2 solid surface finish)

COM	Dillon	Carson	A <sub>5</sub>	B <sub>6</sub>	C <sub>7</sub>	D <sub>8</sub>	E <sub>9</sub>	F <sub>10</sub>	G <sub>11</sub>	H <sub>12</sub>	I <sub>13</sub>
5,569	5,609	5,679	5,889	6,039	6,189	6,269	6,399	6,499	6,599	6,709	

**KTC07 - Corner Ganging Table with Thermofoil Top**

<b>Dimensions</b>	Overall			<b>Unit Weight:</b> 32 lb	<b>Price</b> 1,209
	W	D	H		
	37	16	15		

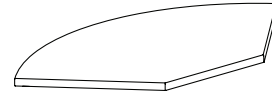

**KTE07L - Left End Ganging Table (facing) with Thermofoil Top**

<b>Dimensions</b>	Overall			<b>Unit Weight:</b> 32 lb	<b>Price</b> 989
	W	D	H		
	15.5	20	15		

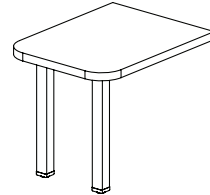

**KTE07R - Right End Ganging Table (facing) with Thermofoil Top**

<b>Dimensions</b>	Overall			<b>Unit Weight:</b> 32 lb	<b>Price</b> 989
	W	D	H		
	15.5	20	15		

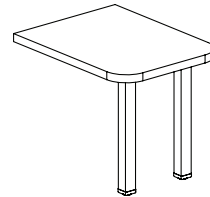

**KTI07 - Intervening Ganging Table with Thermofoil Top**

<b>Dimensions</b>	Overall			<b>Unit Weight:</b> 17 lb	<b>Price</b> 829
	W	D	H		
	15.5	20	15		

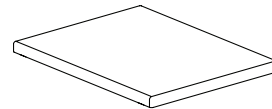

**PT - Undermount Power**

<b>Dimensions</b>	Overall			<b>Unit Weight:</b> 2 lb	<b>Price</b> 289
	W	D	H		
	9	12	2.25		

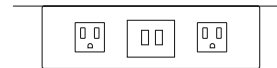

**GANG BRKT KOT - Ganging Bracket**

<b>Dimensions</b>	Overall			<b>Unit Weight:</b> 4 lb	<b>Price</b> 79
	W	D	H		
	11	0.25	3.5		

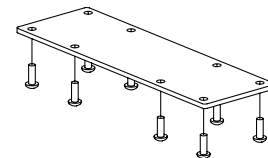

**To Order, Specify**

- Model Number
- Finish



**General Product Information**

- Passive Flex Back
- Seat clean-out
- Wall-saver leg design
- Adjustable glides
- 16 gauge steel frame
- Arms connected by heavy steel rails
- Molded seat foam on 21" seats
- Back foam: 1.7 density foam that meets CAL 117 Fire Standards
- Comfort webbing in seats
- Field replaceable components

**To Order, Specify**

- Model Number
- Textile
- Finish
- Options

**Available Options**

<p>FRAME OPTIONS <i>See pg 2 for finishes</i>                  *Default 540 Pewter finish. 211 Silver Frost available at no charge.</p>		<p>ADDITIONAL FEATURES &amp; OPTIONS</p>	
<p>ARM CAP OPTIONS <i>See pg 2 for finishes</i></p>		CAL	CAL TB133 <i>See pg 9</i>
U	Urethane <i>Standard</i>	Z	Multi Cover <i>Use Pricing for Highest Grade</i>
		MB	Moisture Barrier <i>See pg 11</i>

**KOT10 - Guest Chair**

**Dimensions**

Overall			Seat		
W	D	H	W	D	H
24.5	29.5	33.25	20.75	19.5	18.25
			Back H	Arm H	
			15	25.75	

**COM:** 1.7 yds  
**Wt Cap:** 550 lb  
**Unit Weight:** 56 lb

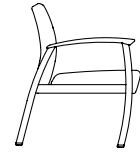
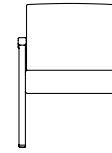

**KOT10U with Urethane Arm Caps**

COM	Dillon/Carson	A <sub>5</sub>	B <sub>6</sub>	C <sub>7</sub>	D <sub>8</sub>	E <sub>9</sub>	F <sub>10</sub>	G <sub>11</sub>	H <sub>12</sub>	I <sub>13</sub>
1,519	1,539	1,569	1,599	1,659	1,729	1,769	1,839	1,899	1,989	2,139

**KOT10H - High Back Guest Chair**

**Dimensions**

Overall			Seat		
W	D	H	W	D	H
24.5	29.5	45	20.75	19	18.25
			Back H	Arm H	
			26.75	25.75	

**COM:** 2.2 yds  
**Wt Cap:** 550 lb  
**Unit Weight:** 61 lb

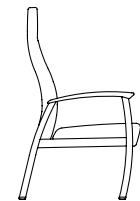
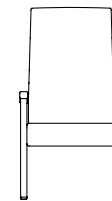

**KOT10HU with Urethane Arm Caps**

COM	Dillon/Carson	A <sub>5</sub>	B <sub>6</sub>	C <sub>7</sub>	D <sub>8</sub>	E <sub>9</sub>	F <sub>10</sub>	G <sub>11</sub>	H <sub>12</sub>	I <sub>13</sub>
1,779	1,789	1,809	1,839	1,889	1,959	2,009	2,079	2,119	2,229	2,389

**KOT12 - Guest Chair - 24" Seat**

**Dimensions**

Overall			Seat		
W	D	H	W	D	H
27.25	29.5	33.25	24	19.5	18.25
			Back H	Arm H	
			15	25.75	

**COM:** 1.8 yds  
**Wt Cap:** 550 lb  
**Unit Weight:** 61 lb

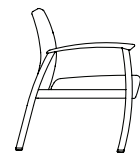
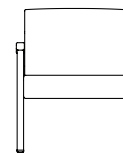

**KOT12U with Urethane Arm Caps**

COM	Dillon/Carson	A <sub>5</sub>	B <sub>6</sub>	C <sub>7</sub>	D <sub>8</sub>	E <sub>9</sub>	F <sub>10</sub>	G <sub>11</sub>	H <sub>12</sub>	I <sub>13</sub>
1,609	1,629	1,699	1,729	1,749	1,809	1,849	1,919	1,969	2,049	2,219

**KOT10B - Bariatric Guest Chair**

**Dimensions**

Overall			Seat		
W	D	H	W	D	H
33.5	29.5	33.25	29.5	19.5	18.25
			Back H	Arm H	
			15	25.75	

COM: 2.7 yds  
 Wt Cap: 750 lb  
 Unit Weight: 76 lb

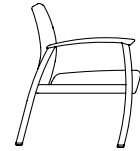
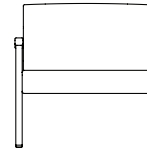

**KOT10BU with Urethane Arm Caps**

COM	Dillon/Carson	A <sub>5</sub>	B <sub>6</sub>	C <sub>7</sub>	D <sub>8</sub>	E <sub>9</sub>	F <sub>10</sub>	G <sub>11</sub>	H <sub>12</sub>	I <sub>13</sub>
1,819	1,849	1,919	2,009	2,039	2,159	2,249	2,349	2,389	2,559	2,819

**KOT10BH - High Back Bariatric Guest Chair**

**Dimensions**

Overall			Seat		
W	D	H	W	D	H
33.5	29.5	45	29.5	19	18.25
			Back H	Arm H	
			26.75	25.75	

COM: 3.4 yds  
 Wt Cap: 750 lb  
 Unit Weight: 83 lb

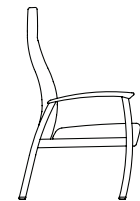
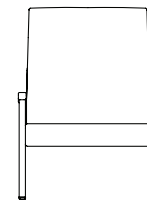

**KOT10BHU with Urethane Arm Caps**

COM	Dillon/Carson	A <sub>5</sub>	B <sub>6</sub>	C <sub>7</sub>	D <sub>8</sub>	E <sub>9</sub>	F <sub>10</sub>	G <sub>11</sub>	H <sub>12</sub>	I <sub>13</sub>
2,279	2,419	2,519	2,609	2,649	2,799	2,939	3,059	3,099	3,309	3,589

**KOT20 - 2 Seat Guest Chair**

**Dimensions**

Overall			Seat		
W	D	H	W	D	H
45.5	29.5	33.25	42	19.5	18.25
			Back H	Arm H	
			15	25.75	

COM: 2.9 yds  
 Wt Cap: 750 lb  
 Unit Weight: 90 lb

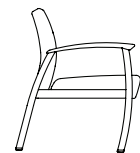
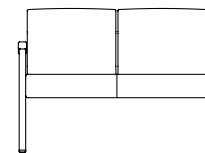

**KOT20U with Urethane Arm Caps**

COM	Dillon/Carson	A <sub>5</sub>	B <sub>6</sub>	C <sub>7</sub>	D <sub>8</sub>	E <sub>9</sub>	F <sub>10</sub>	G <sub>11</sub>	H <sub>12</sub>	I <sub>13</sub>
2,419	2,489	2,539	2,609	2,659	2,789	2,899	2,979	3,079	3,169	3,439

**KOT20I - 2 Seat Guest Chair with Intervening Arm**

**Dimensions**

Overall			Seat		
W	D	H	W	D	H
47	29.5	33.25	20.75	19.5	18.25
			Back H	Arm H	
			15	25.75	

COM: 3 yds  
 Wt Cap: 1000 lb  
 Unit Weight: 101 lb

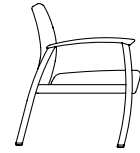
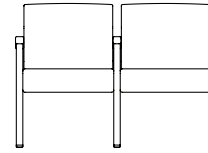

**KOT20IU with Urethane Arm Caps**

COM	Dillon/Carson	A <sub>5</sub>	B <sub>6</sub>	C <sub>7</sub>	D <sub>8</sub>	E <sub>9</sub>	F <sub>10</sub>	G <sub>11</sub>	H <sub>12</sub>	I <sub>13</sub>
2,739	2,779	2,839	2,899	2,969	3,059	3,199	3,279	3,309	3,459	3,749

**KOT20IBL - 2 Seat Left 29.5" Bariatric Guest Chair with Intervening Arm**

**Dimensions**

Overall			Seat		
W	D	H	W	D	H
58	29.5	33.25	20.75	19.5	18.25
			Back H	Arm H	
			15	25.75	

COM: 3.4 yds  
 Wt Cap: 1000 lb  
 Unit Weight: 115 lb

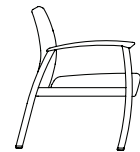
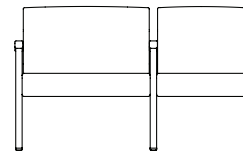

**KOT20IBLU with Urethane Arm Caps**

COM	Dillon/Carson	A <sub>5</sub>	B <sub>6</sub>	C <sub>7</sub>	D <sub>8</sub>	E <sub>9</sub>	F <sub>10</sub>	G <sub>11</sub>	H <sub>12</sub>	I <sub>13</sub>
3,119	3,139	3,219	3,309	3,339	3,479	3,649	3,749	3,829	3,899	4,219

**KOT20IBR - 2 Seat Right 29.5" Bariatric Guest Chair with Intervening Arm**

**Dimensions**

Overall			Seat		
W	D	H	W	D	H
58	29.5	33.25	20.75	19.5	18.25
			Back H	Arm H	
			15	25.75	

COM: 3.4 yds  
 Wt Cap: 1000 lb  
 Unit Weight: 115 lb

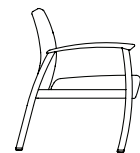
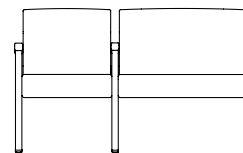

**KOT20IBRU with Urethane Arm Caps**

COM	Dillon/Carson	A <sub>5</sub>	B <sub>6</sub>	C <sub>7</sub>	D <sub>8</sub>	E <sub>9</sub>	F <sub>10</sub>	G <sub>11</sub>	H <sub>12</sub>	I <sub>13</sub>
3,119	3,139	3,219	3,309	3,339	3,479	3,649	3,749	3,829	3,899	4,219

**KOT30I - 3 Seat Guest Chair with Intervening Arms**

**Dimensions**

Overall			Seat		
W	D	H	W	D	H
69.5	29.5	33.25	20.75	19.5	18.25
			Back H	Arm H	
			15	25.75	

COM: 4.4 yds  
 Wt Cap: 1000 lb  
 Unit Weight: 159 lb

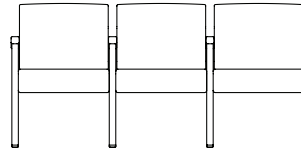

**KOT30IU with Urethane Arm Caps**

COM	Dillon/Carson	A <sub>5</sub>	B <sub>6</sub>	C <sub>7</sub>	D <sub>8</sub>	E <sub>9</sub>	F <sub>10</sub>	G <sub>11</sub>	H <sub>12</sub>	I <sub>13</sub>
3,669	3,709	3,829	3,919	3,989	4,189	4,409	4,469	4,509	4,739	5,209

**KOT30IBC - 3 Seat Center 29.5" Bariatric Guest Chair with Intervening Arms**

**Dimensions**

Overall			Seat		
W	D	H	W	D	H
78.25	29.5	33.25	20.75	19.5	18.25
			Back H	Arm H	
			15	25.75	

COM: 4.6 yds  
 Wt Cap: 1000 lb  
 Unit Weight: 154 lb

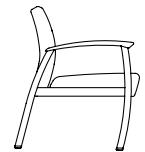
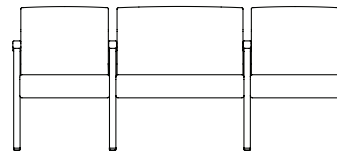

**KOT30IBCU with Urethane Arm Caps**

COM	Dillon/Carson	A <sub>5</sub>	B <sub>6</sub>	C <sub>7</sub>	D <sub>8</sub>	E <sub>9</sub>	F <sub>10</sub>	G <sub>11</sub>	H <sub>12</sub>	I <sub>13</sub>
4,239	4,319	4,409	4,559	4,679	4,889	5,029	5,189	5,209	5,219	5,729

**KOT30IBL - 3 Seat Left 29.5" Bariatric Guest Chair with Intervening Arms**

**Dimensions**

Overall			Seat		
W	D	H	W	D	H
78.25	29.5	33.25	20.75	19.5	18.25
			Back H	Arm H	
			15	25.75	

COM: 4.6 yds  
 Wt Cap: 1000 lb  
 Unit Weight: 154 lb

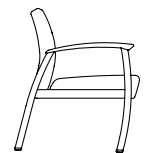
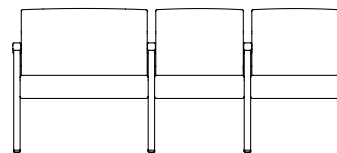

**KOT30IBLU with Urethane Arm Caps**

COM	Dillon/Carson	A <sub>5</sub>	B <sub>6</sub>	C <sub>7</sub>	D <sub>8</sub>	E <sub>9</sub>	F <sub>10</sub>	G <sub>11</sub>	H <sub>12</sub>	I <sub>13</sub>
4,239	4,319	4,409	4,559	4,679	4,889	5,029	5,189	5,209	5,219	5,729

**KOT30IBR - 3 Seat Right 29.5" Bariatric Guest Chair with Intervening Arms**

**Dimensions**

Overall			Seat		
W	D	H	W	D	H
78.25	29.5	33.25	20.75	19.5	18.25
			Back H	Arm H	
			15	25.75	

COM: 4.6 yds  
 Wt Cap: 1000 lb  
 Unit Weight: 154 lb

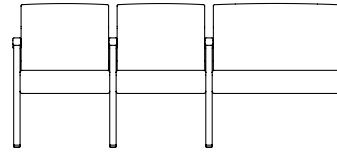

**KOT30IBRU with Urethane Arm Caps**

COM	Dillon/Carson	A5	B6	C7	D8	E9	F10	G11	H12	I13
4,239	4,319	4,409	4,559	4,679	4,889	5,029	5,189	5,209	5,219	5,729

**KOT00 - K-Series Ottoman**

**Dimensions**

Overall		
W	D	H
19	18.5	12

COM: 1.2 yds  
 Unit Weight: 12 lb

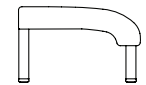
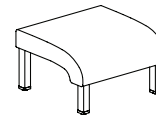

**KOT00**

COM	Dillon/Carson	A5	B6	C7	D8	E9	F10	G11	H12	I13
989	999	1,029	1,059	1,069	1,139	1,199	1,229	1,249	1,299	1,349

**KTC07 - Corner Ganging Table with Thermofoil Top**

<b>Dimensions</b>	Overall			<b>Unit Weight:</b> 32 lb	<b>Price</b> 1,209
	W	D	H		
	37	16	15		

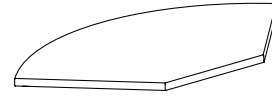

**KTE07L - Left End Ganging Table (facing) with Thermofoil Top**

<b>Dimensions</b>	Overall			<b>Unit Weight:</b> 32 lb	<b>Price</b> 989
	W	D	H		
	15.5	20	15		

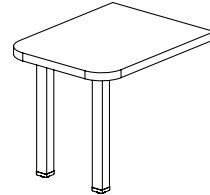

**KTE07R - Right End Ganging Table (facing) with Thermofoil Top**

<b>Dimensions</b>	Overall			<b>Unit Weight:</b> 32 lb	<b>Price</b> 989
	W	D	H		
	15.5	20	15		

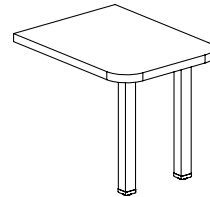

**KTI07 - Intervening Ganging Table with Thermofoil Top**

<b>Dimensions</b>	Overall			<b>Unit Weight:</b> 17 lb	<b>Price</b> 829
	W	D	H		
	15.5	20	15		

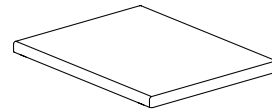

**PT - Undermount Power**

<b>Dimensions</b>	Overall			<b>Unit Weight:</b> 2 lb	<b>Price</b> 289
	W	D	H		
	9	12	2.25		

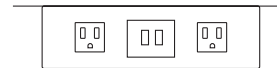

**GANG BRKT KOT - Ganging Bracket**

<b>Dimensions</b>	Overall			<b>Unit Weight:</b> 4 lb	<b>Price</b> 79
	W	D	H		
	11	0.25	3.5		

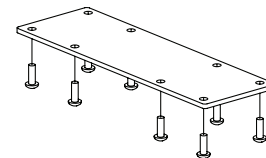

**To Order, Specify**

- Model Number
- Tabletop Finish
- Leg/skirt Finish (if applicable)

**KOT2020 - K-Series 20 x 20 End Table with Thermofoil Top**

**Dimensions**

Overall		
W	D	H
20	20	21.25

Unit Weight: 29 lb

**Price**

1,029

(Contact customer service for solid surface pricing)

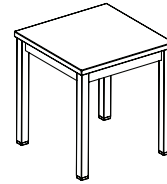

**KOT2420 - K-Series 24 x 20 End Table with Thermofoil Top**

**Dimensions**

Overall		
W	D	H
24	20	21.25

Unit Weight: 32 lb

**Price**

1,039

(Contact customer service for solid surface pricing)

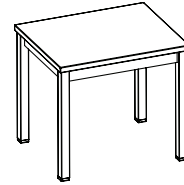

**KOT3636 - K-Series 36 x 36 Magazine Table with Thermofoil Top**

**Dimensions**

Overall		
W	D	H
36	36	16.25

Unit Weight: 66 lb

**Price**

1,509

(Contact customer service for solid surface pricing)

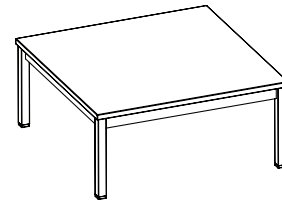

**KOT4820 - K-Series 48 x 20 Magazine Table with Thermofoil Top**

**Dimensions**

Overall		
W	D	H
48	20	16.25

Unit Weight: 52 lb

**Price**

1,279

(Contact customer service for solid surface pricing)

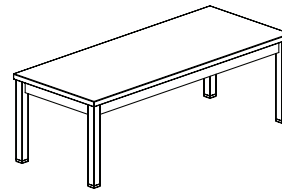

**KOT24R - K-Series 24" Round Occasional Table with Thermofoil Top**

**Dimensions**

Overall		
W	D	H
24	24	21

Unit Weight: 43 lb

**Price**

1,069

(Contact customer service for solid surface pricing)

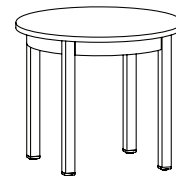

**KOT36R - K-Series 36" Round Occasional Table with Thermofoil Top**

**Dimensions**

Overall		
W	D	H
36	36	16

Unit Weight: 63 lb

**Price**

1,349

(Contact customer service for solid surface pricing)

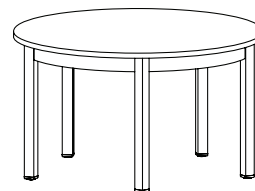

**To Order, Specify**

- Model Number
- Tabletop Finish
- Leg/skirt Finish



**General Product Information**

- Passive Flex Back
- Seat clean-out
- Wall-saver leg design
- Adjustable glides
- 16 gauge steel frame
- Arms connected by heavy steel rails
- Molded seat foam on 21" seats
- Back foam: 1.7 density foam that meets CAL 117 Fire Standards
- Comfort webbing in seats
- Field replaceable components

**To Order, Specify**

- Model Number
- Textile
- Finish
- Options

**Available Options**

<p>FRAME OPTIONS <i>See pg 2 for finishes</i>  <i>*Default 540 Pewter finish. 211 Silver Frost available at no charge.</i></p>		<p>ADDITIONAL FEATURES &amp; OPTIONS</p>	
<p>ARM CAP OPTIONS <i>See pg 2 for finishes</i></p>		CAL	CAL TB133 <i>See pg 9</i>
U	Urethane <i>Standard on specified models</i>	Z	Multi Cover <i>Use Pricing for Highest Grade</i>
J	Solid Surface <i>Standard on specified models</i>	MB	Moisture Barrier <i>See pg 11</i>

**KAM10HIP - Hip Chair**

**Dimensions**

Overall			Seat		
W	D	H	W	D	H
24.5	31	39.25	20.75	22	22.75
			Back H	Arm H	
			16	31.5	

COM: 1.7 yds  
 Wt Cap: 550 lb  
 Unit Weight: 58 lb

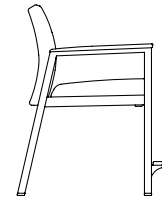
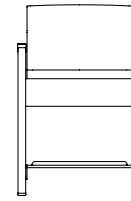

**KAM10HIPU with Urethane Arm Caps**

COM	Dillon	Carson	A <sub>5</sub>	B <sub>6</sub>	C <sub>7</sub>	D <sub>8</sub>	E <sub>9</sub>	F <sub>10</sub>	G <sub>11</sub>	H <sub>12</sub>	I <sub>13</sub>
2,129	2,139	2,179	2,229	2,269	2,329	2,379	2,439	2,509	2,599	2,679	

**KAM10HIPJ with Solid Surface Arm Caps** (Add \$50 List per arm cap for Group 2 solid surface finish)

COM	Dillon	Carson	A <sub>5</sub>	B <sub>6</sub>	C <sub>7</sub>	D <sub>8</sub>	E <sub>9</sub>	F <sub>10</sub>	G <sub>11</sub>	H <sub>12</sub>	I <sub>13</sub>
2,769	2,779	2,809	2,849	2,889	2,969	3,019	3,049	3,109	3,259	3,309	

**KOT10HIP - Hip Chair**

**Dimensions**

Overall			Seat		
W	D	H	W	D	H
24.5	29.5	39.25	20.75	19.5	24.25
			Back H	Arm H	
			15	31.75	

COM: 1.7 yds  
 Wt Cap: 550 lb  
 Unit Weight: 61.5 lb

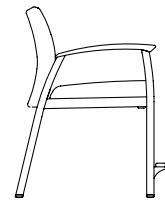
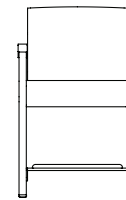

**KOT10HIPU with Urethane Arm Caps**

COM	Dillon	Carson	A <sub>5</sub>	B <sub>6</sub>	C <sub>7</sub>	D <sub>8</sub>	E <sub>9</sub>	F <sub>10</sub>	G <sub>11</sub>	H <sub>12</sub>	I <sub>13</sub>
2,129	2,139	2,179	2,229	2,269	2,329	2,379	2,439	2,509	2,599	2,679	

**KAM10BHIP - Bariatric Hip Chair**

**Dimensions**

Overall			Seat		
W	D	H	W	D	H
33.5	31	39.25	29.5	22	22.75
			Back H	Arm H	
			16	31.5	

COM: 2.7 yds  
 Wt Cap: 750 lb  
 Unit Weight: 78 lb

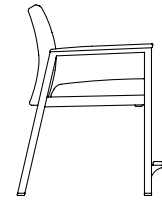
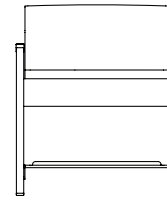

**KAM10BHIPU with Urethane Arm Caps**

COM	Dillon	Carson	A <sub>5</sub>	B <sub>6</sub>	C <sub>7</sub>	D <sub>8</sub>	E <sub>9</sub>	F <sub>10</sub>	G <sub>11</sub>	H <sub>12</sub>	I <sub>13</sub>
2,549	2,599	2,629	2,659	2,749	2,869	2,999	3,019	3,119	3,269	3,369	

**KAM10BHIPJ with Solid Surface Arm Caps** (Add \$50 List per arm cap for Group 2 solid surface finish)

COM	Dillon	Carson	A <sub>5</sub>	B <sub>6</sub>	C <sub>7</sub>	D <sub>8</sub>	E <sub>9</sub>	F <sub>10</sub>	G <sub>11</sub>	H <sub>12</sub>	I <sub>13</sub>
3,179	3,239	3,279	3,309	3,369	3,519	3,609	3,629	3,699	3,859	3,939	

**KOT10BHIP - Bariatric Hip Chair**

**Dimensions**

Overall			Seat		
W	D	H	W	D	H
33.5	29.5	39.25	29.5	19.5	24.25
			Back H	Arm H	
			15	31.75	

COM: 2.7 yds  
 Wt Cap: 750 lb  
 Unit Weight: 81.5 lb

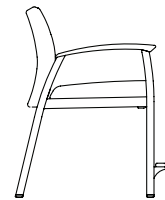
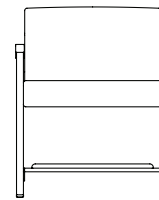

**KOT10BHIPU with Urethane Arm Caps**

COM	Dillon	Carson	A <sub>5</sub>	B <sub>6</sub>	C <sub>7</sub>	D <sub>8</sub>	E <sub>9</sub>	F <sub>10</sub>	G <sub>11</sub>	H <sub>12</sub>	I <sub>13</sub>
2,549	2,599	2,629	2,659	2,749	2,869	2,999	3,019	3,119	3,269	3,369	



**General Product Information**

- Passive Flex Back
- Seat clean-out
- Wall-saver leg design
- Adjustable glides
- 16 gauge steel frame
- Arms connected by heavy steel rails
- Seat foam: 2.8 high resilience density foam that meets CAL 117 Fire Standards
- Back foam: 1.7 density foam that meets CAL 117 Fire Standards
- Comfort webbing in seats
- Field replaceable components

**To Order, Specify**

- Model Number
- Textile
- Finish
- Options

**Available Options**

<p><b>FRAME OPTIONS</b> <span style="float: right;"><i>See pg 2 for finishes</i></span>  <i>*Default 540 Pewter finish. 211 Silver Frost available at no charge.</i></p>		<p><b>ADDITIONAL FEATURES &amp; OPTIONS</b></p>	
<p><b>ARM CAP OPTIONS</b> <span style="float: right;"><i>See pg 2 for finishes</i></span></p>		CAL	CAL TB133 <span style="float: right;"><i>See pg 9</i></span>
U	Urethane <span style="float: right;"><i>Standard on specified models</i></span>	Z	Multi Cover <span style="float: right;"><i>Use Pricing for Highest Grade</i></span>
J	Solid Surface <span style="float: right;"><i>Standard on specified models</i></span>	MB	Moisture Barrier <span style="float: right;"><i>See pg 11</i></span>

**KAL12 - Lounge Chair**

**Dimensions**

Overall			Seat		
W	D	H	W	D	H
27	30.5	34.5	24	20.5	19
			Back H	Arm H	
			16	25.5	

COM: 2 yds  
 Wt Cap: 550 lb  
 Unit Weight: 55.3 lb

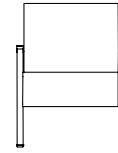

**KAL12U with Urethane Arm Caps**

COM	Dillon	Carson	A <sub>5</sub>	B <sub>6</sub>	C <sub>7</sub>	D <sub>8</sub>	E <sub>9</sub>	F <sub>10</sub>	G <sub>11</sub>	H <sub>12</sub>	I <sub>13</sub>
2,129	2,139	2,169	2,219	2,269	2,339	2,429	2,549	2,669	2,809	2,909	

**KAL12J with Solid Surface Arm Caps** (Add \$50 List per arm cap for Group 2 solid surface finish)

COM	Dillon	Carson	A <sub>5</sub>	B <sub>6</sub>	C <sub>7</sub>	D <sub>8</sub>	E <sub>9</sub>	F <sub>10</sub>	G <sub>11</sub>	H <sub>12</sub>	I <sub>13</sub>
2,559	2,569	2,599	2,639	2,689	2,769	2,849	2,949	3,069	3,229	3,379	

**KAL12B - Bariatric Lounge Chair**

**Dimensions**

Overall			Seat		
W	D	H	W	D	H
33	30.5	34.5	30	20.5	19
			Back H	Arm H	
			16	25.5	

COM: 3 yds  
 Wt Cap: 750 lb  
 Unit Weight: 62.7 lb

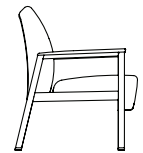
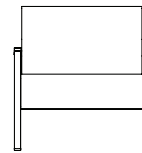

**KAL12BU with Urethane Arm Caps**

COM	Dillon	Carson	A <sub>5</sub>	B <sub>6</sub>	C <sub>7</sub>	D <sub>8</sub>	E <sub>9</sub>	F <sub>10</sub>	G <sub>11</sub>	H <sub>12</sub>	I <sub>13</sub>
2,379	2,399	2,419	2,489	2,599	2,689	2,799	2,829	3,079	3,259	3,479	

**KAL12BJ with Solid Surface Arm Caps** (Add \$50 List per arm cap for Group 2 solid surface finish)

COM	Dillon	Carson	A <sub>5</sub>	B <sub>6</sub>	C <sub>7</sub>	D <sub>8</sub>	E <sub>9</sub>	F <sub>10</sub>	G <sub>11</sub>	H <sub>12</sub>	I <sub>13</sub>
2,809	2,829	2,849	2,899	3,029	3,109	3,209	3,239	3,469	3,659	3,829	

**KAL24 - 2 Seat Lounge Chair**

**Dimensions**

Overall			Seat		
W	D	H	W	D	H
51.25	30.5	34.5	48	20.5	19
			Back H	Arm H	
			16	25.5	

COM: 3.5 yds  
 Wt Cap: 750 lb  
 Unit Weight: 87.3 lb

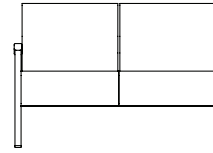

**KAL24U with Urethane Arm Caps**

COM	Dillon	Carson	A <sub>5</sub>	B <sub>6</sub>	C <sub>7</sub>	D <sub>8</sub>	E <sub>9</sub>	F <sub>10</sub>	G <sub>11</sub>	H <sub>12</sub>	I <sub>13</sub>
3,029	3,049	3,129	3,189	3,319	3,429	3,549	3,629	3,969	4,299	4,539	

**KAL24J with Solid Surface Arm Caps** (Add \$50 List per arm cap for Group 2 solid surface finish)

COM	Dillon	Carson	A <sub>5</sub>	B <sub>6</sub>	C <sub>7</sub>	D <sub>8</sub>	E <sub>9</sub>	F <sub>10</sub>	G <sub>11</sub>	H <sub>12</sub>	I <sub>13</sub>
3,459	3,469	3,559	3,619	3,739	3,859	3,959	4,049	4,369	4,489	4,619	

**KAL24I - 2 Seat Lounge Chair with Intervening Arm**

**Dimensions**

Overall			Seat		
W	D	H	W	D	H
51.25	30.5	34.5	24	20.5	19
			Back H	Arm H	
			16	25.5	

COM: 3.7 yds  
 Wt Cap: 1000 lb  
 Unit Weight: 101 lb

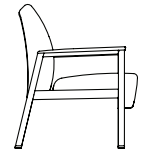
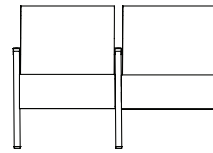

**KAL24IU with Urethane Arm Caps**

COM	Dillon	Carson	A <sub>5</sub>	B <sub>6</sub>	C <sub>7</sub>	D <sub>8</sub>	E <sub>9</sub>	F <sub>10</sub>	G <sub>11</sub>	H <sub>12</sub>	I <sub>13</sub>
3,809	3,879	3,959	4,109	4,309	4,499	4,729	4,839	4,889	4,939	5,209	

**KAL24IJ with Solid Surface Arm Caps** (Add \$50 List per arm cap for Group 2 solid surface finish)

COM	Dillon	Carson	A <sub>5</sub>	B <sub>6</sub>	C <sub>7</sub>	D <sub>8</sub>	E <sub>9</sub>	F <sub>10</sub>	G <sub>11</sub>	H <sub>12</sub>	I <sub>13</sub>
4,449	4,519	4,609	4,739	4,939	5,139	5,359	5,459	5,619	5,769	6,219	

**KAL24IBL - 2 Seat Left 30" Bariatric Lounge Chair with Intervening Arm**

**Dimensions**

Overall			Seat		
W	D	H	W	D	H
58.5	30.5	34.5	30	20.5	19
			Back H	Arm H	
			16	25.5	

COM: 4 yds  
 Wt Cap: 1000 lb  
 Unit Weight: 111 lb

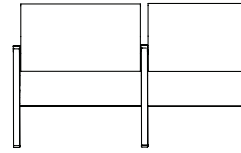

**KAL24IBLU with Urethane Arm Caps**

COM	Dillon	Carson	A <sub>5</sub>	B <sub>6</sub>	C <sub>7</sub>	D <sub>8</sub>	E <sub>9</sub>	F <sub>10</sub>	G <sub>11</sub>	H <sub>12</sub>	I <sub>13</sub>
3,749	3,779	3,869	3,919	4,089	4,219	4,369	4,459	4,729	5,019	5,339	

**KAL24IBLJ with Solid Surface Arm Caps** (Add \$50 List per arm cap for Group 2 solid surface finish)

COM	Dillon	Carson	A <sub>5</sub>	B <sub>6</sub>	C <sub>7</sub>	D <sub>8</sub>	E <sub>9</sub>	F <sub>10</sub>	G <sub>11</sub>	H <sub>12</sub>	I <sub>13</sub>
4,399	4,409	4,509	4,569	4,719	4,859	4,989	5,079	5,319	5,769	6,229	

**KAL24IBR - 2 Seat Right 30" Bariatric Lounge Chair with Intervening Arm**

**Dimensions**

Overall			Seat		
W	D	H	W	D	H
58.5	30.5	34.5	30	20.5	19
			Back H	Arm H	
			16	25.5	

COM: 4 yds  
 Wt Cap: 1000 lb  
 Unit Weight: 111 lb

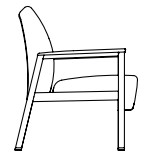
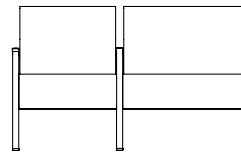

**KAL24IBRU with Urethane Arm Caps**

COM	Dillon	Carson	A <sub>5</sub>	B <sub>6</sub>	C <sub>7</sub>	D <sub>8</sub>	E <sub>9</sub>	F <sub>10</sub>	G <sub>11</sub>	H <sub>12</sub>	I <sub>13</sub>
3,749	3,779	3,869	3,919	4,089	4,219	4,369	4,459	4,729	5,019	5,339	

**KAL24IBRJ with Solid Surface Arm Caps** (Add \$50 List per arm cap for Group 2 solid surface finish)

COM	Dillon	Carson	A <sub>5</sub>	B <sub>6</sub>	C <sub>7</sub>	D <sub>8</sub>	E <sub>9</sub>	F <sub>10</sub>	G <sub>11</sub>	H <sub>12</sub>	I <sub>13</sub>
4,399	4,409	4,509	4,569	4,719	4,859	4,989	5,079	5,319	5,769	6,229	

**KAL36I - 3 Seat Lounge Chair with Intervening Arms**

**Dimensions**

Overall			Seat		
W	D	H	W	D	H
78.25	30.5	34.5	24	20.5	19
			Back H	Arm H	
			16	25.5	

COM: 5.3 yds  
 Wt Cap: 1000 lb  
 Unit Weight: 143 lb

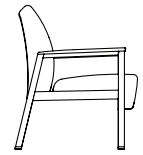
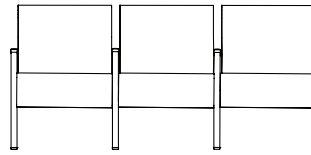

**KAL36IU with Urethane Arm Caps**

COM	Dillon	Carson	A <sub>5</sub>	B <sub>6</sub>	C <sub>7</sub>	D <sub>8</sub>	E <sub>9</sub>	F <sub>10</sub>	G <sub>11</sub>	H <sub>12</sub>	I <sub>13</sub>
5,099	5,159	5,229	5,379	5,599	5,829	6,009	6,179	6,309	6,449	6,759	

**KAL36IJ with Solid Surface Arm Caps** (Add \$50 List per arm cap for Group 2 solid surface finish)

COM	Dillon	Carson	A <sub>5</sub>	B <sub>6</sub>	C <sub>7</sub>	D <sub>8</sub>	E <sub>9</sub>	F <sub>10</sub>	G <sub>11</sub>	H <sub>12</sub>	I <sub>13</sub>
5,959	6,019	6,079	6,229	6,439	6,669	6,839	6,999	7,089	7,179	7,459	

**KAL36IBC - 3 Seat Center 30" Bariatric Lounge Chair with Intervening Arms**

**Dimensions**

Overall			Seat		
W	D	H	W	D	H
84.25	30.5	34.5	30	20.5	19
			Back H	Arm H	
			16	25.5	

COM: 5.6 yds  
 Wt Cap: 1000 lb  
 Unit Weight: 153.2 lb

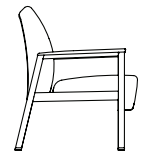
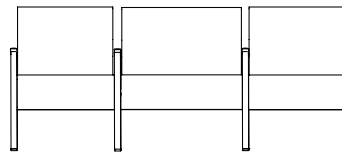

**KAL36BCU with Urethane Arm Caps**

COM	Dillon	Carson	A <sub>5</sub>	B <sub>6</sub>	C <sub>7</sub>	D <sub>8</sub>	E <sub>9</sub>	F <sub>10</sub>	G <sub>11</sub>	H <sub>12</sub>	I <sub>13</sub>
4,929	4,979	5,099	5,189	5,409	5,619	5,839	5,989	6,079	6,619	7,019	

**KAL36BCJ with Solid Surface Arm Caps** (Add \$50 List per arm cap for Group 2 solid surface finish)

COM	Dillon	Carson	A <sub>5</sub>	B <sub>6</sub>	C <sub>7</sub>	D <sub>8</sub>	E <sub>9</sub>	F <sub>10</sub>	G <sub>11</sub>	H <sub>12</sub>	I <sub>13</sub>
5,789	5,829	5,959	6,029	6,259	6,459	6,679	6,809	6,869	7,309	7,759	

**KAL36IBL - 3 Seat Left 30" Bariatric Lounge Chair with Intervening Arms**

**Dimensions**

Overall			Seat		
W	D	H	W	D	H
84.25	30.5	34.5	30	20.5	19
			Back H	Arm H	
			16	25.5	

COM: 5.6 yds  
 Wt Cap: 1000 lb  
 Unit Weight: 153.2 lb

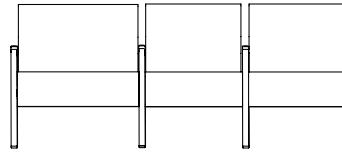

**KAL36IBLU with Urethane Arm Caps**

COM	Dillon	Carson	A <sub>5</sub>	B <sub>6</sub>	C <sub>7</sub>	D <sub>8</sub>	E <sub>9</sub>	F <sub>10</sub>	G <sub>11</sub>	H <sub>12</sub>	I <sub>13</sub>
4,929	4,979	5,099	5,189	5,409	5,619	5,839	5,989	6,079	6,619	6,619	7,019

**KAL36IBLJ with Solid Surface Arm Caps** (Add \$50 List per arm cap for Group 2 solid surface finish)

COM	Dillon	Carson	A <sub>5</sub>	B <sub>6</sub>	C <sub>7</sub>	D <sub>8</sub>	E <sub>9</sub>	F <sub>10</sub>	G <sub>11</sub>	H <sub>12</sub>	I <sub>13</sub>
5,789	5,829	5,959	6,029	6,259	6,459	6,679	6,809	6,869	6,869	7,309	7,759

**KAL36IBR - 3 Seat Right 30" Bariatric Lounge Chair with Intervening Arms**

**Dimensions**

Overall			Seat		
W	D	H	W	D	H
84.25	30.5	34.5	30	20.5	19
			Back H	Arm H	
			16	25.5	

COM: 5.6 yds  
 Wt Cap: 1000 lb  
 Unit Weight: 153.2 lb

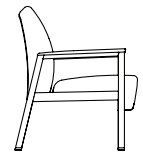
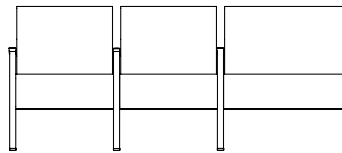

**KAL36IBRU with Urethane Arm Caps**

COM	Dillon	Carson	A <sub>5</sub>	B <sub>6</sub>	C <sub>7</sub>	D <sub>8</sub>	E <sub>9</sub>	F <sub>10</sub>	G <sub>11</sub>	H <sub>12</sub>	I <sub>13</sub>
4,929	4,979	5,099	5,189	5,409	5,619	5,839	5,989	6,079	6,619	6,619	7,019

**KAL36IBRJ with Solid Surface Arm Caps** (Add \$50 List per arm cap for Group 2 solid surface finish)

COM	Dillon	Carson	A <sub>5</sub>	B <sub>6</sub>	C <sub>7</sub>	D <sub>8</sub>	E <sub>9</sub>	F <sub>10</sub>	G <sub>11</sub>	H <sub>12</sub>	I <sub>13</sub>
5,789	5,829	5,959	6,029	6,259	6,459	6,679	6,809	6,869	6,869	7,309	7,759



**General Product Information**

- Passive Flex Back
- Seat clean-out
- Wall-saver leg design
- Adjustable glides
- 16 gauge steel frame
- Arms connected by heavy steel rails
- Seat foam: 2.8 high resilience density foam that meets CAL 117 Fire Standards
- Back foam: 1.7 density foam that meets CAL 117 Fire Standards
- Comfort webbing in seats
- Field replaceable components

**To Order, Specify**

- Model Number
- Textile
- Finish
- Options

**Available Options**

<p><b>FRAME OPTIONS</b> <i>See pg 2 for finishes</i>  <i>*Default 540 Pewter finish. 211 Silver Frost available at no charge.</i></p> <p><b>ARM CAP OPTIONS</b> <i>See pg 2 for finishes</i></p> <p>U Urethane <span style="float: right;">Standard</span></p>	<p><b>ADDITIONAL FEATURES &amp; OPTIONS</b></p> <table border="0"> <tr> <td>CAL</td> <td>CAL TB133</td> <td style="text-align: right;">See pg 9</td> </tr> <tr> <td>Z</td> <td>Multi Cover</td> <td style="text-align: right;">Use Pricing for Highest Grade</td> </tr> <tr> <td>MB</td> <td>Moisture Barrier</td> <td style="text-align: right;">See pg 11</td> </tr> </table>	CAL	CAL TB133	See pg 9	Z	Multi Cover	Use Pricing for Highest Grade	MB	Moisture Barrier	See pg 11
CAL	CAL TB133	See pg 9								
Z	Multi Cover	Use Pricing for Highest Grade								
MB	Moisture Barrier	See pg 11								

**KOL12 - Lounge Chair**

**Dimensions**

Overall			Seat		
W	D	H	W	D	H
27	30	35	24	20.5	18
			Back H	Arm H	
			16	25.5	

**COM:** 2 yds  
**Wt Cap:** 550 lb  
**Unit Weight:** 56.3 lb

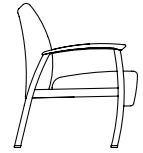
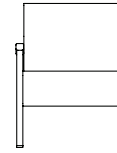

**KOL12U with Urethane Arm Caps**

COM	Dillon/Carson	A <sub>5</sub>	B <sub>6</sub>	C <sub>7</sub>	D <sub>8</sub>	E <sub>9</sub>	F <sub>10</sub>	G <sub>11</sub>	H <sub>12</sub>	I <sub>13</sub>
2,129	2,139	2,169	2,219	2,269	2,339	2,429	2,549	2,669	2,859	3,019

**KOL12B - Bariatric Lounge Chair**

**Dimensions**

Overall			Seat		
W	D	H	W	D	H
33	30	35	30	20.5	19
			Back H	Arm H	
			16	25.5	

**COM:** 3 yds  
**Wt Cap:** 750 lb  
**Unit Weight:** 63.5 lb

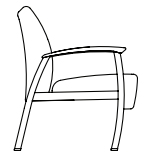
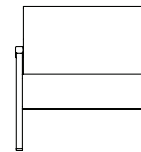

**KOL12BU with Urethane Arm Caps**

COM	Dillon/Carson	A <sub>5</sub>	B <sub>6</sub>	C <sub>7</sub>	D <sub>8</sub>	E <sub>9</sub>	F <sub>10</sub>	G <sub>11</sub>	H <sub>12</sub>	I <sub>13</sub>
2,379	2,399	2,419	2,489	2,599	2,689	2,799	2,829	3,079	3,279	3,479

**KOL24 - 2 Seat Lounge Chair**

**Dimensions**

Overall			Seat		
W	D	H	W	D	H
51.25	30	35	48	20.5	19
			Back H	Arm H	
			16	25.5	

**COM:** 3.5 yds  
**Wt Cap:** 750 lb  
**Unit Weight:** 89 lb

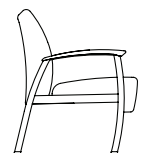
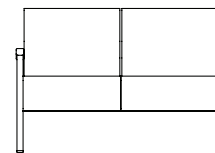

**KOL24U with Urethane Arm Caps**

COM	Dillon/Carson	A <sub>5</sub>	B <sub>6</sub>	C <sub>7</sub>	D <sub>8</sub>	E <sub>9</sub>	F <sub>10</sub>	G <sub>11</sub>	H <sub>12</sub>	I <sub>13</sub>
3,029	3,049	3,129	3,189	3,319	3,429	3,549	3,629	3,969	4,259	4,539

**KOL24I - 2 Seat Lounge Chair with Intervening Arm**

**Dimensions**

Overall			Seat		
W	D	H	W	D	H
51.25	30	35	24	20.5	19
		<b>Back H</b>			<b>Arm H</b>
		16			25.5

**COM:** 3.7 yds  
**Wt Cap:** 1000 lb  
**Unit Weight:** 101 lb

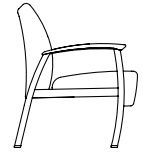
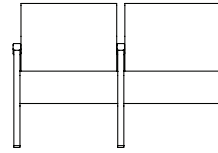

**KOL24IU with Urethane Arm Caps**

COM	Dillon/Carson	A <sub>5</sub>	B <sub>6</sub>	C <sub>7</sub>	D <sub>8</sub>	E <sub>9</sub>	F <sub>10</sub>	G <sub>11</sub>	H <sub>12</sub>	I <sub>13</sub>
3,809	3,879	3,959	4,109	4,309	4,499	4,729	4,839	4,919	4,989	5,249

**KOL24IBL - 2 Seat Left 30" Bariatric Lounge Chair with Intervening Arm**

**Dimensions**

Overall			Seat		
W	D	H	W	D	H
58.5	30	35	30	20.5	19
		<b>Back H</b>			<b>Arm H</b>
		16			25.5

**COM:** 4 yds  
**Wt Cap:** 1000 lb  
**Unit Weight:** 110.5 lb

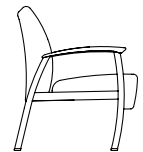
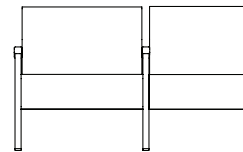

**KOL24IBLU with Urethane Arm Caps**

COM	Dillon/Carson	A <sub>5</sub>	B <sub>6</sub>	C <sub>7</sub>	D <sub>8</sub>	E <sub>9</sub>	F <sub>10</sub>	G <sub>11</sub>	H <sub>12</sub>	I <sub>13</sub>
3,749	3,779	3,869	3,919	4,089	4,219	4,369	4,459	4,729	5,059	5,459

**KOL24IBR - 2 Seat Right 30" Bariatric Lounge Chair with Intervening Arm**

**Dimensions**

Overall			Seat		
W	D	H	W	D	H
58.5	30	35	30	20.5	19
		<b>Back H</b>			<b>Arm H</b>
		16			25.5

**COM:** 4 yds  
**Wt Cap:** 1000 lb  
**Unit Weight:** 110.5 lb

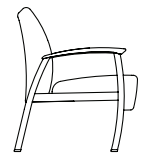
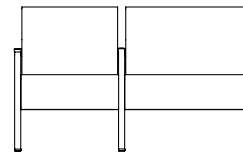

**KOL24IBRU with Urethane Arm Caps**

COM	Dillon/Carson	A <sub>5</sub>	B <sub>6</sub>	C <sub>7</sub>	D <sub>8</sub>	E <sub>9</sub>	F <sub>10</sub>	G <sub>11</sub>	H <sub>12</sub>	I <sub>13</sub>
3,749	3,779	3,869	3,919	4,089	4,219	4,369	4,459	4,729	5,059	5,459

**KOL36I - 3 Seat Lounge Chair with Intervening Arms**

**Dimensions**

Overall			Seat		
W	D	H	W	D	H
78.25	30	35	24	20.5	19
		<b>Back H</b>			<b>Arm H</b>
		16			25.5

**COM:** 5.3 yds  
**Wt Cap:** 1000 lb  
**Unit Weight:** 143 lb

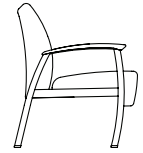
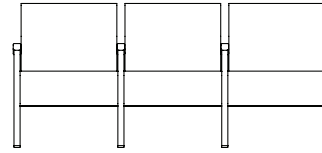

**KOL36IU with Urethane Arm Caps**

COM	Dillon/Carson	A <sub>5</sub>	B <sub>6</sub>	C <sub>7</sub>	D <sub>8</sub>	E <sub>9</sub>	F <sub>10</sub>	G <sub>11</sub>	H <sub>12</sub>	I <sub>13</sub>
5,099	5,159	5,229	5,379	5,599	5,829	6,009	6,179	6,339	6,499	6,879

**KOL36IBC - 3 Seat Center 30" Bariatric Lounge Chair with Intervening Arms**

**Dimensions**

Overall			Seat		
W	D	H	W	D	H
84.25	30	35	30	20.5	19
		<b>Back H</b>			<b>Arm H</b>
		16			25.5

**COM:** 5.6 yds  
**Wt Cap:** 1000 lb  
**Unit Weight:** 153 lb

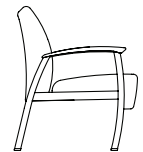
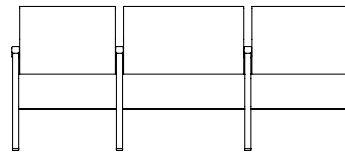

**KOL36IBCU with Urethane Arm Caps**

COM	Dillon/Carson	A <sub>5</sub>	B <sub>6</sub>	C <sub>7</sub>	D <sub>8</sub>	E <sub>9</sub>	F <sub>10</sub>	G <sub>11</sub>	H <sub>12</sub>	I <sub>13</sub>
4,929	4,979	5,099	5,189	5,409	5,619	5,839	5,989	6,079	6,619	7,019

**KOL36IBL - 3 Seat Left 30" Bariatric Lounge Chair with Intervening Arms**

**Dimensions**

Overall			Seat		
W	D	H	W	D	H
84.25	30	35	30	20.5	19
		<b>Back H</b>			<b>Arm H</b>
		16			25.5

**COM:** 5.6 yds  
**Wt Cap:** 1000 lb  
**Unit Weight:** 153 lb

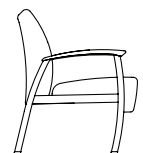
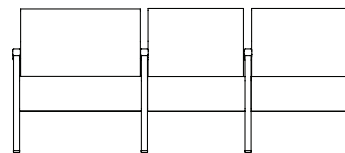

**KOL36IBLU with Urethane Arm Caps**

COM	Dillon/Carson	A <sub>5</sub>	B <sub>6</sub>	C <sub>7</sub>	D <sub>8</sub>	E <sub>9</sub>	F <sub>10</sub>	G <sub>11</sub>	H <sub>12</sub>	I <sub>13</sub>
4,929	4,979	5,099	5,189	5,409	5,619	5,839	5,989	6,079	6,619	7,019

**KOL36IBR - 3 Seat Right 30" Bariatric Lounge Chair with Intervening Arms**

**Dimensions**

Overall			Seat		
W	D	H	W	D	H
84.25	30	35	30	20.5	19
			Back H	Arm H	
			16	25.5	

COM: 5.6 yds  
 Wt Cap: 1000 lb  
 Unit Weight: 153 lb

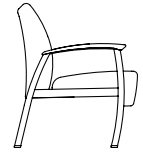
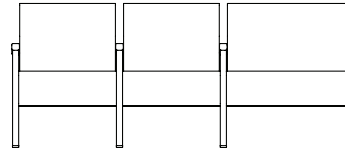

**KOL36IBRU with Urethane Arm Caps**

COM	Dillon/Carson	A <sub>5</sub>	B <sub>6</sub>	C <sub>7</sub>	D <sub>8</sub>	E <sub>9</sub>	F <sub>10</sub>	G <sub>11</sub>	H <sub>12</sub>	I <sub>13</sub>
4,929	4,979	5,099	5,189	5,409	5,619	5,839	5,989	6,079	6,619	7,019



**General Product Information**

- Standard with fully upholstered arms & metal feet
- Passive Flex Back
- Seat clean-out
- Wall-saver leg design
- All interior joints are CNC cut/puzzle-jointed, corner blocked, screwed, & glued together
- Commercial grade double-walled plywood interior frame
- Arms connected by 14 gauge steel support tubes
- Seat foam: 2.8 high resilience density foam that meets CAL 117 Fire Standards
- Back foam: 1.7 density foam that meets CAL 117 Fire Standards
- Comfort webbing in seats and sinuous springs in backs
- Field replaceable components

**To Order, Specify**

- Model Number
- Textile
- Finish
- Options

**Available Options**

<b>ARM CAP OPTIONS</b>		<i>See pg 2 for finishes</i>		
		<b>2 Arms</b>	<b>3 Arms</b>	<b>4 Arms</b>
U	Urethane	210	315	420
J1	Solid Surface - Group 1	618	927	1236
J2	Solid Surface - Group 2	818	1227	1636
F	Fully Upholstered Arms	Standard		

<b>FEET OPTIONS</b>		<i>See pg 2 for finishes</i>
MF	Metal Feet with Adjustable Glides	Standard

*\*Default S40 Pewter finish. 211 Silver Frost available at no charge.*

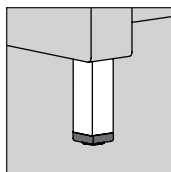

<b>POWER OPTIONS</b>		
PU8	Power <sup>1</sup> (USB-A/USB-C/Grounded Receptacle)	209

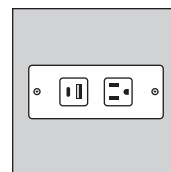

<b>ADDITIONAL FEATURES &amp; OPTIONS</b>		
CAL	CAL TB133	See pg 9
Z	Multi Cover	Use Pricing for Highest Grade
MB	Moisture Barrier	See pg 11

<sup>1</sup>Installed on outside of left (facing) arm

**KMU10 - Lounge Chair**

**Dimensions**

Overall			Seat		
W	D	H	W	D	H
28.25	29	32.75	22	20	18.25
			Back H	Arm H	
			15	25.25	

COM: 3.8 yds  
 Wt Cap: 550 lb  
 Unit Weight: 77 lb

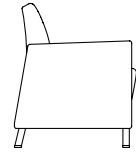
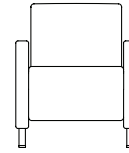

**KMU10 Standard with Fully Upholstered Arms** (Refer to pg 57 for arm cap options)

COM	Dillon/Carson	A <sub>5</sub>	B <sub>6</sub>	C <sub>7</sub>	D <sub>8</sub>	E <sub>9</sub>	F <sub>10</sub>	G <sub>11</sub>	H <sub>12</sub>	I <sub>13</sub>
2,229	2,259	2,359	2,489	2,599	2,739	2,869	3,009	3,259	3,449	3,619

**KMU10B - Bariatric Lounge Chair**

**Dimensions**

Overall			Seat		
W	D	H	W	D	H
34.75	29	32.75	29.5	20	18.25
			Back H	Arm H	
			15	25.25	

COM: 5.5 yds  
 Wt Cap: 750 lb  
 Unit Weight: 101 lb

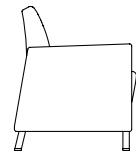
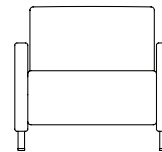

**KMU10B Standard with Fully Upholstered Arms** (Refer to pg 57 for arm cap options)

COM	Dillon/Carson	A <sub>5</sub>	B <sub>6</sub>	C <sub>7</sub>	D <sub>8</sub>	E <sub>9</sub>	F <sub>10</sub>	G <sub>11</sub>	H <sub>12</sub>	I <sub>13</sub>
2,619	2,649	2,779	2,829	2,979	3,049	3,169	3,339	3,679	4,009	4,299

**KMU20 - Lounge Loveseat**

**Dimensions**

Overall			Seat		
W	D	H	W	D	H
50.25	29	32.75	44	20	18.25
			Back H	Arm H	
			15	25.25	

COM: 5.5 yds  
 Wt Cap: 750 lb  
 Unit Weight: 121 lb

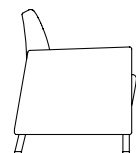
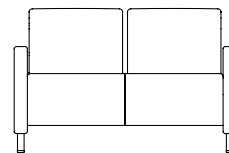

**KMU20 Standard with Fully Upholstered Arms** (Refer to pg 57 for arm cap options)

COM	Dillon/Carson	A <sub>5</sub>	B <sub>6</sub>	C <sub>7</sub>	D <sub>8</sub>	E <sub>9</sub>	F <sub>10</sub>	G <sub>11</sub>	H <sub>12</sub>	I <sub>13</sub>
3,189	3,239	3,399	3,559	3,749	3,929	4,129	4,349	4,719	4,929	5,059

**KMU20I - 2 Seat Lounge Chair with Intervening Arm**

**Dimensions**

Overall			Seat		
W	D	H	W	D	H
52	29	32.75	22	20	18.25
			Back H	Arm H	
			15	25.25	

COM: 6.5 yds  
 Wt Cap: 1000 lb  
 Unit Weight: 141 lb

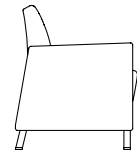
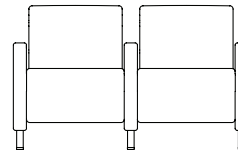

**KMU20I Standard with Fully Upholstered Arms** (Refer to pg 57 for arm cap options)

COM	Dillon/Carson	A <sub>5</sub>	B <sub>6</sub>	C <sub>7</sub>	D <sub>8</sub>	E <sub>9</sub>	F <sub>10</sub>	G <sub>11</sub>	H <sub>12</sub>	I <sub>13</sub>
3,879	3,949	4,139	4,309	4,569	4,729	4,949	5,219	5,579	5,799	6,019

**KMU20T - 2 Seat Lounge Chair with Intervening Table**

**Dimensions**

Overall			Seat		
W	D	H	W	D	H
72	29	32.75	22	20	18.25
			Back H	Arm H	
			15	25.25	

COM: 6.1 yds  
 Wt Cap: 750 lb  
 Unit Weight: 155 lb

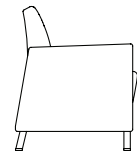
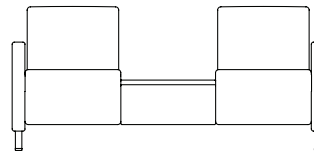

**KMU20T Standard with Fully Upholstered Arms** (Refer to pg 57 for arm cap options)

COM	Dillon/Carson	A <sub>5</sub>	B <sub>6</sub>	C <sub>7</sub>	D <sub>8</sub>	E <sub>9</sub>	F <sub>10</sub>	G <sub>11</sub>	H <sub>12</sub>	I <sub>13</sub>
4,389	4,439	4,679	4,829	5,099	5,279	5,509	5,809	5,889	6,419	6,769

(Tables standard with thermofoil top. Contact customer service for solid surface pricing)

**KMU20IT - 2 Seat Lounge Chair with Intervening Table & Intervening Arms**

**Dimensions**

Overall			Seat		
W	D	H	W	D	H
77.5	29	32.75	22	20	20
			Back H	Arm H	
			15	25.25	

COM: 7.8 yds  
 Wt Cap: 1000 lb  
 Unit Weight: 182 lb

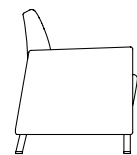
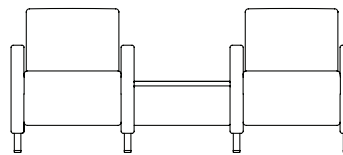

**KMU20IT Standard with Fully Upholstered Arms** (Refer to pg 57 for arm cap options)

COM	Dillon/Carson	A <sub>5</sub>	B <sub>6</sub>	C <sub>7</sub>	D <sub>8</sub>	E <sub>9</sub>	F <sub>10</sub>	G <sub>11</sub>	H <sub>12</sub>	I <sub>13</sub>
4,969	5,029	5,309	5,489	5,799	6,019	6,279	6,599	6,769	7,379	7,819

(Tables standard with thermofoil top. Contact customer service for solid surface pricing)

**KMU20IBL - 2 Seat Left 29.5" Bariatric Lounge Chair with Intervening Arm**

**Dimensions**

Overall			Seat		
W	D	H	W	D	H
59.5	29	32.75	22	20	18.25
			Back H	Arm H	
			15	25.25	

COM: 7.1 yds  
 Wt Cap: 1000 lb  
 Unit Weight: 151 lb

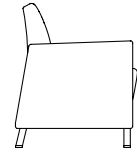
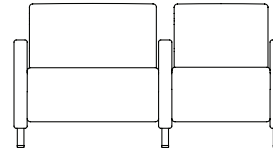

**KMU20IBL Standard with Fully Upholstered Arms** (Refer to pg 57 for arm cap options)

COM	Dillon/Carson	A <sub>5</sub>	B <sub>6</sub>	C <sub>7</sub>	D <sub>8</sub>	E <sub>9</sub>	F <sub>10</sub>	G <sub>11</sub>	H <sub>12</sub>	I <sub>13</sub>
4,309	4,339	4,559	4,709	4,929	5,129	5,309	5,529	5,889	6,409	6,749

**KMU20IBR - 2 Seat Right 29.5" Bariatric Lounge Chair with Intervening Arm**

**Dimensions**

Overall			Seat		
W	D	H	W	D	H
59.5	29	32.75	29.5	20	18.25
			Back H	Arm H	
			15	25.25	

COM: 7.1 yds  
 Wt Cap: 1000 lb  
 Unit Weight: 151 lb

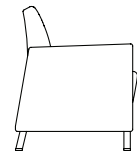
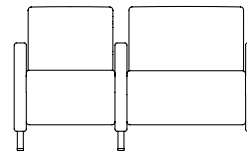

**KMU20IBR Standard with Fully Upholstered Arms** (Refer to pg 57 for arm cap options)

COM	Dillon/Carson	A <sub>5</sub>	B <sub>6</sub>	C <sub>7</sub>	D <sub>8</sub>	E <sub>9</sub>	F <sub>10</sub>	G <sub>11</sub>	H <sub>12</sub>	I <sub>13</sub>
4,309	4,339	4,559	4,709	4,929	5,129	5,309	5,529	5,889	6,409	6,749

**KMU30 - Lounge Sofa**

**Dimensions**

Overall			Seat		
W	D	H	W	D	H
71.5	29	32.75	66.5	20	18.25
			Back H	Arm H	
			15	25.25	

COM: 7 yds  
 Wt Cap: 750 lb  
 Unit Weight: 154 lb

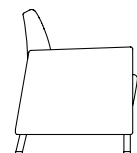
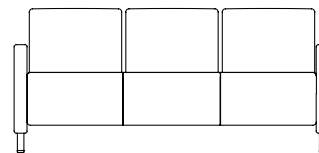

**KMU30 Standard with Fully Upholstered Arms** (Refer to pg 57 for arm cap options)

COM	Dillon/Carson	A <sub>5</sub>	B <sub>6</sub>	C <sub>7</sub>	D <sub>8</sub>	E <sub>9</sub>	F <sub>10</sub>	G <sub>11</sub>	H <sub>12</sub>	I <sub>13</sub>
4,159	4,259	4,509	4,669	4,959	5,169	5,429	5,749	6,199	6,519	6,749

**KMU30I - 3 Seat Lounge Chair with Intervening Arms**

**Dimensions**

Overall			Seat		
W	D	H	W	D	H
76.5	29	32.75	22	20	18.25
			Back H	Arm H	
			15	25.25	

COM: 9.1 yds  
 Wt Cap: 1000 lb  
 Unit Weight: 197 lb

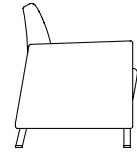
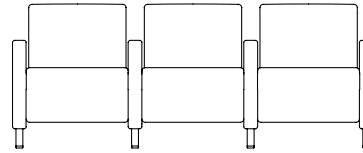

**KMU30I Standard with Fully Upholstered Arms** (Refer to pg 57 for arm cap options)

COM	Dillon/Carson	A <sub>5</sub>	B <sub>6</sub>	C <sub>7</sub>	D <sub>8</sub>	E <sub>9</sub>	F <sub>10</sub>	G <sub>11</sub>	H <sub>12</sub>	I <sub>13</sub>
5,489	5,599	5,919	6,129	6,489	6,749	7,099	7,489	7,649	8,119	8,419

**KMU30IBC - 3 Seat Center 29.5" Bariatric Lounge Chair with Intervening Arms**

**Dimensions**

Overall			Seat		
W	D	H	W	D	H
84.25	29	32.75	29.5	20	18.25
			Back H	Arm H	
			15	25.25	

COM: 9.6 yds  
 Wt Cap: 1000 lb  
 Unit Weight: 206 lb

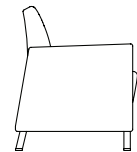
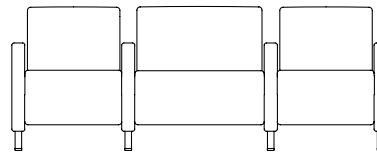

**KMU30IBC Standard with Fully Upholstered Arms** (Refer to pg 57 for arm cap options)

COM	Dillon/Carson	A <sub>5</sub>	B <sub>6</sub>	C <sub>7</sub>	D <sub>8</sub>	E <sub>9</sub>	F <sub>10</sub>	G <sub>11</sub>	H <sub>12</sub>	I <sub>13</sub>
6,099	6,149	6,469	6,649	6,919	7,159	7,429	7,809	7,969	8,609	9,059

**KMU30IBL - 3 Seat Left 29.5" Bariatric Lounge Chair with Intervening Arms**

**Dimensions**

Overall			Seat		
W	D	H	W	D	H
84.25	29	32.75	29.5	20	18.25
			Back H	Arm H	
			15	25.25	

COM: 9.6 yds  
 Wt Cap: 1000 lb  
 Unit Weight: 206 lb

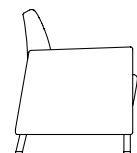
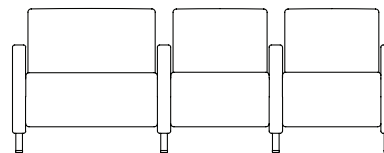

**KMU30IBL Standard with Fully Upholstered Arms** (Refer to pg 57 for arm cap options)

COM	Dillon/Carson	A <sub>5</sub>	B <sub>6</sub>	C <sub>7</sub>	D <sub>8</sub>	E <sub>9</sub>	F <sub>10</sub>	G <sub>11</sub>	H <sub>12</sub>	I <sub>13</sub>
6,099	6,149	6,469	6,649	6,919	7,159	7,429	7,809	7,969	8,609	9,059

**KMU30IBR - 3 Seat Right 29.5" Bariatric Lounge Chair with Intervening Arms**

**Dimensions**

Overall			Seat		
W	D	H	W	D	H
84.25	29	32.75	29.5	20	18.25
			Back H	Arm H	
			15	25.5	

COM: 9.6 yds  
 Wt Cap: 1000 lb  
 Unit Weight: 206 lb

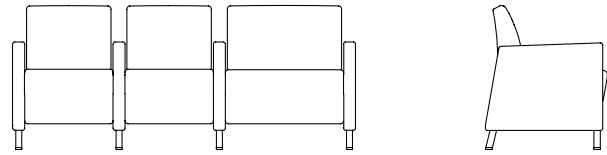

**KMU30IBR Standard with Fully Upholstered Arms** (Refer to pg 57 for arm cap options)

COM	Dillon/Carson	A <sub>5</sub>	B <sub>6</sub>	C <sub>7</sub>	D <sub>8</sub>	E <sub>9</sub>	F <sub>10</sub>	G <sub>11</sub>	H <sub>12</sub>	I <sub>13</sub>
6,099	6,149	6,469	6,649	6,919	7,159	7,429	7,809	7,969	8,609	9,059



**General Product Information**

- Standard with fully upholstered arms & metal feet
- Passive Flex Back
- Seat clean-out
- Wall-saver leg design
- All interior joints are CNC cut/puzzle-jointed, corner blocked, screwed, & glued together
- Arms connected by 14 gauge steel support tubes
- Seat foam: 2.8 high resilience density foam that meets CAL 117 Fire Standards
- Back foam: 1.7 density foam that meets CAL 117 Fire Standards
- Comfort webbing in seats
- Field replaceable components

**To Order, Specify**

- Model Number
- Textile
- Finish
- Options

**Available Options**

**ARM CAP OPTIONS** *See pg 2 for finishes*

U	Urethane	210
J1	Solid Surface - Group 1	618
J2	Solid Surface - Group 2	818
F	Fully Upholstered Arms	Standard

**FEET OPTIONS** *See pg 2 for finishes*

MF	Metal Feet with Front Adjustable Glides	Standard
----	---	----------

*\*Default 540 Pewter finish. 211 Silver Frost available at no charge.*

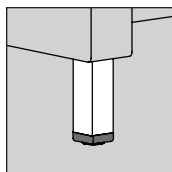

**ADDITIONAL FEATURES & OPTIONS**

CAL	CAL TB133	See pg 9
Z	Multi Cover	Use Pricing for Highest Grade
MB	Moisture Barrier	See pg 11

**KZU10 - Lounge Chair**

**Dimensions**

Overall			Seat			COM: 2.9 yds Wt Cap: 550 lb Unit Weight: 59 lb
W	D	H	W	D	H	
24	27.25	33.25	20.5	20	18	
		Back H			Arm H	
		15			25.5	

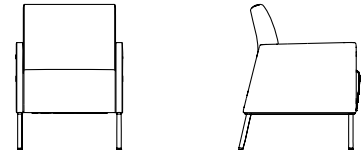

**KZU10 Standard with Fully Upholstered Arms** (Refer to pg 63 for arm cap options)

COM	Dillon/Carson	A <sub>5</sub>	B <sub>6</sub>	C <sub>7</sub>	D <sub>8</sub>	E <sub>9</sub>	F <sub>10</sub>	G <sub>11</sub>	H <sub>12</sub>	I <sub>13</sub>
2,289	2,399	2,469	2,549	2,629	2,739	2,829	2,969	3,189	3,399	3,599

**KZU10H - High Back Lounge Chair**

**Dimensions**

Overall			Seat			COM: 3.3 yds Wt Cap: 550 lb Unit Weight: 65 lb
W	D	H	W	D	H	
24	27.25	45	20.5	20	18	
		Back H			Arm H	
		26.75			25.5	

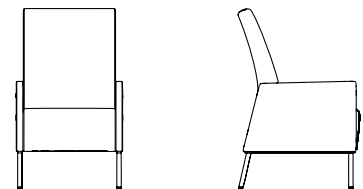

**KZU10H Standard with Fully Upholstered Arms** (Refer to pg 63 for arm cap options)

COM	Dillon/Carson	A <sub>5</sub>	B <sub>6</sub>	C <sub>7</sub>	D <sub>8</sub>	E <sub>9</sub>	F <sub>10</sub>	G <sub>11</sub>	H <sub>12</sub>	I <sub>13</sub>
2,399	2,549	2,619	2,699	2,799	2,919	3,029	3,199	3,419	3,679	3,899

**KZU12 - Lounge Chair - 24" Seat**

**Dimensions**

Overall			Seat			COM: 3.1 yds Wt Cap: 550 lb Unit Weight: 65 lb
W	D	H	W	D	H	
27.5	27.25	33.25	24	20	18	
		Back H			Arm H	
		15			25.5	

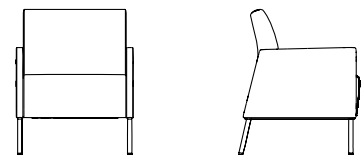

**KZU12 Standard with Fully Upholstered Arms** (Refer to pg 63 for arm cap options)

COM	Dillon/Carson	A <sub>5</sub>	B <sub>6</sub>	C <sub>7</sub>	D <sub>8</sub>	E <sub>9</sub>	F <sub>10</sub>	G <sub>11</sub>	H <sub>12</sub>	I <sub>13</sub>
2,369	2,499	2,579	2,659	2,739	2,839	2,949	3,099	3,319	3,529	3,749

**KZU10B - Bariatric Lounge Chair**

**Dimensions**

Overall			Seat		
W	D	H	W	D	H
33.25	27.25	33.25	29.5	20	18
			Back H	Arm H	
			15	25.5	

COM: 3.9 yds  
 Wt Cap: 750 lb  
 Unit Weight: 73 lb

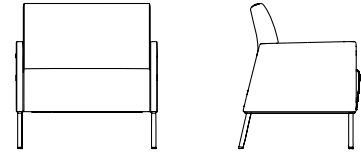

**KZU10B Standard with Fully Upholstered Arms** (Refer to pg 63 for arm cap options)

COM	Dillon/Carson	A <sub>5</sub>	B <sub>6</sub>	C <sub>7</sub>	D <sub>8</sub>	E <sub>9</sub>	F <sub>10</sub>	G <sub>11</sub>	H <sub>12</sub>	I <sub>13</sub>
2,529	2,659	2,759	2,859	2,969	3,099	3,239	3,419	3,679	3,969	4,269

**KZU10BH - High Back Bariatric Lounge Chair**

**Dimensions**

Overall			Seat		
W	D	H	W	D	H
33.25	27.25	45	29.5	20	18
			Back H	Arm H	
			26.75	25.5	

COM: 4.6 yds  
 Wt Cap: 750 lb  
 Unit Weight: 89 lb

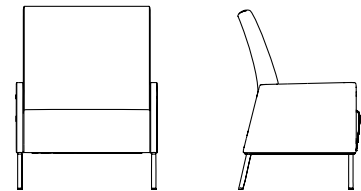

**KZU10BH Standard with Fully Upholstered Arms** (Refer to pg 63 for arm cap options)

COM	Dillon/Carson	A <sub>5</sub>	B <sub>6</sub>	C <sub>7</sub>	D <sub>8</sub>	E <sub>9</sub>	F <sub>10</sub>	G <sub>11</sub>	H <sub>12</sub>	I <sub>13</sub>
2,659	2,819	2,949	3,049	3,179	3,339	3,529	3,739	4,059	4,399	4,699

**KZU20 - 2 Seat Lounge Chair**

**Dimensions**

Overall			Seat		
W	D	H	W	D	H
45	27.25	33.25	41.75	20	18
			Back H	Arm H	
			15	25.5	

COM: 4.3 yds  
 Wt Cap: 750 lb  
 Unit Weight: 86 lb

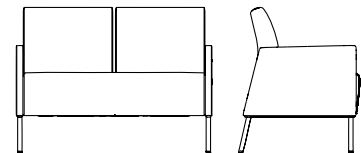

**KZU20 Standard with Fully Upholstered Arms** (Refer to pg 63 for arm cap options)

COM	Dillon/Carson	A <sub>5</sub>	B <sub>6</sub>	C <sub>7</sub>	D <sub>8</sub>	E <sub>9</sub>	F <sub>10</sub>	G <sub>11</sub>	H <sub>12</sub>	I <sub>13</sub>
2,899	3,079	3,159	3,289	3,399	3,549	3,699	3,919	4,199	4,529	4,869



**General Product Information**

- Standard with fully upholstered arms & metal feet
- Passive Flex Back
- Seat clean-out
- Wall-saver leg design
- All interior joints are CNC cut/puzzle-jointed, corner blocked, screwed, & glued together
- Commercial grade double-walled plywood interior frame
- Arms connected by 14 gauge steel support tubes
- Seat foam: 2.8 high resilience density foam that meets CAL 117 Fire Standards
- Back foam: 1.7 density foam that meets CAL 117 Fire Standards
- Comfort webbing in seats and sinuous springs in backs
- Field replaceable components

**To Order, Specify**

- Model Number
- Textile
- Finish
- Options

**Available Options**

<b>ARM CAP OPTIONS</b>		<i>See pg 2 for finishes</i>		
		<b>2 Arms</b>	<b>3 Arms</b>	<b>4 Arms</b>
U	Urethane	210	315	420
J1	Solid Surface - Group 1	618	927	1236
J2	Solid Surface - Group 2	818	1227	1636
F	Fully Upholstered Arms	Standard		

<b>FEET OPTIONS</b>		<i>See pg 2 for finishes</i>	
MF	Metal Feet* with Adjustable Glides	Standard	
WF	Wood Feet		
	4 Wood Feet (Single Seat, Love Seat, Sofa)	109	
	6 Wood Feet (2-Seat w/ Intervening Arms)	169	
	8 Wood Feet (3-Seat w/ Intervening Arms)	229	

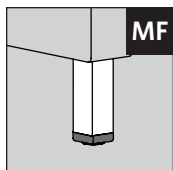

\*Default 540 Pewter finish. 211 Silver Frost available at no charge.

**POWER OPTIONS**

PU8 Power<sup>1</sup> (USB-A/USB-C/Grounded Receptacle) 209

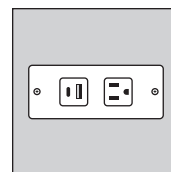

**ADDITIONAL FEATURES & OPTIONS**

CAL CAL TB133 See pg 9  
 Z Multi Cover Use Pricing for Highest Grade  
 MB Moisture Barrier See pg 11

<sup>1</sup>Installed on outside of left (facing) arm

**KOU10 - Lounge Chair**

**Dimensions**

Overall			Seat		
W	D	H	W	D	H
27.25	30	33.75	21.75	19	18
			Back H	Arm H	
			15.75	25	

COM: 3.8 yds  
 Wt Cap: 550 lb  
 Unit Weight: 82 lb

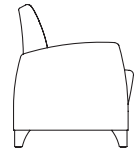
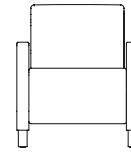

**KOU10 Standard with Fully Upholstered Arms** (Refer to pg 66 for arm cap options)

COM	Dillon/Carson	A <sub>5</sub>	B <sub>6</sub>	C <sub>7</sub>	D <sub>8</sub>	E <sub>9</sub>	F <sub>10</sub>	G <sub>11</sub>	H <sub>12</sub>	I <sub>13</sub>
2,229	2,259	2,359	2,489	2,599	2,739	2,869	3,009	3,259	3,459	3,619

**KOU10B - Bariatric Lounge Chair**

**Dimensions**

Overall			Seat		
W	D	H	W	D	H
34.5	30	33.75	29.5	19	18
			Back H	Arm H	
			15.75	25	

COM: 4.5 yds  
 Wt Cap: 750 lb  
 Unit Weight: 102 lb

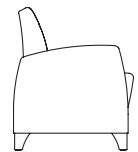
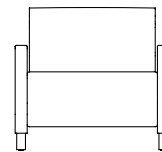

**KOU10B Standard with Fully Upholstered Arms** (Refer to pg 66 for arm cap options)

COM	Dillon/Carson	A <sub>5</sub>	B <sub>6</sub>	C <sub>7</sub>	D <sub>8</sub>	E <sub>9</sub>	F <sub>10</sub>	G <sub>11</sub>	H <sub>12</sub>	I <sub>13</sub>
2,619	2,649	2,779	2,829	2,979	3,049	3,169	3,339	3,679	3,929	4,189

**KOU20 - Lounge Loveseat**

**Dimensions**

Overall			Seat		
W	D	H	W	D	H
49.75	30	33.75	44	19	18
			Back H	Arm H	
			15.75	25	

COM: 5.4 yds  
 Wt Cap: 750 lb  
 Unit Weight: 120 lb

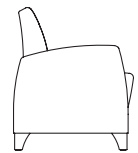
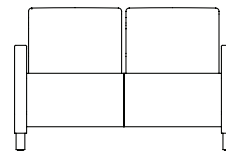

**KOU20 Standard with Fully Upholstered Arms** (Refer to pg 66 for arm cap options)

COM	Dillon/Carson	A <sub>5</sub>	B <sub>6</sub>	C <sub>7</sub>	D <sub>8</sub>	E <sub>9</sub>	F <sub>10</sub>	G <sub>11</sub>	H <sub>12</sub>	I <sub>13</sub>
3,189	3,239	3,399	3,559	3,749	3,929	4,129	4,349	4,719	5,179	5,419

**KOU20I - 2 Seat Lounge Chair with Intervening Arm**

**Dimensions**

Overall			Seat		
W	D	H	W	D	H
51.75	30	33.75	21.75	19	18
			Back H	Arm H	
			15.75	25	

COM: 6.4 yds  
 Wt Cap: 1000 lb  
 Unit Weight: 140 lb

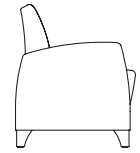
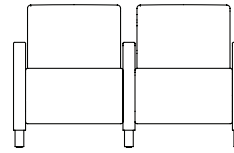

**KOU20I Standard with Fully Upholstered Arms** (Refer to pg 66 for arm cap options)

COM	Dillon/Carson	A <sub>5</sub>	B <sub>6</sub>	C <sub>7</sub>	D <sub>8</sub>	E <sub>9</sub>	F <sub>10</sub>	G <sub>11</sub>	H <sub>12</sub>	I <sub>13</sub>
3,879	3,949	4,139	4,309	4,569	4,729	4,949	5,219	5,579	6,039	6,269

**KOU20T - 2 Seat Lounge Chair with Intervening Table**

**Dimensions**

Overall			Seat		
W	D	H	W	D	H
71.75	30	33.75	21.75	19	18
			Back H	Arm H	
			15.75	25	

COM: 6 yds  
 Wt Cap: 750 lb  
 Unit Weight: 155 lb

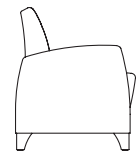
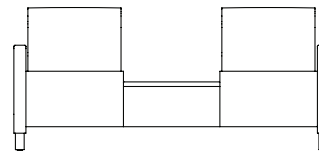

**KOU20T Standard with Fully Upholstered Arms** (Refer to pg 66 for arm cap options)

COM	Dillon/Carson	A <sub>5</sub>	B <sub>6</sub>	C <sub>7</sub>	D <sub>8</sub>	E <sub>9</sub>	F <sub>10</sub>	G <sub>11</sub>	H <sub>12</sub>	I <sub>13</sub>
4,389	4,439	4,679	4,829	5,099	5,279	5,509	5,809	5,889	6,269	6,609

(Tables standard with thermofoil top. Contact customer service for solid surface pricing)

**KOU20IT - 2 Seat Lounge Chair with Intervening Table & Intervening Arms**

**Dimensions**

Overall			Seat		
W	D	H	W	D	H
76.25	30	33.75	21.75	19	18
			Back H	Arm H	
			15.75	25	

COM: 7.8 yds  
 Wt Cap: 1000 lb  
 Unit Weight: 180 lb

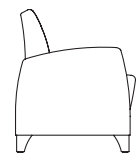
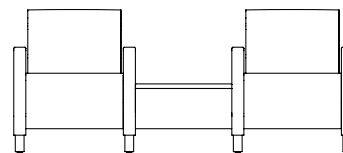

**KOU20IT Standard with Fully Upholstered Arms** (Refer to pg 66 for arm cap options)

COM	Dillon/Carson	A <sub>5</sub>	B <sub>6</sub>	C <sub>7</sub>	D <sub>8</sub>	E <sub>9</sub>	F <sub>10</sub>	G <sub>11</sub>	H <sub>12</sub>	I <sub>13</sub>
4,969	5,029	5,309	5,489	5,799	6,019	6,279	6,599	6,769	7,239	7,589

(Tables standard with thermofoil top. Contact customer service for solid surface pricing)

**KOU20IBL - 2 Seat Left 29.5" Bariatric Lounge Chair with Intervening Arm**

**Dimensions**

Overall			Seat		
W	D	H	W	D	H
59.125	30	33.75	29.5	19	18
			Back H	Arm H	
			15.75	25	

COM: 6.9 yds  
 Wt Cap: 1000 lb  
 Unit Weight: 150 lb

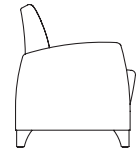
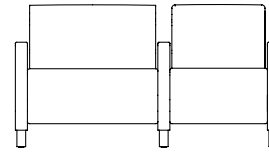

**KOU20IBL Standard with Fully Upholstered Arms** (Refer to pg 66 for arm cap options)

COM	Dillon/Carson	A <sub>5</sub>	B <sub>6</sub>	C <sub>7</sub>	D <sub>8</sub>	E <sub>9</sub>	F <sub>10</sub>	G <sub>11</sub>	H <sub>12</sub>	I <sub>13</sub>
4,309	4,339	4,559	4,709	4,929	5,129	5,309	5,529	5,889	6,269	6,589

**KOU20IBR - 2 Seat Right 29.5" Bariatric Lounge Chair with Intervening Arm**

**Dimensions**

Overall			Seat		
W	D	H	W	D	H
59.125	30	33.75	29.5	19	18
			Back H	Arm H	
			15.75	25	

COM: 6.9 yds  
 Wt Cap: 1000 lb  
 Unit Weight: 150 lb

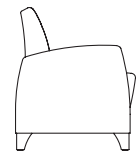
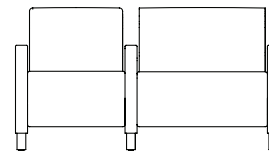

**KOU20IBR Standard with Fully Upholstered Arms** (Refer to pg 66 for arm cap options)

COM	Dillon/Carson	A <sub>5</sub>	B <sub>6</sub>	C <sub>7</sub>	D <sub>8</sub>	E <sub>9</sub>	F <sub>10</sub>	G <sub>11</sub>	H <sub>12</sub>	I <sub>13</sub>
4,309	4,339	4,559	4,709	4,929	5,129	5,309	5,529	5,889	6,269	6,589

**KOU30 - Lounge Sofa**

**Dimensions**

Overall			Seat		
W	D	H	W	D	H
71.75	30	33.75	66.5	19	18
			Back H	Arm H	
			15.75	25	

COM: 7 yds  
 Wt Cap: 750 lb  
 Unit Weight: 155 lb

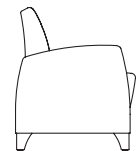
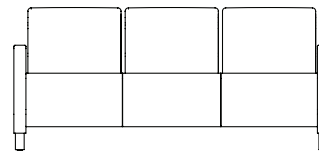

**KOU30 Standard with Fully Upholstered Arms** (Refer to pg 66 for arm cap options)

COM	Dillon/Carson	A <sub>5</sub>	B <sub>6</sub>	C <sub>7</sub>	D <sub>8</sub>	E <sub>9</sub>	F <sub>10</sub>	G <sub>11</sub>	H <sub>12</sub>	I <sub>13</sub>
4,159	4,259	4,509	4,669	4,959	5,169	5,429	5,749	6,199	6,769	7,099

**KOU30I - 3 Seat Lounge Chair with Intervening Arms**

**Dimensions**

Overall			Seat		
W	D	H	W	D	H
76.25	30	33.75	21.75	19	18
			Back H	Arm H	
			15.75	25	

COM: 9.1 yds  
 Wt Cap: 1000 lb  
 Unit Weight: 196 lb

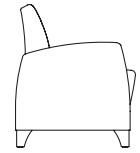
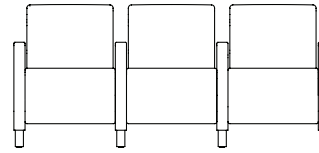

**KOU30I Standard with Fully Upholstered Arms** (Refer to pg 66 for arm cap options)

COM	Dillon/Carson	A <sub>5</sub>	B <sub>6</sub>	C <sub>7</sub>	D <sub>8</sub>	E <sub>9</sub>	F <sub>10</sub>	G <sub>11</sub>	H <sub>12</sub>	I <sub>13</sub>
5,489	5,599	5,919	6,129	6,489	6,749	7,099	7,489	7,649	8,259	8,669

**KOU30IBC - 3 Seat Center 29.5" Bariatric Lounge Chair with Intervening Arms**

**Dimensions**

Overall			Seat		
W	D	H	W	D	H
84	30	33.75	29.5	19	18
			Back H	Arm H	
			15.75	25	

COM: 9.6 yds  
 Wt Cap: 1000 lb  
 Unit Weight: 205 lb

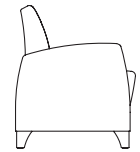
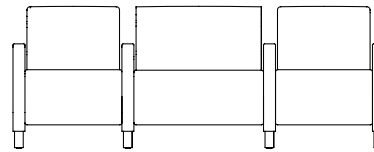

**KOU30IBC Standard with Fully Upholstered Arms** (Refer to pg 66 for arm cap options)

COM	Dillon/Carson	A <sub>5</sub>	B <sub>6</sub>	C <sub>7</sub>	D <sub>8</sub>	E <sub>9</sub>	F <sub>10</sub>	G <sub>11</sub>	H <sub>12</sub>	I <sub>13</sub>
6,099	6,489	6,609	6,649	6,919	7,209	7,429	7,809	7,969	8,609	9,039

**KOU30IBL - 3 Seat Left 29.5" Bariatric Lounge Chair with Intervening Arms**

**Dimensions**

Overall			Seat		
W	D	H	W	D	H
84	30	33.75	29.5	19	18
			Back H	Arm H	
			15.75	25	

COM: 9.6 yds  
 Wt Cap: 1000 lb  
 Unit Weight: 205 lb

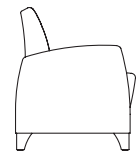
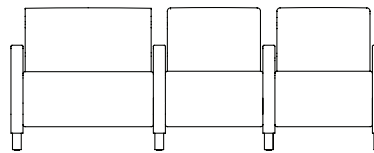

**KOU30IBL Standard with Fully Upholstered Arms** (Refer to pg 66 for arm cap options)

COM	Dillon/Carson	A <sub>5</sub>	B <sub>6</sub>	C <sub>7</sub>	D <sub>8</sub>	E <sub>9</sub>	F <sub>10</sub>	G <sub>11</sub>	H <sub>12</sub>	I <sub>13</sub>
6,099	6,149	6,469	6,649	6,919	7,159	7,429	7,809	7,969	8,609	9,039

**KOU30IBR - 3 Seat Right 29.5" Bariatric Lounge Chair with Intervening Arms**

**Dimensions**

Overall			Seat		
W	D	H	W	D	H
84	30	33.75	29.5	19	18
			Back H	Arm H	
			15.75	25	

COM: 9.6 yds  
 Wt Cap: 1000 lb  
 Unit Weight: 205 lb

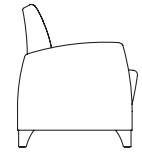
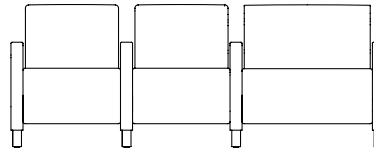

**KOU30IBR Standard with Fully Upholstered Arms** (Refer to pg 66 for arm cap options)

COM	Dillon/Carson	A <sub>5</sub>	B <sub>6</sub>	C <sub>7</sub>	D <sub>8</sub>	E <sub>9</sub>	F <sub>10</sub>	G <sub>11</sub>	H <sub>12</sub>	I <sub>13</sub>
6,099	6,149	6,469	6,649	6,919	7,159	7,429	7,809	7,969	8,609	9,039

**KOU15T - Upholstered Lounge 15" Inline Table**

**Dimensions**

Overall		
W	D	H
16	20.25	19

COM: 1 yds  
 Unit Weight: 34 lb

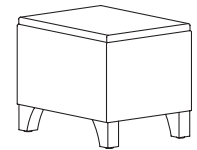

**KOU15T Standard with Thermofoil Top** (Contact customer service for solid surface pricing - KOU15J)

COM	Dillon/Carson	A <sub>5</sub>	B <sub>6</sub>	C <sub>7</sub>	D <sub>8</sub>	E <sub>9</sub>	F <sub>10</sub>	G <sub>11</sub>	H <sub>12</sub>	I <sub>13</sub>
1,219	1,229	1,239	1,259	1,269	1,289	1,309	1,329	1,489	1,559	1,589

**KOU90T - Upholstered Lounge 90 Degree Corner Table**

**Dimensions**

Overall		
W	D	H
45	23.75	18.25

COM: 1 yds  
 Unit Weight: 60 lb

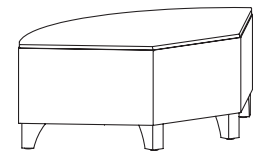

**KOU90T Standard with Thermofoil Top** (Contact customer service for solid surface pricing - KOU90J)

COM	Dillon/Carson	A <sub>5</sub>	B <sub>6</sub>	C <sub>7</sub>	D <sub>8</sub>	E <sub>9</sub>	F <sub>10</sub>	G <sub>11</sub>	H <sub>12</sub>	I <sub>13</sub>
1,629	1,649	1,659	1,669	1,719	1,739	1,749	1,799	1,979	2,059	2,129



**General Product Information**

- Seat and back frames are poplar plywood construction; joints are CNC cut/puzzle-jointed, glued, stapled together, and reinforced with corner blocks for superior strength
- Seat foam: 2.5 density foam that meets CAL 117 Fire Standards
- Back foam: 1.7 high resilience density foam that meets CAL 117 Fire Standards
- 10 gauge heavy duty steel springs in back
- 7.5 gauge steel sinuous seat springs for lasting comfort
- Standard with round metal legs with adjustable glides
- Ganging brackets included with armless units

**To Order, Specify**

- Model Number
- Textile
- Finish
- Options

**Available Options**

<b>ARM CAP OPTIONS</b>		<i>See pg 2 for finishes</i>
U	Urethane	Standard on specified models
J	Solid Surface	Standard on specified models
F	Fully Upholstered Arms	Standard on specified models

<b>POWER OPTIONS</b>		
PUB8	Power (USB-A/USB-C/Grounded Receptacle)	209

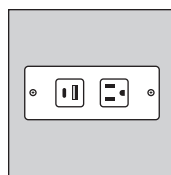

**Power Placement:**  
*Armless Models-*  
*front center of seat*  
*Seat with Arms-*  
*side of left (facing) arm*  
*Left Arm Models-*  
*side of left (facing) arm*  
*Right Arm Models-*  
*side of right (facing) arm*  
*Table Models-*  
*front center of table*

<b>LEG OPTIONS</b>		<i>See pg 2 for finishes</i>
RL	Round Metal Legs	Standard
	<i>*Standard in 211 Silver Frost finish</i>	
SL	Square Metal Legs	No Upcharge
	<i>*Standard in 211 Silver Frost finish</i>	

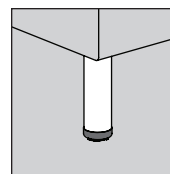

Round Metal Leg

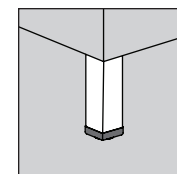

Square Metal Leg

**ADDITIONAL FEATURES & OPTIONS**

CAL	CAL TB133	See pg 9
Z	Multi Cover	Use Pricing for Highest Grade
MB	Moisture Barrier	See pg 11

**AS10N - Armless Lounge Chair**

**Dimensions**

Overall			Seat		
W	D	H	W	D	H
24.5	30.75	32.75	24.5	21.5	18.5
			Back H	Arm H	
			14.25	n/a	

<b>COM:</b> 2.7 yds
<b>Wt Cap:</b> 500 lb
<b>Unit Weight:</b> 48 lb

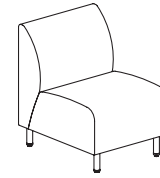

**Pricing**

COM	Dillon/Carson	A <sub>5</sub>	B <sub>6</sub>	C <sub>7</sub>	D <sub>8</sub>	E <sub>9</sub>	F <sub>10</sub>	G <sub>11</sub>	H <sub>12</sub>	I <sub>13</sub>
1,739	1,769	1,809	1,849	1,919	2,039	2,109	2,259	2,579	2,759	2,969

**AS10NC - Armless Lounge Chair on Casters**

**Dimensions**

Overall			Seat		
W	D	H	W	D	H
24.5	30.75	32.75	24.5	21.5	18.5
			Back H	Arm H	
			14.25	n/a	

<b>COM:</b> 2.7 yds
<b>Wt Cap:</b> 500 lb
<b>Unit Weight:</b> 48 lb

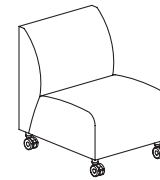

**Pricing**

COM	Dillon/Carson	A <sub>5</sub>	B <sub>6</sub>	C <sub>7</sub>	D <sub>8</sub>	E <sub>9</sub>	F <sub>10</sub>	G <sub>11</sub>	H <sub>12</sub>	I <sub>13</sub>
1,989	2,019	2,079	2,119	2,199	2,289	2,359	2,519	2,809	3,019	3,269

**AS20N - 2 Seat Armless Lounge Chair**

**Dimensions**

Overall			Seat		
W	D	H	W	D	H
48.75	30.75	32.75	48.75	21.5	18.5
			Back H	Arm H	
			14.25	n/a	

<b>COM:</b> 3.9 yds
<b>Wt Cap:</b> 750 lb
<b>Unit Weight:</b> 94 lb

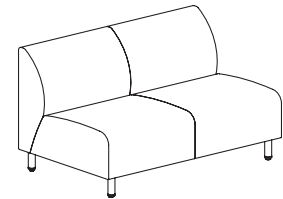

**Pricing**

COM	Dillon/Carson	A <sub>5</sub>	B <sub>6</sub>	C <sub>7</sub>	D <sub>8</sub>	E <sub>9</sub>	F <sub>10</sub>	G <sub>11</sub>	H <sub>12</sub>	I <sub>13</sub>
2,809	2,879	3,009	3,099	3,269	3,429	3,579	3,819	3,999	4,419	4,839

**AS30N - 3 Seat Armless Lounge Chair**

**Dimensions**

Overall			Seat		
W	D	H	W	D	H
72.75	30.75	32.75	72.75	21.5	18.5
			Back H	Arm H	
			14.25	n/a	

<b>COM:</b> 5.4 yds
<b>Wt Cap:</b> 1000 lb
<b>Unit Weight:</b> 138 lb

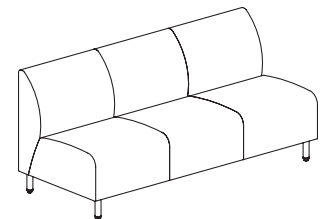

**Pricing**

COM	Dillon/Carson	A <sub>5</sub>	B <sub>6</sub>	C <sub>7</sub>	D <sub>8</sub>	E <sub>9</sub>	F <sub>10</sub>	G <sub>11</sub>	H <sub>12</sub>	I <sub>13</sub>
3,889	4,059	4,179	4,389	4,619	4,889	5,109	5,419	6,019	6,439	6,879

**AS12A - Lounge Chair with Square Arms**

**Dimensions**

Overall			Seat				
W	D	H	W	D	H		
29.5	30.75	32.75	24	21.5	18.5	COM: 4.9 yds	
			Back H		Arm H	Wt Cap: 500 lb	
			14.25		26	Unit Weight: 78 lb	

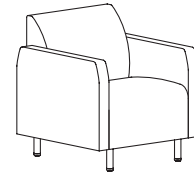

**AS12AF with Fully Upholstered Arms**

COM	Dillon	Carson	A <sub>5</sub>	B <sub>6</sub>	C <sub>7</sub>	D <sub>8</sub>	E <sub>9</sub>	F <sub>10</sub>	G <sub>11</sub>	H <sub>12</sub>	I <sub>13</sub>
2,309	2,399	2,579	2,719	2,919	3,129	3,339	3,689	3,849	4,109	4,469	

**AS12AU with Urethane Arm Caps**

COM	Dillon	Carson	A <sub>5</sub>	B <sub>6</sub>	C <sub>7</sub>	D <sub>8</sub>	E <sub>9</sub>	F <sub>10</sub>	G <sub>11</sub>	H <sub>12</sub>	I <sub>13</sub>
2,509	2,639	2,769	2,909	3,119	3,349	3,539	3,869	4,059	4,509	5,009	

**AS12AJ with Solid Surface Arm Caps** (Add \$100 List per arm cap for Group 2 solid surface finish)

COM	Dillon	Carson	A <sub>5</sub>	B <sub>6</sub>	C <sub>7</sub>	D <sub>8</sub>	E <sub>9</sub>	F <sub>10</sub>	G <sub>11</sub>	H <sub>12</sub>	I <sub>13</sub>
2,959	3,069	3,239	3,389	3,589	3,799	3,999	4,359	4,469	4,779	5,299	

**AS12L - Lounge Chair with Left Square Arm**

**Dimensions**

Overall			Seat				
W	D	H	W	D	H		
27	30.75	32.75	24	21.5	18.5	COM: 3.8 yds	
			Back H		Arm H	Wt Cap: 500 lb	
			14.25		26	Unit Weight: 64 lb	

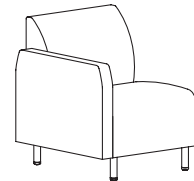

**AS12LF with Fully Upholstered Arms**

COM	Dillon	Carson	A <sub>5</sub>	B <sub>6</sub>	C <sub>7</sub>	D <sub>8</sub>	E <sub>9</sub>	F <sub>10</sub>	G <sub>11</sub>	H <sub>12</sub>	I <sub>13</sub>
1,969	2,059	2,149	2,259	2,379	2,559	2,669	2,929	3,279	3,639	3,949	

**AS12LU with Urethane Arm Caps**

COM	Dillon	Carson	A <sub>5</sub>	B <sub>6</sub>	C <sub>7</sub>	D <sub>8</sub>	E <sub>9</sub>	F <sub>10</sub>	G <sub>11</sub>	H <sub>12</sub>	I <sub>13</sub>
2,089	2,159	2,259	2,349	2,519	2,649	2,799	3,039	3,369	3,719	4,109	

**AS12LJ with Solid Surface Arm Caps** (Add \$100 List per arm cap for Group 2 solid surface finish)

COM	Dillon	Carson	A <sub>5</sub>	B <sub>6</sub>	C <sub>7</sub>	D <sub>8</sub>	E <sub>9</sub>	F <sub>10</sub>	G <sub>11</sub>	H <sub>12</sub>	I <sub>13</sub>
2,309	2,379	2,499	2,599	2,719	2,899	3,019	3,279	3,599	3,969	4,329	

**AS12R - Lounge Chair with Right Square Arm**

**Dimensions**

Overall			Seat				
W	D	H	W	D	H		
27	30.75	32.75	24	21.5	18.5		
			Back H	Arm H			
			14.25	26			

COM: 3.8 yds  
Wt Cap: 500 lb  
Unit Weight: 64 lb

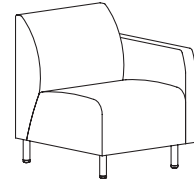

**AS12RF with Fully Upholstered Arms**

COM	Dillon	Carson	A <sub>5</sub>	B <sub>6</sub>	C <sub>7</sub>	D <sub>8</sub>	E <sub>9</sub>	F <sub>10</sub>	G <sub>11</sub>	H <sub>12</sub>	I <sub>13</sub>
1,969	2,059	2,149	2,259	2,379	2,559	2,669	2,929	3,279	3,639	3,949	

**AS12RU with Urethane Arm Caps**

COM	Dillon	Carson	A <sub>5</sub>	B <sub>6</sub>	C <sub>7</sub>	D <sub>8</sub>	E <sub>9</sub>	F <sub>10</sub>	G <sub>11</sub>	H <sub>12</sub>	I <sub>13</sub>
2,089	2,159	2,259	2,349	2,519	2,649	2,799	3,039	3,369	3,719	4,109	

**AS12RJ with Solid Surface Arm Caps** (Add \$100 List per arm cap for Group 2 solid surface finish)

COM	Dillon	Carson	A <sub>5</sub>	B <sub>6</sub>	C <sub>7</sub>	D <sub>8</sub>	E <sub>9</sub>	F <sub>10</sub>	G <sub>11</sub>	H <sub>12</sub>	I <sub>13</sub>
2,309	2,379	2,499	2,599	2,719	2,899	3,019	3,279	3,599	3,969	4,329	

**AS22A - 2 Seat Lounge Chair with Square Arms**

**Dimensions**

Overall			Seat				
W	D	H	W	D	H		
53.5	30.75	32.75	48.5	21.5	18.5		
			Back H	Arm H			
			14.25	26			

COM: 6.2 yds  
Wt Cap: 750 lb  
Unit Weight: 123 lb

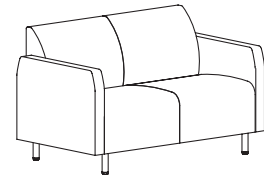

**AS22AF with Fully Upholstered Arms**

COM	Dillon	Carson	A <sub>5</sub>	B <sub>6</sub>	C <sub>7</sub>	D <sub>8</sub>	E <sub>9</sub>	F <sub>10</sub>	G <sub>11</sub>	H <sub>12</sub>	I <sub>13</sub>
3,369	3,549	3,679	3,869	4,099	4,379	4,599	4,959	5,269	5,729	6,299	

**AS22AU with Urethane Arm Caps**

COM	Dillon	Carson	A <sub>5</sub>	B <sub>6</sub>	C <sub>7</sub>	D <sub>8</sub>	E <sub>9</sub>	F <sub>10</sub>	G <sub>11</sub>	H <sub>12</sub>	I <sub>13</sub>
3,599	3,729	3,879	4,079	4,329	4,579	4,779	5,139	5,439	5,929	6,569	

**AS22AJ with Solid Surface Arm Caps** (Add \$100 List per arm cap for Group 2 solid surface finish)

COM	Dillon	Carson	A <sub>5</sub>	B <sub>6</sub>	C <sub>7</sub>	D <sub>8</sub>	E <sub>9</sub>	F <sub>10</sub>	G <sub>11</sub>	H <sub>12</sub>	I <sub>13</sub>
4,049	4,199	4,349	4,539	4,759	5,039	5,249	5,629	5,869	6,239	6,709	

**AS22L - 2 Seat Lounge Chair with Left Square Arm**

**Dimensions**

Overall			Seat				
W	D	H	W	D	H		
51	30.75	32.75	48.5	21.5	18.5		
			Back H	Arm H			
			14.25	26			

COM: 5 yds  
 Wt Cap: 750 lb  
 Unit Weight: 111 lb

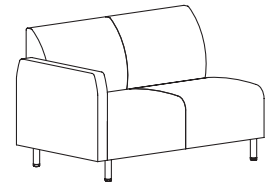

**AS22LF with Fully Upholstered Arms**

COM	Dillon	Carson	A <sub>5</sub>	B <sub>6</sub>	C <sub>7</sub>	D <sub>8</sub>	E <sub>9</sub>	F <sub>10</sub>	G <sub>11</sub>	H <sub>12</sub>	I <sub>13</sub>
3,089	3,189	3,309	3,479	3,659	3,879	4,069	4,349	4,519	4,989	5,499	

**AS22LU with Urethane Arm Caps**

COM	Dillon	Carson	A <sub>5</sub>	B <sub>6</sub>	C <sub>7</sub>	D <sub>8</sub>	E <sub>9</sub>	F <sub>10</sub>	G <sub>11</sub>	H <sub>12</sub>	I <sub>13</sub>
3,199	3,309	3,409	3,589	3,779	3,989	4,159	4,449	4,609	5,319	5,909	

**AS22LJ with Solid Surface Arm Caps** (Add \$100 List per arm cap for Group 2 solid surface finish)

COM	Dillon	Carson	A <sub>5</sub>	B <sub>6</sub>	C <sub>7</sub>	D <sub>8</sub>	E <sub>9</sub>	F <sub>10</sub>	G <sub>11</sub>	H <sub>12</sub>	I <sub>13</sub>
3,429	3,539	3,639	3,829	3,989	4,219	4,399	4,679	4,829	5,629	6,439	

**AS22R - 2 Seat Lounge Chair with Right Square Arm**

**Dimensions**

Overall			Seat				
W	D	H	W	D	H		
51	30.75	32.75	48.5	21.5	18.5		
			Back H	Arm H			
			14.25	26			

COM: 5 yds  
 Wt Cap: 750 lb  
 Unit Weight: 111 lb

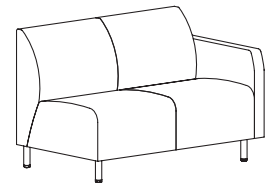

**AS22RF with Fully Upholstered Arms**

COM	Dillon	Carson	A <sub>5</sub>	B <sub>6</sub>	C <sub>7</sub>	D <sub>8</sub>	E <sub>9</sub>	F <sub>10</sub>	G <sub>11</sub>	H <sub>12</sub>	I <sub>13</sub>
3,089	3,189	3,309	3,479	3,659	3,879	4,069	4,349	4,519	4,989	5,499	

**AS22RU with Urethane Arm Caps**

COM	Dillon	Carson	A <sub>5</sub>	B <sub>6</sub>	C <sub>7</sub>	D <sub>8</sub>	E <sub>9</sub>	F <sub>10</sub>	G <sub>11</sub>	H <sub>12</sub>	I <sub>13</sub>
3,199	3,309	3,409	3,589	3,779	3,989	4,159	4,449	4,609	5,319	5,909	

**AS22RJ with Solid Surface Arm Caps** (Add \$100 List per arm cap for Group 2 solid surface finish)

COM	Dillon	Carson	A <sub>5</sub>	B <sub>6</sub>	C <sub>7</sub>	D <sub>8</sub>	E <sub>9</sub>	F <sub>10</sub>	G <sub>11</sub>	H <sub>12</sub>	I <sub>13</sub>
3,429	3,539	3,639	3,829	3,989	4,219	4,399	4,679	4,829	5,629	6,439	

**AS32A - 3 Seat Lounge Chair with Square Arms**

**Dimensions**

Overall			Seat				
W	D	H	W	D	H	Back H	Arm H
77.5	30.75	32.75	72.5	21.5	18.5	14.25	26

COM: 7.6 yds  
 Wt Cap: 1000 lb  
 Unit Weight: 167 lb

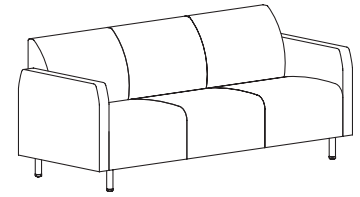

**AS32AF with Fully Upholstered Arms**

COM	Dillon	Carson	A <sub>5</sub>	B <sub>6</sub>	C <sub>7</sub>	D <sub>8</sub>	E <sub>9</sub>	F <sub>10</sub>	G <sub>11</sub>	H <sub>12</sub>	I <sub>13</sub>
4,429	4,619	4,869	5,139	5,459	5,879	6,179	6,619	6,919	7,329	8,059	

**AS32AU with Urethane Arm Caps**

COM	Dillon	Carson	A <sub>5</sub>	B <sub>6</sub>	C <sub>7</sub>	D <sub>8</sub>	E <sub>9</sub>	F <sub>10</sub>	G <sub>11</sub>	H <sub>12</sub>	I <sub>13</sub>
4,649	4,849	5,079	5,349	5,669	6,049	6,379	6,829	7,089	7,429	8,059	

**AS32AJ with Solid Surface Arm Caps** (Add \$100 List per arm cap for Group 2 solid surface finish)

COM	Dillon	Carson	A <sub>5</sub>	B <sub>6</sub>	C <sub>7</sub>	D <sub>8</sub>	E <sub>9</sub>	F <sub>10</sub>	G <sub>11</sub>	H <sub>12</sub>	I <sub>13</sub>
5,109	5,279	5,519	5,789	6,129	6,529	6,819	7,289	7,509	7,959	8,439	

**AS32L - 3 Seat Lounge Chair with Left Square Arm**

**Dimensions**

Overall			Seat				
W	D	H	W	D	H	Back H	Arm H
75	30.75	32.75	72.5	21.5	18.5	14.25	26

COM: 6.4 yds  
 Wt Cap: 1000 lb  
 Unit Weight: 153 lb

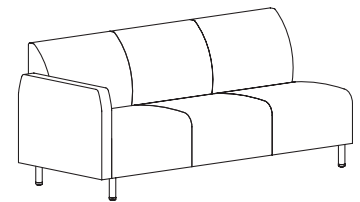

**AS32LF with Fully Upholstered Arms**

COM	Dillon	Carson	A <sub>5</sub>	B <sub>6</sub>	C <sub>7</sub>	D <sub>8</sub>	E <sub>9</sub>	F <sub>10</sub>	G <sub>11</sub>	H <sub>12</sub>	I <sub>13</sub>
4,089	4,209	4,409	4,609	4,879	5,189	5,439	5,809	6,329	6,699	7,159	

**AS32LU with Urethane Arm Caps**

COM	Dillon	Carson	A <sub>5</sub>	B <sub>6</sub>	C <sub>7</sub>	D <sub>8</sub>	E <sub>9</sub>	F <sub>10</sub>	G <sub>11</sub>	H <sub>12</sub>	I <sub>13</sub>
4,169	4,349	4,529	4,709	4,969	5,309	5,529	5,899	6,419	6,819	7,279	

**AS32LJ with Solid Surface Arm Caps** (Add \$100 List per arm cap for Group 2 solid surface finish)

COM	Dillon	Carson	A <sub>5</sub>	B <sub>6</sub>	C <sub>7</sub>	D <sub>8</sub>	E <sub>9</sub>	F <sub>10</sub>	G <sub>11</sub>	H <sub>12</sub>	I <sub>13</sub>
4,419	4,559	4,749	4,939	5,209	5,519	5,769	6,149	6,639	7,019	7,359	

**AS32R - 3 Seat Lounge Chair with Right Square Arm**

**Dimensions**

Overall			Seat				
W	D	H	W	D	H		
75	30.75	32.75	72.5	21.5	18.5		
			Back H	Arm H			
			14.25	26			

COM: 6.4 yds  
 Wt Cap: 1000 lb  
 Unit Weight: 153 lb

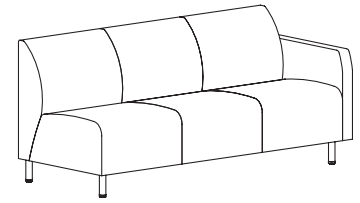

**AS32RF with Fully Upholstered Arms**

COM	Dillon/Carson	A <sub>5</sub>	B <sub>6</sub>	C <sub>7</sub>	D <sub>8</sub>	E <sub>9</sub>	F <sub>10</sub>	G <sub>11</sub>	H <sub>12</sub>	I <sub>13</sub>
4,089	4,209	4,409	4,609	4,879	5,189	5,439	5,809	6,329	6,699	7,159

**AS32RU with Urethane Arm Caps**

COM	Dillon/Carson	A <sub>5</sub>	B <sub>6</sub>	C <sub>7</sub>	D <sub>8</sub>	E <sub>9</sub>	F <sub>10</sub>	G <sub>11</sub>	H <sub>12</sub>	I <sub>13</sub>
4,169	4,349	4,529	4,709	4,969	5,309	5,529	5,899	6,419	6,819	7,279

**AS32RJ with Solid Surface Arm Caps** (Add \$100 List per arm cap for Group 2 solid surface finish)

COM	Dillon/Carson	A <sub>5</sub>	B <sub>6</sub>	C <sub>7</sub>	D <sub>8</sub>	E <sub>9</sub>	F <sub>10</sub>	G <sub>11</sub>	H <sub>12</sub>	I <sub>13</sub>
4,419	4,559	4,749	4,939	5,209	5,519	5,769	6,149	6,639	6,989	7,359

**AS90IC - 90 Degree Inside Corner Lounge Chair**

**Dimensions**

Overall			Seat		
W	D	H	W	D	H
51.25	34.5	32.75	50	25.5	18.5
			Back H	Arm H	
			14.25	n/a	

COM: 4.2 yds  
 Wt Cap: 750 lb  
 Unit Weight: 75 lb

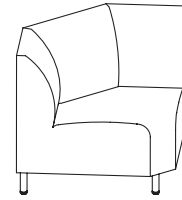

**Pricing**

COM	Dillon/Carson	A <sub>5</sub>	B <sub>6</sub>	C <sub>7</sub>	D <sub>8</sub>	E <sub>9</sub>	F <sub>10</sub>	G <sub>11</sub>	H <sub>12</sub>	I <sub>13</sub>
2,459	2,599	2,769	2,879	2,979	3,189	3,299	3,529	3,729	3,819	3,979

**AS90OC - 90 Degree Outside Corner Lounge Chair**

**Dimensions**

Overall			Seat		
W	D	H	W	D	H
50.5	34.5	32.75	50.5	22.5	18.5
			Back H	Arm H	
			14.25	n/a	

COM: 3 yds  
 Wt Cap: 750 lb  
 Unit Weight: 69 lb

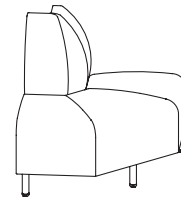

**Pricing**

COM	Dillon/Carson	A <sub>5</sub>	B <sub>6</sub>	C <sub>7</sub>	D <sub>8</sub>	E <sub>9</sub>	F <sub>10</sub>	G <sub>11</sub>	H <sub>12</sub>	I <sub>13</sub>
2,399	2,539	2,709	2,789	2,909	3,109	3,229	3,469	3,679	3,699	3,809

**ASB2424 - 24" One Seat Bench**

**Dimensions**

Overall			Seat		
W	D	H	W	D	H
24.5	24.5	18.5	24.5	24.5	18.5

COM: 1.8 yds  
 Wt Cap: 400 lb  
 Unit Weight: 32 lb

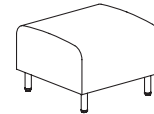

**Pricing**

COM	Dillon/Carson	A <sub>5</sub>	B <sub>6</sub>	C <sub>7</sub>	D <sub>8</sub>	E <sub>9</sub>	F <sub>10</sub>	G <sub>11</sub>	H <sub>12</sub>	I <sub>13</sub>
1,359	1,369	1,459	1,469	1,499	1,609	1,639	1,669	1,819	1,919	1,979

**ASB2448 - 24" Two Seat Bench**

**Dimensions**

Overall			Seat		
W	D	H	W	D	H
48.5	24.5	18.5	48.5	24.5	18.5

COM: 2.2 yds  
 Wt Cap: 650 lb  
 Unit Weight: 62 lb

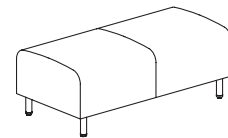

**Pricing**

COM	Dillon/Carson	A <sub>5</sub>	B <sub>6</sub>	C <sub>7</sub>	D <sub>8</sub>	E <sub>9</sub>	F <sub>10</sub>	G <sub>11</sub>	H <sub>12</sub>	I <sub>13</sub>
2,249	2,279	2,409	2,449	2,499	2,619	2,639	2,689	2,799	2,899	3,009

**ASB2472 - 24" Three Seat Bench**

**Dimensions**

Overall			Seat		
W	D	H	W	D	H
72.5	24.5	18.5	72.5	24.5	18.5

COM: 3.3 yds  
 Wt Cap: 900 lb  
 Unit Weight: 85 lb

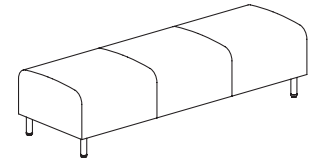

**Pricing**

COM	Dillon/Carson	A <sub>5</sub>	B <sub>6</sub>	C <sub>7</sub>	D <sub>8</sub>	E <sub>9</sub>	F <sub>10</sub>	G <sub>11</sub>	H <sub>12</sub>	I <sub>13</sub>
2,669	2,699	2,859	2,899	2,939	3,019	3,159	3,369	3,469	3,579	3,679

**ASB3024 - 30" One Seat Bench**

**Dimensions**

Overall			Seat		
W	D	H	W	D	H
24.5	30.35	18.5	24.5	30.5	18.5

COM: 2.8 yds  
 Wt Cap: 400 lb  
 Unit Weight: 67 lb

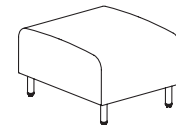

**Pricing**

COM	Dillon/Carson	A <sub>5</sub>	B <sub>6</sub>	C <sub>7</sub>	D <sub>8</sub>	E <sub>9</sub>	F <sub>10</sub>	G <sub>11</sub>	H <sub>12</sub>	I <sub>13</sub>
1,469	1,479	1,539	1,569	1,629	1,729	1,799	1,869	2,109	2,219	2,359

**ASB3048 - 30" Two Seat Bench**

**Dimensions**

Overall			Seat		
W	D	H	W	D	H
48.5	30.5	18.5	48.5	30.5	18.5

COM: 2.8 yds  
 Wt Cap: 650 lb  
 Unit Weight: 67 lb

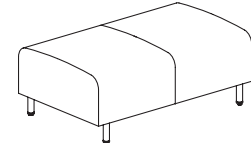

**Pricing**

COM	Dillon/Carson	A <sub>5</sub>	B <sub>6</sub>	C <sub>7</sub>	D <sub>8</sub>	E <sub>9</sub>	F <sub>10</sub>	G <sub>11</sub>	H <sub>12</sub>	I <sub>13</sub>
2,369	2,399	2,539	2,629	2,669	2,739	2,759	2,839	2,939	3,049	3,149

**ASB3072 - 30" Three Seat Bench**

**Dimensions**

Overall			Seat		
W	D	H	W	D	H
72.5	30.5	18.5	72.5	30.5	18.5

COM: 4.5 yds  
 Wt Cap: 900 lb  
 Unit Weight: 92 lb

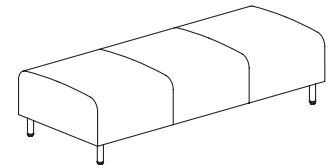

**Pricing**

COM	Dillon/Carson	A <sub>5</sub>	B <sub>6</sub>	C <sub>7</sub>	D <sub>8</sub>	E <sub>9</sub>	F <sub>10</sub>	G <sub>11</sub>	H <sub>12</sub>	I <sub>13</sub>
2,939	2,959	3,159	3,199	3,229	3,289	3,429	3,619	3,849	3,929	4,149

**AST10 - Table with Thermofoil Top** *(Contact customer service for solid surface pricing)*

**Dimensions**

Overall		
W	D	H
24.5	29.75	15.5

COM: 1.3 yds  
Unit Weight: 51 lb

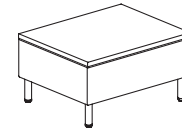

**Pricing**

COM	Dillon/Carson	A <sub>5</sub>	B <sub>6</sub>	C <sub>7</sub>	D <sub>8</sub>	E <sub>9</sub>	F <sub>10</sub>	G <sub>11</sub>	H <sub>12</sub>	I <sub>13</sub>
1,509	1,549	1,669	1,699	1,709	1,729	1,739	1,819	1,879	1,989	2,089

**AST15 - Inline Table with Thermofoil Top** *(Contact customer service for solid surface pricing)*

**Dimensions**

Overall		
W	D	H
16	20.25	15.5

COM: 0.9 yds  
Unit Weight: 34 lb

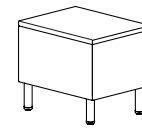

**Pricing**

COM	Dillon/Carson	A <sub>5</sub>	B <sub>6</sub>	C <sub>7</sub>	D <sub>8</sub>	E <sub>9</sub>	F <sub>10</sub>	G <sub>11</sub>	H <sub>12</sub>	I <sub>13</sub>
1,249	1,259	1,309	1,339	1,349	1,389	1,399	1,409	1,569	1,669	1,779

**AST90 - 90 Degree Table with Thermofoil Top** *(Contact customer service for solid surface pricing)*

**Dimensions**

Overall		
W	D	H
50.75	34.75	15.5

COM: 1.3 yds  
Unit Weight: 78 lb

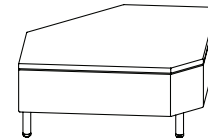

**Pricing**

COM	Dillon/Carson	A <sub>5</sub>	B <sub>6</sub>	C <sub>7</sub>	D <sub>8</sub>	E <sub>9</sub>	F <sub>10</sub>	G <sub>11</sub>	H <sub>12</sub>	I <sub>13</sub>
2,119	2,169	2,289	2,339	2,379	2,409	2,479	2,529	2,599	2,649	2,699



**General Product Information**

- Seat clean-out
- All interior joints are CNC cut/puzzle-jointed, corner blocked, screwed, & glued together
- Commercial grade double-walled plywood interior
- Kiln-dried hardwood interior components
- Arms connected by 14 gauge steel support tubes
- Seat foam: 2.8 high resilience density foam that meets CAL 117 Fire Standards
- Back foam: 2.5 density foam that meets CAL 117 Fire Standards
- Steel sinuous springs in seat & back
- Field replaceable components

**To Order, Specify**

- Model Number
- Textile
- Finish
- Options

**Available Options**

<b>ARM CAP OPTIONS</b>		<i>See pg 2 for finishes</i>
T	Thermofoil	Standard on specified models
J	Solid Surface	Contact customer service
F	Fully Upholstered Arms	Standard on specified models

<b>POWER OPTIONS</b>		
PUB8	Power (USB-A/USB-C/Grounded Receptacle)	209

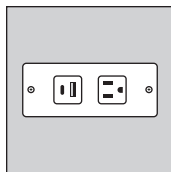

**Power Placement:**  
 3.5" Arm Models-  
 outside of left (facing) arm  
 8.5" Arm Models-  
 front of left (facing) arm

<b>ADDITIONAL FEATURES &amp; OPTIONS</b>		
CAL	CAL TB133	See pg 9
Z	Multi Cover	Use Pricing for Highest Grade
MB	Moisture Barrier	See pg 11

<b>LEG OPTIONS</b>		<i>See pg 2 for finishes</i>
ML	Metal Legs* with Adjustable Glides	Standard
	<i>*Default 540 Pewter finish. 211 Silver Frost available at no charge.</i>	
TML	Tapered Metal Legs with Adjustable Glides	949
	<i>*211 Silver Frost finish<sup>1</sup></i>	
WL	Wood Legs with Adjustable Glides	No Upcharge
WTL	Wood Tapered Legs with Adjustable Glides	279

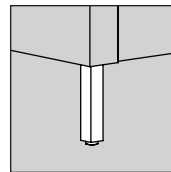

Metal Leg

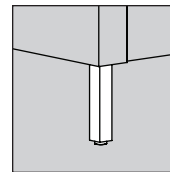

Wood Leg

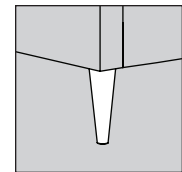

Tapered Leg  
(Wood or Metal)

<sup>1</sup>Additional metal finishes are available. Contact customer service for a quote.

**KAS10 - Lounge Chair with 22" Wide Seat, 3.5" Arms**

**Dimensions**

Overall			Seat			COM: 3.8 yds Wt Cap: 550 lb Unit Weight: 71 lb
W	D	H	W	D	H	
29.5	27.75	31.75	22.25	19.125	18.375	
			Back H	Arm H		
			14.5	25.25		

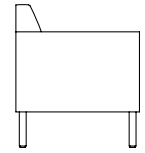
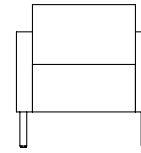

**KAS10F with Fully Upholstered Arms**

COM	Dillon	Carson	A <sub>5</sub>	B <sub>6</sub>	C <sub>7</sub>	D <sub>8</sub>	E <sub>9</sub>	F <sub>10</sub>	G <sub>11</sub>	H <sub>12</sub>	I <sub>13</sub>
2,129	2,179	2,309	2,509	2,649	2,799	2,959	3,149	3,389	3,659	3,949	

**KAS10A with Thermofoil Arm Caps**

COM	Dillon	Carson	A <sub>5</sub>	B <sub>6</sub>	C <sub>7</sub>	D <sub>8</sub>	E <sub>9</sub>	F <sub>10</sub>	G <sub>11</sub>	H <sub>12</sub>	I <sub>13</sub>
2,239	2,269	2,379	2,639	2,779	2,939	3,079	3,259	3,469	3,729	4,039	

\*Contact customer service for solid surface pricing of arm caps or back rail caps (on applicable models).

**KAS13 - Lounge Chair with 22" Wide Seat, 3.5" Arms & Boxed Back**

**Dimensions**

Overall			Seat			COM: 4.1 yds Wt Cap: 550 lb Unit Weight: 90 lb
W	D	H	W	D	H	
29.5	31.25	31.75	22.25	19.125	18.375	
			Back H	Arm H		
			14.5	25.25		

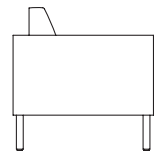
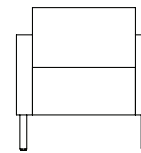

**KAS13F with Fully Upholstered Arms**

COM	Dillon	Carson	A <sub>5</sub>	B <sub>6</sub>	C <sub>7</sub>	D <sub>8</sub>	E <sub>9</sub>	F <sub>10</sub>	G <sub>11</sub>	H <sub>12</sub>	I <sub>13</sub>
2,249	2,279	2,409	2,679	2,789	2,999	3,129	3,339	3,629	3,859	4,149	

**KAS13A with Thermofoil Arm Caps and Back Rail Cap**

COM	Dillon	Carson	A <sub>5</sub>	B <sub>6</sub>	C <sub>7</sub>	D <sub>8</sub>	E <sub>9</sub>	F <sub>10</sub>	G <sub>11</sub>	H <sub>12</sub>	I <sub>13</sub>
2,359	2,389	2,529	2,799	2,909	3,099	3,239	3,439	3,679	3,939	4,299	

\*Contact customer service for solid surface pricing of arm caps or back rail caps (on applicable models).

**KAS10B - Lounge Chair with 30" Wide Seat, 3.5" Arms**

**Dimensions**

Overall			Seat				
W	D	H	W	D	H		
37.25	27.75	31.75	30	19.125	18.375	COM: 4.5 yds	
						Wt Cap: 750 lb	
						Unit Weight: 80 lb	
			Back H	Arm H			
			14.5	25.25			

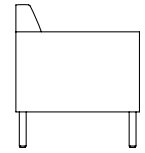
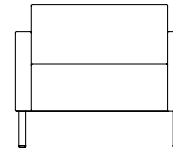

**KAS10BF with Fully Upholstered Arms**

COM	Dillon	Carson	A <sub>5</sub>	B <sub>6</sub>	C <sub>7</sub>	D <sub>8</sub>	E <sub>9</sub>	F <sub>10</sub>	G <sub>11</sub>	H <sub>12</sub>	I <sub>13</sub>
2,329	2,349	2,459	2,749	2,829	3,069	3,199	3,409	3,859	4,109	4,539	

**KAS10BA with Thermofoil Arm Caps**

COM	Dillon	Carson	A <sub>5</sub>	B <sub>6</sub>	C <sub>7</sub>	D <sub>8</sub>	E <sub>9</sub>	F <sub>10</sub>	G <sub>11</sub>	H <sub>12</sub>	I <sub>13</sub>
2,389	2,409	2,559	2,829	2,929	3,129	3,269	3,459	3,929	4,199	4,559	

\*Contact customer service for solid surface pricing of arm caps or back rail caps (on applicable models).

**KAS13B - Lounge Chair with 30" Wide Seat, 3.5" Arms & Boxed Back**

**Dimensions**

Overall			Seat				
W	D	H	W	D	H		
37.25	31.25	31.75	30	19.125	18.375	COM: 5.4 yds	
						Wt Cap: 750 lb	
						Unit Weight: 100 lb	
			Back H	Arm H			
			14.5	25.25			

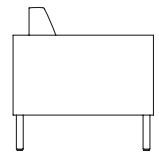
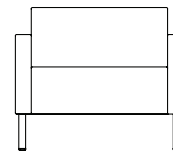

**KAS13BF with Fully Upholstered Arms**

COM	Dillon	Carson	A <sub>5</sub>	B <sub>6</sub>	C <sub>7</sub>	D <sub>8</sub>	E <sub>9</sub>	F <sub>10</sub>	G <sub>11</sub>	H <sub>12</sub>	I <sub>13</sub>
2,439	2,529	2,609	2,859	2,969	3,179	3,309	3,499	4,149	4,379	4,819	

**KAS13BA with Thermofoil Arm Caps and Back Rail Cap**

COM	Dillon	Carson	A <sub>5</sub>	B <sub>6</sub>	C <sub>7</sub>	D <sub>8</sub>	E <sub>9</sub>	F <sub>10</sub>	G <sub>11</sub>	H <sub>12</sub>	I <sub>13</sub>
2,549	2,599	2,709	2,999	3,099	3,289	3,429	3,629	4,249	4,639	5,059	

\*Contact customer service for solid surface pricing of arm caps or back rail caps (on applicable models).

**KAS18 - Lounge Chair with 30" Wide Seat, 8.5" Arms & Boxed Back**

**Dimensions**

Overall			Seat			COM: 5.4 yds Wt Cap: 750 lb Unit Weight: 89 lb
W	D	H	W	D	H	
37.25	31.25	31.75	30	19.125	18.375	
			Back H	Arm H		
			14.5	25.25		

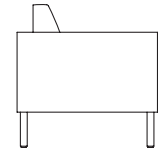
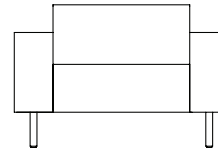

**KAS18F with Fully Upholstered Arms**

COM	Dillon	Carson	A <sub>5</sub>	B <sub>6</sub>	C <sub>7</sub>	D <sub>8</sub>	E <sub>9</sub>	F <sub>10</sub>	G <sub>11</sub>	H <sub>12</sub>	I <sub>13</sub>
2,499	2,539	2,669	2,939	3,039	3,239	3,359	3,549	4,319	4,639	5,059	

**KAS18A with Thermofoil Arm Caps and Back Rail Cap**

COM	Dillon	Carson	A <sub>5</sub>	B <sub>6</sub>	C <sub>7</sub>	D <sub>8</sub>	E <sub>9</sub>	F <sub>10</sub>	G <sub>11</sub>	H <sub>12</sub>	I <sub>13</sub>
2,649	2,699	2,819	3,099	3,219	3,379	3,539	3,709	4,469	4,759	5,209	

\*Contact customer service for solid surface pricing of arm caps or back rail caps (on applicable models).

**KAS20 - 2 Seat Lounge Chair with 3.5" Arms**

**Dimensions**

Overall			Seat			COM: 5.5 yds Wt Cap: 750 lb Unit Weight: 99 lb
W	D	H	W	D	H	
51	27.75	31.75	44.5	19.125	18.375	
			Back H	Arm H		
			14.5	25.25		

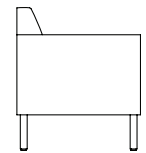
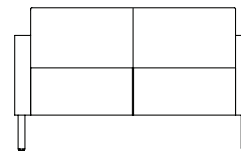

**KAS20F with Fully Upholstered Arms**

COM	Dillon	Carson	A <sub>5</sub>	B <sub>6</sub>	C <sub>7</sub>	D <sub>8</sub>	E <sub>9</sub>	F <sub>10</sub>	G <sub>11</sub>	H <sub>12</sub>	I <sub>13</sub>
3,019	3,099	3,259	3,629	3,809	4,079	4,299	4,569	4,619	4,889	5,339	

**KAS20A with Thermofoil Arm Caps**

COM	Dillon	Carson	A <sub>5</sub>	B <sub>6</sub>	C <sub>7</sub>	D <sub>8</sub>	E <sub>9</sub>	F <sub>10</sub>	G <sub>11</sub>	H <sub>12</sub>	I <sub>13</sub>
3,109	3,159	3,349	3,699	3,879	4,159	4,359	4,639	4,719	5,139	5,599	

\*Contact customer service for solid surface pricing of arm caps or back rail caps (on applicable models).

**KAS23 - 2 Seat Lounge Chair with 3.5" Arms & Boxed Back**

**Dimensions**

Overall			Seat			COM: 5.8 yds Wt Cap: 750 lb Unit Weight: 125 lb
W	D	H	W	D	H	
52	31.25	31.75	44.5	19.125	18.375	
Back H		Arm H				
14.5		25.25				

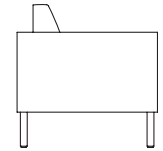
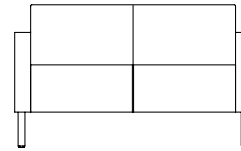

**KAS23F with Fully Upholstered Arms**

COM	Dillon	Carson	A <sub>5</sub>	B <sub>6</sub>	C <sub>7</sub>	D <sub>8</sub>	E <sub>9</sub>	F <sub>10</sub>	G <sub>11</sub>	H <sub>12</sub>	I <sub>13</sub>
3,489	3,529	3,679	4,079	4,199	4,399	4,619	4,849	5,039	5,409	5,839	

**KAS23A with Thermofoil Arm Caps and Back Rail Cap**

COM	Dillon	Carson	A <sub>5</sub>	B <sub>6</sub>	C <sub>7</sub>	D <sub>8</sub>	E <sub>9</sub>	F <sub>10</sub>	G <sub>11</sub>	H <sub>12</sub>	I <sub>13</sub>
3,649	3,659	3,819	4,169	4,389	4,599	4,739	5,019	5,229	5,619	6,099	

\*Contact customer service for solid surface pricing of arm caps or back rail caps (on applicable models).

**KAS28 - 2 Seat Lounge Chair with 8.5" Arms & Boxed Back**

**Dimensions**

Overall			Seat			COM: 6.5 yds Wt Cap: 750 lb Unit Weight: 133 lb
W	D	H	W	D	H	
64	31.25	31.75	44.5	19.125	18.375	
Back H		Arm H				
14.5		25.25				

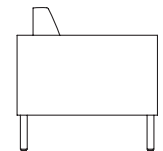
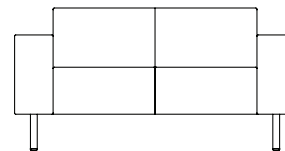

**KAS28F with Fully Upholstered Arms**

COM	Dillon	Carson	A <sub>5</sub>	B <sub>6</sub>	C <sub>7</sub>	D <sub>8</sub>	E <sub>9</sub>	F <sub>10</sub>	G <sub>11</sub>	H <sub>12</sub>	I <sub>13</sub>
3,539	3,589	3,719	4,109	4,269	4,459	4,649	4,909	4,989	5,409	5,929	

**KAS28A with Thermofoil Arm Caps and Back Rail Cap**

COM	Dillon	Carson	A <sub>5</sub>	B <sub>6</sub>	C <sub>7</sub>	D <sub>8</sub>	E <sub>9</sub>	F <sub>10</sub>	G <sub>11</sub>	H <sub>12</sub>	I <sub>13</sub>
3,699	3,799	3,879	4,229	4,439	4,649	4,789	5,049	5,109	5,629	6,099	

\*Contact customer service for solid surface pricing of arm caps or back rail caps (on applicable models).

**KAS30 - 3 Seat Lounge Chair with 3.5" Arms**

**Dimensions**

Overall			Seat		
W	D	H	W	D	H
74	27.75	31.75	66.5	19.125	18.375
			Back H	Arm H	
			14.5	25.25	

COM: 7.2 yds  
 Wt Cap: 1000 lb  
 Unit Weight: 123 lb

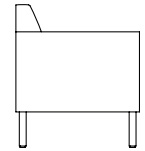
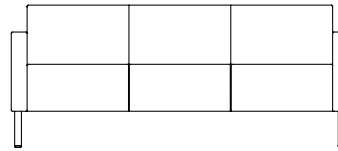

**KAS30F with Fully Upholstered Arms**

COM	Dillon	Carson	A <sub>5</sub>	B <sub>6</sub>	C <sub>7</sub>	D <sub>8</sub>	E <sub>9</sub>	F <sub>10</sub>	G <sub>11</sub>	H <sub>12</sub>	I <sub>13</sub>
3,779	3,859	4,079	4,589	4,689	5,119	5,389	5,699	5,829	6,299	6,899	

**KAS30A with Thermofoil Arm Caps**

COM	Dillon	Carson	A <sub>5</sub>	B <sub>6</sub>	C <sub>7</sub>	D <sub>8</sub>	E <sub>9</sub>	F <sub>10</sub>	G <sub>11</sub>	H <sub>12</sub>	I <sub>13</sub>
3,819	3,909	4,139	4,669	4,759	5,139	5,449	5,749	5,999	6,439	7,019	

\*Contact customer service for solid surface pricing of arm caps or back rail caps (on applicable models).

**KAS33 - 3 Seat Lounge Chair with 3.5" Arms & Boxed Back**

**Dimensions**

Overall			Seat		
W	D	H	W	D	H
74	31.25	31.75	66.75	19.125	18.375
			Back H	Arm H	
			14.5	25.25	

COM: 7.7 yds  
 Wt Cap: 1000 lb  
 Unit Weight: 152 lb

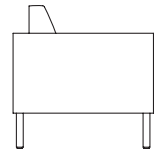
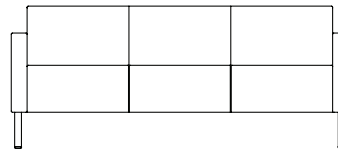

**KAS33F with Fully Upholstered Arms**

COM	Dillon	Carson	A <sub>5</sub>	B <sub>6</sub>	C <sub>7</sub>	D <sub>8</sub>	E <sub>9</sub>	F <sub>10</sub>	G <sub>11</sub>	H <sub>12</sub>	I <sub>13</sub>
4,209	4,239	4,499	4,969	5,179	5,499	5,799	6,149	6,299	6,699	7,279	

**KAS33A with Thermofoil Arm Caps and Back Rail Cap**

COM	Dillon	Carson	A <sub>5</sub>	B <sub>6</sub>	C <sub>7</sub>	D <sub>8</sub>	E <sub>9</sub>	F <sub>10</sub>	G <sub>11</sub>	H <sub>12</sub>	I <sub>13</sub>
4,349	4,399	4,639	5,129	5,339	5,659	5,939	6,289	6,429	6,819	7,539	

\*Contact customer service for solid surface pricing of arm caps or back rail caps (on applicable models).

**KAS38 - 3 Seat Lounge Chair with 8.5" Arms & Boxed Back**

**Dimensions**

Overall			Seat		
W	D	H	W	D	H
85	31.25	31.75	66.75	19.125	18.375
			Back H	Arm H	
			14.5	25.25	

COM: 8.4 yds  
 Wt Cap: 1000 lb  
 Unit Weight: 173 lb

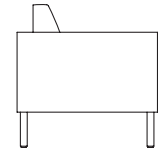
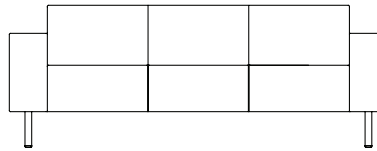

**KAS38F with Fully Upholstered Arms**

COM	Dillon	Carson	A <sub>5</sub>	B <sub>6</sub>	C <sub>7</sub>	D <sub>8</sub>	E <sub>9</sub>	F <sub>10</sub>	G <sub>11</sub>	H <sub>12</sub>	I <sub>13</sub>
4,259	4,299	4,539	5,029	5,229	5,579	5,899	6,189	6,469	6,819	7,539	

**KAS38A with Thermofoil Arm Caps and Back Rail Cap**

COM	Dillon	Carson	A <sub>5</sub>	B <sub>6</sub>	C <sub>7</sub>	D <sub>8</sub>	E <sub>9</sub>	F <sub>10</sub>	G <sub>11</sub>	H <sub>12</sub>	I <sub>13</sub>
4,439	4,479	4,709	5,229	5,419	5,739	6,049	6,359	6,619	6,939	7,539	

\*Contact customer service for solid surface pricing of arm caps or back rail caps (on applicable models).

# BEHAVIORAL HEALTH



## General Product Information

- Utilizes tamper-resistant hardware
- Sled-style base
- Passive Flex Back
- Seat clean-out
- Wall-saver leg design
- Arms connected by heavy steel rails
- Molded seat foam on 21" seats
- Back foam: 1.7 density foam that meets CAL 117 Fire Standards
- Comfort webbing in seats
- Field replaceable components

## To Order, Specify

- Model Number
- Textile
- Finish
- Options

## Available Options

FRAME OPTIONS *See pg 2 for finishes*  
 \*Default 540 Pewter finish. 211 Silver Frost available at no charge.

ARM CAP OPTIONS *See pg 2 for finishes*

- U Urethane Standard on specified models
- F Fully Upholstered Arms Standard on specified models

### ADDITIONAL FEATURES & OPTIONS

- M Additional Weight Specified models
- CAL CAL TB133 See pg 9
- Z Multi Cover Use Pricing for Highest Grade
- MB Moisture Barrier See pg 11

**KOT19 - Behavioral Health Chair**

**Dimensions**

Overall			Seat		
W	D	H	W	D	H
24.5	29.5	33.25	20.75	19.5	18.25
			Back H	Arm H	
			15	25.75	

COM: 1.7 yds  
 Wt Cap: 550 lb  
 Unit Weight: 62 lb

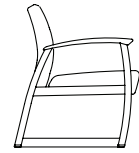
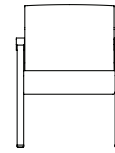

**KOT19U with Urethane Arm Caps**

COM	Dillon/Carson	A5	B6	C7	D8	E9	F10	G11	H12	I13
1,999	2,029	2,069	2,109	2,159	2,199	2,289	2,309	2,399	2,499	2,599

**KOT19-M - Behavioral Health Chair with Additional Weight**

**Dimensions**

Overall			Seat		
W	D	H	W	D	H
24.5	29.5	33.25	20.75	19.5	18.25
			Back H	Arm H	
			15	25.75	

COM: 1.7 yds  
 Wt Cap: 550 lb  
 Unit Weight: 96 lb

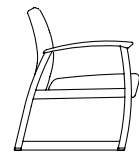
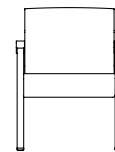

**KOT19UM with Urethane Arm Caps**

COM	Dillon/Carson	A5	B6	C7	D8	E9	F10	G11	H12	I13
2,369	2,389	2,399	2,489	2,549	2,559	2,639	2,669	2,759	2,809	2,869

**KOT29 - 2 Seat Behavioral Health Chair**

**Dimensions**

Overall			Seat		
W	D	H	W	D	H
45.5	29.5	33.25	42	19.5	18.25
			Back H	Arm H	
			15	25.75	

COM: 2.9 yds  
 Wt Cap: 750 lb  
 Unit Weight: 95 lb

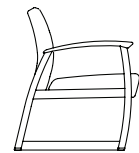
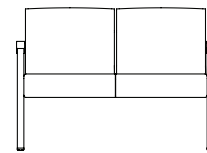

**KOT29U with Urethane Arm Caps**

COM	Dillon/Carson	A5	B6	C7	D8	E9	F10	G11	H12	I13
3,119	3,159	3,229	3,329	3,419	3,479	3,639	3,789	3,949	4,019	4,149

**KOT29I - 2 Seat Behavioral Health Chair with Intervening Arm**

**Dimensions**

Overall			Seat		
W	D	H	W	D	H
47	29.5	33.25	20.75	19.5	18.25
			Back H	Arm H	
			15	25.75	

**COM:** 3 yds  
**Wt Cap:** 750 lb  
**Unit Weight:** 110 lb

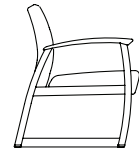
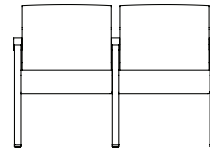

**KOT29IU with Urethane Arm Caps**

COM	Dillon/Carson	A <sub>5</sub>	B <sub>6</sub>	C <sub>7</sub>	D <sub>8</sub>	E <sub>9</sub>	F <sub>10</sub>	G <sub>11</sub>	H <sub>12</sub>	I <sub>13</sub>
3,729	3,759	3,829	4,019	4,149	4,169	4,369	4,449	4,649	4,659	4,669

**KOT39I - 3 Seat Behavioral Health Chair with Intervening Arms**

**Dimensions**

Overall			Seat		
W	D	H	W	D	H
69.5	29.5	33.25	20.75	19.5	18.25
			Back H	Arm H	
			15	25.75	

**COM:** 4.4 yds  
**Wt Cap:** 1000 lb  
**Unit Weight:** 159 lb

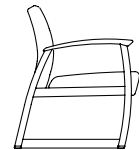
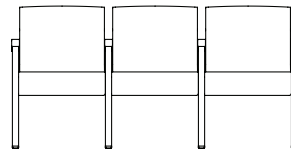

**KOT39IU with Urethane Arm Caps**

COM	Dillon/Carson	A <sub>5</sub>	B <sub>6</sub>	C <sub>7</sub>	D <sub>8</sub>	E <sub>9</sub>	F <sub>10</sub>	G <sub>11</sub>	H <sub>12</sub>	I <sub>13</sub>
5,129	5,269	5,379	5,459	5,669	5,739	5,989	6,119	6,409	6,439	6,499

**KOU19 - Behavioral Health Lounge Chair**

**Dimensions**

Overall			Seat			COM: 3.8 yds Wt Cap: 550 lb Unit Weight: 88 lb
W	D	H	W	D	H	
27.25	30	33.75	21.75	19	18	
Back H		Arm H				
15.75		25				

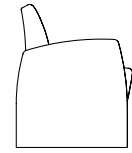
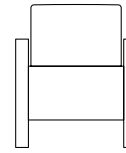

**KOU19F Standard with Fully Upholstered Arms**

COM	Dillon/Carson	A <sub>5</sub>	B <sub>6</sub>	C <sub>7</sub>	D <sub>8</sub>	E <sub>9</sub>	F <sub>10</sub>	G <sub>11</sub>	H <sub>12</sub>	I <sub>13</sub>
2,789	2,819	2,839	2,939	3,069	3,109	3,319	3,489	3,839	4,039	4,169

**KOU19-M - Behavioral Health Lounge Chair with Additional Weight**

**Dimensions**

Overall			Seat			COM: 3.8 yds Wt Cap: 550 lb Unit Weight: 123 lb
W	D	H	W	D	H	
27.25	30	33.75	21.75	19	18	
Back H		Arm H				
15.75		25				

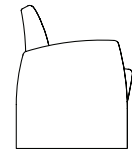
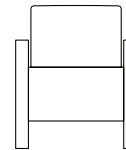

**KOU19FM Standard with Fully Upholstered Arms**

COM	Dillon/Carson	A <sub>5</sub>	B <sub>6</sub>	C <sub>7</sub>	D <sub>8</sub>	E <sub>9</sub>	F <sub>10</sub>	G <sub>11</sub>	H <sub>12</sub>	I <sub>13</sub>
3,169	3,189	3,209	3,299	3,419	3,469	3,659	3,839	4,169	4,309	4,449

**KOU29 - 2 Seat Behavioral Health Lounge Chair**

**Dimensions**

Overall			Seat			COM: 5.5 yds Wt Cap: 750 lb Unit Weight: 126 lb
W	D	H	W	D	H	
49.75	30	33.75	44	19	18	
Back H		Arm H				
15.75		25				

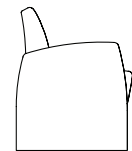
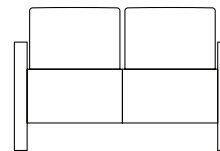

**KOU29F Standard with Fully Upholstered Arms**

COM	Dillon/Carson	A <sub>5</sub>	B <sub>6</sub>	C <sub>7</sub>	D <sub>8</sub>	E <sub>9</sub>	F <sub>10</sub>	G <sub>11</sub>	H <sub>12</sub>	I <sub>13</sub>
4,039	4,049	4,109	4,239	4,399	4,429	4,619	4,949	5,309	5,529	5,749

**KOU29I - 2 Seat Behavioral Health Lounge Chair with Intervening Arms**

**Dimensions**

Overall			Seat		
W	D	H	W	D	H
51.75	30	33.75	21.75	19	18
			Back H	Arm H	
			15.75	25	

**COM:** 6.6 yds  
**Wt Cap:** 750 lb  
**Unit Weight:** 152 lb

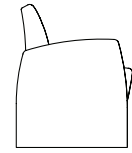
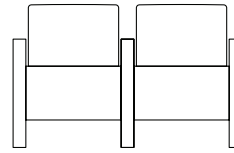

**KOU29IF Standard with Fully Upholstered Arms**

COM	Dillon/Carson	A <sub>5</sub>	B <sub>6</sub>	C <sub>7</sub>	D <sub>8</sub>	E <sub>9</sub>	F <sub>10</sub>	G <sub>11</sub>	H <sub>12</sub>	I <sub>13</sub>
4,859	4,889	4,909	5,169	5,449	5,569	5,809	6,179	6,829	6,879	7,049

**KOU39 - 3 Seat Behavioral Health Lounge Chair**

**Dimensions**

Overall			Seat		
W	D	H	W	D	H
71.75	30	33.75	66.5	19	18
			Back H	Arm H	
			15.75	25	

**COM:** 7.1 yds  
**Wt Cap:** 1000 lb  
**Unit Weight:** 161 lb

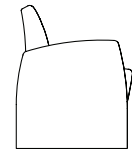
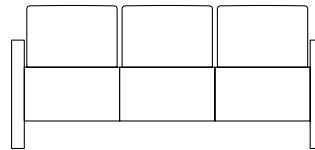

**KOU39F Standard with Fully Upholstered Arms**

COM	Dillon/Carson	A <sub>5</sub>	B <sub>6</sub>	C <sub>7</sub>	D <sub>8</sub>	E <sub>9</sub>	F <sub>10</sub>	G <sub>11</sub>	H <sub>12</sub>	I <sub>13</sub>
5,039	5,159	5,219	5,389	5,749	5,889	6,179	6,679	7,189	7,269	7,579

**KOU39I - 3 Seat Behavioral Health Lounge Chair with Intervening Arms**

**Dimensions**

Overall			Seat		
W	D	H	W	D	H
76.25	30	33.75	21.75	19	18
			Back H	Arm H	
			15.75	25	

**COM:** 9.3 yds  
**Wt Cap:** 1000 lb  
**Unit Weight:** 208 lb

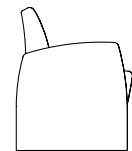
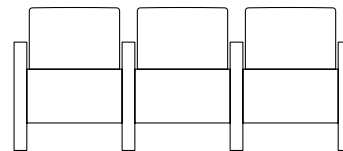

**KOU39IF Standard with Fully Upholstered Arms**

COM	Dillon/Carson	A <sub>5</sub>	B <sub>6</sub>	C <sub>7</sub>	D <sub>8</sub>	E <sub>9</sub>	F <sub>10</sub>	G <sub>11</sub>	H <sub>12</sub>	I <sub>13</sub>
6,519	6,649	6,779	6,979	7,379	7,639	8,059	8,549	9,399	9,429	9,799

**KMU19 - Behavioral Health Lounge Chair**

**Dimensions**

Overall			Seat		
W	D	H	W	D	H
27.25	30	33.75	21.75	19	18
		Back H			Arm H
		15.75			25.25

COM: 3.8 yds  
 Wt Cap: 550 lb  
 Unit Weight: 88 lb

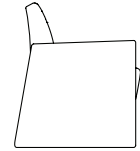
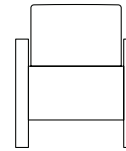

**KMU19F Standard with Fully Upholstered Arms**

COM	Dillon/Carson	A <sub>5</sub>	B <sub>6</sub>	C <sub>7</sub>	D <sub>8</sub>	E <sub>9</sub>	F <sub>10</sub>	G <sub>11</sub>	H <sub>12</sub>	I <sub>13</sub>
2,919	2,949	3,029	3,079	3,189	3,319	3,469	3,609	3,899	4,119	4,319

**KMU19-M - Behavioral Health Lounge Chair with Additional Weight**

**Dimensions**

Overall			Seat		
W	D	H	W	D	H
27.25	30	33.75	21.75	19	18
		Back H			Arm H
		15.75			25.25

COM: 3.8 yds  
 Wt Cap: 550 lb  
 Unit Weight: 123 lb

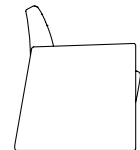
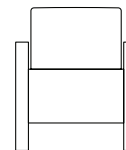

**KMU19FM Standard with Fully Upholstered Arms**

COM	Dillon/Carson	A <sub>5</sub>	B <sub>6</sub>	C <sub>7</sub>	D <sub>8</sub>	E <sub>9</sub>	F <sub>10</sub>	G <sub>11</sub>	H <sub>12</sub>	I <sub>13</sub>
3,299	3,319	3,349	3,439	3,559	3,619	3,809	3,999	4,349	4,489	4,639

**KMU29 - 2 Seat Behavioral Health Lounge Chair**

**Dimensions**

Overall			Seat		
W	D	H	W	D	H
49.75	30	33.75	44	19	18
		Back H			Arm H
		15.75			25.25

COM: 5.5 yds  
 Wt Cap: 750 lb  
 Unit Weight: 126 lb

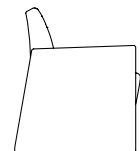
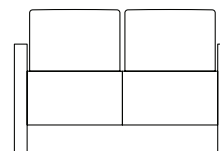

**KMU29F Standard with Fully Upholstered Arms**

COM	Dillon/Carson	A <sub>5</sub>	B <sub>6</sub>	C <sub>7</sub>	D <sub>8</sub>	E <sub>9</sub>	F <sub>10</sub>	G <sub>11</sub>	H <sub>12</sub>	I <sub>13</sub>
4,219	4,229	4,279	4,429	4,589	4,619	4,819	5,169	5,539	5,769	5,989

**KMU29I - 2 Seat Behavioral Health Lounge Chair with Intervening Arms**

**Dimensions**

Overall			Seat		
W	D	H	W	D	H
51.75	30	33.75	21.75	19	18
			Back H	Arm H	
			15.75	25.25	

**COM:** 6.6 yds  
**Wt Cap:** 750 lb  
**Unit Weight:** 152 lb

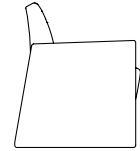
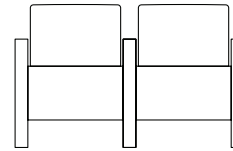

**KMU29IF Standard with Fully Upholstered Arms**

COM	Dillon/Carson	A <sub>5</sub>	B <sub>6</sub>	C <sub>7</sub>	D <sub>8</sub>	E <sub>9</sub>	F <sub>10</sub>	G <sub>11</sub>	H <sub>12</sub>	I <sub>13</sub>
5,069	5,099	5,119	5,399	5,689	5,809	6,059	6,439	7,129	7,169	7,359

**KMU39 - 3 Seat Behavioral Health Lounge Chair**

**Dimensions**

Overall			Seat		
W	D	H	W	D	H
71.75	30	33.75	66.5	19	18
			Back H	Arm H	
			15.75	25.25	

**COM:** 7.1 yds  
**Wt Cap:** 1000 lb  
**Unit Weight:** 161 lb

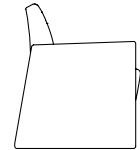
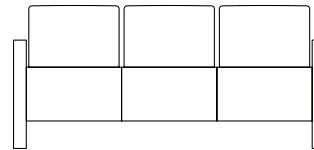

**KMU39F Standard with Fully Upholstered Arms**

COM	Dillon/Carson	A <sub>5</sub>	B <sub>6</sub>	C <sub>7</sub>	D <sub>8</sub>	E <sub>9</sub>	F <sub>10</sub>	G <sub>11</sub>	H <sub>12</sub>	I <sub>13</sub>
5,249	5,379	5,449	5,619	5,989	6,149	6,439	6,969	7,499	7,589	7,899

**KMU39I - 3 Seat Behavioral Health Lounge Chair with Intervening Arms**

**Dimensions**

Overall			Seat		
W	D	H	W	D	H
76.25	30	33.75	21.75	19	18
			Back H	Arm H	
			15.75	25.25	

**COM:** 9.3 yds  
**Wt Cap:** 1000 lb  
**Unit Weight:** 208 lb

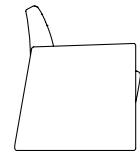
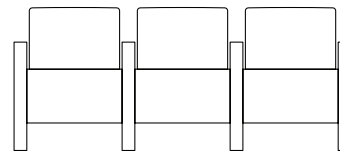

**KMU39IF Standard with Fully Upholstered Arms**

COM	Dillon/Carson	A <sub>5</sub>	B <sub>6</sub>	C <sub>7</sub>	D <sub>8</sub>	E <sub>9</sub>	F <sub>10</sub>	G <sub>11</sub>	H <sub>12</sub>	I <sub>13</sub>
6,799	6,929	7,069	7,279	7,699	7,969	8,399	8,919	9,809	9,829	10,219

# RECLINERS

350 Series	98
450 Series	114
Durable® Series Recliners	118
Durable® 550 Series	119
Option Guide	130
Durable® 650 Series	134
Durable® 750 Series	154
Durable® Power Series	164
Durable® Exam Lift Series	175



**How to Order**

The chart below is a guide to use in building a recliner model number for ordering. Base models and their available aesthetic styles and options are listed in the following sections of 350 Series and 450 Series recliners. Specify textiles and finishes, along with any additional options from the following pages. Recliner base pricing is determined by selected textile grade. Option prices for each base model are listed on individual product pages, along with availability.

	Aesthetic Style	Base Model	Arms	Multicover	Caster System
<b>EXAMPLE</b>	<b>K</b> Kure	<b>0107</b> Mobile Recliner	<b>J</b> Solid Surface Arm Caps	<b>Z</b> Multiple Covers Selected	<b>S</b> Two-Caster Lock & Steer
	<p><b>Denotes Back and Arm Design</b></p> <p>See individual product pages for available Aesthetic Styles.</p> <p>Products with limited aesthetic styles may include this letter with the base model number.</p>	<p><b>Denotes Base Functionality</b></p> <p>'C' in front of model number indicates 'Chaise Continuous Leg Support.'</p>	<p><b>Denotes Arm Cap Selection</b></p> <p>(F) Fully Upholstered Arms (no arm cap)</p> <p>(U) Urethane Arm Cap</p> <p>(J) Solid Surface Arm Cap</p>	<p><b>Denotes if Multiple Textiles Specified</b></p> <p>(Z) Multicover</p> <p>If entire unit is specified in a single textile, leave this space blank.</p>	<p><b>Denotes Caster System Selection</b></p> <p>(S) Two Caster Locking</p> <p>Not available on 350 Series models.</p> <p>If no caster system selected, leave this space blank. Casters that are not part of a two-caster locking system are able to be locked individually.</p>

**\*\* See individual product pages for availability of above options.\*\***

**350 Series Aesthetic Styles**

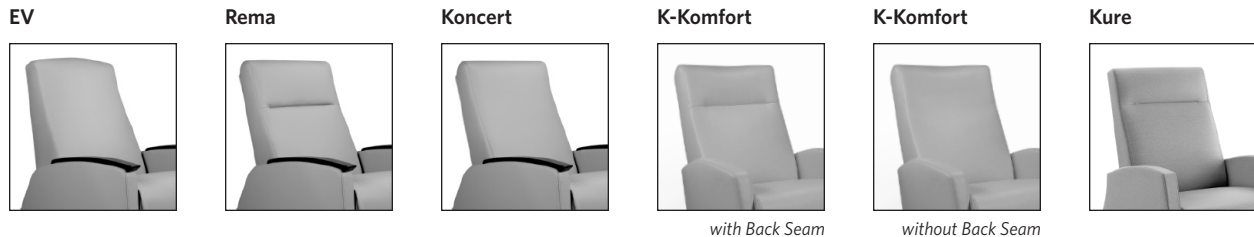

**450 Series Aesthetic Styles**

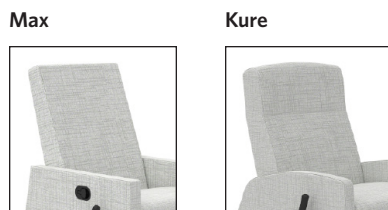

**Recliner Dimension Key**

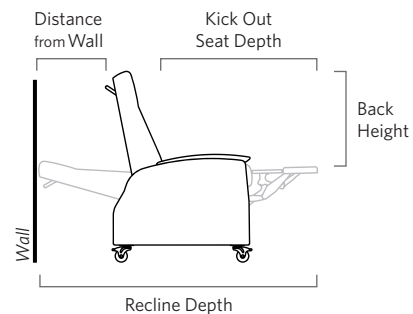

# 350 SERIES



## Series Overview

Boasting several different designs and functionalities, the 350 Series is one of our broadest categories. With products designed specifically for controlled environments, such as senior living, wellness rooms, or office lounges, the 350 Series offers Gliders, Power Recliners, Three Position Recliners, and more. The common thread among all 350 Series models is the trusted comfort we have come to be known for.

## General Product Information

- 350 lb Weight Rating
- Variety of stationary and mobile styles
- Power and manual operation styles
- Seat clean-out
- Field replaceable components

## Options vary by model, see specific model page for list of available options

Refer to pg 130 for full option details and images

## To Order, Specify

- Model Number
- Textile
- Finish
- Options

## Recommended Applications

	Long-Term Care & Assisted Living	Women's & Children's	Wellness Room	Doctor's Lounge	Home Health
Three Position Recliner			●	●	
Glider Recliner (Manual)	●	●	●	●	
Glider Recliner (Power)	●	●	●	●	
Body Weight Activated Glider	●	●	●	●	
Room Saver™ Recliner (Manual)	●				
Room Saver™ Recliner (Power)	●				
Room Saver™ Recliner (Power/Lift)	●				
Standard Recliner (Stationary Models)	●		●	●	
Standard Recliner (Mobile Models)	●				
K-Komfort Recliners	●		●	●	●

\*For recliners designed for acute care and other "uncontrolled" healthcare applications, refer to Durable® series:

- Durable® 550 - Rocker Recliner
- Durable® 650 - Mobile
- Durable® 750 - Bariatric Mobile
- Durable® Power - Power/Lift Assist
- Durable® Exam Lift - Exam Lift

# 350 SERIES

# Three Position Recliner

Select Aesthetic Style (Denotes back & arm design)

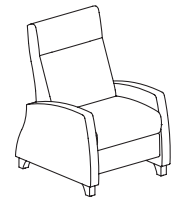
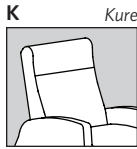

Select Functional Style (Aesthetic style code precedes selected model number below, e.g., RC1306)

**0017 Kure Three Position Recliner**

COM	Dillon/Carson	A <sub>5</sub>	B <sub>6</sub>	C <sub>7</sub>	D <sub>8</sub>	E <sub>9</sub>	F <sub>10</sub>	G <sub>11</sub>	H <sub>12</sub>	I <sub>13</sub>
3,419	3,459	3,579	3,619	3,729	3,869	4,039	4,219	4,379	4,639	4,889

### Dimensions

	Overall			Seat			Back H	Arm H	Kick Out Seat D	Recline D	Distance from Wall
	W	D	H	W	D	H					
K0017	28	37.5	44	22.5	20.5	19	23.5	25.5	41	67	17

**General Info**

COM: 4.6 yds

Wt Cap: 350 lb

Unit Weight: 97 lb

### Available Options

<p><b>ARM CAP OPTIONS</b></p> <p>F Fully Upholstered Arms Standard</p> <p>U Urethane 209</p> <p>J1 Solid Surface - Group 1 619</p> <p>J2 Solid Surface - Group 2 819</p> <p><b>CASTER &amp; BASE OPTIONS</b></p> <p>CASTER 3" - Locking Casters 199</p> <p>WF Wood Legs Standard</p> <p><b>ADDITIONAL FEATURES &amp; OPTIONS</b></p> <p>CAL CAL TB133 See pg 9</p> <p>Z Multi Cover Use Pricing for Highest Grade</p> <p>EG Protective Edge Guard Standard</p>	<p>See pg 2 for finishes</p> <p><b>PATIENT WELLNESS &amp; COMFORT OPTIONS</b></p> <p>MBB Moisture Barrier (Back) 59</p> <p>MBS Moisture Barrier (Seat) 59</p> <p><b>TRAY TABLE OPTIONS</b></p> <table border="1" style="margin-left: auto; margin-right: auto;"> <thead> <tr> <th rowspan="2"></th> <th colspan="2">Solid Surface Trays*</th> </tr> <tr> <th>Grp 1</th> <th>Grp 2</th> </tr> </thead> <tbody> <tr> <td>LFSTR Large Folding (Right) Side Tray<sup>2,4</sup></td> <td>269</td> <td>739 959</td> </tr> <tr> <td>LFSTRCH Large Folding Cup Holder (Right) Side Tray<sup>2,4</sup></td> <td>339</td> <td>849 1099</td> </tr> <tr> <td>PLFSTR Padded Large Folding (Right) Side Tray<sup>2,4</sup></td> <td>379</td> <td>n/a n/a</td> </tr> <tr> <td>SFSTR Small Folding (Right) Side Tray<sup>2,4</sup></td> <td>269</td> <td>689 889</td> </tr> </tbody> </table> <p style="text-align: right; font-size: small;">*Finishes on pg 2</p>		Solid Surface Trays*		Grp 1	Grp 2	LFSTR Large Folding (Right) Side Tray <sup>2,4</sup>	269	739 959	LFSTRCH Large Folding Cup Holder (Right) Side Tray <sup>2,4</sup>	339	849 1099	PLFSTR Padded Large Folding (Right) Side Tray <sup>2,4</sup>	379	n/a n/a	SFSTR Small Folding (Right) Side Tray <sup>2,4</sup>	269	689 889
	Solid Surface Trays*																	
	Grp 1	Grp 2																
LFSTR Large Folding (Right) Side Tray <sup>2,4</sup>	269	739 959																
LFSTRCH Large Folding Cup Holder (Right) Side Tray <sup>2,4</sup>	339	849 1099																
PLFSTR Padded Large Folding (Right) Side Tray <sup>2,4</sup>	379	n/a n/a																
SFSTR Small Folding (Right) Side Tray <sup>2,4</sup>	269	689 889																

\*Refer to pg 130 for full option details and images\*

<sup>2</sup>Standard on right side (facing). Replace "R" with "L" for left side (facing) option where available.

<sup>4</sup>Contact customer service for solid surface pricing

# 350 SERIES

# Glider Recliner | Manual

## Select Aesthetic Style (Denotes back & arm design)

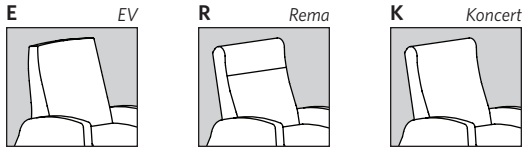

(Koncert style pictured)

## Select Functional Style (Aesthetic style code precedes selected model number below, e.g., RC1306)

### C1306 Chaise Glider Recliner

COM	Dillon/Carson	A <sub>5</sub>	B <sub>6</sub>	C <sub>7</sub>	D <sub>8</sub>	E <sub>9</sub>	F <sub>10</sub>	G <sub>11</sub>	H <sub>12</sub>	I <sub>13</sub>
3,739	3,839	3,899	4,099	4,329	4,539	4,709	4,929	5,189	5,499	5,729

## Dimensions

	Overall			Seat			Back H	Arm H	Kick Out Seat D	Recline D	Distance from Wall
	W	D	H	W	D	H					
EC1306	30.75	35.25	42	22.25	20.75	18.5	24.25	24.25	36.75	64.25	16.25
RC1306	30.75	35.25	42	22.25	20.75	18.5	24.25	24.25	36.75	64.25	16.25
KC1306	30.75	35.25	42	22.25	20.75	18.5	24.25	24.25	36.75	64.25	16.25

**General Info**  
**COM:** 4.8 yds  
**Wt Cap:** 350 lb  
**Unit Weight:** 93 lb

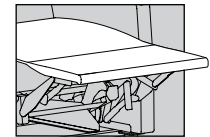

Chaise Continuous Leg Support

## Available Options

### ARM CAP OPTIONS

See pg 2 for finishes

F	Fully Upholstered Arms	Standard
U	Urethane	209
J1	Solid Surface - Group 1	619
J2	Solid Surface - Group 2	819

### PATIENT WELLNESS & COMFORT OPTIONS

MBB	Moisture Barrier (Back)	59
MBS	Moisture Barrier (Seat)	59

### ADDITIONAL FEATURES & OPTIONS

CAL	CAL TB133	See pg 9
Z	Multi Cover	Use Pricing for Highest Grade

\*Refer to pg 130 for full option details and images\*

# 350 SERIES

# Glider Recliner | Power

## Select Aesthetic Style (Denotes back & arm design)

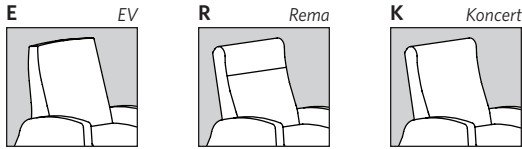

(Koncert style pictured)

## Select Functional Style (Aesthetic style code precedes selected model number below, e.g., RC1306)

### CFO1N0 Power Chaise Glider Recliner

COM	Dillon/Carson	A <sub>5</sub>	B <sub>6</sub>	C <sub>7</sub>	D <sub>8</sub>	E <sub>9</sub>	F <sub>10</sub>	G <sub>11</sub>	H <sub>12</sub>	I <sub>13</sub>
3,699	3,789	3,959	4,089	4,219	4,339	4,489	4,699	4,909	5,219	5,569

## Dimensions

	Overall			Seat			Back H	Arm H	Kick Out Seat D	Recline D	Distance from Wall
	W	D	H	W	D	H					
ECF01N0	28.5	36	39.25	22.25	21	18.25	24	25.5	37	65	15
RCF01N0	28.5	36	39.25	22.25	21	18.25	24	25.5	37	65	15
KCF01N0	28.5	36	39.25	22.25	21	18.25	24	25.5	37	65	15

**General Info**  
 COM: 4.8 yds  
 Wt Cap: 350 lb  
 Unit Weight: 104 lb

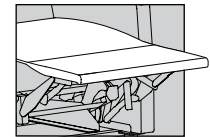

Chaise Continuous Leg Support

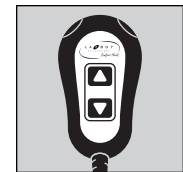

Power Recliner Wand

## Available Options

### ARM CAP OPTIONS

See pg 2 for finishes

F	Fully Upholstered Arms	Standard
U	Urethane	209
J1	Solid Surface - Group 1	619
J2	Solid Surface - Group 2	819

### PATIENT WELLNESS & COMFORT OPTIONS

MBB	Moisture Barrier (Back)	59
MBS	Moisture Barrier (Seat)	59

### ADDITIONAL FEATURES & OPTIONS

CAL	CAL TB133	See pg 9
Z	Multi Cover	Use Pricing for Highest Grade

\*Refer to pg 130 for full option details and images\*

# 350 SERIES

# Body Weight Activated Glider

Select Aesthetic Style (Denotes back & arm design)

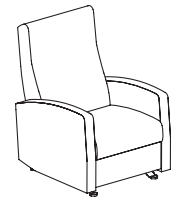
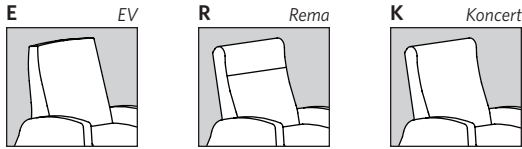

(Koncert style pictured)

Select Functional Style (Aesthetic style code precedes selected model number below, e.g., RC1306)

### 1716 Body Weight Activated Glider

COM	Dillon/Carson	A <sub>5</sub>	B <sub>6</sub>	C <sub>7</sub>	D <sub>8</sub>	E <sub>9</sub>	F <sub>10</sub>	G <sub>11</sub>	H <sub>12</sub>	I <sub>13</sub>
3,009	3,099	3,179	3,269	3,359	3,549	3,759	3,959	4,229	4,559	4,839

### Dimensions

	Overall			Seat			Back H	Arm H	Distance from Wall
	W	D	H	W	D	H			
E1716	30.25	34	42.5	22	21	18.75	27.5	25	12
R1716	30.25	34	42.5	22	21	18.75	26.5	25	12
K1716	30.25	34	42.5	22	21	18.75	26.5	25	12

**General Info**  
 COM: 4.6 yds  
 Wt Cap: 350 lb  
 Unit Weight: 89 lb

### Available Options

#### ARM CAP OPTIONS

See pg 2 for finishes

F	Fully Upholstered Arms	Standard
U	Urethane	209
J1	Solid Surface - Group 1	619
J2	Solid Surface - Group 2	819

#### PATIENT WELLNESS & COMFORT OPTIONS

MBB	Moisture Barrier (Back)	59
MBS	Moisture Barrier (Seat)	59

#### ADDITIONAL FEATURES & OPTIONS

CAL	CAL TB133	See pg 9
Z	Multi Cover	Use Pricing for Highest Grade

\*Refer to pg 130 for full option details and images\*

### GOT00 Gliding Ottoman (designed to complement 1716 style gliders only)

COM	Dillon/Carson	A <sub>5</sub>	B <sub>6</sub>	C <sub>7</sub>	D <sub>8</sub>	E <sub>9</sub>	F <sub>10</sub>	G <sub>11</sub>	H <sub>12</sub>	I <sub>13</sub>
959	969	989	1,029	1,059	1,099	1,189	1,239	1,309	1,389	1,479

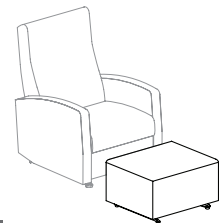

### Dimensions

W	Overall	
	D	H
23.25	19.25	14.75

**General Info**  
 COM: 1.6 yds  
 Unit Weight: 29 lb

# 350 SERIES

# Room Saver™ Recliner | Manual

## Select Aesthetic Style (Denotes back & arm design)

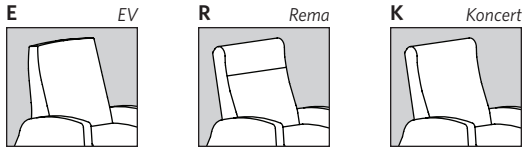

(Koncert style pictured)

## Select Functional Style (Aesthetic style code precedes selected model number below, e.g., RC1306)

### C1304 Room Saver™ Chaise Recliner

COM	Dillon/Carson	A <sub>5</sub>	B <sub>6</sub>	C <sub>7</sub>	D <sub>8</sub>	E <sub>9</sub>	F <sub>10</sub>	G <sub>11</sub>	H <sub>12</sub>	I <sub>13</sub>
3,329	3,399	3,499	3,649	3,829	3,979	4,239	4,489	4,719	4,939	5,169

## Dimensions

	Overall			Seat			Back H	Arm H	Kick Out Seat D	Recline D	Distance from Wall
	W	D	H	W	D	H					
EC1304	30.75	34.25	38.5	22.25	20	17.25	24	23.75	37.75	66.5	6
RC1304	30.75	34.25	38.5	22.25	20	17.25	24	23.75	37.75	66.5	6
KC1304	30.75	34.25	38.5	22.25	20	17.75	24	23.75	37.75	66.5	6

**General Info**  
**COM:** 4.8 yds  
**Wt Cap:** 350 lb  
**Unit Weight:** 82 lb

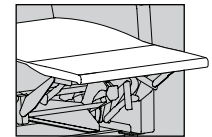

Chaise Continuous Leg Support

## Available Options

### ARM CAP OPTIONS

See pg 2 for finishes

F	Fully Upholstered Arms	Standard
U	Urethane	209
J1	Solid Surface - Group 1	619
J2	Solid Surface - Group 2	819

### CASTER & BASE OPTIONS

LRSP	Large Room Saver™ Platform (adds 1" to height)	139
------	--	-----

### ADDITIONAL FEATURES & OPTIONS

CAL	CAL TB133	See pg 9
Z	Multi Cover	Use Pricing for Highest Grade

### PATIENT WELLNESS & COMFORT OPTIONS

MBB	Moisture Barrier (Back)	59
MBS	Moisture Barrier (Seat)	59

\*Refer to pg 130 for full option details and images\*

# 350 SERIES

# Room Saver™ Recliner | Power

Select Aesthetic Style (Denotes back & arm design)

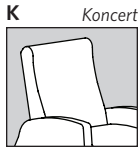

Select Functional Style (Aesthetic style code precedes selected model number below, e.g., RC1306)

### C1P04 Power Room Saver™ Chaise Recliner

COM	Dillon/Carson	A <sub>5</sub>	B <sub>6</sub>	C <sub>7</sub>	D <sub>8</sub>	E <sub>9</sub>	F <sub>10</sub>	G <sub>11</sub>	H <sub>12</sub>	I <sub>13</sub>
3,939	3,989	4,189	4,349	4,489	4,669	4,879	5,189	5,309	5,499	5,679

### Dimensions

	Overall			Seat			Back H	Arm H	Kick Out Seat D	Recline D	Distance from Wall
	W	D	H	W	D	H					
KC1P04	30.75	34.25	38	22.25	20	17.25	23.5	23.75	37.75	65.5	5

**General Info**  
 COM: 4.8 yds  
 Wt Cap: 350 lb  
 Unit Weight: 84 lb

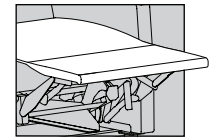

Chaise Continuous Leg Support

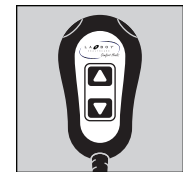

Power Recliner Wand

### Available Options

#### ARM CAP OPTIONS

See pg 2 for finishes

F	Fully Upholstered Arms	Standard
U	Urethane	209
J1	Solid Surface - Group 1	619
J2	Solid Surface - Group 2	819

#### CASTER & BASE OPTIONS

LRSP	Large Room Saver™ Platform (adds 1" to height)	139
------	--	-----

#### ADDITIONAL FEATURES & OPTIONS

CAL	CAL TB133	See pg 9
Z	Multi Cover	Use Pricing for Highest Grade

#### PATIENT WELLNESS & COMFORT OPTIONS

MBB	Moisture Barrier (Back)	59
MBS	Moisture Barrier (Seat)	59

\*Refer to pg 130 for full option details and images\*

# 350 SERIES

# Room Saver™ Recliner | Power & Lift

## Select Aesthetic Style (Denotes back & arm design)

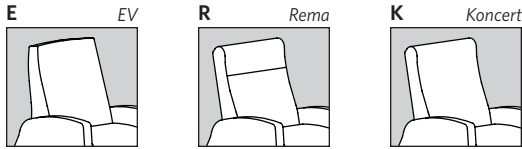

(Koncert style pictured)

## Select Functional Style (Aesthetic style code precedes selected model number below, e.g., RC1306)

### CH02NO Power & Lift Room Saver™ Chaise Recliner

COM	Dillon/Carson	A <sub>5</sub>	B <sub>6</sub>	C <sub>7</sub>	D <sub>8</sub>	E <sub>9</sub>	F <sub>10</sub>	G <sub>11</sub>	H <sub>12</sub>	I <sub>13</sub>
3,939	3,989	4,039	4,179	4,399	4,529	4,779	5,029	5,109	5,389	5,679

## Dimensions

	Overall			Seat			Back H	Arm H	Kick Out Seat D	Recline D	Distance from Wall
	W	D	H	W	D	H					
ECH02NO	30.75	34.25	39.5	22.25	20	17.25	23.5	23.75	38	65.5	5
RCH02NO	30.75	34.25	39.5	22.25	20	17.25	23.5	23.75	38	65.5	5
KCH02NO	30.75	34.25	39.5	22.25	20	17.25	23.5	23.75	38	65.5	5

**General Info**  
 COM: 4.8 yds  
 Wt Cap: 350 lb  
 Unit Weight: 120 lb

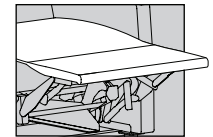

Chaise Continuous Leg Support

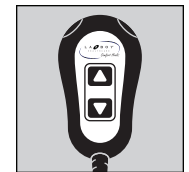

Power Recliner Wand

## Available Options

### ARM CAP OPTIONS

See pg 2 for finishes

F	Fully Upholstered Arms	Standard
U	Urethane	209
J1	Solid Surface - Group 1	619
J2	Solid Surface - Group 2	819

### PATIENT WELLNESS & COMFORT OPTIONS

MBB	Moisture Barrier (Back)	59
MBS	Moisture Barrier (Seat)	59

### ADDITIONAL FEATURES & OPTIONS

CAL	CAL TB133	See pg 9
Z	Multi Cover	Use Pricing for Highest Grade

\*Refer to pg 130 for full option details and images\*

# 350 SERIES

# Standard Recliner | Stationary Power

## Select Aesthetic Style (Denotes back & arm design)

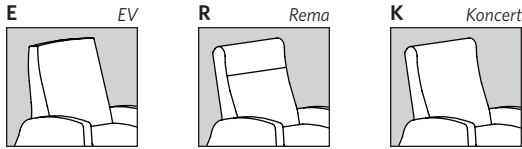

(Koncert style pictured)

## Select Functional Style (Aesthetic style code precedes selected model number below, e.g., RC1306)

### CE17NO Standard Stationary Power Chaise Recliner

COM	Dillon/Carson	A <sub>5</sub>	B <sub>6</sub>	C <sub>7</sub>	D <sub>8</sub>	E <sub>9</sub>	F <sub>10</sub>	G <sub>11</sub>	H <sub>12</sub>	I <sub>13</sub>
3,699	3,789	3,909	4,059	4,189	4,299	4,459	4,659	4,869	5,169	5,519

## Dimensions

	Overall			Seat			Back H	Arm H	Kick Out Seat D	Recline D	Distance from Wall
	W	D	H	W	D	H					
ECE17NO	28.5	36	41.5	22.25	21	19	24	25.5	37	66	15.5
RCE17NO	28.5	36	41.5	22.25	21	19	24	25.5	37	66	15.5
KCE17NO	28.5	36	41.5	22.25	21	19	24	25.5	37	66	15.5

**General Info**  
 COM: 4.8 yds  
 Wt Cap: 350 lb  
 Unit Weight: 102 lb

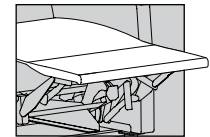

Chaise Continuous Leg Support

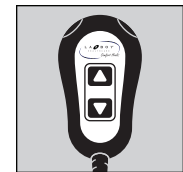

Power Recliner Wand

## Available Options

### ARM CAP OPTIONS

See pg 2 for finishes

F	Fully Upholstered Arms	Standard
U	Urethane	209
J1	Solid Surface - Group 1	619
J2	Solid Surface - Group 2	819

### PATIENT WELLNESS & COMFORT OPTIONS

MBB	Moisture Barrier (Back)	59
MBS	Moisture Barrier (Seat)	59

### ADDITIONAL FEATURES & OPTIONS

CAL	CAL TB133	See pg 9
Z	Multi Cover	Use Pricing for Highest Grade

\*Refer to pg 130 for full option details and images\*

# 350 SERIES

# Standard Recliner | Mobile Power

## Select Aesthetic Style (Denotes back & arm design)

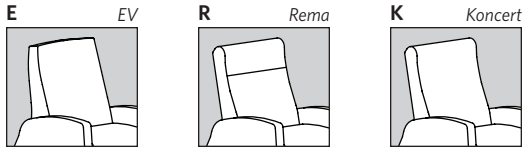

(Koncert style pictured)

## Select Functional Style (Aesthetic style code precedes selected model number below, e.g., RC1306)

### CE00NO **Standard Mobile Power Chaise Recliner**

COM	Dillon/Carson	A <sub>5</sub>	B <sub>6</sub>	C <sub>7</sub>	D <sub>8</sub>	E <sub>9</sub>	F <sub>10</sub>	G <sub>11</sub>	H <sub>12</sub>	I <sub>13</sub>
3,929	4,009	4,169	4,299	4,459	4,509	4,709	4,879	5,039	5,389	5,729

## Dimensions

	Overall			Seat			Back H	Arm H	Kick Out Seat D	Recline D	Distance from Wall
	W	D	H	W	D	H					
ECE00NO	28.5	36	42.5	22.25	21	20.5	24	28	37	66.5	18
RCE00NO	28.5	36	42.5	22.25	21	20.5	24	28	37	66.5	18
KCE00NO	28.5	36	42.5	22.25	21	20.5	24	28	37	66.5	18

**General Info**  
 COM: 4.8 yds  
 Wt Cap: 350 lb  
 Unit Weight: 115 lb

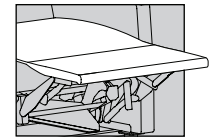

Chaise Continuous Leg Support

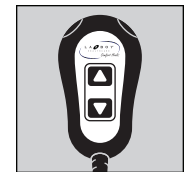

Power Recliner Wand

## Available Options

### ARM CAP OPTIONS

See pg 2 for finishes

F	Fully Upholstered Arms	Standard
U	Urethane	209
J1	Solid Surface - Group 1	619
J2	Solid Surface - Group 2	819

### CASTER & BASE OPTIONS

3S1R3	3" - (3) Swivel/(1) Rigid Locking Casters	Standard
3S4	3" - (4) Swivel Locking Casters	19

### ADDITIONAL FEATURES & OPTIONS

CAL	CAL TB133	See pg 9
Z	Multi Cover	Use Pricing for Highest Grade

### PATIENT WELLNESS & COMFORT OPTIONS

MBB	Moisture Barrier (Back)	59
MBS	Moisture Barrier (Seat)	59

\*Refer to pg 130 for full option details and images\*

# 350 SERIES

# Standard Recliner | Stationary Manual

## Select Aesthetic Style (Denotes back & arm design)

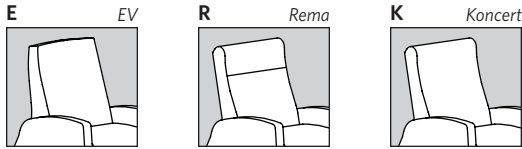

(Koncert style pictured)

## Select Functional Style (Aesthetic style code precedes selected model number below, e.g., RC1306)

### CD17N0 **Standard Stationary Manual Chaise Recliner**

COM	Dillon/Carson	A <sub>5</sub>	B <sub>6</sub>	C <sub>7</sub>	D <sub>8</sub>	E <sub>9</sub>	F <sub>10</sub>	G <sub>11</sub>	H <sub>12</sub>	I <sub>13</sub>
3,219	3,319	3,469	3,579	3,709	3,829	3,989	4,169	4,389	4,729	5,039

## Dimensions

	Overall			Seat			Back H	Arm H	Kick Out Seat D	Recline D	Distance from Wall
	W	D	H	W	D	H					
ECD17N0	30.75	36	41.5	22.25	21	19	24	25.5	37	66	15.5
RCD17N0	30.75	36	41.5	22.25	21	19	24	25.5	37	66	15.5
KCD17N0	30.75	36	41.5	22.25	21	19	24	25.5	37	66	15.5

**General Info**  
 COM: 4.8 yds  
 Wt Cap: 350 lb  
 Unit Weight: 92 lb

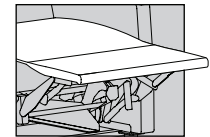

Chaise Continuous Leg Support

## Available Options

### ARM CAP OPTIONS

See pg 2 for finishes

F	Fully Upholstered Arms	Standard
U	Urethane	209
J1	Solid Surface - Group 1	619
J2	Solid Surface - Group 2	819

### PATIENT WELLNESS & COMFORT OPTIONS

MBB	Moisture Barrier (Back)	59
MBS	Moisture Barrier (Seat)	59

### ADDITIONAL FEATURES & OPTIONS

CAL	CAL TB133	See pg 9
Z	Multi Cover	Use Pricing for Highest Grade

\*Refer to pg 130 for full option details and images\*

# 350 SERIES

# Standard Recliner | Mobile Manual

## Select Aesthetic Style (Denotes back & arm design)

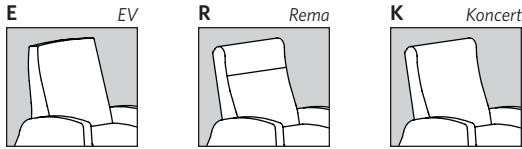

(Koncert style pictured)

## Select Functional Style (Aesthetic style code precedes selected model number below, e.g., RC1306)

### CD00NO *Standard Mobile Manual Chaise Recliner*

COM	Dillon/Carson	A <sub>5</sub>	B <sub>6</sub>	C <sub>7</sub>	D <sub>8</sub>	E <sub>9</sub>	F <sub>10</sub>	G <sub>11</sub>	H <sub>12</sub>	I <sub>13</sub>
3,639	3,729	3,849	3,959	4,139	4,239	4,369	4,559	4,789	5,119	5,459

## Dimensions

	Overall			Seat			Back H	Arm H	Kick Out Seat D	Recline D	Distance from Wall
	W	D	H	W	D	H					
EC00NO	30.75	36	42.5	22.25	21	20.5	24	28	37	66.5	18
RCD00NO	30.75	36	42.5	22.25	21	20.5	24	28	37	66.5	18
KCD00NO	30.75	36	42.5	22.25	21	20.5	24	28	37	66.5	18

**General Info**

COM: 4.8 yds

Wt Cap: 350 lb

Unit Weight: 105 lb

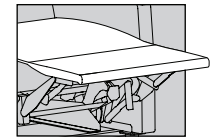

Chaise Continuous Leg Support

## Available Options

### ARM CAP OPTIONS

See pg 2 for finishes

F	Fully Upholstered Arms	Standard
U	Urethane	209
J1	Solid Surface - Group 1	619
J2	Solid Surface - Group 2	819

### CASTER & BASE OPTIONS

3S1R3	3" - (3) Swivel/(1) Rigid Locking Casters	Standard
3S4	3" - (4) Swivel Locking Casters	19

### ADDITIONAL FEATURES & OPTIONS

CAL	CAL TB133	See pg 9
Z	Multi Cover	Use Pricing for Highest Grade

### PATIENT WELLNESS & COMFORT OPTIONS

MBB	Moisture Barrier (Back)	59
MBS	Moisture Barrier (Seat)	59

\*Refer to pg 130 for full option details and images\*

Select Aesthetic Style (Denotes back & arm design)

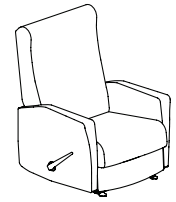
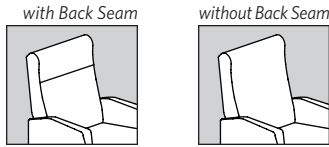

Select Functional Style

**KC8004 K-Komfort Room Saver™ Chaise Recliner with Back Seam**

COM	Dillon	Carson	A <sub>5</sub>	B <sub>6</sub>	C <sub>7</sub>	D <sub>8</sub>	E <sub>9</sub>	F <sub>10</sub>	G <sub>11</sub>	H <sub>12</sub>	I <sub>13</sub>
2,819	2,889	3,019	3,179	3,279	3,409	3,599	3,849	4,159	4,429	4,669	

**KC8014 K-Komfort Room Saver™ Chaise Recliner**

COM	Dillon	Carson	A <sub>5</sub>	B <sub>6</sub>	C <sub>7</sub>	D <sub>8</sub>	E <sub>9</sub>	F <sub>10</sub>	G <sub>11</sub>	H <sub>12</sub>	I <sub>13</sub>
2,709	2,779	2,939	3,079	3,189	3,339	3,489	3,739	3,999	4,309	4,579	

Dimensions

	Overall			Seat			Back H	Arm H	Kick Out Seat D	Recline D	Distance from Wall
	W	D	H	W	D	H					
KC8004   KC8014	32	35	40.5	23	21	18	27.5	23.5	37	64	6

**General Info**  
 COM: 5 yds  
 Wt Cap: 350 lb  
 Unit  
 Weight: 86 lb

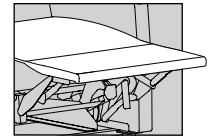

Chaise Continuous Leg Support

Available Options

ARM OPTIONS

F Fully Upholstered Arms Standard

BASE OPTIONS

LRSP Large Room Saver™ Platform (adds 1" to height) 139

ADDITIONAL FEATURES & OPTIONS

CAL CAL TB133 See pg 9  
 Z Multi Cover Use Pricing for Highest Grade  
 MBB Moisture Barrier (Back) 59  
 MBS Moisture Barrier (Seat) 59

Select Aesthetic Style (Denotes back & arm design)

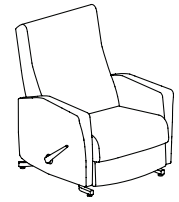
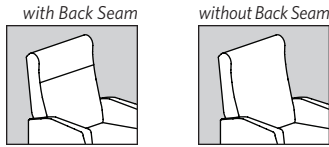

Select Functional Style

**KC8006 K-Komfort Glider Chaise Recliner with Back Seam**

COM	Dillon	Carson	A <sub>5</sub>	B <sub>6</sub>	C <sub>7</sub>	D <sub>8</sub>	E <sub>9</sub>	F <sub>10</sub>	G <sub>11</sub>	H <sub>12</sub>	I <sub>13</sub>
3,059	3,089	3,269	3,409	3,499	3,649	3,809	4,069	4,329	4,539	4,719	

**KC8016 K-Komfort Glider Chaise Recliner**

COM	Dillon	Carson	A <sub>5</sub>	B <sub>6</sub>	C <sub>7</sub>	D <sub>8</sub>	E <sub>9</sub>	F <sub>10</sub>	G <sub>11</sub>	H <sub>12</sub>	I <sub>13</sub>
2,979	3,059	3,189	3,319	3,459	3,609	3,749	4,019	4,259	4,539	4,719	

Dimensions

	Overall			Seat			Back H	Arm H	Kick Out Seat D	Recline D	Distance from Wall
	W	D	H	W	D	H					
KC8006   KC8016	32	36	40.5	23	21	18.5	27.5	24.5	37	64	16.5

**General Info**  
 COM: 5 yds  
 Wt Cap: 350 lb  
 Unit  
 Weight: 92 lb

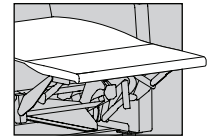

Chaise Continuous Leg Support

Available Options

ARM OPTIONS

F	Fully Upholstered Arms	Standard
---	------------------------	----------

ADDITIONAL FEATURES & OPTIONS

CAL	CAL TB133	See pg 9
Z	Multi Cover	Use Pricing for Highest Grade
MBB	Moisture Barrier (Back)	59
MBS	Moisture Barrier (Seat)	59

### Select Aesthetic Style (Denotes back & arm design)

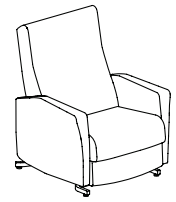
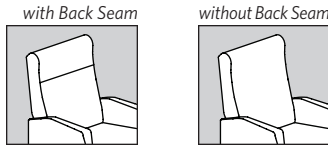

### Select Functional Style

#### KC8P04 K-Komfort Room Saver™ Power Chaise Recliner with Back Seam

COM	Dillon	Carson	A <sub>5</sub>	B <sub>6</sub>	C <sub>7</sub>	D <sub>8</sub>	E <sub>9</sub>	F <sub>10</sub>	G <sub>11</sub>	H <sub>12</sub>	I <sub>13</sub>
3,709	3,739	3,909	4,039	4,149	4,259	4,449	4,719	4,819	5,039	5,259	

#### KC8P14 K-Komfort Room Saver™ Power Chaise Recliner

COM	Dillon	Carson	A <sub>5</sub>	B <sub>6</sub>	C <sub>7</sub>	D <sub>8</sub>	E <sub>9</sub>	F <sub>10</sub>	G <sub>11</sub>	H <sub>12</sub>	I <sub>13</sub>
3,619	3,639	3,779	3,969	4,079	4,149	4,319	4,589	4,719	4,959	5,189	

### Dimensions

	Overall			Seat			Back H	Arm H	Kick Out Seat D	Recline D	Distance from Wall
	W	D	H	W	D	H					
KC8P04   KC8P14	30.75	35	39.5	22.25	21	18.5	27.5	24.5	38	65.5	5

**General Info**  
 COM: 5 yds  
 Wt Cap: 350 lb  
 Unit Weight: 96 lb

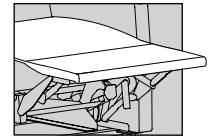

Chaise Continuous Leg Support

### Available Options

#### ARM OPTIONS

F	Fully Upholstered Arms	Standard
---	------------------------	----------

#### ADDITIONAL FEATURES & OPTIONS

CAL	CAL TB133	See pg 9
Z	Multi Cover	Use Pricing for Highest Grade
MBB	Moisture Barrier (Back)	59
MBS	Moisture Barrier (Seat)	59



Power Recliner Wand

# 350 SERIES | K-KOMFORT

# Room Saver™ Recliner | Power & Lift

## Select Aesthetic Style (Denotes back & arm design)

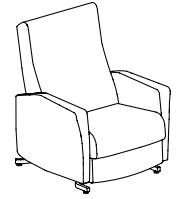
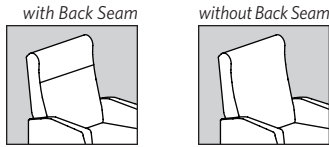

## Select Functional Style

### KC8L04 K-Komfort Room Saver™ Power & Lift Chaise Recliner with Back Seam

COM	Dillon	Carson	A <sub>5</sub>	B <sub>6</sub>	C <sub>7</sub>	D <sub>8</sub>	E <sub>9</sub>	F <sub>10</sub>	G <sub>11</sub>	H <sub>12</sub>	I <sub>13</sub>
3,709	3,739	3,909	4,039	4,149	4,259	4,449	4,719	4,819	5,099	5,339	

### KC8L14 K-Komfort Room Saver™ Power & Lift Chaise Recliner

COM	Dillon	Carson	A <sub>5</sub>	B <sub>6</sub>	C <sub>7</sub>	D <sub>8</sub>	E <sub>9</sub>	F <sub>10</sub>	G <sub>11</sub>	H <sub>12</sub>	I <sub>13</sub>
3,619	3,639	3,779	3,969	4,079	4,149	4,319	4,589	4,719	4,959	5,189	

## Dimensions

	Overall			Seat			Back H	Arm H	Kick Out Seat D	Recline D	Distance from Wall
	W	D	H	W	D	H					
KC8L04   KC8L14	30.5	35	39.5	22.25	21	18.5	27.5	24.5	38	65.5	5

**General Info**  
 COM: 5 yds  
 Wt Cap: 350 lb  
 Unit  
 Weight: 120 lb

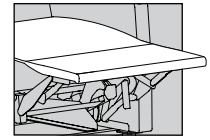

Chaise Continuous Leg Support

## Available Options

### ARM OPTIONS

F	Fully Upholstered Arms	Standard
---	------------------------	----------

### ADDITIONAL FEATURES & OPTIONS

CAL	CAL TB133	See pg 9
Z	Multi Cover	Use Pricing for Highest Grade
MBB	Moisture Barrier (Back)	59
MBS	Moisture Barrier (Seat)	59



Power Recliner Wand

# 450 SERIES



## Series Overview

The 450 Series is our entry-level recliner offering for uncontrolled healthcare environments. Available in Max and Kure aesthetic styles, the 450 Series utilizes independent leg support and back angle adjustments. Both styles are available with several of our most popular “add-on” options to make them a practical choice for a utility recliner when price is a concern, while not sacrificing quality or comfort.

## General Product Information

- 450 lb Weight Rating
- Designed for 24/7 use healthcare environments
- Manually operated recline functionality
- Independent footrest and back adjustment
- Seat Foam Density: 2.3 High Resiliency
- Back Foam Density: 1.75 High Resiliency
- Seat clean-out
- Mid-Ottoman Calf Support
- Infinite Position Back reclines to infinite angle positions
- All interior plywood California Carb Compliant/Phase II
- Field replaceable components

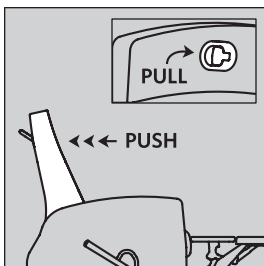

### Infinite Position Locking Back

Allows patient/caregiver to lock back into any position. Lock lever located inside left (facing) arm on applicable models, unless otherwise noted/pictured.

## To Order, Specify

- Model Number
- Textile
- Finish
- Options

## Options vary by model, see specific model page for list of available options

Refer to pg 130 for full option details and images

# 450 SERIES

# Mobile Healthcare Recliners

## K0107 - Kure Mobile Healthcare Recliner - Infinite Position Locking Back



### Pricing

COM	Dillon	Carson	A <sub>5</sub>	B <sub>6</sub>	C <sub>7</sub>	D <sub>8</sub>	E <sub>9</sub>	F <sub>10</sub>	G <sub>11</sub>	H <sub>12</sub>	I <sub>13</sub>
3,709	3,719	3,839	3,949	4,089	4,239	4,369	4,519	4,799	5,029	5,499	

### Dimensions

Overall			Seat			Back H	Arm H	Kick Out Seat D	Recline D	Distance from Wall
W	D	H	W	D	H					
30	37	44.5	22.5	21	20	24.5	26	37.5	71	20

General Info	
COM:	4.3 yds
Wt Cap:	450 lb
Unit Weight:	118 lb

### Available Options

#### ARM CAP OPTIONS

See pg 2 for finishes

U	Urethane	209
J1	Solid Surface - Group 1	619
J2	Solid Surface - Group 2	819
F	Fully Upholstered Arms	Standard

#### CASTER OPTIONS

S4	4" - (2) Caster Lock & Steer System	569
4S3R1	4" - (3) Swivel/(1) Rigid Locking Casters	Standard
4S4	4" - (4) Swivel Locking Casters	39
450-Q4	4" - Central Locking System	1019

#### ADDITIONAL FEATURES & OPTIONS

EG	Protective Edge Guard	Standard
QR	Additional Quick Release Accessory Bracket	69
CAL	CAL TB133	See pg 9
Z	Multi Cover	Use Pricing for Highest Grade
PB	Push Bar	Standard

#### PATIENT WELLNESS & COMFORT OPTIONS

AHP	Adjustable Head Rest Pillow (COM 1 yd)	339
DP	Dual IV Poles & Brackets <sup>1</sup>	498
FBH	Foley Bag Holder	89
FT	Foot Tray	279
IV	IV Pole & Bracket <sup>1</sup>	249
MBB	Moisture Barrier (Back)	59
MBS	Moisture Barrier (Seat)	59
MR	Monitor Arm (right side facing) <sup>1,2</sup>	849
MTR	Monitor Arm with Tray (right side facing) <sup>1,2</sup>	949
WR	Wrist Restraint Mounts (pair)	229

#### TRAY TABLE OPTIONS

		Solid Surface Trays*	
		Grp 1	Grp 2
TSR1	Adjustable (Right) Side Tray <sup>1,2,5</sup>	399	
TD3	Dual Adjustable Side Trays (TSR1 & TSL1) <sup>1,5</sup>	798	
LFSTR	Large Folding (Right) Side Tray <sup>4</sup>	269	739 959
LFSTRCH	Large Folding Cup Holder (Right) Side Tray	339	849 1099
PLFSTR	Padded Large Folding (Right) Side Tray	379	n/a n/a
SFSTR	Small Folding (Right) Side Tray <sup>4</sup>	269	689 889

\*Finishes on pg 2

\*Refer to pg 130 for full option details and images\*

<sup>1</sup>Includes QR bracket connection installed on recliner

<sup>2</sup>Standard on right side (facing). Replace "R" with "L" for left side (facing) option where available.

<sup>4</sup>Contact customer service for solid surface pricing

<sup>5</sup>Over the lap tray function recommended in seated position.

# 450 SERIES

# Mobile Healthcare Recliners

## K0167 - Kure Mobile Healthcare Recliner - Infinite Position Locking Back - Single Fold Down Arm



### Pricing

COM	Dillon/Carson	A <sub>5</sub>	B <sub>6</sub>	C <sub>7</sub>	D <sub>8</sub>	E <sub>9</sub>	F <sub>10</sub>	G <sub>11</sub>	H <sub>12</sub>	I <sub>13</sub>
4,369	4,379	4,479	4,559	4,679	4,859	4,949	5,079	5,299	5,569	6,079

### Dimensions

Overall			Seat			Back H	Arm H	Kick Out Seat D	Recline D	Distance from Wall
W	D	H	W	D	H					
30	37	44.5	22.5	21	20	24.5	26	37.5	71	20

General Info	
COM:	4.8 yds
Wt Cap:	450 lb
Unit Weight:	138 lb

**NOTE:** Transfer arm standard on right side (facing). If specified on left side, handle will be placed on right side and vice versa.

### Available Options

ARM CAP OPTIONS			See pg 2 for finishes			PATIENT WELLNESS & COMFORT OPTIONS		
U	Urethane	Standard	AHP	Adjustable Head Rest Pillow (COM 1 yd)	339			
J1	Solid Surface - Group 1	619	DP	Dual IV Poles & Brackets <sup>1</sup>	498			
J2	Solid Surface - Group 2	819	FBH	Foley Bag Holder	89			
			FT	Foot Tray	279			
			IV	IV Pole & Bracket <sup>1</sup>	249			
			MBB	Moisture Barrier (Back)	59			
			MBS	Moisture Barrier (Seat)	59			
			ML	Monitor Arm (left side facing) <sup>1</sup>	849			
			MTL	Monitor Arm with Tray (left side facing) <sup>1</sup>	949			
			<b>FOLD DOWN TRANSFER ARM SPECIFIC</b>					
			HC	Hinge Cover	Standard			

CASTER OPTIONS		
S4	4" - (2) Caster Lock & Steer System	569
4S3R1	4" - (3) Swivel/(1) Rigid Locking Casters	Standard
4S4	4" - (4) Swivel Locking Casters	39
450-Q4	4" - Central Locking System	1019

ADDITIONAL FEATURES & OPTIONS		
EG	Protective Edge Guard	Standard
QR	Additional Quick Release Accessory Bracket	69
CAL	CAL TB133	See pg 9
Z	Multi Cover	Use Pricing for Highest Grade
PB	Push Bar	Standard

\*Refer to pg 130 for full option details and images\*

<sup>1</sup>Includes QR bracket connection installed on recliner

# 450 SERIES

# Mobile Healthcare Recliners

## M0107 - Max Mobile Healthcare Recliner - Infinite Position Locking Back

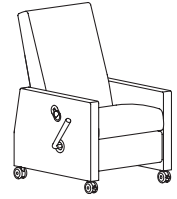

### Pricing

COM	Dillon/Carson	A <sub>5</sub>	B <sub>6</sub>	C <sub>7</sub>	D <sub>8</sub>	E <sub>9</sub>	F <sub>10</sub>	G <sub>11</sub>	H <sub>12</sub>	I <sub>13</sub>
3,149	3,199	3,259	3,429	3,579	3,779	3,979	4,179	4,479	4,709	5,159

### Dimensions

Overall			Seat			Back H	Arm H	Kick Out Seat D	Recline D	Distance from Wall
W	D	H	W	D	H					
32.75	33.5	44	22.5	20	19.5	24.5	25	38	70	18

General Info	
COM:	4.7 yds
Wt Cap:	450 lb
Unit Weight:	98.3 lb

### Available Options

<b>ARM CAP OPTIONS</b>		<i>See pg 2 for finishes</i>	<b>PATIENT WELLNESS &amp; COMFORT OPTIONS</b>		
U	Urethane	209	FBH	Foley Bag Holder	89
J1	Solid Surface - Group 1	619	MBB	Moisture Barrier (Back)	59
J2	Solid Surface - Group 2	819	MBS	Moisture Barrier (Seat)	59
F	Fully Upholstered Arms	Standard	MR	Monitor Arm (right side facing) <sup>1,2</sup>	849
T	Thermofoil	119	MTR	Monitor Arm with Tray (right side facing) <sup>1,2</sup>	949
			WR	Wrist Restraint Mounts (pair)	229
<b>CASTER OPTIONS</b>			<b>TRAY TABLE OPTIONS</b>		
3S4	3" - Swivel Locking Casters	Standard	TSR1	Adjustable (Right) Side Tray <sup>1,2,5</sup>	399
	<i>*Not intended for transport.</i>		TD3	Dual Adjustable Side Trays (TSR1 & TSL1) <sup>1,5</sup>	798
<b>ADDITIONAL FEATURES &amp; OPTIONS</b>			LFSTR	Large Folding (Right) Side Tray <sup>4</sup>	269
EG	Protective Edge Guard	Standard	LFSTRCH	Large Folding Cup Holder (Right) Side Tray	339
QR	Additional Quick Release Accessory Bracket	69	PLFSTR	Padded Large Folding (Right) Side Tray	379
CAL	CAL TB133	See pg 9	SFSTR	Small Folding (Right) Side Tray <sup>4</sup>	269
Z	Multi Cover	Use Pricing for Highest Grade			

*\*Refer to pg 130 for full option details and images\**

<sup>1</sup>Includes QR bracket connection installed on recliner

<sup>2</sup>Standard on right side (facing). Replace "R" with "L" for left side (facing) option where available.

<sup>4</sup>Contact customer service for solid surface pricing

<sup>5</sup>Over the lap tray function recommended in seated position.

**How to Order**

The chart below is a guide to use in building a recliner model number for ordering. Base models and their available aesthetic styles and options are listed in the following sections of Durable® Series healthcare recliners. Specify textiles and finishes, along with any additional options from the following pages. Recliner base pricing is determined by selected textile grade. Option prices for each base model are listed on individual product pages, along with availability.

	Aesthetic Style	Base Model	Arms	Multicover	Heat/Massage	Caster System
<b>EXAMPLE</b>	<b>KM</b> Kadia Mod	<b>1117</b> Mobile Healthcare Recliner	<b>J</b> Solid Surface Arm Caps	<b>Z</b> Multiple Covers Selected	<b>HM</b> Heat & Massage	<b>Q</b> Central Locking
	<p><b>Denotes Back and Arm Design</b></p> <p>See individual product pages for available Aesthetic Styles.</p> <p>Images of all styles within Durable® Series shown below.</p>	<p><b>Denotes Base Functionality</b></p> <p>'C' in front of model number indicates 'Chaise Continuous Leg Support.'</p> <p>Chart below lists each Durable® recliner series.</p>	<p><b>Denotes Arm Cap Selection</b></p> <p>(F) Fully Upholstered Arms (no arm cap)</p> <p>(U) Urethane Arm Cap</p> <p>(J) Solid Surface Arm Cap</p> <p>(T) Thermofoil Arm Cap</p>	<p><b>Denotes if Multiple Textiles Specified</b></p> <p>(Z) Multicover</p> <p>If entire unit is specified in a single textile, leave this space blank.</p>	<p><b>Denotes Heat and Massage Selection</b></p> <p>(H) Heat</p> <p>(HM) Heat &amp; Massage</p> <p>Above codes still apply to model number when wand controlled option is selected (HW, HMW). Note HW or HMW with other options when ordering to specify.</p> <p>If no heat or massage option selected, leave this space blank.</p>	<p><b>Denotes Caster System Selection</b></p> <p>(Q)* Central Locking</p> <p>(S) Two Caster Locking</p> <p>*Use for any caster system containing 'Q'</p> <p>If no caster system selected, leave this space blank. Casters that are not part of a central or two-caster locking system are able to be locked individually.</p>

**\*\* See individual product pages for availability of above options.\*\***

**Durable® Series Aesthetic Styles**

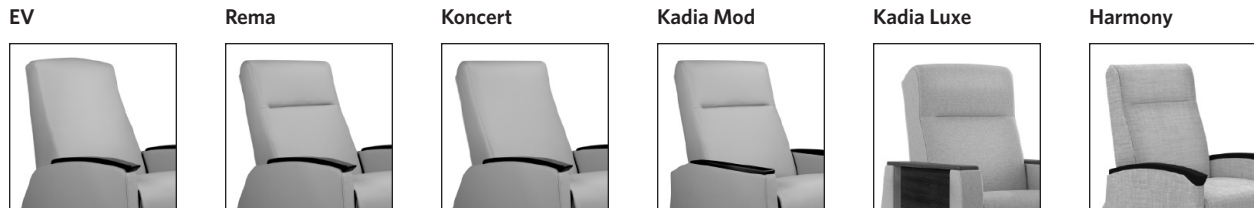

**Durable® Series Healthcare Recliners by Category**

<b>550 Series</b>	Rocker Recliners
<b>650 Series</b>	Mobile Recliners
<b>750 Series</b>	Mobile Bariatric Recliners
<b>Power Series</b>	Power / Lift Assist Mobile Recliners
<b>Exam Lift Series</b>	Exam Lift Treatment Recliners

**Recliner Dimension Key**

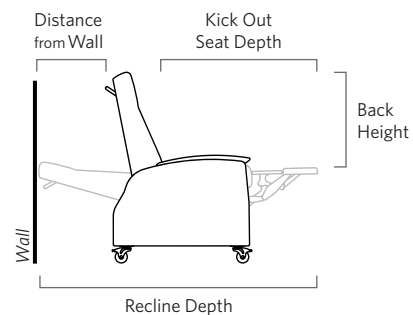

# DURABLE® 550 SERIES



## Series Overview

The Durable® 550 Series is our collection of Rocker Recliners, all featuring the patented Durable® unitized mechanism, which harmonizes motion of the back, footrest, and seat for smooth, full-body movement. Available in both stationary and mobile configurations, as well as patient transfer options, all models in the Durable® 550 Series boast a full flatbed sleep position and a 550 lb weight capacity to make them an exceptional fit for healthcare applications where comfort is key.

## General Product Information

- 550 lb Weight Rating
- Stationary or mobile base allows rocking functionality
- Designed for 24/7 use healthcare environments
- Manually operated recline functionality
- Footrest and back move in harmony when engaged
- Quick removable back & lift up seat for ease of cleaning
- True flatbed sleep position
- Sinuous spring seat and back
- Seat clean-out
- All steel base structure for maximum durability
- Mid-Ottoman Calf Support
- Infinite Position Back reclines to infinite angle positions
- All interior plywood California Carb Compliant/Phase II
- Field replaceable components

## To Order, Specify

- Model Number
- Textile
- Finish
- Options

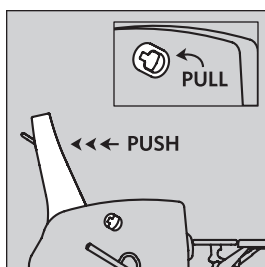

### Infinite Position Locking Back

Allows patient/caregiver to lock back into any position. Lock lever located outside left (facing) arm on applicable 550 Series models, unless otherwise noted/pictured.

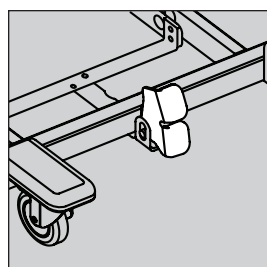

### Rocker Lock Mechanism

Mobile Rocker Recliners feature a pedal on rear of base to lock & unlock rocking motion, allowing easier entry or exit of chair by users.

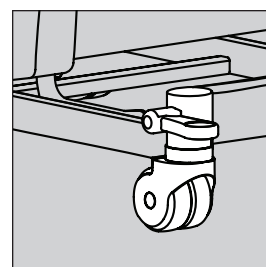

### Central Lock Caster System

Available on Mobile Rocker Recliners. Controlled by 2-position lever located at front of chair on left (facing) arm.

## Options vary by model, see specific model page for list of available options

Refer to pg 130 for full option details and images

# DURABLE® 550 SERIES

# Healthcare Rocker Recliners | Stationary

## Select Aesthetic Style *(Denotes back & arm design)*

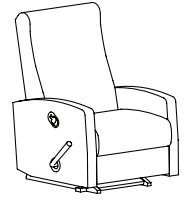
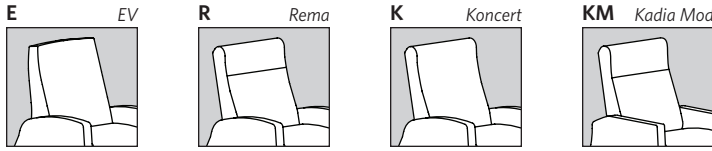

(Koncert style pictured)

## Select Functional Style *(Aesthetic style code precedes selected model number below, e.g., RC1127)*

### 1125 Stationary Rocker Recliner - Infinite Position Locking Back

COM	Dillon	Carson	A <sub>5</sub>	B <sub>6</sub>	C <sub>7</sub>	D <sub>8</sub>	E <sub>9</sub>	F <sub>10</sub>	G <sub>11</sub>	H <sub>12</sub>	I <sub>13</sub>
4,109	4,129	4,289	4,439	4,609	4,819	5,069	5,329	5,859	6,189	6,579	

### C1125 Stationary Chaise Rocker Recliner - Infinite Position Locking Back

COM	Dillon	Carson	A <sub>5</sub>	B <sub>6</sub>	C <sub>7</sub>	D <sub>8</sub>	E <sub>9</sub>	F <sub>10</sub>	G <sub>11</sub>	H <sub>12</sub>	I <sub>13</sub>
4,409	4,449	4,579	4,739	4,909	5,109	5,369	5,609	6,119	6,579	6,979	

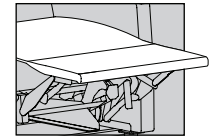

Chaise Models

## Dimensions

	Overall			Seat			Back H	Arm H	Kick Out Seat D	Recline D	Distance from Wall
	W	D	H	W	D	H					
E1125   EC1125	32.5	34.25	43.25	23.75	21	18.75	24.5	24.25	36	71	19.5
R1125   RC1125   K1125   KC1125	32.5	39	43.25	23.75	21	18.75	24.5	24.25	36	71	18.5
KM1125   KMC1125	32.5	39	43.25	23.75	21	18.75	24.5	24.5	36	71	18.5

### General Info

COM: 4.7 yds  
w/ Chaise  
COM: 5.1 yds  
Wt Cap: 550 lb  
Unit Weight: 134 lb

## Available Options

### ARM CAP OPTIONS

See pg 2 for finishes

U	Urethane	209
J1	Solid Surface - Group 1	619
J2	Solid Surface - Group 2	819
F	Fully Upholstered Arms	Standard

### CASTER OPTIONS

Not applicable on stationary models

### ADDITIONAL FEATURES & OPTIONS

EG	Protective Edge Guard	Standard
QR	Additional Quick Release Accessory Bracket	69
CAL	CAL TB133	See pg 9
Z	Multi Cover	Use Pricing for Highest Grade

### PATIENT WELLNESS & COMFORT OPTIONS

ABP	Adjustable Back Pad (COM 1.75 yds)	
	Textile Grades COM-B	459
	Textile Grades C-I	569
FBH	Foley Bag Holder	89
MBB	Moisture Barrier (Back)	59
MBS	Moisture Barrier (Seat)	59
MR	Monitor Arm (right side facing) <sup>1,2</sup>	849
MTR	Monitor Arm with Tray (right side facing) <sup>1,2</sup>	949

\*Refer to pg 130 for full option details and images\*

<sup>1</sup>Includes QR bracket connection installed on recliner

<sup>2</sup>Standard on right side (facing). Replace "R" with "L" for left side (facing) option where available.

# DURABLE® 550 SERIES

# Healthcare Rocker Recliners | Stationary

## Select Aesthetic Style *(Denotes back & arm design)*

**E** EV-Narrow Arm

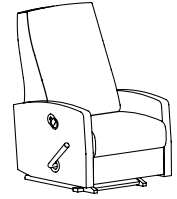
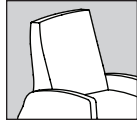

## Select Functional Style *(Aesthetic style code precedes selected model number below, e.g., RC1127)*

### 4125 Stationary Rocker Recliner - Narrow Arms - Infinite Position Locking Back

COM	Dillon	Carson	A <sub>5</sub>	B <sub>6</sub>	C <sub>7</sub>	D <sub>8</sub>	E <sub>9</sub>	F <sub>10</sub>	G <sub>11</sub>	H <sub>12</sub>	I <sub>13</sub>
4,109	4,129	4,289	4,439	4,609	4,819	5,069	5,329	5,859	6,179	6,579	

### C4125 Stationary Rocker Chaise Recliner - Narrow Arms - Infinite Position Locking Back

COM	Dillon	Carson	A <sub>5</sub>	B <sub>6</sub>	C <sub>7</sub>	D <sub>8</sub>	E <sub>9</sub>	F <sub>10</sub>	G <sub>11</sub>	H <sub>12</sub>	I <sub>13</sub>
4,409	4,449	4,579	4,739	4,909	5,109	5,369	5,609	6,119	6,579	6,979	

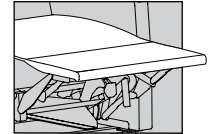

Chaise Models

## Dimensions

	Overall			Seat			Back H	Arm H	Kick Out Seat D	Recline D	Distance from Wall
	W	D	H	W	D	H					
E4125   EC4125	32	34.25	43.25	23.75	21	18.75	24.5	24.25	36	71	19.5

### General Info

COM: 4.7 yds  
w/ Chaise  
COM: 5.1 yds  
Wt Cap: 550 lb  
Unit  
Weight: 128 lb

## Available Options

### ARM CAP OPTIONS

See pg 2 for finishes

U	Urethane	209
J1	Solid Surface - Group 1	619
J2	Solid Surface - Group 2	819
F	Fully Upholstered Arms	Standard

### CASTER OPTIONS

Not applicable on stationary models

### ADDITIONAL FEATURES & OPTIONS

EG	Protective Edge Guard	Standard
QR	Additional Quick Release Accessory Bracket	69
CAL	CAL TB133	See pg 9
Z	Multi Cover	Use Pricing for Highest Grade

### PATIENT WELLNESS & COMFORT OPTIONS

ABP	Adjustable Back Pad (COM 1.75 yds)	
	Textile Grades COM-B	459
	Textile Grades C-I	569
FBH	Foley Bag Holder	89
MBB	Moisture Barrier (Back)	59
MBS	Moisture Barrier (Seat)	59
MR	Monitor Arm (right side facing) <sup>1,2</sup>	849
MTR	Monitor Arm with Tray (right side facing) <sup>1,2</sup>	949

\*Refer to pg 130 for full option details and images\*

<sup>1</sup>Includes QR bracket connection installed on recliner

<sup>2</sup>Standard on right side (facing). Replace "R" with "L" for left side (facing) option where available.

# DURABLE® 550 SERIES

# Healthcare Rocker Recliners | Stationary

## Select Aesthetic Style (Denotes back & arm design)

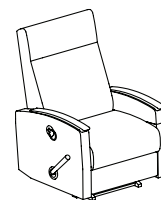
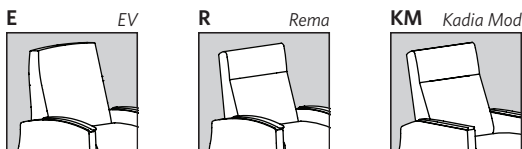

(Rema style pictured)

## Select Functional Style (Aesthetic style code precedes selected model number below, e.g., RC1127)

### 1125R Stationary Rocker Recliner - Infinite Position Locking Back - Right Facing Fold Down Arm

COM	Dillon	Carson	A <sub>5</sub>	B <sub>6</sub>	C <sub>7</sub>	D <sub>8</sub>	E <sub>9</sub>	F <sub>10</sub>	G <sub>11</sub>	H <sub>12</sub>	I <sub>13</sub>
5,109	5,199	5,209	5,339	5,499	5,619	5,899	6,059	6,339	6,659	6,879	

### C1125R Stationary Chaise Rocker Recliner - Infinite Position Locking Back - Right Facing Fold Down Arm

COM	Dillon	Carson	A <sub>5</sub>	B <sub>6</sub>	C <sub>7</sub>	D <sub>8</sub>	E <sub>9</sub>	F <sub>10</sub>	G <sub>11</sub>	H <sub>12</sub>	I <sub>13</sub>
5,459	5,599	5,639	5,729	5,919	6,139	6,339	6,549	6,789	7,059	7,269	

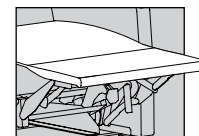

Chaise Models

**NOTE:** Transfer arm standard on right side (facing). Replace "R" with "L" in model number to specify on left side, handle will be placed on right side and vice versa.

## Dimensions

	Overall			Seat			Back H	Arm H	Kick Out Seat D	Recline D	Distance from Wall
	W	D	H	W	D	H					
E1125R   EC1125R   E1125L   EC1125L	32.5	34.25	43.25	23.75	21	18.75	24.5	24.25	36	71	19.5
R1125R   RC1125R   R1125L   RC1125L	32.5	39	43.25	23.75	21	18.75	24.5	24.25	36	71	18.5
KM1125R   KMC1125R   KM1125L   KMC1125L	32.5	39	43.25	23.75	21	18.75	24.5	24.5	36	71	18.5

### General Info

COM: 4.9 yds  
w/ Chaise  
COM: 5.2 yds  
Wt Cap: 550 lb  
Unit Weight: 134 lb

## Available Options

### ARM CAP OPTIONS

See pg 2 for finishes

U	Urethane	Standard
J1	Solid Surface - Group 1	619
J2	Solid Surface - Group 2	819

### CASTER OPTIONS

Not applicable on stationary models

### ADDITIONAL FEATURES & OPTIONS

EG	Protective Edge Guard	Standard
QR	Additional Quick Release Accessory Bracket	69
CAL	CAL TB133	See pg 9
Z	Multi Cover	Use Pricing for Highest Grade

### PATIENT WELLNESS & COMFORT OPTIONS

ABP	Adjustable Back Pad (COM 1.75 yds)	
	Textile Grades COM-B	459
	Textile Grades C-I	569
FBH	Foley Bag Holder	89
MBB	Moisture Barrier (Back)	59
MBS	Moisture Barrier (Seat)	59
ML	Monitor Arm (left side facing) <sup>1,2</sup>	849
MTL	Monitor Arm with Tray (left side facing) <sup>1,2</sup>	949

\*Refer to pg 130 for full option details and images\*

<sup>1</sup>Includes QR bracket connection installed on recliner

<sup>2</sup>Standard on left side (facing). Replace "L" with "R" for right side (facing) option when specifying left side fold down arm.

# DURABLE® 550 SERIES

# Healthcare Rocker Recliners | Mobile

## Select Aesthetic Style *(Denotes back & arm design)*

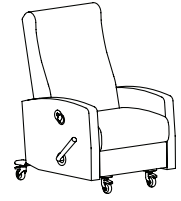
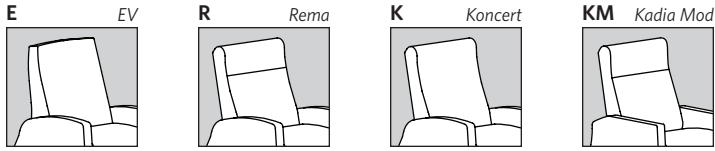

*(Koncert style pictured)*

## Select Functional Style *(Aesthetic style code precedes selected model number below, e.g., RC1127)*

### 1127 Mobile Rocker Recliner - Infinite Position Locking Back

COM	Dillon/Carson	A <sub>5</sub>	B <sub>6</sub>	C <sub>7</sub>	D <sub>8</sub>	E <sub>9</sub>	F <sub>10</sub>	G <sub>11</sub>	H <sub>12</sub>	I <sub>13</sub>
4,489	4,549	4,689	4,869	5,119	5,369	5,659	5,949	6,619	6,969	7,359

### C1127 Mobile Chaise Rocker Recliner - Infinite Position Locking Back

COM	Dillon/Carson	A <sub>5</sub>	B <sub>6</sub>	C <sub>7</sub>	D <sub>8</sub>	E <sub>9</sub>	F <sub>10</sub>	G <sub>11</sub>	H <sub>12</sub>	I <sub>13</sub>
4,789	4,859	4,999	5,149	5,439	5,649	5,969	6,219	6,879	7,239	7,629

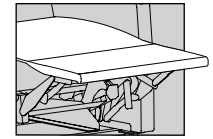

*Chaise Models*

## Dimensions

	Overall			Seat			Back H	Arm H	Kick Out Seat D	Recline D	Distance from Wall
	W	D	H	W	D	H					
E1127   EC1127	32.5	38	44	23.75	21.5	19.75	24.5	25	37.5	72.5	20
R1127   RC1127   K1127   KC1127	32.5	38	44	23.75	21.5	19.75	24.5	25	37.5	72.5	20
KM1127   KMC1127	32.5	38	44	23.75	21.5	19.75	24.5	25.25	37.5	72.5	20

**General Info**

COM: 4.7 yds  
w/ Chaise COM: 5.1 yds

Wt Cap: 550 lb  
Unit Weight: 156 lb

## Available Options

ARM CAP OPTIONS		See pg 2 for finishes	PATIENT WELLNESS & COMFORT OPTIONS	
U	Urethane	209	ABP	Adjustable Back Pad (COM 1.75 yds) Textile Grades COM-B 459 Textile Grades C-I 569
J1	Solid Surface - Group 1	619	AHP	Adjustable Head Rest Pillow (COM 1 yd) 339
J2	Solid Surface - Group 2	819	FBH	Foley Bag Holder 89
F	Fully Upholstered Arms	Standard	MBB	Moisture Barrier (Back) 59
<b>CASTER OPTIONS</b>			MBS	Moisture Barrier (Seat) 59
3S1R3	3" - (3) Swivel/(1) Rigid Locking Casters	Standard	MR	Monitor Arm (right side facing) <sup>1,2</sup> 849
3S4	3" - (4) Swivel Locking Casters	19	MTR	Monitor Arm with Tray (right side facing) <sup>1,2</sup> 949
Q3	3" - Dual Wheel Central Locking System <sup>3</sup>	1649		
<b>ADDITIONAL FEATURES &amp; OPTIONS</b>			*Refer to pg 130 for full option details and images*	
PB	Push Bar	Standard		
EG	Protective Edge Guard	Standard		
QR	Additional Quick Release Accessory Bracket	69		
CAL	CAL TB133	See pg 9		
Z	Multi Cover	Use Pricing for Highest Grade		

<sup>1</sup>Includes QR bracket connection installed on recliner

<sup>2</sup>Standard on right side (facing). Replace "R" with "L" for left side (facing) option where available.

<sup>3</sup>For 4" or 5" central locking casters, please contact customer service.



**Select Aesthetic Style** (Denotes back & arm design)

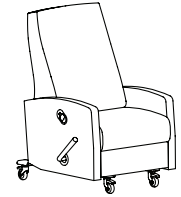
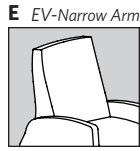

**Select Functional Style** (Aesthetic style code precedes selected model number below, e.g., RC1127)

**4127 Mobile Rocker Recliner - Narrow Arms - Infinite Position Locking Back**

COM	Dillon	Carson	A <sub>5</sub>	B <sub>6</sub>	C <sub>7</sub>	D <sub>8</sub>	E <sub>9</sub>	F <sub>10</sub>	G <sub>11</sub>	H <sub>12</sub>	I <sub>13</sub>
4,489	4,549	4,689	4,869	5,119	5,369	5,659	5,949	6,619	6,969	7,359	

**C4127 Mobile Rocker Chaise Recliner - Narrow Arms - Infinite Position Locking Back**

COM	Dillon	Carson	A <sub>5</sub>	B <sub>6</sub>	C <sub>7</sub>	D <sub>8</sub>	E <sub>9</sub>	F <sub>10</sub>	G <sub>11</sub>	H <sub>12</sub>	I <sub>13</sub>
4,789	4,859	4,999	5,149	5,439	5,649	5,969	6,219	6,879	7,239	7,629	

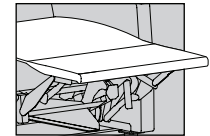

Chaise Models

**Dimensions**

E4127   EC4127	Overall			Seat			Back H	Arm H	Kick Out Seat D	Recline D	Distance from Wall
	W	D	H	W	D	H					
	32	38	44	23.75	21.5	19.75	24.5	25	37.5	72.5	20

**General Info**

COM: 4.7 yds  
w/ Chaise COM: 5.1 yds  
Wt Cap: 550 lb  
Unit Weight: 151 lb

**Available Options**

**ARM CAP OPTIONS**

See pg 2 for finishes

U	Urethane	209
J1	Solid Surface - Group 1	619
J2	Solid Surface - Group 2	819
F	Fully Upholstered Arms	Standard

**CASTER OPTIONS**

3S1R3	3" - (3) Swivel/(1) Rigid Locking Casters	Standard
3S4	3" - (4) Swivel Locking Casters	19
Q3	3" - Dual Wheel Central Locking System <sup>3</sup>	1649

**ADDITIONAL FEATURES & OPTIONS**

PB	Push Bar	Standard
EG	Protective Edge Guard	Standard
QR	Additional Quick Release Accessory Bracket	69
CAL	CAL TB133	See pg 9
Z	Multi Cover	Use Pricing for Highest Grade

**PATIENT WELLNESS & COMFORT OPTIONS**

ABP	Adjustable Back Pad (COM 1.75 yds)	
	Textile Grades COM-B	459
	Textile Grades C-I	569
AHP	Adjustable Head Rest Pillow (COM 1 yd)	339
FBH	Foley Bag Holder	89
MBB	Moisture Barrier (Back)	59
MBS	Moisture Barrier (Seat)	59
MR	Monitor Arm (right side facing) <sup>1,2</sup>	849
MTR	Monitor Arm with Tray (right side facing) <sup>1,2</sup>	949

\*Refer to pg 130 for full option details and images\*

<sup>1</sup>Includes QR bracket connection installed on recliner

<sup>2</sup>Standard on right side (facing). Replace "R" with "L" for left side (facing) option where available.

<sup>3</sup>For 4" or 5" central locking casters, please contact customer service.

# DURABLE® 550 SERIES

# Healthcare Rocker Recliners | Mobile

## Select Aesthetic Style (Denotes back & arm design)

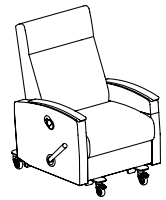
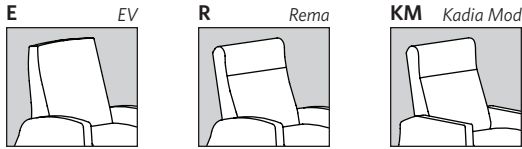

(Rema style pictured)

## Select Functional Style (Aesthetic style code precedes selected model number below, e.g., RC1127)

### 1127R Mobile Rocker Recliner - Infinite Position Locking Back - Right Facing Fold Down Arm

COM	Dillon/Carson	A <sub>5</sub>	B <sub>6</sub>	C <sub>7</sub>	D <sub>8</sub>	E <sub>9</sub>	F <sub>10</sub>	G <sub>11</sub>	H <sub>12</sub>	I <sub>13</sub>
5,389	5,459	5,479	5,609	5,739	5,889	6,149	6,289	6,579	7,159	7,389

### C1127R Mobile Chaise Rocker Recliner - Infinite Position Locking Back - Right Facing Fold Down Arm

COM	Dillon/Carson	A <sub>5</sub>	B <sub>6</sub>	C <sub>7</sub>	D <sub>8</sub>	E <sub>9</sub>	F <sub>10</sub>	G <sub>11</sub>	H <sub>12</sub>	I <sub>13</sub>
5,729	5,879	5,919	5,999	6,169	6,399	6,599	6,789	7,039	7,459	7,659

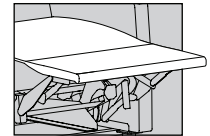

Chaise Models

**NOTE:** Transfer arm standard on right side (facing). Replace "R" with "L" in model number to specify on left side, handle will be placed on right side and vice versa.

## Dimensions

	Overall			Seat			Back H	Arm H	Kick Out Seat D	Recline D	Distance from Wall
	W	D	H	W	D	H					
E1127R   EC1127R   E1127L   EC1127L	32.5	38	44	23.75	21.5	19.75	24.5	25	37.5	72.5	20
R1127R   RC1127R   R1127L   RC1127L	32.5	38	44	23.75	21.5	19.75	24.5	25	37.5	72.5	20
KM1127R   KMC1127R   KM1127L   KMC1127L	32.5	38	44	23.75	21.5	19.75	24.5	25.25	37.5	72.5	20

General Info	
COM:	4.9 yds
w/ Chaise COM:	5.2 yds
Wt Cap:	550 lb
Unit Weight:	156 lb

## Available Options

ARM CAP OPTIONS			See pg 2 for finishes	PATIENT WELLNESS & COMFORT OPTIONS		
U	Urethane	Standard		ABP	Adjustable Back Pad (COM 1.75 yds)	
J1	Solid Surface - Group 1	619			Textile Grades COM-B	459
J2	Solid Surface - Group 2	819			Textile Grades C-I	569
CASTER OPTIONS				AHP	Adjustable Head Rest Pillow (COM 1 yd)	339
3S1R3	3" - (3) Swivel/(1) Rigid Locking Casters	Standard		FBH	Foley Bag Holder	89
3S4	3" - (4) Swivel Locking Casters	19		MBB	Moisture Barrier (Back)	59
Q3	3" - Dual Wheel Central Locking System <sup>3</sup>	1649		MBS	Moisture Barrier (Seat)	59
ADDITIONAL FEATURES & OPTIONS				ML	Monitor Arm (left side facing) <sup>1,2</sup>	849
PB	Push Bar	Standard		MTL	Monitor Arm with Tray (left side facing) <sup>1,2</sup>	949
EG	Protective Edge Guard	Standard				
QR	Additional Quick Release Accessory Bracket	69				
CAL	CAL TB133	See pg 9				
Z	Multi Cover	Use Pricing for Highest Grade				

\*Refer to pg 130 for full option details and images\*

<sup>1</sup>Includes QR bracket connection installed on recliner

<sup>2</sup>Standard on left side (facing). Replace "L" with "R" for right side (facing) option when specifying left side fold down arm.

<sup>3</sup>For 4" or 5" central locking casters, please contact customer service.



**Select Aesthetic Style** (Denotes back & arm design)

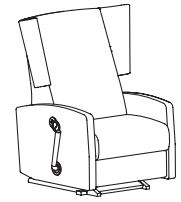
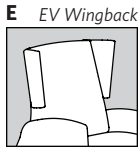

(Koncert style pictured)

**Select Functional Style** (Aesthetic style code precedes selected model number below, e.g., RC1127)

**2125 Stationary Wingback Rocker Recliner - Infinite Position Locking Back**

COM	Dillon	Carson	A <sub>5</sub>	B <sub>6</sub>	C <sub>7</sub>	D <sub>8</sub>	E <sub>9</sub>	F <sub>10</sub>	G <sub>11</sub>	H <sub>12</sub>	I <sub>13</sub>
5,079	5,149	5,209	5,349	5,539	5,699	5,969	6,169	6,519	6,959	7,229	

**C2125 Stationary Chaise Wingback Rocker Recliner - Infinite Position Locking Back**

COM	Dillon	Carson	A <sub>5</sub>	B <sub>6</sub>	C <sub>7</sub>	D <sub>8</sub>	E <sub>9</sub>	F <sub>10</sub>	G <sub>11</sub>	H <sub>12</sub>	I <sub>13</sub>
5,379	5,399	5,499	5,659	5,829	5,989	6,259	6,449	6,769	7,339	7,629	

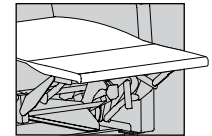

Chaise Models

**Dimensions**

	Overall			Seat			Back H	Arm H	Kick Out Seat D	Recline D	Distance from Wall
	W	D	H	W	D	H					
E2125   EC2125	32.5	34.25	43.25	23.75	21	18.75	24.5	24.25	36	71	19.5

**General Info**

COM: 5.2 yds  
w/ Chaise  
COM: 5.5 yds

Wt Cap: 550 lb  
Unit  
Weight: 139 lb

**Available Options**

**ARM CAP OPTIONS**

See pg 2 for finishes

U	Urethane	209
J1	Solid Surface - Group 1	619
J2	Solid Surface - Group 2	819
F	Fully Upholstered Arms	Standard

**CASTER OPTIONS**

Not applicable on stationary models

**ADDITIONAL FEATURES & OPTIONS**

EG	Protective Edge Guard	Standard
QR	Additional Quick Release Accessory Bracket	69
CAL	CAL TB133	See pg 9
Z	Multi Cover	Use Pricing for Highest Grade

**PATIENT WELLNESS & COMFORT OPTIONS**

ABP	Adjustable Back Pad (COM 1.75 yds)	
	Textile Grades COM-B	459
	Textile Grades C-I	569
FBH	Foley Bag Holder	89
MBB	Moisture Barrier (Back)	59
MBS	Moisture Barrier (Seat)	59
MR	Monitor Arm (right side facing) <sup>1,2</sup>	849
MTR	Monitor Arm with Tray (right side facing) <sup>1,2</sup>	949

\*Refer to pg 130 for full option details and images\*

<sup>1</sup>Includes QR bracket connection installed on recliner

<sup>2</sup>Standard on right side (facing). Replace "R" with "L" for left side (facing) option where available.



**Select Aesthetic Style** (Denotes back & arm design)

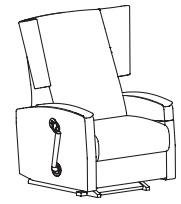

(Rema style pictured)

**Select Functional Style** (Aesthetic style code precedes selected model number below, e.g., RC1127)

**2125R Stationary Wingback Rocker Recliner - Infinite Position Locking Back - Right Facing Fold Down Arm**

COM	Dillon/Carson	A <sub>5</sub>	B <sub>6</sub>	C <sub>7</sub>	D <sub>8</sub>	E <sub>9</sub>	F <sub>10</sub>	G <sub>11</sub>	H <sub>12</sub>	I <sub>13</sub>
6,079	6,149	6,209	6,259	6,429	6,499	6,789	6,899	6,999	7,429	7,539

**C2125R Stationary Chaise Wingback Rocker Recliner - Infinite Position Locking Back - Right Facing Fold Down Arm**

COM	Dillon/Carson	A <sub>5</sub>	B <sub>6</sub>	C <sub>7</sub>	D <sub>8</sub>	E <sub>9</sub>	F <sub>10</sub>	G <sub>11</sub>	H <sub>12</sub>	I <sub>13</sub>
6,429	6,549	6,559	6,649	6,839	7,019	7,239	7,379	7,449	7,819	7,929

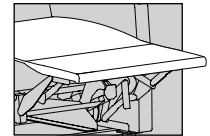

Chaise Models

**NOTE:** Transfer arm standard on right side (facing). Replace "R" with "L" in model number to specify on left side, handle will be placed on right side and vice versa.

**Dimensions**

	Overall			Seat			Back H	Arm H	Kick Out Seat D	Recline D	Distance from Wall
	W	D	H	W	D	H					
E2125R   EC2125R   E2125L   EC2125L	32.5	34.25	43.25	23.75	21	18.75	24.5	24.25	36	71	19.5

**General Info**

COM: 5.4 yds  
w/ Chaise  
COM: 5.7 yds

Wt Cap: 550 lb  
Unit  
Weight: 139 lb

**Available Options**

**ARM CAP OPTIONS**

See pg 2 for finishes

U	Urethane	Standard
J1	Solid Surface - Group 1	619
J2	Solid Surface - Group 2	819

**CASTER OPTIONS**

Not applicable on stationary models

**ADDITIONAL FEATURES & OPTIONS**

EG	Protective Edge Guard	Standard
QR	Additional Quick Release Accessory Bracket	69
CAL	CAL TB133	See pg 9
Z	Multi Cover	Use Pricing for Highest Grade

**PATIENT WELLNESS & COMFORT OPTIONS**

ABP	Adjustable Back Pad (COM 1.75 yds)	
	Textile Grades COM-B	459
	Textile Grades C-I	569
FBH	Foley Bag Holder	89
MBB	Moisture Barrier (Back)	59
MBS	Moisture Barrier (Seat)	59
ML	Monitor Arm (left side facing) <sup>1,2</sup>	849
MTL	Monitor Arm with Tray (left side facing) <sup>1,2</sup>	949

\*Refer to pg 130 for full option details and images\*

<sup>1</sup>Includes QR bracket connection installed on recliner

<sup>2</sup>Standard on left side (facing). Replace "L" with "R" for right side (facing) option when specifying left side fold down arm.



**Select Aesthetic Style** (Denotes back & arm design)

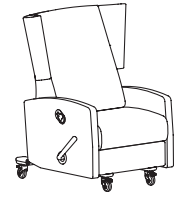
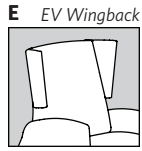

**Select Functional Style** (Aesthetic style code precedes selected model number below, e.g., RC1127)

**2127 Mobile Wingback Rocker Recliner - Infinite Position Locking Back**

COM	Dillon	Carson	A <sub>5</sub>	B <sub>6</sub>	C <sub>7</sub>	D <sub>8</sub>	E <sub>9</sub>	F <sub>10</sub>	G <sub>11</sub>	H <sub>12</sub>	I <sub>13</sub>
5,459	5,499	5,609	5,779	6,049	6,239	6,559	6,779	7,269	7,729	8,019	

**C2127 Mobile Chaise Wingback Rocker Recliner - Infinite Position Locking Back**

COM	Dillon	Carson	A <sub>5</sub>	B <sub>6</sub>	C <sub>7</sub>	D <sub>8</sub>	E <sub>9</sub>	F <sub>10</sub>	G <sub>11</sub>	H <sub>12</sub>	I <sub>13</sub>
5,759	5,799	5,919	6,069	6,359	6,529	6,859	7,059	7,539	8,009	8,279	

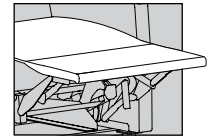

Chaise Models

**Dimensions**

	Overall			Seat			Back H	Arm H	Kick Out Seat D	Recline D	Distance from Wall
	W	D	H	W	D	H					
E2127   EC2127	32.5	38	44	23.75	21.5	19.75	24.5	25	37.5	72.5	20

**General Info**

COM: 5.2 yds  
 w/ Chaise COM: 5.5 yds  
 Wt Cap: 550 lb  
 Unit Weight: 161 lb

**Available Options**

**ARM CAP OPTIONS**

See pg 2 for finishes

U	Urethane	209
J1	Solid Surface - Group 1	619
J2	Solid Surface - Group 2	819
F	Fully Upholstered Arms	Standard

**CASTER OPTIONS**

3S1R3	3" - (3) Swivel/(1) Rigid Locking Casters	Standard
3S4	3" - (4) Swivel Locking Casters	19
Q3	3" - Dual Wheel Central Locking System <sup>3</sup>	1649

**ADDITIONAL FEATURES & OPTIONS**

PB	Push Bar	Standard
EG	Protective Edge Guard	Standard
QR	Additional Quick Release Accessory Bracket	69
CAL	CAL TB133	See pg 9
Z	Multi Cover	Use Pricing for Highest Grade

**PATIENT WELLNESS & COMFORT OPTIONS**

ABP	Adjustable Back Pad (COM 1.75 yds)	
	Textile Grades COM-B	459
	Textile Grades C-1	569
AHP	Adjustable Head Rest Pillow (COM 1 yd)	339
FBH	Foley Bag Holder	89
MBB	Moisture Barrier (Back)	59
MBS	Moisture Barrier (Seat)	59
MR	Monitor Arm (right side facing) <sup>1,2</sup>	849
MTR	Monitor Arm with Tray (right side facing) <sup>1,2</sup>	949

\*Refer to pg 130 for full option details and images\*

<sup>1</sup>Includes QR bracket connection installed on recliner

<sup>2</sup>Standard on right side (facing). Replace "R" with "L" for left side (facing) option where available.

<sup>3</sup>For 4" or 5" central locking casters, please contact customer service.

**Select Aesthetic Style** (Denotes back & arm design)

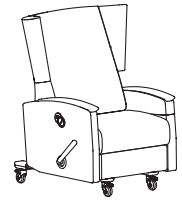
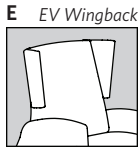

**Select Functional Style** (Aesthetic style code precedes selected model number below, e.g., RC1127)

**2127R Mobile Wingback Rocker Recliner - Infinite Position Locking Back - Right Facing Fold Down Arm**

COM	Dillon/Carson	A <sub>5</sub>	B <sub>6</sub>	C <sub>7</sub>	D <sub>8</sub>	E <sub>9</sub>	F <sub>10</sub>	G <sub>11</sub>	H <sub>12</sub>	I <sub>13</sub>
6,349	6,409	6,469	6,529	6,669	6,759	7,049	7,129	7,229	7,929	8,049

**C2127R Mobile Chaise Wingback Rocker Recliner - Infinite Position Locking Back - Right Facing Fold Down Arm**

COM	Dillon/Carson	A <sub>5</sub>	B <sub>6</sub>	C <sub>7</sub>	D <sub>8</sub>	E <sub>9</sub>	F <sub>10</sub>	G <sub>11</sub>	H <sub>12</sub>	I <sub>13</sub>
6,699	6,819	6,829	6,919	7,099	7,269	7,499	7,629	7,689	8,219	8,309

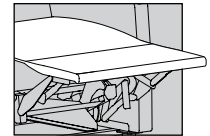

Chaise Models

**NOTE:** Transfer arm standard on right side (facing). Replace "R" with "L" in model number to specify on left side, handle will be placed on right side and vice versa.

**Dimensions**

	Overall			Seat			Back H	Arm H	Kick Out Seat D	Recline D	Distance from Wall
	W	D	H	W	D	H					
E2127R   EC2127R   E2127L   EC2127L	32.5	38	44	23.75	21.5	19.75	24.5	25	37.5	72.5	20

**General Info**

COM: 5.4 yds  
w/ Chaise COM: 5.7 yds

Wt Cap: 550 lb  
Unit Weight: 161 lb

**Available Options**

ARM CAP OPTIONS			See pg 2 for finishes	PATIENT WELLNESS & COMFORT OPTIONS		
U	Urethane		Standard	ABP	Adjustable Back Pad (COM 1.75 yds)	
J1	Solid Surface - Group 1		619		Textile Grades COM-B	459
J2	Solid Surface - Group 2		819		Textile Grades C-I	569
CASTER OPTIONS				AHP	Adjustable Head Rest Pillow (COM 1 yd)	339
3S1R3	3" - (3) Swivel/(1) Rigid Locking Casters		Standard	FBH	Foley Bag Holder	89
3S4	3" - (4) Swivel Locking Casters		19	MBB	Moisture Barrier (Back)	59
Q3	3" - Dual Wheel Central Locking System <sup>3</sup>		1649	MBS	Moisture Barrier (Seat)	59
ADDITIONAL FEATURES & OPTIONS				ML	Monitor Arm (left side facing) <sup>1,2</sup>	849
PB	Push Bar		Standard	MTL	Monitor Arm with Tray (left side facing) <sup>1,2</sup>	949
EG	Protective Edge Guard		Standard	*Refer to pg 130 for full option details and images*		
QR	Additional Quick Release Accessory Bracket		69			
CAL	CAL TB133		See pg 9			
Z	Multi Cover		Use Pricing for Highest Grade			

<sup>1</sup>Includes QR bracket connection installed on recliner  
<sup>2</sup>Standard on left side (facing). Replace "L" with "R" for right side (facing) option when specifying left side fold down arm.  
<sup>3</sup>For 4" or 5" central locking casters, please contact customer service.

Arm Cap Options

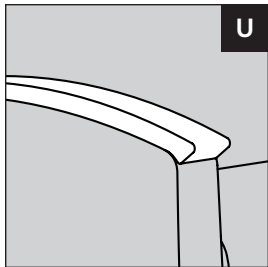

**Urethane**

Available in multiple styles (refer to product page for availability). See pg 2 for finishes.

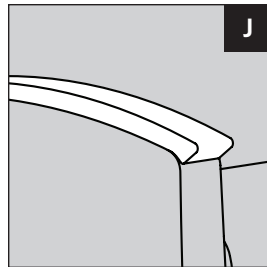

**Solid Surface**

Available in multiple styles (refer to product page for availability). See pg 2 for standard Group 1 and Group 2 finishes. Additional solid surface finishes are able to be specified, contact customer service for pricing.

Caster Options

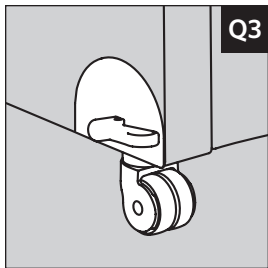

**3" Dual Wheel Central Locking Caster System**

Controlled by 2-position lever located at front of chair on left (facing) arm.

On 550 Series models, 2-position lever located at back on both sides.

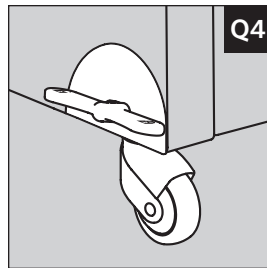

**4" Central Lock & Steer\* Caster System**

Controlled by 3-position lever located at front of chair on left (facing) arm. Steer setting locks rear casters to forward-facing orientation. Neutral setting allows all casters to swivel freely. Lock setting locks recliner into stationary position.

*\*Q4 option is non-steering on some models, see product pages for model specific info*

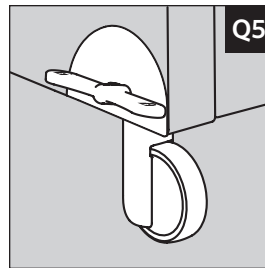

**5" Central Lock & Steer\* Caster System**

Controlled by 3-position lever located at front of chair on left (facing) arm. Steer setting locks rear casters to forward-facing orientation. Neutral setting allows all casters to swivel freely. Lock setting locks recliner into stationary position.

*\*Q5 option is non-steering on some models, see product pages for model specific info*

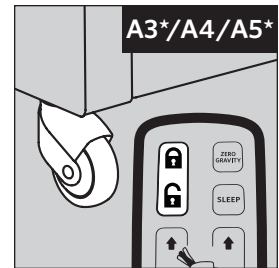

**3" / 4" / 5" Auto-Locking Central Caster System**

Controlled by lock and unlock buttons on control wand. Recliner locks into stationary position when lock button is pressed, or when recline buttons are operated. Unlock button releases casters for movement (after 5 second safety delay).

*\*4" caster style pictured. 3" & 5" caster styles match styles of Q3 & Q5 images, respectively.*

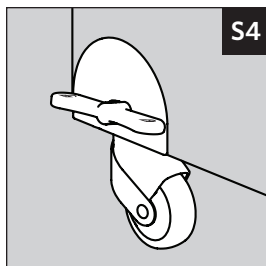

**4" Two Caster Lock & Steer**

Controlled by 3-position lever located at back of chair on left (facing) arm. Steer setting locks rear casters to forward-facing orientation. Neutral setting allows all casters to swivel freely. Lock setting locks recliner into stationary position.

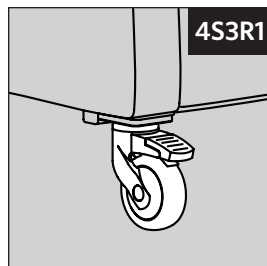

**4" (3) Swivel / (1) Rigid Individual Locking Casters**

All casters lock individually with lock tabs attached to each caster. Right front caster remains in forward facing orientation to aid in forward movement. Three remaining casters swivel 360 degrees.

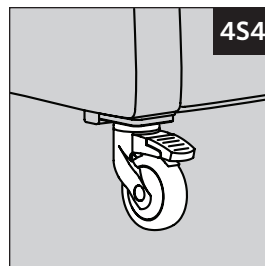

**4" (4) Swivel Individual Locking Casters**

All casters lock individually with lock tabs attached to each caster. All four casters swivel 360 degrees.

**Note:** Selecting a different caster size option than the standard on a particular model will increase or decrease the recliner seat height by the difference in caster sizes. (E.g., Exam Lift Recliners with standard 3" casters will have two inches added to seat height when the Q5 option is specified).

Heat & Massage Options

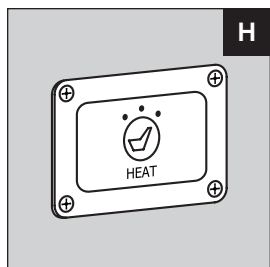

**Heat  
(In-Arm Controls)**

**IEC 60601-1 Certified.**  
Controls located inside left (facing) arm. Includes 10' cord with ground plug. Three heat settings, ranging 97° low to 105° high. Automatic shutoff after one hour.

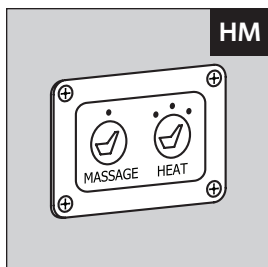

**Heat & Massage  
(In-Arm Controls)**

**IEC 60601-1 Certified.**  
Controls located inside left (facing) arm. Includes 10' cord with ground plug. Three heat settings, ranging 97° low to 105° high. Automatic shutoff after one hour (Heat) or 15 minutes (Massage).

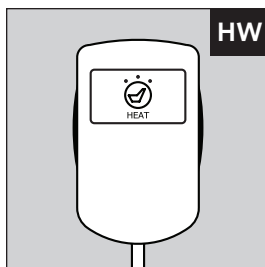

**Heat  
(Wand Controls)**

**IEC 60601-1 Certified.**  
Controls located on attached control wand. Includes 10' cord with ground plug. Three settings, ranging 97° low to 105° high. Automatic shutoff after one hour.

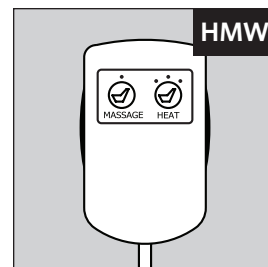

**Heat & Massage  
(Wand Controls)**

**IEC 60601-1 Certified.**  
Controls located on attached control wand. Includes 10' cord with ground plug. Three settings, ranging 97° low to 105° high. Automatic shutoff after one hour (Heat) or 15 minutes (Massage).

Patient Wellness & Comfort Options

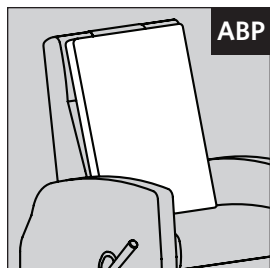

**Adjustable Back Pad**

Pad comprised of memory foam, adds additional cushioning to back. Two styles to match recliner back shape.  
**E models: ABP-E**  
**R, K, KM/L, H, wingback models: ABP-R**  
COM requires 1.75 yds.

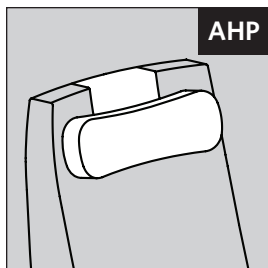

**Adjustable Head Rest Pillow**

Pillow comprised of memory foam. Weighted strap slides through push bar on back of recliner to hold pillow in desired position. Pillow and strap both upholstered in same textile as recliner back.  
COM requires 1 yd.

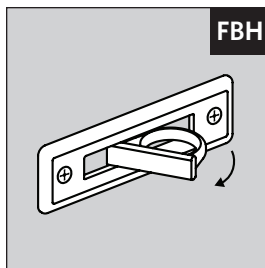

**Foley Bag Holder**

Accommodates Foley bags and other drainage bags. Closes flush with recliner when not in use. Located in arm opposite of handle side near front.

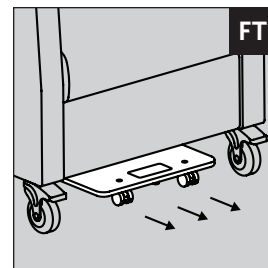

**Foot Tray**

Connected foot tray pulls out to support user's feet in seated position (not intended as step). Slides underneath recliner when not in use.

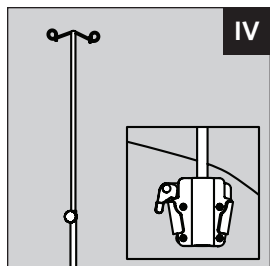

**IV Pole & Bracket**

Positioned on right (facing) arm toward back. IV pole is height adjustable. Attached via included QR Bracket.  
**Dual IV Poles (right/left): DP**



**LiquiCell**

Aids in process of helping prevent pressure ulcers. Installed in seat (underneath textile), ultra-thin cells containing liquid that is in constant motion in order to reduce shear and friction for user. Included at no charge on recliners specified with Heat & Massage or Heat options.

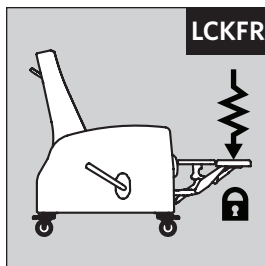

**Orthopedic Locking Footrest**

Recliner footrest locks completely into position when engaged and can only be adjusted with recline handle (or control wand on power models). Helps prevent unintentional movement of user's lower body/abdomen.

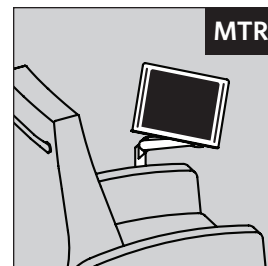

**Monitor Arm with Tray**

Adjustable arm designed to hold tablet or screen. Attached to recliner arm via included QR Bracket, standard on right side (facing). Tray/monitor connects to arm with VESA bracket.  
**Left side (facing): MTL**  
**Right side (facing), w/o Tray: MR**  
**Left side (facing), w/o Tray: ML**  
On fold down arm (adds protective strike plate): MTR67,MTL67,MR67,ML67

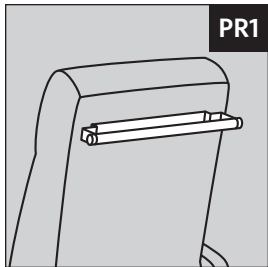

**Paper Roll Holder**  
Accommodates exam paper rolls up to 21.25" wide. Takes place of Push Bar. Paper roll sold separately.

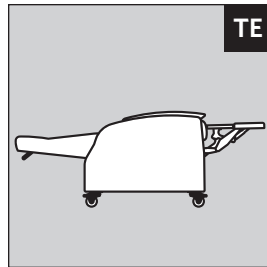

**Trendelenburg**  
Allows additional 10° recline pitch in order to elevate user's feet above head. Engaged via non-handed foot pedal (or control wand on power models).

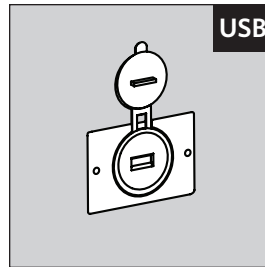

**USB Power Outlet**  
**IEC 60601-1 Certified.**  
Supplies power via USB-A port. Connected rubber plug provides protection to port when cleaning. Standard position on right (facing) arm.

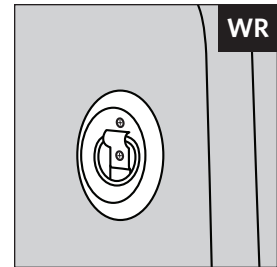

**Wrist Restraint Mounts**  
Located on outside of arms (both sides). Metal loops accommodate wrist restraints.

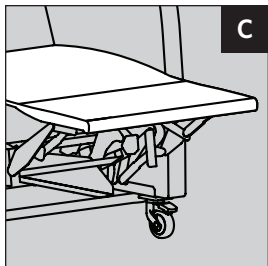

**Chaise Continuous Leg Support**  
Continuous upholstery from back of seat to end of footrest. (Non-chaise leg support utilizes separately upholstered mid-ottoman and footrest pieces)

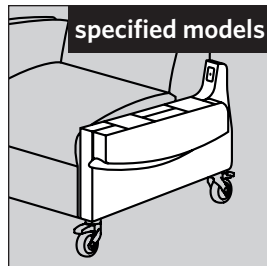

**Fold Down Transfer Arm**  
Allows lateral transfer of patient. Folding portion of arm is released by spring-loaded pull lever on back of arm. Available in left, right, or dual side configurations. When arm is in down position, adds 4" to overall width of recliner.

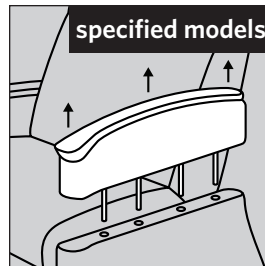

**Removable Transfer Arm**  
Allows lateral transfer of patient. Available in left, right, or dual side configurations.

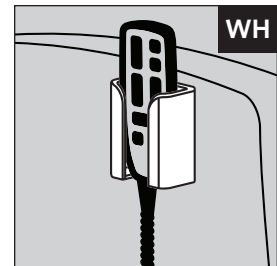

**Control Wand Holder**  
Metal holder for control wand on power healthcare recliners. Positioned on side of arm on which control wand is positioned, towards front (towards back on dual transfer arm models). Occupies same position required by adjustable side tray or monitor arm options on wand side of recliner (see pg 164 for standard wand placement).

Tray Table Options

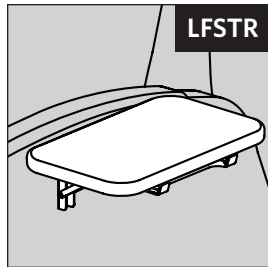

**Large Folding Side Tray**  
 Folds out to reveal table surface, standard on right side (facing). Measures 17" L x 10.7" W. Extends 2.5" from chair arm when in down position.  
**Left side (facing): LFSTR**

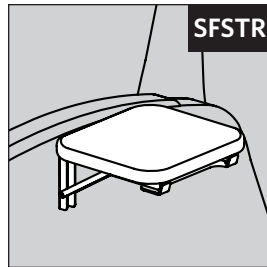

**Small Folding Side Tray**  
 Folds out to reveal table surface, standard on right side (facing). Measures 12" L x 10.7" W. Extends 2.5" from chair arm when in down position.  
**Left side (facing): SFSTR**

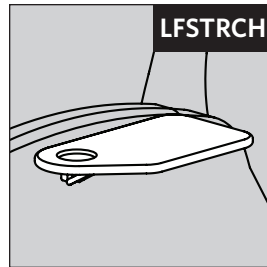

**Large Folding Cup Holder Side Tray**  
 Folds out to reveal table surface with recessed area to accommodate beverage, standard on right side (facing). Measures 23" L x 10.7" W. Extends 2.5" from chair arm when in down position.  
**Left side (facing): LFSTRCH**

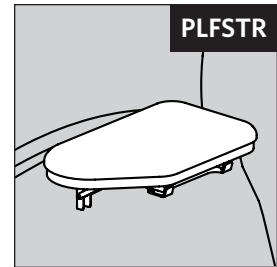

**Padded Large Folding Side Tray**  
 Folds out to reveal upholstered surface, standard on right side (facing). Padded to allow patients to comfortably rest arm during treatment. Measures 17" L x 10.7" W. Extends 2.5" from chair arm when in down position.  
**Left side (facing): PLFSTR**  
 COM requires 1 yd.

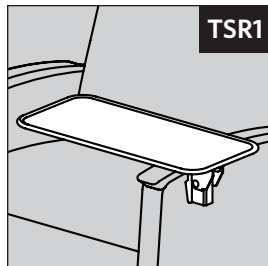

**Adjustable Side Tray**  
 Tray swivels at base and can be positioned vertically at side of arm when not in use (extends 4" from arm). Measures 23" L x 10.7" W. Attached to recliner arm via included QR Bracket, standard on right side (facing). Access to handle may be impeded when specified on handle side.  
**Left side (facing): TSR1**  
**Dual sides: TD3**

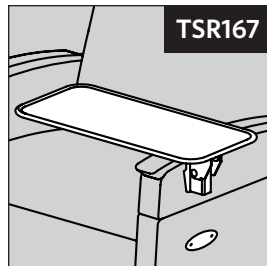

**Adjustable Side Tray (On Fold Down Arm)**  
 Same specifications as Adjustable Side Tray (TSR1), attached to fold down transfer arm. Strike plate installed on side of recliner arm to protect upholstery from QR bracket when arm is folded down.  
**Left side (facing): TSR167**  
**Dual sides: TD362**

**Standard Finish\* Folding Tray Table**



**Northern Grey**  
 To specify other available thermofoil finishes (listed on pg 2), add \$149 list to tray table option price. Solid surface also available, see individual product pages for pricing.

**Standard Finish Adjustable Side Trays**

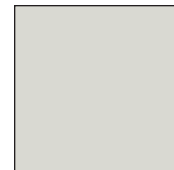

Made of phenolic material.

\*Padded Large Folding Side Tray is upholstered (in same textile as recliner arms)

Additional Features & Options

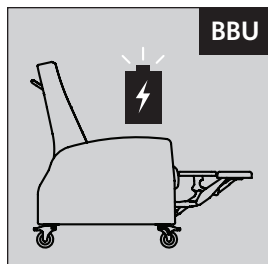

**Battery Back Up**  
 Provides back up power supply to allow recliner functions on applicable power recliners when disconnected from power source. Battery unit charges when recliner is connected to power source. Not intended as substitute for regular operational usage.

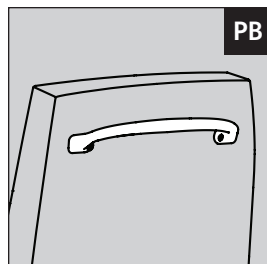

**Push Bar**  
 Aids in ease of movement of mobile healthcare recliners. Attached to back of applicable recliners.

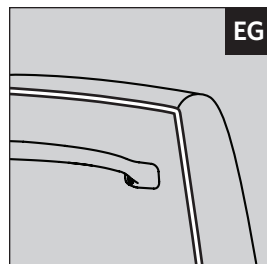

**Protective Edge Guard**  
 Plastic piping installed around back edges of recliner to protect from minor abrasions.

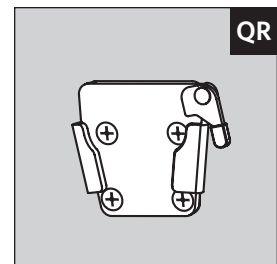

**Additional Quick Release Accessory Bracket**  
 Additional attachment bracket for IV Pole and other various accessories. (Options requiring QR Bracket include the necessary bracket/hardware) Mounted into metal insert nuts in recliner arm.

# DURABLE® 650 SERIES



## Series Overview

The Durable® 650 Series is our premier collection of mobile healthcare recliners. Featuring a patented unitized mechanism (which harmonizes motion of the back, foot rest, and seat for smooth, full-body movement), 650 lb weight capacity, full flatbed sleep position, and near limitless option configurations to adapt to any environment, the Durable® 650 Series truly encapsulates our core product values of Comfort, Durability, and Performance to make it a recliner choice trusted by patients and caregivers alike.

## General Product Information

- 650 lb Weight Rating
- Designed for 24/7 use healthcare environments
- Standard & compact/pediatric width options
- Manually operated recline functionality
- Footrest and back move in harmony when engaged
- Quick removable back & lift up seat for ease of cleaning
- True flatbed sleep position
- Sinuous spring seat and back
- Seat clean-out
- All steel base structure for maximum durability
- Mid-Ottoman Calf Support
- Infinite Position Back reclines to infinite angle positions
- All interior plywood California Carb Compliant/Phase II
- Field replaceable components

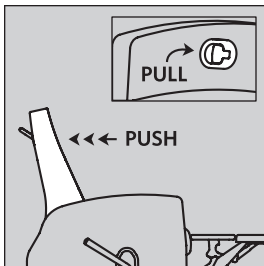

### Infinite Position Locking Back

Allows patient/caregiver to lock back into any position. Lock lever located inside left (facing) arm on applicable models, unless otherwise noted/pictured.

## To Order, Specify

- Model Number
- Textile
- Finish
- Options

## Options vary by model, see specific model page for list of available options

Refer to pg 130 for full option details and images

# DURABLE® 650 SERIES

# Mobile Healthcare Recliners | Compact

## Select Aesthetic Style *(Denotes back & arm design)*

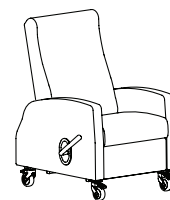
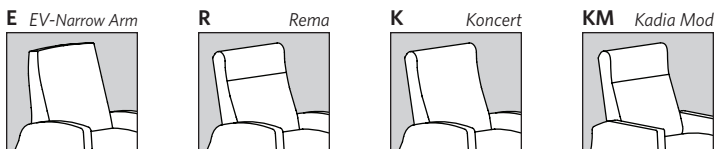

(Konkert style pictured)

## Select Functional Style *(Aesthetic style code precedes selected model number below, e.g., KC1117)*

Model	COM	Dillon	Carson	A <sub>5</sub>	B <sub>6</sub>	C <sub>7</sub>	D <sub>8</sub>	E <sub>9</sub>	F <sub>10</sub>	G <sub>11</sub>	H <sub>12</sub>	I <sub>13</sub>
<b>3017 Compact Mobile Healthcare Recliner - Infinite Position Non-Locking Back</b>	4,109	4,139	4,279	4,499	4,699	4,959	5,199	5,489	5,739	6,309	6,689	
<b>3117 Compact Mobile Healthcare Recliner - Infinite Position Locking Back</b>	4,389	4,489	4,589	4,799	5,039	5,259	5,539	5,559	5,829	6,429	6,909	
<b>C3017 Compact Mobile Healthcare Chaise Recliner - Infinite Position Non-Locking Back</b>	4,359	4,469	4,629	4,919	5,199	5,519	5,879	6,259	6,489	7,109	7,469	
<b>C3117 Compact Mobile Healthcare Chaise Recliner - Infinite Position Locking Back</b>	4,639	4,769	4,929	5,219	5,529	5,829	6,199	6,329	6,549	7,209	7,579	

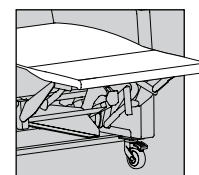

Chaise Models

## Dimensions

Model	Overall			Seat			Back H	Arm H	Kick Out Seat D	Recline D	Distance from Wall
	W	D	H	W	D	H					
E3017   E3117   EC3017   EC3117	30.5	34.5	47.5	22	21	21.5	28.5	28	40	75.5	20
R3017   R3117   RC3017   RC3117 K3017   K3117   KC3017   KC3117	31.5	38.5	47	22	21	21.5	28	28	40	76.5	20
KM3017   KM3117   KMC3017   KMC3117	31.5	38.5	47	22	21	21.5	28	26.5	39	76.5	20

### General Info

COM:	5.3 yds
w/ Chaise COM:	5.7 yds
Wt Cap:	650 lb
Unit Weight:	155 lb

## Available Options

ARM CAP OPTIONS		See pg 2 for finishes	PATIENT WELLNESS & COMFORT OPTIONS	
U	Urethane	209	ABP	Adjustable Back Pad (COM 1.75 yds) Textile Grades COM-B 459 Textile Grades C-I 569
J1	Solid Surface - Group 1	619	AHP	Adjustable Head Rest Pillow (COM 1 yd) 339
J2	Solid Surface - Group 2	819	DP	Dual IV Poles & Brackets <sup>1</sup> 498
F	Fully Upholstered Arms	Standard	FBH	Foley Bag Holder 89
CASTER OPTIONS			FT	Foot Tray 279
Q3	3" - Dual Wheel Central Locking System	1019	IV	IV Pole & Bracket <sup>1</sup> 249
Q4	4" - Central Lock & Steer System	1019	LC	LiquiCell 229
Q5	5" - Central Lock & Steer System	1139	LCKFR	Orthopedic Locking Footrest 399
S4	4" - (2) Caster Lock & Steer System	569	MBB	Moisture Barrier (Back) 59
4S3R1	4" - (3) Swivel/(1) Rigid Locking Casters	Standard	MBS	Moisture Barrier (Seat) 59
4S4	4" - (4) Swivel Locking Casters	39	MR	Monitor Arm (right side facing) <sup>1,2</sup> 849
HEAT/MASSAGE OPTIONS (IEC 60601-1 CERTIFIED)			MTR	Monitor Arm with Tray (right side facing) <sup>1,2</sup> 949
Wand Controls			PR1	Paper Roll Holder <sup>3</sup> 229
HW	Heat	1139	TE	Trendelenburg 339
HMW	Heat & Massage	1369	USB	USB Power Outlet (IEC 60601-1 Certified) 459
In-Arm Controls			WR	Wrist Restraint Mounts (pair) 229
H	Heat	849	TRAY TABLE OPTIONS	
HM	Heat & Massage	1119	TSR1	Adjustable (Right) Side Tray <sup>1,2,5</sup> 399
ADDITIONAL FEATURES & OPTIONS			TD3	Dual Adjustable Side Trays (TSR1 & TSL1) <sup>1,5</sup> 798
PB	Push Bar	Standard	LFSTR	Large Folding (Right) Side Tray <sup>4</sup> 269
EG	Protective Edge Guard	Standard	LFSTRCH	Large Folding Cup Holder (Right) Side Tray 339
QR	Additional Quick Release Accessory Bracket	69	PLFSTR	Padded Large Folding (Right) Side Tray 379
CAL	CAL TB133	See pg 9	SFSTR	Small Folding (Right) Side Tray <sup>4</sup> 269
Z	Multi Cover	Use Pricing for Highest Grade	*Refer to pg 130 for full option details and images*	

Solid Surface Trays*		
	Grp 1	Grp 2
TSR1	798	959
LFSTR	339	1099
PLFSTR	n/a	n/a
SFSTR	689	889

\*Finishes on pg 2

<sup>1</sup>Includes QR bracket connection installed on recliner

<sup>2</sup>Standard on right side (facing). Replace "R" with "L" for left side (facing) option where available.

<sup>3</sup>Takes place of Push Bar. Paper sold separately.

<sup>4</sup>Contact customer service for solid surface pricing

<sup>5</sup>Over the lap tray function recommended in seated position.



# DURABLE® 650 SERIES

# Mobile Healthcare Recliners | Compact, Patient Transfer

## Select Aesthetic Style *(Denotes back & arm design)*

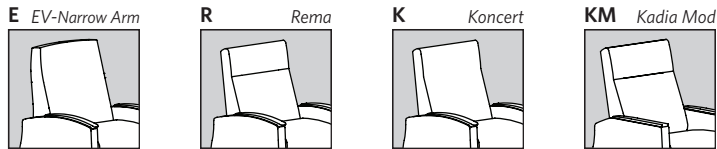

Single Fold Down Arm  
(Koncert style pictured)

## Select Functional Style *(Aesthetic style code precedes selected model number below, e.g., KC117)*

Model	COM	Dillon	Carson	A <sub>5</sub>	B <sub>6</sub>	C <sub>7</sub>	D <sub>8</sub>	E <sub>9</sub>	F <sub>10</sub>	G <sub>11</sub>	H <sub>12</sub>	I <sub>13</sub>
<b>3067 Compact Mobile Healthcare Recliner - Infinite Position Non-Locking Back - Single Fold Down Arm</b>	4,949	4,989	5,099	5,279	5,509	5,709	5,949	6,209	6,589	7,019	7,499	
<b>3167 Compact Mobile Healthcare Recliner - Infinite Position Locking Back - Single Fold Down Arm</b>	5,249	5,289	5,369	5,589	5,789	6,029	6,269	6,289	6,649	7,159	7,619	
<b>C3067 Compact Mobile Healthcare Chaise Recliner - Infinite Position Non-Locking Back - Single Fold Down Arm</b>	5,149	5,249	5,379	5,639	5,939	6,209	6,519	6,899	7,429	7,739	8,199	
<b>C3167 Compact Mobile Healthcare Chaise Recliner - Infinite Position Locking Back - Single Fold Down Arm</b>	5,459	5,539	5,679	5,959	6,239	6,539	6,879	6,969	7,489	7,969	8,429	

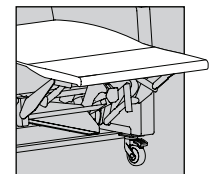

Chaise Models

**NOTE:** Transfer arm standard on right side (facing). If specified on left side, handle will be placed on right side and vice versa.

## Dimensions

Model	Overall			Seat			Back H	Arm H	Kick Out Seat D	Recline D	Distance from Wall
	W	D	H	W	D	H					
E3067   E3167   EC3067   EC3167	30.5	34.5	47.5	22	21	21.5	28.5	27	39	75.5	20
R3067   R3167   RC3067   RC3167 K3067   K3167   KC3067   KC3167	31.5	38.5	47	22	21	21.5	28	27	40	76.5	20
KM3067   KM3167   KMC3067   KMC3167	31.5	38.5	47	22	21	21.5	28	26.5	40	76.5	20

### General Info

COM: 5.2 yds  
w/ Chaise COM: 5.6 yds  
Wt Cap: 650 lb  
Unit Weight: 155 lb

## Available Options

ARM CAP OPTIONS		See pg 2 for finishes	PATIENT WELLNESS & COMFORT OPTIONS	
U	Urethane	Standard	ABP	Adjustable Back Pad (COM 1.75 yds)
J1	Solid Surface - Group 1	619		Textile Grades COM-B 459
J2	Solid Surface - Group 2	819		Textile Grades C-I 569
<b>CASTER OPTIONS</b>			AHP	Adjustable Head Rest Pillow (COM 1 yd) 339
Q3	3" - Dual Wheel Central Locking System	1019	DP	Dual IV Poles & Brackets <sup>1</sup> 498
Q4	4" - Central Lock & Steer System	1019	FBH	Foley Bag Holder 89
Q5	5" - Central Lock & Steer System	1139	FT	Foot Tray 279
S4	4" - (2) Caster Lock & Steer System	569	IV	IV Pole & Bracket <sup>1</sup> 249
4S3R1	4" - (3) Swivel/(1) Rigid Locking Casters	Standard	LC	LiquiCell 229
4S4	4" - (4) Swivel Locking Casters	39	LCKFR	Orthopedic Locking Footrest 399
<b>HEAT/MASSAGE OPTIONS (IEC 60601-1 CERTIFIED)</b>			MBB	Moisture Barrier (Back) 59
<i>Wand Controls</i>			MBS	Moisture Barrier (Seat) 59
HW	Heat	1139	MR67	Monitor Arm, on Fold Down Arm <sup>1,2</sup> 899
HMW	Heat & Massage	1369	MTR67	Monitor Arm with Tray, on Fold Down Arm <sup>1,2</sup> 999
<i>In-Arm Controls</i>			PR1	Paper Roll Holder <sup>3</sup> 229
H	Heat	849	TE	Trendelenburg 339
HM	Heat & Massage	1119	USB	USB Power Outlet (IEC 60601-1 Certified) 459
<b>ADDITIONAL FEATURES &amp; OPTIONS</b>			WR	Wrist Restraint Mounts (pair) 229
PB	Push Bar	Standard	<b>TRAY TABLE OPTIONS</b>	
EG	Protective Edge Guard	Standard	TSL1	Adjustable (Left) Side Tray, on Stationary Arm <sup>15</sup> 399
QR	Additional Quick Release Accessory Bracket	69	TSR167	Adjustable (Right) Side Tray, on Fold Down Arm <sup>15</sup> 449
CAL	CAL TB133	See pg 9	<b>FOLD DOWN TRANSFER ARM SPECIFIC</b>	
Z	Multi Cover	Use Pricing for Highest Grade	HC	Hinge Cover Standard

\*Refer to pg 130 for full option details and images\*

<sup>1</sup>Includes QR bracket connection installed on recliner

<sup>2</sup>Standard on right side (facing). Replace "R" with "L" for left side (facing) option where available.

<sup>3</sup>Takes place of Push Bar. Paper sold separately.

<sup>4</sup>Contact customer service for solid surface pricing

<sup>5</sup>Over the lap tray function recommended in seated position.









# DURABLE® 650 SERIES

# Mobile Healthcare Recliners | Kadia Luxe

Select Aesthetic Style (Denotes back & arm design)

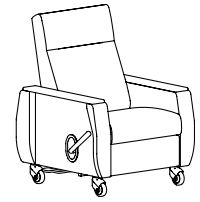
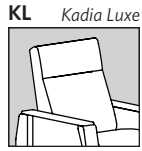

Select Functional Style (Aesthetic style code precedes selected model number below, e.g., KC1117)

**KL1017 Kadia Luxe Mobile Healthcare Recliner - Infinite Position Non-Locking Back**

COM	Dillon	Carson	A <sub>5</sub>	B <sub>6</sub>	C <sub>7</sub>	D <sub>8</sub>	E <sub>9</sub>	F <sub>10</sub>	G <sub>11</sub>	H <sub>12</sub>	I <sub>13</sub>
6,399	6,449	6,509	6,579	6,609	6,779	6,839	6,979	7,229	7,629	8,079	

**KL1117 Kadia Luxe Mobile Healthcare Recliner - Infinite Position Locking Back**

COM	Dillon	Carson	A <sub>5</sub>	B <sub>6</sub>	C <sub>7</sub>	D <sub>8</sub>	E <sub>9</sub>	F <sub>10</sub>	G <sub>11</sub>	H <sub>12</sub>	I <sub>13</sub>
6,679	6,759	6,769	6,859	6,939	7,099	7,179	7,299	7,549	8,159	8,749	

**KLC1017 Kadia Luxe Mobile Healthcare Chaise Recliner - Infinite Position Non-Locking Back**

COM	Dillon	Carson	A <sub>5</sub>	B <sub>6</sub>	C <sub>7</sub>	D <sub>8</sub>	E <sub>9</sub>	F <sub>10</sub>	G <sub>11</sub>	H <sub>12</sub>	I <sub>13</sub>
6,649	6,739	6,809	7,009	7,099	7,359	7,489	7,749	8,129	8,529	8,959	

**KLC1117 Kadia Luxe Mobile Healthcare Chaise Recliner - Infinite Position Locking Back**

COM	Dillon	Carson	A <sub>5</sub>	B <sub>6</sub>	C <sub>7</sub>	D <sub>8</sub>	E <sub>9</sub>	F <sub>10</sub>	G <sub>11</sub>	H <sub>12</sub>	I <sub>13</sub>
6,949	7,059	7,109	7,299	7,429	7,679	7,849	8,069	8,459	8,969	9,449	

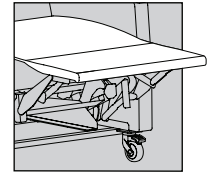

Chaise Models

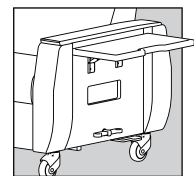

Side Detail <sup>4</sup>

## Dimensions

KL1017   KL1117   KLC1017   KLC1117	Overall			Seat			Back H	Arm H	Kick Out Seat D	Recline D	Distance from Wall
	W	D	H	W	D	H					
	35	39	47	24	22	21.5	28	26.5	40	76.5	17.5

### General Info

COM:	4.9 yds
w/ Chaise COM:	5.3 yds
Wt Cap:	650 lb
Unit Weight:	208 lb

## Available Options

### ARM CAP OPTIONS

See pg 2 for finishes

U	Urethane	Standard
J1	Solid Surface - Group 1	1239
J2	Solid Surface - Group 2	1439
T	Thermofoil	229

### CASTER OPTIONS

Q3	3" - Dual Wheel Central Locking System	No Charge
Q4	4" - Central Lock & Steer System	Standard
Q5	5" - Central Lock & Steer System	119

### HEAT/MASSAGE OPTIONS (IEC 60601-1 CERTIFIED)

<i>Wand Controls</i>		
HW	Heat	1139
HMW	Heat & Massage	1369
<i>In-Arm Controls</i>		
H	Heat	849
HM	Heat & Massage	1119

### ADDITIONAL FEATURES & OPTIONS

PB	Push Bar	Standard
EG	Protective Edge Guard	Standard
QR	Additional Quick Release Accessory Bracket	69
CAL	CAL TB133	See pg 9
Z	Multi Cover	Use Pricing for Highest Grade

### PATIENT WELLNESS & COMFORT OPTIONS

ABP	Adjustable Back Pad (COM 1.75 yds)	
	Textile Grades COM-B	459
	Textile Grades C-I	569
AHP	Adjustable Head Rest Pillow (COM 1 yd)	339
DP	Dual IV Poles & Brackets <sup>1</sup>	498
FBH	Foley Bag Holder	89
FT	Foot Tray	279
IV	IV Pole & Bracket <sup>1</sup>	249
LC	LiquiCell	229
LCKFR	Orthopedic Locking Footrest	399
MBB	Moisture Barrier (Back)	59
MBS	Moisture Barrier (Seat)	59
MR	Monitor Arm (right side facing) <sup>1,2</sup>	849
MTR	Monitor Arm with Tray (right side facing) <sup>1,2</sup>	949
PR1	Paper Roll Holder <sup>3</sup>	229
TE	Trendelenburg	339
USB	USB Power Outlet (IEC 60601-1 Certified)	459

### TRAY TABLE OPTIONS

KL-FST	Kadia Luxe Folding Side Tray <sup>4</sup>	Standard
--------	---	----------

\*Refer to pg 130 for full option details and images\*

<sup>1</sup>Includes QR bracket connection installed on recliner

<sup>2</sup>Standard on right side (facing). Replace "R" with "L" for left side (facing) option where available.

<sup>3</sup>Takes place of Push Bar. Paper sold separately.

<sup>4</sup>Side panels & folding side tray standard with thermofoil finish. See pg 2 for available finishes.



# DURABLE® 650 SERIES

# Mobile Healthcare Recliners

Select Aesthetic Style (Denotes back & arm design)

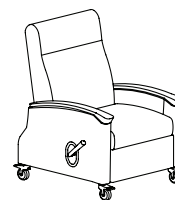
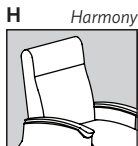

Select Functional Style (Aesthetic style code precedes selected model number below, e.g., KC1117)

**5017 Mobile Healthcare Recliner - Infinite Position Non-Locking Back**

COM	Dillon/Carson	A <sub>5</sub>	B <sub>6</sub>	C <sub>7</sub>	D <sub>8</sub>	E <sub>9</sub>	F <sub>10</sub>	G <sub>11</sub>	H <sub>12</sub>	I <sub>13</sub>
4,519	4,569	4,669	4,859	5,079	5,289	5,519	5,789	6,169	6,769	7,129

**5117 Mobile Healthcare Recliner - Infinite Position Locking Back**

COM	Dillon/Carson	A <sub>5</sub>	B <sub>6</sub>	C <sub>7</sub>	D <sub>8</sub>	E <sub>9</sub>	F <sub>10</sub>	G <sub>11</sub>	H <sub>12</sub>	I <sub>13</sub>
4,879	4,919	5,029	5,229	5,449	5,679	5,929	6,149	6,469	7,099	7,469

**C5017 Mobile Healthcare Chaise Recliner - Infinite Position Non-Locking Back**

COM	Dillon/Carson	A <sub>5</sub>	B <sub>6</sub>	C <sub>7</sub>	D <sub>8</sub>	E <sub>9</sub>	F <sub>10</sub>	G <sub>11</sub>	H <sub>12</sub>	I <sub>13</sub>
4,769	4,859	4,999	5,269	5,579	5,879	6,179	6,569	6,909	7,539	7,889

**C5117 Mobile Healthcare Chaise Recliner - Infinite Position Locking Back**

COM	Dillon/Carson	A <sub>5</sub>	B <sub>6</sub>	C <sub>7</sub>	D <sub>8</sub>	E <sub>9</sub>	F <sub>10</sub>	G <sub>11</sub>	H <sub>12</sub>	I <sub>13</sub>
5,129	5,209	5,349	5,639	5,949	6,249	6,579	6,929	7,209	7,779	8,129

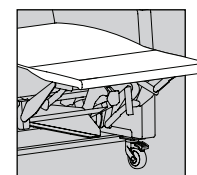

Chaise Models

### Dimensions

Model	Overall			Seat			Back H	Arm H	Kick Out Seat D	Recline D	Distance from Wall
	W	D	H	W	D	H					
H5017   H5117   HC5017   HC5117	34	38	47	24	21	21.5	26	28	40	76	20

#### General Info

COM: 5.2 yds  
w/ Chaise COM: 5.7 yds  
Wt Cap: 650 lb  
Unit Weight: 168 lb

### Available Options

**ARM CAP OPTIONS**

See pg 2 for finishes

U	Urethane (black only in Harmony style)	Standard
---	--	----------

**CASTER OPTIONS**

S4	4" - (2) Caster Lock & Steer System	569
4S3R1	4" - (3) Swivel/(1) Rigid Locking Casters	Standard
4S4	4" - (4) Swivel Locking Casters	39

**HEAT/MESSAGE OPTIONS (IEC 60601-1 CERTIFIED)**

*Wand Controls*

HW	Heat	1139
HMW	Heat & Massage	1369

*In-Arm Controls*

H	Heat	849
HM	Heat & Massage	1119

**ADDITIONAL FEATURES & OPTIONS**

PB	Push Bar	Standard
EG	Protective Edge Guard	Standard
QR	Additional Quick Release Accessory Bracket	69
CAL	CAL TB133	See pg 9
Z	Multi Cover	Use Pricing for Highest Grade

**PATIENT WELLNESS & COMFORT OPTIONS**

ABP	Adjustable Back Pad (COM 1.75 yds)	
	Textile Grades COM-B	459
	Textile Grades C-I	569
AHP	Adjustable Head Rest Pillow (COM 1 yd)	339
DP	Dual IV Poles & Brackets <sup>1</sup>	498
FBH	Foley Bag Holder	89
FT	Foot Tray	279
IV	IV Pole & Bracket <sup>1</sup>	249
LC	LiquiCell	229
LCKFR	Orthopedic Locking Footrest	399
MBB	Moisture Barrier (Back)	59
MBS	Moisture Barrier (Seat)	59
MR	Monitor Arm (right side facing) <sup>1,2</sup>	849
MTR	Monitor Arm with Tray (right side facing) <sup>1,2</sup>	949
PR1	Paper Roll Holder <sup>3</sup>	229
TE	Trendelenburg	339
USB	USB Power Outlet (IEC 60601-1 Certified)	459
WR	Wrist Restraint Mounts (pair)	229

**TRAY TABLE OPTIONS**

Option	Description	Price	Solid Surface Trays*	
			Grp 1	Grp 2
TSR1	Adjustable (Right) Side Tray <sup>1,2,5</sup>	399	798	739
TD3	Dual Adjustable Side Trays (TSR1 & TSL1) <sup>1,5</sup>	298	739	959
LFSTR	Large Folding (Right) Side Tray <sup>4</sup>	369	849	1099
LFSTRCH	Large Folding Cup Holder (Right) Side Tray	339	n/a	n/a
PLFSTR	Padded Large Folding (Right) Side Tray	379	689	889
SFSTR	Small Folding (Right) Side Tray <sup>4</sup>	269		

\*Refer to pg 130 for full option details and images\*

\*Finishes on pg 2

<sup>1</sup>Includes QR bracket connection installed on recliner

<sup>2</sup>Standard on right side (facing). Replace "R" with "L" for left side (facing) option where available.

<sup>3</sup>Takes place of Push Bar. Paper sold separately.

<sup>4</sup>Contact customer service for solid surface pricing

<sup>5</sup>Over the lap tray function recommended in seated position.



# DURABLE® 650 SERIES

# Mobile Healthcare Recliners | Wingback

Select Aesthetic Style (Denotes back & arm design)

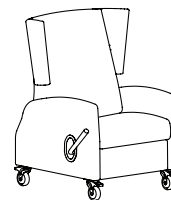
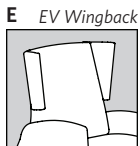

Select Functional Style (Aesthetic style code precedes selected model number below, e.g., KC1117)

**2017 Mobile Healthcare Wingback Recliner - Infinite Position Non-Locking Back**

COM	Dillon/Carson	A <sub>5</sub>	B <sub>6</sub>	C <sub>7</sub>	D <sub>8</sub>	E <sub>9</sub>	F <sub>10</sub>	G <sub>11</sub>	H <sub>12</sub>	I <sub>13</sub>
5,119	5,169	5,269	5,479	5,689	5,879	6,149	6,369	6,579	7,079	7,339

**2117 Mobile Healthcare Wingback Recliner - Infinite Position Locking Back**

COM	Dillon/Carson	A <sub>5</sub>	B <sub>6</sub>	C <sub>7</sub>	D <sub>8</sub>	E <sub>9</sub>	F <sub>10</sub>	G <sub>11</sub>	H <sub>12</sub>	I <sub>13</sub>
5,409	5,479	5,549	5,769	5,979	6,209	6,469	6,739	6,859	7,319	7,579

**C2017 Mobile Healthcare Wingback Chaise Recliner - Infinite Position Non-Locking Back**

COM	Dillon/Carson	A <sub>5</sub>	B <sub>6</sub>	C <sub>7</sub>	D <sub>8</sub>	E <sub>9</sub>	F <sub>10</sub>	G <sub>11</sub>	H <sub>12</sub>	I <sub>13</sub>
5,399	5,479	5,629	5,889	6,189	6,469	6,799	7,139	7,199	7,669	8,019

**C2117 Mobile Healthcare Wingback Chaise Recliner - Infinite Position Locking Back**

COM	Dillon/Carson	A <sub>5</sub>	B <sub>6</sub>	C <sub>7</sub>	D <sub>8</sub>	E <sub>9</sub>	F <sub>10</sub>	G <sub>11</sub>	H <sub>12</sub>	I <sub>13</sub>
5,679	5,769	5,929	6,209	6,489	6,779	7,149	7,509	7,809	8,109	8,469

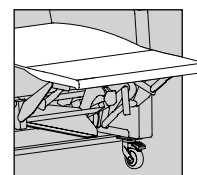

Chaise Models

### Dimensions

E2017   E2117   EC2017   EC2117	Overall			Seat			Back H	Arm H	Kick Out Seat D	Recline D	Distance from Wall
	W	D	H	W	D	H					
	33.5	34.5	47.5	24	21	21.5	28.5	28	40	75.5	20

#### General Info

COM: 5.6 yds  
w/ Chaise COM: 6 yds  
Wt Cap: 650 lb  
Unit Weight: 176 lb

### Available Options

**ARM CAP OPTIONS**

See pg 2 for finishes

U	Urethane	209
J1	Solid Surface - Group 1	619
J2	Solid Surface - Group 2	819
F	Fully Upholstered Arms	Standard

**CASTER OPTIONS**

Q3	3" - Dual Wheel Central Locking System	1019
Q4	4" - Central Lock & Steer System	1019
Q5	5" - Central Lock & Steer System	1139
S4	4" - (2) Caster Lock & Steer System	569
4S3R1	4" - (3) Swivel/(1) Rigid Locking Casters	Standard
4S4	4" - (4) Swivel Locking Casters	39

**HEAT/MASSAGE OPTIONS (IEC 60601-1 CERTIFIED)**

*Wand Controls*

HW	Heat	1139
HMW	Heat & Massage	1369

*In-Arm Controls*

H	Heat	849
HM	Heat & Massage	1119

**ADDITIONAL FEATURES & OPTIONS**

PB	Push Bar	Standard
EG	Protective Edge Guard	Standard
QR	Additional Quick Release Accessory Bracket	69
CAL	CAL TB133	See pg 9
Z	Multi Cover	Use Pricing for Highest Grade

**PATIENT WELLNESS & COMFORT OPTIONS**

ABP	Adjustable Back Pad (COM 1.75 yds)	
	Textile Grades COM-B	459
	Textile Grades C-I	569
AHP	Adjustable Head Rest Pillow (COM 1 yd)	339
DP	Dual IV Poles & Brackets <sup>1</sup>	498
FBH	Foley Bag Holder	89
FT	Foot Tray	279
IV	IV Pole & Bracket <sup>1</sup>	249
LC	LiquiCell	229
LCKFR	Orthopedic Locking Footrest	399
MBB	Moisture Barrier (Back)	59
MBS	Moisture Barrier (Seat)	59
MR	Monitor Arm (right side facing) <sup>1,2</sup>	849
MTR	Monitor Arm with Tray (right side facing) <sup>1,2</sup>	949
PR1	Paper Roll Holder <sup>3</sup>	229
TE	Trendelenburg	339
USB	USB Power Outlet (IEC 60601-1 Certified)	459
WR	Wrist Restraint Mounts (pair)	229

**TRAY TABLE OPTIONS**

TSR1	Adjustable (Right) Side Tray <sup>1,2,5</sup>	399	Solid Surface Trays*	
TD3	Dual Adjustable Side Trays (TSR1 & TSL1) <sup>1,5</sup>	798	Grp 1	Grp 2
LFSTR	Large Folding (Right) Side Tray <sup>4</sup>	269	739	959
LFSTRCH	Large Folding Cup Holder (Right) Side Tray	339	849	1099
PLFSTR	Padded Large Folding (Right) Side Tray	379	n/a	n/a
SFSTR	Small Folding (Right) Side Tray <sup>4</sup>	269	689	889

\*Refer to pg 130 for full option details and images\*

\*Finishes on pg 2

<sup>1</sup>Includes QR bracket connection installed on recliner

<sup>2</sup>Standard on right side (facing). Replace "R" with "L" for left side (facing) option where available.

<sup>3</sup>Takes place of Push Bar. Paper sold separately.

<sup>4</sup>Contact customer service for solid surface pricing

<sup>5</sup>Over the lap tray function recommended in seated position.



# DURABLE® 650 SERIES

# Mobile Healthcare Recliners | Patient Transfer

## Select Aesthetic Style *(Denotes back & arm design)*

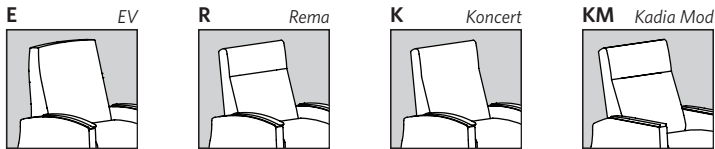

Single Fold Down Arm  
(Koncert style pictured)

## Select Functional Style *(Aesthetic style code precedes selected model number below, e.g., KC1117)*

### 1067 Mobile Healthcare Recliner - Infinite Position Non-Locking Back - Single Fold Down Arm

COM	Dillon/Carson	A <sub>5</sub>	B <sub>6</sub>	C <sub>7</sub>	D <sub>8</sub>	E <sub>9</sub>	F <sub>10</sub>	G <sub>11</sub>	H <sub>12</sub>	I <sub>13</sub>
5,019	5,029	5,149	5,329	5,559	5,749	5,999	6,259	6,629	6,929	7,269

### 1167 Mobile Healthcare Recliner - Infinite Position Locking Back - Single Fold Down Arm

COM	Dillon/Carson	A <sub>5</sub>	B <sub>6</sub>	C <sub>7</sub>	D <sub>8</sub>	E <sub>9</sub>	F <sub>10</sub>	G <sub>11</sub>	H <sub>12</sub>	I <sub>13</sub>
5,299	5,339	5,449	5,639	5,859	6,079	6,329	6,589	6,919	7,269	7,609

### C1067 Mobile Healthcare Chaise Recliner - Infinite Position Non-Locking Back - Single Fold Down Arm

COM	Dillon/Carson	A <sub>5</sub>	B <sub>6</sub>	C <sub>7</sub>	D <sub>8</sub>	E <sub>9</sub>	F <sub>10</sub>	G <sub>11</sub>	H <sub>12</sub>	I <sub>13</sub>
5,199	5,289	5,469	5,699	5,999	6,259	6,639	6,949	7,479	7,849	8,299

### C1167 Mobile Healthcare Chaise Recliner - Infinite Position Locking Back - Single Fold Down Arm

COM	Dillon/Carson	A <sub>5</sub>	B <sub>6</sub>	C <sub>7</sub>	D <sub>8</sub>	E <sub>9</sub>	F <sub>10</sub>	G <sub>11</sub>	H <sub>12</sub>	I <sub>13</sub>
5,519	5,589	5,729	6,019	6,279	6,579	6,929	7,269	7,749	8,069	8,549

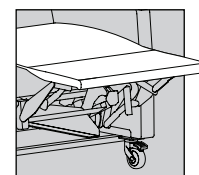

Chaise Models

**NOTE:** Transfer arm standard on right side (facing). If specified on left side, handle will be placed on right side and vice versa.

## Dimensions

E1067   E1167   EC1067   EC1167	Overall			Seat			Back H	Arm H	Kick Out Seat D	Recline D	Distance from Wall
	W	D	H	W	D	H					
R1067   R1167   RC1067   RC1167	33.5	34.5	47.5	24	21	21.5	28.5	27	40	75.5	20
K1067   K1167   KC1067   KC1167	33.5	38.5	47	24	21	21.5	28	27	40	76.5	20
KM1067   KM1167   KMC1067   KMC1167	33.5	38.5	47	24	22	22	28	26.5	40	76.5	20

### General Info

COM:	5.4 yds
w/ Chaise COM:	5.8 yds
Wt Cap:	650 lb
Unit Weight:	167 lb

## Available Options

### ARM CAP OPTIONS

See pg 2 for finishes

U	Urethane	Standard
J1	Solid Surface - Group 1	619
J2	Solid Surface - Group 2	819

### CASTER OPTIONS

Q3	3" - Dual Wheel Central Locking System	1019
Q4	4" - Central Lock & Steer System	1019
Q5	5" - Central Lock & Steer System	1139
S4	4" - (2) Caster Lock & Steer System	569
4S3R1	4" - (3) Swivel/(1) Rigid Locking Casters	Standard
4S4	4" - (4) Swivel Locking Casters	39

### HEAT/MESSAGE OPTIONS (IEC 60601-1 CERTIFIED)

#### Wand Controls

HW	Heat	1139
HMW	Heat & Massage	1369

#### In-Arm Controls

H	Heat	849
HM	Heat & Massage	1119

### ADDITIONAL FEATURES & OPTIONS

PB	Push Bar	Standard
EG	Protective Edge Guard	Standard
QR	Additional Quick Release Accessory Bracket	69
CAL	CAL TB133	See pg 9
Z	Multi Cover	Use Pricing for Highest Grade

### PATIENT WELLNESS & COMFORT OPTIONS

ABP	Adjustable Back Pad (COM 1.75 yds)	
	Textile Grades COM-B	459
	Textile Grades C-I	569
AHP	Adjustable Head Rest Pillow (COM 1 yd)	339
DP	Dual IV Poles & Brackets <sup>1</sup>	498
FBH	Foley Bag Holder	89
FT	Foot Tray	279
IV	IV Pole & Bracket <sup>1</sup>	249
LC	LiquiCell	229
LCKFR	Orthopedic Locking Footrest	399
MBB	Moisture Barrier (Back)	59
MBS	Moisture Barrier (Seat)	59
MR67	Monitor Arm, on Fold Down Arm <sup>1,2</sup>	899
MTR67	Monitor Arm with Tray, on Fold Down Arm <sup>1,2</sup>	999
PR1	Paper Roll Holder <sup>3</sup>	229
TE	Trendelenburg	339
USB	USB Power Outlet (IEC 60601-1 Certified)	459
WR	Wrist Restraint Mounts (pair)	229

### TRAY TABLE OPTIONS

TSL1	Adjustable (Left) Side Tray, on Stationary Arm <sup>1,5</sup>	399
TSR167	Adjustable (Right) Side Tray, on Fold Down Arm <sup>1,5</sup>	449

### FOLD DOWN TRANSFER ARM SPECIFIC

HC	Hinge Cover	Standard
----	-------------	----------

\*Refer to pg 130 for full option details and images\*

<sup>1</sup>Includes QR bracket connection installed on recliner

<sup>2</sup>Standard on right side (facing). Replace "R" with "L" for left side (facing) option where available.

<sup>3</sup>Takes place of Push Bar. Paper sold separately.

<sup>4</sup>Contact customer service for solid surface pricing

<sup>5</sup>Over the lap tray function recommended in seated position.



# DURABLE® 650 SERIES

# Mobile Healthcare Recliners | Patient Transfer

Select Aesthetic Style (Denotes back & arm design)

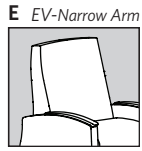

Single Fold Down Arm

Select Functional Style (Aesthetic style code precedes selected model number below, e.g., KC117)

Model	COM	Dillon	Carson	A <sub>5</sub>	B <sub>6</sub>	C <sub>7</sub>	D <sub>8</sub>	E <sub>9</sub>	F <sub>10</sub>	G <sub>11</sub>	H <sub>12</sub>	I <sub>13</sub>
<b>4067 Mobile Healthcare Recliner - Narrow Arms - Infinite Position Non-Locking Back - Single Fold Down Arm</b>	4,949	4,989	5,099	5,279	5,509	5,709	5,949	6,209	6,589	7,019	7,499	
<b>4167 Mobile Healthcare Recliner - Narrow Arms - Infinite Position Locking Back - Single Fold Down Arm</b>	5,249	5,289	5,369	5,589	5,789	6,029	6,269	6,289	6,649	7,109	7,499	
<b>C4067 Mobile Healthcare Chaise Recliner - Narrow Arms - Infinite Position Non-Locking Back - Single Fold Down Arm</b>	5,149	5,249	5,379	5,639	5,939	6,209	6,519	6,899	7,429	7,739	8,199	
<b>C4167 Mobile Healthcare Chaise Recliner - Narrow Arms - Infinite Position Locking Back - Single Fold Down Arm</b>	5,459	5,539	5,679	5,959	6,239	6,539	6,879	6,969	7,489	7,969	8,429	

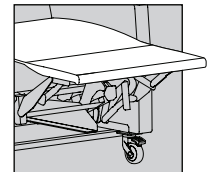

Chaise Models

**NOTE:** Transfer arm standard on right side (facing). If specified on left side, handle will be placed on right side and vice versa.

## Dimensions

Model	Overall			Seat			Back H	Arm H	Kick Out Seat D	Recline D	Distance from Wall
	W	D	H	W	D	H					
E4067   E4167   EC4067   EC4167	32.5	34.5	47.5	24	21	21.5	28.5	27	39	75.5	20

### General Info

COM:	5.3 yds
w/ Chaise COM:	5.8 yds
Wt Cap:	650 lb
Unit Weight:	155 lb

## Available Options

ARM CAP OPTIONS		See pg 2 for finishes	PATIENT WELLNESS & COMFORT OPTIONS	
U	Urethane	Standard	ABP	Adjustable Back Pad (COM 1.75 yds)
J1	Solid Surface - Group 1	619		Textile Grades COM-B
J2	Solid Surface - Group 2	819		Textile Grades C-I
CASTER OPTIONS			AHP	Adjustable Head Rest Pillow (COM 1 yd)
Q3	3" - Dual Wheel Central Locking System	1019	DP	Dual IV Poles & Brackets <sup>1</sup>
Q4	4" - Central Lock & Steer System	1019	FBH	Foley Bag Holder
Q5	5" - Central Lock & Steer System	1139	FT	Foot Tray
S4	4" - (2) Caster Lock & Steer System	569	IV	IV Pole & Bracket <sup>1</sup>
4S3R1	4" - (3) Swivel/(1) Rigid Locking Casters	Standard	LC	LiquiCell
4S4	4" - (4) Swivel Locking Casters	39	LCKFR	Orthopedic Locking Footrest
HEAT/MASSAGE OPTIONS (IEC 60601-1 CERTIFIED)			MBB	Moisture Barrier (Back)
Wand Controls			MBS	Moisture Barrier (Seat)
HW	Heat	1139	MR67	Monitor Arm, on Fold Down Arm <sup>1,2</sup>
HMW	Heat & Massage	1369	MTR67	Monitor Arm with Tray, on Fold Down Arm <sup>1,2</sup>
In-Arm Controls			PR1	Paper Roll Holder <sup>3</sup>
H	Heat	849	TE	Trendelenburg
HM	Heat & Massage	1119	USB	USB Power Outlet (IEC 60601-1 Certified)
ADDITIONAL FEATURES & OPTIONS			WR	Wrist Restraint Mounts (pair)
PB	Push Bar	Standard	TRAY TABLE OPTIONS	
EG	Protective Edge Guard	Standard	TSL1	Adjustable (Left) Side Tray, on Stationary Arm <sup>1,5</sup>
QR	Additional Quick Release Accessory Bracket	69	TSR167	Adjustable (Right) Side Tray, on Fold Down Arm <sup>1,5</sup>
CAL	CAL TB133	See pg 9	FOLD DOWN TRANSFER ARM SPECIFIC	
Z	Multi Cover	Use Pricing for Highest Grade	HC	Hinge Cover

\*Refer to pg 130 for full option details and images\*

<sup>1</sup>Includes QR bracket connection installed on recliner

<sup>2</sup>Standard on right side (facing). Replace "R" with "L" for left side (facing) option where available.

<sup>3</sup>Takes place of Push Bar. Paper sold separately.

<sup>4</sup>Contact customer service for solid surface pricing

<sup>5</sup>Over the lap tray function recommended in seated position.



# DURABLE® 650 SERIES

# Mobile Healthcare Recliners | Patient Transfer, Wingback

Select Aesthetic Style (Denotes back & arm design)

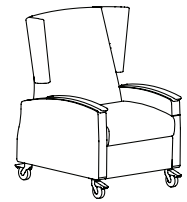

Single Fold Down Arm

Select Functional Style (Aesthetic style code precedes selected model number below, e.g., KC117)

**2067 Mobile Healthcare Wingback Recliner - Infinite Position Non-Locking Back - Single Fold Down Arm**

COM	Dillon/Carson	A <sub>5</sub>	B <sub>6</sub>	C <sub>7</sub>	D <sub>8</sub>	E <sub>9</sub>	F <sub>10</sub>	G <sub>11</sub>	H <sub>12</sub>	I <sub>13</sub>
5,969	6,019	6,059	6,269	6,449	6,619	6,879	7,079	7,309	7,739	8,189

**2167 Mobile Healthcare Wingback Recliner - Infinite Position Locking Back - Single Fold Down Arm**

COM	Dillon/Carson	A <sub>5</sub>	B <sub>6</sub>	C <sub>7</sub>	D <sub>8</sub>	E <sub>9</sub>	F <sub>10</sub>	G <sub>11</sub>	H <sub>12</sub>	I <sub>13</sub>
6,239	6,269	6,339	6,539	6,729	6,959	7,189	7,429	7,599	8,069	8,489

**C2067 Mobile Healthcare Chaise Wingback Recliner - Infinite Position Non-Locking Back - Single Fold Down Arm**

COM	Dillon/Carson	A <sub>5</sub>	B <sub>6</sub>	C <sub>7</sub>	D <sub>8</sub>	E <sub>9</sub>	F <sub>10</sub>	G <sub>11</sub>	H <sub>12</sub>	I <sub>13</sub>
6,159	6,209	6,339	6,609	6,869	7,139	7,459	7,759	8,149	8,549	8,999

**C2167 Mobile Healthcare Chaise Wingback Recliner - Infinite Position Locking Back - Single Fold Down Arm**

COM	Dillon/Carson	A <sub>5</sub>	B <sub>6</sub>	C <sub>7</sub>	D <sub>8</sub>	E <sub>9</sub>	F <sub>10</sub>	G <sub>11</sub>	H <sub>12</sub>	I <sub>13</sub>
6,459	6,519	6,629	6,879	7,179	7,459	7,769	8,109	8,439	8,769	9,209

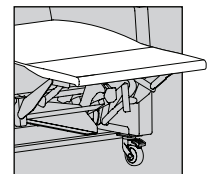

Chaise Models

**NOTE:** Transfer arm standard on right side (facing). If specified on left side, handle will be placed on right side and vice versa.

## Dimensions

E2067   E2167   EC2067   EC2167	Overall			Seat			Back H	Arm H	Kick Out Seat D	Recline D	Distance from Wall
	W	D	H	W	D	H					
	33.5	34.5	47.5	24	21	21.5	28.5	27	39	75.5	20

### General Info

COM:	5.9 yds
w/ Chaise COM:	6.3 yds
Wt Cap:	650 lb
Unit Weight:	188 lb

## Available Options

### ARM CAP OPTIONS

See pg 2 for finishes

U	Urethane	Standard
J1	Solid Surface - Group 1	619
J2	Solid Surface - Group 2	819

### CASTER OPTIONS

Q3	3" - Dual Wheel Central Locking System	1019
Q4	4" - Central Lock & Steer System	1019
Q5	5" - Central Lock & Steer System	1139
S4	4" - (2) Caster Lock & Steer System	569
4S3R1	4" - (3) Swivel/(1) Rigid Locking Casters	Standard
4S4	4" - (4) Swivel Locking Casters	39

### HEAT/MASSAGE OPTIONS (IEC 60601-1 CERTIFIED)

#### Wand Controls

HW	Heat	1139
HMW	Heat & Massage	1369

#### In-Arm Controls

H	Heat	849
HM	Heat & Massage	1119

### ADDITIONAL FEATURES & OPTIONS

PB	Push Bar	Standard
EG	Protective Edge Guard	Standard
QR	Additional Quick Release Accessory Bracket	69
CAL	CAL TB133	See pg 9
Z	Multi Cover	Use Pricing for Highest Grade

### PATIENT WELLNESS & COMFORT OPTIONS

ABP	Adjustable Back Pad (COM 1.75 yds)	
	Textile Grades COM-B	459
	Textile Grades C-I	569
AHP	Adjustable Head Rest Pillow (COM 1 yd)	339
DP	Dual IV Poles & Brackets <sup>1</sup>	498
FBH	Foley Bag Holder	89
FT	Foot Tray	279
IV	IV Pole & Bracket <sup>1</sup>	249
LC	LiquiCell	229
LCKFR	Orthopedic Locking Footrest	399
MBB	Moisture Barrier (Back)	59
MBS	Moisture Barrier (Seat)	59
MR67	Monitor Arm, on Fold Down Arm <sup>1,2</sup>	899
MTR67	Monitor Arm with Tray, on Fold Down Arm <sup>1,2</sup>	999
PR1	Paper Roll Holder <sup>3</sup>	229
TE	Trendelenburg	339
USB	USB Power Outlet (IEC 60601-1 Certified)	459
WR	Wrist Restraint Mounts (pair)	229

### TRAY TABLE OPTIONS

TSL1	Adjustable (Left) Side Tray, on Stationary Arm <sup>1,5</sup>	399
TSR167	Adjustable (Right) Side Tray, on Fold Down Arm <sup>1,5</sup>	449

### FOLD DOWN TRANSFER ARM SPECIFIC

HC	Hinge Cover	Standard
----	-------------	----------

\*Refer to pg 130 for full option details and images\*

<sup>1</sup>Includes QR bracket connection installed on recliner

<sup>2</sup>Standard on right side (facing). Replace "R" with "L" for left side (facing) option where available.

<sup>3</sup>Takes place of Push Bar. Paper sold separately.

<sup>4</sup>Contact customer service for solid surface pricing

<sup>5</sup>Over the lap tray function recommended in seated position.



# DURABLE® 650 SERIES

# Mobile Healthcare Recliners | Patient Transfer

## Select Aesthetic Style (Denotes back & arm design)

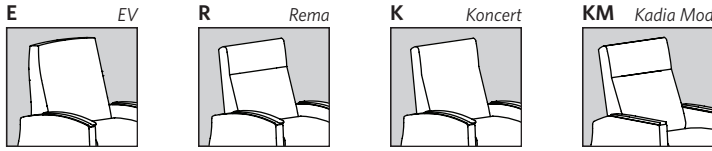

## Select Functional Style (Aesthetic style code precedes selected model number below, e.g., KC117)

### 1062 Mobile Healthcare Recliner - Infinite Position Non-Locking Back - Dual Fold Down Arms

COM	Dillon/Carson	A <sub>5</sub>	B <sub>6</sub>	C <sub>7</sub>	D <sub>8</sub>	E <sub>9</sub>	F <sub>10</sub>	G <sub>11</sub>	H <sub>12</sub>	I <sub>13</sub>
5,719	5,749	5,829	6,029	6,229	6,429	6,669	6,899	7,239	7,569	7,849

### 1162 Mobile Healthcare Recliner - Infinite Position Locking Back - Dual Fold Down Arms

COM	Dillon/Carson	A <sub>5</sub>	B <sub>6</sub>	C <sub>7</sub>	D <sub>8</sub>	E <sub>9</sub>	F <sub>10</sub>	G <sub>11</sub>	H <sub>12</sub>	I <sub>13</sub>
6,429	6,449	6,539	6,709	6,909	7,069	7,309	7,539	7,769	8,069	8,429

### C1062 Mobile Healthcare Chaise Recliner - Infinite Position Non-Locking Back - Dual Fold Down Arms

COM	Dillon/Carson	A <sub>5</sub>	B <sub>6</sub>	C <sub>7</sub>	D <sub>8</sub>	E <sub>9</sub>	F <sub>10</sub>	G <sub>11</sub>	H <sub>12</sub>	I <sub>13</sub>
5,939	5,999	6,119	6,359	6,679	6,939	7,239	7,579	7,949	8,299	8,879

### C1162 Mobile Healthcare Chaise Recliner - Infinite Position Locking Back - Dual Fold Down Arms

COM	Dillon/Carson	A <sub>5</sub>	B <sub>6</sub>	C <sub>7</sub>	D <sub>8</sub>	E <sub>9</sub>	F <sub>10</sub>	G <sub>11</sub>	H <sub>12</sub>	I <sub>13</sub>
6,639	6,679	6,809	7,059	7,319	7,589	7,929	8,219	8,489	8,879	9,239

Dual Fold Down Arms  
(Koncert style pictured)

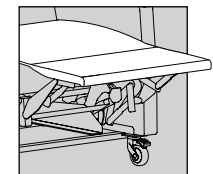

Chaise Models

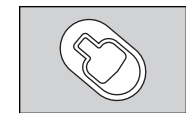

Locking Back Lever  
(located on outside arm on applicable models)

## Dimensions

E1062   E1162   EC1062   EC1162	Overall			Seat			Back H	Arm H	Kick Out Seat D	Recline D	Distance from Wall
	W	D	H	W	D	H					
R1062   R1162   RC1062   RC1162	33.5	34.5	47.5	24	21	21.5	28.5	27	40	75.5	20
K1062   K1162   KC1062   KC1162	33.5	38.5	47	24	21	21.5	28	27	40	76.5	20
KM1062   KM1162   KMC1062   KMC1162	33.5	38.5	47	24	21	21.5	28	26.5	40	76.5	20

### General Info

COM:	5.7 yds
w/ Chaise COM:	6.1 yds
Wt Cap:	650 lb
Unit Weight:	166 lb

## Available Options

ARM CAP OPTIONS	See pg 2 for finishes	PATIENT WELLNESS & COMFORT OPTIONS
U Urethane	Standard	ABP Adjustable Back Pad (COM 1.75 yds) Textile Grades COM-B 459 Textile Grades C-I 569
J1 Solid Surface - Group 1	619	AHP Adjustable Head Rest Pillow (COM 1 yd) 339
J2 Solid Surface - Group 2	819	DP Dual IV Poles & Brackets <sup>1</sup> 498
		FBH Foley Bag Holder 89
		FT Foot Tray 279
		IV IV Pole & Bracket <sup>1</sup> 249
		LC LiquiCell 229
		LCKFR Orthopedic Locking Footrest 399
		MBB Moisture Barrier (Back) 59
		MBS Moisture Barrier (Seat) 59
		MR67 Monitor Arm, on Fold Down Arm <sup>1,2</sup> 899
		MTR67 Monitor Arm with Tray, on Fold Down Arm <sup>1,2</sup> 999
		PR1 Paper Roll Holder <sup>3</sup> 229
		TE Trendelenburg 339
		USB USB Power Outlet (IEC 60601-1 Certified) 459
		WR Wrist Restraint Mounts (pair) 229
		TRAY TABLE OPTIONS
		TD362 Dual Adjustable Side Trays, on Fold Down Arms <sup>1,5</sup> 898
		TSR167 Adjustable (Right) Side Tray, on Fold Down Arm <sup>1,5</sup> 449
		TSL167 Adjustable (Left) Side Tray, on Fold Down Arm <sup>1,5</sup> 449
		FOLD DOWN TRANSFER ARM SPECIFIC
		HC Hinge Cover Standard

\*Refer to pg 130 for full option details and images\*

<sup>1</sup>Includes QR bracket connection installed on recliner

<sup>2</sup>Standard on right side (facing). Replace "R" with "L" for left side (facing) option where available.

<sup>3</sup>Takes place of Push Bar. Paper sold separately.

<sup>4</sup>Contact customer service for solid surface pricing

<sup>5</sup>Over the lap tray function recommended in seated position.



**Select Aesthetic Style** (Denotes back & arm design)

**E** EV-Narrow Arm

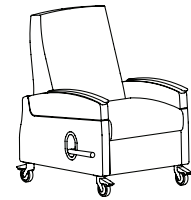
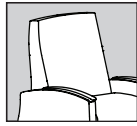

Dual Fold Down Arms

**Select Functional Style** (Aesthetic style code precedes selected model number below, e.g., KC117)

**4062 Mobile Healthcare Recliner - Narrow Arms - Infinite Position Non-Locking Back - Dual Fold Down Arms**

COM	Dillon/Carson	A <sub>5</sub>	B <sub>6</sub>	C <sub>7</sub>	D <sub>8</sub>	E <sub>9</sub>	F <sub>10</sub>	G <sub>11</sub>	H <sub>12</sub>	I <sub>13</sub>
5,659	5,689	5,769	5,979	6,179	6,369	6,599	6,839	7,199	7,619	8,039

**4162 Mobile Healthcare Recliner - Narrow Arms - Infinite Position Locking Back - Dual Fold Down Arms**

COM	Dillon/Carson	A <sub>5</sub>	B <sub>6</sub>	C <sub>7</sub>	D <sub>8</sub>	E <sub>9</sub>	F <sub>10</sub>	G <sub>11</sub>	H <sub>12</sub>	I <sub>13</sub>
6,369	6,419	6,459	6,629	6,839	7,019	7,239	7,479	7,719	7,969	8,429

**C4062 Mobile Healthcare Chaise Recliner - Narrow Arms - Infinite Position Non-Locking Back - Dual Fold Down Arms**

COM	Dillon/Carson	A <sub>5</sub>	B <sub>6</sub>	C <sub>7</sub>	D <sub>8</sub>	E <sub>9</sub>	F <sub>10</sub>	G <sub>11</sub>	H <sub>12</sub>	I <sub>13</sub>
5,859	5,939	6,079	6,319	6,609	6,859	7,189	7,539	7,899	8,069	8,549

**C4162 Mobile Healthcare Chaise Recliner - Narrow Arms - Infinite Position Locking Back - Dual Fold Down Arms**

COM	Dillon/Carson	A <sub>5</sub>	B <sub>6</sub>	C <sub>7</sub>	D <sub>8</sub>	E <sub>9</sub>	F <sub>10</sub>	G <sub>11</sub>	H <sub>12</sub>	I <sub>13</sub>
6,599	6,629	6,769	7,019	7,279	7,529	7,829	8,169	8,569	8,879	9,349

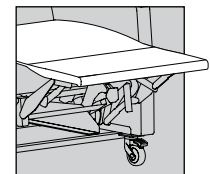

Chaise Models



Locking Back Lever (located on outside arm on applicable models)

**Dimensions**

E4062   E4162   EC4062   EC4162	Overall			Seat			Back H	Arm H	Kick Out Seat D	Recline D	Distance from Wall
	W	D	H	W	D	H					
	32.5	34.5	47.5	24	21	21.5	28.5	27	39	75.5	20

**General Info**

COM:	5.7 yds
w/ Chaise COM:	6.1 yds
Wt Cap:	650 lb
Unit Weight:	155 lb

**Available Options**

**ARM CAP OPTIONS**

See pg 2 for finishes

U	Urethane	Standard
J1	Solid Surface - Group 1	619
J2	Solid Surface - Group 2	819

**CASTER OPTIONS**

Q3	3" - Dual Wheel Central Locking System	1019
Q4	4" - Central Lock & Steer System	1019
Q5	5" - Central Lock & Steer System	1139
S4	4" - (2) Caster Lock & Steer System	569
4S3R1	4" - (3) Swivel/(1) Rigid Locking Casters	Standard
4S4	4" - (4) Swivel Locking Casters	39

**HEAT/MASSAGE OPTIONS (IEC 60601-1 CERTIFIED)**

Wand Controls

HW	Heat	1139
HMW	Heat & Massage	1369

**ADDITIONAL FEATURES & OPTIONS**

PB	Push Bar	Standard
EG	Protective Edge Guard	Standard
QR	Additional Quick Release Accessory Bracket	69
CAL	CAL TB133	See pg 9
Z	Multi Cover	Use Pricing for Highest Grade

**PATIENT WELLNESS & COMFORT OPTIONS**

ABP	Adjustable Back Pad (COM 1.75 yds)	
	Textile Grades COM-B	459
	Textile Grades C-I	569
AHP	Adjustable Head Rest Pillow (COM 1 yd)	339
DP	Dual IV Poles & Brackets <sup>1</sup>	498
FBH	Foley Bag Holder	89
FT	Foot Tray	279
IV	IV Pole & Bracket <sup>1</sup>	249
LC	LiquiCell	229
LCKFR	Orthopedic Locking Footrest	399
MBB	Moisture Barrier (Back)	59
MBS	Moisture Barrier (Seat)	59
MR67	Monitor Arm, on Fold Down Arm <sup>1,2</sup>	899
MTR67	Monitor Arm with Tray, on Fold Down Arm <sup>1,2</sup>	999
PR1	Paper Roll Holder <sup>3</sup>	229
TE	Trendelenburg	339
USB	USB Power Outlet (IEC 60601-1 Certified)	459
WR	Wrist Restraint Mounts (pair)	229

**TRAY TABLE OPTIONS**

TD362	Dual Adjustable Side Trays, on Fold Down Arms <sup>1,5</sup>	898
TSR167	Adjustable (Right) Side Tray, on Fold Down Arm <sup>1,5</sup>	449
TSL167	Adjustable (Left) Side Tray, on Fold Down Arm <sup>1,5</sup>	449

**FOLD DOWN TRANSFER ARM SPECIFIC**

HC	Hinge Cover	Standard
----	-------------	----------

\*Refer to pg 130 for full option details and images\*

<sup>1</sup>Includes QR bracket connection installed on recliner

<sup>2</sup>Standard on right side (facing). Replace "R" with "L" for left side (facing) option where available.

<sup>3</sup>Takes place of Push Bar. Paper sold separately.

<sup>4</sup>Contact customer service for solid surface pricing

<sup>5</sup>Over the lap tray function recommended in seated position.



# DURABLE® 650 SERIES

# Mobile Healthcare Recliners | Patient Transfer, Wingback

Select Aesthetic Style (Denotes back & arm design)

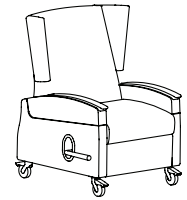
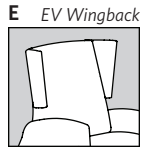

Dual Fold Down Arms

Select Functional Style (Aesthetic style code precedes selected model number below, e.g., KC117)

**2062 Mobile Healthcare Wingback Recliner - Infinite Position Non-Locking Back - Dual Fold Down Arms**

COM	Dillon/Carson	A <sub>5</sub>	B <sub>6</sub>	C <sub>7</sub>	D <sub>8</sub>	E <sub>9</sub>	F <sub>10</sub>	G <sub>11</sub>	H <sub>12</sub>	I <sub>13</sub>
6,659	6,709	6,749	6,939	7,119	7,279	7,519	7,739	7,949	8,189	8,659

**2162 Mobile Healthcare Wingback Recliner - Infinite Position Locking Back - Dual Fold Down Arms**

COM	Dillon/Carson	A <sub>5</sub>	B <sub>6</sub>	C <sub>7</sub>	D <sub>8</sub>	E <sub>9</sub>	F <sub>10</sub>	G <sub>11</sub>	H <sub>12</sub>	I <sub>13</sub>
7,369	7,389	7,419	7,619	7,779	7,949	8,179	8,369	8,619	8,769	9,119

**C2062 Mobile Healthcare Chaise Wingback Recliner - Infinite Position Non-Locking Back - Dual Fold Down Arms**

COM	Dillon/Carson	A <sub>5</sub>	B <sub>6</sub>	C <sub>7</sub>	D <sub>8</sub>	E <sub>9</sub>	F <sub>10</sub>	G <sub>11</sub>	H <sub>12</sub>	I <sub>13</sub>
6,879	6,899	7,039	7,289	7,539	7,789	8,119	8,429	8,779	8,999	9,469

**C2162 Mobile Healthcare Chaise Wingback Recliner - Infinite Position Locking Back - Dual Fold Down Arms**

COM	Dillon/Carson	A <sub>5</sub>	B <sub>6</sub>	C <sub>7</sub>	D <sub>8</sub>	E <sub>9</sub>	F <sub>10</sub>	G <sub>11</sub>	H <sub>12</sub>	I <sub>13</sub>
7,589	7,599	7,709	7,989	8,219	8,459	8,779	9,059	9,319	9,649	10,159

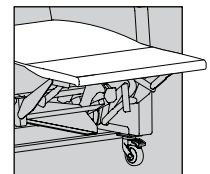

Chaise Models

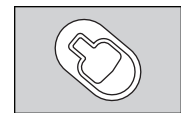

Locking Back Lever (located on outside arm on applicable models)

## Dimensions

E2062   E2162   EC2062   EC2162	Overall			Seat			Back H	Arm H	Kick Out Seat D	Recline D	Distance from Wall
	W	D	H	W	D	H					
	33.5	34.5	47.5	24	21	21.5	28.5	27	40	75.5	20

### General Info

COM:	6.2 yds
w/ Chaise COM:	6.5 yds
Wt Cap:	650 lb
Unit Weight:	176 lb

## Available Options

### ARM CAP OPTIONS

See pg 2 for finishes

U	Urethane	Standard
J1	Solid Surface - Group 1	619
J2	Solid Surface - Group 2	819

### CASTER OPTIONS

Q3	3" - Dual Wheel Central Locking System	1019
Q4	4" - Central Lock & Steer System	1019
Q5	5" - Central Lock & Steer System	1139
S4	4" - (2) Caster Lock & Steer System	569
4S3R1	4" - (3) Swivel/(1) Rigid Locking Casters	Standard
4S4	4" - (4) Swivel Locking Casters	39

### HEAT/MESSAGE OPTIONS (IEC 60601-1 CERTIFIED)

#### Wand Controls

HW	Heat	1139
HMW	Heat & Massage	1369

### ADDITIONAL FEATURES & OPTIONS

PB	Push Bar	Standard
EG	Protective Edge Guard	Standard
QR	Additional Quick Release Accessory Bracket	69
CAL	CAL TB133	See pg 9
Z	Multi Cover	Use Pricing for Highest Grade

### PATIENT WELLNESS & COMFORT OPTIONS

ABP	Adjustable Back Pad (COM 1.75 yds)	
	Textile Grades COM-B	459
	Textile Grades C-I	569
AHP	Adjustable Head Rest Pillow (COM 1 yd)	339
DP	Dual IV Poles & Brackets <sup>1</sup>	498
FBH	Foley Bag Holder	89
FT	Foot Tray	279
IV	IV Pole & Bracket <sup>1</sup>	249
LC	LiquiCell	229
LCKFR	Orthopedic Locking Footrest	399
MBB	Moisture Barrier (Back)	59
MBS	Moisture Barrier (Seat)	59
MR67	Monitor Arm, on Fold Down Arm <sup>1,2</sup>	899
MTR67	Monitor Arm with Tray, on Fold Down Arm <sup>1,2</sup>	999
PR1	Paper Roll Holder <sup>3</sup>	229
TE	Trendelenburg	339
USB	USB Power Outlet (IEC 60601-1 Certified)	459
WR	Wrist Restraint Mounts (pair)	229

### TRAY TABLE OPTIONS

TD362	Dual Adjustable Side Trays, on Fold Down Arms <sup>1,5</sup>	898
TSR167	Adjustable (Right) Side Tray, on Fold Down Arm <sup>1,5</sup>	449
TSL167	Adjustable (Left) Side Tray, on Fold Down Arm <sup>1,5</sup>	449

### FOLD DOWN TRANSFER ARM SPECIFIC

HC	Hinge Cover	Standard
----	-------------	----------

\*Refer to pg 130 for full option details and images\*

<sup>1</sup>Includes QR bracket connection installed on recliner

<sup>2</sup>Standard on right side (facing). Replace "R" with "L" for left side (facing) option where available.

<sup>3</sup>Takes place of Push Bar. Paper sold separately.

<sup>4</sup>Contact customer service for solid surface pricing

<sup>5</sup>Over the lap tray function recommended in seated position.



# DURABLE® 650 SERIES

# Mobile Healthcare Recliners | Patient Transfer

## Select Aesthetic Style *(Denotes back & arm design)*

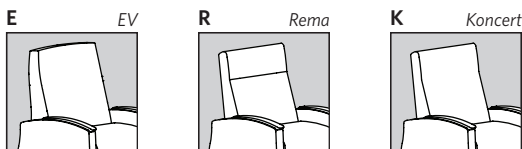

Single Removable Arm  
(Koncert style pictured)

## Select Functional Style *(Aesthetic style code precedes selected model number below, e.g., KC117)*

### 1047 Mobile Healthcare Recliner - Infinite Position Non-Locking Back - Single Removable Arm

COM	Dillon/Carson	A <sub>5</sub>	B <sub>6</sub>	C <sub>7</sub>	D <sub>8</sub>	E <sub>9</sub>	F <sub>10</sub>	G <sub>11</sub>	H <sub>12</sub>	I <sub>13</sub>
5,019	5,029	5,149	5,329	5,559	5,749	5,999	6,259	6,629	6,929	7,269

### 1147 Mobile Healthcare Recliner - Infinite Position Locking Back - Single Removable Arm

COM	Dillon/Carson	A <sub>5</sub>	B <sub>6</sub>	C <sub>7</sub>	D <sub>8</sub>	E <sub>9</sub>	F <sub>10</sub>	G <sub>11</sub>	H <sub>12</sub>	I <sub>13</sub>
5,299	5,339	5,449	5,639	5,859	6,079	6,329	6,589	6,919	7,269	7,609

### C1047 Mobile Healthcare Chaise Recliner - Infinite Position Non-Locking Back - Single Removable Arm

COM	Dillon/Carson	A <sub>5</sub>	B <sub>6</sub>	C <sub>7</sub>	D <sub>8</sub>	E <sub>9</sub>	F <sub>10</sub>	G <sub>11</sub>	H <sub>12</sub>	I <sub>13</sub>
5,199	5,289	5,469	5,699	5,999	6,259	6,599	6,949	7,479	7,849	8,299

### C1147 Mobile Healthcare Chaise Recliner - Infinite Position Locking Back - Single Removable Arm

COM	Dillon/Carson	A <sub>5</sub>	B <sub>6</sub>	C <sub>7</sub>	D <sub>8</sub>	E <sub>9</sub>	F <sub>10</sub>	G <sub>11</sub>	H <sub>12</sub>	I <sub>13</sub>
5,519	5,589	5,729	6,019	6,279	6,579	6,929	7,269	7,749	8,069	8,549

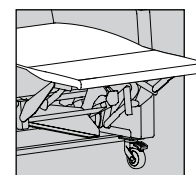

Chaise Models

**NOTE:** Transfer arm standard on right side (facing). If specified on left side, handle will be placed on right side and vice versa.

## Dimensions

E1047   E1147   EC1047   EC1147	Overall			Seat			Back H	Arm H	Kick Out Seat D	Recline D	Distance from Wall
	W	D	H	W	D	H					
R1047   R1147   RC1047   RC1147	33.5	34.5	47.5	24	21	21.5	28.5	28	40	75.5	20
K1047   K1147   KC1047   KC1147	33.5	38.5	47	24	21	21.5	28	28	40	76.5	20

### General Info

COM: 5.3 yds  
w/ Chaise COM: 5.7 yds  
Wt Cap: 650 lb  
Unit Weight: 166 lb

## Available Options

### ARM CAP OPTIONS

See pg 2 for finishes

U	Urethane	Standard
J1	Solid Surface - Group 1	619
J2	Solid Surface - Group 2	819

### CASTER OPTIONS

Q3	3" - Dual Wheel Central Locking System	1019
Q4	4" - Central Lock & Steer System	1019
Q5	5" - Central Lock & Steer System	1139
S4	4" - (2) Caster Lock & Steer System	569
4S3R1	4" - (3) Swivel/(1) Rigid Locking Casters	Standard
4S4	4" - (4) Swivel Locking Casters	39

### HEAT/MASSAGE OPTIONS (IEC 60601-1 CERTIFIED)

#### Wand Controls

HW	Heat	1139
HMW	Heat & Massage	1369

#### In-Arm Controls

H	Heat	849
HM	Heat & Massage	1119

### ADDITIONAL FEATURES & OPTIONS

PB	Push Bar	Standard
EG	Protective Edge Guard	Standard
QR	Additional Quick Release Accessory Bracket	69
CAL	CAL TB133	See pg 9
Z	Multi Cover	Use Pricing for Highest Grade

### PATIENT WELLNESS & COMFORT OPTIONS

ABP	Adjustable Back Pad (COM 1.75 yds)	
	Textile Grades COM-B	459
	Textile Grades C-I	569
AHP	Adjustable Head Rest Pillow (COM 1 yd)	339
DP	Dual IV Poles & Brackets <sup>1</sup>	498
FBH	Foley Bag Holder	89
FT	Foot Tray	279
IV	IV Pole & Bracket <sup>1</sup>	249
LC	LiquiCell	229
LCKFR	Orthopedic Locking Footrest	399
MBB	Moisture Barrier (Back)	59
MBS	Moisture Barrier (Seat)	59
MR	Monitor Arm (right side facing) <sup>1,2</sup>	849
MTR	Monitor Arm with Tray (right side facing) <sup>1,2</sup>	949
PR1	Paper Roll Holder <sup>3</sup>	229
TE	Trendelenburg	339
USB	USB Power Outlet (IEC 60601-1 Certified)	459
WR	Wrist Restraint Mounts (pair)	229

### TRAY TABLE OPTIONS

TSR1	Adjustable (Right) Side Tray <sup>1,2,5</sup>	399
TD3	Dual Adjustable Side Trays (TSR1 & TSL1) <sup>1,5</sup>	798

\*Refer to pg 130 for full option details and images\*

<sup>1</sup>Includes QR bracket connection installed on recliner

<sup>2</sup>Standard on right side (facing). Replace "R" with "L" for left side (facing) option where available.

<sup>3</sup>Takes place of Push Bar. Paper sold separately.

<sup>4</sup>Contact customer service for solid surface pricing

<sup>5</sup>Over the lap tray function recommended in seated position.



# DURABLE® 650 SERIES

# Mobile Healthcare Recliners | Patient Transfer

Select Aesthetic Style (Denotes back & arm design)

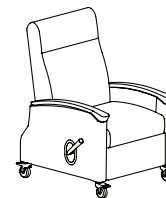

Single Removable Arm

Select Functional Style (Aesthetic style code precedes selected model number below, e.g., KC117)

**5047 Mobile Healthcare Recliner - Infinite Position Non-Locking Back - Single Removable Arm**

COM	Dillon/Carson	A <sub>5</sub>	B <sub>6</sub>	C <sub>7</sub>	D <sub>8</sub>	E <sub>9</sub>	F <sub>10</sub>	G <sub>11</sub>	H <sub>12</sub>	I <sub>13</sub>
4,939	4,999	5,179	5,439	5,649	5,939	6,259	6,579	6,979	7,379	7,849

**5147 Mobile Healthcare Recliner - Infinite Position Locking Back - Single Removable Arm**

COM	Dillon/Carson	A <sub>5</sub>	B <sub>6</sub>	C <sub>7</sub>	D <sub>8</sub>	E <sub>9</sub>	F <sub>10</sub>	G <sub>11</sub>	H <sub>12</sub>	I <sub>13</sub>
5,289	5,309	5,489	5,669	5,919	6,139	6,419	6,659	7,069	7,499	7,969

**C5047 Mobile Healthcare Chaise Recliner - Infinite Position Non-Locking Back - Single Removable Arm**

COM	Dillon/Carson	A <sub>5</sub>	B <sub>6</sub>	C <sub>7</sub>	D <sub>8</sub>	E <sub>9</sub>	F <sub>10</sub>	G <sub>11</sub>	H <sub>12</sub>	I <sub>13</sub>
5,189	5,279	5,509	5,839	6,149	6,519	6,939	7,339	7,749	8,229	8,699

**C5147 Mobile Healthcare Chaise Recliner - Infinite Position Locking Back - Single Removable Arm**

COM	Dillon/Carson	A <sub>5</sub>	B <sub>6</sub>	C <sub>7</sub>	D <sub>8</sub>	E <sub>9</sub>	F <sub>10</sub>	G <sub>11</sub>	H <sub>12</sub>	I <sub>13</sub>
5,539	5,609	5,799	6,079	6,419	6,719	7,069	7,439	7,839	8,239	8,679

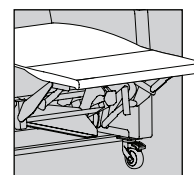

Chaise Models

**NOTE:** Transfer arm standard on right side (facing). If specified on left side, handle will be placed on right side and vice versa.

## Dimensions

H5047   H5147   HC5047   HC5147	Overall			Seat			Back H	Arm H	Kick Out Seat D	Recline D	Distance from Wall
	W	D	H	W	D	H					
	34	38	47	24	21	21.5	26	28	40	76	20

### General Info

COM: 5.4 yds  
w/ Chaise COM: 5.7 yds  
Wt Cap: 650 lb  
Unit Weight: 175 lb

## Available Options

### ARM CAP OPTIONS

See pg 2 for finishes

U	Urethane (black only in Harmony style)	Standard
---	--	----------

### CASTER OPTIONS

S4	4" - (2) Caster Lock & Steer System	569
4S3R1	4" - (3) Swivel/(1) Rigid Locking Casters	Standard
4S4	4" - (4) Swivel Locking Casters	39

### HEAT/MASSAGE OPTIONS (IEC 60601-1 CERTIFIED)

#### Wand Controls

HW	Heat	1139
HMW	Heat & Massage	1369

#### In-Arm Controls

H	Heat	849
HM	Heat & Massage	1119

### ADDITIONAL FEATURES & OPTIONS

PB	Push Bar	Standard
EG	Protective Edge Guard	Standard
QR	Additional Quick Release Accessory Bracket	69
CAL	CAL TB133	See pg 9
Z	Multi Cover	Use Pricing for Highest Grade

### PATIENT WELLNESS & COMFORT OPTIONS

ABP	Adjustable Back Pad (COM 1.75 yds)	
	Textile Grades COM-B	459
	Textile Grades C-I	569
AHP	Adjustable Head Rest Pillow (COM 1 yd)	339
DP	Dual IV Poles & Brackets <sup>1</sup>	498
FBH	Foley Bag Holder	89
FT	Foot Tray	279
IV	IV Pole & Bracket <sup>1</sup>	249
LC	LiquiCell	229
LCKFR	Orthopedic Locking Footrest	399
MBB	Moisture Barrier (Back)	59
MBS	Moisture Barrier (Seat)	59
MR	Monitor Arm (right side facing) <sup>1,2</sup>	849
MTR	Monitor Arm with Tray (right side facing) <sup>1,2</sup>	949
PR1	Paper Roll Holder <sup>3</sup>	229
TE	Trendelenburg	339
USB	USB Power Outlet (IEC 60601-1 Certified)	459
WR	Wrist Restraint Mounts (pair)	229

### TRAY TABLE OPTIONS

TSR1	Adjustable (Right) Side Tray <sup>1,2,5</sup>	399
TD3	Dual Adjustable Side Trays (TSR1 & TSL1) <sup>1,5</sup>	798

\*Refer to pg 130 for full option details and images\*

<sup>1</sup>Includes QR bracket connection installed on recliner

<sup>2</sup>Standard on right side (facing). Replace "R" with "L" for left side (facing) option where available.

<sup>3</sup>Takes place of Push Bar. Paper sold separately.

<sup>4</sup>Contact customer service for solid surface pricing

<sup>5</sup>Over the lap tray function recommended in seated position.



# DURABLE® 650 SERIES

# Mobile Healthcare Recliners | Patient Transfer

## Select Aesthetic Style (Denotes back & arm design)

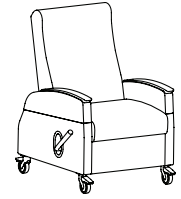
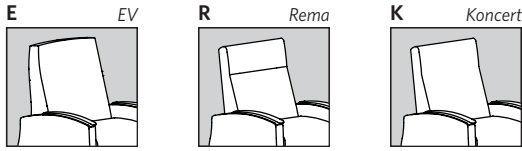

Dual Removable Arms  
(Koncert style pictured)

## Select Functional Style (Aesthetic style code precedes selected model number below, e.g., KC117)

### 1042 Mobile Healthcare Recliner - Infinite Position Non-Locking Back - Dual Removable Arms

COM	Dillon/Carson	A <sub>5</sub>	B <sub>6</sub>	C <sub>7</sub>	D <sub>8</sub>	E <sub>9</sub>	F <sub>10</sub>	G <sub>11</sub>	H <sub>12</sub>	I <sub>13</sub>
5,719	5,749	5,829	6,029	6,229	6,429	6,669	6,899	7,239	7,499	7,969

### 1142 Mobile Healthcare Recliner - Infinite Position Locking Back - Dual Removable Arms

COM	Dillon/Carson	A <sub>5</sub>	B <sub>6</sub>	C <sub>7</sub>	D <sub>8</sub>	E <sub>9</sub>	F <sub>10</sub>	G <sub>11</sub>	H <sub>12</sub>	I <sub>13</sub>
6,429	6,449	6,539	6,709	6,909	7,069	7,309	7,539	7,769	7,849	8,189

### C1042 Mobile Healthcare Chaise Recliner - Infinite Position Non-Locking Back - Dual Removable Arms

COM	Dillon/Carson	A <sub>5</sub>	B <sub>6</sub>	C <sub>7</sub>	D <sub>8</sub>	E <sub>9</sub>	F <sub>10</sub>	G <sub>11</sub>	H <sub>12</sub>	I <sub>13</sub>
5,939	5,999	6,119	6,359	6,679	6,939	7,239	7,579	7,949	8,299	8,879

### C1142 Mobile Healthcare Chaise Recliner - Infinite Position Locking Back - Dual Removable Arms

COM	Dillon/Carson	A <sub>5</sub>	B <sub>6</sub>	C <sub>7</sub>	D <sub>8</sub>	E <sub>9</sub>	F <sub>10</sub>	G <sub>11</sub>	H <sub>12</sub>	I <sub>13</sub>
6,639	6,679	6,809	7,059	7,319	7,589	7,929	8,219	8,489	8,879	9,239

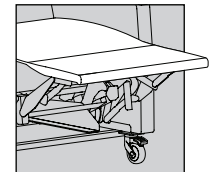

Chaise Models

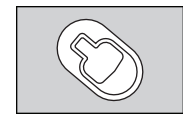

Locking Back Lever  
(located on outside arm on applicable models)

## Dimensions

E1042   E1142   EC1042   EC1142	Overall			Seat			Back H	Arm H	Kick Out Seat D	Recline D	Distance from Wall
	W	D	H	W	D	H					
R1042   R1142   RC1042   RC1142	33.5	34.5	47.5	24	21	21.5	28.5	28	40	75.5	20
K1042   K1142   KC1042   KC1142	33.5	38.5	47	24	21	21.5	28	28	40	76.5	20

### General Info

COM: 5.6 yds  
w/ Chaise COM: 6 yds  
Wt Cap: 650 lb  
Unit Weight: 166 lb

## Available Options

### ARM CAP OPTIONS

See pg 2 for finishes

U	Urethane	Standard
J1	Solid Surface - Group 1	619
J2	Solid Surface - Group 2	819

### CASTER OPTIONS

Q3	3" - Dual Wheel Central Locking System	1019
Q4	4" - Central Lock & Steer System	1019
Q5	5" - Central Lock & Steer System	1139
S4	4" - (2) Caster Lock & Steer System	569
4S3R1	4" - (3) Swivel/(1) Rigid Locking Casters	Standard
4S4	4" - (4) Swivel Locking Casters	39

### HEAT/MESSAGE OPTIONS (IEC 60601-1 CERTIFIED)

#### Wand Controls

HW	Heat	1139
HMW	Heat & Massage	1369

### ADDITIONAL FEATURES & OPTIONS

PB	Push Bar	Standard
EG	Protective Edge Guard	Standard
QR	Additional Quick Release Accessory Bracket	69
CAL	CAL TB133	See pg 9
Z	Multi Cover	Use Pricing for Highest Grade

### PATIENT WELLNESS & COMFORT OPTIONS

ABP	Adjustable Back Pad (COM 1.75 yds)	
	Textile Grades COM-B	459
	Textile Grades C-I	569
AHP	Adjustable Head Rest Pillow (COM 1 yd)	339
DP	Dual IV Poles & Brackets <sup>1</sup>	498
FBH	Foley Bag Holder	89
FT	Foot Tray	279
IV	IV Pole & Bracket <sup>1</sup>	249
LC	LiquiCell	229
LCKFR	Orthopedic Locking Footrest	399
MBB	Moisture Barrier (Back)	59
MBS	Moisture Barrier (Seat)	59
MR	Monitor Arm (right side facing) <sup>1,2</sup>	849
MTR	Monitor Arm with Tray (right side facing) <sup>1,2</sup>	949
PR1	Paper Roll Holder <sup>3</sup>	229
TE	Trendelenburg	339
USB	USB Power Outlet (IEC 60601-1 Certified)	459
WR	Wrist Restraint Mounts (pair)	229

### TRAY TABLE OPTIONS

TSR1	Adjustable (Right) Side Tray <sup>1,2,5</sup>	399
TD3	Dual Adjustable Side Trays (TSR1 & TSL1) <sup>1,5</sup>	798

\*Refer to pg 130 for full option details and images\*

<sup>1</sup>Includes QR bracket connection installed on recliner

<sup>2</sup>Standard on right side (facing). Replace "R" with "L" for left side (facing) option where available.

<sup>3</sup>Takes place of Push Bar. Paper sold separately.

<sup>4</sup>Contact customer service for solid surface pricing

<sup>5</sup>Over the lap tray function recommended in seated position.



# DURABLE® 650 SERIES

# Mobile Healthcare Recliners | Compact

Select Aesthetic Style (Denotes back & arm design)

**KM** Kadia Mod

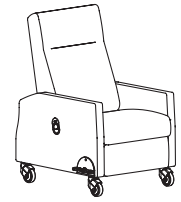
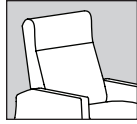

Select Functional Style (Aesthetic style code precedes selected model number below, e.g., KC1117)

**KM3217 Controlled Environment Mobile Healthcare Recliner - Infinite Position Non-Locking Back**

COM	Dillon/Carson	A <sub>5</sub>	B <sub>6</sub>	C <sub>7</sub>	D <sub>8</sub>	E <sub>9</sub>	F <sub>10</sub>	G <sub>11</sub>	H <sub>12</sub>	I <sub>13</sub>
5,499	5,549	5,689	5,899	6,139	6,389	6,679	7,449	8,539	9,049	9,589



**Controlled Patient Environment Specializations**

Recliner models denoted as "Controlled Patient Environment" have specialized modifications (listed at right) that differ from standard features of similar products in their respective series.



**Cable Release Recline Operation**

Footrest is opened by pulling the cable release lever located on inside of arm. Lean forward and press down with legs to return footrest to closed position.

**Tamper-Resistant Hardware**

Recliner parts fastened together using tamper resistant hardware.

**Additional Options Available by Request**

Please contact your local sales representative to discuss specific needs.

**Dimensions**

KM3217	Overall			Seat			Back H	Arm H	Kick Out Seat D	Recline D	Distance from Wall
	W	D	H	W	D	H					
	31.5	38.5	47	22	21	21.5	28	26.5	39	76.5	20

**General Info**

COM: 5.3 yds

Wt Cap: 650 lb  
Unit Weight: 158 yds

**Available Options**

**ARM CAP OPTIONS**

F	Fully Upholstered Arms	Standard
---	------------------------	----------

**CASTER OPTIONS**

Q3	3" - Dual Wheel Central Locking System	No Charge
Q4	4" - Central Lock & Steer System	Standard
Q5	5" - Central Lock & Steer System	119

**PATIENT WELLNESS & COMFORT OPTIONS**

LC	LiquiCell	229
MBB	Moisture Barrier (Back)	59
MBS	Moisture Barrier (Seat)	59

**ADDITIONAL FEATURES & OPTIONS**

EG	Protective Edge Guard	Standard
CAL	CAL TB133	See pg 9
Z	Multi Cover	Use Pricing for Highest Grade

Note: Controlled Patient Environment recliners are standard without Push Bar

\*Refer to pg 130 for full option details and images\*



# DURABLE® 650 SERIES

# Mobile Healthcare Recliners

Select Aesthetic Style (Denotes back & arm design)

**KM** Kadia Mod

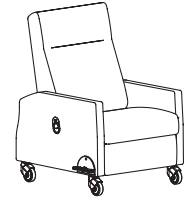
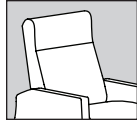

Select Functional Style (Aesthetic style code precedes selected model number below, e.g., KC1117)

**KM1217 Controlled Environment Mobile Healthcare Recliner - Infinite Position Non-Locking Back**

COM	Dillon/Carson	A <sub>5</sub>	B <sub>6</sub>	C <sub>7</sub>	D <sub>8</sub>	E <sub>9</sub>	F <sub>10</sub>	G <sub>11</sub>	H <sub>12</sub>	I <sub>13</sub>
5,539	5,629	5,759	5,959	6,199	6,429	6,729	7,499	8,749	9,049	9,589



**Controlled Patient Environment Specializations**

Recliner models denoted as "Controlled Patient Environment" have specialized modifications (listed at right) that differ from standard features of similar products in their respective series.

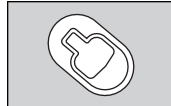

**Cable Release Recline Operation**

Footrest is opened by pulling the cable release lever located on inside of arm. Lean forward and press down with legs to return footrest to closed position.

**Tamper-Resistant Hardware**

Recliner parts fastened together using tamper resistant hardware.

**Additional Options Available by Request**

Please contact your local sales representative to discuss specific needs.

**Dimensions**

KM1217	Overall			Seat			Back H	Arm H	Kick Out Seat D	Recline D	Distance from Wall
	W	D	H	W	D	H					
	33.5	38.5	47	24	21	21.5	28	26.5	40	76.5	20

**General Info**

COM: 5.5 yds

Wt Cap: 650 lb

Unit Weight: 158 yds

**Available Options**

**ARM CAP OPTIONS**

F	Fully Upholstered Arms	Standard
---	------------------------	----------

**CASTER OPTIONS**

Q3	3" - Dual Wheel Central Locking System	No Charge
Q4	4" - Central Lock & Steer System	Standard
Q5	5" - Central Lock & Steer System	119

**PATIENT WELLNESS & COMFORT OPTIONS**

LC	LiquiCell	229
MBB	Moisture Barrier (Back)	59
MBS	Moisture Barrier (Seat)	59

**ADDITIONAL FEATURES & OPTIONS**

EG	Protective Edge Guard	Standard
CAL	CAL TB133	See pg 9
Z	Multi Cover	Use Pricing for Highest Grade

Note: Controlled Patient Environment recliners are standard without Push Bar

\*Refer to pg 130 for full option details and images\*



# DURABLE® 750 SERIES



## Series Overview

The bariatric sibling of the Durable® 650 Series, the Durable® 750 Series delivers the same comfort, performance, and durability, along with a wider 29" seat width and 750 lb weight rating. Featuring the patented Durable® unitized mechanism for smooth, full-body motion and near limitless option configurations, the Durable® 750 Series ensures that all patients have access to a comfortable and safe seating space.

## General Product Information

- 750 lb Weight Rating
- Designed for 24/7 use healthcare environments
- Seat width 29"
- Manually operated recline functionality
- Footrest and back move in harmony when engaged
- Quick removable back & lift up seat for ease of cleaning
- True flatbed sleep position
- Sinuous spring seat and back
- Seat clean-out
- All steel base structure for maximum durability
- Mid-Ottoman Calf Support
- Infinite Position Back reclines to infinite angle positions
- All interior plywood California Carb Compliant/Phase II
- Field replaceable components

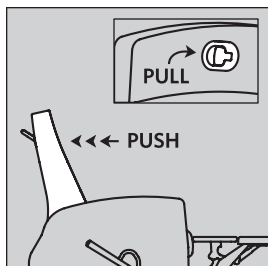

### Infinite Position Locking Back

Allows patient/caregiver to lock back into any position. Lock lever located inside left (facing) arm on applicable models, unless otherwise noted/pictured.

## To Order, Specify

- Model Number
- Textile
- Finish
- Options

## Options vary by model, see specific model page for list of available options

Refer to pg 130 for full option details and images

# DURABLE® 750 SERIES

# Bariatric Mobile Healthcare Recliners

Select Aesthetic Style (Denotes back & arm design)

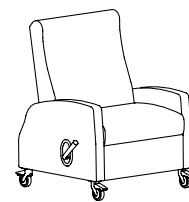
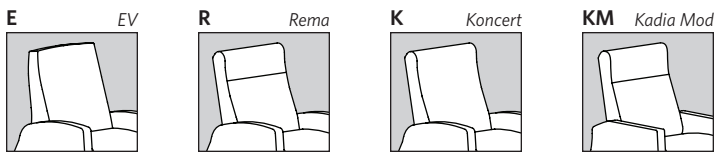

(Koncert style pictured)

Select Functional Style (Aesthetic style code precedes selected model number below, e.g., KBC1117)

**B1037 Bariatric Mobile Healthcare Recliner - Infinite Position Non-Locking Back**

COM	Dillon/Carson	A <sub>5</sub>	B <sub>6</sub>	C <sub>7</sub>	D <sub>8</sub>	E <sub>9</sub>	F <sub>10</sub>	G <sub>11</sub>	H <sub>12</sub>	I <sub>13</sub>
4,829	4,899	5,099	5,309	5,599	5,809	6,069	6,509	6,859	7,349	7,939

**B1137 Bariatric Mobile Healthcare Recliner - Infinite Position Locking Back**

COM	Dillon/Carson	A <sub>5</sub>	B <sub>6</sub>	C <sub>7</sub>	D <sub>8</sub>	E <sub>9</sub>	F <sub>10</sub>	G <sub>11</sub>	H <sub>12</sub>	I <sub>13</sub>
5,249	5,349	5,539	5,739	6,029	6,229	6,469	6,879	7,179	7,739	8,219

**BC1037 Bariatric Mobile Healthcare Chaise Recliner - Infinite Position Non-Locking Back**

COM	Dillon/Carson	A <sub>5</sub>	B <sub>6</sub>	C <sub>7</sub>	D <sub>8</sub>	E <sub>9</sub>	F <sub>10</sub>	G <sub>11</sub>	H <sub>12</sub>	I <sub>13</sub>
5,049	5,169	5,389	5,689	6,059	6,339	6,669	7,219	7,699	8,049	8,589

**BC1137 Bariatric Mobile Healthcare Chaise Recliner - Infinite Position Locking Back**

COM	Dillon/Carson	A <sub>5</sub>	B <sub>6</sub>	C <sub>7</sub>	D <sub>8</sub>	E <sub>9</sub>	F <sub>10</sub>	G <sub>11</sub>	H <sub>12</sub>	I <sub>13</sub>
5,479	5,619	5,819	6,119	6,489	6,749	7,069	7,599	8,019	8,489	9,029

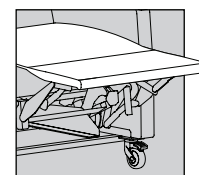

Chaise Models

## Dimensions

	Overall			Seat			Back H	Arm H	Kick Out Seat D	Recline D	Distance from Wall
	W	D	H	W	D	H					
EB1037   EB1137   EBC1037   EBC1137	38	34.5	47.5	29	21	21.5	28.5	28	40	75.5	20
RB1037   RB1137   RBC1037   RBC1137	38	38.5	47	29	21	21.5	28	28	40	76.5	20
KB1037   KB1137   KBC1037   KBC1137	38	38.5	47	29	21	21.5	28	26.5	40	76.5	20
KMB1037   KMB1137   KMBC1037   KMBC1137	38	38.5	47	29	21	21.5	28	26.5	40	76.5	20

### General Info

COM: 7 yds  
w/ Chaise COM: 8 yds  
Wt Cap: 750 lb  
Unit Weight: 162 lb

## Available Options

### ARM CAP OPTIONS

See pg 2 for finishes

U	Urethane	209
J1	Solid Surface - Group 1	619
J2	Solid Surface - Group 2	819
F	Fully Upholstered Arms	Standard

### CASTER OPTIONS

Q3	3" - Dual Wheel Central Locking System	1019
Q4	4" - Central Lock & Steer System	1019
Q5	5" - Central Lock & Steer System	1139
S4	4" - (2) Caster Lock & Steer System	569
4S3R1	4" - (3) Swivel/(1) Rigid Locking Casters	Standard
4S4	4" - (4) Swivel Locking Casters	39

### HEAT/MASSAGE OPTIONS (IEC 60601-1 CERTIFIED)

<i>Wand Controls</i>		
HW	Heat	1139
HMW	Heat & Massage	1369
<i>In-Arm Controls</i>		
H	Heat	849
HM	Heat & Massage	1119

### ADDITIONAL FEATURES & OPTIONS

PB	Push Bar	Standard
EG	Protective Edge Guard	Standard
QR	Additional Quick Release Accessory Bracket	69
CAL	CAL TB133	See pg 9
Z	Multi Cover	Use Pricing for Highest Grade

### PATIENT WELLNESS & COMFORT OPTIONS

AHP	Adjustable Head Rest Pillow (COM 1 yd)	339
DP	Dual IV Poles & Brackets <sup>1</sup>	498
FBH	Foley Bag Holder	89
FT	Foot Tray	279
IV	IV Pole & Bracket <sup>1</sup>	249
LC	LiquiCell	229
LCKFR	Orthopedic Locking Footrest	399
MB2B	Moisture Barrier (Back)	89
MB2S	Moisture Barrier (Seat)	89
MR	Monitor Arm (right side facing) <sup>1,2</sup>	849
MTR	Monitor Arm with Tray (right side facing) <sup>1,2</sup>	949
PR1	Paper Roll Holder <sup>3</sup>	229
TE750	Trendelenburg (Bariatric)	459
USB	USB Power Outlet (IEC 60601-1 Certified)	459
WR	Wrist Restraint Mounts (pair)	229

### TRAY TABLE OPTIONS

TSR1	Adjustable (Right) Side Tray <sup>1,2,5</sup>	399	Solid Surface Trays*	
TD3	Dual Adjustable Side Trays (TSR1 & TSL1) <sup>1,5</sup>	798	Grp 1	Grp 2
LFSTR	Large Folding (Right) Side Tray <sup>4</sup>	269	739	959
LFSTRCH	Large Folding Cup Holder (Right) Side Tray	339	849	1099
PLFSTR	Padded Large Folding (Right) Side Tray	379	n/a	n/a
SFSTR	Small Folding (Right) Side Tray <sup>4</sup>	269	689	889

\*Refer to pg 130 for full option details and images\*

\*Finishes on pg 2

<sup>1</sup>Includes QR bracket connection installed on recliner

<sup>2</sup>Standard on right side (facing). Replace "R" with "L" for left side (facing) option where available.

<sup>3</sup>Takes place of Push Bar. Paper sold separately.

<sup>4</sup>Contact customer service for solid surface pricing

<sup>5</sup>Over the lap tray function recommended in seated position.



# DURABLE® 750 SERIES

# Bariatric Mobile Healthcare Recliners

Select Aesthetic Style (Denotes back & arm design)

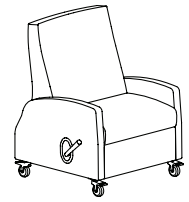
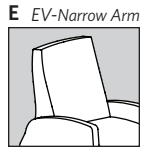

Select Functional Style (Aesthetic style code precedes selected model number below, e.g., KBC1117)

**B4037 Bariatric Mobile Healthcare Recliner - Narrow Arms - Infinite Position Non-Locking Back**

COM	Dillon/Carson	A <sub>5</sub>	B <sub>6</sub>	C <sub>7</sub>	D <sub>8</sub>	E <sub>9</sub>	F <sub>10</sub>	G <sub>11</sub>	H <sub>12</sub>	I <sub>13</sub>
4,729	4,839	5,019	5,259	5,529	5,759	6,009	6,439	6,809	7,349	7,829

**B4137 Bariatric Mobile Healthcare Recliner - Narrow Arms - Infinite Position Locking Back**

COM	Dillon/Carson	A <sub>5</sub>	B <sub>6</sub>	C <sub>7</sub>	D <sub>8</sub>	E <sub>9</sub>	F <sub>10</sub>	G <sub>11</sub>	H <sub>12</sub>	I <sub>13</sub>
5,169	5,289	5,429	5,669	5,949	6,169	6,389	6,829	7,129	7,599	8,039

**BC4037 Bariatric Mobile Healthcare Chaise Recliner - Narrow Arms - Infinite Position Non-Locking Back**

COM	Dillon/Carson	A <sub>5</sub>	B <sub>6</sub>	C <sub>7</sub>	D <sub>8</sub>	E <sub>9</sub>	F <sub>10</sub>	G <sub>11</sub>	H <sub>12</sub>	I <sub>13</sub>
4,949	5,099	5,329	5,639	5,999	6,279	6,599	7,149	7,639	8,039	8,589

**BC4137 Bariatric Mobile Healthcare Chaise Recliner - Narrow Arms - Infinite Position Locking Back**

COM	Dillon/Carson	A <sub>5</sub>	B <sub>6</sub>	C <sub>7</sub>	D <sub>8</sub>	E <sub>9</sub>	F <sub>10</sub>	G <sub>11</sub>	H <sub>12</sub>	I <sub>13</sub>
5,419	5,539	5,759	6,059	6,419	6,689	6,999	7,549	7,969	8,479	8,909

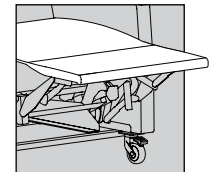

Chaise Models

## Dimensions

EB4037   EB4137   EBC4037   EBC4137	Overall			Seat			Back H	Arm H	Kick Out Seat D	Recline D	Distance from Wall
	W	D	H	W	D	H					
	37	34.5	47.5	29	21	21.5	28.5	28	40	75.5	20

### General Info

COM: 7 yds  
w/ Chaise COM: 8 yds  
Wt Cap: 750 lb  
Unit Weight: 162 lb

## Available Options

### ARM CAP OPTIONS

See pg 2 for finishes

U	Urethane	209
J1	Solid Surface - Group 1	619
J2	Solid Surface - Group 2	819
F	Fully Upholstered Arms	Standard

### CASTER OPTIONS

Q3	3" - Dual Wheel Central Locking System	1019
Q4	4" - Central Lock & Steer System	1019
Q5	5" - Central Lock & Steer System	1139
S4	4" - (2) Caster Lock & Steer System	569
4S3R1	4" - (3) Swivel/(1) Rigid Locking Casters	Standard
4S4	4" - (4) Swivel Locking Casters	39

### HEAT/MASSAGE OPTIONS (IEC 60601-1 CERTIFIED)

#### Wand Controls

HW	Heat	1139
HMW	Heat & Massage	1369

#### In-Arm Controls

H	Heat	849
HM	Heat & Massage	1119

### ADDITIONAL FEATURES & OPTIONS

PB	Push Bar	Standard
EG	Protective Edge Guard	Standard
QR	Additional Quick Release Accessory Bracket	69
CAL	CAL TB133	See pg 9
Z	Multi Cover	Use Pricing for Highest Grade

### PATIENT WELLNESS & COMFORT OPTIONS

AHP	Adjustable Head Rest Pillow (COM 1yd)	339
DP	Dual IV Poles & Brackets <sup>1</sup>	498
FBH	Foley Bag Holder	89
FT	Foot Tray	279
IV	IV Pole & Bracket <sup>1</sup>	249
LC	LiquiCell	229
LCKFR	Orthopedic Locking Footrest	399
MB2B	Moisture Barrier (Back)	89
MB2S	Moisture Barrier (Seat)	89
MR	Monitor Arm (right side facing) <sup>1,2</sup>	849
MTR	Monitor Arm with Tray (right side facing) <sup>1,2</sup>	949
PR1	Paper Roll Holder <sup>3</sup>	229
TE750	Trendelenburg (Bariatric)	459
USB	USB Power Outlet (IEC 60601-1 Certified)	459
WR	Wrist Restraint Mounts (pair)	229

### TRAY TABLE OPTIONS

TSR1	Adjustable (Right) Side Tray <sup>1,2,5</sup>	399	Solid Surface Trays*	
TD3	Dual Adjustable Side Trays (TSR1 & TSL1) <sup>1,5</sup>	798	Grp 1	Grp 2
LFSTR	Large Folding (Right) Side Tray <sup>4</sup>	269	739	959
LFSTRCH	Large Folding Cup Holder (Right) Side Tray	339	849	1099
PLFSTR	Padded Large Folding (Right) Side Tray	379	n/a	n/a
SFSTR	Small Folding (Right) Side Tray <sup>4</sup>	269	689	889

\*Refer to pg 130 for full option details and images\*

\*Finishes on pg 2

<sup>1</sup>Includes QR bracket connection installed on recliner

<sup>2</sup>Standard on right side (facing). Replace "R" with "L" for left side (facing) option where available.

<sup>3</sup>Takes place of Push Bar. Paper sold separately.

<sup>4</sup>Contact customer service for solid surface pricing

<sup>5</sup>Over the lap tray function recommended in seated position.



# DURABLE® 750 SERIES

# Bariatric Mobile Healthcare Recliners

Select Aesthetic Style (Denotes back & arm design)

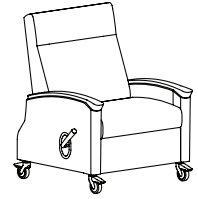
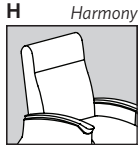

Select Functional Style (Aesthetic style code precedes selected model number below, e.g., KBC1117)

Model	COM	Dillon	Carson	A <sub>5</sub>	B <sub>6</sub>	C <sub>7</sub>	D <sub>8</sub>	E <sub>9</sub>	F <sub>10</sub>	G <sub>11</sub>	H <sub>12</sub>	I <sub>13</sub>
<b>5037 Bariatric Mobile Healthcare Recliner - Infinite Position Non-Locking Back</b>												
	5,049	5,119	5,319	5,549	5,799	6,019	6,259	6,689	7,029	7,499	7,939	
<b>5137 Bariatric Mobile Healthcare Recliner - Infinite Position Locking Back</b>												
	5,479	5,559	5,749	5,979	6,239	6,429	6,669	7,089	7,319	7,829	8,259	
<b>C5037 Bariatric Mobile Healthcare Chaise Recliner - Infinite Position Non-Locking Back</b>												
	5,299	5,409	5,639	5,959	6,299	6,599	6,909	7,469	7,769	8,219	8,649	
<b>C5137 Bariatric Mobile Healthcare Chaise Recliner - Infinite Position Locking Back</b>												
	5,729	5,839	6,079	6,399	6,739	6,989	7,299	7,839	8,069	8,479	9,129	

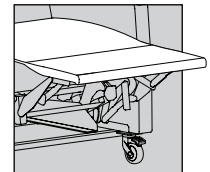

Chaise Models

## Dimensions

H5037   H5137   HC5037   HC5137	Overall			Seat			Back H	Arm H	Kick Out Seat D	Recline D	Distance from Wall
	W	D	H	W	D	H					
	39	38	47	29	21	21.5	26	28	40	73	20

### General Info

COM: 8 yds  
w/ Chaise COM: 7 yds  
Wt Cap: 750 lb  
Unit Weight: 162 lb

## Available Options

ARM CAP OPTIONS		See pg 2 for finishes
U	Urethane (black only in Harmony style)	Standard

CASTER OPTIONS	
S4	4" - (2) Caster Lock & Steer System 569
4S3R1	4" - (3) Swivel/(1) Rigid Locking Casters Standard
4S4	4" - (4) Swivel Locking Casters 39

HEAT/MASSAGE OPTIONS (IEC 60601-1 CERTIFIED)	
<i>Wand Controls</i>	
HW	Heat 1139
HMW	Heat & Massage 1369
<i>In-Arm Controls</i>	
H	Heat 849
HM	Heat & Massage 1119

ADDITIONAL FEATURES & OPTIONS	
PB	Push Bar Standard
EG	Protective Edge Guard Standard
QR	Additional Quick Release Accessory Bracket 69
CAL	CAL TB133 See pg 9
Z	Multi Cover Use Pricing for Highest Grade

PATIENT WELLNESS & COMFORT OPTIONS	
AHP	Adjustable Head Rest Pillow (COM 1yd) 339
DP	Dual IV Poles & Brackets <sup>1</sup> 498
FBH	Foley Bag Holder 89
FT	Foot Tray 279
IV	IV Pole & Bracket <sup>1</sup> 249
LC	LiquiCell 229
LCKFR	Orthopedic Locking Footrest 399
MB2B	Moisture Barrier (Back) 89
MB2S	Moisture Barrier (Seat) 89
MR	Monitor Arm (right side facing) <sup>1,2</sup> 849
MTR	Monitor Arm with Tray (right side facing) <sup>1,2</sup> 949
PR1	Paper Roll Holder <sup>3</sup> 229
TE750	Trendelenburg (Bariatric) 459
USB	USB Power Outlet (IEC 60601-1 Certified) 459
WR	Wrist Restraint Mounts (pair) 229

TRAY TABLE OPTIONS		Solid Surface Trays*	
TSR1	Adjustable (Right) Side Tray <sup>1,2,5</sup> 399	Grp 1	Grp 2
TD3	Dual Adjustable Side Trays (TSR1 & TSL1) <sup>1,5</sup> 798	269	739
LFSTR	Large Folding (Right) Side Tray <sup>4</sup> 269	739	959
LFSTRCH	Large Folding Cup Holder (Right) Side Tray 339	849	1099
PLFSTR	Padded Large Folding (Right) Side Tray 379	n/a	n/a
SFSTR	Small Folding (Right) Side Tray <sup>4</sup> 269	689	889

\*Refer to pg 130 for full option details and images\*

\*Finishes on pg 2

<sup>1</sup>Includes QR bracket connection installed on recliner

<sup>2</sup>Standard on right side (facing). Replace "R" with "L" for left side (facing) option where available.

<sup>3</sup>Takes place of Push Bar. Paper sold separately.

<sup>4</sup>Contact customer service for solid surface pricing

<sup>5</sup>Over the lap tray function recommended in seated position.





**Select Aesthetic Style** (Denotes back & arm design)

**E** EV-Narrow Arm

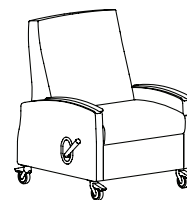

Single Fold Down Arm

**Select Functional Style** (Aesthetic style code precedes selected model number below, e.g., KC1117)

**B4067 Bari. Mobile Healthcare Recliner - Narrow Arms - Inf. Position Non-Locking Back - Single Fold Down Arm**

COM	Dillon/Carson	A <sub>5</sub>	B <sub>6</sub>	C <sub>7</sub>	D <sub>8</sub>	E <sub>9</sub>	F <sub>10</sub>	G <sub>11</sub>	H <sub>12</sub>	I <sub>13</sub>
5,959	6,019	6,159	6,399	6,609	6,839	7,149	7,519	7,939	8,339	8,699

**B4167 Bari. Mobile Healthcare Recliner - Narrow Arms - Inf. Position Locking Back - Single Fold Down Arm**

COM	Dillon/Carson	A <sub>5</sub>	B <sub>6</sub>	C <sub>7</sub>	D <sub>8</sub>	E <sub>9</sub>	F <sub>10</sub>	G <sub>11</sub>	H <sub>12</sub>	I <sub>13</sub>
6,399	6,449	6,599	6,819	7,009	7,259	7,559	7,889	8,269	8,679	8,989

**BC4067 Bari. Mobile Healthcare Chaise Recliner - Narrow Arms - Inf. Position Non-Locking Back - Single Fold Down Arm**

COM	Dillon/Carson	A <sub>5</sub>	B <sub>6</sub>	C <sub>7</sub>	D <sub>8</sub>	E <sub>9</sub>	F <sub>10</sub>	G <sub>11</sub>	H <sub>12</sub>	I <sub>13</sub>
6,149	6,279	6,459	6,789	7,059	7,379	7,749	8,219	8,799	9,239	9,579

**BC4167 Bari. Mobile Healthcare Chaise Recliner - Narrow Arms - Inf. Position Locking Back - Single Fold Down Arm**

COM	Dillon/Carson	A <sub>5</sub>	B <sub>6</sub>	C <sub>7</sub>	D <sub>8</sub>	E <sub>9</sub>	F <sub>10</sub>	G <sub>11</sub>	H <sub>12</sub>	I <sub>13</sub>
6,609	6,719	6,909	7,199	7,489	7,779	8,149	8,619	9,129	9,469	9,689

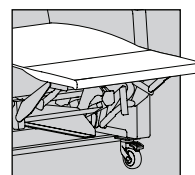

Chaise Models

**NOTE:** Transfer arm standard on right side (facing). If specified on left side, handle will be placed on right side and vice versa.

**Dimensions**

EB4067   EB4167   EBC4067   EBC4167	Overall			Seat			Back H	Arm H	Kick Out Seat D	Recline D	Distance from Wall
	W	D	H	W	D	H					
	37	34.5	47.5	29	21	21.5	28.5	27	40	75.5	20

**General Info**

COM: 7.1 yds  
w/ Chaise COM: 8 yds  
Wt Cap: 750 lb  
Unit Weight: 162 lb

**Available Options**

**ARM CAP OPTIONS**

See pg 2 for finishes

U	Urethane	Standard
J1	Solid Surface - Group 1	619
J2	Solid Surface - Group 2	819

**CASTER OPTIONS**

Q3	3" - Dual Wheel Central Locking System	1019
Q4	4" - Central Lock & Steer System	1019
Q5	5" - Central Lock & Steer System	1139
S4	4" - (2) Caster Lock & Steer System	569
4S3R1	4" - (3) Swivel/(1) Rigid Locking Casters	Standard
4S4	4" - (4) Swivel Locking Casters	39

**HEAT/MASSAGE OPTIONS (IEC 60601-1 CERTIFIED)**

*Wand Controls*

HW	Heat	1139
HMW	Heat & Massage	1369

*In-Arm Controls*

H	Heat	849
HM	Heat & Massage	1119

**ADDITIONAL FEATURES & OPTIONS**

PB	Push Bar	Standard
EG	Protective Edge Guard	Standard
QR	Additional Quick Release Accessory Bracket	69
CAL	CAL TB133	See pg 9
Z	Multi Cover	Use Pricing for Highest Grade

**PATIENT WELLNESS & COMFORT OPTIONS**

AHP	Adjustable Head Rest Pillow (COM 1 yd)	339
DP	Dual IV Poles & Brackets <sup>1</sup>	498
FBH	Foley Bag Holder	89
FT	Foot Tray	279
IV	IV Pole & Bracket <sup>1</sup>	249
LC	LiquiCell	229
LCKFR	Orthopedic Locking Footrest	399
MB2B	Moisture Barrier (Back)	89
MB2S	Moisture Barrier (Seat)	89
MR67	Monitor Arm, on Fold Down Arm <sup>1,2</sup>	899
MTR67	Monitor Arm with Tray, on Fold Down Arm <sup>1,2</sup>	999
PR1	Paper Roll Holder <sup>3</sup>	229
TE750	Trendelenburg (Bariatric)	459
USB	USB Power Outlet (IEC 60601-1 Certified)	459
WR	Wrist Restraint Mounts (pair)	229

**TRAY TABLE OPTIONS**

TSL1	Adjustable (Left) Side Tray, on Stationary Arm <sup>1,5</sup>	399
TSR167	Adjustable (Right) Side Tray, on Fold Down Arm <sup>1,5</sup>	449

**FOLD DOWN TRANSFER ARM SPECIFIC**

HC	Hinge Cover	Standard
----	-------------	----------

\*Refer to pg 130 for full option details and images\*

<sup>1</sup>Includes QR bracket connection installed on recliner

<sup>2</sup>Standard on right side (facing). Replace "R" with "L" for left side (facing) option where available.

<sup>3</sup>Takes place of Push Bar. Paper sold separately.

<sup>4</sup>Contact customer service for solid surface pricing

<sup>5</sup>Over the lap tray function recommended in seated position.





**Select Aesthetic Style** (Denotes back & arm design)

**E** EV-Narrow Arm

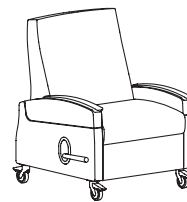
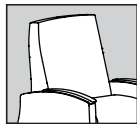

Dual Fold Down Arms

**Select Functional Style** (Aesthetic style code precedes selected model number below, e.g., KC117)

**B4062 Bari. Mobile Healthcare Recliner - Narrow Arms - Inf. Position Non-Locking Back - Dual Fold Down Arms**

COM	Dillon/Carson	A <sub>5</sub>	B <sub>6</sub>	C <sub>7</sub>	D <sub>8</sub>	E <sub>9</sub>	F <sub>10</sub>	G <sub>11</sub>	H <sub>12</sub>	I <sub>13</sub>
7,139	7,149	7,319	7,539	7,759	7,939	8,189	8,559	8,689	8,959	9,349

**B4162 Bari. Mobile Healthcare Recliner - Narrow Arms - Inf. Position Locking Back - Dual Fold Down Arms**

COM	Dillon/Carson	A <sub>5</sub>	B <sub>6</sub>	C <sub>7</sub>	D <sub>8</sub>	E <sub>9</sub>	F <sub>10</sub>	G <sub>11</sub>	H <sub>12</sub>	I <sub>13</sub>
7,579	7,589	7,789	7,989	8,119	8,339	8,609	8,909	9,039	9,359	9,709

**BC4062 Bari. Mobile Healthcare Chaise Recliner - Narrow Arms - Inf. Position Non-Locking Back - Dual Fold Down Arms**

COM	Dillon/Carson	A <sub>5</sub>	B <sub>6</sub>	C <sub>7</sub>	D <sub>8</sub>	E <sub>9</sub>	F <sub>10</sub>	G <sub>11</sub>	H <sub>12</sub>	I <sub>13</sub>
7,319	7,429	7,619	7,959	8,179	8,479	8,799	9,239	9,559	10,039	10,329

**BC4162 Bari. Mobile Healthcare Chaise Recliner - Narrow Arms - Inf. Position Locking Back - Dual Fold Down Arms**

COM	Dillon/Carson	A <sub>5</sub>	B <sub>6</sub>	C <sub>7</sub>	D <sub>8</sub>	E <sub>9</sub>	F <sub>10</sub>	G <sub>11</sub>	H <sub>12</sub>	I <sub>13</sub>
7,759	7,859	8,069	8,329	8,619	8,859	9,179	9,639	9,879	10,429	10,679

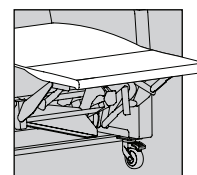

Chaise Models

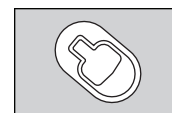

Locking Back Lever (located on outside arm on applicable models)

**Dimensions**

	Overall			Seat			Back H	Arm H	Kick Out Seat D	Recline D	Distance from Wall
	W	D	H	W	D	H					
EB4062   EB4162   EBC4062   EBC4162	37	34.5	47.5	29	21	21.5	28.5	27	40	75.5	20

**General Info**

COM: 7.3 yds  
w/ Chaise COM: 8.1 yds  
Wt Cap: 750 lb  
Unit Weight: 162 lb

**Available Options**

**ARM CAP OPTIONS**

See pg 2 for finishes

U	Urethane	Standard
J1	Solid Surface - Group 1	619
J2	Solid Surface - Group 2	819

**CASTER OPTIONS**

Q3	3" - Dual Wheel Central Locking System	1019
Q4	4" - Central Lock & Steer System	1019
Q5	5" - Central Lock & Steer System	1139
S4	4" - (2) Caster Lock & Steer System	569
453R1	4" - (3) Swivel/(1) Rigid Locking Casters	Standard
4S4	4" - (4) Swivel Locking Casters	39

**HEAT/MESSAGE OPTIONS (IEC 60601-1 CERTIFIED)**

*Wand Controls*

HW	Heat	1139
HMW	Heat & Massage	1369

**ADDITIONAL FEATURES & OPTIONS**

PB	Push Bar	Standard
EG	Protective Edge Guard	Standard
QR	Additional Quick Release Accessory Bracket	69
CAL	CAL TB133	See pg 9
Z	Multi Cover	Use Pricing for Highest Grade

**PATIENT WELLNESS & COMFORT OPTIONS**

AHP	Adjustable Head Rest Pillow (COM 1 yd)	339
DP	Dual IV Poles & Brackets <sup>1</sup>	498
FBH	Foley Bag Holder	89
FT	Foot Tray	279
IV	IV Pole & Bracket <sup>1</sup>	249
LC	LiquiCell	229
LCKFR	Orthopedic Locking Footrest	399
MB2B	Moisture Barrier (Back)	89
MB2S	Moisture Barrier (Seat)	89
MR67	Monitor Arm, on Fold Down Arm <sup>1,2</sup>	899
MTR67	Monitor Arm with Tray, on Fold Down Arm <sup>1,2</sup>	999
PR1	Paper Roll Holder <sup>3</sup>	229
TE750	Trendelenburg (Bariatric)	459
USB	USB Power Outlet (IEC 60601-1 Certified)	459
WR	Wrist Restraint Mounts (pair)	229

**TRAY TABLE OPTIONS**

TD362	Dual Adjustable Side Trays, on Fold Down Arms <sup>1,5</sup>	898
TSR167	Adjustable (Right) Side Tray, on Fold Down Arm <sup>1,5</sup>	449
TSL167	Adjustable (Left) Side Tray, on Fold Down Arm <sup>1,5</sup>	449

**FOLD DOWN TRANSFER ARM SPECIFIC**

HC	Hinge Cover	Standard
----	-------------	----------

\*Refer to pg 130 for full option details and images\*

<sup>1</sup>Includes QR bracket connection installed on recliner

<sup>2</sup>Standard on right side (facing). Replace "R" with "L" for left side (facing) option where available.

<sup>3</sup>Takes place of Push Bar. Paper sold separately.

<sup>4</sup>Contact customer service for solid surface pricing

<sup>5</sup>Over the lap tray function recommended in seated position.



**Select Aesthetic Style** (Denotes back & arm design)

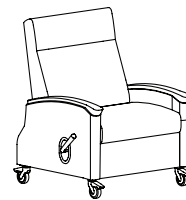

Single Removable Arm

**Select Functional Style** (Aesthetic style code precedes selected model number below, e.g., KC1117)

**5057 Bariatric Mobile Healthcare Recliner - Infinite Position Non-Locking Back - Single Removable Arm**

COM	Dillon/Carson	A <sub>5</sub>	B <sub>6</sub>	C <sub>7</sub>	D <sub>8</sub>	E <sub>9</sub>	F <sub>10</sub>	G <sub>11</sub>	H <sub>12</sub>	I <sub>13</sub>
5,519	5,689	5,839	6,189	6,499	6,839	7,229	7,749	8,129	8,569	8,989

**5157 Bariatric Mobile Healthcare Recliner - Infinite Position Locking Back - Single Removable Arm**

COM	Dillon/Carson	A <sub>5</sub>	B <sub>6</sub>	C <sub>7</sub>	D <sub>8</sub>	E <sub>9</sub>	F <sub>10</sub>	G <sub>11</sub>	H <sub>12</sub>	I <sub>13</sub>
5,979	6,129	6,279	6,619	6,939	7,259	7,619	8,139	8,459	8,909	9,129

**C5057 Bariatric Mobile Healthcare Chaise Recliner - Infinite Position Non-Locking Back - Single Removable Arm**

COM	Dillon/Carson	A <sub>5</sub>	B <sub>6</sub>	C <sub>7</sub>	D <sub>8</sub>	E <sub>9</sub>	F <sub>10</sub>	G <sub>11</sub>	H <sub>12</sub>	I <sub>13</sub>
5,769	5,979	6,169	6,619	6,999	7,429	7,869	8,519	8,899	9,369	9,599

**C5157 Bariatric Mobile Healthcare Chaise Recliner - Infinite Position Locking Back - Single Removable Arm**

COM	Dillon/Carson	A <sub>5</sub>	B <sub>6</sub>	C <sub>7</sub>	D <sub>8</sub>	E <sub>9</sub>	F <sub>10</sub>	G <sub>11</sub>	H <sub>12</sub>	I <sub>13</sub>
6,229	6,419	6,609	7,039	7,429	7,829	8,279	8,899	9,229	9,609	9,799

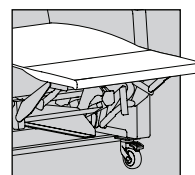

Chaise Models

**NOTE:** Transfer arm standard on right side (facing). If specified on left side, handle will be placed on right side and vice versa.

**Dimensions**

H5057   H5157   HC5057   HC5157	Overall			Seat			Back H	Arm H	Kick Out Seat D	Recline D	Distance from Wall
	W	D	H	W	D	H					
	39	38	47	29	21	21.5	26	28	40	73	19

**General Info**

COM: 7.2 yds  
w/ Chaise COM: 8.2 yds  
Wt Cap: 750 lb  
Unit Weight: 169 lb

**Available Options**

**ARM CAP OPTIONS** See pg 2 for finishes

U	Urethane (black only in Harmony style)	Standard
---	--	----------

**CASTER OPTIONS**

S4	4" - (2) Caster Lock & Steer System	569
4S3R1	4" - (3) Swivel/(1) Rigid Locking Casters	Standard
4S4	4" - (4) Swivel Locking Casters	39

**HEAT/MASSAGE OPTIONS (IEC 60601-1 CERTIFIED)**

*Wand Controls*

HW	Heat	1139
HMW	Heat & Massage	1369

*In-Arm Controls*

H	Heat	849
HM	Heat & Massage	1119

**ADDITIONAL FEATURES & OPTIONS**

PB	Push Bar	Standard
EG	Protective Edge Guard	Standard
QR	Additional Quick Release Accessory Bracket	69
CAL	CAL TB133	See pg 9
Z	Multi Cover	Use Pricing for Highest Grade

**PATIENT WELLNESS & COMFORT OPTIONS**

AHP	Adjustable Head Rest Pillow (COM 1 yd)	339
DP	Dual IV Poles & Brackets <sup>1</sup>	498
FBH	Foley Bag Holder	89
FT	Foot Tray	279
IV	IV Pole & Bracket <sup>1</sup>	249
LC	LiquiCell	229
LCKFR	Orthopedic Locking Footrest	399
MB2B	Moisture Barrier (Back)	89
MB2S	Moisture Barrier (Seat)	89
MR	Monitor Arm (right side facing) <sup>1,2</sup>	849
MTR	Monitor Arm with Tray (right side facing) <sup>1,2</sup>	949
PR1	Paper Roll Holder <sup>3</sup>	229
TE750	Trendelenburg (Bariatric)	459
USB	USB Power Outlet (IEC 60601-1 Certified)	459
WR	Wrist Restraint Mounts (pair)	229

**TRAY TABLE OPTIONS**

TSR1	Adjustable (Right) Side Tray <sup>1,2,5</sup>	399
TD3	Dual Adjustable Side Trays (TSR1 & TSL1) <sup>1,5</sup>	798

\*Refer to pg 130 for full option details and images\*

<sup>1</sup>Includes QR bracket connection installed on recliner  
<sup>2</sup>Standard on right side (facing). Replace "R" with "L" for left side (facing) option where available.  
<sup>3</sup>Takes place of Push Bar. Paper sold separately.

<sup>4</sup>Contact customer service for solid surface pricing  
<sup>5</sup>Over the lap tray function recommended in seated position.



# DURABLE® 750 SERIES

# Bariatric Mobile Healthcare Recliners

Select Aesthetic Style (Denotes back & arm design)

**KM** Kadia Mod

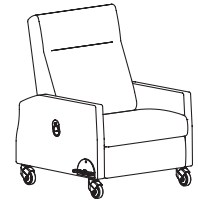
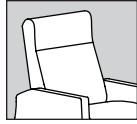

Select Functional Style (Aesthetic style code precedes selected model number below, e.g., KBC1117)

**KMB1237 Bariatric Controlled Environment Mobile Healthcare Recliner - Infinite Position Non-Locking Back**

COM	Dillon/Carson	A <sub>5</sub>	B <sub>6</sub>	C <sub>7</sub>	D <sub>8</sub>	E <sub>9</sub>	F <sub>10</sub>	G <sub>11</sub>	H <sub>12</sub>	I <sub>13</sub>
6,199	6,259	6,459	6,689	7,019	7,309	7,719	8,569	10,009	10,609	11,319



**Controlled Patient Environment Specializations**

Recliner models denoted as "Controlled Patient Environment" have specialized modifications (listed at right) that differ from standard features of similar products in their respective series.



**Cable Release Recline Operation**

Footrest is opened by pulling the cable release lever located on inside of arm. Lean forward and press down with legs to return footrest to closed position.

**Tamper-Resistant Hardware**

Recliner parts fastened together using tamper resistant hardware.

**Additional Options Available by Request**

Please contact your local sales representative to discuss specific needs.

**Dimensions**

	Overall			Seat			Back H	Arm H	Kick Out Seat D	Recline D	Distance from Wall
	W	D	H	W	D	H					
KMB1237	38	38.5	47	29	21	21.5	28	26.5	40	76.5	20

**General Info**

COM: 7 yds

Wt Cap: 750 lb  
Unit Weight: 162 yds

**Available Options**

**ARM CAP OPTIONS**

F	Fully Upholstered Arms	Standard
---	------------------------	----------

**CASTER OPTIONS**

Q3	3" - Dual Wheel Central Locking System	No Charge
Q4	4" - Central Lock & Steer System	Standard
Q5	5" - Central Lock & Steer System	119

**PATIENT WELLNESS & COMFORT OPTIONS**

LC	LiquiCell	229
MB2B	Moisture Barrier (Back)	89
MB2S	Moisture Barrier (Seat)	89

**ADDITIONAL FEATURES & OPTIONS**

EG	Protective Edge Guard	Standard
CAL	CAL TB133	See pg 9
Z	Multi Cover	Use Pricing for Highest Grade

Note: Controlled Patient Environment recliners are standard without Push Bar

\*Refer to pg 130 for full option details and images\*

# DURABLE® POWER SERIES



## Series Overview

The Durable® Power Series combines over a half century of recliner mastery with leading, proven technology to create something completely new to the healthcare space—fully adjustable infinite position power recliners featuring weightless zero gravity capability. The intuitive control wand is preset with easy access buttons for the most common positions, while individual movement controls allow users to fine tune the footrest, back, and seat angle to their specific level of comfort. These features are found across healthcare recliners and healthcare recliners with lift assist functionality.

## General Product Information

- 650 lb Static / 500 lb Dynamic Weight Rating
- Designed for 24/7 use healthcare environments
- Available with Lift Assist function
- Power operated recline functionality via control wand
- Footrest, back, and seat pitch can be controlled independently and precisely
- Control wand preset buttons include: Trendelenburg, Sleep, Zero Gravity, and Home (base position)
- Quick removable back & lift up seat for ease of cleaning
- True flatbed sleep position
- Standard with Chaise Continuous Leg Support feature
- Sinuous spring seat and back
- All steel base structure for maximum durability
- Seat clean-out
- Mid-Ottoman Calf Support
- Infinite Position Back reclines to infinite angle positions
- All interior plywood California Carb Compliant/Phase II
- Field replaceable components

## Options vary by model, see specific model page for list of available options

*Refer to pg 130 for full option details and images*

## To Order, Specify

- Model Number
- Textile
- Finish
- Options

### POWER CONTROL WAND

Cord pass through bezel placement is standard on outside of left (facing) arm. If single left (facing) transfer arm or single left side (facing) folding side tray specified, wand located on right side (facing). Wand connects magnetically to metal connector plate on outside of arm when not in use.

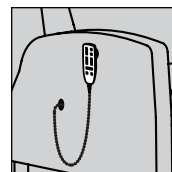

#### Connector Plate Placement:

**\*\*Plate & wand pass through bezel always located on same side**

*Stationary Arm without Folding Side Tray-  
side of arm, upper center*

*Stationary Arm with Folding Side Tray on both sides-  
side of arm, towards back*

*Dual Transfer Arms-  
side of arm, towards back*

Select Aesthetic Style (Denotes back & arm design)

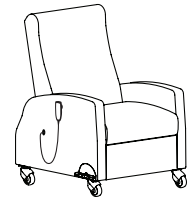
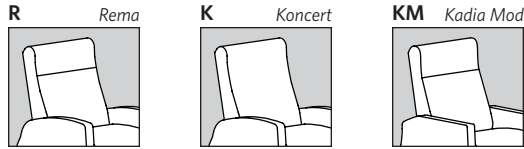

(Konkert style pictured)

Functional Style (Aesthetic style code precedes selected model number below, e.g., KCZP17)

CZP17 ZG Power Healthcare Recliner

COM	Dillon/Carson	A <sub>5</sub>	B <sub>6</sub>	C <sub>7</sub>	D <sub>8</sub>	E <sub>9</sub>	F <sub>10</sub>	G <sub>11</sub>	H <sub>12</sub>	I <sub>13</sub>
9,379	9,669	9,929	10,199	10,469	10,739	11,139	11,549	12,079	12,619	13,289

Standard Features

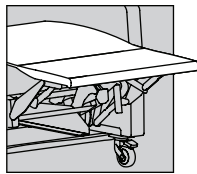

Chaise Continuous Leg Support

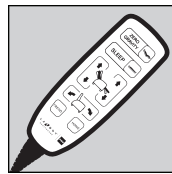

Recline Functions Operated by Intuitive Control Wand\*

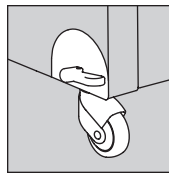

4" Central Locking Caster System

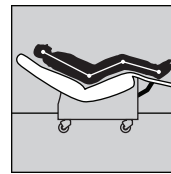

Weightless Zero Gravity Position via Wand Preset

\*Refer to pg 164 for wand placement location details

Dimensions

	Overall			Seat			Back H	Arm H	Kick Out Seat D	Recline D	Distance from Wall
	W	D	H	W	D	H					
RCZP17   KCZP17	33	37	46.5	24	21	22	27.5	26.5	40.5	68	15.5
KMCZP17	33	37	46.5	24	21	22	27.5	26.5	40.5	68	15.5

General Info

COM:	5.8 yds
Static Wt Cap:	650 lb
Dynamic Wt Cap:	500 lb
Unit Weight:	174 lb

Available Options

ARM CAP OPTIONS		See pg 2 for finishes	PATIENT WELLNESS & COMFORT OPTIONS	
U	Urethane	209	ABP	Adjustable Back Pad (COM 1.75 yds) Textile Grades COM-B 459 Textile Grades C-I 569
J1	Solid Surface - Group 1	619	AHP	Adjustable Head Rest Pillow (COM 1 yd) 339
J2	Solid Surface - Group 2	819	DP	Dual IV Poles & Brackets <sup>1</sup> 498
F	Fully Upholstered Arms	Standard	FBH	Foley Bag Holder 89
<b>CASTER OPTIONS</b>			FT	Foot Tray 279
Z-Q3	3" - Dual Wheel Central Locking System	No Charge	IV	IV Pole & Bracket <sup>1</sup> 249
Z-Q4	4" - Central Locking System	Standard	LC	LiquiCell 229
Z-Q5	5" - Central Locking System	119	LCKFR	Orthopedic Locking Footrest <sup>6</sup> Standard
A3	3" Auto-Locking Caster System	499	MBB	Moisture Barrier (Back) 59
A4	4" Auto-Locking Caster System	499	MBS	Moisture Barrier (Seat) 59
A5	5" Auto-Locking Caster System	619	MR	Monitor Arm (right side facing) <sup>1,2</sup> 849
<b>HEAT/MASSAGE OPTIONS (IEC 60601-1 CERTIFIED)</b>			MTR	Monitor Arm with Tray (right side facing) <sup>1,2</sup> 949
Wand Controls			PR1	Paper Roll Holder <sup>3</sup> 229
HW	Heat	1139	TE	Trendelenburg Standard
HMW	Heat & Massage	1369	USB	USB Power Outlet (IEC 60601-1 Certified) 459
In-Arm Controls			WR	Wrist Restraint Mounts (pair) 229
H	Heat	849	<b>TRAY TABLE OPTIONS</b>	
HM	Heat & Massage	1119	TSR1	Adjustable (Right) Side Tray <sup>1,2,5</sup> 399
<b>ADDITIONAL FEATURES &amp; OPTIONS</b>			TD3	Dual Adjustable Side Trays (TSR1 & TSL1) <sup>1,5</sup> 798
BBU	Battery Back Up	649	LFSTR	Large Folding (Right) Side Tray <sup>4,2</sup> 269
PB	Push Bar	Standard	LFSTRCH	Large Folding Cup Holder (Right) Side Tray <sup>2</sup> 339
EG	Protective Edge Guard	Standard	PLFSTR	Padded Large Folding (Right) Side Tray <sup>2</sup> 379
QR	Additional Quick Release Accessory Bracket	69	SFSTR	Small Folding (Right) Side Tray <sup>4,2</sup> 269
WH	Control Wand Holder	99	*Refer to pg 130 for full option details and images*	
Z	Multi Cover	Use Pricing for Highest Grade		

\*Finishes on pg 2

<sup>1</sup>Includes QR bracket connection installed on recliner  
<sup>2</sup>Standard on right side (facing). Replace "R" with "L" for left side (facing) option where available.  
<sup>3</sup>Takes place of Push Bar. Paper sold separately.

<sup>4</sup>Contact customer service for solid surface pricing  
<sup>5</sup>Over the lap tray function recommended in seated position.  
<sup>6</sup>Position is locked in place by motors and can only be adjusted by the control wand.



**Select Aesthetic Style** (Denotes back & arm design)

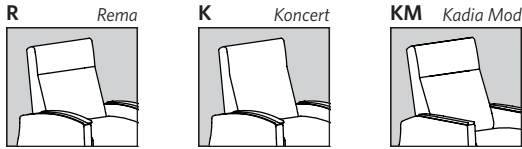

Single Fold Down Arm  
(Konzert style pictured)

**Functional Style** (Aesthetic style code precedes selected model number below, e.g., KCZP17)

**CZP67 ZG Power Healthcare Recliner - Single Fold Down Arm**

COM	Dillon/Carson	A <sub>5</sub>	B <sub>6</sub>	C <sub>7</sub>	D <sub>8</sub>	E <sub>9</sub>	F <sub>10</sub>	G <sub>11</sub>	H <sub>12</sub>	I <sub>13</sub>
10,329	10,609	10,869	11,139	11,399	11,679	12,079	12,479	13,019	13,569	14,229

**Standard Features**

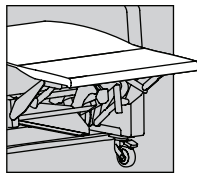

Chaise Continuous Leg Support

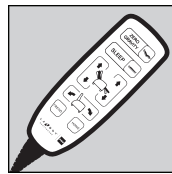

Recline Functions Operated by Intuitive Control Wand\*

\*Refer to pg 164 for wand placement location details

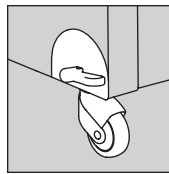

4" Central Locking Caster System

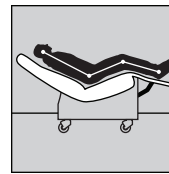

Weightless Zero Gravity Position via Wand Preset

**NOTE:** Transfer arm standard on right side (facing). Left side (facing) available, please specify if requested.

**Dimensions**

	Overall			Seat			Back H	Arm H	Kick Out Seat D	Recline D	Distance from Wall
	W	D	H	W	D	H					
RCZP67   KCZP67	33	37	46.5	24	21	22	27.5	26.5	40.5	68	15.5
KMCZP67	33	37	46.5	24	21	22	27.5	26.5	40.5	68	15.5

**General Info**

COM: 6 yds  
Static Wt Cap: 650 lb  
Dynamic Wt Cap: 500 lb  
Unit Weight: 174 lb

**Available Options** \*Refer to pg 130 for full option details and images\*

ARM CAP OPTIONS		See pg 2 for finishes	PATIENT WELLNESS & COMFORT OPTIONS	
U	Urethane	Standard	ABP	Adjustable Back Pad (COM 1.75 yds)
J1	Solid Surface - Group 1	619		Textile Grades COM-B 459
J2	Solid Surface - Group 2	819		Textile Grades C-I 569
<b>CASTER OPTIONS</b>			AHP	Adjustable Head Rest Pillow (COM 1 yd) 339
Z-Q3	3" - Dual Wheel Central Locking System	No Charge	DP	Dual IV Poles & Brackets <sup>1</sup> 498
Z-Q4	4" - Central Locking System	Standard	FBH	Foley Bag Holder 89
Z-Q5	5" - Central Locking System	119	FT	Foot Tray 279
A3	3" Auto-Locking Caster System	499	IV	IV Pole & Bracket <sup>1</sup> 249
A4	4" Auto-Locking Caster System	499	LC	LiquiCell 229
A5	5" Auto-Locking Caster System	619	LCKFR	Orthopedic Locking Footrest <sup>6</sup> Standard
<b>HEAT/MASSAGE OPTIONS (IEC 60601-1 CERTIFIED)</b>			MBB	Moisture Barrier (Back) 59
Wand Controls			MBS	Moisture Barrier (Seat) 59
HW	Heat	1139	MR67	Monitor Arm, on Fold Down Arm <sup>1,2</sup> 899
HMW	Heat & Massage	1369	MTR67	Monitor Arm with Tray, on Fold Down Arm <sup>1,2</sup> 999
In-Arm Controls			PR1	Paper Roll Holder <sup>3</sup> 229
H	Heat	849	TE	Trendelenburg Standard
HM	Heat & Massage	1119	USB	USB Power Outlet (IEC 60601-1 Certified) 459
<b>ADDITIONAL FEATURES &amp; OPTIONS</b>			WR	Wrist Restraint Mounts (pair) 229
BBU	Battery Back Up	649	<b>TRAY TABLE OPTIONS</b>	
PB	Push Bar	Standard	TSL1	Adjustable (Left) Side Tray, on Stationary Arm <sup>1,5</sup> 399
EG	Protective Edge Guard	Standard	TSR167	Adjustable (Right) Side Tray, on Fold Down Arm <sup>1,2,5</sup> 449
QR	Additional Quick Release Accessory Bracket	69	LFSTR	Large Folding (Right) Side Tray <sup>2,4</sup> 269
WH	Control Wand Holder	99	LFSTRCH	Large Folding Cup Holder (Right) Side Tray <sup>2</sup> 339
Z	Multi Cover	Use Pricing for Highest Grade	PLFSTR	Padded Large Folding (Right) Side Tray <sup>2</sup> 379
			SFSTR	Small Folding (Right) Side Tray <sup>2,4</sup> 269
			<b>FOLD DOWN TRANSFER ARM SPECIFIC</b>	
			HC	Hinge Cover Standard

Solid Surface Trays*	
Grp 1	Grp 2
739	959
849	1099
n/a	n/a
689	889

\*Finishes on pg 2

<sup>1</sup>Includes QR bracket connection installed on recliner

<sup>2</sup>Standard on right side (facing). Replace "R" with "L" for left side (facing) option where available.

<sup>3</sup>Takes place of Push Bar. Paper sold separately.

<sup>4</sup>Contact customer service for solid surface pricing

<sup>5</sup>Over the lap tray function recommended in seated position.

<sup>6</sup>Position is locked in place by motors and can only be adjusted by the control wand.



**Select Aesthetic Style** (Denotes back & arm design)

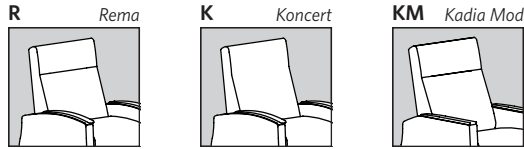

Dual Fold Down Arms  
(Konzert style pictured)

**Functional Style** (Aesthetic style code precedes selected model number below, e.g., KCZP17)

**CZP62 ZG Power Healthcare Recliner - Dual Fold Down Arms**

COM	Dillon/Carson	A <sub>5</sub>	B <sub>6</sub>	C <sub>7</sub>	D <sub>8</sub>	E <sub>9</sub>	F <sub>10</sub>	G <sub>11</sub>	H <sub>12</sub>	I <sub>13</sub>
11,009	11,269	11,549	11,809	12,079	12,349	12,749	13,159	13,689	14,229	14,889

**Standard Features**

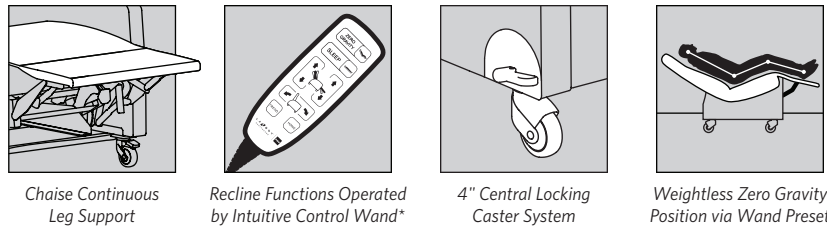

Chaise Continuous Leg Support

Recline Functions Operated by Intuitive Control Wand\*

4" Central Locking Caster System

Weightless Zero Gravity Position via Wand Preset

\*Refer to pg 164 for wand placement location details

**Dimensions**

	Overall			Seat			Back H	Arm H	Kick Out Seat D	Recline D	Distance from Wall
	W	D	H	W	D	H					
RCZP62   KCZP62	33	37	46.5	24	21	22	27.5	26.5	40.5	68	15.5
KMCZP62	33	37	46.5	24	21	22	27.5	26.5	40.5	68	15.5

General Info	
COM:	6.3 yds
Static Wt Cap:	650 lb
Dynamic Wt Cap:	500 lb
Unit Weight:	174 lb

**Available Options** \*Refer to pg 130 for full option details and images\*

ARM CAP OPTIONS		See pg 2 for finishes	PATIENT WELLNESS & COMFORT OPTIONS	
U	Urethane	Standard	ABP	Adjustable Back Pad (COM 1.75 yds)
J1	Solid Surface - Group 1	619		Textile Grades COM-B 459
J2	Solid Surface - Group 2	819		Textile Grades C-I 569
<b>CASTER OPTIONS</b>			AHP	Adjustable Head Rest Pillow (COM 1 yd) 339
Z-Q3	3" - Dual Wheel Central Locking System	No Charge	DP	Dual IV Poles & Brackets <sup>1</sup> 498
Z-Q4	4" - Central Locking System	Standard	FBH	Foley Bag Holder 89
Z-Q5	5" - Central Locking System	119	FT	Foot Tray 279
A3	3" Auto-Locking Caster System	499	IV	IV Pole & Bracket <sup>1</sup> 249
A4	4" Auto-Locking Caster System	499	LC	LiquiCell 229
A5	5" Auto-Locking Caster System	619	LCKFR	Orthopedic Locking Footrest <sup>6</sup> Standard
<b>HEAT/MASSAGE OPTIONS (IEC 60601-1 CERTIFIED)</b>			MBB	Moisture Barrier (Back) 59
Wand Controls			MBS	Moisture Barrier (Seat) 59
HW	Heat	1139	MR67	Monitor Arm, on Fold Down Arm <sup>1,2</sup> 899
HMW	Heat & Massage	1369	MTR67	Monitor Arm with Tray, on Fold Down Arm <sup>1,2</sup> 999
<b>ADDITIONAL FEATURES &amp; OPTIONS</b>			PR1	Paper Roll Holder <sup>3</sup> 229
BBU	Battery Back Up	649	TE	Trendelenburg Standard
PB	Push Bar	Standard	USB	USB Power Outlet (IEC 60601-1 Certified) 459
EG	Protective Edge Guard	Standard	WR	Wrist Restraint Mounts (pair) 229
QR	Additional Quick Release Accessory Bracket	69	<b>TRAY TABLE OPTIONS</b>	
WH	Control Wand Holder	99	TD362	Dual Adjustable Side Trays, on Fold Down Arms <sup>1,5</sup> 898
Z	Multi Cover	Use Pricing for Highest Grade	TSR167	Adjustable (Right) Side Tray, on Fold Down Arm <sup>1,5</sup> 449
			TSL167	Adjustable (Left) Side Tray, on Fold Down Arm <sup>1,5</sup> 449
			<b>FOLD DOWN TRANSFER ARM SPECIFIC</b>	
			HC	Hinge Cover Standard

<sup>1</sup>Includes QR bracket connection installed on recliner  
<sup>2</sup>Standard on right side (facing). Replace "R" with "L" for left side (facing) option where available.  
<sup>3</sup>Takes place of Push Bar. Paper sold separately.

<sup>4</sup>Contact customer service for solid surface pricing  
<sup>5</sup>Over the lap tray function recommended in seated position.  
<sup>6</sup>Position is locked in place by motors and can only be adjusted by the control wand.



**Select Aesthetic Style** (Denotes back & arm design)

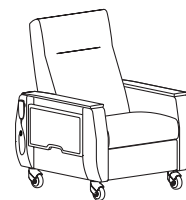
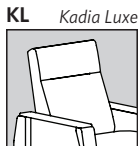

**Functional Style** (Aesthetic style code precedes selected model number below, e.g., KCZP17)

**KLCZP17 ZG Power Healthcare Recliner - Kadia Luxe Style**

COM	Dillon/Carson	A <sub>5</sub>	B <sub>6</sub>	C <sub>7</sub>	D <sub>8</sub>	E <sub>9</sub>	F <sub>10</sub>	G <sub>11</sub>	H <sub>12</sub>	I <sub>13</sub>
10,759	11,049	11,309	11,579	11,839	12,119	12,519	12,919	13,449	13,989	14,669

**Standard Features**

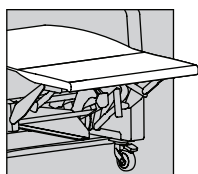

Chaise Continuous Leg Support

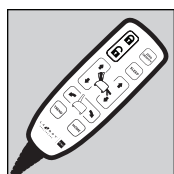

Recline Functions Operated by Intuitive Control Wand\*

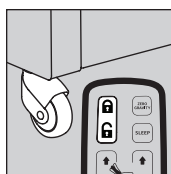

4" Auto-Locking Caster System

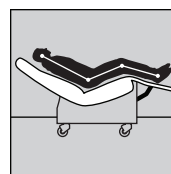

Weightless Zero Gravity Position via Wand Preset

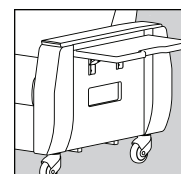

Dual Left/Right Integrated Side Tray Tables

\*Refer to pg 164 for wand placement location details

**Dimensions**

	Overall			Seat			Back H	Arm H	Kick Out Seat D	Recline D	Distance from Wall
	W	D	H	W	D	H					
KLCZP17	35	39	47	24	22	21.5	28	26.5	40	76.5	17.5

**General Info**

COM:	5.3 yds
Static Wt Cap:	650 lb
Dynamic Wt Cap:	500 lb
Unit Weight:	208 lb

**Available Options**

**ARM CAP OPTIONS**

See pg 2 for finishes

U	Urethane	Standard
J1	Solid Surface - Group 1	1239
J2	Solid Surface - Group 2	1439
T	Thermofoil	229

**CASTER OPTIONS**

A3	3" Auto-Locking Caster System	No Charge
A4	4" Auto-Locking Caster System	Standard
A5	5" Auto-Locking Caster System	119

**HEAT/MASSAGE OPTIONS (IEC 60601-1 CERTIFIED)**

<i>Wand Controls</i>		
HW	Heat	1139
HMW	Heat & Massage	1369
<i>In-Arm Controls</i>		
H	Heat	849
HM	Heat & Massage	1119

**ADDITIONAL FEATURES & OPTIONS**

BBU	Battery Back Up	649
PB	Push Bar	Standard
EG	Protective Edge Guard	Standard
QR	Additional Quick Release Accessory Bracket	69
WH	Control Wand Holder	99
Z	Multi Cover	Use Pricing for Highest Grade

**PATIENT WELLNESS & COMFORT OPTIONS**

ABP	Adjustable Back Pad (COM 1.75 yds)	
	Textile Grades COM-B	459
	Textile Grades C-I	569
AHP	Adjustable Head Rest Pillow (COM 1 yd)	339
DP	Dual IV Poles & Brackets <sup>1</sup>	498
FBH	Foley Bag Holder	89
FT	Foot Tray	279
IV	IV Pole & Bracket <sup>1</sup>	249
LC	LiquiCell	229
LCKFR	Orthopedic Locking Footrest <sup>6</sup>	Standard
MBB	Moisture Barrier (Back)	59
MBS	Moisture Barrier (Seat)	59
MR	Monitor Arm (right side facing) <sup>1,2</sup>	849
MTR	Monitor Arm with Tray (right side facing) <sup>1,2</sup>	949
PR1	Paper Roll Holder <sup>3</sup>	229
TE	Trendelenburg	Standard
USB	USB Power Outlet (IEC 60601-1 Certified)	459
<b>TRAY TABLE OPTIONS</b>		
KL-DFST	Kadia Luxe Dual Folding Side Trays <sup>4</sup>	Standard

\*Refer to pg 130 for full option details and images\*

<sup>1</sup>Includes QR bracket connection installed on recliner

<sup>2</sup>Standard on right side (facing). Replace "R" with "L" for left side (facing) option where available.

<sup>3</sup>Takes place of Push Bar. Paper sold separately.

<sup>4</sup>Side panels & folding side tray standard with thermofoil finish. See pg 2 for available finishes.

<sup>6</sup>Position is locked in place by motors and can only be adjusted by the control wand.



# DURABLE® POWER SERIES

# ZG Power Bariatric Healthcare Recliner

## Select Aesthetic Style *(Denotes back & arm design)*

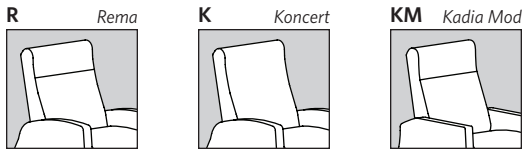

*(Konkert style pictured)*

## Functional Style *(Aesthetic style code precedes selected model number below, e.g., KCZP17)*

### BCZP37 ZG Power Bariatric Healthcare Recliner

COM	Dillon/Carson	A <sub>5</sub>	B <sub>6</sub>	C <sub>7</sub>	D <sub>8</sub>	E <sub>9</sub>	F <sub>10</sub>	G <sub>11</sub>	H <sub>12</sub>	I <sub>13</sub>
10,659	10,939	11,209	11,469	11,739	12,019	12,409	12,819	13,349	13,889	14,569

## Standard Features

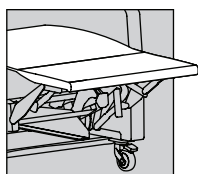

Chaise Continuous Leg Support

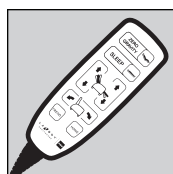

Recline Functions Operated by Intuitive Control Wand\*

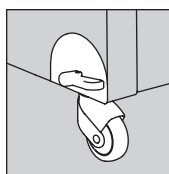

4" Central Locking Caster System

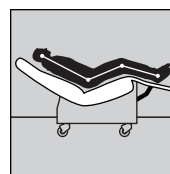

Weightless Zero Gravity Position via Wand Preset

\*Refer to pg 164 for wand placement location details

## Dimensions

	Overall			Seat			Back H	Arm H	Kick Out Seat D	Recline D	Distance from Wall
	W	D	H	W	D	H					
RBCZP37   KBCZP37	38	37	46.5	29	21	22	27.5	26.5	40.5	68	15.5
KMBCZP37	38	37	46.5	29	21	22	27.5	26.5	40.5	68	15.5

### General Info

COM:	8.3 yds
Static Wt Cap:	650 lb
Dynamic Wt Cap:	500 lb
Unit Weight:	207 lb

## Available Options

### ARM CAP OPTIONS

See pg 2 for finishes

U	Urethane	209
J1	Solid Surface - Group 1	619
J2	Solid Surface - Group 2	819
F	Fully Upholstered Arms	Standard

### CASTER OPTIONS

Z-Q3	3" - Dual Wheel Central Locking System	No Charge
Z-Q4	4" - Central Locking System	Standard
Z-Q5	5" - Central Locking System	119
A3	3" Auto-Locking Caster System	499
A4	4" Auto-Locking Caster System	499
A5	5" Auto-Locking Caster System	619

### HEAT/MASSAGE OPTIONS (IEC 60601-1 CERTIFIED)

<i>Wand Controls</i>		
HW	Heat	1139
HMW	Heat & Massage	1369
<i>In-Arm Controls</i>		
H	Heat	849
HM	Heat & Massage	1119

### ADDITIONAL FEATURES & OPTIONS

BBU	Battery Back Up	649
PB	Push Bar	Standard
EG	Protective Edge Guard	Standard
QR	Additional Quick Release Accessory Bracket	69
WH	Control Wand Holder	99
Z	Multi Cover	Use Pricing for Highest Grade

### PATIENT WELLNESS & COMFORT OPTIONS

ABP	Adjustable Back Pad (COM 1.75 yds)	
	Textile Grades COM-B	459
	Textile Grades C-I	569
AHP	Adjustable Head Rest Pillow (COM 1 yd)	339
DP	Dual IV Poles & Brackets <sup>1</sup>	498
FBH	Foley Bag Holder	89
FT	Foot Tray	279
IV	IV Pole & Bracket <sup>1</sup>	249
LC	LiquiCell	229
LCKFR	Orthopedic Locking Footrest <sup>6</sup>	Standard
MB2B	Moisture Barrier (Back)	89
MB2S	Moisture Barrier (Seat)	89
MR	Monitor Arm (right side facing) <sup>1,2</sup>	849
MTR	Monitor Arm with Tray (right side facing) <sup>1,2</sup>	949
PR1	Paper Roll Holder <sup>3</sup>	229
TE	Trendelenburg	Standard
USB	USB Power Outlet (IEC 60601-1 Certified)	459
WR	Wrist Restraint Mounts (pair)	229

### TRAY TABLE OPTIONS

TSR1	Adjustable (Right) Side Tray <sup>1,2,5</sup>	399	Solid Surface Trays*	
TD3	Dual Adjustable Side Trays (TSR1 & TSL1) <sup>1,5</sup>	798	Grp 1	Grp 2
LFSTR	Large Folding (Right) Side Tray <sup>4,2</sup>	299	739	959
LFSTRCH	Large Folding Cup Holder (Right) Side Tray <sup>2</sup>	339	849	1099
PLFSTR	Padded Large Folding (Right) Side Tray <sup>2</sup>	379	n/a	n/a
SFSTR	Small Folding (Right) Side Tray <sup>4,2</sup>	269	689	889

\*Refer to pg 130 for full option details and images\*

\*Finishes on pg 2

<sup>1</sup>Includes QR bracket connection installed on recliner

<sup>2</sup>Standard on right side (facing). Replace "R" with "L" for left side (facing) option where available.

<sup>3</sup>Takes place of Push Bar. Paper sold separately.

<sup>4</sup>Contact customer service for solid surface pricing

<sup>5</sup>Over the lap tray function recommended in seated position.

<sup>6</sup>Position is locked in place by motors and can only be adjusted by the control wand.



# DURABLE® POWER SERIES ZG Power Bariatric Healthcare Recliner | Patient Transfer

Select Aesthetic Style (Denotes back & arm design)

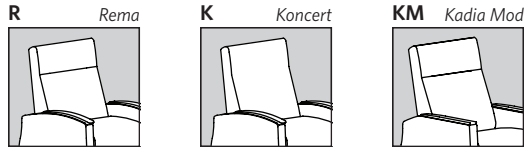

Single Fold Down Arm (Koncert style pictured)

Functional Style (Aesthetic style code precedes selected model number below, e.g., KCZP17)

## BCZP67 ZG Power Bariatric Healthcare Recliner - Single Fold Down Arm

COM	Dillon/Carson	A <sub>5</sub>	B <sub>6</sub>	C <sub>7</sub>	D <sub>8</sub>	E <sub>9</sub>	F <sub>10</sub>	G <sub>11</sub>	H <sub>12</sub>	I <sub>13</sub>
11,609	11,879	12,149	12,409	12,679	12,949	13,349	13,759	14,289	14,839	15,499

## Standard Features

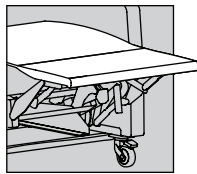

Chaise Continuous Leg Support

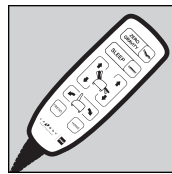

Recline Functions Operated by Intuitive Control Wand\*

\*Refer to pg 164 for wand placement location details

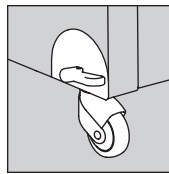

4" Central Locking Caster System

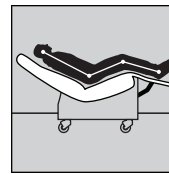

Weightless Zero Gravity Position via Wand Preset

**NOTE:** Transfer arm standard on right side (facing). Left side (facing) available, please specify if requested.

## Dimensions

	Overall			Seat			Back H	Arm H	Kick Out Seat D	Recline D	Distance from Wall
	W	D	H	W	D	H					
RBCZP67   KBCZP67	38	37	46.5	29	21	22	27.5	26.5	40.5	68	15.5
KMBCZP67	38	37	46.5	29	21	22	27.5	26.5	40.5	68	15.5

### General Info

COM:	8.3 yds
Static Wt Cap:	650 lb
Dynamic Wt Cap:	500 lb
Unit Weight:	207 lb

Available Options \*Refer to pg 130 for full option details and images\*

### ARM CAP OPTIONS

See pg 2 for finishes

U	Urethane	Standard
J1	Solid Surface - Group 1	619
J2	Solid Surface - Group 2	819

### CASTER OPTIONS

Z-Q3	3" - Dual Wheel Central Locking System	No Charge
Z-Q4	4" - Central Locking System	Standard
Z-Q5	5" - Central Locking System	119
A3	3" Auto-Locking Caster System	499
A4	4" Auto-Locking Caster System	499
A5	5" Auto-Locking Caster System	619

### HEAT/MASSAGE OPTIONS (IEC 60601-1 CERTIFIED)

Wand Controls		
HW	Heat	1139
HMW	Heat & Massage	1369
In-Arm Controls		
H	Heat	849
HM	Heat & Massage	1119

### ADDITIONAL FEATURES & OPTIONS

BBU	Battery Back Up	649
PB	Push Bar	Standard
EG	Protective Edge Guard	Standard
QR	Additional Quick Release Accessory Bracket	69
WH	Control Wand Holder	99
Z	Multi Cover	Use Pricing for Highest Grade

### PATIENT WELLNESS & COMFORT OPTIONS

ABP	Adjustable Back Pad (COM 1.75 yds)	
	Textile Grades COM-B	459
	Textile Grades C-I	569
AHP	Adjustable Head Rest Pillow (COM 1 yd)	339
DP	Dual IV Poles & Brackets <sup>1</sup>	498
FBH	Foley Bag Holder	89
FT	Foot Tray	279
IV	IV Pole & Bracket <sup>1</sup>	249
LC	LiquiCell	229
LCKFR	Orthopedic Locking Footrest <sup>6</sup>	Standard
MB2B	Moisture Barrier (Back)	89
MB2S	Moisture Barrier (Seat)	89
MR67	Monitor Arm, on Fold Down Arm <sup>1,2</sup>	899
MTR67	Monitor Arm with Tray, on Fold Down Arm <sup>1,2</sup>	999
PR1	Paper Roll Holder <sup>3</sup>	229
TE	Trendelenburg	Standard
USB	USB Power Outlet (IEC 60601-1 Certified)	459
WR	Wrist Restraint Mounts (pair)	229

### TRAY TABLE OPTIONS

		Solid Surface Trays*	
		Grp 1	Grp 2
TSL1	Adjustable (Left) Side Tray, on Stationary Arm <sup>1,5</sup>	399	
TSR167	Adjustable (Right) Side Tray, on Fold Down Arm <sup>1,2,5</sup>	449	
LFSTR	Large Folding (Right) Side Tray <sup>2,4</sup>	269	739 959
LFSTRCH	Large Folding Cup Holder (Right) Side Tray <sup>2</sup>	339	849 1099
PLFSTR	Padded Large Folding (Right) Side Tray <sup>2</sup>	379	n/a n/a
SFSTR	Small Folding (Right) Side Tray <sup>2,4</sup>	269	689 889

### FOLD DOWN TRANSFER ARM SPECIFIC

HC	Hinge Cover	Standard
----	-------------	----------

\*Finishes on pg 2

<sup>1</sup>Includes QR bracket connection installed on recliner

<sup>2</sup>Standard on right side (facing). Replace "R" with "L" for left side (facing) option where available.

<sup>3</sup>Takes place of Push Bar. Paper sold separately.

<sup>4</sup>Contact customer service for solid surface pricing

<sup>5</sup>Over the lap tray function recommended in seated position.

<sup>6</sup>Position is locked in place by motors and can only be adjusted by the control wand.

# DURABLE® POWER SERIES ZG Power Bariatric Healthcare Recliner | Patient Transfer

## Select Aesthetic Style (Denotes back & arm design)

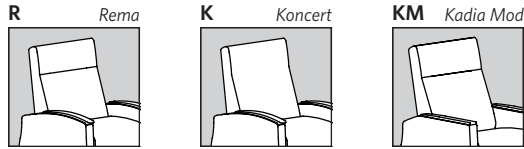

Dual Fold Down Arms  
(Konzert style pictured)

## Functional Style (Aesthetic style code precedes selected model number below, e.g., KCZP17)

### BCZP62 ZG Power Bariatric Healthcare Recliner - Dual Fold Down Arms

COM	Dillon/Carson	A <sub>5</sub>	B <sub>6</sub>	C <sub>7</sub>	D <sub>8</sub>	E <sub>9</sub>	F <sub>10</sub>	G <sub>11</sub>	H <sub>12</sub>	I <sub>13</sub>
12,279	12,549	12,819	13,089	13,349	13,629	14,019	14,429	14,959	15,499	16,169

## Standard Features

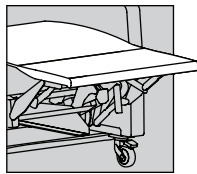

Chaise Continuous Leg Support

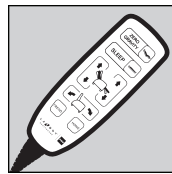

Recline Functions Operated by Intuitive Control Wand\*

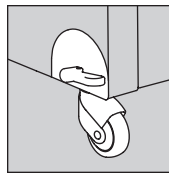

4" Central Locking Caster System

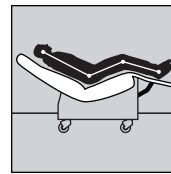

Weightless Zero Gravity Position via Wand Preset

\*Refer to pg 164 for wand placement location details

## Dimensions

	Overall			Seat			Back H	Arm H	Kick Out Seat D	Recline D	Distance from Wall
	W	D	H	W	D	H					
RBCZP62   KBCZP62	38	37	46.5	29	21	22	27.5	26.5	40.5	68	15.5
KMBCZP62	38	37	46.5	29	21	22	27.5	26.5	40.5	68	15.5

General Info	
COM:	8.5 yds
Static Wt Cap:	650 lb
Dynamic Wt Cap:	500 lb
Unit Weight:	207 lb

## Available Options \*Refer to pg 130 for full option details and images\*

### ARM CAP OPTIONS

See pg 2 for finishes

U	Urethane	Standard
J1	Solid Surface - Group 1	619
J2	Solid Surface - Group 2	819

### CASTER OPTIONS

Z-Q3	3" - Dual Wheel Central Locking System	No Charge
Z-Q4	4" - Central Locking System	Standard
Z-Q5	5" - Central Locking System	119
A3	3" Auto-Locking Caster System	499
A4	4" Auto-Locking Caster System	499
A5	5" Auto-Locking Caster System	619

### HEAT/MASSAGE OPTIONS (IEC 60601-1 CERTIFIED)

Wand Controls		
HW	Heat	1139
HMW	Heat & Massage	1369

### ADDITIONAL FEATURES & OPTIONS

BBU	Battery Back Up	649
PB	Push Bar	Standard
EG	Protective Edge Guard	Standard
QR	Additional Quick Release Accessory Bracket	69
WH	Control Wand Holder	99
Z	Multi Cover	Use Pricing for Highest Grade

### PATIENT WELLNESS & COMFORT OPTIONS

ABP	Adjustable Back Pad (COM 1.75 yds)	
	Textile Grades COM-B	459
	Textile Grades C-I	569
AHP	Adjustable Head Rest Pillow (COM 1 yd)	339
DP	Dual IV Poles & Brackets <sup>1</sup>	498
FBH	Foley Bag Holder	89
FT	Foot Tray	279
IV	IV Pole & Bracket <sup>1</sup>	249
LC	LiquiCell	229
LCKFR	Orthopedic Locking Footrest <sup>6</sup>	Standard
MB2B	Moisture Barrier (Back)	89
MB2S	Moisture Barrier (Seat)	89
MR67	Monitor Arm, on Fold Down Arm <sup>1,2</sup>	899
MTR67	Monitor Arm with Tray, on Fold Down Arm <sup>1,2</sup>	999
PR1	Paper Roll Holder <sup>3</sup>	229
TE	Trendelenburg	Standard
USB	USB Power Outlet (IEC 60601-1 Certified)	459
WR	Wrist Restraint Mounts (pair)	229

### TRAY TABLE OPTIONS

TD362	Dual Adjustable Side Trays, on Fold Down Arms <sup>1,5</sup>	898
TSR167	Adjustable (Right) Side Tray, on Fold Down Arm <sup>1,5</sup>	449
TSL167	Adjustable (Left) Side Tray, on Fold Down Arm <sup>1,5</sup>	449

### FOLD DOWN TRANSFER ARM SPECIFIC

HC	Hinge Cover	Standard
----	-------------	----------

<sup>1</sup>Includes QR bracket connection installed on recliner

<sup>2</sup>Standard on right side (facing). Replace "R" with "L" for left side (facing) option where available.

<sup>3</sup>Takes place of Push Bar. Paper sold separately.

<sup>4</sup>Contact customer service for solid surface pricing

<sup>5</sup>Over the lap tray function recommended in seated position.

<sup>6</sup>Position is locked in place by motors and can only be adjusted by the control wand.

# DURABLE® POWER SERIES

# ZG Lift Assist Power Healthcare Recliner

## Select Aesthetic Style *(Denotes back & arm design)*

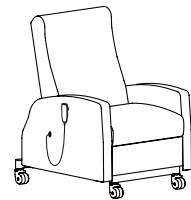
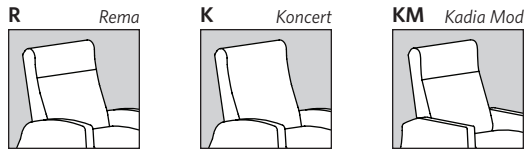

*(Konkert style pictured)*

## Functional Style *(Aesthetic style code precedes selected model number below, e.g., KCZL17)*

### CZL17 ZG Lift Assist Power Healthcare Recliner

COM	Dillon/Carson	A <sub>5</sub>	B <sub>6</sub>	C <sub>7</sub>	D <sub>8</sub>	E <sub>9</sub>	F <sub>10</sub>	G <sub>11</sub>	H <sub>12</sub>	I <sub>13</sub>
11,419	12,239	12,749	13,159	13,289	13,419	13,689	13,969	14,639	15,039	15,579

## Standard Features

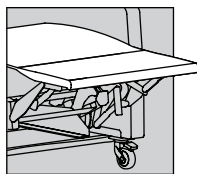

Chaise Continuous Leg Support

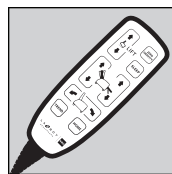

Recline Functions Operated by Intuitive Control Wand\*

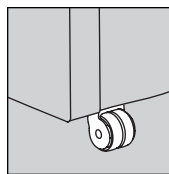

3" Automatic Central Locking Caster System

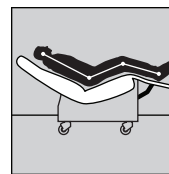

Weightless Zero Gravity Position via Wand Preset

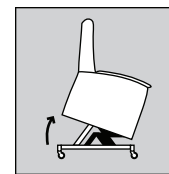

Lift Assist Function Aids User in Exiting Chair

\*Refer to pg 164 for wand placement location details

## Dimensions

	Overall			Seat			Back H	Arm H	Kick Out Seat D	Recline D	Distance from Wall
	W	D	H	W	D	H					
RCZL17   KCZL17	30.5	38.5	47.5	24	21.5	23.5	28	29.5	39	71	18.75
KMCZL17	30.5	38.5	47.5	24	21.5	23.5	28	29.5	39	71	18.75

### General Info

COM:	5.5 yds
Static Wt Cap:	650 lb
Dynamic Wt Cap:	500 lb
Unit Weight:	214 lb

## Available Options

### ARM CAP OPTIONS

See pg 2 for finishes

U	Urethane	209
J1	Solid Surface - Group 1	619
J2	Solid Surface - Group 2	819
F	Fully Upholstered Arms	Standard

### CASTER OPTIONS

ZL-Q3	3" Auto-Locking Central Caster System	Standard
ZL-Q4	4" Auto-Locking Central Caster System <i>Increases seat height by 1"</i>	No Charge
ZL-Q5	5" Auto-Locking Central Caster System <i>Increases seat height by 2"</i>	119

### HEAT/MESSAGE OPTIONS (IEC 60601-1 CERTIFIED)

<i>Wand Controls</i>		
HW	Heat	1139
HMW	Heat & Massage	1369
<i>In-Arm Controls</i>		
H	Heat	849
HM	Heat & Massage	1119

### ADDITIONAL FEATURES & OPTIONS

BBU	Battery Back Up	649
PB	Push Bar	Standard
EG	Protective Edge Guard	Standard
Z	Multi Cover	Use Pricing for Highest Grade
WH	Control Wand Holder	99

### PATIENT WELLNESS & COMFORT OPTIONS

ABP	Adjustable Back Pad (COM 1.75 yds)	
	Textile Grades COM-B	459
	Textile Grades C-I	569
AHP	Adjustable Head Rest Pillow (COM 1 yd)	339
FT	Foot Tray	279
LC	LiquiCell	229
LCKFR	Orthopedic Locking Footrest <sup>6</sup>	Standard
MBB	Moisture Barrier (Back)	59
MBS	Moisture Barrier (Seat)	59
PR1	Paper Roll Holder <sup>3</sup>	229
TE	Trendelenburg	Standard
USB	USB Power Outlet (IEC 60601-1 Certified)	459

\*Refer to pg 130 for full option details and images\*

<sup>3</sup>Takes place of Push Bar. Paper sold separately.

<sup>6</sup>Position is locked in place by motors and can only be adjusted by the control wand.

# DURABLE® POWER SERIES ZG Lift Assist Power Healthcare Recliner | Patient Transfer

## Select Aesthetic Style *(Denotes back & arm design)*

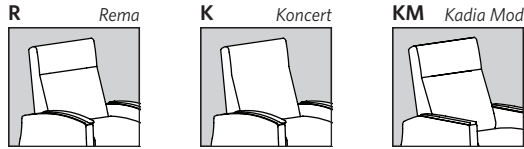

## Functional Style *(Aesthetic style code precedes selected model number below, e.g., KCZL17)*

### CZL67 ZG Lift Assist Power Healthcare Recliner - Single Fold Down Arm

COM	Dillon/Carson	A <sub>5</sub>	B <sub>6</sub>	C <sub>7</sub>	D <sub>8</sub>	E <sub>9</sub>	F <sub>10</sub>	G <sub>11</sub>	H <sub>12</sub>	I <sub>13</sub>
12,489	13,029	13,159	13,419	13,699	13,969	14,279	14,769	15,169	15,709	16,319

Single Fold Down Arm  
(Koncert style pictured)

**NOTE:** Transfer arm standard on right side (facing). Left side (facing) available, please specify if requested.

## Standard Features

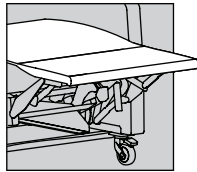

Chaise Continuous Leg Support

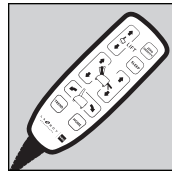

Recline Functions Operated by Intuitive Control Wand\*

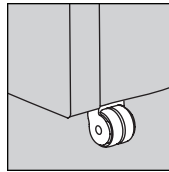

3" Automatic Central Locking Caster System

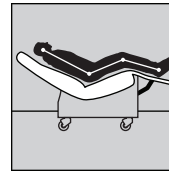

Weightless Zero Gravity Position via Wand Preset

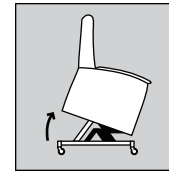

Lift Assist Function Aids User in Exiting Chair

\*Refer to pg 164 for wand placement location details

## Dimensions

	Overall			Seat			Back H	Arm H	Kick Out Seat D	Recline D	Distance from Wall
	W	D	H	W	D	H					
RCZL67   KCZL67	30.5	38.5	47.5	24	21.5	23.5	28	29.5	39	71	18.75
KMCZL67	30.5	38.5	47.5	24	21.5	23.5	28	29.5	39	71	18.75

### General Info

COM: 5.6 yds  
Static Wt Cap: 650 lb  
Dynamic Wt Cap: 500 lb  
Unit Weight: 214 lb

## Available Options

### ARM CAP OPTIONS

See pg 2 for finishes

U	Urethane	Standard
J1	Solid Surface - Group 1	619
J2	Solid Surface - Group 2	819

### CASTER OPTIONS

ZL-Q3	3" Auto-Locking Central Caster System	Standard
ZL-Q4	4" Auto-Locking Central Caster System <i>Increases seat height by 1"</i>	No Charge
ZL-Q5	5" Auto-Locking Central Caster System <i>Increases seat height by 2"</i>	119

### HEAT/MESSAGE OPTIONS (IEC 60601-1 CERTIFIED)

<i>Wand Controls</i>		
HW	Heat	1139
HMW	Heat & Massage	1369
<i>In-Arm Controls</i>		
H	Heat	849
HM	Heat & Massage	1119

### ADDITIONAL FEATURES & OPTIONS

BBU	Battery Back Up	649
PB	Push Bar	Standard
EG	Protective Edge Guard	Standard
Z	Multi Cover	Use Pricing for Highest Grade
WH	Control Wand Holder	99

### PATIENT WELLNESS & COMFORT OPTIONS

ABP	Adjustable Back Pad (COM 1.75 yds)	
	Textile Grades COM-B	459
	Textile Grades C-I	569
AHP	Adjustable Head Rest Pillow (COM 1 yd)	339
FT	Foot Tray	279
LC	LiquiCell	229
LCKFR	Orthopedic Locking Footrest <sup>6</sup>	Standard
MBB	Moisture Barrier (Back)	59
MBS	Moisture Barrier (Seat)	59
PR1	Paper Roll Holder <sup>3</sup>	229
TE	Trendelenburg	Standard
USB	USB Power Outlet (IEC 60601-1 Certified)	459

\*Refer to pg 130 for full option details and images\*

<sup>3</sup>Takes place of Push Bar. Paper sold separately.

<sup>6</sup>Position is locked in place by motors and can only be adjusted by the control wand.

# DURABLE® POWER SERIES ZG Lift Assist Power Healthcare Recliner | Patient Transfer

## Select Aesthetic Style (Denotes back & arm design)

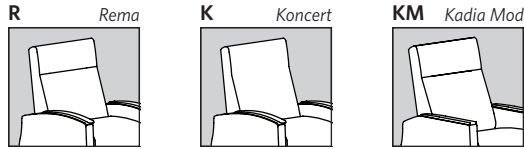

Dual Fold Down Arms  
(Koncert style pictured)

## Functional Style (Aesthetic style code precedes selected model number below, e.g., KCZL17)

### CZL62 ZG Lift Assist Power Healthcare Recliner - Dual Fold Down Arms

COM	Dillon/Carson	A <sub>5</sub>	B <sub>6</sub>	C <sub>7</sub>	D <sub>8</sub>	E <sub>9</sub>	F <sub>10</sub>	G <sub>11</sub>	H <sub>12</sub>	I <sub>13</sub>
13,129	13,419	13,569	13,949	14,159	14,489	14,769	15,169	15,709	16,119	16,649

## Standard Features

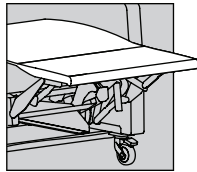

Chaise Continuous Leg Support

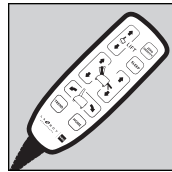

Recline Functions Operated by Intuitive Control Wand\*

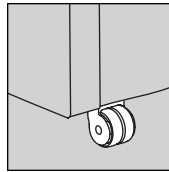

3" Automatic Central Locking Caster System

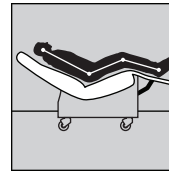

Weightless Zero Gravity Position via Wand Preset

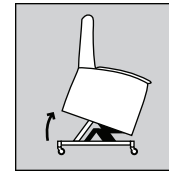

Lift Assist Function Aids User in Exiting Chair

\*Refer to pg 164 for wand placement location details

## Dimensions

	Overall			Seat			Back H	Arm H	Kick Out Seat D	Recline D	Distance from Wall
	W	D	H	W	D	H					
RCZL62   KCZL62	30.5	38.5	47.5	24	21.5	23.5	28	29.5	39	71	18.75
KMCZL62	30.5	38.5	47.5	24	21.5	23.5	28	29.5	39	71	18.75

### General Info

COM: 6 yds  
Static Wt Cap: 650 lb  
Dynamic Wt Cap: 500 lb  
Unit Weight: 214 lb

## Available Options

### ARM CAP OPTIONS

See pg 2 for finishes

U	Urethane	Standard
J1	Solid Surface - Group 1	619
J2	Solid Surface - Group 2	819

### CASTER OPTIONS

ZL-Q3	3" Auto-Locking Central Caster System	Standard
ZL-Q4	4" Auto-Locking Central Caster System <i>Increases seat height by 1"</i>	No Charge
ZL-Q5	5" Auto-Locking Central Caster System <i>Increases seat height by 2"</i>	119

### HEAT/MESSAGE OPTIONS (IEC 60601-1 CERTIFIED)

Wand Controls		
HW	Heat	1139
HMW	Heat & Massage	1369

### ADDITIONAL FEATURES & OPTIONS

BBU	Battery Back Up	649
PB	Push Bar	Standard
EG	Protective Edge Guard	Standard
Z	Multi Cover	Use Pricing for Highest Grade
WH	Control Wand Holder	99

### PATIENT WELLNESS & COMFORT OPTIONS

ABP	Adjustable Back Pad (COM 1.75 yds)	
	Textile Grades COM-B	459
	Textile Grades C-I	569
AHP	Adjustable Head Rest Pillow (COM 1 yd)	339
FT	Foot Tray	279
LC	LiquiCell	229
LCKFR	Orthopedic Locking Footrest <sup>6</sup>	Standard
MBB	Moisture Barrier (Back)	59
MBS	Moisture Barrier (Seat)	59
PR1	Paper Roll Holder <sup>3</sup>	229
TE	Trendelenburg	Standard
USB	USB Power Outlet (IEC 60601-1 Certified)	459

\*Refer to pg 130 for full option details and images\*

<sup>3</sup>Takes place of Push Bar. Paper sold separately.

<sup>6</sup>Position is locked in place by motors and can only be adjusted by the control wand.

# DURABLE® EXAM LIFT SERIES



## Series Overview

The Exam Lift Series is engineered with threefold functionality as a recliner, exam surface, and sleep space (with true flatbed position). Exam Lift Series recliners raise to a 36" exam height in all positions, while providing trusted comfort, performance, and durability. For enhanced safety, a central locking caster system is standard on all models to secure the chair when the user is elevated, and a locking leg support mechanism prevents the footrest from lowering unintentionally.

## General Product Information

- 650 lb Static / 500 lb Dynamic Weight Rating
- Designed for 24/7 use healthcare environments
- Raises to exam height via non-handed power foot pedal
- Power or manually operated recline functionality
- Footrest and back move in harmony when engaged
- Quick removable back & lift up seat for ease of cleaning
- Standard with Chaise Continuous Leg Support and Trendelenburg features
- Standard with Orthopedic Locking Footrest
- Sinuous spring seat and back
- All steel base structure for maximum durability
- Seat clean-out
- Mid-Ottoman Calf Support
- Infinite Position Back reclines to infinite angle positions
- All interior plywood California Carb Compliant/Phase II
- Field replaceable components

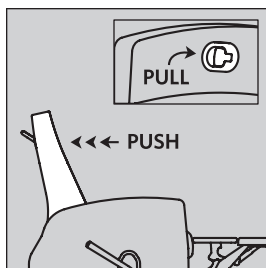

### Infinite Position Locking Back

Allows patient/caregiver to lock back into any position. Lock lever located inside left (facing) arm on applicable models, unless otherwise noted/pictured. (manual recline models)

## To Order, Specify

- Model Number
- Textile
- Finish
- Options

### POWER CONTROL WAND (ZG EXAM LIFT MODELS ONLY)

Cord pass through bezel placement is standard on outside of left (facing) arm. If single left (facing) transfer arm or single left side (facing) folding side tray specified, wand located on right side (facing). Wand connects magnetically to metal connector plate on outside of arm when not in use.

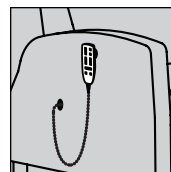

### Connector Plate Placement:

\*\*Plate & wand pass through bezel always located on same side

Stationary Arm without Folding Side Tray-side of arm, upper center

Stationary Arm with Folding Side Tray on both sides-side of arm, towards back

Dual Transfer Arms-side of arm, towards back

**Options vary by model, see specific model page for list of available options**

Refer to pg 130 for full option details and images

# DURABLE® EXAM LIFT SERIES

# ZG Exam Lift Power Healthcare Recliner

## Select Aesthetic Style *(Denotes back & arm design)*

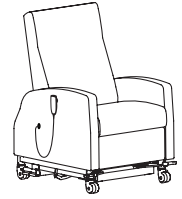
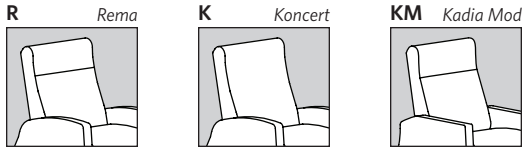

*(Konkert style pictured)*

## Functional Style *(Aesthetic style code precedes selected model number below, e.g., KCZX67)*

### CZX17 ZG Exam Lift Power Healthcare Recliner

COM	Dillon/Carson	A <sub>5</sub>	B <sub>6</sub>	C <sub>7</sub>	D <sub>8</sub>	E <sub>9</sub>	F <sub>10</sub>	G <sub>11</sub>	H <sub>12</sub>	I <sub>13</sub>
16,649	16,909	17,039	17,449	17,719	17,979	18,259	18,789	19,329	19,859	20,269

## Standard Features

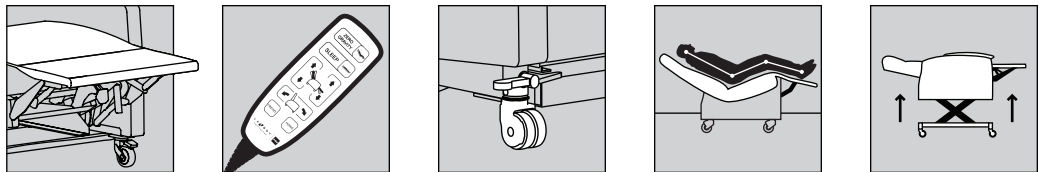

Chaise Continuous Leg Support

Recline Functions Operated by Intuitive Control Wand\*

3" Dual Wheel Central Locking Caster System

Weightless Zero Gravity Position via Wand Preset

Raise to Exam Height via Non-Handed Foot Pedals

\*Refer to pg 175 for wand placement location details

## Dimensions

	Overall			Seat			Back H	Arm H	Kick Out Seat D	Recline D	Distance from Wall
	W	D	H	W	D	H					
RCZX17   KCZX17	34.5	40.5	48.5	24	21	24.5	26	31	40	73	20
KMCZX17	34.5	40.5	48.5	24	21	24.5	26	31	40	73	20

### General Info

COM:	5.7 yds
Static Wt Cap:	650 lb
Dynamic Wt Cap:	500 lb
Unit Weight:	281 lb

## Available Options

ARM CAP OPTIONS		See pg 2 for finishes
U	Urethane	209
J1	Solid Surface - Group 1	619
J2	Solid Surface - Group 2	819
F	Fully Upholstered Arms	Standard
CASTER OPTIONS		
Z-Q3	3" - Dual Wheel Central Locking System	Standard
Z-Q4	4" - Central Locking System <i>Increases seat height by 1".</i>	No Charge
Z-Q5	5" - Central Locking System <i>Increases seat height by 2".</i>	119
HEAT/MASSAGE OPTIONS (IEC 60601-1 CERTIFIED)		
<i>Wand Controls</i>		
HW	Heat	1139
HMW	Heat & Massage	1369
<i>In-Arm Controls</i>		
H	Heat	849
HM	Heat & Massage	1119
ADDITIONAL FEATURES & OPTIONS		
BBU	Battery Back Up	649
PB	Push Bar	Standard
EG	Protective Edge Guard	Standard
QR	Additional Quick Release Accessory Bracket	69
WH	Control Wand Holder	99
Z	Multi Cover	Use Pricing for Highest Grade

PATIENT WELLNESS & COMFORT OPTIONS		
ABP	Adjustable Back Pad (COM 1.75 yds) Textile Grades COM-B	459
	Textile Grades C-I	569
AHP	Adjustable Head Rest Pillow (COM 1 yd)	339
DP	Dual IV Poles & Brackets <sup>1</sup>	498
FBH	Foley Bag Holder	89
IV	IV Pole & Bracket <sup>1</sup>	249
LC	LiquiCell	229
LCKFR	Orthopedic Locking Footrest <sup>6</sup>	Standard
MBB	Moisture Barrier (Back)	59
MBS	Moisture Barrier (Seat)	59
MR	Monitor Arm (right side facing) <sup>1,2</sup>	849
MTR	Monitor Arm with Tray (right side facing) <sup>1,2</sup>	949
PR1	Paper Roll Holder <sup>3</sup>	229
TE	Trendelenburg	Standard
USB	USB Power Outlet (IEC 60601-1 Certified)	459
WR	Wrist Restraint Mounts (pair)	229
TRAY TABLE OPTIONS		
TSR1	Adjustable (Right) Side Tray <sup>1,2,5</sup>	399
TD3	Dual Adjustable Side Trays (TSR1 & TSL1) <sup>1,5</sup>	798
LFSTR	Large Folding (Right) Side Tray <sup>4</sup>	269
LFSTRCH	Large Folding Cup Holder (Right) Side Tray	339
PLFSTR	Padded Large Folding (Right) Side Tray	379
SFSTR	Small Folding (Right) Side Tray <sup>4</sup>	269

Solid Surface Trays*		
Grp 1	Grp 2	
739	959	
849	1099	
n/a	n/a	
689	889	

\*Refer to pg 130 for full option details and images\*

\*Finishes on pg 2

<sup>1</sup>Includes QR bracket connection installed on recliner

<sup>2</sup>Standard on right side (facing). Replace "R" with "L" for left side (facing) option where available.

<sup>3</sup>Takes place of Push Bar. Paper sold separately.

<sup>4</sup>Contact customer service for solid surface pricing

<sup>5</sup>Over the lap tray function recommended in seated position.

<sup>6</sup>Position is locked in place by motors and can only be adjusted by the control wand.

# DURABLE® EXAM LIFT SERIES ZG Exam Lift Power Healthcare Recliner | Patient Transfer

## Select Aesthetic Style *(Denotes back & arm design)*

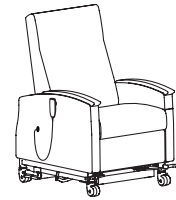
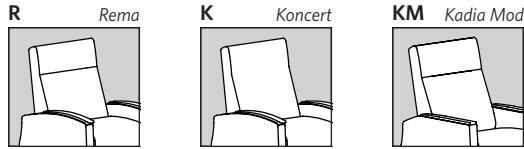

## Functional Style *(Aesthetic style code precedes selected model number below, e.g., KCZX67)*

### CZX67 ZG Exam Lift Power Healthcare Recliner - Single Fold Down Arm

COM	Dillon/Carson	A <sub>5</sub>	B <sub>6</sub>	C <sub>7</sub>	D <sub>8</sub>	E <sub>9</sub>	F <sub>10</sub>	G <sub>11</sub>	H <sub>12</sub>	I <sub>13</sub>
17,179	17,449	17,579	17,979	18,259	18,519	18,919	19,459	19,989	20,529	21,069

Single Fold Down Arm  
(Koncert style pictured)

**NOTE:** Transfer arm standard on right side (facing). Left side (facing) available, please specify if requested.

## Standard Features

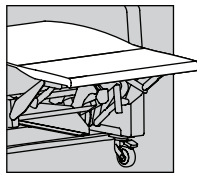

Chaise Continuous Leg Support

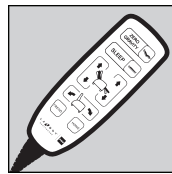

Recline Functions Operated by Intuitive Control Wand\*

\*Refer to pg 175 for wand placement location details

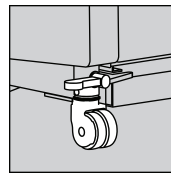

3" Dual Wheel Central Locking Caster System

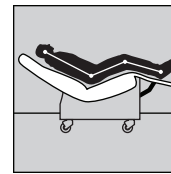

Weightless Zero Gravity Position via Wand Preset

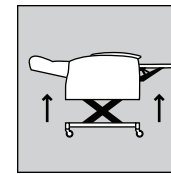

Raise to Exam Height via Non-Handed Foot Pedals

## Dimensions

	Overall			Seat			Back H	Arm H	Kick Out Seat D	Recline D	Distance from Wall
	W	D	H	W	D	H					
RCZX67   KCZX67	34.5	40.5	48.5	24	21	24.5	26	31	40	73	20
KMCZX67	34.5	40.5	48.5	24	21	24.5	26	31	40	73	20

### General Info

COM: 5.9 yds  
Static Wt Cap: 650 lb  
Dynamic Wt Cap: 500 lb  
Unit Weight: 281 lb

## Available Options *\*Refer to pg 130 for full option details and images\**

### ARM CAP OPTIONS

See pg 2 for finishes

U	Urethane	Standard
J1	Solid Surface - Group 1	619
J2	Solid Surface - Group 2	819

### CASTER OPTIONS

Z-Q3	3" - Dual Wheel Central Locking System	Standard
Z-Q4	4" - Central Locking System <i>Increases seat height by 1".</i>	No Charge
Z-Q5	5" - Central Locking System <i>Increases seat height by 2".</i>	119

### HEAT/MASSAGE OPTIONS (IEC 60601-1 CERTIFIED)

<i>Wand Controls</i>		
HW	Heat	1139
HMW	Heat & Massage	1369
<i>In-Arm Controls</i>		
H	Heat	849
HM	Heat & Massage	1119

### ADDITIONAL FEATURES & OPTIONS

BBU	Battery Back Up	649
PB	Push Bar	Standard
EG	Protective Edge Guard	Standard
QR	Additional Quick Release Accessory Bracket	69
WH	Control Wand Holder	99
Z	Multi Cover	Use Pricing for Highest Grade

### PATIENT WELLNESS & COMFORT OPTIONS

ABP	Adjustable Back Pad (COM 1.75 yds) Textile Grades COM-B	459
	Textile Grades C-I	569
AHP	Adjustable Head Rest Pillow (COM 1 yd)	339
DP	Dual IV Poles & Brackets <sup>1</sup>	498
FBH	Foley Bag Holder	89
IV	IV Pole & Bracket <sup>1</sup>	249
LC	LiquiCell	229
LCKFR	Orthopedic Locking Footrest <sup>6</sup>	Standard
MBB	Moisture Barrier (Back)	59
MBS	Moisture Barrier (Seat)	59
MR67	Monitor Arm, on Fold Down Arm <sup>1,2</sup>	899
MTR67	Monitor Arm with Tray, on Fold Down Arm <sup>1,2</sup>	999
PR1	Paper Roll Holder <sup>3</sup>	229
TE	Trendelenburg	Standard
USB	USB Power Outlet (IEC 60601-1 Certified)	459
WR	Wrist Restraint Mounts (pair)	229

### TRAY TABLE OPTIONS

		Solid Surface Trays*	
		Grp 1	Grp 2
TSL1	Adjustable (Left) Side Tray, on Stationary Arm <sup>1,5</sup>	399	
TSR167	Adjustable (Right) Side Tray, on Fold Down Arm <sup>1,2,5</sup>	449	
LFSTR	Large Folding (Right) Side Tray <sup>2,4</sup>	269	739 959
LFSTRCH	Large Folding Cup Holder (Right) Side Tray <sup>2</sup>	339	849 1099
PLFSTR	Padded Large Folding (Right) Side Tray <sup>2</sup>	379	n/a n/a
SFSTR	Small Folding (Right) Side Tray <sup>2,4</sup>	269	689 889

### FOLD DOWN TRANSFER ARM SPECIFIC

HC	Hinge Cover	Standard
----	-------------	----------

\*Finishes on pg 2

<sup>1</sup>Includes QR bracket connection installed on recliner

<sup>2</sup>Standard on right side (facing). Replace "R" with "L" for left side (facing) option where available.

<sup>3</sup>Takes place of Push Bar. Paper sold separately.

<sup>4</sup>Contact customer service for solid surface pricing

<sup>5</sup>Over the lap tray function recommended in seated position.

<sup>6</sup>Position is locked in place by motors and can only be adjusted by the control wand.

# DURABLE® EXAM LIFT SERIES ZG Exam Lift Power Healthcare Recliner | Patient Transfer

## Select Aesthetic Style *(Denotes back & arm design)*

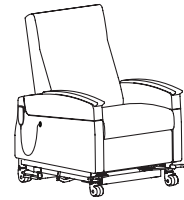
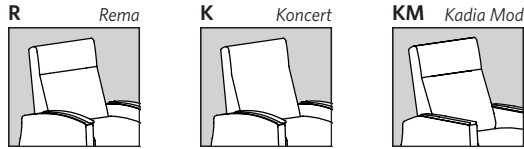

Dual Fold Down Arms  
(Koncert style pictured)

## Functional Style *(Aesthetic style code precedes selected model number below, e.g., KCZX67)*

### CZX62 ZG Exam Lift Power Healthcare Recliner - Dual Fold Down Arms

COM	Dillon/Carson	A <sub>5</sub>	B <sub>6</sub>	C <sub>7</sub>	D <sub>8</sub>	E <sub>9</sub>	F <sub>10</sub>	G <sub>11</sub>	H <sub>12</sub>	I <sub>13</sub>
17,719	17,979	18,119	18,519	18,789	19,049	19,459	20,129	20,669	21,339	22,009

## Standard Features

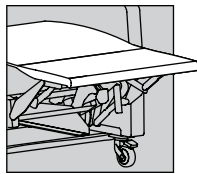

Chaise Continuous Leg Support

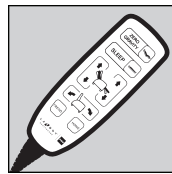

Recline Functions Operated by Intuitive Control Wand\*

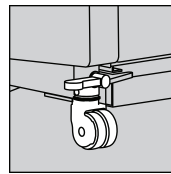

3" Dual Wheel Central Locking Caster System

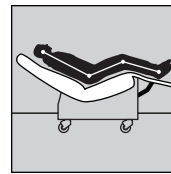

Weightless Zero Gravity Position via Wand Preset



Raise to Exam Height via Non-Handed Foot Pedals

\*Refer to pg 175 for wand placement location details

## Dimensions

	Overall			Seat			Back H	Arm H	Kick Out Seat D	Recline D	Distance from Wall
	W	D	H	W	D	H					
RCZX62   KCZX62	34.5	40.5	48.5	24	21	24.5	26	31	40	73	20
KMCZX62	34.5	40.5	48.5	24	21	24.5	26	31	40	73	20

### General Info

COM:	6.3 yds
Static Wt Cap:	650 lb
Dynamic Wt Cap:	500 lb
Unit Weight:	281 lb

## Available Options *\*Refer to pg 130 for full option details and images\**

### ARM CAP OPTIONS

See pg 2 for finishes

U	Urethane	Standard
J1	Solid Surface - Group 1	619
J2	Solid Surface - Group 2	819

### CASTER OPTIONS

Z-Q3	3" - Dual Wheel Central Locking System	Standard
Z-Q4	4" - Central Locking System <i>Increases seat height by 1".</i>	No Charge
Z-Q5	5" - Central Locking System <i>Increases seat height by 2".</i>	119

### HEAT/MASSAGE OPTIONS (IEC 60601-1 CERTIFIED)

<i>Wand Controls</i>		
HW	Heat	1139
HMW	Heat & Massage	1369

### ADDITIONAL FEATURES & OPTIONS

BBU	Battery Back Up	649
PB	Push Bar	Standard
EG	Protective Edge Guard	Standard
QR	Additional Quick Release Accessory Bracket	69
WH	Control Wand Holder	99
Z	Multi Cover	Use Pricing for Highest Grade

### PATIENT WELLNESS & COMFORT OPTIONS

ABP	Adjustable Back Pad (COM 1.75 yds) Textile Grades COM-B	459
	Textile Grades C-I	569
AHP	Adjustable Head Rest Pillow (COM 1 yd)	339
DP	Dual IV Poles & Brackets <sup>1</sup>	498
FBH	Foley Bag Holder	89
IV	IV Pole & Bracket <sup>1</sup>	249
LC	LiquiCell	229
LCKFR	Orthopedic Locking Footrest <sup>6</sup>	Standard
MBB	Moisture Barrier (Back)	59
MBS	Moisture Barrier (Seat)	59
MR67	Monitor Arm, on Fold Down Arm <sup>1,2</sup>	899
MTR67	Monitor Arm with Tray, on Fold Down Arm <sup>1,2</sup>	999
PR1	Paper Roll Holder <sup>3</sup>	229
TE	Trendelenburg	Standard
USB	USB Power Outlet (IEC 60601-1 Certified)	459
WR	Wrist Restraint Mounts (pair)	229

### TRAY TABLE OPTIONS

TD362	Dual Adjustable Side Trays, on Fold Down Arms <sup>1,5</sup>	898
TSR167	Adjustable (Right) Side Tray, on Fold Down Arm <sup>1,5</sup>	449
TSL167	Adjustable (Left) Side Tray, on Fold Down Arm <sup>1,5</sup>	449

### FOLD DOWN TRANSFER ARM SPECIFIC

HC	Hinge Cover	Standard
----	-------------	----------

<sup>1</sup>Includes QR bracket connection installed on recliner

<sup>2</sup>Standard on right side (facing). Replace "R" with "L" for left side (facing) option where available.

<sup>3</sup>Takes place of Push Bar. Paper sold separately.

<sup>4</sup>Contact customer service for solid surface pricing

<sup>5</sup>Over the lap tray function recommended in seated position.

<sup>6</sup>Position is locked in place by motors and can only be adjusted by the control wand.

# DURABLE® EXAM LIFT SERIES

# Exam Lift Healthcare Recliner

## Select Aesthetic Style *(Denotes back & arm design)*

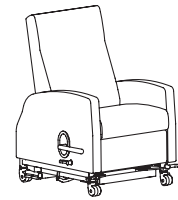
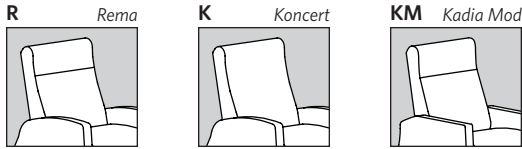

(Koncert style pictured)

## Functional Style *(Aesthetic style code precedes selected model number below, e.g., KC7X67)*

### C7X18 Exam Lift Recliner - Infinite Position Locking Back

COM	Dillon/Carson	A <sub>5</sub>	B <sub>6</sub>	C <sub>7</sub>	D <sub>8</sub>	E <sub>9</sub>	F <sub>10</sub>	G <sub>11</sub>	H <sub>12</sub>	I <sub>13</sub>
14,149	14,299	14,469	14,639	14,779	14,999	15,119	15,249	15,609	15,909	16,309

## Standard Features

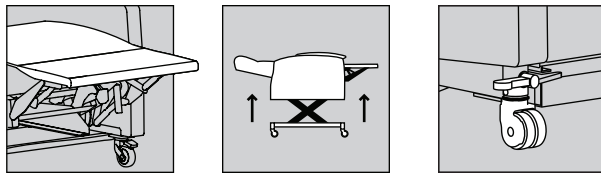

Chaise Continuous Leg Support

Raise to Exam Height via Non-Handed Foot Pedals

3" Dual Wheel Central Locking Caster System

## Dimensions

	Overall			Seat			Back H	Arm H	Kick Out Seat D	Recline D	Distance from Wall
	W	D	H	W	D	H					
RC7X18   KC7X18	34.5	40.5	48.5	24	21	23.5	26	28	40	73	20
KMC7X18	34.5	40.5	48.5	24	21	23.5	26	28	40	73	20

### General Info

COM:	5.3 yds
Static Wt Cap:	650 lb
Dynamic Wt Cap:	500 lb
Unit Weight:	263 lb

## Available Options

ARM CAP OPTIONS		See pg 2 for finishes
U	Urethane	209
J1	Solid Surface - Group 1	619
J2	Solid Surface - Group 2	819
F	Fully Upholstered Arms	Standard
CASTER OPTIONS		
Z-Q3	3" - Dual Wheel Central Locking System	Standard
Z-Q4	4" - Central Locking System <i>Increases seat height by 1".</i>	No Charge
Z-Q5	5" - Central Locking System <i>Increases seat height by 2".</i>	119
HEAT/MASSAGE OPTIONS (IEC 60601-1 CERTIFIED)		
<i>Wand Controls</i>		
HW	Heat	1139
HMW	Heat & Massage	1369
<i>In-Arm Controls</i>		
H	Heat	849
HM	Heat & Massage	1119
ADDITIONAL FEATURES & OPTIONS		
BBU	Battery Back Up	649
PB	Push Bar	Standard
EG	Protective Edge Guard	Standard
QR	Additional Quick Release Accessory Bracket	69
Z	Multi Cover	Use Pricing for Highest Grade

PATIENT WELLNESS & COMFORT OPTIONS		
ABP	Adjustable Back Pad (COM 1.75 yds) Textile Grades COM-B	459
	Textile Grades C-I	569
AHP	Adjustable Head Rest Pillow (COM 1 yd)	339
DP	Dual IV Poles & Brackets <sup>1</sup>	498
FBH	Foley Bag Holder	89
IV	IV Pole & Bracket <sup>1</sup>	249
LC	LiquiCell	229
LCKFR	Orthopedic Locking Footrest	Standard
MBB	Moisture Barrier (Back)	59
MBS	Moisture Barrier (Seat)	59
MR	Monitor Arm (right side facing) <sup>1,2</sup>	849
MTR	Monitor Arm with Tray (right side facing) <sup>1,2</sup>	949
PR1	Paper Roll Holder <sup>3</sup>	229
TE	Trendelenburg	Standard
USB	USB Power Outlet (IEC 60601-1 Certified)	459
WR	Wrist Restraint Mounts (pair)	229

TRAY TABLE OPTIONS		Solid Surface Trays*	
		Grp 1	Grp 2
TSR1	Adjustable (Right) Side Tray <sup>1,2,5</sup>	399	798
TD3	Dual Adjustable Side Trays (TSR1 & TSL1) <sup>1,5</sup>	298	739
LFSTR	Large Folding (Right) Side Tray <sup>4</sup>	269	849
LFSTRCH	Large Folding Cup Holder (Right) Side Tray	339	1099
PLFSTR	Padded Large Folding (Right) Side Tray	379	n/a
SFSTR	Small Folding (Right) Side Tray <sup>4</sup>	269	689

\*Refer to pg 130 for full option details and images\*

\*Finishes on pg 2

<sup>1</sup>Includes QR bracket connection installed on recliner

<sup>2</sup>Standard on right side (facing). Replace "R" with "L" for left side (facing) option where available.

<sup>3</sup>Takes place of Push Bar. Paper sold separately.

<sup>4</sup>Contact customer service for solid surface pricing

<sup>5</sup>Over the lap tray function recommended in seated position.



# DURABLE® EXAM LIFT SERIES

# Exam Lift Healthcare Recliner | Patient Transfer

## Select Aesthetic Style *(Denotes back & arm design)*

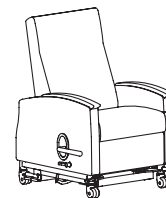
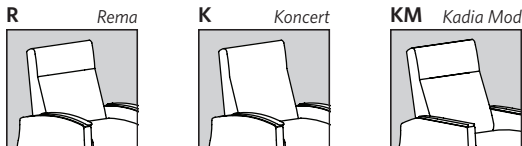

Single Fold Down Arm  
(Koncert style pictured)

## Functional Style *(Aesthetic style code precedes selected model number below, e.g., KC7X67)*

### C7X67 Exam Lift Recliner - Infinite Position Locking Back - Single Fold Down Arm

COM	Dillon/Carson	A <sub>5</sub>	B <sub>6</sub>	C <sub>7</sub>	D <sub>8</sub>	E <sub>9</sub>	F <sub>10</sub>	G <sub>11</sub>	H <sub>12</sub>	I <sub>13</sub>
14,789	15,009	15,269	15,479	15,709	15,849	16,059	16,259	16,509	16,739	17,109

## Standard Features

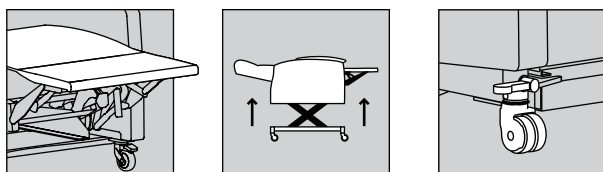

Chaise Continuous Leg Support

Raise to Exam Height via Non-Handed Foot Pedals

3" Dual Wheel Central Locking Caster System

**NOTE:** Transfer arm standard on right side (facing). If specified on left side, handle will be placed on right side and vice versa.

## Dimensions

	Overall			Seat			Back H	Arm H	Kick Out Seat D	Recline D	Distance from Wall
	W	D	H	W	D	H					
RC7X67   KC7X67	34.5	40.5	48.5	24	21	23.5	26	28	40	73	20
KMC7X67	34.5	40.5	48.5	24	21	23.5	26	28	40	73	20

### General Info

COM: 5.5 yds  
Static Wt Cap: 650 lb  
Dynamic Wt Cap: 500 lb  
Unit Weight: 263 lb

## Available Options

ARM CAP OPTIONS		See pg 2 for finishes	PATIENT WELLNESS & COMFORT OPTIONS	
U	Urethane	Standard	ABP	Adjustable Back Pad (COM 1.75 yds)
J1	Solid Surface - Group 1	619		Textile Grades COM-B 459
J2	Solid Surface - Group 2	819		Textile Grades C-I 569
<b>CASTER OPTIONS</b>			AHP	Adjustable Head Rest Pillow (COM 1 yd) 339
Z-Q3	3" - Dual Wheel Central Locking System	Standard	DP	Dual IV Poles & Brackets <sup>1</sup> 498
Z-Q4	4" - Central Locking System	No Charge	FBH	Foley Bag Holder 89
	<i>Increases seat height by 1".</i>		IV	IV Pole & Bracket <sup>1</sup> 249
Z-Q5	5" - Central Locking System	119	LC	LiquiCell 229
	<i>Increases seat height by 2".</i>		LCKFR	Orthopedic Locking Footrest Standard
<b>HEAT/MESSAGE OPTIONS (IEC 60601-1 CERTIFIED)</b>			MBB	Moisture Barrier (Back) 59
	<i>Wand Controls</i>		MBS	Moisture Barrier (Seat) 59
HW	Heat	1139	MR67	Monitor Arm, on Fold Down Arm <sup>1,2</sup> 899
HMW	Heat & Massage	1369	MTR67	Monitor Arm with Tray, on Fold Down Arm <sup>1,2</sup> 999
	<i>In-Arm Controls</i>		PR1	Paper Roll Holder <sup>3</sup> 229
H	Heat	849	TE	Trendelenburg Standard
HM	Heat & Massage	1119	USB	USB Power Outlet (IEC 60601-1 Certified) 459
			WR	Wrist Restraint Mounts (pair) 229
<b>ADDITIONAL FEATURES &amp; OPTIONS</b>			<b>TRAY TABLE OPTIONS</b>	
BBU	Battery Back Up	649	TSL1	Adjustable (Left) Side Tray, on Stationary Arm <sup>1,5</sup> 399
PB	Push Bar	Standard	TSR167	Adjustable (Right) Side Tray, on Fold Down Arm <sup>1,5</sup> 449
EG	Protective Edge Guard	Standard	<b>FOLD DOWN TRANSFER ARM SPECIFIC</b>	
QR	Additional Quick Release Accessory Bracket	69	HC	Hinge Cover Standard
Z	Multi Cover	Use Pricing for Highest Grade	*Refer to pg 130 for full option details and images*	

<sup>1</sup>Includes QR bracket connection installed on recliner

<sup>2</sup>Standard on right side (facing). Replace "R" with "L" for left side (facing) option where available.

<sup>3</sup>Takes place of Push Bar. Paper sold separately.

<sup>4</sup>Contact customer service for solid surface pricing

<sup>5</sup>Over the lap tray function recommended in seated position.



# DURABLE® EXAM LIFT SERIES

# Exam Lift Healthcare Recliner | Patient Transfer

## Select Aesthetic Style *(Denotes back & arm design)*

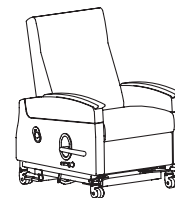
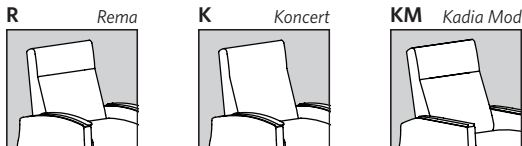

Dual Fold Down Arms  
(Koncert style pictured)

## Functional Style *(Aesthetic style code precedes selected model number below, e.g., KC7X67)*

### C7X62 Exam Lift Recliner - Infinite Position Locking Back - Dual Fold Down Arms

COM	Dillon/Carson	A <sub>5</sub>	B <sub>6</sub>	C <sub>7</sub>	D <sub>8</sub>	E <sub>9</sub>	F <sub>10</sub>	G <sub>11</sub>	H <sub>12</sub>	I <sub>13</sub>
15,059	15,329	15,499	15,709	15,939	16,159	16,389	16,619	16,989	17,279	17,629

## Standard Features

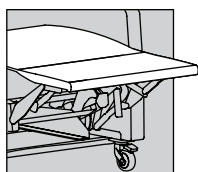

Chaise Continuous Leg Support

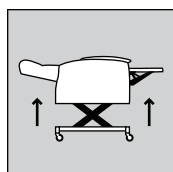

Raise to Exam Height via Non-Handed Foot Pedals

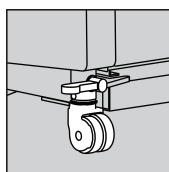

3" Dual Wheel Central Locking Caster System

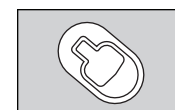

Locking Back Lever  
(located on outside arm on applicable models)

## Dimensions

	Overall			Seat			Back H	Arm H	Kick Out Seat D	Recline D	Distance from Wall
	W	D	H	W	D	H					
RC7X62   KC7X62	34.5	40.5	48.5	24	21	23.5	26	28	40	73	20
KMC7X62	34.5	40.5	48.5	24	21	23.5	26	28	40	73	20

### General Info

COM:	5.8 yds
Static Wt Cap:	650 lb
Dynamic Wt Cap:	500 lb
Unit Weight:	263 lb

## Available Options

### ARM CAP OPTIONS

See pg 2 for finishes

U	Urethane	Standard
J1	Solid Surface - Group 1	619
J2	Solid Surface - Group 2	819

### CASTER OPTIONS

Z-Q3	3" - Dual Wheel Central Locking System	Standard
Z-Q4	4" - Central Locking System <i>Increases seat height by 1".</i>	No Charge
Z-Q5	5" - Central Locking System <i>Increases seat height by 2".</i>	119

### HEAT/MASSAGE OPTIONS (IEC 60601-1 CERTIFIED)

<i>Wand Controls</i>		
HW	Heat	1139
HMW	Heat & Massage	1369

### ADDITIONAL FEATURES & OPTIONS

BBU	Battery Back Up	649
PB	Push Bar	Standard
EG	Protective Edge Guard	Standard
QR	Additional Quick Release Accessory Bracket	69
Z	Multi Cover	Use Pricing for Highest Grade

### PATIENT WELLNESS & COMFORT OPTIONS

ABP	Adjustable Back Pad (COM 1.75 yds)	
	Textile Grades COM-B	459
	Textile Grades C-I	569
AHP	Adjustable Head Rest Pillow (COM 1 yd)	339
DP	Dual IV Poles & Brackets <sup>1</sup>	498
FBH	Foley Bag Holder	89
IV	IV Pole & Bracket <sup>1</sup>	249
LC	LiquiCell	229
LCKFR	Orthopedic Locking Footrest	Standard
MBB	Moisture Barrier (Back)	59
MBS	Moisture Barrier (Seat)	59
MR67	Monitor Arm, on Fold Down Arm <sup>1,2</sup>	899
MTR67	Monitor Arm with Tray, on Fold Down Arm <sup>1,2</sup>	999
PR1	Paper Roll Holder <sup>3</sup>	229
TE	Trendelenburg	Standard
USB	USB Power Outlet (IEC 60601-1 Certified)	459
WR	Wrist Restraint Mounts (pair)	229

### TRAY TABLE OPTIONS

TD362	Dual Adjustable Side Trays, on Fold Down Arms <sup>1,5</sup>	898
TSR167	Adjustable (Right) Side Tray, on Fold Down Arm <sup>1,5</sup>	449
TSL167	Adjustable (Left) Side Tray, on Fold Down Arm <sup>1,5</sup>	449

### FOLD DOWN TRANSFER ARM SPECIFIC

HC	Hinge Cover	Standard
----	-------------	----------

*\*Refer to pg 130 for full option details and images\**

<sup>1</sup>Includes QR bracket connection installed on recliner

<sup>2</sup>Standard on right side (facing). Replace "R" with "L" for left side (facing) option where available.

<sup>3</sup>Takes place of Push Bar. Paper sold separately.

<sup>4</sup>Contact customer service for solid surface pricing

<sup>5</sup>Over the lap tray function recommended in seated position.

# SLEEP SERIES

Sleep Chairs	183
Sofa & Bench	
Oxley Sleep Sofa	187
Oxley Sleep Bench	189
Max Sleep Sofa	190
Kenzley Sleep Sofa	194
EZ Rest	198





**General Product Information**

- 600 lb Single / 1,000 Dual Chair Weight Capacity
- Three positions: Chair, Chaise, Sleep
- Single & dual chair options
- Standard with 3" dual wheel casters
- Heavy duty steel pull-out bed mechanism
- Easy to open and close
- Field replaceable components
- Sinuous spring seats

**To Order, Specify**

- Model Number
- Textile
- Finish
- Options

**Available Options**

**ARM CAP OPTIONS** *See pg 2 for finishes*

U	Urethane	209
J1	Solid Surface - Group 1	619
J2	Solid Surface - Group 2	819
F	Fully Upholstered Arms	Standard

**ADDITIONAL FEATURES & OPTIONS**

CASTER	3" Dual Wheel Swivel Locking Casters	Standard
WF	Wood Legs	279
CAL	CAL TB133	See pg 9
Z	Multi Cover	Use Pricing for Highest Grade
MB	Moisture Barrier	See pg 11



*Chair Position*

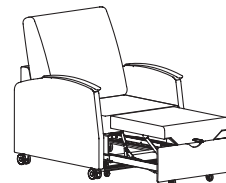

*Chaise Lounge Position*

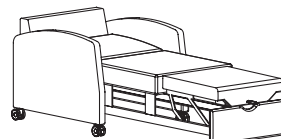

*Sleep Position*

# SLEEP SERIES

# Sleep Chair | EV Style

## E0740 - EV 32" Sleep Chair

### Dimensions

Overall			Seat		
W	D**	H	W	D	H
31.25	36	42	27	22	20
Sleep W	Sleep D	Back H	Arm H		
27	75.25	21	27		

COM: 8.6 yds  
 Wt Cap: 600 lb  
 Unit Weight: 176 lb

\*\*Total Depth is 80" when sleep surface fully extended

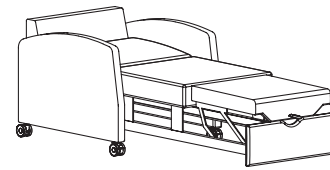

### Pricing

COM	Dillon/Carson	A <sub>5</sub>	B <sub>6</sub>	C <sub>7</sub>	D <sub>8</sub>	E <sub>9</sub>	F <sub>10</sub>	G <sub>11</sub>	H <sub>12</sub>	I <sub>13</sub>
4,809	4,859	5,019	5,269	5,549	5,789	6,139	6,639	7,169	7,749	8,319

## E0840 - EV 36" Sleep Chair

### Dimensions

Overall			Seat		
W	D**	H	W	D	H
35.25	36	42	30.5	22	20
Sleep W	Sleep D	Back H	Arm H		
30.5	75.25	21	27		

COM: 10 yds  
 Wt Cap: 600 lb  
 Unit Weight: 181 lb

\*\*Total Depth is 80" when sleep surface fully extended

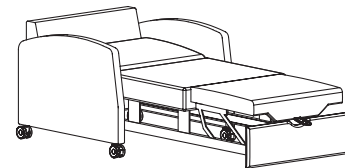

### Pricing

COM	Dillon/Carson	A <sub>5</sub>	B <sub>6</sub>	C <sub>7</sub>	D <sub>8</sub>	E <sub>9</sub>	F <sub>10</sub>	G <sub>11</sub>	H <sub>12</sub>	I <sub>13</sub>
4,969	5,159	5,369	5,689	6,039	6,439	6,939	7,419	7,839	8,379	8,889

## E0940 - EV 52" Sleep Chair

### Dimensions

Overall			Seat		
W	D**	H	W	D	H
51.25	36	42	47.25	22	20
Sleep W	Sleep D	Back H	Arm H		
47.25	75.25	21	27		

COM: 10 yds  
 Wt Cap: 600 lb  
 Unit Weight: 252 lb

\*\*Total Depth is 80" when sleep surface fully extended

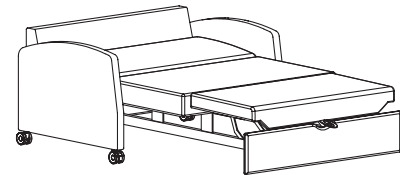

### Pricing

COM	Dillon/Carson	A <sub>5</sub>	B <sub>6</sub>	C <sub>7</sub>	D <sub>8</sub>	E <sub>9</sub>	F <sub>10</sub>	G <sub>11</sub>	H <sub>12</sub>	I <sub>13</sub>
6,109	6,399	6,599	6,949	7,219	7,569	7,979	8,539	8,869	9,449	9,899

## E0742 - EV Dual Sleep Chair

### Dimensions

Overall			Seat		
W	D**	H	W*	D	H
59	36	42	27	22	20
Sleep W*	Sleep D	Back H	Arm H		
27	75.25	21	27		

COM: 13.9 yds  
 Wt Cap: 1000 lb  
 Unit Weight: 290 lb

\*Sleep Width & Seat Width are per side  
 \*\*Total Depth is 80" when sleep surface fully extended

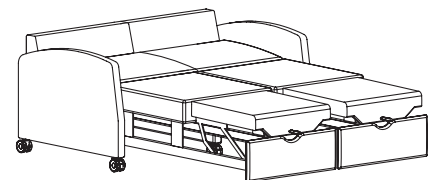

### Pricing

COM	Dillon/Carson	A <sub>5</sub>	B <sub>6</sub>	C <sub>7</sub>	D <sub>8</sub>	E <sub>9</sub>	F <sub>10</sub>	G <sub>11</sub>	H <sub>12</sub>	I <sub>13</sub>
9,219	9,769	10,189	10,589	10,999	11,669	12,349	13,029	14,239	15,339	16,549

### Available Options

ARM CAP OPTIONS		See pg 2 for finishes
U	Urethane	209
J1	Solid Surface - Group 1	619
J2	Solid Surface - Group 2	819
F	Fully Upholstered Arms	Standard

ADDITIONAL FEATURES & OPTIONS		
CASTER	3" Dual Wheel Swivel Locking Casters	Standard
WF	Wood Legs	279
CAL	CAL TB133	See pg 9
Z	Multi Cover	Use Pricing for Highest Grade
MB	Moisture Barrier	See pg 11

# SLEEP SERIES

# Sleep Chair | Rema Style

## R1740 - Rema 33" Sleep Chair

### Dimensions

Overall			Seat		
W	D**	H	W	D	H
32.25	36	42	27	22	20
Sleep W	Sleep D	Back H	Arm H		
27	75.25	21	27		

COM: 8.6 yds  
 Wt Cap: 600 lb  
 Unit Weight: 176 lb

\*\*Total Depth is 80" when sleep surface fully extended

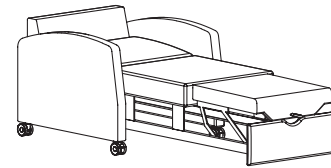

### Pricing

COM	Dillon/Carson	A <sub>5</sub>	B <sub>6</sub>	C <sub>7</sub>	D <sub>8</sub>	E <sub>9</sub>	F <sub>10</sub>	G <sub>11</sub>	H <sub>12</sub>	I <sub>13</sub>
4,809	4,859	5,019	5,269	5,549	5,789	6,139	6,639	7,169	7,749	8,319

## R1840 - Rema 37" Sleep Chair

### Dimensions

Overall			Seat		
W	D**	H	W	D	H
36.25	36	42	30.5	22	20
Sleep W	Sleep D	Back H	Arm H		
30.5	75.25	21	27		

COM: 10 yds  
 Wt Cap: 600 lb  
 Unit Weight: 181 lb

\*\*Total Depth is 80" when sleep surface fully extended

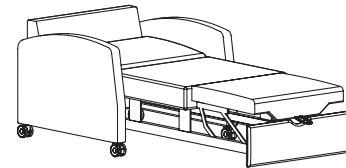

### Pricing

COM	Dillon/Carson	A <sub>5</sub>	B <sub>6</sub>	C <sub>7</sub>	D <sub>8</sub>	E <sub>9</sub>	F <sub>10</sub>	G <sub>11</sub>	H <sub>12</sub>	I <sub>13</sub>
4,969	5,159	5,369	5,689	6,039	6,439	6,939	7,419	7,839	8,379	8,889

## R1940 - Rema 53" Sleep Chair

### Dimensions

Overall			Seat		
W	D**	H	W	D	H
52.25	36	42	47.25	22	20
Sleep W	Sleep D	Back H	Arm H		
47.25	75.25	21	27		

COM: 10.1 yds  
 Wt Cap: 600 lb  
 Unit Weight: 252 lb

\*\*Total Depth is 80" when sleep surface fully extended

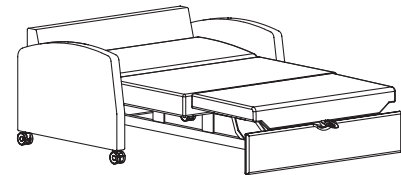

### Pricing

COM	Dillon/Carson	A <sub>5</sub>	B <sub>6</sub>	C <sub>7</sub>	D <sub>8</sub>	E <sub>9</sub>	F <sub>10</sub>	G <sub>11</sub>	H <sub>12</sub>	I <sub>13</sub>
6,109	6,399	6,599	6,949	7,219	7,569	7,979	8,539	8,869	9,449	9,899

## R1742 - Rema Dual Sleep Chair

### Dimensions

Overall			Seat		
W	D**	H	W*	D	H
60	36	42	27	22	20
Sleep W*	Sleep D	Back H	Arm H		
27	75.25	21	27		

COM: 13.9 yds  
 Wt Cap: 1000 lb  
 Unit Weight: 290 lb

\*Sleep Width & Seat Width are per side  
 \*\*Total Depth is 80" when sleep surface fully extended

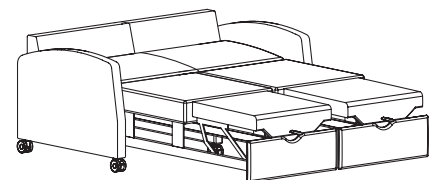

### Pricing

COM	Dillon/Carson	A <sub>5</sub>	B <sub>6</sub>	C <sub>7</sub>	D <sub>8</sub>	E <sub>9</sub>	F <sub>10</sub>	G <sub>11</sub>	H <sub>12</sub>	I <sub>13</sub>
9,219	9,769	10,189	10,589	10,999	11,669	12,349	13,029	14,239	15,339	16,549

### Available Options

ARM CAP OPTIONS		See pg 2 for finishes
U	Urethane	209
J1	Solid Surface - Group 1	619
J2	Solid Surface - Group 2	819
F	Fully Upholstered Arms	Standard

ADDITIONAL FEATURES & OPTIONS		
CASTER	3" Dual Wheel Swivel Locking Casters	Standard
WF	Wood Legs	279
CAL	CAL TB133	See pg 9
Z	Multi Cover	Use Pricing for Highest Grade
MB	Moisture Barrier	See pg 11

# SLEEP SERIES

# Sleep Chair | Kadia Mod Style

## KM1740 - Kadia Mod 33" Sleep Chair

### Dimensions

Overall			Seat		
W	D**	H	W	D	H
32.25	36	42	27	22	20
Sleep W	Sleep D	Back H	Arm H		
27	75.25	21	26.5		

COM: 8.6 yds  
 Wt Cap: 600 lb  
 Unit Weight: 176 lb

\*\*Total Depth is 80" when sleep surface fully extended

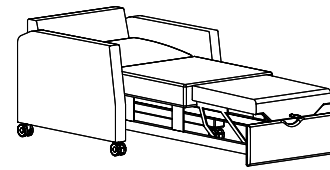

### Pricing

COM	Dillon/Carson	A <sub>5</sub>	B <sub>6</sub>	C <sub>7</sub>	D <sub>8</sub>	E <sub>9</sub>	F <sub>10</sub>	G <sub>11</sub>	H <sub>12</sub>	I <sub>13</sub>
4,809	4,859	5,019	5,269	5,549	5,789	6,139	6,639	7,169	7,749	8,319

## KM1840 - Kadia Mod 37" Sleep Chair

### Dimensions

Overall			Seat		
W	D**	H	W	D	H
36.25	36	42	30.5	22	20
Sleep W	Sleep D	Back H	Arm H		
30.5	75.25	21	26.5		

COM: 10 yds  
 Wt Cap: 600 lb  
 Unit Weight: 181 lb

\*\*Total Depth is 80" when sleep surface fully extended

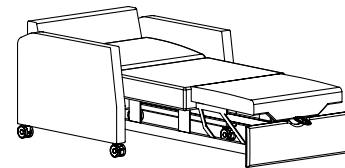

### Pricing

COM	Dillon/Carson	A <sub>5</sub>	B <sub>6</sub>	C <sub>7</sub>	D <sub>8</sub>	E <sub>9</sub>	F <sub>10</sub>	G <sub>11</sub>	H <sub>12</sub>	I <sub>13</sub>
4,969	5,159	5,369	5,689	6,039	6,439	6,939	7,419	7,839	8,379	8,889

## KM1940 - Kadia Mod 53" Sleep Chair

### Dimensions

Overall			Seat		
W	D**	H	W	D	H
52.25	36	42	47.25	22	20
Sleep W	Sleep D	Back H	Arm H		
47.25	75.25	21	26.5		

COM: 10.1 yds  
 Wt Cap: 600 lb  
 Unit Weight: 252 lb

\*\*Total Depth is 80" when sleep surface fully extended

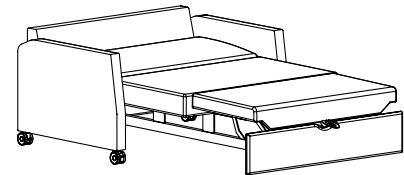

### Pricing

COM	Dillon/Carson	A <sub>5</sub>	B <sub>6</sub>	C <sub>7</sub>	D <sub>8</sub>	E <sub>9</sub>	F <sub>10</sub>	G <sub>11</sub>	H <sub>12</sub>	I <sub>13</sub>
6,109	6,399	6,599	6,949	7,219	7,569	7,979	8,539	8,869	9,449	9,899

## KM1742 - Kadia Mod Dual Sleep Chair

### Dimensions

Overall			Seat		
W	D**	H	W*	D	H
60	36	42	27	22	20
Sleep W*	Sleep D	Back H	Arm H		
27	75.25	21	26.5		

COM: 13.9 yds  
 Wt Cap: 1000 lb  
 Unit Weight: 290 lb

\*Sleep Width & Seat Width are per side  
 \*\*Total Depth is 80" when sleep surface fully extended

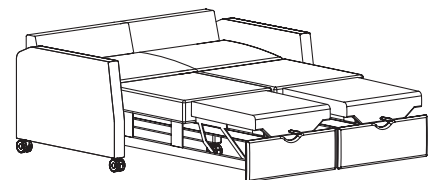

### Pricing

COM	Dillon/Carson	A <sub>5</sub>	B <sub>6</sub>	C <sub>7</sub>	D <sub>8</sub>	E <sub>9</sub>	F <sub>10</sub>	G <sub>11</sub>	H <sub>12</sub>	I <sub>13</sub>
9,219	9,769	10,189	10,589	10,999	11,669	12,349	13,029	14,239	15,339	16,549

### Available Options

ARM CAP OPTIONS		See pg 2 for finishes
U	Urethane	209
J1	Solid Surface - Group 1	619
J2	Solid Surface - Group 2	819
F	Fully Upholstered Arms	Standard

ADDITIONAL FEATURES & OPTIONS		
CASTER	3" Dual Wheel Swivel Locking Casters	Standard
WF	Wood Legs	279
CAL	CAL TB133	See pg 9
Z	Multi Cover	Use Pricing for Highest Grade
MB	Moisture Barrier	See pg 11



**General Product Information**

- 1,000 lb Weight Capacity
- Sofa and bench styles available
- Front panel pulls out and seat folds over to reveal sleep surface
- Standard with 3" dual wheel casters
- Separate seat and sleep surfaces
- Blue sleep surface material is anti-microbial, bleach cleanable, and moisture resistant
- 24" needed in front of unit to pull out sleep extension

**To Order, Specify**

- Model Number
- Textile
- Finish
- Options

**Available Options**

**ARM CAP OPTIONS**

*See pg 2 for finishes*

		OO Model	OW Model
U	Urethane	209	259
J1	Solid Surface - Group 1	619	1239
J2	Solid Surface - Group 2	819	1439
T	Thermofoil	139	229
F	Fully Upholstered Arms	Standard	Standard

**POWER OPTIONS**

POWER	Hospital Grade Power	569
-------	----------------------	-----

(USB-A/USB-C/120 V Outlet)

\*Available on OW2176UF only.

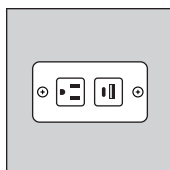

**ADDITIONAL FEATURES & OPTIONS**

CASTER	3" Dual Wheel Swivel Locking Casters	Standard
CAL	CAL TB133	See pg 9
Z	Multi Cover	Use Pricing for Highest Grade
MB	Moisture Barrier	See pg 11

# SLEEP SERIES

# Oxley | Sleep Sofa

## ON2176UF - Oxley Pullout Sleep Sofa - Armless

### Dimensions

Overall			Seat		
W	D**	H	W	D	H
76	31	36	76	20	20.5
Sleep W	Sleep D	Back H	Arm H		
75	45	15.5	n/a		

COM: 7.6 yds  
 Wt Cap: 1000 lb  
 Unit Weight: 207 lb

\*\*Total Depth is 53" when sleep surface pulled out

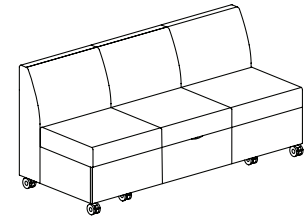

### Pricing

COM	Dillon/Carson	A <sub>5</sub>	B <sub>6</sub>	C <sub>7</sub>	D <sub>8</sub>	E <sub>9</sub>	F <sub>10</sub>	G <sub>11</sub>	H <sub>12</sub>	I <sub>13</sub>
6,669	6,709	7,219	7,499	7,659	7,749	8,309	8,779	9,199	9,629	9,979

## OO2176UF - Oxley Pullout Sleep Sofa - 3.5" Wide Square Arms

### Dimensions

Overall			Seat		
W	D**	H	W	D	H
82	31	36	76	22	20.5
Sleep W	Sleep D	Back H	Arm H		
75	45	15.5	27.75		

COM: 10 yds  
 Wt Cap: 1000 lb  
 Unit Weight: 264 lb

\*\*Total Depth is 53" when sleep surface pulled out

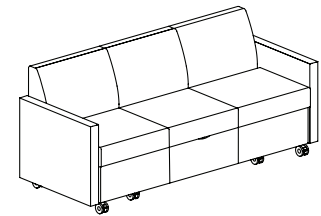

### Pricing

COM	Dillon/Carson	A <sub>5</sub>	B <sub>6</sub>	C <sub>7</sub>	D <sub>8</sub>	E <sub>9</sub>	F <sub>10</sub>	G <sub>11</sub>	H <sub>12</sub>	I <sub>13</sub>
7,349	7,499	7,739	8,189	8,509	8,949	9,349	9,929	10,459	10,959	11,459

## OW2176UF - Oxley Pullout Sleep Sofa - 5" Wide Square Arms

### Dimensions

Overall			Seat		
W	D**	H	W	D	H
85.5	31	36	76	22	20.5
Sleep W	Sleep D	Back H	Arm H		
74	45	15.5	21.75		

COM: 10.1 yds  
 Wt Cap: 1000 lb  
 Unit Weight: 265 lb

\*\*Total Depth is 53" when sleep surface pulled out

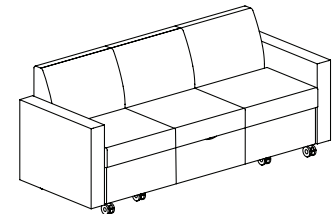

### Pricing

COM	Dillon/Carson	A <sub>5</sub>	B <sub>6</sub>	C <sub>7</sub>	D <sub>8</sub>	E <sub>9</sub>	F <sub>10</sub>	G <sub>11</sub>	H <sub>12</sub>	I <sub>13</sub>
7,349	7,499	7,739	8,189	8,509	8,949	9,349	9,929	10,459	10,959	11,459

## OC2176UF - Oxley Pullout Sleep Sofa - Lounge Arms

### Dimensions

Overall			Seat		
W	D**	H	W	D	H
91	31	36	76	22	20.5
Sleep W	Sleep D	Back H	Arm H		
74	45	15.5	36		

COM: 10.7 yds  
 Wt Cap: 1000 lb  
 Unit Weight: 268 lb

\*Solid textile pattern must be used on back & arms.

\*\*Total Depth is 53" when sleep surface pulled out

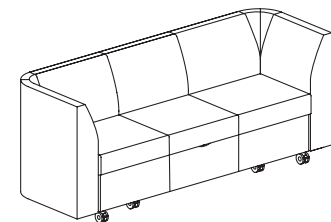

### Pricing

COM	Dillon/Carson	A <sub>5</sub>	B <sub>6</sub>	C <sub>7</sub>	D <sub>8</sub>	E <sub>9</sub>	F <sub>10</sub>	G <sub>11</sub>	H <sub>12</sub>	I <sub>13</sub>
7,889	8,469	8,739	8,929	9,289	9,669	9,989	10,429	10,849	11,589	12,229

### Available Options

#### ARM CAP OPTIONS

See pg 2 for finishes

	OO Model	OW Model
U Urethane	209	259
J1 Solid Surface - Group 1	619	1239
J2 Solid Surface - Group 2	819	1439
T Thermofoil	139	229
F Fully Upholstered Arms	Standard	Standard

#### ADDITIONAL FEATURES & OPTIONS

CASTER	3" Dual Wheel Swivel Locking Casters	Standard
POWER	Hospital Grade Power Outlet <sup>1</sup>	569
CAL	CAL TB133	See pg 9
Z	Multi Cover	Use Pricing for Highest Grade
MB	Moisture Barrier	See pg 11

<sup>1</sup>Available on OW2176UF only. (2) USB Ports, (1) 120 V Power Outlet

# SLEEP SERIES

# Oxley | Sleep Bench

## ON2076UF - Oxley Pullout Sleep Bench

### Dimensions

Overall			Seat		
W	D**	H	W	D	H
76	24	24.625	76	20	20.5
Sleep W	Sleep D	Back H	Arm H		
75	39.5	3	n/a		

COM: 6 yds  
 Wt Cap: 1000 lb  
 Unit Weight: 181 lb

\*\*Total Depth is 43" when sleep surface pulled out

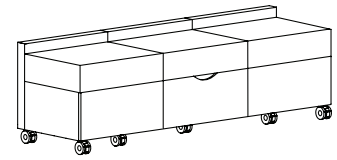

### Pricing

COM	Dillon/Carson	A <sub>5</sub>	B <sub>6</sub>	C <sub>7</sub>	D <sub>8</sub>	E <sub>9</sub>	F <sub>10</sub>	G <sub>11</sub>	H <sub>12</sub>	I <sub>13</sub>
5,189	5,209	5,339	5,429	5,619	5,829	6,039	6,269	6,509	6,869	7,229

## ON2076HPUF - Oxley High Back Pullout Sleep Bench with Back Pad

### Dimensions

Overall			Seat		
W	D**	H	W	D	H
76	24	36	76	20	20.5
Sleep W	Sleep D	Back H	Arm H		
75	39.5	15.5	n/a		

COM: 8 yds  
 Wt Cap: 1000 lb  
 Unit Weight: 207 lb

\*\*Total Depth is 43" when sleep surface pulled out

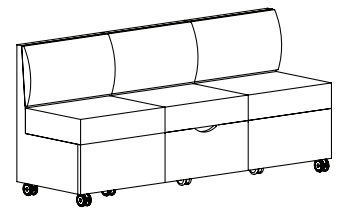

### Pricing

COM	Dillon/Carson	A <sub>5</sub>	B <sub>6</sub>	C <sub>7</sub>	D <sub>8</sub>	E <sub>9</sub>	F <sub>10</sub>	G <sub>11</sub>	H <sub>12</sub>	I <sub>13</sub>
6,939	6,979	7,069	7,229	7,499	7,689	7,879	8,209	8,329	8,909	9,349

## Available Options

### ADDITIONAL FEATURES & OPTIONS

CASTER	3" Dual Wheel Swivel Locking Casters	Standard
CAL	CAL TB133	See pg 9
Z	Multi Cover	Use Pricing for Highest Grade
MB	Moisture Barrier	See pg 11



**General Product Information**

- 1,000 lb Weight Capacity
- Back cushion folds down to reveal sleep surface
- Customizable with recliner footrests, drawers, tables, and more
- Separate seat and sleep surfaces
- Blue sleep surface material is anti-microbial, bleach cleanable, and moisture resistant
- Size footprint remains same when converted to sleep position
- Standard with wood legs

**To Specify, See Product Builder on Following Pages**

**Visual Option Guide**

This page illustrates the choices available to customize the Max Sleep Sofa to your specific needs. The following pages include pricing and a table to guide you in building a product model number based on your selected specifications.

The Max Sleep Sofa is available in two (2) standard seat widths: 78" and 70".

**ARM STYLES**

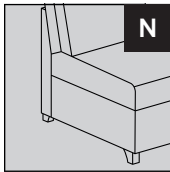

Armless

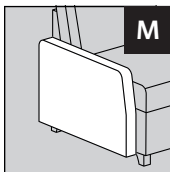

3" Arm

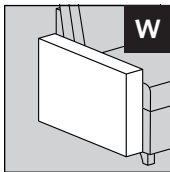

5" Arm

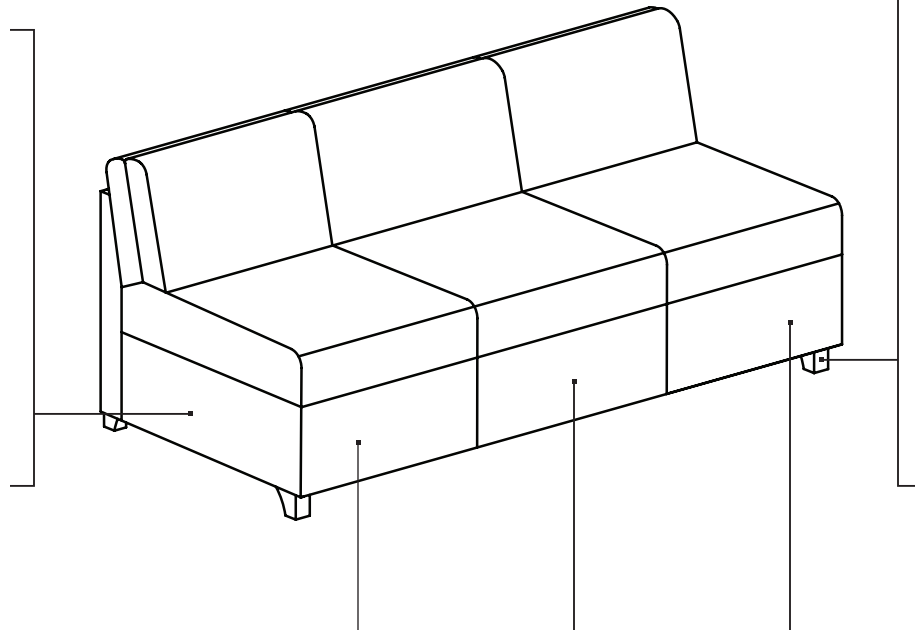

**LEG OPTIONS**

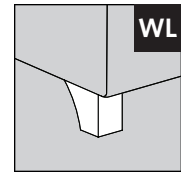

Wood Legs

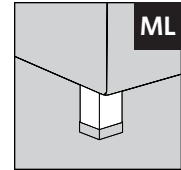

Metal Legs

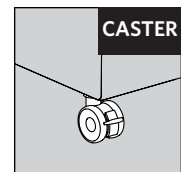

3" Swivel Locking Casters

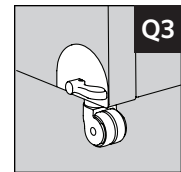

3" Central Locking Caster System

**ARM CAPS**

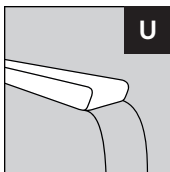

Urethane

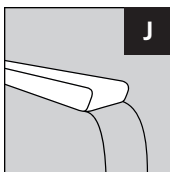

Solid Surface

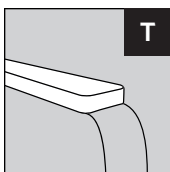

Thermofoil

**POWER**

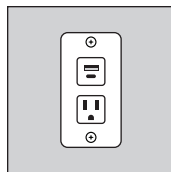

Hospital Grade Power

**LEFT SIDE**

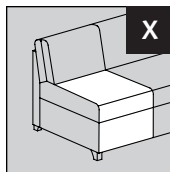

Fixed Front

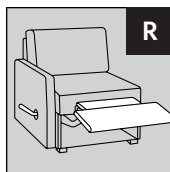

Recliner Leg Rest

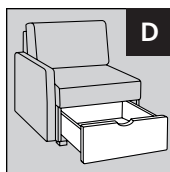

Drawer

**CENTER**

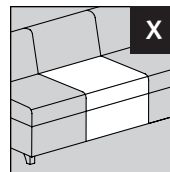

Fixed Front

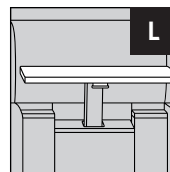

Lift Table

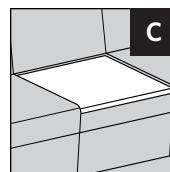

Console Table

**RIGHT SIDE**

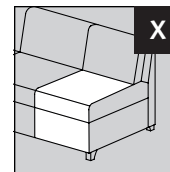

Fixed Front

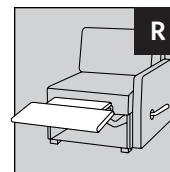

Recliner Leg Rest

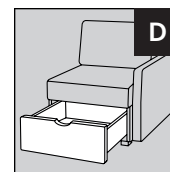

Drawer

**Base Model & Arm Pricing**

Select base pricing below dependent on your selection of 78" seat width (N78XXXUF) or 70" seat width (N70XXXUF), and selected textile grade. If 3" arms or 5" arms are selected, use the chart below to find the upcharge based on textile grade.

Base models are standard with upholstered fixed front, wood legs, and no arms. Selections made on the following page will affect the model number and list price.

**N78XXXUF - 78" Seat Width Base Sofa**

**Dimensions**

Overall			Seat		
W	D	H	W	D	H
78	35	36	78	22	20.5
Sleep D	Sleep W	Back H	Arm H		
28	Seat W + Arms	15	n/a		

COM: 8 yds\*  
Wt Cap: 1000 lb  
Unit Weight: 175 lb\*\*

\*See table (below right) for additional COM info  
\*\*Weight will vary based on selected options

**Pricing**

COM	Dillon/Carson	A <sub>5</sub>	B <sub>6</sub>	C <sub>7</sub>	D <sub>8</sub>	E <sub>9</sub>	F <sub>10</sub>	G <sub>11</sub>	H <sub>12</sub>	I <sub>13</sub>
5,479	5,539	5,889	6,259	6,619	6,999	7,339	7,629	8,009	8,179	8,699

**Arm Pricing (per pair)**

	3" Arms	5" Arms
COM	279	479
Dillon/Carson	329	519
A <sub>5</sub>	459	629
B <sub>6</sub>	589	779
C <sub>7</sub>	679	839
D <sub>8</sub>	829	1,019
E <sub>9</sub>	879	1,079
F <sub>10</sub>	959	1,129
G <sub>11</sub>	1,069	1,279
H <sub>12</sub>	1,239	1,379
I <sub>13</sub>	1,379	1,509

**N70XXXUF - 70" Seat Width Base Sofa** (Not available with drawer or recliner leg rest options)

**Dimensions**

Overall			Seat		
W	D	H	W	D	H
70	35	36	70	22	20.5
Sleep D	Sleep W	Back H	Arm H		
28	Seat W + Arms	15	n/a		

COM: 7.4 yds\*  
Wt Cap: 1000 lb  
Unit Weight: 173 lb\*\*

\*See table (below right) for additional COM info  
\*\*Weight will vary based on selected options

**Pricing**

COM	Dillon/Carson	A <sub>5</sub>	B <sub>6</sub>	C <sub>7</sub>	D <sub>8</sub>	E <sub>9</sub>	F <sub>10</sub>	G <sub>11</sub>	H <sub>12</sub>	I <sub>13</sub>
5,299	5,379	5,709	6,079	6,439	6,819	7,109	7,399	7,779	8,059	8,469

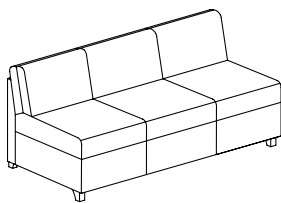

N78XXXUF  
78" Base Sofa

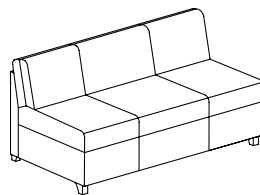

N70XXXUF  
70" Base Sofa

For COM orders, add the below yardage for options selected.

- 3" or 5" Arms (pair): +1.2 yds
- Recliner Leg Rest (each): +0.5 yds
- Drawer (each): +0.5 yds
- Lift or Console Table: +0.6 yds

**Build Model Number by Selecting One Option from Each Column**

Specify any additional options, along with textile/s and finishes. Add associated list prices from your selections below to the base model price on the previous page.

EXAMPLE

**1. Arm Style**

Choose from  
**N or M or W**

**M**

3" Arms

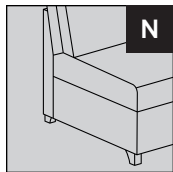

**Armless**

See pricing table on previous page

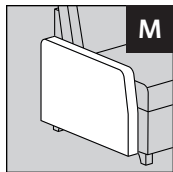

**3" Arm**

See pricing table on previous page

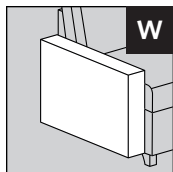

**5" Arm**

See pricing table on previous page

**2. Seat Width**

Choose from  
**78 or 70**

**78**

78" Seat Width

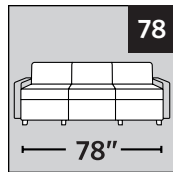

**78" Seat Width**

See base pricing on previous page

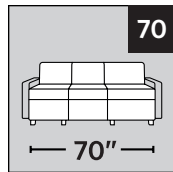

**70" Seat Width**

See base pricing on previous page

**3. Left Side**

Choose from  
**X or R or D**

**R**

Recliner Leg Rest  
(Left side facing)

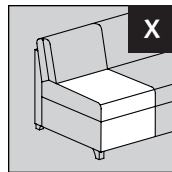

**Fixed Front**

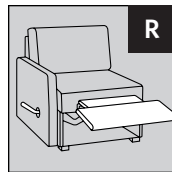

**Recliner Leg Rest**

+649

Available on 78" models with 3" arms only. Choose UF for selection #6 (front style).

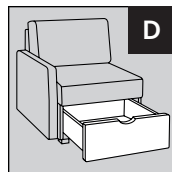

**Drawer**

Upholstered +1129  
Thermofoil +1299

Drawers available on 78" models only.

**4. Center**

Choose from  
**X or L or C**

**L**

Lift Table

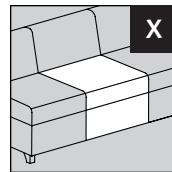

**Fixed Front**

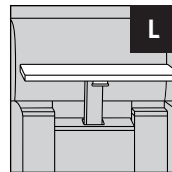

**Lift Table**

Thermofoil +2789

Solid Surface

Group 1 +4019

Group 2 +4219

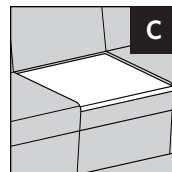

**Console Table**

Thermofoil +819

Solid Surface

Group 1 +2249

Group 2 +2449

**5. Right Side**

Choose from  
**X or R or D**

**R**

Recliner Leg Rest  
(Right side facing)

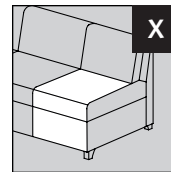

**Fixed Front**

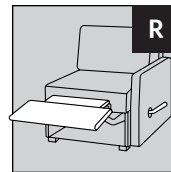

**Recliner Leg Rest**

+649

Available on 78" models with 3" arms only. Choose UF for selection #6 (front style).

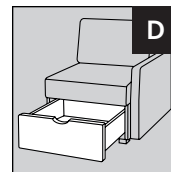

**Drawer**

Upholstered +1129

Thermofoil +1299

Drawers available on 78" models only.

**6. Front Style**

Choose from\*\*  
**UF or LF**

**UF**

Upholstered Front

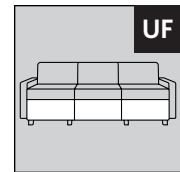

**Upholstered Front**

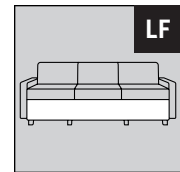

**Thermofoil Front**

Full Front +339  
Single Section +169

\*\*If (D) Drawer option selected, choose from **UD** for Upholstered **LD** for Thermofoil

**Available Options**

**ARM CAP OPTIONS**

See pg 2 for finishes

	3" Arms	5" Arms
U Urethane	209	259
J1 Solid Surface - Group 1	619	1239
J2 Solid Surface - Group 2	819	1439
T Thermofoil	139	229
F Fully Upholstered Arms	Standard	Standard

**CASTER & LEG OPTIONS**

WL Wood Legs	Standard
ML Metal Legs	279
CASTER Q3 3" - Dual Wheel Swivel Locking Casters	199
Q3 3" - Dual Wheel Central Locking Caster System <sup>1</sup>	1019

**ADDITIONAL FEATURES & OPTIONS**

POWER	Hospital Grade Power Outlet <sup>2</sup>	569
CAL	CAL TB133	See pg 9
Z	Multi Cover	Use Pricing for Highest Grade
MB	Moisture Barrier	See pg 11

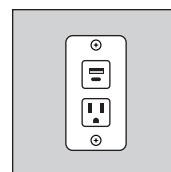

**Power Placement:**

If Lift Table selected-  
left side of inner console

If 5" Arms selected (and no Lift Table)-  
left (facing) arm

If neither 5" Arms or Lift Table selected-  
front center of fixed front

<sup>1</sup>Not available when recliner or drawer selected

<sup>2</sup>(2) USB Ports, (1) 120 V Power Outlet



**General Product Information**

- 900 lb Weight Capacity
- Back cushion folds down to reveal sleep surface
- Clean-out function in both sofa and sleep position for ease of cleaning
- Customizable with multiple seat widths, arm styles/ widths, and leg styles
- Separate seat and sleep surfaces
- Blue sleep surface material is anti-microbial, bleach cleanable, and moisture resistant
- Size footprint remains same when converted to sleep position

**To Specify, See Product Builder on Following Pages**

**Visual Option Guide**

This page illustrates the choices available to customize the Kenzley Sleep Sofa to your specific needs. The following pages include pricing and a table to guide you in building a product model number based on your selected specifications.

The Kenzley Sleep Sofa is available in two (2) standard seat widths: 78" and 70".

**LEG OPTIONS**

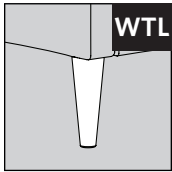

Wood Tapered Leg

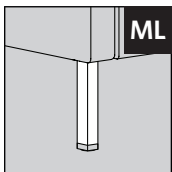

Metal Leg

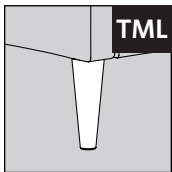

Tapered Metal Leg

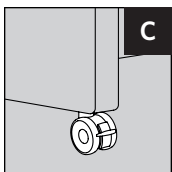

3" Swivel Locking Casters\*

\*Available on 3.5" Wide Caster Arms (Full Height)

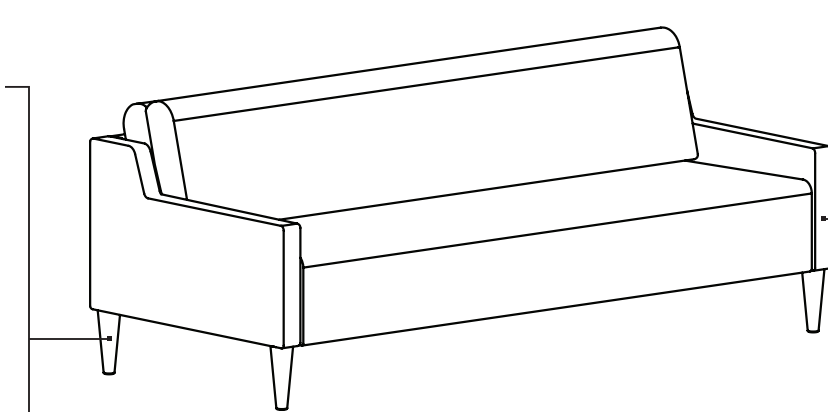

**ARM STYLES**

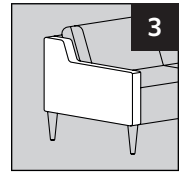

3.5" Wide Arms

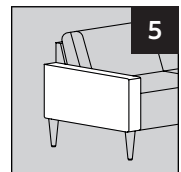

5" Wide Arms

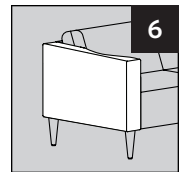

6" Wide Lounge Arms

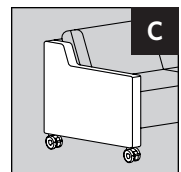

3.5" Wide Caster Arms (Full Height)

**ARM CAPS**

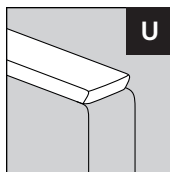

Urethane

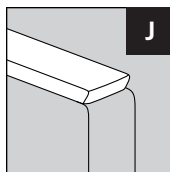

Solid Surface

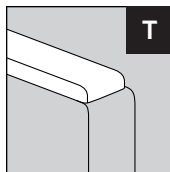

Thermofoil

**POWER**

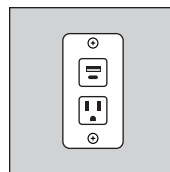

Hospital Grade Power

**Base Model Pricing**

Select base pricing below dependent on your selection of 78" seat width (K7833) or 70" seat width (K7033), and selected textile grade.

Base models are standard with upholstered 3.5" wide arms and wood tapered legs. Selections made on the following page will affect the model number, list price, and dimensions.

**K7833 - 78" Seat Width Base Sofa with 3.5" Arms**

**Dimensions**

Overall			Seat		
W	D	H	W	D	H
84	35.5	32	77	21.5	17.75
Sleep W	Sleep D	Back H	Arm H		
84	28.5	15	24.75		

COM: 9.4 yds
Wt Cap: 900 lb
Unit Weight: 175 lb

\*\*Weight will vary based on selected options

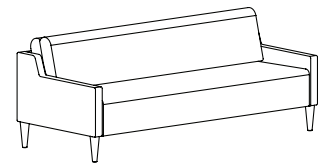

K7833  
78" Base Sofa

**Pricing**

COM	Dillon/Carson	A5	B6	C7	D8	E9	F10	G11	H12	I13
5,989	6,299	6,559	6,859	7,109	7,469	7,669	7,939	8,379	8,739	9,079

**K7033 - 70" Seat Width Base Sofa with 3.5" Arms**

**Dimensions**

Overall			Seat		
W	D	H	W	D	H
76.5	35.5	32	69.5	21.5	17.75
Sleep W	Sleep D	Back H	Arm H		
76.5	28.5	15	24.75		

COM: 9.2 yds
Wt Cap: 900 lb
Unit Weight: 173 lb

\*\*Weight will vary based on selected options

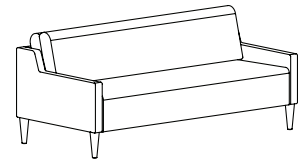

K7033  
70" Base Sofa

**Pricing**

COM	Dillon/Carson	A5	B6	C7	D8	E9	F10	G11	H12	I13
5,829	6,139	6,399	6,689	6,939	7,299	7,509	7,779	8,229	8,589	8,939

For COM orders, add the below yardage for options selected.

Lounge Arms (pair): +0.4 yds  
Caster Arms (each): +0.6 yds

**KZE07R - Right Side Facing Integrated Side Table with Thermofoil Top (for left facing table, use KZE07L)**

**Dimensions**

Overall		
W	D	H
16	34.5	9

Unit Weight: 17.5 lb
----------------------

**Price**  
419

**TABLE LEG OPTIONS**

WTL	Wood Tapered Legs	Standard
ML	Metal Legs	149
TML	Tapered Metal Legs (Silver Frost finish <sup>1</sup> )	449

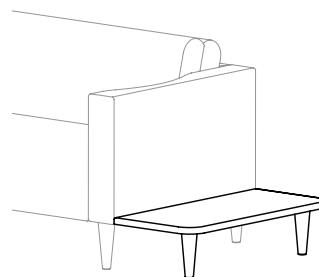

KZE07R  
Right Facing Integrated Table  
(for left facing table, use KZE07L)

<sup>1</sup>Additional metal finishes are available. Contact customer service for a quote.

**Build Model Number by Selecting One Option from Each Column**

Specify any additional options, along with textile/s and finishes. Add associated list prices from your selections below to the base model price on the previous page.

EXAMPLE

**1. Family**

All Kenzley models begin with **K**

**K**

Kenzley

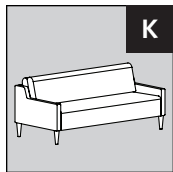

Kenzley

**2. Seat Width**

Choose from **78** or **70**

**78**

78" Seat Width

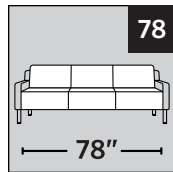

**78" Seat Width**  
See base pricing on previous page

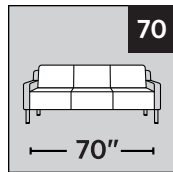

**70" Seat Width**  
See base pricing on previous page

**3. Left Arm**

Choose from **3** or **5** or **6**

**3**

3.5" Wide Arm

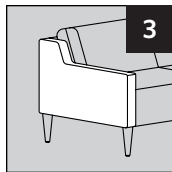

3.5" Wide Arm

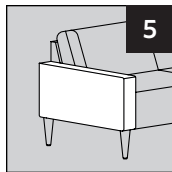

**5" Wide Arm**  
Single Arm +100

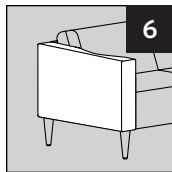

**Lounge Arm (6")<sup>4</sup>**  
Single Arm +250

**4. Right Arm**

Choose from **3** or **5** or **6**

**3**

3.5" Wide Arm

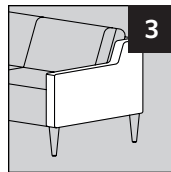

3.5" Wide Arm

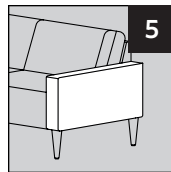

**5" Wide Arm**  
Single Arm +100

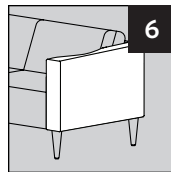

**Lounge Arm (6")<sup>4</sup>**  
Single Arm +250

**5. Casters**

Optional **C**

**C**

Casters

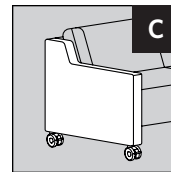

**Caster Arms**  
+369

Must select 3.5" Wide Arm on left and right side. Arms with casters are full height.

**Available Options**

**ARM CAP OPTIONS<sup>3</sup>**

See pg 2 for finishes

	3.5" Arms	5" Arms
U Urethane	209	259
J1 Solid Surface - Group 1	619	1239
J2 Solid Surface - Group 2	819	1439
T Thermofoil	139	229
F Fully Upholstered Arms	Standard	Standard

**LEG OPTIONS**

	Standard
WTL Wood Tapered Legs	Standard
ML Metal Legs	279
TML Tapered Metal Legs (Silver Frost finish <sup>1</sup> )	949
C Casters (See table above for availability)	369

**ADDITIONAL FEATURES & OPTIONS**

POWER	Hospital Grade Power Outlet <sup>2</sup>	569
CAL	CAL TB133	See pg 9
Z	Multi Cover	Use Pricing for Highest Grade
MB	Moisture Barrier	See pg 11

**Power Placement:**

If 3.5" Left Arm selected- front of raised back arm

If 5" or 6" Left Arm selected- front of left (facing) arm

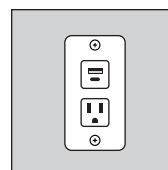

<sup>1</sup>Additional metal finishes are available. Contact customer service for a quote.

<sup>2</sup>(2) USB Ports, (1) 120 V Power Outlet

<sup>3</sup>Arm caps not available on Lounge style arms

<sup>4</sup>Due to arm contour, textiles with 2-way repeat will not match on lounge arm



**General Product Information**

- 900 lb Weight Capacity
- Seat cushion pulls out to convert to sleep space
- Dual locking caster system secures unit in place
- Customizable with multiple seat widths and arm styles
- Clean-out openings where seat meets back and arms
- Elevated sleep surface opens area beneath seat for storage and easy cleaning
- Field replaceable components

**To Specify, See Product Builder on Following Pages**

**Visual Option Guide**

This page illustrates the choices available to customize the EZ Rest Sleep Sofa to your specific needs. The following pages include pricing and a table to guide you in building a product model number based on your selected specifications.

The EZ Rest Sleep Sofa is available in two (2) standard seat widths: 76" and 68".

**POWER**

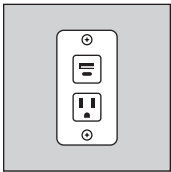

Hospital Grade Power

**ARM STYLES**

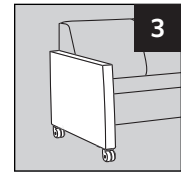

3.5" Wide Arms

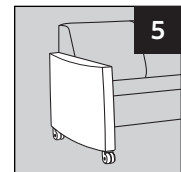

5.5" Barrel Arms

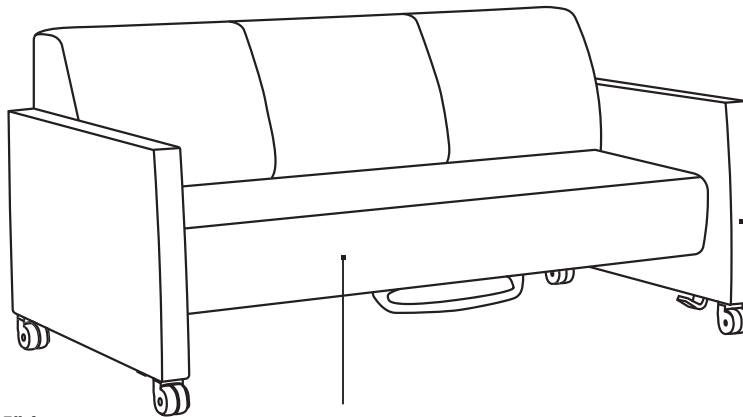

**ARM CAPS**

on 5.5" Barrel Arms

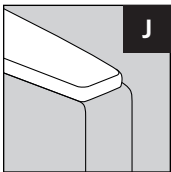

Solid Surface

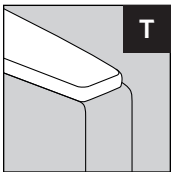

Thermofoil

on 3.5" Arms

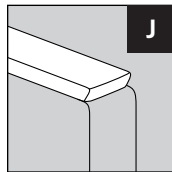

Solid Surface

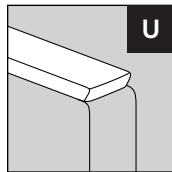

Urethane

**SEAT SEAMS**

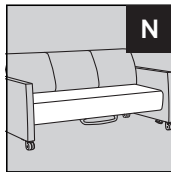

No Seams on Seat

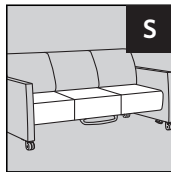

Seams on Seat

**Base Model Pricing**

Select base pricing below dependent on your selection of 76" seat width (EZ7633) or 68" seat width (EZ6833), and selected textile grade.

Base models are standard with upholstered 3.5" wide arms and dual locking caster system. Selections made on the following page will affect the model number, list price, and dimensions.

**EZ7633 - 76" Seat Width Sofa with 3.5" Arms**

**Dimensions**

Overall			Seat		
W	D	H	W	D	H
83	38.5	35.25	76	20.5	19.75
Sleep W	Sleep D	Back H	Arm H		
76	30.5	15.75	27.5		

COM: 10 yds  
 Wt Cap: 900 lb  
 Unit Weight: 207 lb\*

\*Weight will vary based on selected options

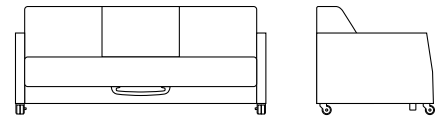

**Pricing**

COM	Dillon/Carson	A <sub>5</sub>	B <sub>6</sub>	C <sub>7</sub>	D <sub>8</sub>	E <sub>9</sub>	F <sub>10</sub>	G <sub>11</sub>	H <sub>12</sub>	I <sub>13</sub>
7,209	7,669	7,989	8,289	8,669	9,139	9,569	10,169	11,119	12,009	12,959

EZ7633  
76" Base Sofa

**EZ6833 - 68" Seat Width Sofa with 3.5" Arms**

**Dimensions**

Overall			Seat		
W	D	H	W	D	H
75	38.5	35.25	68	20.5	19.75
Sleep W	Sleep D	Back H	Arm H		
68	30.5	15.75	27.5		

COM: 9.5yds  
 Wt Cap: 900 lb  
 Unit Weight: 207 lb\*

\*Weight will vary based on selected options

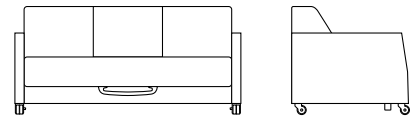

**Pricing**

COM	Dillon/Carson	A <sub>5</sub>	B <sub>6</sub>	C <sub>7</sub>	D <sub>8</sub>	E <sub>9</sub>	F <sub>10</sub>	G <sub>11</sub>	H <sub>12</sub>	I <sub>13</sub>
7,089	7,549	7,869	8,169	8,549	9,009	9,449	10,039	10,999	11,889	12,829

EZ6833  
68" Base Sofa

For COM orders, add the below yardage for options selected.  
 Barrel Arms (pair): +0.8 yds

**Build Model Number by Selecting One Option from Each Column**

Specify any additional options, along with textile/s and finishes. Add associated list prices from your selections below to the base model price on the previous page.

EXAMPLE

**1. Family**

All EZ Rest models begin with EZ

**EZ**  
EZ Rest

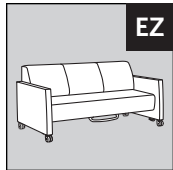

EZ Rest

**2. Seat Width**

Choose from 76 or 68

**76**  
76" Seat Width

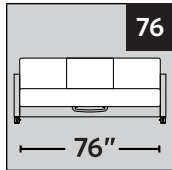

76" Seat Width  
See base pricing on previous page

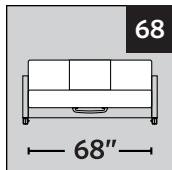

68" Seat Width  
See base pricing on previous page

**3. Left Arm**

Choose from 3 or 5

**3**  
3.5" Wide Arm

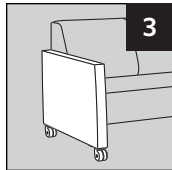

3.5" Wide Arm

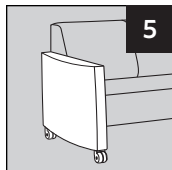

5.5" Barrel Arm  
Single Arm +300

**4. Right Arm**

Choose from 3 or 5

**3**  
3.5" Wide Arm

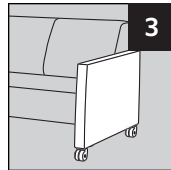

3.5" Wide Arm

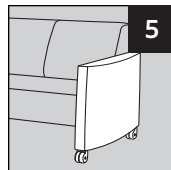

5.5" Barrel Arm  
Single Arm +300

**5. Seat Seams**

Choose from N or S

**N**  
No Seams on Seat

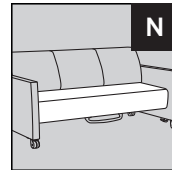

No Seams on Seat<sup>1</sup>

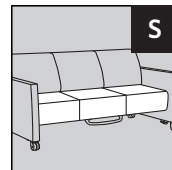

Seams on Seat

Additional arm options coming soon

**Available Options**

**ARM CAP OPTIONS**

See pg 2 for finishes

		3.5" Arms	Barrel Arms
U	Urethane	209	n/a
J1	Solid Surface - Group 1	619	1199
J2	Solid Surface - Group 2	819	1399
T	Thermofoil	n/a	399
F	Fully Upholstered Arms	Standard	Standard

To specify different arms on left & right side, divide above prices in half for single cap price

**CASTER OPTIONS**

Q3-EZ	3" - Dual Locking Caster System	Standard
-------	---------------------------------	----------

**SEAT OPTIONS**

Must choose 1 of the below

- N No seams on seat surface<sup>1</sup>
- S Seams on seat surface to match back

**ADDITIONAL FEATURES & OPTIONS**

POWER	Hospital Grade Power Outlet <sup>2</sup>	569
Z	Multi Cover	Use Pricing for Highest Grade
MB	Moisture Barrier	See pg 11

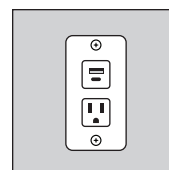

**Power Placement:**

Front of left (facing) arm

<sup>1</sup>Seat cover material must be railroaded with this selection

<sup>2</sup>(2) USB Ports, (1) 120 V Power Outlet



**Mailing Address**

P.O. Box 9  
Ferdinand, IN 47532

[getknu.com](http://getknu.com)

**Contact Us**

812.367.2068  
[customerservice@getknu.com](mailto:customerservice@getknu.com)

**Follow @GetKnu**

