

## **NOTICE TO AUTHORIZED USERS OF AWARD #23295 - Furniture, All Types (Except Hospital Room and Patient Handling)**

This pricelist/catalog **may** contain items that are not within the Scope of the Contract Award and/or not within this Contractors approved furniture Categories. All Authorized Users are strongly encouraged to review the Scope of the Award and the Contractors Category Matrix prior to selecting items for purchase under the Contract. Per Solicitation Section 4.5 (D) - Procurement Instructions for Authorized Users: When placing orders under this Award, the Authorized User should follow and be familiar with the terms and conditions governing the Contract and are responsible for determining that the product(s) they intend to purchase fit within the scope of the Award.

References to other government contracts that may be included in a Contractor's pricelist/catalog, including any additional terms or conditions, are void under the OGS Award and should be disregarded. Only OGS' Terms and Conditions, including those within a Contractor's posted Contractor Information and Supplemental Information sheet, are valid under the Contract.

Additionally, Authorized Users are reminded that where discrepancies exist between Price List documents, the lowest price shall prevail (see Section 5.3 Price).

All orders must be placed with the Contractor, or the Contractor's OGS approved Authorized Reseller listed on the OGS website under the Award. Orders placed with a reseller not approved by OGS are not considered contract orders and therefore are not subject to the same terms and conditions of the OGS Award.

Authorized Users should contact the OGS Contract Manager listed on the Award with any questions pertaining to this pricelist/catalog.

## **NYS Price List Effective 1/2/26**

**V/S**

# 2026 Legacy Price List

*VS Product Information*



## 2026 Price List Table of Contents

<b>Seating</b>	<b>Page 5</b>	RondoStand-Q	Page 157
Hokki	Page 6	RondoLift-Q	Page 158
Hokki+	Page 7	FlipTable-RU	Page 161
Compass-LuPo	Page 8	FlipTable-TR	Page 166
Compass-LuPo Plus	Page 11	FlipTable-TQ	Page 170
Compass-VF	Page 12	InteractiveTeach	Page 175
Compass-Soft	Page 16	Puzzle	Page 176
PantoSwing-LuPo	Page 17	TeamTable	Page 177
PantoSwing-VF	Page 19	TriUnion	Page 178
PantoSwing-Soft	Page 21	DROP Table	Page 179
PantoMove-LuPo	Page 22	JUMPER Studio Table	Page 180
PantoMove-VF	Page 27	M-Table	Page 181
PantoMove-Soft	Page 31		
JUMPER Air-Four	Page 32	<b>Shift+</b>	<b>Page 187</b>
JUMPER Air-Four Plus	Page 36	ThumbPrint	Page 188
JUMPER Air-Active	Page 37	Fusion	Page 189
JUMPER Air-Meet	Page 39	FusionFlip	Page 190
JUMPER Air-Move	Page 41	BaseStation	Page 191
JUMPER Air Stool	Page 48	Interact	Page 192
JUMPER Air Stool (Lift)	Page 49	Landscape	Page 193
JUMPER Air Stool Plus	Page 50	Landscape Storage	Page 196
JUMPER Ply-Four	Page 51	Transfer Teach	Page 197
JUMPER Ply-Four Plus	Page 55	Transfer	Page 198
JUMPER Ply-Active	Page 56	Transfer Box	Page 202
JUMPER Ply-Meet	Page 58	Transfer 60	Page 204
JUMPER Ply-Move	Page 59	Transfer Mobile Cabinet	Page 207
JUMPER Ply Stool	Page 65	Drum	Page 209
JUMPER Ply Stool (Lift)	Page 67	Leaf	Page 210
JUMPER Ply Stool Plus	Page 69	Drum and Leaf Kit	Page 211
NF-Compass	Page 71	Magnetic Board	Page 212
NF-Swing	Page 73	Up	Page 213
NF-Move	Page 74		
Solo	Page 76	<b>Storage</b>	<b>Page 217</b>
LuPoStool	Page 77	SPACE	Page 218
LuPoGlide	Page 78	Series 600: Cupboard for paper & handicrafts	Page 237
LiteBench-ST	Page 79	Series 600: Clothes, shoes & satchel cupboard	Page 239
Rondo (Lift)	Page 80	Series 600: Storage module	Page 241
RondoStool	Page 81	Series 600: Cupboard. Open cupboard.	Page 243
RondoStool Plus	Page 82	Series 600: MyCaddy. Stand-at module	Page 245
KN-39	Page 83	Series 600: Open cupboard	Page 248
WD-39	Page 84	Series 600: Cupboard	Page 251
Classic	Page 85	Series 600: Tambour cupboard	Page 252
M-Bench	Page 86	Profil-800	Page 253
Stakki	Page 87	Series 800	Page 258
Stacking Wagons	Page 88	OfficeBox (short)	Page 265
		OfficeBox (long)	Page 266
		LearnBox	Page 267
		MediaBox	Page 273
<b>Tables</b>	<b>Page 91</b>		
StepByStep-I	Page 92	<b>Screens</b>	<b>Page 275</b>
StepByStep-III	Page 93	LinkUp	Page 276
Step-III	Page 94	Series 2000	Page 277
Ergo-I	Page 95		
Ergo-III	Page 96	<b>Soft Seating</b>	<b>Page 281</b>
ErgoUp	Page 97	Series Lounge Linear seating	Page 282
Uno-M	Page 98	Series Lounge Chaise lounge and corner elements	Page 284
Uno-M Book Box	Page 100	Series Lounge Curved seating	Page 285
Uno-M-Step	Page 101	Series Lounge Hiback seating	Page 287
Uno-M-Teach	Page 103	Series Lounge Chair	Page 288
Duo-Media	Page 104	Series Lounge Occasional tables	Page 289
Uno-C	Page 107	RondoLounge-R	Page 292
Network	Page 109	RondoLounge-Q	Page 293
Tano	Page 118	AddLounge-R	Page 294
EcoTable-R	Page 119	AddLounge-Q	Page 295
EcoTable-Q	Page 130	ClubLounge	Page 296
LiteTable-ST	Page 142		
LiteTable-LIGNOdur	Page 148		
TriTable-III	Page 149		
TriCurve	Page 150		
RondoSit-R	Page 151		
RondoStand-R	Page 152		
RondoLift-R	Page 153		
RondoSit-Q	Page 156		

All illustrations were up-to-date at the time of going to print. In the interests of product improvement, we reserve the right to make technical or design changes at any time.

### Glide recommendation:

Plastic glides: recommended for use on carpeted areas.

2-component glides: all purpose glide, recommended for use on hard floor surfaces.

Felt glides: recommended for use on robust hard floors.





**Seating**

**Hokki  
Stool.**



<b>Model</b>	<b>03825</b>
<b>Standard price</b>	<b>\$115.00</b>
seat height 12.25 (No. 2 violet)	0.00
seat height 15 (No. 4 red)	15.00
seat height 18.15 (No. 6 blue)	21.00
seat height 20.1 (No. 7 brown)	24.00
<hr/>	
color C2	0.00

**Material overview**

**Plastic Colors**

C2	027	dark red
	029	dark blue
	030	light blue
	033	light green
	037	traffic red
	041	turquoise
	045	broom yellow
	073	black grey (RAL 7021)

**Hokki +  
Stool.**

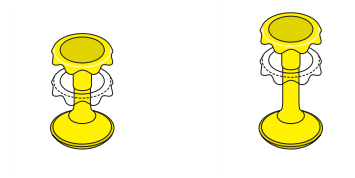

Model	03813	03814
<b>Standard price</b>	<b>\$235.00</b>	<b>\$249.00</b>
height range 15 - 19.7	0.00	--
height range 19.7 - 26.8	--	0.00
color C2	0.00	0.00

**Material overview**

**Plastic Colors**

- C2 027 dark red
- 029 dark blue
- 030 light blue
- 033 light green
- 037 traffic red
- 041 turquoise
- 045 broom yellow
- 073 black grey (RAL 7021)

**Compass-LuPo**  
Four-legged chair.



Model	31300
<b>Standard price</b>	<b>\$176.00</b>
seat height 12.25 (No. 2 violet) S	0.00
seat height 13.8 (No. 3 yellow) S	0.00
seat height 15 (No. 4 red) M	0.00
seat height 16.95 (No. 5 green) M	0.00
seat height 18.15 (No. 6 blue) L	0.00
seat height 20.1 (No. 7 brown) XL	15.00
metal color M1	0.00
metal color M060	56.00
seat / backrest plastic C1	0.00
plastic glides	0.00
felt glides	3.00
2-component glides	0.00

-Seat sizes (w, d): S (12.65", 11"); M (14.65", 14.25"); L (17", 16.5"); XL (17.9", 17.75")

**Material overview**

**Metal Colors**

- M1 030 terra grey
- 032 light blue
- 033 light green
- 041 turquoise
- 045 broom yellow
- 059 arctic
- 063 anthracite
- 065 black (RAL 9011)
- 071 sapphire blue (RAL 5003)
- 084 oxblood
- 091 white

**Plastic Colors**

- C1 027 dark red
- 029 dark blue
- 030 light blue
- 033 light green
- 041 turquoise
- 045 broom yellow
- 073 black grey (RAL 7021)
- 078 dolphin grey

- Mx 060 chrome-plated

**Compass-LuPo**  
Four-legged chair.



Model	31304	31315*
<b>Standard price</b>	<b>\$276.00</b>	<b>\$299.00</b>
seat height 12.25 (No. 2 violet) S	0.00	--
seat height 13.8 (No. 3 yellow) S	0.00	--
seat height 15 (No. 4 red) M	0.00	--
seat height 16.95 (No. 5 green) M	0.00	--
seat height 18.15 (No. 6 blue) L	0.00	0.00
seat height 20.1 (No. 7 brown) XL	15.00	--
metal color M1	0.00	0.00
metal color M060	56.00	50.00
seat / backrest plastic C1	0.00	0.00
hard casters	0.00	0.00
soft casters	0.00	0.00
bookshelf with storage basket	--	88.00

-Seat sizes (w, d): S (12.65", 11"); M (14.65", 14.25"); L (17", 16.5"); XL (17.9", 17.75")

\* XL seat shell

**Material overview**

**Metal Colors**

- M1 030 terra grey
- 032 light blue
- 033 light green
- 041 turquoise
- 045 broom yellow
- 059 arctic
- 063 anthracite
- 065 black (RAL 9011)
- 071 sapphire blue (RAL 5003)
- 084 oxblood
- 091 white

**Plastic Colors**

- C1 027 dark red
- 029 dark blue
- 030 light blue
- 033 light green
- 041 turquoise
- 045 broom yellow
- 073 black grey (RAL 7021)
- 078 dolphin grey

- Mx 060 chrome-plated

**Compass-LuPo**  
Four-legged chair.



Model	31310	31311*	31312
<b>Base price</b>	<b>\$211.00</b>	<b>\$232.00</b>	<b>\$264.00</b>
seat height	18.15	18.15	18.15
metal color M1	0.00	0.00	0.00
metal color M060	56.00	56.00	88.00
seat / backrest plastic C1	0.00	0.00	0.00
plastic glides	0.00	0.00	0.00
felt glides	3.00	3.00	3.00
2-component glides	0.00	0.00	0.00
hard casters	--	--	--
soft casters	--	--	--
bookshelf with storage basket	88.00	88.00	88.00

-Seat sizes (w, d): XL (17.9", 17.75")

\* With row linking connector

**Material overview**

**Metal Colors**

- M1 030 terra grey
- 032 light blue
- 033 light green
- 041 turquoise
- 045 broom yellow
- 059 arctic
- 063 anthracite
- 065 black (RAL 9011)
- 071 sapphire blue (RAL 5003)
- 084 oxblood
- 091 white

- Mx 060 chrome-plated

**Plastic Colors**

- C1 027 dark red
- 029 dark blue
- 030 light blue
- 033 light green
- 041 turquoise
- 045 broom yellow
- 073 black grey (RAL 7021)
- 078 dolphin grey

**Compass-LuPo Plus**  
Four-legged stool.



Model	A2536	A2537	A2538
<b>Standard price</b>	<b>\$290.00</b>	<b>\$293.00</b>	<b>\$296.00</b>
seat height	24.05	28.35	29.95
seat shell size	L	L	L
metal color M1	0.00	0.00	0.00
metal color M060	65.00	70.00	76.00
seat / backrest plastic C1	0.00	0.00	0.00
plastic glides	0.00	0.00	0.00
felt glides	3.00	3.00	3.00
2-component glides	0.00	0.00	0.00

-Seat sizes (w, d): S (12.65", 11"); M (14.65", 14.25"); L (17", 16.5"); XL (17.9", 17.75")

**Material overview**

**Metal Colors**

- M1 030 terra grey
- 032 light blue
- 033 light green
- 041 turquoise
- 045 broom yellow
- 059 arctic
- 063 anthracite
- 065 black (RAL 9011)
- 071 sapphire blue (RAL 5003)
- 084 oxblood
- 091 white

**Plastic Colors**

- C1 027 dark red
- 029 dark blue
- 030 light blue
- 033 light green
- 041 turquoise
- 045 broom yellow
- 073 black grey (RAL 7021)
- 078 dolphin grey

- Mx 060 chrome-plated

**Compass-VF**  
Four-legged chair.



Model	31324
<b>Standard price</b>	<b>\$372.00</b>
seat height 12.25 (No. 2 violet) S	0.00
seat height 13.8 (No. 3 yellow) S	0.00
seat height 15 (No. 4 red) M	0.00
seat height 16.95 (No. 5 green) M	0.00
seat height 18.15 (No. 6 blue) L	0.00
seat height 20.1 (No. 7 brown) XL	15.00
<hr/>	
max. number stackable	10
<hr/>	
metal color M1	0.00
metal color M060	56.00
<hr/>	
wooden parts seat / backrest 010 natural	0.00
wooden parts seat / backrest H1	18.00
<hr/>	
hard casters	0.00
soft casters	0.00

-Seat sizes (w, d): S (12.65", 11"); M (14.65", 14.25"); L (17", 16.5"); XL (17.9", 17.75")

**Material overview**

**Metal Colors**

M1	030	terra grey
	032	light blue
	033	light green
	041	turquoise
	045	broom yellow
	059	arctic
	063	anthracite
	065	black (RAL 9011)
	071	sapphire blue (RAL 5003)
	084	oxblood
	091	white

**Wood Stain Colors**

H1	011	black
	021	light green
	022	light blue
	023	light grey
	027	dark red
	029	dark blue
	037	traffic red
	041	turquoise
	045	broom yellow
	051	polar white

Mx	060	chrome-plated
----	-----	---------------

Hx	010	natural
----	-----	---------

**Compass-VF**  
Four-legged chair.



Model	31320
Standard price	\$267.00
seat height 12.25 (No. 2 violet) S	0.00
seat height 13.8 (No. 3 yellow) S	0.00
seat height 15 (No. 4 red) M	0.00
seat height 16.95 (No. 5 green) M	0.00
seat height 18.15 (No. 6 blue) L	0.00
seat height 20.1 (No. 7 brown) XL	15.00
<hr/>	
max. number stackable	10
<hr/>	
metal color M1	0.00
metal color M060	44.00
<hr/>	
wooden parts seat / backrest 010 natural	0.00
wooden parts seat / backrest H1	18.00
<hr/>	
plastic glides	0.00
felt glides	3.00
2-component glides	0.00

-Seat sizes (w, d): S (12.65", 11"); M (14.65", 14.25"); L (17", 16.5"); XL (17.9", 17.75")

**Material overview**

**Metal Colors**

M1	030	terra grey
	032	light blue
	033	light green
	041	turquoise
	045	broom yellow
	059	arctic
	063	anthracite
	065	black (RAL 9011)
	071	sapphire blue (RAL 5003)
	084	oxblood
	091	white

**Wood Stain Colors**

H1	011	black
	021	light green
	022	light blue
	023	light grey
	027	dark red
	029	dark blue
	037	traffic red
	041	turquoise
	045	broom yellow
	051	polar white

Mx	060	chrome-plated
----	-----	---------------

Hx	010	natural
----	-----	---------

**Compass-VF**  
Four-legged chair.



Model	31330	31331	31335*
<b>Base price</b>	<b>\$337.00</b>	<b>\$398.00</b>	<b>\$369.00</b>
seat height	17.55	18.15	17.55
max. number stackable**	10	10	10
metal color M1	0.00	0.00	0.00
metal color M060	56.00	56.00	56.00
wooden parts seat / backrest 010 natural	0.00	0.00	0.00
wooden parts seat / backrest H1	18.00	18.00	18.00
plastic glides	0.00	0.00	0.00
felt glides	3.00	3.00	3.00
2-component glides	0.00	0.00	0.00
bookshelf with storage basket	41.00	41.00	41.00
upholstery S40	--	50.00	--
upholstery S46/54	--	0.00	--
upholstery S51	--	30.00	--
upholstery S64	--	18.00	--
upholstery S74	--	0.00	--
upholstery S78	--	6.00	--
upholstery S79	--	24.00	--
upholstery S82	--	30.00	--

-Seat sizes (w, d): S (12.65", 11"); M (14.65", 14.25"); L (17", 16.5"); XL (17.9", 17.75")

\* With row linking connector

\*\* Only stackable without storage basket

Material overview

**Metal Colors**

M1	030	terra grey
	032	light blue
	033	light green
	041	turquoise
	045	broom yellow
	059	arctic
	063	anthracite
	065	black (RAL 9011)
	071	sapphire blue (RAL 5003)
	084	oxblood
	091	white

Mx	060	chrome-plated
----	-----	---------------

**Wood Stain Colors**

H1	011	black
	021	light green
	022	light blue
	023	light grey
	027	dark red
	029	dark blue
	037	traffic red
	041	turquoise
	045	broom yellow
	051	polar white

Hx	010	natural
----	-----	---------

**Fabrics**

S40	Stamskin Top
S46/S54	Xtreme
S51	Blazer
S64	Mover
S74	Era
S78	Step/StepMelange
S79	Trevi D
S82	Evida

**Compass-VF**  
Four-legged chair.

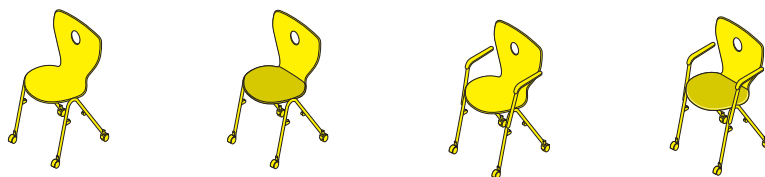

Model	31360	31361	31365	31366
<b>Base price</b>	<b>\$410.00</b>	<b>\$506.00</b>	<b>\$468.00</b>	<b>\$544.00</b>
seat height	18.15	18.35	17.75	18.35
max. number stackable*	6	6	6	6
metal color M1	0.00	0.00	0.00	0.00
metal color M060	50.00	50.00	88.00	88.00
wooden parts seat / backrest 010 natural	0.00	0.00	0.00	0.00
wooden parts seat / backrest H1	18.00	18.00	18.00	18.00
hard casters	0.00	0.00	0.00	0.00
soft casters	6.00	6.00	6.00	6.00
upholstery S40	--	50.00	--	50.00
upholstery S46/54	--	0.00	--	0.00
upholstery S51	--	30.00	--	30.00
upholstery S64	--	18.00	--	18.00
upholstery S74	--	0.00	--	0.00
upholstery S78	--	6.00	--	6.00
upholstery S79	--	24.00	--	24.00
upholstery S82	--	30.00	--	30.00

-Seat sizes (w, d): S (12.65", 11"); M (14.65", 14.25"); L (17", 16.5"); XL (17.9", 17.75")

\* Only stackable without storage basket

**Material overview**

**Metal Colors**

- M1 030 terra grey
- 032 light blue
- 033 light green
- 041 turquoise
- 045 broom yellow
- 059 arctic
- 063 anthracite
- 065 black (RAL 9011)
- 071 sapphire blue (RAL 5003)
- 084 oxblood
- 091 white

**Wood Stain Colors**

- H1 011 black
- 021 light green
- 022 light blue
- 023 light grey
- 027 dark red
- 029 dark blue
- 037 traffic red
- 041 turquoise
- 045 broom yellow
- 051 polar white

**Fabrics**

- S40 Stamskin Top
- S46/S54 Xtreme
- S51 Blazer
- S64 Mover
- S74 Era
- S78 Step/StepMelange
- S79 Trevi D
- S82 Evida

- Mx 060 chrome-plated

- Hx 010 natural

**Compass-Soft**  
Four-legged chair.



Model	31382	31387
<b>Standard price</b>	<b>\$503.00</b>	<b>\$599.00</b>
seat height	18.9	18.9
metal color M1	0.00	0.00
metal color M060	50.00	50.00
all-around upholstery S51	73.00	73.00
all-around upholstery S74	0.00	0.00
all-around upholstery S78	24.00	24.00
all-around upholstery S79	62.00	62.00
plastic glides	0.00	--
felt glides	3.00	--
2-component glides	12.00	--
hard casters	--	0.00
soft casters	--	6.00
with storage basket	88.00	88.00

\* With row linking connector

**Material overview**

**Metal Colors**

- M1 030 terra grey
- 032 light blue
- 033 light green
- 041 turquoise
- 045 broom yellow
- 059 arctic
- 063 anthracite
- 065 black (RAL 9011)
- 071 sapphire blue (RAL 5003)
- 084 oxblood
- 091 white

**Fabrics**

- S51 Blazer
- S74 Era
- S78 Step/StepMelange
- S79 Trevi D

- Mx 060 chrome-plated

\*L seat shell on green dot height,  
XL seat shell on blue dot height

**PantoSwing-LuPo**  
Forward-flexing cantilever chair.



Model	31400	31401*
<b>Standard price</b>	<b>\$171.00</b>	<b>\$171.00</b>
seat height 12.25 (No. 2 violet) S	0.00	--
seat height 13.8 (No. 3 yellow) S	0.00	--
seat height 15 (No. 4 red) M	0.00	--
seat height 16.95 (No. 5 green) M	0.00	0.00
seat height 18.15 (No. 6 blue) L	0.00	18.00
seat height 20.1 (No. 7 brown) XL	18.00	--
<hr/>		
metal color M1	0.00	0.00
metal color M060	44.00	44.00
<hr/>		
seat / backrest plastic C1	0.00	0.00
<hr/>		
plastic glides	0.00	0.00
felt glides	3.00	3.00
2-component glides	0.00	0.00
<hr/>		
tabletop edge protector	18.00	18.00

-Seat sizes (w, d): S (12.65", 11"); M (14.65", 14.25"); L (17", 16.5"); XL (17.9", 17.75")

**Material overview**

**Metal Colors**

- M1 030 terra grey
- 032 light blue
- 033 light green
- 041 turquoise
- 045 broom yellow
- 059 arctic
- 063 anthracite
- 065 black (RAL 9011)
- 071 sapphire blue (RAL 5003)
- 084 oxblood
- 091 white

**Plastic Colors**

- C1 027 dark red
- 029 dark blue
- 030 light blue
- 033 light green
- 041 turquoise
- 045 broom yellow
- 073 black grey (RAL 7021)
- 078 dolphin grey

- Mx 060 chrome-plated

**PantoSwing-LuPo**  
Forward-flexing cantilever chair.

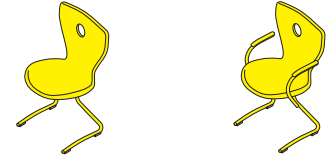

Model	31410	31412
<b>Standard price</b>	<b>\$203.00</b>	<b>\$299.00</b>
seat height	18.15	18.15
seat shell size	XL	XL
metal color M1	0.00	0.00
metal color M060	59.00	88.00
seat / backrest plastic C1	0.00	0.00
plastic glides	0.00	0.00
felt glides	3.00	3.00
2-component glides	12.00	12.00
tabletop edge protector	18.00	18.00

-Seat sizes (w, d): S (12.65", 11"); M (14.65", 14.25"); L (17", 16.5"); XL (17.9", 17.75")

**Material overview**

**Metal Colors**

- M1 030 terra grey
- 032 light blue
- 033 light green
- 041 turquoise
- 045 broom yellow
- 059 arctic
- 063 anthracite
- 065 black (RAL 9011)
- 071 sapphire blue (RAL 5003)
- 084 oxblood
- 091 white

**Plastic Colors**

- C1 027 dark red
- 029 dark blue
- 030 light blue
- 033 light green
- 041 turquoise
- 045 broom yellow
- 073 black grey (RAL 7021)
- 078 dolphin grey

- Mx 060 chrome-plated

**PantoSwing-VF**  
Forward-flexing cantilever chair.

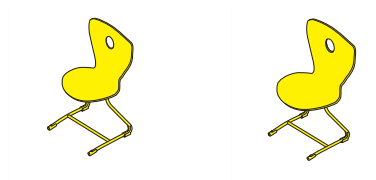

Model	31420	31421*
<b>Standard price</b>	<b>\$279.00</b>	<b>\$308.00</b>
seat height 12.25 (No. 2 violet) S	0.00	--
seat height 13.8 (No. 3 yellow) S	0.00	--
seat height 15 (No. 4 red) M	0.00	--
seat height 16.95 (No. 5 green) M	0.00	0.00
seat height 18.15 (No. 6 blue) L	0.00	18.00
seat height 20.1 (No. 7 brown) XL	15.00	--
<hr/>		
metal color M1	0.00	0.00
metal color M060	41.00	50.00
<hr/>		
wooden parts seat / backrest 010 natural	0.00	0.00
wooden parts seat / backrest H1	18.00	18.00
<hr/>		
plastic glides	0.00	0.00
felt glides	3.00	3.00
2-component glides	0.00	0.00
<hr/>		
tabletop edge protector	18.00	18.00

*\*L seat shell on green dot height, XL seat shell on blue dot height*  
*-Seat sizes (w, d): S (12.65", 11"); M (14.65", 14.25"); L (17", 16.5"); XL (17.9", 17.75")*

**Material overview**

**Metal Colors**

- M1 030 terra grey
- 032 light blue
- 033 light green
- 041 turquoise
- 045 broom yellow
- 059 arctic
- 063 anthracite
- 065 black (RAL 9011)
- 071 sapphire blue (RAL 5003)
- 084 oxblood
- 091 white

**Wood Stain Colors**

- H1 011 black
- 021 light green
- 022 light blue
- 023 light grey
- 027 dark red
- 029 dark blue
- 037 traffic red
- 041 turquoise
- 045 broom yellow
- 051 polar white

- Mx 060 chrome-plated

- Hx 010 natural

**PantoSwing-VF**  
Forward-flexing cantilever chair.

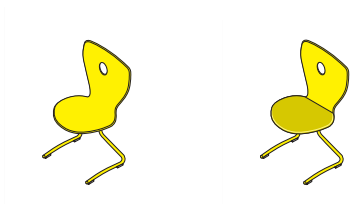

Model	31430	31431
<b>Base price</b>	<b>\$314.00</b>	<b>\$398.00</b>
seat height	18.15	18.75
metal color M1	0.00	0.00
metal color M060	62.00	62.00
wooden parts seat / backrest 010 natural	0.00	0.00
wooden parts seat / backrest H1	18.00	18.00
plastic glides	0.00	0.00
felt glides	3.00	3.00
2-component glides	12.00	12.00
tabletop edge protector	18.00	18.00
upholstery S40	--	50.00
upholstery S46/54	--	0.00
upholstery S51	--	30.00
upholstery S64	--	18.00
upholstery S74	--	0.00
upholstery S78	--	6.00
upholstery S79	--	24.00
upholstery S82	--	30.00

-Seat sizes (w, d): S (12.65", 11"); M (14.65", 14.25"); L (17", 16.5"); XL (17.9", 17.75")

**Material overview**

**Metal Colors**

M1	030	terra grey
	032	light blue
	033	light green
	041	turquoise
	045	broom yellow
	059	arctic
	063	anthracite
	065	black (RAL 9011)
	071	sapphire blue (RAL 5003)
	084	oxblood
	091	white

**Wood Stain Colors**

H1	011	black
	021	light green
	022	light blue
	023	light grey
	027	dark red
	029	dark blue
	037	traffic red
	041	turquoise
	045	broom yellow
	051	polar white

**Fabrics**

S40	Stamskin Top
S46/S54	Xtreme
S51	Blazer
S64	Mover
S74	Era
S78	Step/StepMelange
S79	Trevi D
S82	Evida

Mx	060	chrome-plated
----	-----	---------------

Hx	010	natural
----	-----	---------

**PantoSwing-Soft**  
Forward-flexing cantilever chair.



Model	31413	31415	31414
<b>Standard price</b>	<b>\$512.00</b>	<b>\$526.00</b>	<b>\$585.00</b>
seat height	18.9	18.9	18.9
seat shell size	XL	XL	XL
metal color M1	0.00	0.00	0.00
metal color M060	56.00	50.00	82.00
all-around upholstery S51	73.00	73.00	73.00
all-around upholstery S74	0.00	0.00	0.00
all-around upholstery S78	24.00	24.00	24.00
all-around upholstery S79	62.00	62.00	62.00
plastic glides	0.00	0.00	0.00
felt glides	3.00	3.00	3.00
2-component glides	0.00	0.00	0.00
tabletop edge protector	18.00	18.00	18.00

**Material overview**

**Metal Colors**

- M1 030 terra grey
- 032 light blue
- 033 light green
- 041 turquoise
- 045 broom yellow
- 059 arctic
- 063 anthracite
- 065 black (RAL 9011)
- 071 sapphire blue (RAL 5003)
- 084 oxblood
- 091 white

- Mx 060 chrome-plated

**Fabrics**

- S51 Blazer
- S74 Era
- S78 Step/StepMelange
- S79 Trevi D

**PantoMove-LuPo**  
Five-star foot chair.

fix



kiga



Model	31501	31505	31506	31508	31507
<b>Standard price</b>	<b>\$360.00</b>	<b>\$366.00</b>	<b>\$392.00</b>	<b>\$395.00</b>	<b>\$550.00</b>
seat height	18.15	13.45 - 16.95	16.7 - 21.75	13.95 - 17.45	19.85 - 29.6
seat shell size	L	M	L	L	L
metal color M1	0.00	0.00	0.00	0.00	0.00
seat / backrest plastic C1	0.00	0.00	0.00	0.00	0.00
plastic glides	0.00	0.00	0.00	0.00	<b>-8.00</b>
2-component glides	0.00	0.00	0.00	0.00	<b>-8.00</b>
hard casters, height +1	0.00	0.00	0.00	0.00	--
soft casters, height +1	0.00	0.00	0.00	0.00	0.00
height-adjust. foot ring	--	105.00	105.00	--	0.00
3D rocking	--	0.00	0.00	0.00	0.00
basic non-rocking	--	<b>-37.00</b>	<b>-37.00</b>	<b>-37.00</b>	<b>-37.00</b>

-Seat sizes (w, d): S (12.65", 11"); M (14.65", 14.25"); L (17", 16.5"); XL (17.9", 17.75")

**Material overview**

**Metal Colors**

M1	030	terra grey
	032	light blue
	033	light green
	041	turquoise
	045	broom yellow
	059	arctic
	063	anthracite
	065	black (RAL 9011)
	071	sapphire blue (RAL 5003)
	084	oxblood
	091	white

**Plastic Colors**

C1	027	dark red
	029	dark blue
	030	light blue
	033	light green
	041	turquoise
	045	broom yellow
	073	black grey (RAL 7021)
	078	dolphin grey

**PantoMove-LuPo**  
**Five-star foot chair.**

kiga



<b>Model</b>	<b>31579</b>
<b>Standard price</b>	<b>\$494.00</b>
adjustable seat height	14.75 - 18.25
seat shell size	L
metal color M1	0.00
seat / backrest plastic C1	0.00
plastic glides	0.00
2-component glides	0.00
hard casters, height +1	0.00
soft casters, height +1	0.00
3D rocking	0.00
basic non-rocking	<b>-37.00</b>
upholstery S51	56.00
upholstery S74	0.00
upholstery S78	12.00
upholstery S79	44.00

-Seat sizes (w, d): S (12.65", 11"); M (14.65", 14.25"); L (17", 16.5"); XL (17.9", 17.75")

**Material overview**

**Metal Colors**

M1	030	terra grey
	032	light blue
	033	light green
	041	turquoise
	045	broom yellow
	059	arctic
	063	anthracite
	065	black (RAL 9011)
	071	sapphire blue (RAL 5003)
	084	oxblood
	091	white

**Plastic Colors**

C1	027	dark red
	029	dark blue
	030	light blue
	033	light green
	041	turquoise
	045	broom yellow
	073	black grey (RAL 7021)
	078	dolphin grey

**PantoMove-LuPo**  
**Five-star foot chair.**



<b>Model</b>	<b>31509</b>
<b>Standard price</b>	<b>\$395.00</b>
adjustable seat height	16.2 - 21.25
seat shell size	M
metal color M1	0.00
seat / backrest plastic C1	0.00
plastic glides	0.00
2-component glides	0.00
hard casters, height +1	0.00
soft casters, height +1	0.00
load activated braking casters , height +1	24.00
height-adjust. foot ring	105.00
3D rocking	0.00
basic non-rocking	<b>-37.00</b>

-Seat sizes (w, d): S (12.65", 11"); M (14.65", 14.25"); L (17", 16.5"); XL (17.9", 17.75")

**Material overview**

**Metal Colors**

M1	030	terra grey
	032	light blue
	033	light green
	041	turquoise
	045	broom yellow
	059	arctic
	063	anthracite
	065	black (RAL 9011)
	071	sapphire blue (RAL 5003)
	084	oxblood
	091	white

**Plastic Colors**

C1	027	dark red
	029	dark blue
	030	light blue
	033	light green
	041	turquoise
	045	broom yellow
	073	black grey (RAL 7021)
	078	dolphin grey

**PantoMove-LuPo**  
Five-star foot chair.



Model	31510	31511	31512	31517
<b>Standard price</b>	<b>\$480.00</b>	<b>\$629.00</b>	<b>\$582.00</b>	<b>\$728.00</b>
adjustable seat height	18.8 - 23.85	18.8 - 23.85	21.9 - 31.65	21.9 - 31.7
seat shell size	XL	XL	XL	XL
metal color M1	0.00	0.00	0.00	0.00
metal color alu highly polished	44.00	44.00	44.00	44.00
metal color M060	383.00	429.00	383.00	429.00
seat / backrest plastic C1	0.00	0.00	0.00	0.00
plastic glides	0.00	0.00	-8.00	-8.00
2-component glides	0.00	0.00	-8.00	-8.00
hard casters, height +1	0.00	0.00	--	--
soft casters, height +1	0.00	0.00	0.00	0.00
3D rocking	0.00	0.00	0.00	0.00
basic non-rocking	-37.00	-37.00	-37.00	-37.00

-Seat sizes (w, d): S (12.65", 11"); M (14.65", 14.25"); L (17", 16.5"); XL (17.9", 17.75")

**Material overview**

**Metal Colors**

- M1 030 terra grey
- 032 light blue
- 033 light green
- 041 turquoise
- 045 broom yellow
- 059 arctic
- 063 anthracite
- 065 black (RAL 9011)
- 071 sapphire blue (RAL 5003)
- 084 oxblood
- 091 white

**Plastic Colors**

- C1 027 dark red
- 029 dark blue
- 030 light blue
- 033 light green
- 041 turquoise
- 045 broom yellow
- 073 black grey (RAL 7021)
- 078 dolphin grey

- Mx 049 high polished aluminum
- 060 chrome-plated

**PantoMove-LuPo**  
College chair with tray.



Model	31580	31581
<b>Standard price</b>	<b>\$629.00</b>	<b>\$687.00</b>
seat height	18.15	16.25 - 19.75
seat shell size	L	L
metal color M1	0.00	0.00
seat / backrest plastic C1	0.00	0.00
tablet made of white CDF with black rounded edge, left or right	0.00	0.00
plastic glides	0.00	0.00
2-component glides	0.00	0.00
hard casters, height +1	0.00	0.00
soft casters, height +1	0.00	0.00
3D rocking	--	0.00
basic non-rocking	--	<b>-37.00</b>

-Seat sizes (w, d): S (12.65", 11"); M (14.65", 14.25"); L (17", 16.5"); XL (17.9", 17.75")

**Material overview**

**Metal Colors**

M1	030	terra grey
	032	light blue
	033	light green
	041	turquoise
	045	broom yellow
	059	arctic
	063	anthracite
	065	black (RAL 9011)
	071	sapphire blue (RAL 5003)
	084	oxblood
	091	white

**Plastic Colors**

C1	027	dark red
	029	dark blue
	030	light blue
	033	light green
	041	turquoise
	045	broom yellow
	073	black grey (RAL 7021)
	078	dolphin grey

**PantoMove-VF**  
Five-star foot chair.

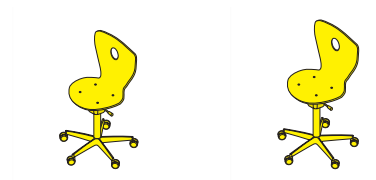

Model	31525	31526
<b>Standard price</b>	<b>\$465.00</b>	<b>\$494.00</b>
seat height	--	--
adjustable seat height	12.95 - 16.9	16.35 - 22.35
seat shell size	M	L
metal color M1	0.00	0.00
wooden parts seat / backrest 010 natural	0.00	0.00
wooden parts seat / backrest H1	18.00	18.00
plastic glides	0.00	0.00
2-component glides	0.00	0.00
hard casters, height +1	0.00	0.00
soft casters, height +1	0.00	0.00
height-adjust. foot ring	105.00	105.00
3D rocking	0.00	0.00
basic non-rocking	<b>-37.00</b>	<b>-37.00</b>

-Seat sizes (w, d): S (12.65", 11"); M (14.65", 14.25"); L (17", 16.5"); XL (17.9", 17.75")

**Material overview**

**Metal Colors**

- M1 030 terra grey
- 032 light blue
- 033 light green
- 041 turquoise
- 045 broom yellow
- 059 arctic
- 063 anthracite
- 065 black (RAL 9011)
- 071 sapphire blue (RAL 5003)
- 084 oxblood
- 091 white

**Wood Stain Colors**

- H1 011 black
- 021 light green
- 022 light blue
- 023 light grey
- 027 dark red
- 029 dark blue
- 037 traffic red
- 041 turquoise
- 045 broom yellow
- 051 polar white
- Hx 010 natural

**PantoMove-VF**  
Five-star foot chair.

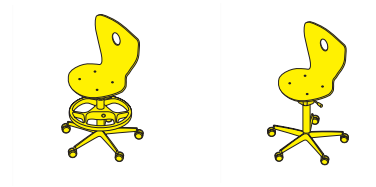

Model	31527	31529
<b>Standard price</b>	<b>\$582.00</b>	<b>\$465.00</b>
adjustable seat height	19.95 - 30.7	16.25 - 22.25
seat shell size	L	M
metal color M1	0.00	0.00
wooden parts seat / backrest 010 natural	0.00	0.00
wooden parts seat / backrest H1	18.00	18.00
plastic glides	<b>-8.00</b>	0.00
2-component glides	<b>-8.00</b>	0.00
hard casters, height +1	--	0.00
soft casters, height +1	0.00	0.00
load activated braking casters, height +1	0.00	24.00
height-adjust. foot ring	--	105.00
3D rocking	0.00	0.00
basic non-rocking	<b>-37.00</b>	<b>-37.00</b>

-Seat sizes (w, d): S (12.65", 11"); M (14.65", 14.25"); L (17", 16.5"); XL (17.9", 17.75")

**Material overview**

**Metal Colors**

M1	030	terra grey
	032	light blue
	033	light green
	041	turquoise
	045	broom yellow
	059	arctic
	063	anthracite
	065	black (RAL 9011)
	071	sapphire blue (RAL 5003)
	084	oxblood
	091	white

**Wood Stain Colors**

H1	011	black
	021	light green
	022	light blue
	023	light grey
	027	dark red
	029	dark blue
	037	traffic red
	041	turquoise
	045	broom yellow
	051	polar white
Hx	010	natural

**PantoMove-VF**  
Five-star foot chair.



Model	31540	31541	31545	31546
<b>Standard price</b>	<b>\$524.00</b>	<b>\$541.00</b>	<b>\$556.00</b>	<b>\$658.00</b>
adjustable seat height	17.45 - 23.45	18.25 - 24.25	17.45 - 23.45	18.25 - 24.25
seat shell size	XL	XL	XL	XL
metal color M1	0.00	0.00	0.00	0.00
metal color alu highly polished	44.00	44.00	44.00	44.00
metal color M060	383.00	383.00	429.00	429.00
wooden parts seat / backrest 010 natural	0.00	0.00	0.00	0.00
wooden parts seat / backrest H1	18.00	18.00	18.00	18.00
plastic glides	0.00	0.00	0.00	0.00
2-component glides	0.00	0.00	0.00	0.00
hard casters, height +1	0.00	0.00	0.00	0.00
soft casters, height +1	0.00	0.00	0.00	0.00
3D rocking	0.00	0.00	0.00	0.00
basic non-rocking	<b>-37.00</b>	<b>-37.00</b>	<b>-37.00</b>	<b>-37.00</b>
upholstery S40	--	50.00	--	50.00
upholstery S46/54	--	0.00	--	0.00
upholstery S51	--	30.00	--	30.00
upholstery S64	--	24.00	--	24.00
upholstery S74	--	0.00	--	0.00
upholstery S78	--	6.00	--	6.00
upholstery S79	--	24.00	--	24.00
upholstery S82	--	30.00	--	30.00

-Seat sizes (w, d): L (17", 16.5"); XL (17.9", 17.75")

**Material overview**

**Metal Colors**

- M1 030 terra grey
- 032 light blue
- 033 light green
- 041 turquoise
- 045 broom yellow
- 059 arctic
- 063 anthracite
- 065 black (RAL 9011)
- 071 sapphire blue (RAL 5003)
- 084 oxblood
- 091 white

**Wood Stain Colors**

- H1 011 black
- 021 light green
- 022 light blue
- 023 light grey
- 027 dark red
- 029 dark blue
- 037 traffic red
- 041 turquoise
- 045 broom yellow
- 051 polar white

**Fabrics**

- S40 Stamskin Top
- S46/S54 Xtreme
- S51 Blazer
- S64 Mover
- S74 Era
- S78 Step/StepMelange
- S79 Trevi D
- S82 Evida

- Mx 049 high polished aluminum
- 060 chrome-plated

**PantoMove-VF**  
Five-star foot chair.



Model	31550	31551	31555	31556
<b>Standard price</b>	<b>\$614.00</b>	<b>\$666.00</b>	<b>\$701.00</b>	<b>\$760.00</b>
adjustable seat height	20.98 -31.75	21.8 - 32.55	20.98 -31.75	21.8 - 32.55
seat shell size	XL	XL	XL	XL
metal color M1	0.00	0.00	0.00	0.00
metal color alu highly polished	44.00	44.00	44.00	44.00
metal color M060	383.00	383.00	429.00	429.00
wooden parts seat / backrest 010 natural	0.00	0.00	0.00	0.00
wooden parts seat / backrest H1	18.00	18.00	18.00	18.00
plastic glides	<b>-8.00</b>	<b>-8.00</b>	<b>-8.00</b>	<b>-8.00</b>
2-component glides	<b>-8.00</b>	<b>-8.00</b>	<b>-8.00</b>	<b>-8.00</b>
soft casters, height +1	0.00	0.00	0.00	0.00
3D rocking	0.00	0.00	0.00	0.00
basic non-rocking	<b>-37.00</b>	<b>-37.00</b>	<b>-37.00</b>	<b>-37.00</b>
upholstery S40	--	50.00	--	50.00
upholstery S46/54	--	0.00	--	0.00
upholstery S51	--	30.00	--	30.00
upholstery S64	--	24.00	--	24.00
upholstery S74	--	0.00	--	0.00
upholstery S78	--	6.00	--	6.00
upholstery S79	--	24.00	--	24.00
upholstery S82	--	30.00	--	30.00

-Seat sizes (w, d): L (17", 16.5"); XL (17.9", 17.75")

**Material overview**

**Metal Colors**

M1	030	terra grey
	032	light blue
	033	light green
	041	turquoise
	045	broom yellow
	059	arctic
	063	anthracite
	065	black (RAL 9011)
	071	sapphire blue (RAL 5003)
	084	oxblood
	091	white

**Wood Stain Colors**

H1	011	black
	021	light green
	022	light blue
	023	light grey
	027	dark red
	029	dark blue
	037	traffic red
	041	turquoise
	045	broom yellow
	051	polar white

**Fabrics**

S40	Stamskin Top
S46/S54	Xtreme
S51	Blazer
S64	Mover
S74	Era
S78	Step/StepMelange
S79	Trevi D
S82	Evida

Mx	049	high polished aluminum
	060	chrome-plated

Hx	010	natural
----	-----	---------

**PantoMove-Soft**  
Five-star foot chair.



Model	31513	31514	31515	31516
<b>Standard price</b>	<b>\$701.00</b>	<b>\$818.00</b>	<b>\$789.00</b>	<b>\$935.00</b>
seat height	19.4 - 24.45	19.4 - 24.45	22.65 - 32.5	22.65 - 32.5
seat shell size	XL	XL	XL	XL
metal color M1	0.00	0.00	0.00	0.00
metal color alu highly polished	44.00	44.00	44.00	44.00
metal color M060	383.00	429.00	383.00	429.00
all-around upholstery S51	73.00	73.00	73.00	73.00
all-around upholstery S74	0.00	0.00	0.00	0.00
all-around upholstery S78	24.00	24.00	24.00	24.00
all-around upholstery S79	62.00	62.00	62.00	62.00
plastic glides	<b>-8.00</b>	<b>-8.00</b>	<b>-8.00</b>	<b>-8.00</b>
2-component glides	<b>-8.00</b>	<b>-8.00</b>	<b>-8.00</b>	<b>-8.00</b>
hard casters	0.00	0.00	--	--
soft casters	0.00	0.00	0.00	0.00
3D rocking	0.00	0.00	0.00	0.00
basic non-rocking	<b>-37.00</b>	<b>-37.00</b>	<b>-37.00</b>	<b>-37.00</b>

-Seat sizes (w, d): L (17", 16.5"); XL (17.9", 17.75")

**Material overview**

**Metal Colors**

M1	030	terra grey
	032	light blue
	033	light green
	041	turquoise
	045	broom yellow
	059	arctic
	063	anthracite
	065	black (RAL 9011)
	071	sapphire blue (RAL 5003)
	084	oxblood
	091	white

**Fabrics**

S51	Blazer
S74	Era
S78	Step/StepMelange
S79	Trevi D

Mx	049	high polished aluminum
	060	chrome-plated

**JUMPER Air-Four**  
Four-legged chair.

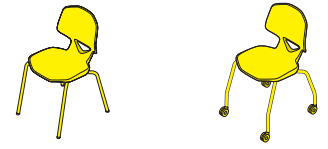

Model	33300	33319
<b>Standard price</b>	<b>\$200.00</b>	<b>\$252.00</b>
seat height 12.25 (No. 2 violet) S	0.00	0.00
seat height 13.8 (No. 3 yellow) S	0.00	0.00
seat height 15 (No. 4 red) M	0.00	0.00
seat height 16.95 (No. 5 green) M	0.00	0.00
seat height 18.15 (No. 6 blue) L	0.00	0.00
seat height 20.1 (No. 7 brown) XL	15.00	15.00
<hr/>		
max. number stackable	5	5
<hr/>		
metal color M1	0.00	0.00
metal color M060	50.00	50.00
<hr/>		
seat / backrest plastic C4	0.00	0.00
<hr/>		
plastic glides	0.00	--
felt glides	0.00	--
2-component glides	0.00	--
hard casters	--	0.00
soft casters	--	0.00

- Seat sizes (w, d): S (13.1", 9.6"); M (15.6", 11.25"); L (17.35", 12.35"); XL (18.55", 13.1")

**Material overview**

**Metal Colors**

- M1 030 terra grey
- 032 light blue
- 033 light green
- 041 turquoise
- 045 broom yellow
- 059 arctic
- 063 anthracite
- 065 black (RAL 9011)
- 071 sapphire blue (RAL 5003)
- 084 oxblood
- 091 white

**Plastic Colors**

- C4 027 dark red
- 029 dark blue
- 030 light blue
- 033 light green
- 037 traffic red
- 041 turquoise
- 045 broom yellow
- 073 black grey (RAL 7021)
- 078 dolphin grey

- Mx 060 chrome-plated

**JUMPER Air-Four**  
 Four-legged chair.

Model	33310*	33313	33312
<b>Standard price</b>	<b>\$235.00</b>	<b>\$334.00</b>	<b>\$521.00</b>
seat height	18.15	18.15	18.75
seat shell size	XL	XL	XL
max. number stackable	5	3	5
metal color M1	0.00	0.00	0.00
metal color M060	50.00	79.00	50.00
seat / backrest plastic C4	0.00	0.00	--
plastic glides	0.00	0.00	0.00
felt glides	0.00	0.00	0.00
2-component glides	0.00	0.00	0.00
upholstery S40	--	--	135.00
upholstery S46/54	--	--	0.00
upholstery S51	--	--	79.00
upholstery S64	--	--	56.00
upholstery S74	--	--	0.00
upholstery S78	--	--	30.00*
upholstery S79	--	--	68.00
upholstery S82	--	--	82.00

- Seat sizes (w, d): S (13.1", 9.6"); M (15.6", 11.25"); L (17.35", 12.35"); XL (18.55", 13.1")

\*Two colored option available for S78 for an extra \$56.00 upcharge list.

**Material overview**
**Metal Colors**

M1	030	terra grey
	032	light blue
	033	light green
	041	turquoise
	045	broom yellow
	059	arctic
	063	anthracite
	065	black (RAL 9011)
	071	sapphire blue (RAL 5003)
	084	oxblood
	091	white

**Plastic Colors**

C4	027	dark red
	029	dark blue
	030	light blue
	033	light green
	037	traffic red
	041	turquoise
	045	broom yellow
	073	black grey (RAL 7021)
	078	dolphin grey

**Fabrics**

S40	Stamskin Top
S46/S54	Xtreme
S51	Blazer
S64	Mover
S74	Era
S78	Step/StepMelange
S79	Trevi D
S82	Evida

Mx 060 chrome-plated

**JUMPER Air-Four**  
Four-legged chair with casters.



Model	33323	33325*	33326
<b>Standard price</b>	<b>\$279.00</b>	<b>\$579.00</b>	<b>\$343.00</b>
seat height	18.15	18.15	18.15
seat shell size	XL	XL	XL
max. number stackable	5	5	3
metal color M1	0.00	0.00	0.00
metal color M060	50.00	50.00	79.00
seat / backrest plastic C4	0.00	--	0.00
hard casters	0.00	0.00	0.00
soft casters	0.00	0.00	0.00
upholstery S40	--	97.00	--
upholstery S46/54	--	0.00	--
upholstery S51	--	79.00	--
upholstery S64	--	56.00	--
upholstery S74	--	0.00	--
upholstery S78	--	30.00*	--
upholstery S79	--	68.00	--
upholstery S82	--	82.00	--

- Seat sizes (w, d): S (13.1", 9.6"); M (15.6", 11.25"); L (17.35", 12.35"); XL (18.55", 13.1")

\*Two colored option available for S78 for an extra \$56.00 upcharge list.

**Material overview**

**Metal Colors**

- M1 030 terra grey
- 032 light blue
- 033 light green
- 041 turquoise
- 045 broom yellow
- 059 arctic
- 063 anthracite
- 065 black (RAL 9011)
- 071 sapphire blue (RAL 5003)
- 084 oxblood
- 091 white

**Plastic Colors**

- C4 027 dark red
- 029 dark blue
- 030 light blue
- 033 light green
- 037 traffic red
- 041 turquoise
- 045 broom yellow
- 073 black grey (RAL 7021)
- 078 dolphin grey

**Fabrics**

- S40 Stamskin Top
- S46/S54 Xtreme
- S51 Blazer
- S64 Mover
- S74 Era
- S78 Step/StepMelange
- S79 Trevi D
- S82 Evida

- Mx 060 chrome-plated

**JUMPER Air-Four**  
Four-legged chair with casters.

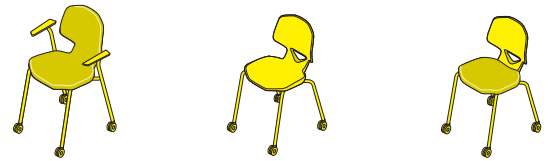

Model	33328*	33320	33321*
<b>Standard price</b>	<b>\$649.00</b>	<b>\$276.00</b>	<b>\$381.00</b>
seat height	18.15	18.15	18.75
seat shell size	XL	L	L
max. number stackable	3	5	5
metal color M1	0.00	0.00	0.00
metal color M060	79.00	50.00	50.00
seat / backrest plastic C4	--	0.00	0.00
hard casters	0.00	0.00	0.00
soft casters	0.00	0.00	0.00
upholstery S40	97.00	--	50.00
upholstery S46/54	0.00	--	0.00
upholstery S51	79.00	--	50.00
upholstery S64	56.00	--	21.00
upholstery S74	0.00	--	0.00
upholstery S78	30.00*	--	15.00*
upholstery S79	68.00	--	24.00
upholstery S82	82.00	--	30.00

- Seat sizes (w, d): S (13.1", 9.6"); M (15.6", 11.25"); L (17.35", 12.35"); XL (18.55", 13.1")

\*Two colored option available for S78 for an extra \$56.00 upcharge list.

**Material overview**

**Metal Colors**

- M1 030 terra grey
- 032 light blue
- 033 light green
- 041 turquoise
- 045 broom yellow
- 059 arctic
- 063 anthracite
- 065 black (RAL 9011)
- 071 sapphire blue (RAL 5003)
- 084 oxblood
- 091 white

**Plastic Colors**

- C4 027 dark red
- 029 dark blue
- 030 light blue
- 033 light green
- 037 traffic red
- 041 turquoise
- 045 broom yellow
- 073 black grey (RAL 7021)
- 078 dolphin grey

**Fabrics**

- S40 Stamskin Top
- S46/S54 Xtreme
- S51 Blazer
- S64 Mover
- S74 Era
- S78 Step/StepMelange
- S79 Trevi D
- S82 Evida

- Mx 060 chrome-plated

**JUMPER Air-Four Plus**  
Four-legged stool.

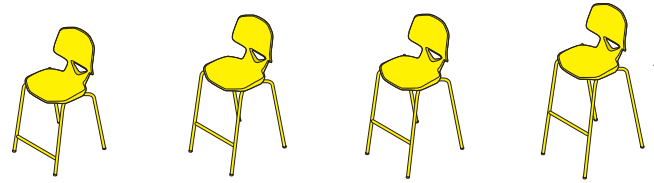

Model	33304	33305	33306	33307
<b>Standard price</b>	<b>\$290.00</b>	<b>\$299.00</b>	<b>\$308.00</b>	<b>\$316.00</b>
seat height	24.05	28.35	29.95	32.7
seat shell size	L	L	L	L
max. number stackable	5	5	5	5
metal color M1	0.00	0.00	0.00	0.00
metal color M060	41.00	47.00	53.00	59.00
seat / backrest plastic C4	0.00	0.00	0.00	0.00
plastic glides	0.00	0.00	0.00	0.00
felt glides	3.00	3.00	3.00	3.00
2-component glides	0.00	0.00	0.00	0.00

- Seat sizes (w, d): S (13.1", 9.6"); M (15.6", 11.25"); L (17.35", 12.35"); XL (18.55", 13.1")

**Material overview**

**Metal Colors**

- M1 030 terra grey
- 032 light blue
- 033 light green
- 041 turquoise
- 045 broom yellow
- 059 arctic
- 063 anthracite
- 065 black (RAL 9011)
- 071 sapphire blue (RAL 5003)
- 084 oxblood
- 091 white

**Plastic Colors**

- C4 027 dark red
- 029 dark blue
- 030 light blue
- 033 light green
- 037 traffic red
- 041 turquoise
- 045 broom yellow
- 073 black grey (RAL 7021)
- 078 dolphin grey

- Mx 060 chrome-plated

\*L seat shell on green dot height,  
XL seat shell on blue dot height

**JUMPER Air-Active  
Cantilever chair.**



Model	33400	33401*	33416
Standard price	\$185.00	\$185.00	\$241.00
seat height 12.25 (No. 2 violet) S	0.00	--	--
seat height 13.8 (No. 3 yellow) S	0.00	--	--
seat height 15 (No. 4 red) M	0.00	--	--
seat height 16.95 (No. 5 green) M	0.00	0.00	--
seat height 18.15 (No. 6 blue) L	0.00	18.00	0.00
seat height 20.1 (No. 7 brown) XL	15.00	--	--
<hr/>			
max. number stackable	5	5	5
<hr/>			
metal color M1	0.00	0.00	0.00
metal color M060	50.00	50.00	50.00
<hr/>			
seat / backrest plastic C4	0.00	0.00	0.00
<hr/>			
plastic glides	0.00	0.00	0.00
felt glides	3.00	3.00	3.00
2-component glides	0.00	0.00	0.00

- Seat sizes (w, d): S (13.1", 9.6"); M (15.6", 11.25"); L (17.35", 12.35"); XL (18.55", 13.1")

**Material overview**

**Metal Colors**

- M1 030 terra grey
- 032 light blue
- 033 light green
- 041 turquoise
- 045 broom yellow
- 059 arctic
- 063 anthracite
- 065 black (RAL 9011)
- 071 sapphire blue (RAL 5003)
- 084 oxblood
- 091 white

**Plastic Colors**

- C4 027 dark red
- 029 dark blue
- 030 light blue
- 033 light green
- 037 traffic red
- 041 turquoise
- 045 broom yellow
- 073 black grey (RAL 7021)
- 078 dolphin grey

- Mx 060 chrome-plated

**JUMPER Air-Active  
Cantilever chair.**

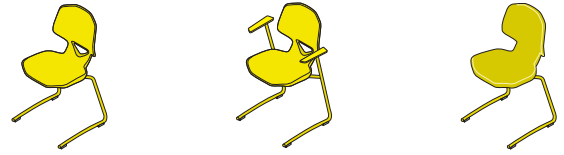

Model	33410*	33413	33412*
<b>Standard price</b>	<b>\$267.00</b>	<b>\$384.00</b>	<b>\$605.00</b>
seat height	18.35	18.35	18.9
seat shell size	XL	XL	XL
max. number stackable	5	3	5
metal color M1	0.00	0.00	0.00
metal color M060	50.00	79.00	50.00
seat / backrest plastic C4	0.00	0.00	--
plastic glides	0.00	0.00	0.00
felt glides	3.00	0.00	0.00
2-component glides	0.00	0.00	0.00
upholstery S40	--	--	135.00
upholstery S46/54	--	--	0.00
upholstery S51	--	--	79.00
upholstery S64	--	--	56.00
upholstery S74	--	--	0.00
upholstery S78	--	--	30.00*
upholstery S79	--	--	68.00
upholstery S82	--	--	82.00

- Seat sizes (w, d): S (13.1", 9.6"); M (15.6", 11.25"); L (17.35", 12.35"); XL (18.55", 13.1")

\*Two colored option available for S78 for an extra \$56.00 upcharge list.

**Material overview**

**Metal Colors**

- M1 030 terra grey
- 032 light blue
- 033 light green
- 041 turquoise
- 045 broom yellow
- 059 arctic
- 063 anthracite
- 065 black (RAL 9011)
- 071 sapphire blue (RAL 5003)
- 084 oxblood
- 091 white

**Plastic Colors**

- C4 027 dark red
- 029 dark blue
- 030 light blue
- 033 light green
- 037 traffic red
- 041 turquoise
- 045 broom yellow
- 073 black grey (RAL 7021)
- 078 dolphin grey

**Fabrics**

- S40 Stamskin Top
- S46/S54 Xtreme
- S51 Blazer
- S64 Mover
- S74 Era
- S78 Step/StepMelange
- S79 Trevi D
- S82 Evida

- Mx 060 chrome-plated

**JUMPER Air-Meet**  
Cantilever chair.

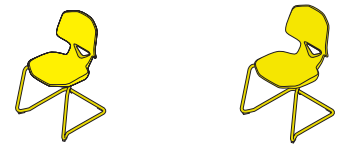

Model	33616	33610
<b>Standard price</b>	<b>\$255.00</b>	<b>\$279.00</b>
seat height	18.6	18.6
seat shell size	L	XL
max. number stackable	5	5
metal color M1	0.00	0.00
metal color M060	50.00	50.00
seat / backrest plastic C4	0.00	0.00
plastic glides	0.00	0.00
felt glides	0.00	0.00
2-component glides	0.00	0.00

- Seat sizes (w, d): S (13.1", 9.6"); M (15.6", 11.25"); L (17.35", 12.35"); XL (18.55", 13.1")

**Material overview**

**Metal Colors**

- M1 030 terra grey
- 032 light blue
- 033 light green
- 041 turquoise
- 045 broom yellow
- 059 arctic
- 063 anthracite
- 065 black (RAL 9011)
- 071 sapphire blue (RAL 5003)
- 084 oxblood
- 091 white

**Plastic Colors**

- C4 027 dark red
- 029 dark blue
- 030 light blue
- 033 light green
- 037 traffic red
- 041 turquoise
- 045 broom yellow
- 073 black grey (RAL 7021)
- 078 dolphin grey

Mx 060 chrome-plated

**JUMPER Air-Meet**  
Cantilever chair.



Model	33613	33612*	33615*
<b>Standard price</b>	<b>\$366.00</b>	<b>\$570.00</b>	<b>\$643.00</b>
seat height	18.6	19.15	19.15
seat shell size	XL	XL	XL
max. number stackable	3	5	3
metal color M1	0.00	0.00	0.00
metal color M060	79.00	50.00	79.00
seat / backrest plastic C4	0.00	--	--
plastic glides	0.00	0.00	0.00
felt glides	0.00	0.00	0.00
2-component glides	0.00	0.00	0.00
upholstery S40	--	135.00	135.00
upholstery S46/54	--	0.00	0.00
upholstery S51	--	79.00	79.00
upholstery S64	--	56.00	56.00
upholstery S74	--	0.00	0.00
upholstery S78	--	30.00*	30.00*
upholstery S79	--	68.00	68.00
upholstery S82	--	82.00	82.00

- Seat sizes (w, d): S (13.1", 9.6"); M (15.6", 11.25"); L (17.35", 12.35"); XL (18.55", 13.1")

\*Two colored option available for S78 for an extra \$56.00 upcharge list.

**Material overview**

**Metal Colors**

- M1 030 terra grey
- 032 light blue
- 033 light green
- 041 turquoise
- 045 broom yellow
- 059 arctic
- 063 anthracite
- 065 black (RAL 9011)
- 071 sapphire blue (RAL 5003)
- 084 oxblood
- 091 white

**Plastic Colors**

- C4 027 dark red
- 029 dark blue
- 030 light blue
- 033 light green
- 037 traffic red
- 041 turquoise
- 045 broom yellow
- 073 black grey (RAL 7021)
- 078 dolphin grey

**Fabrics**

- S40 Stamskin Top
- S46/S54 Xtreme
- S51 Blazer
- S64 Mover
- S74 Era
- S78 Step/StepMelange
- S79 Trevi D
- S82 Evida

- Mx 060 chrome-plated

**JUMPER Air-Move**  
Five star-foot chair.



Model	33501	33502	33506	33537	33526
<b>Standard price</b>	<b>\$398.00</b>	<b>\$392.00</b>	<b>\$451.00</b>	<b>\$448.00</b>	<b>\$576.00</b>
seat height	18.15	13.75 - 17.25	16.5 - 21.35	13.75 - 17.25	19.85 - 29.6
seat shell size	L	M	L	L	L
metal color M1	0.00	0.00	0.00	0.00	0.00
seat / backrest plastic C4	0.00	0.00	0.00	0.00	0.00
plastic glides	0.00	0.00	0.00	0.00	0.00
2-component glides	0.00	0.00	0.00	0.00	0.00
hard casters, height +1	0.00	0.00	0.00	0.00	--
soft casters, height +1	0.00	0.00	0.00	0.00	0.00
height-adjust. foot ring	--	105.00	105.00	--	--
3D rocking	--	0.00	0.00	0.00	0.00
basic non-rocking	--	<b>-37.00</b>	<b>-37.00</b>	<b>-37.00</b>	<b>-37.00</b>

- Seat sizes (w, d): S (13.1", 9.6"); M (15.6", 11.25"); L (17.35", 12.35"); XL (18.55", 13.1")

**Material overview**

**Metal Colors**

- M1 030 terra grey
- 032 light blue
- 033 light green
- 041 turquoise
- 045 broom yellow
- 059 arctic
- 063 anthracite
- 065 black (RAL 9011)
- 071 sapphire blue (RAL 5003)
- 084 oxblood
- 091 white

**Plastic Colors**

- C4 027 dark red
- 029 dark blue
- 030 light blue
- 033 light green
- 037 traffic red
- 041 turquoise
- 045 broom yellow
- 073 black grey (RAL 7021)
- 078 dolphin grey

**JUMPER Air-Move**  
Five star-foot chair.



<b>Model</b>	<b>33503</b>
<b>Standard price</b>	<b>\$416.00</b>
adjustable seat height	16.5 - 21.5
seat shell size	M
<hr/>	
metal color M1	0.00
<hr/>	
seat / backrest plastic C4	0.00
<hr/>	
plastic glides	0.00
2-component glides	0.00
hard casters, height +1	0.00
soft casters, height +1	0.00
load activated braking casters (soft), height +1	24.00
<hr/>	
height-adjust. foot ring	105.00
3D rocking	0.00
basic non-rocking	<b>-37.00</b>

- Seat sizes (w, d): S (13.1", 9.6"); M (15.6", 11.25"); L (17.35", 12.35"); XL (18.55", 13.1")

**Material overview**

**Metal Colors**

M1	030	terra grey
	032	light blue
	033	light green
	041	turquoise
	045	broom yellow
	059	arctic
	063	anthracite
	065	black (RAL 9011)
	071	sapphire blue (RAL 5003)
	084	oxblood
	091	white

**Plastic Colors**

C4	027	dark red
	029	dark blue
	030	light blue
	033	light green
	037	traffic red
	041	turquoise
	045	broom yellow
	073	black grey (RAL 7021)
	078	dolphin grey

**JUMPER Air-Move**  
Five star-foot chair.



<b>Model</b>	<b>33510</b>
<b>Standard price</b>	<b>\$486.00</b>
adjustable seat height	17.6 - 22.6
seat shell size	XL
metal color M1	0.00
metal color alu highly polished	44.00
metal color M060	394.00
seat / backrest plastic C4	0.00
plastic glides	0.00
2-component glides	0.00
hard casters, height +1	0.00
soft casters, height +1	0.00
3D rocking	0.00
basic non-rocking	<b>-37.00</b>

- Seat sizes (w, d): S (13.1", 9.6"); M (15.6", 11.25"); L (17.35", 12.35"); XL (18.55", 13.1")

**Material overview**

**Metal Colors**

- M1 030 terra grey
- 032 light blue
- 033 light green
- 041 turquoise
- 045 broom yellow
- 059 arctic
- 063 anthracite
- 065 black (RAL 9011)
- 071 sapphire blue (RAL 5003)
- 084 oxblood
- 091 white

**Plastic Colors**

- C4 027 dark red
- 029 dark blue
- 030 light blue
- 033 light green
- 037 traffic red
- 041 turquoise
- 045 broom yellow
- 073 black grey (RAL 7021)
- 078 dolphin grey

- Mx 049 high polished aluminum
- 060 chrome-plated

**JUMPER Air-Move**  
Five star-foot chair.



Model	33513	33512*	33515*
<b>Standard price</b>	<b>\$579.00</b>	<b>\$736.00</b>	<b>\$841.00</b>
adjustable seat height	17.6 - 22.6	18.15 - 23.2	18.15 - 23.2
seat shell size	XL	XL	XL
metal color M1	0.00	0.00	0.00
metal color alu highly polished	44.00	44.00	44.00
metal color M060	394.00	394.00	394.00
seat / backrest plastic C4	0.00	--	--
plastic glides	0.00	0.00	0.00
felt glides	0.00	0.00	0.00
2-component glides	0.00	0.00	0.00
hard casters, height +1	0.00	0.00	0.00
soft casters, height +1	0.00	0.00	0.00
height-adjust. foot ring	--	--	--
3D rocking	0.00	0.00	0.00
basic non-rocking	<b>-37.00</b>	<b>-37.00</b>	<b>-37.00</b>
upholstery S40	--	135.00	135.00
upholstery S46/54	--	0.00	0.00
upholstery S51	--	79.00	79.00
upholstery S64	--	56.00	56.00
upholstery S74	--	0.00	0.00
upholstery S78	--	30.00*	30.00*
upholstery S79	--	68.00	68.00
upholstery S82	--	82.00	82.00

- Seat sizes (w, d): S (13.1", 9.6"); M (15.6", 11.25"); L (17.35", 12.35"); XL (18.55", 13.1")

\*Two colored option available for S78 for an extra \$56.00 upcharge list.

**Material overview**

**Metal Colors**

- M1 030 terra grey
- 032 light blue
- 033 light green
- 041 turquoise
- 045 broom yellow
- 059 arctic
- 063 anthracite
- 065 black (RAL 9011)
- 071 sapphire blue (RAL 5003)
- 084 oxblood
- 091 white

**Plastic Colors**

- C4 027 dark red
- 029 dark blue
- 030 light blue
- 033 light green
- 037 traffic red
- 041 turquoise
- 045 broom yellow
- 073 black grey (RAL 7021)
- 078 dolphin grey

**Fabrics**

- S40 Stamskin Top
- S46/S54 Xtreme
- S51 Blazer
- S64 Mover
- S74 Era
- S78 Step/StepMelange
- S79 Trevi D
- S82 Evida

- Mx 049 high polished aluminum
- 060 chrome-plated

**JUMPER Air-Move**  
Five star-foot chair.



<b>Model</b>	<b>33520</b>
<b>Standard price</b>	<b>\$599.00</b>
adjustable seat height	20.9 - 30.75
seat shell size	XL
<hr/>	
metal color M1	0.00
metal color alu highly polished	44.00
metal color M060	394.00
<hr/>	
seat / backrest plastic C4	0.00
<hr/>	
plastic glides	0.00
2-component glides	0.00
hard casters, height +1	--
soft casters, height +1	0.00
<hr/>	
3D rocking	0.00
basic non-rocking	<b>-37.00</b>

- Seat sizes (w, d): S (13.1", 9.6"); M (15.6", 11.25"); L (17.35", 12.35"); XL (18.55", 13.1")

**Material overview**

**Metal Colors**

- M1 030 terra grey
- 032 light blue
- 033 light green
- 041 turquoise
- 045 broom yellow
- 059 arctic
- 063 anthracite
- 065 black (RAL 9011)
- 071 sapphire blue (RAL 5003)
- 084 oxblood
- 091 white

**Plastic Colors**

- C4 027 dark red
- 029 dark blue
- 030 light blue
- 033 light green
- 037 traffic red
- 041 turquoise
- 045 broom yellow
- 073 black grey (RAL 7021)
- 078 dolphin grey

- Mx 049 high polished aluminum
- 060 chrome-plated

**JUMPER Air-Move**  
Five star-foot chair.



Model	33523	33522*	33525*
<b>Standard price</b>	<b>\$684.00</b>	<b>\$876.00</b>	<b>\$970.00</b>
adjustable seat height	20.9 -30.75	21.5 -31.3	21.5 -31.25
seat shell size	XL	XL	XL
metal color M1	0.00	0.00	0.00
metal color alu highly polished	44.00	44.00	44.00
metal color M060	394.00	394.00	394.00
seat / backrest plastic C4	0.00	--	--
plastic glides	0.00	0.00	0.00
felt glides	0.00	0.00	0.00
2-component glides	0.00	0.00	0.00
hard casters, height +1	--	--	--
soft casters, height +1	0.00	0.00	0.00
height-adjust. foot ring	0.00	0.00	0.00
3D rocking	0.00	0.00	0.00
basic non-rocking	<b>-37.00</b>	<b>-37.00</b>	<b>-37.00</b>
upholstery S40	--	135.00	135.00
upholstery S46/54	--	0.00	0.00
upholstery S51	--	79.00	79.00
upholstery S64	--	56.00	56.00
upholstery S74	--	0.00	0.00
upholstery S78	--	30.00*	30.00*
upholstery S79	--	68.00	68.00
upholstery S82	--	82.00	82.00

- Seat sizes (w, d): S (13.1", 9.6"); M (15.6", 11.25"); L (17.35", 12.35"); XL (18.55", 13.1")

\*Two colored option available for S78 for an extra \$56.00 upcharge list.

**Material overview**

**Metal Colors**

- M1 030 terra grey
- 032 light blue
- 033 light green
- 041 turquoise
- 045 broom yellow
- 059 arctic
- 063 anthracite
- 065 black (RAL 9011)
- 071 sapphire blue (RAL 5003)
- 084 oxblood
- 091 white

**Plastic Colors**

- C4 027 dark red
- 029 dark blue
- 030 light blue
- 033 light green
- 037 traffic red
- 041 turquoise
- 045 broom yellow
- 073 black grey (RAL 7021)
- 078 dolphin grey

**Fabrics**

- S40 Stamskin Top
- S46/S54 Xtreme
- S51 Blazer
- S64 Mover
- S74 Era
- S78 Step/StepMelange
- S79 Trevi D
- S82 Evida

- Mx 049 high polished aluminum
- 060 chrome-plated

**JUMPER Air Move**  
College chair with tray.

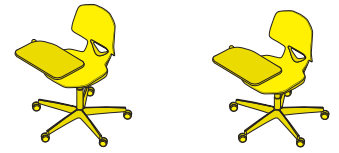

Model	33530	33533
<b>Standard price</b>	<b>\$655.00</b>	<b>\$701.00</b>
seat height	18.15	16.25 - 19.75
seat shell size	L	L
metal color M1	0.00	0.00
seat / backrest plastic C4	0.00	0.00
tablet made of white CDF with black rounded edge, left or right	0.00	0.00
plastic glides	0.00	0.00
2-component glides	0.00	0.00
hard casters, height +1	0.00	0.00
soft casters, height +1	0.00	0.00
3D rocking	--	0.00
basic non-rocking	--	<b>-37.00</b>

- Seat sizes (w, d): S (13.1", 9.6"); M (15.6", 11.25"); L (17.35", 12.35"); XL (18.55", 13.1")

**Material overview**

**Metal Colors**

M1	030	terra grey
	032	light blue
	033	light green
	041	turquoise
	045	broom yellow
	059	arctic
	063	anthracite
	065	black (RAL 9011)
	071	sapphire blue (RAL 5003)
	084	oxblood
	091	white

**Plastic Colors**

C4	027	dark red
	029	dark blue
	030	light blue
	033	light green
	037	traffic red
	041	turquoise
	045	broom yellow
	073	black grey (RAL 7021)
	078	dolphin grey

**JUMPER Air Stool**  
Four-legged stool.



Model	33700	33702
<b>Standard price</b>	<b>\$141.00</b>	<b>\$168.00</b>
seat height 13.8 (No. 3 yellow)	0.00	--
seat height 15 (No. 4 red)	0.00	--
seat height 16.95 (No. 5 green)	0.00	--
seat height 18.15 (No. 6 blue)	0.00	0.00
seat height 20.1 (No. 7 brown)	0.00	--
max. number stackable	10	10
metal color M1	0.00	0.00
metal color M060	35.00	18.00
seat / backrest plastic C4	0.00	0.00
plastic glides	0.00	--
felt glides	0.00	--
2-component glides	0.00	--
hard casters	--	0.00
soft casters	--	0.00

- Seat sizes (w, d): (13.4", 13.4")

**Material overview**

**Metal Colors**

- M1 030 terra grey
- 032 light blue
- 033 light green
- 041 turquoise
- 045 broom yellow
- 059 arctic
- 063 anthracite
- 065 black (RAL 9011)
- 071 sapphire blue (RAL 5003)
- 084 oxblood
- 091 white

**Plastic Colors**

- C4 027 dark red
- 029 dark blue
- 030 light blue
- 033 light green
- 037 traffic red
- 041 turquoise
- 045 broom yellow
- 073 black grey (RAL 7021)
- 078 dolphin grey

- Mx 060 chrome-plated

**JUMPER Air Stool**  
Stool with five-star foot.



<b>Model</b>	<b>33714</b>
<b>Standard price</b>	<b>\$200.00</b>
seat height	15.4 - 20.4
metal color M1	0.00
seat / backrest plastic C4	0.00
plastic glides	0.00
felt glides	0.00
2-component glides	0.00
hard casters, height +1	0.00
soft casters, height +1	0.00

- Seat sizes (w, d): (13.4", 13.4")

**Material overview**

**Metal Colors**

M1	030	terra grey
	032	light blue
	033	light green
	041	turquoise
	045	broom yellow
	059	arctic
	063	anthracite
	065	black (RAL 9011)
	071	sapphire blue (RAL 5003)
	084	oxblood
	091	white

**Plastic Colors**

C4	027	dark red
	029	dark blue
	030	light blue
	033	light green
	037	traffic red
	041	turquoise
	045	broom yellow
	073	black grey (RAL 7021)
	078	dolphin grey

**JUMPER Air Stool Plus**  
Four-legged stool.



Model	33704	33706	33708	33710	33712
<b>Standard price</b>	<b>\$174.00</b>	<b>\$176.00</b>	<b>\$179.00</b>	<b>\$182.00</b>	<b>\$182.00</b>
seat height	24.05	28.35	29.95	31.15	32.7
distance of seat to foot support	18.15	18.15	18.15	18.15	18.15
max. number stackable	7	7	7	7	7
metal color M1	0.00	0.00	0.00	0.00	0.00
metal color M060	30.00	41.00	82.00	82.00	82.00
seat / backrest plastic C4	0.00	0.00	0.00	0.00	0.00
plastic glides	0.00	0.00	0.00	0.00	0.00
felt glides	0.00	0.00	0.00	0.00	0.00
2-component glides	0.00	0.00	0.00	0.00	0.00

- Seat sizes (w, d): (13.4", 13.4")

**Material overview**

**Metal Colors**

- M1 030 terra grey
- 032 light blue
- 033 light green
- 041 turquoise
- 045 broom yellow
- 059 arctic
- 063 anthracite
- 065 black (RAL 9011)
- 071 sapphire blue (RAL 5003)
- 084 oxblood
- 091 white

**Plastic Colors**

- C4 027 dark red
- 029 dark blue
- 030 light blue
- 033 light green
- 037 traffic red
- 041 turquoise
- 045 broom yellow
- 073 black grey (RAL 7021)
- 078 dolphin grey

- Mx 060 chrome-plated

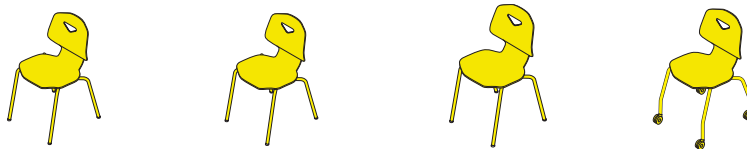
**JUMPER Ply-Four**  
 Four-legged chair.

Model	33350	33366	33360*	33369
<b>Standard price</b>	<b>\$296.00</b>	<b>\$296.00</b>	<b>\$299.00</b>	<b>\$392.00</b>
seat height 12.25 (No. 2 violet) S	0.00	--	--	0.00
seat height 13.8 (No. 3 yellow) S	0.00	--	--	0.00
seat height 15 (No. 4 red) M	0.00	--	--	0.00
seat height 16.95 (No. 5 green) M	0.00	--	--	0.00
seat height 18.15 (No. 6 blue) L	0.00	0.00	0.00	0.00
seat height 20.1 (No. 7 brown) XL	15.00	--	--	15.00
max. number stackable	5	5	5	5
metal color M1	0.00	0.00	0.00	0.00
metal color M060	50.00	50.00	50.00	50.00
wooden parts seat / backrest 010 natural beech	0.00	0.00	0.00	0.00
wooden parts seat / backrest H1	18.00	18.00	18.00	18.00
wooden parts seat / backrest oak veneer	--	103.00	103.00	103.00
plastic glides	0.00	0.00	0.00	--
felt glides	0.00	0.00	0.00	--
2-component glides	0.00	0.00	0.00	--
hard casters	--	--	--	0.00
soft casters	--	--	--	0.00

\*XL seat shell on blue dot height

**Material overview**
**Metal Colors**

M1	030	terra grey
	032	light blue
	033	light green
	041	turquoise
	045	broom yellow
	059	arctic
	063	anthracite
	065	black (RAL 9011)
	071	sapphire blue (RAL 5003)
	084	oxblood
	091	white

**Wood Colors**

H1	011	black
	021	light green
	022	light blue
	023	light grey
	027	dark red
	029	dark blue
	037	traffic red
	041	turquoise
	045	broom yellow
	051	polar white

Mx 060 chrome-plated

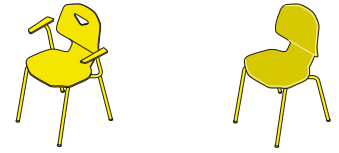
**JUMPER Ply-Four**  
 Four-legged chair.

Model	33363	33362
<b>Standard price</b>	<b>\$410.00</b>	<b>\$526.00</b>
seat height	18.15	18.75
seat shell size	XL	XL
max. number stackable	3	5
metal color M1	0.00	0.00
metal color M060	79.00	50.00
wooden parts seat / backrest 010 natural beech	0.00	--
wooden parts seat / backrest H1	18.00	--
wooden parts seat / backrest oak veneer	103.00	--
plastic glides	0.00	0.00
felt glides	0.00	0.00
2-component glides	0.00	0.00
upholstery S40	--	135.00
upholstery S46/54	--	0.00
upholstery S51	--	79.00
upholstery S64	--	56.00
upholstery S74	--	0.00
upholstery S78	--	30.00*
upholstery S79	--	68.00
upholstery S82	--	82.00

\*Two colored option available for S78 for an extra \$56.00 upcharge list.

**Material overview**
**Metal Colors**

M1	030	terra grey
	032	light blue
	033	light green
	041	turquoise
	045	broom yellow
	059	arctic
	063	anthracite
	065	black (RAL 9011)
	071	sapphire blue (RAL 5003)
	084	oxblood
	091	white

**Wood Colors**

H1	011	black
	021	light green
	022	light blue
	023	light grey
	027	dark red
	029	dark blue
	037	traffic red
	041	turquoise
	045	broom yellow
	051	polar white

**Fabrics**

S40	Stamskin Top
S46/S54	Xtreme
S51	Blazer
S64	Mover
S74	Era
S78	Step/StepMelange
S79	Trevi D
S82	Evida

Mx 060 chrome-plated

**JUMPER Ply-Four**  
Four-legged chair with casters.

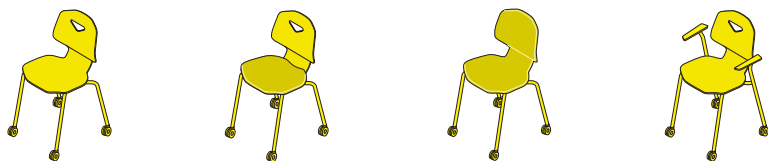

Model	33373	33374	33375*	33376
<b>Standard price</b>	<b>\$410.00</b>	<b>\$570.00</b>	<b>\$629.00</b>	<b>\$456.00</b>
seat height	18.15	18.15	18.15	18.15
seat shell size	XL	XL	XL	XL
max. number stackable	5	5	5	3
metal color M1	0.00	0.00	0.00	0.00
metal color M060	50.00	50.00	50.00	79.00
wooden parts seat / backrest 010 natural beech	0.00	0.00	--	0.00
wooden parts seat / backrest H1	18.00	18.00	--	18.00
wooden parts seat / backrest oak veneer	103.00	103.00	--	103.00
hard casters	0.00	0.00	0.00	0.00
soft casters	0.00	0.00	0.00	0.00
upholstery S40	--	50.00	97.00	--
upholstery S46/54	--	0.00	0.00	--
upholstery S51	--	50.00	79.00	--
upholstery S64	--	18.00	56.00	--
upholstery S74	--	0.00	0.00	--
upholstery S78	--	6.00	30.00*	--
upholstery S79	--	24.00	68.00	--
upholstery S82	--	35.00	82.00	--

\*Two colored option available for S78 for an extra \$56.00 upcharge list.

**Material overview**

**Metal Colors**

M1 030	terra grey
032	light blue
033	light green
041	turquoise
045	broom yellow
059	arctic
063	anthracite
065	black (RAL 9011)
071	sapphire blue (RAL 5003)
084	oxblood
091	white

**Wood Colors**

H1 011	black
021	light green
022	light blue
023	light grey
027	dark red
029	dark blue
037	traffic red
041	turquoise
045	broom yellow
051	polar white

**Fabrics**

S40	Stamskin Top
S46/S54	Xtreme
S51	Blazer
S64	Mover
S74	Era
S78	Step/StepMelange
S79	Trevi D
S82	Evida

Mx 060 chrome-plated

**JUMPER Ply-Four**  
Four-legged chair with casters.



Model	33377	33378*	33370
<b>Standard price</b>	<b>\$561.00</b>	<b>\$672.00</b>	<b>\$410.00</b>
seat height	18.15	18.15	18.15
seat shell size	XL	XL	XL
max. number stackable	3	3	5
metal color M1	0.00	0.00	0.00
metal color M060	79.00	79.00	50.00
wooden parts seat / backrest 010 natural beech	0.00	--	0.00
wooden parts seat / backrest H1	18.00	--	18.00
wooden parts seat / backrest oak veneer	103.00	--	103.00
hard casters	0.00	0.00	0.00
soft casters	0.00	0.00	0.00
upholstery S40	50.00	97.00	--
upholstery S46/54	0.00	0.00	--
upholstery S51	50.00	73.00	--
upholstery S64	18.00	56.00	--
upholstery S74	0.00	0.00	--
upholstery S78	6.00	30.00*	--
upholstery S79	24.00	68.00	--
upholstery S82	35.00	82.00	--

\*Two colored option available for S78 for an extra \$56.00 upcharge list.

**Material overview**

**Metal Colors**

- M1 030 terra grey
- 032 light blue
- 033 light green
- 041 turquoise
- 045 broom yellow
- 059 arctic
- 063 anthracite
- 065 black (RAL 9011)
- 071 sapphire blue (RAL 5003)
- 084 oxblood
- 091 white

**Wood Colors**

- H1 011 black
- 021 light green
- 022 light blue
- 023 light grey
- 027 dark red
- 029 dark blue
- 037 traffic red
- 041 turquoise
- 045 broom yellow
- 051 polar white

**Fabrics**

- S40 Stamskin Top
- S46/S54 Xtreme
- S51 Blazer
- S64 Mover
- S74 Era
- S78 Step/StepMelange
- S79 Trevi D
- S82 Evida

Mx 060 chrome-plated

**JUMPER Ply-Four Plus**  
Four-legged chair for high sitting.

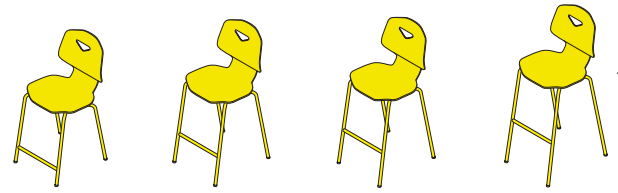

Model	33354	33355	33356	33357
<b>Standard price</b>	<b>\$389.00</b>	<b>\$398.00</b>	<b>\$407.00</b>	<b>\$416.00</b>
seat height	24.05	28.35	29.95	32.7
seat shell size	L	L	L	L
max. number stackable	5	5	5	5
metal color M1	0.00	0.00	0.00	0.00
metal color M060	41.00	47.00	53.00	62.00
wooden parts seat / backrest 010 natural beech	0.00	0.00	0.00	0.00
wooden parts seat / backrest H1	18.00	18.00	18.00	18.00
wooden parts seat / backrest oak veneer	103.00	103.00	103.00	103.00
plastic glides	0.00	0.00	0.00	0.00
felt glides	3.00	3.00	3.00	3.00
2-component glides	0.00	0.00	0.00	0.00

**Material overview**

**Metal Colors**

M1 030	terra grey
032	light blue
033	light green
041	turquoise
045	broom yellow
059	arctic
063	anthracite
065	black (RAL 9011)
071	sapphire blue (RAL 5003)
084	oxblood
091	white

**Wood Colors**

H1 011	black
021	light green
022	light blue
023	light grey
027	dark red
029	dark blue
037	traffic red
041	turquoise
045	broom yellow
051	polar white

Mx 060 chrome-plated

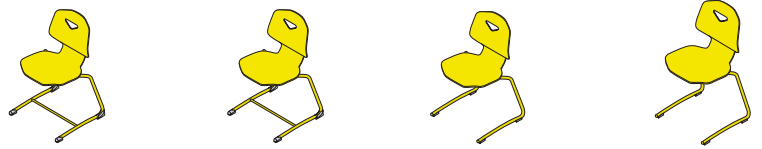
**JUMPER Ply-Active  
Cantilever chair.**

<b>Model</b>	<b>33450</b>	<b>33451*</b>	<b>33466</b>	<b>33460*</b>
<b>Standard price</b>	<b>\$302.00</b>	<b>\$331.00</b>	<b>\$325.00</b>	<b>\$325.00</b>
seat height 12.25 (No. 2 violet) S	0.00	--	--	--
seat height 13.8 (No. 3 yellow) S	0.00	--	--	--
seat height 15 (No. 4 red) M	0.00	--	--	--
seat height 16.95 (No. 5 green) M	0.00	0.00	--	--
seat height 18.15 (No. 6 blue) L	0.00	0.00	0.00	0.00
seat height 20.1 (No. 7 brown) XL	15.00	--	--	--
max. number stackable	5	5	5	5
metal color M1	0.00	0.00	0.00	0.00
metal color M060	50.00	50.00	50.00	50.00
wooden parts seat / backrest 010 natural beech	0.00	0.00	0.00	0.00
wooden parts seat / backrest H1	18.00	18.00	18.00	18.00
wooden parts seat / backrest oak veneer	--	103.00	103.00	103.00
plastic glides	0.00	0.00	0.00	0.00
felt glides	3.00	3.00	3.00	3.00
2-component glides	0.00	0.00	0.00	0.00

\*L seat shell on green dot height, XL seat shell on blue dot height

**Material overview**
**Metal Colors**

M1 030	terra grey
032	light blue
033	light green
041	turquoise
045	broom yellow
059	arctic
063	anthracite
065	black (RAL 9011)
071	sapphire blue (RAL 5003)
084	oxblood
091	white

**Wood Colors**

H1 011	black
021	light green
022	light blue
023	light grey
027	dark red
029	dark blue
037	traffic red
041	turquoise
045	broom yellow
051	polar white

Mx 060 chrome-plated

**JUMPER Ply-Active**  
Cantilever chair.

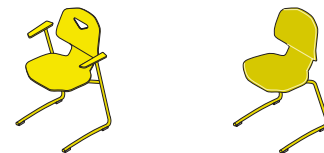

Model	33463	33462
<b>Standard price</b>	<b>\$410.00</b>	<b>\$535.00</b>
seat height	18.35	18.9
seat shell size	XL	XL
max. number stackable	3	5
metal color M1	0.00	0.00
metal color M060	79.00	50.00
wooden parts seat / backrest 010 natural beech	0.00	--
wooden parts seat / backrest H1	18.00	--
wooden parts seat / backrest oak veneer	103.00	--
plastic glides	0.00	0.00
felt glides	3.00	3.00
2-component glides	0.00	0.00
upholstery S40	--	135.00
upholstery S46/54	--	0.00
upholstery S51	--	79.00
upholstery S64	--	56.00
upholstery S74	--	0.00
upholstery S78	--	30.00*
upholstery S79	--	68.00
upholstery S82	--	82.00

\*Two colored option available for S78 for an extra \$56.00 upcharge list.

**Material overview**

**Metal Colors**

M1	030	terra grey
	032	light blue
	033	light green
	041	turquoise
	045	broom yellow
	059	arctic
	063	anthracite
	065	black (RAL 9011)
	071	sapphire blue (RAL 5003)
	084	oxblood
	091	white

**Wood Colors**

H1	011	black
	021	light green
	022	light blue
	023	light grey
	027	dark red
	029	dark blue
	037	traffic red
	041	turquoise
	045	broom yellow
	051	polar white

**Fabrics**

S40	Stamskin Top
S46/S54	Xtreme
S51	Blazer
S64	Mover
S74	Era
S78	Step/StepMelange
S79	Trevi D
S82	Evida

Mx 060 chrome-plated

**JUMPER Ply-Meet**  
Cantilever chair.

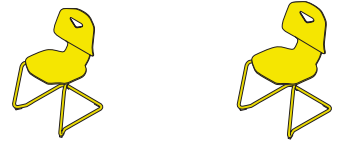

Model	33666	33660*
<b>Standard price</b>	<b>\$363.00</b>	<b>\$363.00</b>
seat height 12.25 (No. 2 violet) S	--	--
seat height 13.38 (No. 3 yellow) S	--	--
seat height 15 (No. 4 red) M	--	--
seat height 17 (No. 5 green) M	--	--
seat height 18.15 (No. 6 blue) L	0.00	0.00
seat height 20.13 (No. 7 brown) XL	--	--
<hr/>		
max. number stackable	5	5
<hr/>		
metal color M1	0.00	0.00
metal color M060	50.00	50.00
<hr/>		
wooden parts seat / backrest 010 natural beech	0.00	0.00
wooden parts seat / backrest H1	18.00	18.00
wooden parts seat / backrest oak veneer	103.00	103.00
<hr/>		
plastic glides	0.00	0.00
felt glides	0.00	3.00
2-component glides	0.00	0.00

\*XL seat shell on blue dot height

**Material overview**

**Metal Colors**

- M1 030 terra grey
- 032 light blue
- 033 light green
- 041 turquoise
- 045 broom yellow
- 059 arctic
- 063 anthracite
- 065 black (RAL 9011)
- 071 sapphire blue (RAL 5003)
- 084 oxblood
- 091 white

**Wood Colors**

- H1 011 black
- 021 light green
- 022 light blue
- 023 light grey
- 027 dark red
- 029 dark blue
- 037 traffic red
- 041 turquoise
- 045 broom yellow
- 051 polar white

- Mx 060 chrome-plated

**JUMPER Ply-Move**  
Star-foot chair.



Kiga

Model	33552	33556	33587	33576
<b>Standard price</b>	<b>\$468.00</b>	<b>\$509.00</b>	<b>\$526.00</b>	<b>\$672.00</b>
seat height	13.1 - 17.05	16.35 - 22.35	13.15 - 17.15	20 - 30.75
seat shell size	M	L	L	L
metal color M1	0.00	0.00	0.00	0.00
wooden parts seat / backrest 010 natural beech	0.00	0.00	0.00	0.00
wooden parts seat / backrest H1	18.00	18.00	18.00	18.00
wooden parts seat / backrest oak veneer	--	--	--	--
plastic glides	0.00	0.00	0.00	0.00
2-component glides	0.00	0.00	0.00	0.00
felt glides	0.00	0.00	0.00	0.00
hard casters, height +1	0.00	0.00	0.00	0.00
soft casters, height +1	0.00	0.00	0.00	0.00
height-adjust. foot ring	105.00	105.00	--	--
3D rocking	0.00	0.00	0.00	0.00
basic non-rocking	<b>-37.00</b>	<b>-37.00</b>	<b>-37.00</b>	<b>-37.00</b>

**Material overview**

**Metal Colors**

- M1 030 terra grey
- 032 light blue
- 033 light green
- 041 turquoise
- 045 broom yellow
- 059 arctic
- 063 anthracite
- 065 black (RAL 9011)
- 071 sapphire blue (RAL 5003)
- 084 oxblood
- 091 white

**Wood Colors**

- H1 011 black
- 021 light green
- 022 light blue
- 023 light grey
- 027 dark red
- 029 dark blue
- 037 traffic red
- 041 turquoise
- 045 broom yellow
- 051 polar white

**JUMPER Ply-Move**  
Star-foot chair.



<b>Model</b>	<b>33553</b>
<b>Standard price</b>	<b>\$515.00</b>
adjustable seat height	16.45 - 22.45
seat shell size	M
<hr/>	
metal color M1	0.00
<hr/>	
wooden parts seat / backrest 010 natural beech	0.00
wooden parts seat / backrest H1	18.00
wooden parts seat / backrest oak veneer	--
<hr/>	
plastic glides	0.00
2-component glides	0.00
felt glides	0.00
hard casters, height +1	0.00
soft casters, height +1	0.00
load activated braking casters (soft), height +1	21.00
<hr/>	
height-adjust. foot ring	105.00
3D rocking	0.00
basic non-rocking	<b>-37.00</b>

**Material overview**

**Metal Colors**

M1	030	terra grey
	032	light blue
	033	light green
	041	turquoise
	045	broom yellow
	059	arctic
	063	anthracite
	065	black (RAL 9011)
	071	sapphire blue (RAL 5003)
	084	oxblood
	091	white

**Wood Colors**

H1	011	black
	021	light green
	022	light blue
	023	light grey
	027	dark red
	029	dark blue
	037	traffic red
	041	turquoise
	045	broom yellow
	051	polar white

**JUMPER Ply-Move**  
Star-foot chair.



<b>Model</b>	<b>33560</b>
<b>Standard price</b>	<b>\$532.00</b>
adjustable seat height	17.75 - 23.75
seat shell size	XL
<hr/>	
metal color M1	0.00
metal color alu highly polished	44.00
metal color M060	394.00
<hr/>	
wooden parts seat / backrest 010 natural beech	0.00
wooden parts seat / backrest H1	18.00
wooden parts seat / backrest oak veneer	--
<hr/>	
plastic glides	0.00
2-component glides	0.00
felt glides	0.00
hard casters, height +1	0.00
soft casters, height +1	0.00
<hr/>	
3D rocking	0.00
basic non-rocking	<b>-37.00</b>

**Material overview**

**Metal Colors**

M1	030	terra grey
	032	light blue
	033	light green
	041	turquoise
	045	broom yellow
	059	arctic
	063	anthracite
	065	black (RAL 9011)
	071	sapphire blue (RAL 5003)
	084	oxblood
	091	white

**Wood Colors**

H1	011	black
	021	light green
	022	light blue
	023	light grey
	027	dark red
	029	dark blue
	037	traffic red
	041	turquoise
	045	broom yellow
	051	polar white

Mx	049	high polished aluminum
	060	chrome-plated

**JUMPER Ply-Move**  
Star-foot chair.



<b>Model</b>	<b>33563</b>
<b>Standard price</b>	<b>\$614.00</b>
adjustable seat height	17.75 - 23.75
seat shell size	XL
metal color M1	0.00
metal color alu highly polished	44.00
metal color M060	394.00
wooden parts seat / backrest 010 natural beech	0.00
wooden parts seat / backrest H1	18.00
wooden parts seat / backrest oak veneer	--
plastic glides	0.00
2-component glides	0.00
felt glides	0.00
hard casters, height +1	0.00
soft casters, height +1	0.00
height-adjust. foot ring	--
3D rocking	0.00
basic non-rocking	<b>-37.00</b>

**Material overview**

**Metal Colors**

M1	030	terra grey
	032	light blue
	033	light green
	041	turquoise
	045	broom yellow
	059	arctic
	063	anthracite
	065	black (RAL 9011)
	071	sapphire blue (RAL 5003)
	084	oxblood
	091	white

**Wood Colors**

H1	011	black
	021	light green
	022	light blue
	023	light grey
	027	dark red
	029	dark blue
	037	traffic red
	041	turquoise
	045	broom yellow
	051	polar white

Mx	049	high polished aluminum
	060	chrome-plated

**JUMPER Ply-Move**  
Star-foot chair.



<b>Model</b>	<b>33570</b>
<b>Standard price</b>	<b>\$658.00</b>
adjustable seat height	21.3 - 32.05
seat shell size	XL
metal color M1	0.00
metal color alu highly polished	44.00
metal color M060	394.00
wooden parts seat / backrest 010 natural beech	0.00
wooden parts seat / backrest H1	18.00
wooden parts seat / backrest oak veneer	--
plastic glides	0.00
2-component glides	0.00
felt glides	0.00
hard casters, height +1	0.00
soft casters, height +1	0.00
3D rocking	0.00
basic non-rocking	<b>-37.00</b>

**Material overview**

**Metal Colors**

M1	030	terra grey
	032	light blue
	033	light green
	041	turquoise
	045	broom yellow
	059	arctic
	063	anthracite
	065	black (RAL 9011)
	071	sapphire blue (RAL 5003)
	084	oxblood
	091	white

**Wood Colors**

H1	011	black
	021	light green
	022	light blue
	023	light grey
	027	dark red
	029	dark blue
	037	traffic red
	041	turquoise
	045	broom yellow
	051	polar white

Mx	049	high polished aluminum
	060	chrome-plated



**JUMPER Ply-Move**  
Star-foot chair.

<b>Model</b>	<b>33573</b>
<b>Standard price</b>	<b>\$774.00</b>
adjustable seat height	21.3 - 32.05
seat shell size	XL
<hr/>	
metal color M1	0.00
metal color alu highly polished	44.00
metal color M060	394.00
<hr/>	
wooden parts seat / backrest 010 natural beech	0.00
wooden parts seat / backrest H1	18.00
wooden parts seat / backrest oak veneer	--
<hr/>	
plastic glides	0.00
2-component glides	0.00
felt glides	0.00
hard casters, height +1	--
soft casters, height +1	0.00
<hr/>	
height-adjust. foot ring	0.00
3D rocking	0.00
basic non-rocking	<b>-37.00</b>

**Material overview**

**Metal Colors**

M1	030	terra grey
	032	light blue
	033	light green
	041	turquoise
	045	broom yellow
	059	arctic
	063	anthracite
	065	black (RAL 9011)
	071	sapphire blue (RAL 5003)
	084	oxblood
	091	white

**Wood Colors**

H1	011	black
	021	light green
	022	light blue
	023	light grey
	027	dark red
	029	dark blue
	037	traffic red
	041	turquoise
	045	broom yellow
	051	polar white

Mx	049	high polished aluminum
	060	chrome-plated

**JUMPER Ply Stool**  
 Four-legged stool.

Model	33750	33752
<b>Standard price</b>	<b>\$194.00</b>	<b>\$238.00</b>
seat height 13.8 (No. 3 yellow)	0.00	--
seat height 15 (No. 4 red)	0.00	--
seat height 16.95 (No. 5 green)	0.00	--
seat height 18.15 (No. 6 blue)	0.00	0.00
seat height 20.1 (No. 7 brown)	0.00	--
max. number stackable	10	10
metal color M1	0.00	0.00
metal color M060	41.00	24.00
wooden parts seat / backrest 010 natural	0.00	0.00
wooden parts seat / backrest H1	18.00	18.00
wooden parts seat / backrest oak veneer	59.00	59.00
plastic glides	0.00	--
felt glides	0.00	--
2-component glides	0.00	--
hard casters, height +1	--	0.00
soft casters, height +1	--	0.00

- Seat sizes (w, d): (13.4", 13.4")

**Material overview**
**Metal Colors**

M1 030	terra grey
032	light blue
033	light green
041	turquoise
045	broom yellow
059	arctic
063	anthracite
065	black (RAL 9011)
071	sapphire blue (RAL 5003)
084	oxblood
091	white

**Wood Colors**

H1 011	black
021	light green
022	light blue
023	light grey
027	dark red
029	dark blue
037	traffic red
041	turquoise
045	broom yellow
051	polar white

Mx 060 chrome-plated

**JUMPER Ply Stool**  
Four-legged stool.



Model	33751	33753
<b>Standard price</b>	<b>\$314.00</b>	<b>\$354.00</b>
seat height 18.15 (No. 6 blue)	0.00	0.00
seat height 20.1 (No. 7 brown)	0.00	--
max. number stackable	10	10
metal color M1	0.00	0.00
metal color M060	41.00	41.00
plastic glides	0.00	--
felt glides	0.00	--
2-component glides	0.00	--
hard casters, height +1	--	0.00
soft casters, height +1	--	0.00
upholstery S46/54	0.00	0.00
upholstery S51	0.00	0.00
upholstery S74	0.00	0.00
upholstery S78	0.00	0.00
upholstery S79	0.00	0.00

- Seat sizes (w, d): (13.4", 13.4")

**Material overview**

**Metal Colors**

- M1 030 terra grey
- 032 light blue
- 033 light green
- 041 turquoise
- 045 broom yellow
- 059 arctic
- 063 anthracite
- 065 black (RAL 9011)
- 071 sapphire blue (RAL 5003)
- 084 oxblood
- 091 white

**Fabrics**

- S46/S54 Xtreme
- S51 Blazer
- S74 Era
- S78 Step/StepMelange
- S79 Trevi D

- Mx 060 chrome-plated

**JUMPER Ply Stool**  
Stool with five-star foot.



<b>Model</b>	<b>33764</b>
<b>Standard price</b>	<b>\$276.00</b>
seat height	14.3 - 19.35
metal color M1	0.00
wooden parts seat / backrest 010 natural	0.00
wooden parts seat / backrest H1	18.00
wooden parts seat / backrest oak veneer	59.00
plastic glides	0.00
felt glides	0.00
2-component glides	0.00
hard casters, height +1	0.00
soft casters, height +1	0.00

- Seat sizes (w, d): (13.4", 13.4")

**Material overview**

**Metal Colors**

M1	030	terra grey
	032	light blue
	033	light green
	041	turquoise
	045	broom yellow
	059	arctic
	063	anthracite
	065	black (RAL 9011)
	071	sapphire blue (RAL 5003)
	084	oxblood
	091	white

**Wood Colors**

H1	011	black
	021	light green
	022	light blue
	023	light grey
	027	dark red
	029	dark blue
	037	traffic red
	041	turquoise
	045	broom yellow
	051	polar white

**JUMPER Ply Stool**  
Stool with five-star foot.



<b>Model</b>	<b>33765</b>
<b>Standard price</b>	<b>\$410.00</b>
seat height 20.1 (No. 7 brown)	14.9 - 19.95
metal color M1	0.00
plastic glides	0.00
felt glides	0.00
2-component glides	0.00
hard casters, height +1	0.00
soft casters, height +1	0.00
upholstery S46/54	0.00
upholstery S51	0.00
upholstery S74	0.00
upholstery S78	0.00
upholstery S79	0.00

- Seat sizes (w, d): (13.4", 13.4")

**Material overview**

**Metal Colors**

M1	030	terra grey
	032	light blue
	033	light green
	041	turquoise
	045	broom yellow
	059	arctic
	063	anthracite
	065	black (RAL 9011)
	071	sapphire blue (RAL 5003)
	084	oxblood
	091	white

**Fabrics**

S46/S54 Xtreme
S51 Blazer
S74 Era
S78 Step/StepMelange
S79 Trevi D

Mx	060	chrome-plated
----	-----	---------------

**JUMPER Ply Stool Plus**  
Four-legged stool.



Model	33754	33756	33758	33760	33762
<b>Standard price</b>	<b>\$258.00</b>	<b>\$270.00</b>	<b>\$270.00</b>	<b>\$273.00</b>	<b>\$276.00</b>
seat height	24.05	28.35	29.95	31.15	32.7
max. number stackable	7	7	7	7	7
metal color M1	0.00	0.00	0.00	0.00	0.00
metal color M060	38.00	47.00	94.00	94.00	94.00
wooden parts seat / backrest 010 natural	0.00	0.00	0.00	0.00	0.00
wooden parts seat / backrest H1	18.00	18.00	18.00	18.00	18.00
wooden parts seat / backrest oak veneer	59.00	59.00	59.00	59.00	59.00
plastic glides	0.00	0.00	0.00	0.00	0.00
felt glides	0.00	0.00	0.00	0.00	0.00
2-component glides	0.00	0.00	0.00	0.00	0.00

- Seat sizes (w, d): (13.4", 13.4")

**Material overview**

**Metal Colors**

- M1 030 terra grey
- 032 light blue
- 033 light green
- 041 turquoise
- 045 broom yellow
- 059 arctic
- 063 anthracite
- 065 black (RAL 9011)
- 071 sapphire blue (RAL 5003)
- 084 oxblood
- 091 white

**Wood Colors**

- H1 011 black
- 021 light green
- 022 light blue
- 023 light grey
- 027 dark red
- 029 dark blue
- 037 traffic red
- 041 turquoise
- 045 broom yellow
- 051 polar white

- Mx 060 chrome-plated

**JUMPER Ply Stool**  
 Four-legged stool.

Model	33755	33757	33759	33761	33763
<b>Standard price</b>	<b>\$372.00</b>	<b>\$381.00</b>	<b>\$384.00</b>	<b>\$384.00</b>	<b>\$386.00</b>
seat height	24.05	28.35	29.95	31.15	32.7
distance of seat to foot support	18.15	18.15	18.15	18.15	18.15
max. number stackable	7	7	7	7	7
metal color M1	0.00	0.00	0.00	0.00	0.00
metal color M060	41.00	41.00	94.00	94.00	94.00
plastic glides	0.00	0.00	0.00	0.00	0.00
felt glides	0.00	0.00	0.00	0.00	0.00
2-component glides	0.00	0.00	0.00	0.00	0.00
upholstery S46/54	0.00	0.00	0.00	0.00	0.00
upholstery S51	0.00	0.00	0.00	0.00	0.00
upholstery S74	0.00	0.00	0.00	0.00	0.00
upholstery S78	0.00	0.00	0.00	0.00	0.00
upholstery S79	0.00	0.00	0.00	0.00	0.00

- Seat sizes (w, d): (13.4", 13.4")

**Material overview**
**Metal Colors**

M1 030 terra grey  
 032 light blue  
 033 light green  
 041 turquoise  
 045 broom yellow  
 059 arctic  
 063 anthracite  
 065 black (RAL 9011)  
 071 sapphire blue (RAL 5003)  
 084 oxblood  
 091 white

**Fabrics**

S46/S54 Xtreme  
 S51 Blazer  
 S74 Era  
 S78 Step/StepMelange  
 S79 Trevi D

Mx 060 chrome-plated

**NF-Compass**  
Four-legged chair.



<b>Model</b>	<b>32300</b>	<b>32301</b>	<b>32302</b>
<b>Standard price</b>	<b>\$246.00</b>	<b>\$357.00</b>	<b>\$465.00</b>
seat height	18.15	18.15	18.15
max. number stackable	10	10	10
metal color M1	0.00	0.00	0.00
metal color chrome-plated	68.00	68.00	68.00
seat / backrest plastic C7	0.00	0.00	0.00
plastic glides	0.00	0.00	0.00
felt glides	0.00	0.00	0.00
2-component glides	0.00	0.00	0.00
upholstery S46/54	--	0.00	0.00
upholstery S51	--	41.00	71.00
upholstery S64	--	30.00	48.00
upholstery S74	--	0.00	0.00
upholstery S78	--	12.00	36.00
upholstery S79	--	35.00	76.00
upholstery S82	--	41.00	82.00

**Material overview**

**Metal Colors**

- M1 030 terra grey
- 032 light blue
- 033 light green
- 041 turquoise
- 045 broom yellow
- 059 arctic
- 063 anthracite
- 065 black (RAL 9011)
- 071 sapphire blue (RAL 5003)
- 084 oxblood
- 091 white

**Plastic Colors**

- C7 027 dark red
- 029 dark blue
- 030 light blue
- 031 white
- 033 light green
- 073 black grey (RAL 7021)
- 078 dolphin grey

**Fabrics**

- S46/S54 Xtreme
- S51 Blazer
- S64 Mover
- S74 Era
- S78 Step/StepMelange
- S79 Trevi D
- S82 Evida

- Mx 060 chrome-plated

**NF-Compass**  
Four-legged chair.



Model	32310*	32311*	32312*
<b>Standard price</b>	<b>\$293.00</b>	<b>\$381.00</b>	<b>\$500.00</b>
seat height	18.15	18.15	18.9
max. number stackable	10	10	10
metal color M1	0.00	0.00	0.00
metal color chrome-plated	68.00	68.00	68.00
seat / backrest plastic C7	0.00	0.00	0.00
plastic glides	0.00	0.00	0.00
felt glides	0.00	0.00	0.00
2-component glides	0.00	0.00	0.00
upholstery S46/54	--	0.00	0.00
upholstery S51	--	41.00	71.00
upholstery S64	--	30.00	48.00
upholstery S74	--	0.00	0.00
upholstery S78	--	12.00	36.00
upholstery S79	--	35.00	76.00
upholstery S82	--	41.00	82.00

\* *With row linking connector*

**Material overview**

**Metal Colors**

M1	030	terra grey
	032	light blue
	033	light green
	041	turquoise
	045	broom yellow
	059	arctic
	063	anthracite
	065	black (RAL 9011)
	071	sapphire blue (RAL 5003)
	084	oxblood
	091	white

**Plastic Colors**

C7	027	dark red
	029	dark blue
	030	light blue
	031	white
	033	light green
	073	black grey (RAL 7021)
	078	dolphin grey

**Fabrics**

S46/S54 Xtreme
S51 Blazer
S64 Mover
S74 Era
S78 Step/StepMelange
S79 Trevi D
S82 Evida

Mx	060	chrome-plated
----	-----	---------------

**NF-Swing**  
Forward-sprung cantilever chair.



<b>Model</b>	<b>32400</b>
<b>Standard price</b>	<b>\$246.00</b>
seat height	18.15
metal color M1	0.00
metal color chrome-plated	62.00
seat / backrest plastic C7	0.00
plastic glides	0.00
felt glides	0.00
2-component glides	0.00
tabletop edge protector	18.00
upholstery S46/54	--
upholstery S51	--
upholstery S64	--
upholstery S74	--
upholstery S78	--
upholstery S79	--
upholstery S82	--

**Material overview**

**Metal Colors**

- M1 030 terra grey
- 032 light blue
- 033 light green
- 041 turquoise
- 045 broom yellow
- 059 arctic
- 063 anthracite
- 065 black (RAL 9011)
- 071 sapphire blue (RAL 5003)
- 084 oxblood
- 091 white

- Mx 060 chrome-plated

**Plastic Colors**

- C7 027 dark red
- 029 dark blue
- 030 light blue
- 031 white
- 033 light green
- 073 black grey (RAL 7021)
- 078 dolphin grey

**Fabrics**

- S46/S54 Xtreme
- S51 Blazer
- S64 Mover
- S74 Era
- S78 Step/StepMelange
- S79 Trevi D
- S82 Evida

**NF-Move**  
Five-star foot chair.



<b>Model</b>	<b>32500</b>
<b>Standard price</b>	<b>\$465.00</b>
adjustable seat height	16.5 - 22.5
metal color M1	0.00
seat / backrest plastic C7	0.00
plastic glides	0.00
felt glides	0.00
2-component glides	0.00
hard casters, height +1	0.00
soft casters, height +1	0.00
height-adjust. foot ring	105.00
3D rocking function	0.00
basic non-rocking	<b>-37.00</b>

**Material overview**

**Metal Colors**

M1	030	terra grey
	032	light blue
	033	light green
	041	turquoise
	045	broom yellow
	059	arctic
	063	anthracite
	065	black (RAL 9011)
	071	sapphire blue (RAL 5003)
	084	oxblood
	091	white

**Plastic Colors**

C7	027	dark red
	029	dark blue
	030	light blue
	031	white
	033	light green
	073	black grey (RAL 7021)
	078	dolphin grey

**NF-Move**  
Five-star foot chair.



Model	32510	32515	32516	32517
<b>Standard price</b>	<b>\$570.00</b>	<b>\$687.00</b>	<b>\$760.00</b>	<b>\$862.00</b>
adjustable seat height	20.05 - 30.8	20.05 - 30.8	20.85 - 31.6	20.85 - 31.6
metal color M1	0.00	0.00	0.00	0.00
seat / backrest plastic C7	0.00	0.00	0.00	0.00
plastic glides	<b>-8.00</b>	<b>-8.00</b>	<b>-8.00</b>	<b>-8.00</b>
felt glides	<b>-17.00</b>	<b>-17.00</b>	<b>-17.00</b>	<b>-17.00</b>
2-component glides	<b>-8.00</b>	<b>-8.00</b>	<b>-8.00</b>	<b>-8.00</b>
soft casters, height +1	0.00	0.00	0.00	0.00
3D rocking function	0.00	0.00	0.00	0.00
basic non-rocking	<b>-37.00</b>	<b>-37.00</b>	<b>-37.00</b>	<b>-37.00</b>
upholstery S46/54	--	--	0.00	0.00
upholstery S51	--	--	41.00	71.00
upholstery S64	--	--	30.00	48.00
upholstery S74	--	--	0.00	0.00
upholstery S78	--	--	12.00	36.00
upholstery S79	--	--	35.00	76.00
upholstery S82	--	--	41.00	82.00

**Material overview**

**Metal Colors**

M1 030	terra grey
032	light blue
033	light green
041	turquoise
045	broom yellow
059	arctic
063	anthracite
065	black (RAL 9011)
071	sapphire blue (RAL 5003)
084	oxblood
091	white

**Plastic Colors**

C7 027	dark red
029	dark blue
030	light blue
031	white
033	light green
073	black grey (RAL 7021)
078	dolphin grey

**Fabrics**

S46/S54 Xtreme
S51 Blazer
S64 Mover
S74 Era
S78 Step/StepMelange
S79 Trevi D
S82 Evida

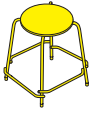
**Solo****Four-legged stool as seat and stand-at seat.**

<b>Model</b>	<b>03826</b>
<b>Standard price</b>	<b>\$182.00</b>
seat height 18.15	0.00
seat height 20.5	6.00
seat height 24.05	15.00
seat height 25.6	33.00
seat height 32.7	65.00
<hr/>	
max. number stackable	4
<hr/>	
metal color M1	0.00
<hr/>	
wooden parts seat / backrest 010 natural	0.00
wooden parts seat / backrest H1	18.00
<hr/>	
plastic glides	0.00
felt glides	0.00

**Material overview****Metal Colors**

M1	030	terra grey
	032	light blue
	033	light green
	041	turquoise
	045	broom yellow
	059	arctic
	063	anthracite
	065	black (RAL 9011)
	071	sapphire blue (RAL 5003)
	084	oxblood
	091	white

**Wood Stain Colors**

H1	011	black
	021	light green
	022	light blue
	023	light grey
	027	dark red
	029	dark blue
	037	traffic red
	041	turquoise
	045	broom yellow
	051	polar white
<hr/>		
Hx	010	natural

**LuPoStool**  
Skid-stool.



Model	03428	03429
<b>Standard price</b>	<b>\$226.00</b>	<b>\$188.00</b>
seat height 18.15	0.00	0.00
seat height 22.05*	47.00	21.00
seat height 24.05*	59.00	24.00
<hr/>		
max. number stackable: 18.15	6	6
max. number stackable: 22.05	2	2
max. number stackable: 24.05	3	3
<hr/>		
metal color M1	0.00	0.00
metal color M060	68.00	50.00
<hr/>		
seat / backrest plastic Cx	0.00	0.00
<hr/>		
plastic glides	0.00	0.00
felt glides	3.00	3.00
2-component glides	0.00	0.00

\* With foot rest.

**Material overview**

**Metal Colors**

- M1 030 terra grey
- 032 light blue
- 033 light green
- 041 turquoise
- 045 broom yellow
- 059 arctic
- 063 anthracite
- 065 black (RAL 9011)
- 071 sapphire blue (RAL 5003)
- 084 oxblood
- 091 white

Mx 060 chrome-plated

**Plastic Colors**

- Cx 073 black grey (RAL 7021)
- 078 dolphin grey

**LuPoGlide  
Skid-chair.**



<b>Model</b>	<b>03430</b>	<b>03434</b>
<b>Standard price</b>	<b>\$174.00</b>	<b>\$220.00</b>
seat height 11.85 (No. 2 violet)	0.00	--
seat height 13.4 (No. 3 yellow)	0.00	--
seat height 15 (No. 4 red)	0.00	--
seat height 16.55 (No. 5 green)	0.00	--
seat height 18.15 (No. 6 blue)	0.00	0.00
seat height 19.7 (No. 7 brown)	--	0.00
max. number stackable	10	10
metal color M1	0.00	0.00
metal color M060	68.00	68.00
seat / backrest plastic Cx	0.00	0.00
plastic glides	0.00	0.00
felt glides	3.00	3.00
2-component glides	0.00	0.00

**Material overview**

**Metal Colors**

- M1 030 terra grey
- 032 light blue
- 033 light green
- 041 turquoise
- 045 broom yellow
- 059 arctic
- 063 anthracite
- 065 black (RAL 9011)
- 071 sapphire blue (RAL 5003)
- 084 oxblood
- 091 white

- Mx 060 chrome-plated

**Plastic Colors**

- Cx 073 black grey (RAL 7021)
- 078 dolphin grey

**LiteBench-ST**  
Stackable bench.

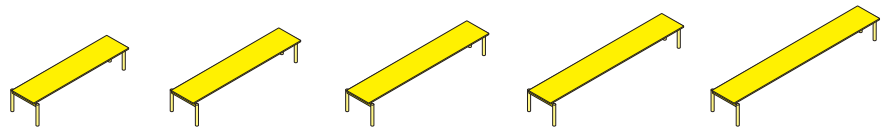

Model	31083	31084	31085	31086	31087
<b>Standard price</b>	<b>\$783.00</b>	<b>\$888.00</b>	<b>\$1,011.00</b>	<b>\$1,168.00</b>	<b>\$1,256.00</b>
dimensions (wxd)*	59.1 x 13.8	66.95 x 13.8	74.85 x 13.8	82.7 x 13.8	90.6 x 13.75
seat height 12.25 (No. 2 violet)	0.00	0.00	0.00	0.00	0.00
seat height 13.8 (No. 3 yellow)	0.00	0.00	0.00	0.00	0.00
seat height 15 (No. 4 red)	0.00	0.00	0.00	0.00	0.00
seat height 16.95 (No. 5 green)	0.00	0.00	0.00	0.00	0.00
seat height 18.15 (No. 6 blue)	0.00	0.00	0.00	0.00	0.00
seat height 20.1 (No. 7 brown)	0.00	0.00	0.00	0.00	0.00
max. number stackable	4	4	4	4	4
metal color M1	0.00	0.00	0.00	0.00	0.00
top HPL solid core 13mm L4	0.00	0.00	0.00	0.00	0.00
plastic glides	0.00	0.00	0.00	0.00	0.00
felt glides	9.00	9.00	9.00	9.00	9.00
2-component glides	0.00	0.00	0.00	0.00	0.00

*Benches are 4" shorter than the tables they should be combined with.*

**Material overview**

**Metal Colors**

- M1 030 terra grey
- 032 light blue
- 033 light green
- 041 turquoise
- 045 broom yellow
- 059 arctic
- 063 anthracite
- 065 black (RAL 9011)
- 071 sapphire blue (RAL 5003)
- 084 oxblood
- 091 white

**Laminate Colors**

- L4 027 natural beech laminate
- 028 natural maple laminate
- 029 natural walnut laminate
- 031 grey white
- 035 andes grey
- 328 white
- 340 natural oak laminate
- 415 terra grey

**Rondo (Lift)**  
Stool with five-star foot.



Model	03822
<b>Standard price</b>	<b>\$264.00</b>
adjustable seat height	14.8 -19.7
metal color M1	0.00
wooden parts seat / backrest 010 natural	0.00
wooden parts seat / backrest H1	18.00
plastic glides	0.00
felt glides	0.00
2-component glides	6.00
hard casters, height +1"	12.00
soft casters, height +1"	12.00
function turnable	0.00

**Material overview**

**Metal Colors**

M1	030	terra grey
	032	light blue
	033	light green
	041	turquoise
	045	broom yellow
	059	arctic
	063	anthracite
	065	black (RAL 9011)
	071	sapphire blue (RAL 5003)
	084	oxblood
	091	white

Mx 060 chrome-plated

**Wood Stain Colors**

H1	011	black
	021	light green
	022	light blue
	023	light grey
	027	dark red
	029	dark blue
	037	traffic red
	041	turquoise
	045	broom yellow
	051	polar white

Hx 010 natural

**RondoStool**  
Four-legged stool.

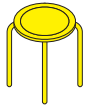

Model	03823
<b>Standard price</b>	<b>\$147.00</b>
seat height 13.8 (No. 3 yellow)	0.00
seat height 15 (No. 4 red)	0.00
seat height 16.95 (No. 5 green)	0.00
seat height 18.15 (No. 6 blue)	0.00
seat height 20.1 (No. 7 brown)	0.00
seat height 21.7	0.00
<hr/>	
max number stackable	15
<hr/>	
metal color M1	0.00
metal color M060	41.00
<hr/>	
wooden parts seat / backrest 010 natural	0.00
wooden parts seat / backrest H1	18.00
<hr/>	
plastic glides	0.00
felt glides	0.00

**Material overview**

**Metal Colors**

M1	030	terra grey
	032	light blue
	033	light green
	041	turquoise
	045	broom yellow
	059	arctic
	063	anthracite
	065	black (RAL 9011)
	071	sapphire blue (RAL 5003)
	084	oxblood
	091	white

Mx 060 chrome-plated

**Wood Stain Colors**

H1	011	black
	021	light green
	022	light blue
	023	light grey
	027	dark red
	029	dark blue
	037	traffic red
	041	turquoise
	045	broom yellow
	051	polar white

Hx 010 natural

**RondoStool Plus**  
Four-legged stool.



Model	03816	03817	03818
<b>Standard price</b>	<b>\$290.00</b>	<b>\$293.00</b>	<b>\$296.00</b>
seat height	25.6	29.95	32.7
distance of seat to foot support	18.15	21.5	20.5
adjustable seat height	--	--	--
max. number stackable	--	--	--
metal color M1	0.00	0.00	0.00
metal color M060	88.00	88.00	88.00
wooden parts seat / backrest 010 natural	0.00	0.00	0.00
wooden parts seat / backrest H1	18.00	18.00	18.00
plastic glides	0.00	0.00	0.00
felt glides	0.00	0.00	0.00

**Material overview**

**Metal Colors**

- M1 030 terra grey
- 032 light blue
- 033 light green
- 041 turquoise
- 045 broom yellow
- 059 arctic
- 063 anthracite
- 065 black (RAL 9011)
- 071 sapphire blue (RAL 5003)
- 084 oxblood
- 091 white

- Mx 060 chrome-plated

**Wood Stain Colors**

- H1 011 black
- 021 light green
- 022 light blue
- 023 light grey
- 027 dark red
- 029 dark blue
- 037 traffic red
- 041 turquoise
- 045 broom yellow
- 051 polar white

- Hx 010 natural

**KN-39**  
Four-legged chair.

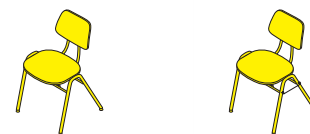

Model	03901	03904*
<b>Base price</b>	<b>\$211.00</b>	<b>\$226.00</b>
seat height 16.55 (No. 5 green)	0.00	--
seat height 18.15 (No. 6 blue)	0.00	0.00
max. number stackable	10	10
metal color M1	0.00	0.00
metal color M060	62.00	62.00
wooden parts seat / backrest 010 natural	0.00	0.00
wooden parts seat / backrest H1	35.00	35.00
plastic glides	0.00	0.00
felt glides	0.00	0.00

\* With row linking connector

**Material overview**

**Metal Colors**

M1	030	terra grey
	032	light blue
	033	light green
	041	turquoise
	045	broom yellow
	059	arctic
	063	anthracite
	065	black (RAL 9011)
	071	sapphire blue (RAL 5003)
	084	oxblood
	091	white

Mx 060 chrome-plated

**Wood Stain Colors**

H1	011	black
	021	light green
	022	light blue
	023	light grey
	027	dark red
	029	dark blue
	037	traffic red
	041	turquoise
	045	broom yellow
	051	polar white

Hx 010 natural

**WD-39**  
Four-legged chair.



Model	03940	03941	03942
<b>Base price</b>	<b>\$264.00</b>	<b>\$372.00</b>	<b>\$430.00</b>
seat height	18.55	19.1	19.1
max. number stackable	10	10	10
metal color M1	0.00	0.00	0.00
metal color M060	88.00	88.00	88.00
wooden parts seat / backrest 010 natural	0.00	0.00	0.00
wooden parts seat / backrest H1	35.00	35.00	35.00
plastic glides	0.00	0.00	0.00
felt glides	3.00	3.00	3.00
upholstery S40	--	0.00	0.00
upholstery S46	--	0.00	0.00
upholstery S51	--	0.00	0.00
upholstery S64	--	0.00	0.00
upholstery S73	--	0.00	0.00
upholstery S74	--	0.00	0.00
upholstery S78	--	0.00	0.00
upholstery S79	--	0.00	0.00
upholstery S81	--	0.00	0.00

**Material overview**

**Metal Colors**

M1	030	terra grey
	032	light blue
	033	light green
	041	turquoise
	045	broom yellow
	059	arctic
	063	anthracite
	065	black (RAL 9011)
	071	sapphire blue (RAL 5003)
	084	oxblood
	091	white

Mx 060 chrome-plated

**Wood Stain Colors**

H1	011	black
	021	light green
	022	light blue
	023	light grey
	027	dark red
	029	dark blue
	037	traffic red
	041	turquoise
	045	broom yellow
	051	polar white

Hx 010 natural

**Fabrics**

S40	Stamskin Top
S46	Xtreme
S51	Blazer
S64	Mover
S73	Erika
S74	Era
S78	Step/StepMelange
S79	Trevi D
S81	Evida Venezia

**Classic  
Skid-chair.**



<b>Model</b>	<b>03100</b>	<b>03101</b>
<b>Standard price</b>	<b>\$343.00</b>	<b>\$459.00</b>
seat height 11.85 (No. 2 violet)	0.00	--
seat height 13.4 (No. 3 yellow)	--	<b>-49.00</b>
seat height 15 (No. 4 red)	--	<b>-43.00</b>
seat height 16.55 (No. 5 green)	--	<b>-8.00</b>
seat height 18.15 (No. 6 blue)	--	0.00
<hr/>		
wooden parts seat / backrest H1	0.00	0.00
<hr/>		
without glides	0.00	0.00
felt glides	3.00	3.00
steel glides	12.00	12.00

**Material overview**

**Wood Stain Colors**

H1 010 natural

**M-Bench  
Side bench.**

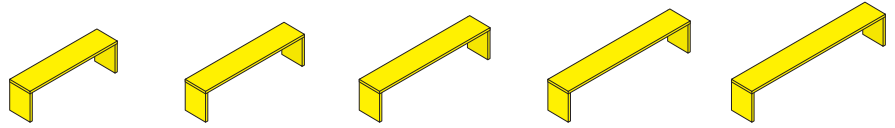

Model	30213	30214	30215	30216	30217
<b>Standard price</b>	<b>\$1,355.00</b>	<b>\$1,413.00</b>	<b>\$1,471.00</b>	<b>\$1,530.00</b>	<b>\$1,705.00</b>
dimensions (wxd)*	58.3 x 13.8	66.15 x 13.8	74.05 x 13.8	81.9 x 13.8	89.8 x 13.75
seat height 18.15 (No. 6 blue)	0.00	0.00	0.00	0.00	0.00
seat color laminate L4	0.00	0.00	0.00	0.00	0.00
side panels color laminate L4	0.00	0.00	0.00	0.00	0.00
plastic glides	0.00	0.00	0.00	0.00	0.00
felt glides	9.00	9.00	9.00	9.00	9.00
with floor attachment kit	68.00	68.00	68.00	68.00	68.00

\* Benches are 4.75" shorter than the tables they should be combined with.

**Knocked-down delivery for all M-Bench models on this page.**

Veneers available upon request.

**Material overview**

**Laminate Colors**

- L4 027 natural beech laminate
- 028 natural maple laminate
- 029 natural walnut laminate
- 031 grey white
- 035 andes grey
- 328 white
- 340 natural oak laminate
- 415 terra grey

**Stakki**  
Three-legged plastic chair.



<b>Model</b>	<b>03811</b>
<b>Standard price</b>	<b>\$165.00</b>
seat height 15 (No. 4 red)	0.00
seat height 18.15 (No. 6 blue)	0.00
<hr/>	
max. number stackable	7
<hr/>	
chair color plastic C6	0.00
<hr/>	
2-component glides	0.00

**Material overview**

**Plastic Colors**

C6	029	dark blue
	033	light green
	037	traffic red
	073	black grey (RAL 7021)

Stacking Wagons/Trolleys

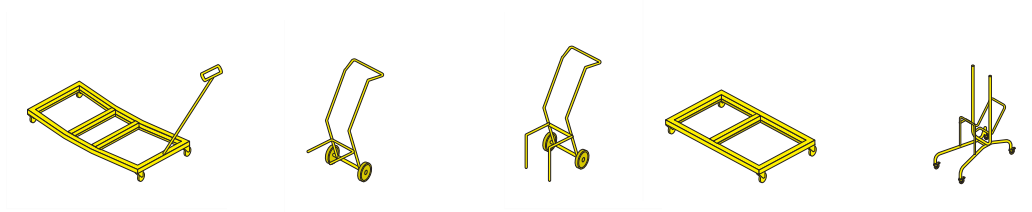

Model	03414	03415	03835	03834	33299
<b>Standard price</b>	<b>\$699.00</b>	<b>\$538.00</b>	<b>\$643.00</b>	<b>\$468.00</b>	<b>\$731.00</b>
	- wagon for BasicGlide model 03402 in heights 16.95, 18.15 - 20x capacity - wagon for LuPoGlide model 03430 and 03434 in heights 16.95, 18.15 - 20x capacity - wagon for LuPoStool model 03428 in height 18.15 - 12x capacity	- trolley for BasicGlide model 03402 in heights 16.95, 18.15 - 10x capacity - trolley for LuPoGlide model 03430 and 03434 in heights 16.95, 18.15 - 10x capacity - trolley for LuPoStool model 03428 in height 18.15 - 6x capacity	- trolley for KN-39 model 03901 in height 18.15 - 10x capacity	- trolley for KN-39 model 03901 in height 18.15 - 10x capacity	- trolley for Jumper Air Active model 33400, 33401 in heights 16.95, 18.15, 20.1 - 10x capacity - trolley for Jumper Ply Active model 33450, 33451 in heights 16.95, 18.15, 20.1 - 10x capacity - trolley for Jumper Air Four model 33300, 33319 in height 18.15 and 33300 in heights 16.95, 18.15, 20.1 - 10x capacity - trolley for Jumper Ply Four model 33350, 33369 in height 18.15 and 33350 in heights 16.95, 18.15, 20.1 - 10x capacity - trolley for PantoSwing LuPo model 31400, 31401 in heights 16.95, 18.15, 20.1 - 10x capacity - trolley for PantoSwing-VF model 31420, 31421 in heights 18.15, 20.1 - 10x capacity







## Tables

**StepByStep-I**  
**Skid table, adjustable height.**

LIGNOdur\*

LIGNOdur\*

LIGNOdur\*



Model	02904	02901	02905
<b>Standard price</b>	<b>\$378.00</b>	<b>\$430.00</b>	<b>\$529.00</b>
dimensions (wxd)	27.6 x 19.7	29.55 x 25.6	51.2 x 19.7
table height 20.9 (No. 2 violet)	0.00	0.00	0.00
table height 22.85 (No. 3 yellow)	0.00	0.00	0.00
table height 25.2 (No. 4 red)	0.00	0.00	0.00
table height 27.6 (No. 5 green)	0.00	0.00	0.00
table height 29.95 (No. 6 blue)	0.00	0.00	0.00
table height 32.3 (No. 7 brown)	0.00	0.00	0.00
metal color M1	0.00	0.00	0.00
top LIGNOdur color laminate L1	0.00	0.00	0.00
top LIGNOpal-PUR color laminate L2	--	--	--
tabletop edge PUR	--	--	--
PUR-color table top edge beige, grey	--	--	--
plastic glides	0.00	0.00	0.00
felt glides	3.00	3.00	3.00
2 casters, 2 felt glides	41.00	41.00	41.00
metal grid bookshelf	18.00	18.00	35.00
satchel hooks	6.00	6.00	12.00
hexagon key locking	0.00	0.00	0.00
hand wheel locking	12.00	12.00	12.00

**Material overview**

**Metal Colors**

- M1 030 terra grey
- 032 light blue
- 033 light green
- 041 turquoise
- 045 broom yellow
- 059 arctic
- 063 anthracite
- 065 black (RAL 9011)
- 071 sapphire blue (RAL 5003)
- 084 oxblood
- 091 white

**Laminate Colors**

- L1 027 natural beech laminate
- 028 natural maple laminate
- 031 grey white
- 035 andes grey
- L2 027 natural beech laminate
- 028 natural maple laminate
- 031 grey white
- 035 andes grey
- 328 white

**StepByStep-III**  
**Skid table, adjustable height.**

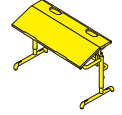
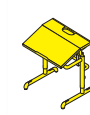

<b>Model</b>	<b>02997*</b>	<b>02998*</b>
<b>Standard price</b>	<b>\$876.00</b>	<b>\$1,037.00</b>
dimensions (wxd)	29.55 x 25.6	51.2 x 25.6
table height 20.9 (No. 2 violet)	0.00	0.00
table height 22.85 (No. 3 yellow)	0.00	0.00
table height 25.2 (No. 4 red)	0.00	0.00
table height 27.6 (No. 5 green)	0.00	0.00
table height 29.95 (No. 6 blue)	0.00	0.00
table height 32.3 (No. 7 brown)	0.00	0.00
metal color M1	0.00	0.00
top LIGNOpal color laminate L2	0.00	0.00
tabletop edge PUR	0.00	0.00
PUR-color table top edge beige, grey	0.00	0.00
plastic glides	0.00	0.00
felt glides	3.00	3.00
2 casters, 2 felt glides	41.00	41.00
metal grid bookshelf	18.00	35.00
plywood bookshelf	202.00	391.00
satchel hooks	6.00	12.00
hexagon key locking	0.00	0.00
hand wheel locking	12.00	12.00

*\*Inclineable in steps (0°, 5°, 10°, 16°, 20°)*

**Material overview**

**Metal Colors**

M1	030	terra grey
	032	light blue
	033	light green
	041	turquoise
	045	broom yellow
	059	arctic
	063	anthracite
	065	black (RAL 9011)
	071	sapphire blue (RAL 5003)
	084	oxblood
	091	white

**Laminate Colors**

L2	027	natural beech laminate
	028	natural maple laminate
	031	grey white
	035	andes grey
	328	white

**Step-III**  
**Skid table.**



<b>Model</b>	<b>02941</b>	<b>02942</b>
<b>Standard price</b>	<b>\$847.00</b>	<b>\$993.00</b>
dimensions (wxd)	29.55 x 25.6	51.2 x 25.6
table height 20.5 (No. 2 violet)	0.00	0.00
table height 22.85 (No. 3 yellow)	0.00	0.00
table height 25.2 (No. 4 red)	0.00	0.00
table height 27.6 (No. 5 green)	0.00	0.00
table height 29.95 (No. 6 blue)	0.00	0.00
table height 32.3 (No. 7 brown)	0.00	0.00
metal color M1	0.00	0.00
top LIGNOpal color laminate L2	0.00	0.00
tabletop edge PUR	0.00	0.00
PUR-color table top edge beige, grey	0.00	0.00
plastic glides	0.00	0.00
felt glides	3.00	3.00
2 casters, 2 felt glides	41.00	41.00
metal grid bookshelf	18.00	35.00
plywood bookshelf	202.00	391.00
satchel hooks	6.00	12.00

*-Edges: PUR: Polyurethane, available in grey , dark grey, or beige*

**Material overview**

**Metal Colors**

- M1 030 terra grey
- 032 light blue
- 033 light green
- 041 turquoise
- 045 broom yellow
- 059 arctic
- 063 anthracite
- 065 black (RAL 9011)
- 071 sapphire blue (RAL 5003)
- 084 oxblood
- 091 white

**Laminate Colors**

- L2 027 natural beech laminate
- 028 natural maple laminate
- 031 grey white
- 035 andes grey
- 328 white

**Ergo-I**  
**Skid table, adjustable height.**



Model	02970	02971
<b>Standard price</b>	<b>\$979.00</b>	<b>\$1,095.00</b>
dimensions (wxd)	29.55 x 25.6	51.2 x 25.6
adjustable height	22.25 - 32.3	22.25 - 32.3
metal color M1	0.00	0.00
top LIGNOpal color laminate L2	0.00	0.00
tabletop edge PUR	0.00	0.00
PUR-color table top edge beige, grey	0.00	0.00
plastic glides	0.00	0.00
2 casters, 2 adj. glides, plastic	50.00	50.00
felt glides	3.00	3.00
metal grid bookshelf	18.00	35.00
plywood bookshelf	202.00	391.00
satchel hooks	6.00	12.00

**Material overview**

**Metal Colors**

- M1 030 terra grey
- 032 light blue
- 033 light green
- 041 turquoise
- 045 broom yellow
- 059 arctic
- 063 anthracite
- 065 black (RAL 9011)
- 071 sapphire blue (RAL 5003)
- 084 oxblood
- 091 white

**Laminate Colors**

- L2 027 natural beech laminate
- 028 natural maple laminate
- 031 grey white
- 035 andes grey
- 328 white

**Ergo-III**  
**Skid table, adjustable height.**



<b>Model</b>	<b>02974*</b>	<b>02975*</b>
<b>Standard price</b>	<b>\$1,329.00</b>	<b>\$1,562.00</b>
dimensions (wxd)	29.55 x 25.6	51.2 x 25.6
adjustable height	22.25 - 32.3	22.25 - 32.3
metal color M1	0.00	0.00
top LIGNOpal color laminate L9	0.00	0.00
tabletop edge PUR	0.00	0.00
PUR-color table top edge beige, grey	0.00	0.00
plastic glides	0.00	0.00
2 casters, 2 adj. glides, plastic	50.00	50.00
felt glides	3.00	3.00
metal grid bookshelf	18.00	35.00
plywood bookshelf	202.00	391.00
satchel hooks	6.00	12.00

*\*Continuously inclineable working top (0°-16°)*

**Material overview**

**Metal Colors**

- M1 030 terra grey
- 032 light blue
- 033 light green
- 041 turquoise
- 045 broom yellow
- 059 arctic
- 063 anthracite
- 065 black (RAL 9011)
- 071 sapphire blue (RAL 5003)
- 084 oxblood
- 091 white

**Laminate Colors**

- L9 027 natural beech laminate
- 028 natural maple laminate
- 031 grey white
- 328 white

**ErgoUp**  
Stand-at desk.



Model	02991
<b>Standard price</b>	<b>\$1,387.00</b>
dimensions (wxd)	29.55 x 25.6
table height stepless from 32.3 to 37.8	0.00
table height stepless from 37.8 to 43.35	0.00
metal color M1	0.00
top LIGNOpal color laminate L9	0.00
tabletop edge PUR	0.00
PUR-color table top edge beige, grey	0.00
plastic glides	0.00
felt glides	3.00
metal grid bookshelf	18.00
plywood shelf	175.00

**Material overview**

**Metal Colors**

M1	030	terra grey
	032	light blue
	033	light green
	041	turquoise
	045	broom yellow
	059	arctic
	063	anthracite
	065	black (RAL 9011)
	071	sapphire blue (RAL 5003)
	084	oxblood
	091	white

**Laminate Colors**

L9	027	natural beech laminate
	028	natural maple laminate
	031	grey white
	328	white

**Uno-M  
Skid table.**

LIGNOdur



LIGNOdur



LIGNOdur

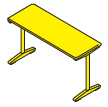

Model	02408	02409	02405
<b>Standard price</b>	<b>\$281.00</b>	<b>\$322.00</b>	<b>\$340.00</b>
dimensions (wxd)	27.6 x 19.7	29.55 x 25.6	51.2 x 19.7
table height 20.5 (No. 2 violet)	0.00	0.00	0.00
table height 22.85 (No. 3 yellow)	0.00	0.00	0.00
table height 25.2 (No. 4 red)	0.00	0.00	0.00
table height 27.6 (No. 5 green)	0.00	0.00	0.00
table height 29.95 (No. 6 blue)	0.00	0.00	0.00
table height 32.3 (No. 7 brown)	0.00	0.00	0.00
metal color M1	0.00	0.00	0.00
metal color M060	97.00	120.00	132.00
top LIGNOdur color laminate L1	0.00	0.00	0.00
top LIGNOpal-PUR color laminate L2	--	--	--
tabletop edge PUR	--	--	--
PUR-color tabletop edge beige, grey	--	--	--
plastic glides	0.00	0.00	0.00
2-component glides	0.00	0.00	0.00
metal grid bookshelf	18.00	18.00	35.00
satchel hooks	6.00	6.00	12.00

**Material overview**

**Metal Colors**

- M1 030 terra grey
- 032 light blue
- 033 light green
- 041 turquoise
- 045 broom yellow
- 059 arctic
- 063 anthracite
- 065 black (RAL 9011)
- 071 sapphire blue (RAL 5003)
- 084 oxblood
- 091 white

**Laminate Colors**

- L1 027 natural beech laminate
- 028 natural maple laminate
- 031 grey white
- 035 andes grey
- L2 027 natural beech laminate
- 028 natural maple laminate
- 031 grey white
- 035 andes grey
- 328 white

- Mx 060 chrome-plated

**Uno-M**  
**Skid table.**

LIGNOpal-PUR



LIGNOpal-PUR

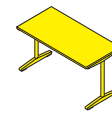

LIGNOpal-PUR

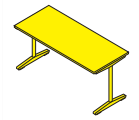

Model	02410	02406	02407
<b>Standard price</b>	<b>\$337.00</b>	<b>\$486.00</b>	<b>\$512.00</b>
dimensions (wxd)	29.55 x 25.6	51.2 x 25.6	59.1 x 25.6
table height 20.5 (No. 2 violet)	0.00	0.00	0.00
table height 22.85 (No. 3 yellow)	0.00	0.00	0.00
table height 25.2 (No. 4 red)	0.00	0.00	0.00
table height 27.6 (No. 5 green)	0.00	0.00	0.00
table height 29.95 (No. 6 blue)	0.00	0.00	0.00
table height 32.3 (No. 7 brown)	0.00	0.00	0.00
metal color M1	0.00	0.00	0.00
metal color M060	120.00	146.00	161.00
top LIGNOdur color laminate L1	--	--	--
top LIGNOpal-PUR color laminate L2	0.00	0.00	0.00
tabletop edge PUR	0.00	0.00	0.00
PUR-color tabletop edge beige, grey	0.00	0.00	0.00
plastic glides	0.00	0.00	0.00
2-component glides	0.00	0.00	0.00
metal grid bookshelf	18.00	35.00	35.00
satchel hooks	6.00	12.00	12.00

**Uno-M Book Box  
Skid table.**

LIGNOdur



LIGNOdur

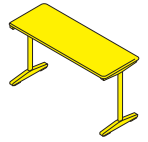

Model	E2408	E2405
<b>Standard price</b>	<b>\$281.00</b>	<b>\$340.00</b>
dimensions (wxd)	27.6 x 19.7	51.2 x 19.7
table height 20.5 (No. 2 violet)	0.00	0.00
table height 22.85 (No. 3 yellow)	0.00	0.00
table height 25.2 (No. 4 red)	0.00	0.00
table height 27.6 (No. 5 green)	0.00	0.00
table height 29.95 (No. 6 blue)	0.00	0.00
table height 32.3 (No. 7 brown)	0.00	0.00
metal color M1	0.00	0.00
top LIGNOdur L1	0.00	0.00
plastic glides	0.00	0.00
2-component glides	0.00	0.00
with 3.38 in solid metal book box (black)	73.00	146.00
with 4.38 in solid metal book box* (black)	73.00	146.00
satchel hooks	6.00	6.00

*\*Not available for No. 2 violet and No. 3 yellow height*

**Material overview**

**Metal Colors**

- M1 030 terra grey
- 032 light blue
- 033 light green
- 041 turquoise
- 045 broom yellow
- 059 arctic
- 063 anthracite
- 065 black (RAL 9011)
- 071 sapphire blue (RAL 5003)
- 084 oxblood
- 091 white

**Laminate Colors**

- L1 027 natural beech laminate
- 028 natural maple laminate
- 031 grey white
- 035 andes grey

- Mx 060 chrome-plated

**Uno-M-Step**  
Skid table, adjustable height.

LIGNOdur\*



LIGNOdur\*



LIGNOdur\*

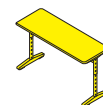

Model	22408	22409	22405
<b>Standard price</b>	<b>\$351.00</b>	<b>\$384.00</b>	<b>\$436.00</b>
dimensions (wxd)	27.6 x 19.7	29.55 x 25.6	51.2 x 19.7
table height 23.25 (No. 3 yellow)	0.00	0.00	0.00
table height 25.2 (No. 4 red)	0.00	0.00	0.00
table height 28 (No. 5 green)	0.00	0.00	0.00
table height 29.95 (No. 6 blue)	0.00	0.00	0.00
table height 32.3 (No. 7 brown)	0.00	0.00	0.00
metal color M1	0.00	0.00	0.00
metal color M060	187.00	263.00	152.00
top LIGNOdur color laminate L1	0.00	0.00	0.00
top LIGNOpal-PUR color laminate L2	--	--	--
tabletop edge PUR	--	--	--
PUR-color tabletop edge beige, grey	--	--	--
plastic glides	0.00	0.00	0.00
2-component glides	0.00	0.00	0.00
metal grid bookshelf	18.00	18.00	35.00
satchel hooks	6.00	6.00	12.00

**Material overview**

**Metal Colors**

- M1 030 terra grey
- 032 light blue
- 033 light green
- 041 turquoise
- 045 broom yellow
- 059 arctic
- 063 anthracite
- 065 black (RAL 9011)
- 071 sapphire blue (RAL 5003)
- 084 oxblood
- 091 white

**Laminate Colors**

- L1 027 natural beech laminate
- 028 natural maple laminate
- 031 grey white
- 035 andes grey
- L2 027 natural beech laminate
- 028 natural maple laminate
- 031 grey white
- 035 andes grey
- 328 white

- Mx 060 chrome-plated

**Uno-M-Step**  
Skid table, adjustable height.

LIGNOpal-PUR



LIGNOpal-PUR

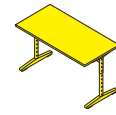

LIGNOpal-PUR

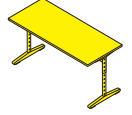

Model	22410	22406	22407
<b>Standard price</b>	<b>\$430.00</b>	<b>\$503.00</b>	<b>\$538.00</b>
dimensions (wxd)	29.55 x 25.6	51.2 x 25.6	59.1 x 25.6
table height 23.25 (No. 3 yellow)	0.00	0.00	0.00
table height 25.2 (No. 4 red)	0.00	0.00	0.00
table height 28 (No. 5 green)	0.00	0.00	0.00
table height 29.95 (No. 6 blue)	0.00	0.00	0.00
table height 32.3 (No. 7 brown)	0.00	0.00	0.00
metal color M1	0.00	0.00	0.00
metal color M060	263.00	222.00	228.00
top LIGNOdur color laminate L1	--	--	--
top LIGNOpal-PUR color laminate L2	0.00	0.00	0.00
tabletop edge PUR	0.00	0.00	0.00
PUR-color tabletop edge beige, grey	0.00	0.00	0.00
plastic glides	0.00	0.00	0.00
2-component glides	0.00	0.00	0.00
metal grid bookshelf	18.00	35.00	35.00
satchel hooks	6.00	12.00	12.00

**Material overview**

**Metal Colors**

- M1 030 terra grey
- 032 light blue
- 033 light green
- 041 turquoise
- 045 broom yellow
- 059 arctic
- 063 anthracite
- 065 black (RAL 9011)
- 071 sapphire blue (RAL 5003)
- 084 oxblood
- 091 white

- Mx 060 chrome-plated

**Laminate Colors**

- L1 027 natural beech laminate
- 028 natural maple laminate
- 031 grey white
- 035 andes grey
- L2 027 natural beech laminate
- 028 natural maple laminate
- 031 grey white
- 035 andes grey
- 328 white

**Uno-M-Teach  
Teachers' desk.**

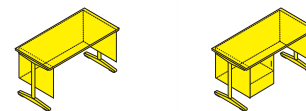

Model	04487	04489
<b>Standard price</b>	<b>\$751.00</b>	<b>\$1,072.00</b>
dimensions (wxd)	51.2 x 25.6	51.2 x 25.6
table height 29.95	0.00	0.00
metal color M1	0.00	0.00
body LIGNOpal color laminate L6	0.00	0.00
top LIGNOpal color laminate L2	0.00	0.00
tabletop edge PUR	0.00	0.00
PUR-color table top edge beige, grey	0.00	0.00
plastic glides	0.00	0.00
2-component glides	0.00	0.00
locking as indicated or 18001	--	50.00
locking plan, site installat.	--	56.00
metal bow handle nickel-plated	--	0.00
metal bow handle chrome-plated	--	0.00

*-Edges: PUR: Polyurethane, available in grey or beige; black grey*

**Material overview**

**Metal Colors**

- M1 030 terra grey
- 032 light blue
- 033 light green
- 041 turquoise
- 045 broom yellow
- 059 arctic
- 063 anthracite
- 065 black (RAL 9011)
- 071 sapphire blue (RAL 5003)
- 084 oxblood
- 091 white
- Mx 060 chrome-plated

**Laminate Colors**

- L2 027 natural beech laminate
- 028 natural maple laminate
- 031 grey white
- 035 andes grey
- 328 white
- L6 017 astral silver
- 018 anthracite
- 019 plain black
- 027 natural beech laminate
- 028 natural maple laminate
- 029 natural walnut laminate
- 031 grey white
- 035 andes grey
- 328 white
- 340 natural oak laminate
- 415 terra grey

**Duo-Media  
Computer table.**

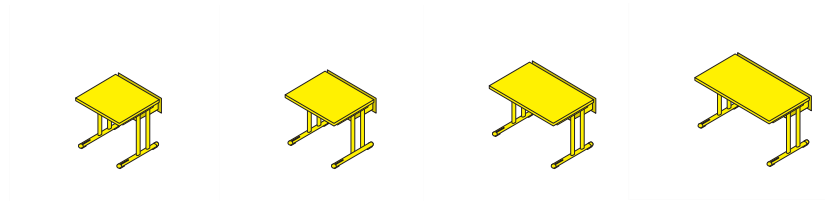

Model	21470	21471	21472	21473
<b>Base price</b>	<b>\$789.00</b>	<b>\$818.00</b>	<b>\$906.00</b>	<b>\$1,081.00</b>
dimensions (wxd)	31.5 x 31.3	35.45 x 31.3	47.25 x 31.3	55.15 x 31.3
table height	28.35	28.35	28.35	28.35
metal color M1	0.00	0.00	0.00	0.00
top color laminate L4	0.00	0.00	0.00	0.00
tabletop edge 2.5mm plastic	0.00	0.00	0.00	0.00
laminate color tabletop edge L4	0.00	0.00	0.00	0.00
unified locking 18001	0.00	0.00	0.00	0.00
locking as indicated	6.00	6.00	6.00	6.00
locking plan, site installat.	56.00	56.00	56.00	56.00
cable channel tabletops flush	0.00	0.00	0.00	0.00
cable channel with 12cm height step	18.00	18.00	18.00	18.00

**Material overview**

**Metal Colors**

- M1 030 terra grey
- 032 light blue
- 033 light green
- 041 turquoise
- 045 broom yellow
- 059 arctic
- 063 anthracite
- 065 black (RAL 9011)
- 071 sapphire blue (RAL 5003)
- 084 oxblood
- 091 white

**Laminate Colors**

- L4 027 natural beech laminate
- 028 natural maple laminate
- 029 natural walnut laminate
- 031 grey white
- 035 andes grey
- 328 white
- 340 natural oak laminate
- 415 terra grey

**Duo-Media  
Computer table.**

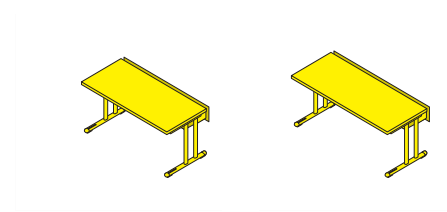

Model	21474	21475
<b>Base price</b>	<b>\$1,139.00</b>	<b>\$1,226.00</b>
dimensions (wxd)	63 x 31.3	131.5 x 70.9
table height	28.35	28.35
metal color M1	0.00	0.00
top color laminate L4	0.00	0.00
tabletop edge 2.5mm plastic	0.00	0.00
laminate color tabletop edge L4	0.00	0.00
unified locking 18001	0.00	0.00
locking as indicated	6.00	6.00
locking plan, site installat.	56.00	56.00
cable channel tabletops flush	0.00	0.00
cable channel with 12cm height step	18.00	18.00

**Material overview**

**Metal Colors**

- M1 030 terra grey
- 032 light blue
- 033 light green
- 041 turquoise
- 045 broom yellow
- 059 arctic
- 063 anthracite
- 065 black (RAL 9011)
- 071 sapphire blue (RAL 5003)
- 084 oxblood
- 091 white

**Laminate Colors**

- L4 027 natural beech laminate
- 028 natural maple laminate
- 029 natural walnut laminate
- 031 grey white
- 035 andes grey
- 328 white
- 340 natural oak laminate
- 415 terra grey

**Duo-Media  
Computer table.**

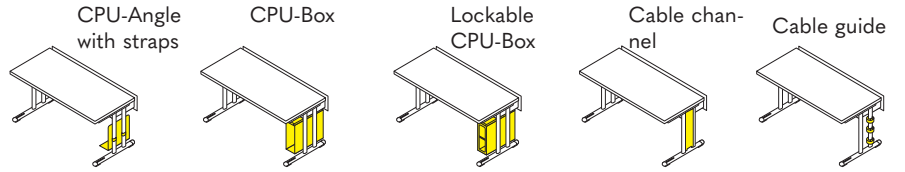

Model	21476*	21477*	21478*	21479	21480
<b>Base price</b>	<b>\$89.00</b>	<b>\$456.00</b>	<b>\$736.00</b>	<b>\$153.00</b>	<b>\$22.00</b>
metal color M1	--	--	--	0.00	--
unified locking 18001	--	--	0.00	--	--
locking as indicated	--	--	6.00	--	--
locking plan, site installat.	--	--	56.00	--	--
assembly position without	0.00	12.00	12.00	12.00	--
assembly position on left inner	0.00	0.00	0.00	--	--
assembly position on right inner	0.00	0.00	0.00	--	--
assembly position on left outer	0.00	--	--	0.00	--
assembly position on right outer	0.00	--	--	0.00	--

*\*Available in Arctic only.*

**Material overview**

**Metal Colors**

- M1 030 terra grey
- 032 light blue
- 033 light green
- 041 turquoise
- 045 broom yellow
- 059 arctic
- 063 anthracite
- 065 black (RAL 9011)
- 071 sapphire blue (RAL 5003)
- 084 oxblood
- 091 white

**Uno-C**  
**Skid table.**

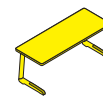

<b>Model</b>	<b>22430</b>	<b>22431</b>	<b>22432</b>
<b>Standard price</b>	<b>\$419.00</b>	<b>\$518.00</b>	<b>\$547.00</b>
dimensions (wxd)	27.6 x 19.7	29.55 x 25.6	51.2 x 19.7
table height 20.9 (No. 2 violet)	0.00	0.00	0.00
table height 23.25 (No. 3 yellow)	0.00	0.00	0.00
table height 25.2 (No. 4 red)	0.00	0.00	0.00
table height 28 (No. 5 green)	0.00	0.00	0.00
table height 29.95 (No. 6 blue)	0.00	0.00	0.00
table height 32.3 (No. 7 brown)	0.00	0.00	0.00
step height adjustment 20.9 - 32.3	68.00	68.00	68.00
metal color M1	0.00	0.00	0.00
metal color M060	132.00	190.00	205.00
top LIGNOdur color laminate L1	0.00	0.00	0.00
plastic glides	0.00	0.00	0.00
plastic glides, additional rear casters	0.00	0.00	0.00
felt glides	0.00	0.00	0.00
felt glides, additional rear casters	0.00	0.00	0.00
2 component glides	0.00	0.00	0.00
2 component glides, additional rear casters	0.00	0.00	0.00
metal grid bookshelf	18.00	18.00	35.00
guide rails ONLY for 3 in. box	33.00	33.00	65.00
with plastic box 3 in. high, plastic color C3	47.00	47.00	94.00
with plastic box 3 in. high, plastic color C3 with cover	59.00	59.00	106.00
satchel hooks	6.00	6.00	12.00
with modesty screen in HPL solid core (L4)	149.00	149.00	149.00

**Material overview**

**Metal Colors**

M1	030	terra grey
	032	light blue
	033	light green
	041	turquoise
	045	broom yellow
	059	arctic
	063	anthracite
	065	black (RAL 9011)
	071	sapphire blue (RAL 5003)
	084	oxblood
	091	white

Mx 060 chrome-plated

**Plastic Colors**

C3	001	red
	014	anthracite
	016	translucent
	030	dark red
	031	dark blue
	032	light blue
	033	light green
	038	turquoise
	039	broom yellow

**Laminate Colors (LIGNOdur Top)**

L1	027	natural beech laminate
	028	natural maple laminate
	031	grey white
	035	andes grey
L4	027	natural beech laminate
	028	natural maple laminate
	029	natural walnut laminate
	031	grey white
	035	andes grey
	328	white
	340	natural oak laminate
	415	terra grey

**Uno-C**  
Modesty screens.

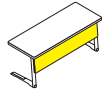

Model	22428	22429
<b>Standard price</b>	<b>\$106.00</b>	<b>\$185.00</b>
dimensions (wxd) for table width	24.05 x 9.85 27.6	45.7 x 9.85 51.2
HPL solid core (L4)	0.00	0.00

**Material overview**

**Laminate Colors**

- L4 027 natural beech laminate
- 028 natural maple laminate
- 029 natural walnut laminate
- 031 grey white
- 035 andes grey
- 328 white
- 340 natural oak laminate
- 415 terra grey

**Network  
Single table.**

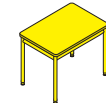
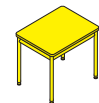
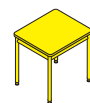
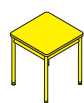

Model	21200	21421	21422	21423
<b>Standard price</b>	<b>\$456.00</b>	<b>\$465.00</b>	<b>\$480.00</b>	<b>\$506.00</b>
dimensions (wxd)	27.6 x 27.6	31.5 x 27.6	35.45 x 27.6	39.4 x 27.6
table height 20.5	0.00	0.00	0.00	0.00
table height 22.85	0.00	0.00	0.00	0.00
table height 25.2	0.00	0.00	0.00	0.00
table height 27.6	0.00	0.00	0.00	0.00
table height 28.35	0.00	0.00	0.00	0.00
table height 29.95	0.00	0.00	0.00	0.00
step height adjustment from 25.6 to 33.5	155.00	155.00	155.00	155.00
stepless height adjustment from 25.6 to 33.5	380.00	380.00	380.00	380.00
legs / top frame M1	0.00	0.00	0.00	0.00
legs / top frame M060	123.00	135.00	158.00	167.00
top 25mm chipboard décor LIGNOpal, 2.5mm KU edge, color laminate L6	0.00	0.00	0.00	0.00
horizontal cable guide	12.00	12.00	12.00	12.00
grid channel	--	111.00	111.00	111.00
cable outlet plastic, 1x	15.00	15.00	15.00	15.00
cable outlet plastic, 2x	--	33.00	33.00	33.00
cable outlet Metal, 1x	27.00	27.00	27.00	27.00
cable outlet Metal, 2x	50.00	50.00	50.00	50.00
cable outlet Metal, 3x	--	--	--	--
cable outlet Metal, 4x	--	--	--	--
adjustable plastic or felt glides	0.00	0.00	0.00	0.00
mobile casters	50.00	50.00	50.00	50.00
2 casters vert. or horiz. / 2 plastic glides	35.00	35.00	35.00	35.00
2 casters vert. or horiz. / 2 felt glides	44.00	44.00	44.00	44.00

*\*Please call for pricing if both height-adjustable legs and casters are needed as up-charges may vary.  
Veneers and Linoleum available upon request.*

**Material overview**

**Metal Colors**

- M1 030 terra grey
- 032 light blue
- 033 light green
- 041 turquoise
- 045 broom yellow
- 059 arctic
- 063 anthracite
- 065 black (RAL 9011)
- 071 sapphire blue (RAL 5003)
- 084 oxblood
- 091 white

**Laminate Colors**

- L6 017 astral silver
- 018 anthracite
- 019 plain black
- 027 natural beech laminate
- 028 natural maple laminate
- 029 natural walnut laminate
- 031 grey white
- 035 andes grey
- 328 white
- 340 natural oak laminate
- 415 terra grey

- Mx 060 chrome-plated

**Network  
Single table.**

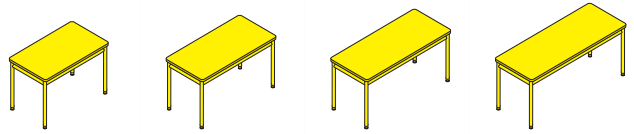

Model	21424	21201	21425	21426
<b>Standard price</b>	<b>\$582.00</b>	<b>\$649.00</b>	<b>\$681.00</b>	<b>\$731.00</b>
dimensions (wxd)	47.25 x 27.6	55.15 x 27.6	63 x 27.6	70.9 x 27.6
table height 20.5	0.00	0.00	0.00	0.00
table height 22.85	0.00	0.00	0.00	0.00
table height 25.2	0.00	0.00	0.00	0.00
table height 27.6	0.00	0.00	0.00	0.00
table height 28.35	0.00	0.00	0.00	0.00
table height 29.95	0.00	0.00	0.00	0.00
step height adjustment from 25.6 to 33.5	155.00	155.00	155.00	155.00
stepless height adjustment from 25.6 to 33.5	380.00	380.00	380.00	380.00
legs / top frame M1	0.00	0.00	0.00	0.00
legs / top frame M060	184.00	190.00	205.00	219.00
top 25mm chipboard décor LIGNOpal, 2.5mm KU edge, color laminate L6	0.00	0.00	0.00	0.00
horizontal cable guide	12.00	21.00	21.00	27.00
grid channel	132.00	135.00	158.00	175.00
cable outlet plastic, 1x	15.00	15.00	15.00	15.00
cable outlet plastic, 2x	33.00	33.00	33.00	33.00
cable outlet Metal, 1x	27.00	27.00	27.00	27.00
cable outlet Metal, 2x	50.00	50.00	50.00	50.00
cable outlet Metal, 3x	76.00	76.00	76.00	76.00
cable outlet Metal, 4x	103.00	103.00	103.00	103.00
adjustable plastic or felt glides	0.00	0.00	0.00	0.00
mobile casters	50.00	50.00	50.00	50.00
2 casters vert. or horiz. / 2 plastic glides	35.00	35.00	35.00	35.00
2 casters vert. or horiz. / 2 felt glides	44.00	44.00	44.00	44.00

*\*Please call for pricing if both height-adjustable legs and casters are needed as up-charges may vary.  
Veneers and Linoleum available upon request.*

**Material overview**

**Metal Colors**

- M1 030 terra grey
- 032 light blue
- 033 light green
- 041 turquoise
- 045 broom yellow
- 059 arctic
- 063 anthracite
- 065 black (RAL 9011)
- 071 sapphire blue (RAL 5003)
- 084 oxblood
- 091 white

**Laminate Colors**

- L6 017 astral silver
- 018 anthracite
- 019 plain black
- 027 natural beech laminate
- 028 natural maple laminate
- 029 natural walnut laminate
- 031 grey white
- 035 andes grey
- 328 white
- 340 natural oak laminate
- 415 terra grey

- Mx 060 chrome-plated

**Network  
Single table.**

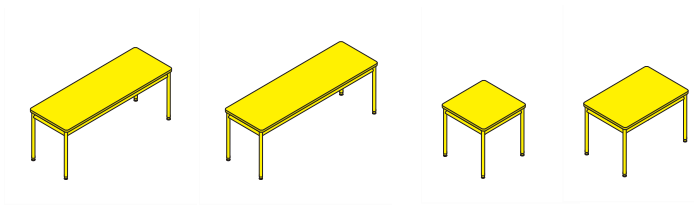

Model	21427	21428	21210	21211
<b>Standard price</b>	<b>\$736.00</b>	<b>\$853.00</b>	<b>\$509.00</b>	<b>\$669.00</b>
dimensions (wxd)	78.75 x 27.6	86.65 x 27.6	31.5 x 31.5	47.25 x 31.50
table height 20.5	0.00	0.00	0.00	0.00
table height 22.85	0.00	0.00	0.00	0.00
table height 25.2	0.00	0.00	0.00	0.00
table height 27.6	0.00	0.00	0.00	0.00
table height 28.35	0.00	0.00	0.00	0.00
table height 29.95	0.00	0.00	0.00	0.00
step height adjustment from 25.6 to 33.5	155.00	155.00	155.00	155.00
stepless height adjustment from 25.6 to 33.5	380.00	380.00	380.00	380.00
legs / top frame M1	0.00	0.00	0.00	0.00
legs / top frame M060	234.00	278.00	146.00	196.00
top 25mm chipboard décor LIGNOpal, 2.5mm KU edge, color laminate L6	0.00	0.00	0.00	0.00
horizontal cable guide	30.00	30.00	12.00	18.00
grid channel	231.00	240.00	111.00	132.00
cable outlet plastic, 1x	15.00	15.00	15.00	15.00
cable outlet plastic, 2x	33.00	33.00	33.00	33.00
cable outlet Metal, 1x	27.00	27.00	27.00	27.00
cable outlet Metal, 2x	50.00	50.00	50.00	50.00
cable outlet Metal, 3x	76.00	76.00	--	76.00
cable outlet Metal, 4x	103.00	103.00	--	103.00
adjustable plastic or felt glides	0.00	0.00	0.00	0.00
mobile casters	50.00	50.00	50.00	50.00
2 casters vert. or horiz. / 2 plastic glides	35.00	35.00	35.00	35.00
2 casters vert. or horiz. / 2 felt glides	44.00	44.00	44.00	44.00

*\*Please call for pricing if both height-adjustable legs and casters are needed as up-charges may vary.  
Veneers and Linoleum available upon request.*

**Material overview**

**Metal Colors**

- M1 030 terra grey
- 032 light blue
- 033 light green
- 041 turquoise
- 045 broom yellow
- 059 arctic
- 063 anthracite
- 065 black (RAL 9011)
- 071 sapphire blue (RAL 5003)
- 084 oxblood
- 091 white

**Laminate Colors**

- L6 017 astral silver
- 018 anthracite
- 019 plain black
- 027 natural beech laminate
- 028 natural maple laminate
- 029 natural walnut laminate
- 031 grey white
- 035 andes grey
- 328 white
- 340 natural oak laminate
- 415 terra grey

- Mx 060 chrome-plated

**Network  
Single table.**

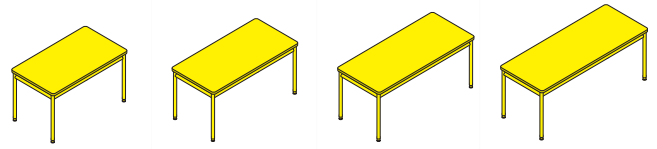

Model	21212	21213	21214	21215
<b>Standard price</b>	<b>\$766.00</b>	<b>\$856.00</b>	<b>\$935.00</b>	<b>\$958.00</b>
dimensions (wxd)	55.15 x 31.5	63 x 31.5	70.9 x 31.5	78.75 x 31.5
table height 20.5	0.00	0.00	0.00	0.00
table height 22.85	0.00	0.00	0.00	0.00
table height 25.2	0.00	0.00	0.00	0.00
table height 27.6	0.00	0.00	0.00	0.00
table height 28.35	0.00	0.00	0.00	0.00
table height 29.95	0.00	0.00	0.00	0.00
step height adjustment from 25.6 to 33.5	155.00	155.00	155.00	155.00
stepless height adjustment from 25.6 to 33.5	380.00	380.00	380.00	380.00
legs / top frame M1	0.00	0.00	0.00	0.00
legs / top frame M060	199.00	219.00	228.00	245.00
top 25mm chipboard décor LIGNOpal, 2.5mm KU edge, color laminate L6	0.00	0.00	0.00	0.00
horizontal cable guide	24.00	24.00	24.00	30.00
grid channel	135.00	158.00	175.00	231.00
cable outlet plastic, 1x	15.00	15.00	15.00	15.00
cable outlet plastic, 2x	33.00	33.00	33.00	33.00
cable outlet Metal, 1x	27.00	27.00	27.00	27.00
cable outlet Metal, 2x	50.00	50.00	50.00	50.00
cable outlet Metal, 3x	76.00	76.00	76.00	76.00
cable outlet Metal, 4x	103.00	103.00	103.00	103.00
adjustable plastic or felt glides	0.00	0.00	0.00	0.00
mobile casters	50.00	50.00	50.00	50.00
2 casters vert. or horiz. / 2 plastic glides	35.00	35.00	35.00	35.00
2 casters vert. or horiz. / 2 felt glides	44.00	44.00	44.00	44.00

*\*Please call for pricing if both height-adjustable legs and casters are needed as up-charges may vary.  
Veneers and Linoleum available upon request.*

**Material overview**

**Metal Colors**

- M1 030 terra grey
- 032 light blue
- 033 light green
- 041 turquoise
- 045 broom yellow
- 059 arctic
- 063 anthracite
- 065 black (RAL 9011)
- 071 sapphire blue (RAL 5003)
- 084 oxblood
- 091 white

**Laminate Colors**

- L6 017 astral silver
- 018 anthracite
- 019 plain black
- 027 natural beech laminate
- 028 natural maple laminate
- 029 natural walnut laminate
- 031 grey white
- 035 andes grey
- 328 white
- 340 natural oak laminate
- 415 terra grey

- Mx 060 chrome-plated

**Network  
Single table.**

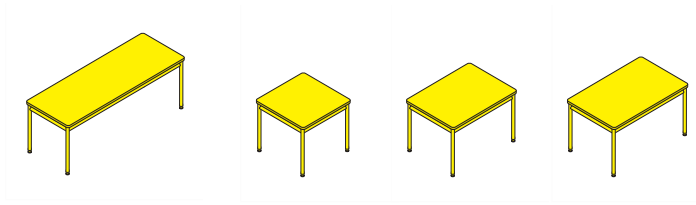

Model	21216	21240	21241	21242
<b>Standard price</b>	<b>\$993.00</b>	<b>\$599.00</b>	<b>\$699.00</b>	<b>\$766.00</b>
dimensions (wxd)	86.65 x 31.5	35.45 x 35.45	47.25 x 35.45	55.15 x 35.45
table height 20.5	0.00	0.00	0.00	0.00
table height 22.85	0.00	0.00	0.00	0.00
table height 25.2	0.00	0.00	0.00	0.00
table height 27.6	0.00	0.00	0.00	0.00
table height 28.35	0.00	0.00	0.00	0.00
table height 29.95	0.00	0.00	0.00	0.00
step height adjustment from 25.6 to 33.5	155.00	155.00	155.00	155.00
stepless height adjustment from 25.6 to 33.5	380.00	380.00	380.00	380.00
legs / top frame M1	0.00	0.00	0.00	0.00
legs / top frame M060	289.00	190.00	219.00	222.00
top 25mm chipboard décor LIGNOpal, 2.5mm KU edge, color laminate L6	0.00	0.00	0.00	0.00
horizontal cable guide	30.00	12.00	18.00	18.00
grid channel	240.00	111.00	132.00	135.00
cable outlet plastic, 1x	15.00	15.00	15.00	15.00
cable outlet plastic, 2x	33.00	33.00	33.00	33.00
cable outlet Metal, 1x	27.00	27.00	27.00	27.00
cable outlet Metal, 2x	50.00	50.00	50.00	50.00
cable outlet Metal, 3x	76.00	--	76.00	76.00
cable outlet Metal, 4x	103.00	--	103.00	103.00
adjustable plastic or felt glides	0.00	0.00	0.00	0.00
mobile casters	50.00	50.00	50.00	50.00
2 casters vert. or horiz. / 2 plastic glides	35.00	35.00	35.00	35.00
2 casters vert. or horiz. / 2 felt glides	44.00	44.00	44.00	44.00

*\*Please call for pricing if both height-adjustable legs and casters are needed as up-charges may vary.  
Veneers and Linoleum available upon request.*

**Material overview**

**Metal Colors**

- M1 030 terra grey
- 032 light blue
- 033 light green
- 041 turquoise
- 045 broom yellow
- 059 arctic
- 063 anthracite
- 065 black (RAL 9011)
- 071 sapphire blue (RAL 5003)
- 084 oxblood
- 091 white

**Laminate Colors**

- L6 017 astral silver
- 018 anthracite
- 019 plain black
- 027 natural beech laminate
- 028 natural maple laminate
- 029 natural walnut laminate
- 031 grey white
- 035 andes grey
- 328 white
- 340 natural oak laminate
- 415 terra grey

- Mx 060 chrome-plated

**Network  
Single table.**

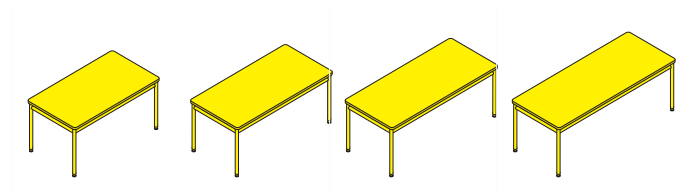

Model	21243	21244	21245	21246
<b>Standard price</b>	<b>\$830.00</b>	<b>\$862.00</b>	<b>\$911.00</b>	<b>\$1,022.00</b>
dimensions (wxd)	63 x 35.45	70.9 x 35.45	78.75 x 35.45	86.65 x 35.45
table height 20.5	0.00	0.00	0.00	0.00
table height 22.85	0.00	0.00	0.00	0.00
table height 25.2	0.00	0.00	0.00	0.00
table height 27.6	0.00	0.00	0.00	0.00
table height 28.35	0.00	0.00	0.00	0.00
table height 29.95	0.00	0.00	0.00	0.00
step height adjustment from 25.6 to 33.5	155.00	155.00	155.00	155.00
stepless height adjustment from 25.6 to 33.5	380.00	380.00	380.00	380.00
legs / top frame M1	0.00	0.00	0.00	0.00
legs / top frame M060	237.00	257.00	266.00	318.00
top 25mm chipboard décor LIGNOpal, 2.5mm KU edge, color laminate L6	0.00	0.00	0.00	0.00
horizontal cable guide	18.00	24.00	24.00	24.00
grid channel	158.00	175.00	231.00	240.00
cable outlet plastic, 1x	15.00	15.00	15.00	15.00
cable outlet plastic, 2x	33.00	33.00	33.00	33.00
cable outlet Metal, 1x	27.00	27.00	27.00	27.00
cable outlet Metal, 2x	50.00	50.00	50.00	50.00
cable outlet Metal, 3x	76.00	76.00	76.00	76.00
cable outlet Metal, 4x	103.00	103.00	103.00	103.00
adjustable plastic or felt glides	0.00	0.00	0.00	0.00
mobile casters	50.00	50.00	50.00	50.00
2 casters vert. or horiz. / 2 plastic glides	35.00	35.00	35.00	35.00
2 casters vert. or horiz. / 2 felt glides	44.00	44.00	44.00	44.00

*\*Please call for pricing if both height-adjustable legs and casters are needed as up-charges may vary.  
Veneers and Linoleum available upon request.*

**Material overview**

**Metal Colors**

- M1 030 terra grey
- 032 light blue
- 033 light green
- 041 turquoise
- 045 broom yellow
- 059 arctic
- 063 anthracite
- 065 black (RAL 9011)
- 071 sapphire blue (RAL 5003)
- 084 oxblood
- 091 white

**Laminate Colors**

- L6 017 astral silver
- 018 anthracite
- 019 plain black
- 027 natural beech laminate
- 028 natural maple laminate
- 029 natural walnut laminate
- 031 grey white
- 035 andes grey
- 328 white
- 340 natural oak laminate
- 415 terra grey

- Mx 060 chrome-plated

**Network  
Single table.**

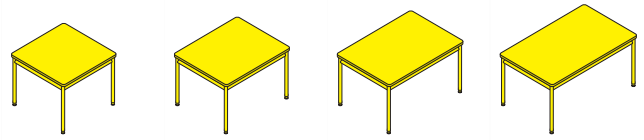

Model	21270	21271	21272	21273
<b>Standard price</b>	<b>\$626.00</b>	<b>\$710.00</b>	<b>\$763.00</b>	<b>\$792.00</b>
dimensions (wxd)	39.4 x 39.4	47.25 x 39.4	55.15 x 39.4	63 x 39.4
table height 20.5	0.00	0.00	0.00	0.00
table height 22.85	0.00	0.00	0.00	0.00
table height 25.2	0.00	0.00	0.00	0.00
table height 27.6	0.00	0.00	0.00	0.00
table height 28.35	0.00	0.00	0.00	0.00
table height 29.95	0.00	0.00	0.00	0.00
step height adjustment from 25.6 to 33.5	155.00	155.00	155.00	155.00
stepless height adjustment from 25.6 to 33.5	380.00	380.00	380.00	380.00
legs / top frame M1	0.00	0.00	0.00	0.00
legs / top frame M060	219.00	228.00	234.00	251.00
top 25mm chipboard décor LIGNOpal, 2.5mm KU edge, color laminate L6	0.00	0.00	0.00	0.00
horizontal cable guide	15.00	18.00	24.00	24.00
grid channel	111.00	132.00	135.00	158.00
cable outlet plastic, 1x	15.00	15.00	15.00	15.00
cable outlet plastic, 2x	33.00	33.00	33.00	33.00
cable outlet Metal, 1x	27.00	27.00	27.00	27.00
cable outlet Metal, 2x	50.00	50.00	50.00	50.00
cable outlet Metal, 3x	--	76.00	76.00	76.00
cable outlet Metal, 4x	--	103.00	103.00	103.00
adjustable plastic or felt glides	0.00	0.00	0.00	0.00
mobile casters	50.00	50.00	50.00	50.00
2 casters vert. or horiz. / 2 plastic glides	35.00	35.00	35.00	35.00
2 casters vert. or horiz. / 2 felt glides	44.00	44.00	44.00	44.00

*\*Please call for pricing if both height-adjustable legs and casters are needed as up-charges may vary.  
Veneers and Linoleum available upon request.*

**Material overview**

**Metal Colors**

- M1 030 terra grey
- 032 light blue
- 033 light green
- 041 turquoise
- 045 broom yellow
- 059 arctic
- 063 anthracite
- 065 black (RAL 9011)
- 071 sapphire blue (RAL 5003)
- 084 oxblood
- 091 white

**Laminate Colors**

- L6 017 astral silver
- 018 anthracite
- 019 plain black
- 027 natural beech laminate
- 028 natural maple laminate
- 029 natural walnut laminate
- 031 grey white
- 035 andes grey
- 328 white
- 340 natural oak laminate
- 415 terra grey

- Mx 060 chrome-plated

**Network  
Single table.**

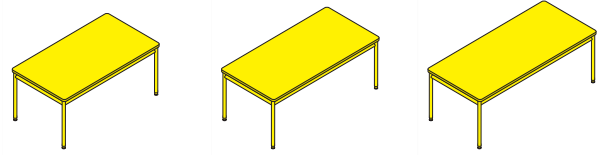

Model	21274	21275	21276
<b>Standard price</b>	<b>\$882.00</b>	<b>\$914.00</b>	<b>\$993.00</b>
dimensions (wxd)	70.9 x 39.4	78.75 x 39.4	86.65 x 39.4
table height 20.5	0.00	0.00	0.00
table height 22.85	0.00	0.00	0.00
table height 25.2	0.00	0.00	0.00
table height 27.6	0.00	0.00	0.00
table height 28.35	0.00	0.00	0.00
table height 29.95	0.00	0.00	0.00
step height adjustment from 25.6 to 33.5	155.00	155.00	155.00
stepless height adjustment from 25.6 to 33.5	380.00	380.00	380.00
legs / top frame M1	0.00	0.00	0.00
legs / top frame M060	266.00	283.00	327.00
top 25mm chipboard décor LIGNOpal, 2.5mm KU edge, color laminate L6	0.00	0.00	0.00
horizontal cable guide	24.00	30.00	30.00
grid channel	175.00	231.00	240.00
cable outlet plastic, 1x	15.00	15.00	15.00
cable outlet plastic, 2x	33.00	33.00	33.00
cable outlet Metal, 1x	27.00	27.00	27.00
cable outlet Metal, 2x	50.00	50.00	50.00
cable outlet Metal, 3x	76.00	76.00	76.00
cable outlet Metal, 4x	103.00	103.00	103.00
adjustable plastic or felt glides	0.00	0.00	0.00
mobile casters	50.00	50.00	50.00
2 casters vert. or horiz. / 2 plastic glides	35.00	35.00	35.00
2 casters vert. or horiz. / 2 felt glides	44.00	44.00	44.00

*\*Please call for pricing if both height-adjustable legs and casters are needed as up-charges may vary.  
Veneers and Linoleum available upon request.*

**Material overview**

**Metal Colors**

- M1 030 terra grey
- 032 light blue
- 033 light green
- 041 turquoise
- 045 broom yellow
- 059 arctic
- 063 anthracite
- 065 black (RAL 9011)
- 071 sapphire blue (RAL 5003)
- 084 oxblood
- 091 white

**Laminate Colors**

- L6 017 astral silver
- 018 anthracite
- 019 plain black
- 027 natural beech laminate
- 028 natural maple laminate
- 029 natural walnut laminate
- 031 grey white
- 035 andes grey
- 328 white
- 340 natural oak laminate
- 415 terra grey

- Mx 060 chrome-plated

**Network  
Single table.**

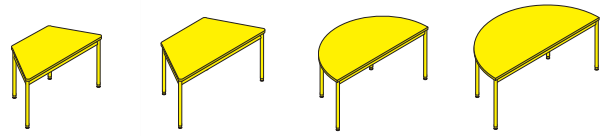

Model	21202	21217	21208	21218
<b>Standard price</b>	<b>\$661.00</b>	<b>\$719.00</b>	<b>\$661.00</b>	<b>\$780.00</b>
dimensions (wxd)	55.15 x 27.6	63 x 31.5	55.15 x 27.6	63 x 31.5
table height 20.5	0.00	0.00	0.00	0.00
table height 22.85	0.00	0.00	0.00	0.00
table height 25.2	0.00	0.00	0.00	0.00
table height 27.6	0.00	0.00	0.00	0.00
table height 28.35	0.00	0.00	0.00	0.00
table height 29.95	0.00	0.00	0.00	0.00
step height adjustment from 25.6 to 33.5	155.00	155.00	155.00	155.00
legs / top frame M1	0.00	0.00	0.00	0.00
legs / top frame M060	228.00	245.00	228.00	245.00
top 25mm chipboard décor LIGNOpal, 2.5mm KU edge, color laminate L6	0.00	0.00	0.00	0.00
horizontal cable guide	--	--	--	--
grid channel	--	--	--	--
adjustable plastic or felt glides	0.00	0.00	0.00	0.00
mobile casters	50.00	50.00	--	--
2 casters vert. / 2 plastic glides	35.00	35.00	35.00	35.00
2 casters vertical / 2 felt glides	44.00	44.00	44.00	44.00

*\*Please call for pricing if both height-adjustable legs and casters are needed as up-charges may vary.  
Veneers and Linoleum available upon request.*

**Material overview**

**Metal Colors**

- M1 030 terra grey
- 032 light blue
- 033 light green
- 041 turquoise
- 045 broom yellow
- 059 arctic
- 063 anthracite
- 065 black (RAL 9011)
- 071 sapphire blue (RAL 5003)
- 084 oxblood
- 091 white

**Laminate Colors**

- L6 017 astral silver
- 018 anthracite
- 019 plain black
- 027 natural beech laminate
- 028 natural maple laminate
- 029 natural walnut laminate
- 031 grey white
- 035 andes grey
- 328 white
- 340 natural oak laminate
- 415 terra grey

- Mx 060 chrome-plated

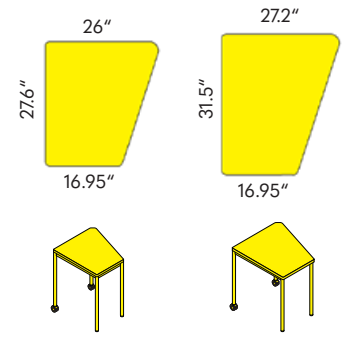

**Tano**  
Asymmetric stacking table.

Model	01492	01493
<b>Standard price</b>	<b>\$445.00</b>	<b>\$468.00</b>
dimensions (wxd) (Ø)	27.6 x 26 (16.95)	31.5 x 27.2 (16.95)
max. number stackable	6	6
table height 15.75 (No. 0 white)	-8.00	-8.00
table height 20.9 (No. 2 violet)	0.00	0.00
table height 23.25 (No. 3 yellow)	0.00	0.00
table height 25.2 (No. 4 red)	0.00	0.00
table height 28 (No. 5 green)	0.00	0.00
table height 29.15	0.00	0.00
table height 29.95 (No. 6 blue)	0.00	0.00
table height 32.3 (No. 7 brown)	0.00	0.00
step height adjustment from 23.25 - 32.3	68.00	68.00
metal color M1	0.00	0.00
top 19mm chipboard laminated (CPL), 2.5mm KU edge, color laminate L2	0.00	0.00
top 19mm chipboard laminated (CPL) writeable, 2.5mm KU edge in white	111.00	111.00
with plastic bin 3in, C3	47.00	47.00
with plastic bin 3in with lid, C3	59.00	59.00
with rails, without plastic bin	33.00	33.00
satchel hooks	6.00	6.00
plastic glides	2.00	2.00
adjustable plastic glides	12.00	12.00
felt glides	2.00	2.00
adjustable felt glides	12.00	12.00
2-component glides	2.00	2.00
2 casters, 2 plastic glides	0.00	0.00
2 casters, 2 felt glides	0.00	0.00
2 casters, 2 2-component glides	0.00	0.00

**Material overview**

**Metal Colors**

M1	030	terra grey
	032	light blue
	033	light green
	041	turquoise
	045	broom yellow
	059	arctic
	063	anthracite
	065	black (RAL 9011)
	071	sapphire blue (RAL 5003)
	084	oxblood
	091	white

**Plastic Colors**

C3	001	red
	014	anthracite
	016	translucent
	030	dark red
	031	dark blue
	032	light blue
	033	light green
	038	turquoise
	039	broom yellow

**Laminate Colors**

L2	027	natural beech laminate
	028	natural maple laminate
	031	grey white
	035	andes grey
	328	white

**EcoTable-R**  
Student's table with round tubular legs.

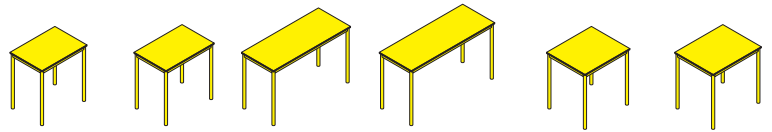

Model	23000	23001	23002	23003	23005	23006
<b>Standard price</b>	<b>\$328.00</b>	<b>\$334.00</b>	<b>\$445.00</b>	<b>\$477.00</b>	<b>\$392.00</b>	<b>\$386.00</b>
dimensions (wxd)	27.6 x 19.7	29.55 x 19.7	47.25 x 19.7	51.2 x 19.7	27.6 x 23.65	29.55 x 23.65
table height 15.75 (No. 0 white)	0.00	0.00	0.00	0.00	0.00	0.00
table height 20.9 (No. 2 violet)	0.00	0.00	0.00	0.00	0.00	0.00
table height 23.25 (No. 3 yellow)	0.00	0.00	0.00	0.00	0.00	0.00
table height 25.2 (No. 4 red)	0.00	0.00	0.00	0.00	0.00	0.00
table height 28 (No. 5 green)	0.00	0.00	0.00	0.00	0.00	0.00
table height 29.15*	--	--	--	--	0.00	0.00
table height 29.95 (No. 6 blue)	0.00	0.00	0.00	0.00	0.00	0.00
table height 32.3 (No. 7 brown)	0.00	0.00	0.00	0.00	0.00	0.00
step height adjustment 23.25 to 32.3	68.00	68.00	68.00	68.00	68.00	68.00
metal color M1	0.00	0.00	0.00	0.00	0.00	0.00
top 19mm chipboard laminated (CPL), 2.5mm KU edge, color laminate L2	0.00	0.00	0.00	0.00	0.00	0.00
metal grid bookshelf	18.00	18.00	35.00	35.00	18.00	18.00
guide rails ONLY for 3 in. box	47.00	47.00	94.00	94.00	47.00	47.00
with plastic box 3 in. high, plastic color C3	65.00	65.00	126.00	126.00	65.00	65.00
with plastic box 3 in. high, plastic color C3 with cover	77.00	77.00	138.00	138.00	77.00	77.00
satchel hooks	6.00	6.00	12.00	12.00	6.00	6.00
with 11.88 modesty screen in LIGNOpal L3	73.00	73.00	82.00	88.00	73.00	73.00
with grid channel	--	--	--	--	68.00	68.00
cable outlet left, outside	--	--	--	--	30.00	30.00
cable outlet left, inside	--	--	--	--	30.00	30.00
cable outlet right, outside	--	--	--	--	30.00	30.00
cable outlet right, inside	--	--	--	--	30.00	30.00
1 cable outlet centered	--	--	--	--	30.00	30.00
plastic glides	0.00	0.00	0.00	0.00	0.00	0.00
adjustable plastic glides	0.00	0.00	0.00	0.00	0.00	0.00
felt glides	0.00	0.00	0.00	0.00	0.00	0.00
adjustable felt glides	0.00	0.00	0.00	0.00	0.00	0.00
2-component glides	0.00	0.00	0.00	0.00	0.00	0.00
mobile	50.00	50.00	50.00	50.00	50.00	50.00
2 rear casters, 2 plastic glides	27.00	27.00	27.00	27.00	27.00	27.00
2 rear casters, 2 felt glides	27.00	27.00	30.00	30.00	27.00	27.00
2 rear casters, 2 component glides	27.00	27.00	27.00	27.00	27.00	27.00

\*29.15" table height cannot be combined with casters.

**Material overview**

Metal Colors	Plastic Colors	Laminate Colors	
M1 030 terra grey	C3 001 red	L2 027 natural beech laminate	029 natural walnut laminate
032 light blue	014 anthracite	028 natural maple laminate	031 grey white
033 light green	016 translucent	031 grey white	035 andes grey
041 turquoise	030 dark red	035 andes grey	328 white
045 broom yellow	031 dark blue	328 white	340 natural oak laminate
059 arctic	032 light blue		415 terra grey
063 anthracite	033 light green	L3 017 astral silver	
065 black (RAL 9011)	038 turquoise	018 anthracite	
071 sapphire blue (RAL 5003)	039 broom yellow	019 plain black	
084 oxblood		027 natural beech laminate	
091 white		028 natural maple laminate	

**EcoTable-R**  
Student's table with round tubular legs.

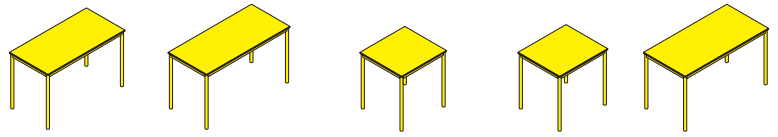

Model	23007	23008	23010	23011	23013
<b>Standard price</b>	<b>\$541.00</b>	<b>\$547.00</b>	<b>\$366.00</b>	<b>\$378.00</b>	<b>\$652.00</b>
dimensions (wxd)	47.25 x 23.65	51.2 x 23.65	27.6 x 25.6	29.55 x 25.6	51.2 x 25.6
table height 15.75 (No. 0 white)	0.00	0.00	0.00	0.00	0.00
table height 20.9 (No. 2 violet)	0.00	0.00	0.00	0.00	0.00
table height 23.25 (No. 3 yellow)	0.00	0.00	0.00	0.00	0.00
table height 25.2 (No. 4 red)	0.00	0.00	0.00	0.00	0.00
table height 28 (No. 5 green)	0.00	0.00	0.00	0.00	0.00
table height 29.15*	0.00	0.00	--	--	--
table height 29.95 (No. 6 blue)	0.00	0.00	0.00	0.00	0.00
table height 32.3 (No. 7 brown)	0.00	0.00	0.00	0.00	0.00
step height adjustment 23.25 to 32.3	68.00	68.00	68.00	68.00	68.00
metal color M1	0.00	0.00	0.00	0.00	0.00
top 19mm chipboard laminated (CPL), 2.5mm KU edge, color laminate L2	0.00	0.00	0.00	0.00	0.00
metal grid bookshelf	35.00	35.00	18.00	18.00	35.00
guide rails ONLY for 3 in. box	94.00	94.00	47.00	47.00	94.00
with plastic box 3 in. high, plastic color C3	126.00	126.00	65.00	65.00	126.00
with plastic box 3 in. high, plastic color C3 with cover	138.00	138.00	77.00	77.00	138.00
satchel hooks	12.00	12.00	6.00	6.00	12.00
with 11.88 modesty screen in LIGNOpal L3	82.00	88.00	73.00	73.00	88.00
with grid channel	82.00	82.00	68.00	68.00	82.00
cable outlet left, outside	30.00	30.00	30.00	30.00	30.00
cable outlet left, inside	30.00	30.00	30.00	30.00	30.00
cable outlet right, outside	30.00	30.00	30.00	30.00	30.00
cable outlet right, inside	30.00	30.00	30.00	30.00	30.00
1 cable outlet centered	30.00	30.00	30.00	30.00	30.00
plastic glides	0.00	0.00	0.00	0.00	0.00
adjustable plastic glides	0.00	0.00	0.00	0.00	0.00
felt glides	0.00	0.00	0.00	0.00	0.00
adjustable felt glides	0.00	0.00	0.00	0.00	0.00
2-component glides	0.00	0.00	0.00	0.00	0.00
mobile	50.00	50.00	50.00	50.00	50.00
2 rear casters, 2 plastic glides	27.00	27.00	27.00	27.00	27.00
2 rear casters, 2 felt glides	30.00	30.00	27.00	27.00	30.00
2 rear casters, 2 component glides	27.00	27.00	27.00	27.00	27.00

\*29.15" table height cannot be combined with casters.

**Material overview**

**Metal Colors**

M1	030	terra grey
	032	light blue
	033	light green
	041	turquoise
	045	broom yellow
	059	arctic
	063	anthracite
	065	black (RAL 9011)
	071	sapphire blue (RAL 5003)
	084	oxblood
	091	white

**Plastic Colors**

C3	001	red
	014	anthracite
	016	translucent
	030	dark red
	031	dark blue
	032	light blue
	033	light green
	038	turquoise
	039	broom yellow

**Laminate Colors**

L2	027	natural beech laminate	029	natural walnut laminate
	028	natural maple laminate	031	grey white
	031	grey white	035	andes grey
	035	andes grey	328	white
	328	white	340	natural oak laminate
			415	terra grey
L3	017	astral silver		
	018	anthracite		
	019	plain black		
	027	natural beech laminate		
	028	natural maple laminate		

**EcoTable-R**  
Office desk with round tubular legs.

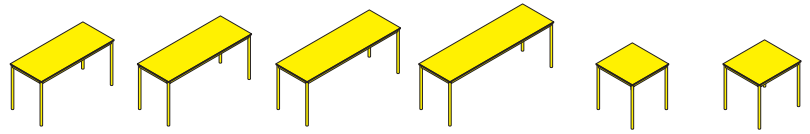

Model	23064	23065	23066	23067	23070	23071
<b>Standard price</b>	<b>\$582.00</b>	<b>\$640.00</b>	<b>\$699.00</b>	<b>\$728.00</b>	<b>\$404.00</b>	<b>\$404.00</b>
dimensions (wxd)	55.15 x 23.65	63 x 23.65	70.9 x 23.65	78.75 x 23.65	27.6 x 27.6	31.5 x 27.6
table height 15.75 (No. 0 white)	0.00	0.00	0.00	0.00	0.00	0.00
table height 20.9 (No. 2 violet)	0.00	0.00	0.00	0.00	0.00	0.00
table height 23.25 (No. 3 yellow)	0.00	0.00	0.00	0.00	0.00	0.00
table height 25.2 (No. 4 red)	0.00	0.00	0.00	0.00	0.00	0.00
table height 28 (No. 5 green)	0.00	0.00	0.00	0.00	0.00	0.00
table height 29.15*	0.00	0.00	0.00	0.00	0.00	0.00
table height 29.95 (No. 6 blue)	0.00	0.00	0.00	0.00	0.00	0.00
table height 32.3 (No. 7 brown)	0.00	0.00	0.00	0.00	0.00	0.00
step height adjustment 23.25 to 32.3	68.00	68.00	68.00	68.00	68.00	68.00
metal color M1	0.00	0.00	0.00	0.00	0.00	0.00
top 19mm chipboard laminated (CPL), 2.5mm KU edge, color laminate L2	0.00	0.00	0.00	0.00	0.00	0.00
with grid channel	97.00	126.00	132.00	155.00	68.00	68.00
cable outlet left, outside	30.00	30.00	30.00	30.00	30.00	30.00
cable outlet left, inside	30.00	30.00	30.00	30.00	30.00	30.00
cable outlet right, outside	30.00	30.00	30.00	30.00	30.00	30.00
cable outlet right, inside	30.00	30.00	30.00	30.00	30.00	30.00
1 cable outlet centered	30.00	30.00	30.00	30.00	30.00	30.00
with 11.88 modesty screen in LIGNOpal L3	88.00	111.00	111.00	117.00	73.00	73.00
plastic glides	0.00	0.00	0.00	0.00	0.00	0.00
adjustable plastic glides	0.00	0.00	0.00	0.00	0.00	0.00
felt glides	0.00	0.00	0.00	0.00	0.00	0.00
adjustable felt glides	0.00	0.00	0.00	0.00	0.00	0.00
2-component glides	0.00	0.00	0.00	0.00	0.00	0.00
mobile	50.00	50.00	50.00	50.00	50.00	50.00
2 casters left, 2 plastic glides	27.00	27.00	27.00	27.00	27.00	27.00
2 casters left, 2 felt glides	30.00	30.00	30.00	30.00	30.00	30.00
2 casters left, 2 component glides	27.00	27.00	27.00	27.00	27.00	27.00

\*29.15" table height cannot be combined with casters.

Veneers available upon request.

**Material overview**

**Metal Colors**

- M1 030 terra grey
- 032 light blue
- 033 light green
- 041 turquoise
- 045 broom yellow
- 059 arctic
- 063 anthracite
- 065 black (RAL 9011)
- 071 sapphire blue (RAL 5003)
- 084 oxblood
- 091 white

**Laminate Colors**

- L2 027 natural beech laminate
- 028 natural maple laminate
- 031 grey white
- 035 andes grey
- 328 white
- L3 017 astral silver
- 018 anthracite
- 019 plain black
- 027 natural beech laminate
- 028 natural maple laminate
- 029 natural walnut laminate
- 031 grey white
- 035 andes grey
- 328 white
- 340 natural oak laminate
- 415 terra grey

**EcoTable-R**  
Office desk with round tubular legs.

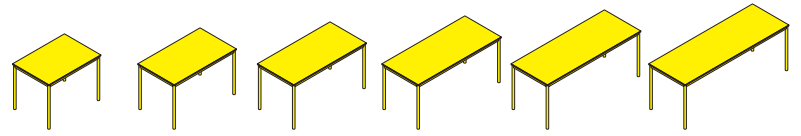

Model	23072	23073	23074	23075	23076	23077
<b>Standard price</b>	<b>\$483.00</b>	<b>\$541.00</b>	<b>\$629.00</b>	<b>\$634.00</b>	<b>\$716.00</b>	<b>\$774.00</b>
dimensions (wxd)	39.4 x 27.6	47.25 x 27.6	55.15 x 27.6	63 x 27.6	70.9 x 27.6	78.75 x 27.6
table height 15.75 (No. 0 white)	0.00	0.00	0.00	0.00	0.00	0.00
table height 20.9 (No. 2 violet)	0.00	0.00	0.00	0.00	0.00	0.00
table height 23.25 (No. 3 yellow)	0.00	0.00	0.00	0.00	0.00	0.00
table height 25.2 (No. 4 red)	0.00	0.00	0.00	0.00	0.00	0.00
table height 28 (No. 5 green)	0.00	0.00	0.00	0.00	0.00	0.00
table height 29.15*	0.00	0.00	0.00	0.00	0.00	0.00
table height 29.95 (No. 6 blue)	0.00	0.00	0.00	0.00	0.00	0.00
table height 32.3 (No. 7 brown)	0.00	0.00	0.00	0.00	0.00	0.00
step height adjustment 23.25 to 32.3	68.00	68.00	68.00	68.00	68.00	68.00
metal color M1	0.00	0.00	0.00	0.00	0.00	0.00
top 19mm chipboard laminated (CPL), 2.5mm KU edge, color laminate L2	0.00	0.00	0.00	0.00	0.00	0.00
with grid channel	68.00	82.00	97.00	126.00	132.00	155.00
cable outlet left outside	30.00	30.00	30.00	30.00	30.00	30.00
cable outlet left inside	30.00	30.00	30.00	30.00	30.00	30.00
cable outlet right outside	30.00	30.00	30.00	30.00	30.00	30.00
cable outlet right inside	30.00	30.00	30.00	30.00	30.00	30.00
1 cable outlet centered	30.00	30.00	30.00	30.00	30.00	30.00
with 11.88 modesty screen in LIGNOpal L3	73.00	79.00	88.00	111.00	111.00	219.00
plastic glides	0.00	0.00	0.00	0.00	0.00	0.00
adjustable plastic glides	0.00	0.00	0.00	0.00	0.00	0.00
felt glides	0.00	0.00	0.00	0.00	0.00	0.00
adjustable felt glides	0.00	0.00	0.00	0.00	0.00	0.00
2-component glides	0.00	0.00	0.00	0.00	0.00	0.00
mobile	50.00	50.00	50.00	50.00	50.00	50.00
2 casters left, 2 plastic glides	27.00	27.00	27.00	27.00	27.00	27.00
2 casters left, 2 felt glides	30.00	30.00	30.00	30.00	30.00	30.00
2 casters left, 2 component glides	27.00	27.00	27.00	27.00	27.00	27.00

\*29.15" table height cannot be combined with casters.

Veneers available upon request.

**Material overview**

**Metal Colors**

- M1 030 terra grey
- 032 light blue
- 033 light green
- 041 turquoise
- 045 broom yellow
- 059 arctic
- 063 anthracite
- 065 black (RAL 9011)
- 071 sapphire blue (RAL 5003)
- 084 oxblood
- 091 white

**Laminate Colors**

- L2 027 natural beech laminate
- 028 natural maple laminate
- 031 grey white
- 035 andes grey
- 328 white
- L3 017 astral silver
- 018 anthracite
- 019 plain black
- 027 natural beech laminate
- 028 natural maple laminate
- 029 natural walnut laminate
- 031 grey white
- 035 andes grey
- 328 white
- 340 natural oak laminate
- 415 terra grey

**EcoTable-R**  
Office desk with round tubular legs.

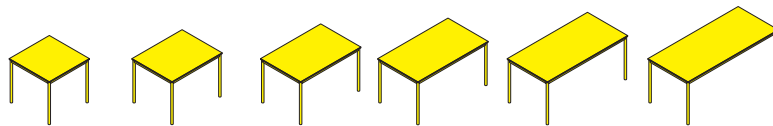

Model	23081	23082	23083	23084	23085	23086
<b>Standard price</b>	<b>\$532.00</b>	<b>\$576.00</b>	<b>\$649.00</b>	<b>\$707.00</b>	<b>\$757.00</b>	<b>\$786.00</b>
dimensions (wxd)	31.5 x 31.5	39.4 x 31.5	47.25 x 31.5	55.15 x 31.5	63 x 31.5	70.9 x 31.5
table height 15.75 (No. 0 white)	0.00	0.00	0.00	0.00	0.00	0.00
table height 20.9 (No. 2 violet)	0.00	0.00	0.00	0.00	0.00	0.00
table height 23.25 (No. 3 yellow)	0.00	0.00	0.00	0.00	0.00	0.00
table height 25.2 (No. 4 red)	0.00	0.00	0.00	0.00	0.00	0.00
table height 28 (No. 5 green)	0.00	0.00	0.00	0.00	0.00	0.00
table height 29.15*	0.00	0.00	0.00	0.00	0.00	0.00
table height 29.95 (No. 6 blue)	0.00	0.00	0.00	0.00	0.00	0.00
table height 32.3 (No. 7 brown)	0.00	0.00	0.00	0.00	0.00	0.00
step height adjustment 23.25 to 32.3	68.00	68.00	68.00	68.00	68.00	68.00
metal color M1	0.00	0.00	0.00	0.00	0.00	0.00
top 19mm chipboard laminated (CPL), 2.5mm KU edge, color laminate L2	0.00	0.00	0.00	0.00	0.00	0.00
with grid channel	68.00	68.00	82.00	97.00	126.00	132.00
cable outlet left, outside	30.00	30.00	30.00	30.00	30.00	30.00
cable outlet left, inside	30.00	30.00	30.00	30.00	30.00	30.00
cable outlet right, outside	30.00	30.00	30.00	30.00	30.00	30.00
cable outlet right, inside	30.00	30.00	30.00	30.00	30.00	30.00
1 cable outlet centered	30.00	30.00	30.00	30.00	30.00	30.00
with 11.88 modesty screen in LIGNOpal L3	73.00	73.00	73.00	88.00	111.00	111.00
plastic glides	0.00	0.00	0.00	0.00	0.00	0.00
adjustable plastic glides	0.00	0.00	0.00	0.00	0.00	0.00
felt glides	0.00	0.00	0.00	0.00	0.00	0.00
adjustable felt glides	0.00	0.00	0.00	0.00	0.00	0.00
2-component glides	0.00	0.00	0.00	0.00	0.00	0.00
mobile	50.00	50.00	50.00	50.00	50.00	50.00
2 casters left, 2 plastic glides	27.00	27.00	27.00	27.00	27.00	27.00
2 casters left, 2 felt glides	30.00	30.00	30.00	30.00	30.00	30.00
2 casters left, 2 component glides	27.00	27.00	27.00	27.00	27.00	27.00

\*29.15" table height cannot be combined with casters.

Veneers available upon request.

**Material overview**

**Metal Colors**

- M1 030 terra grey
- 032 light blue
- 033 light green
- 041 turquoise
- 045 broom yellow
- 059 arctic
- 063 anthracite
- 065 black (RAL 9011)
- 071 sapphire blue (RAL 5003)
- 084 oxblood
- 091 white

**Laminate Colors**

- L2 027 natural beech laminate
- 028 natural maple laminate
- 031 grey white
- 035 andes grey
- 328 white
- L3 017 astral silver
- 018 anthracite
- 019 plain black
- 027 natural beech laminate
- 028 natural maple laminate
- 029 natural walnut laminate
- 031 grey white
- 035 andes grey
- 328 white
- 340 natural oak laminate
- 415 terra grey

**EcoTable-R**  
Office desk with round tubular legs.

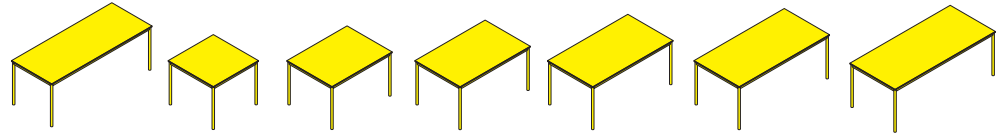

Model	23087	23091	23093	23094	23095	23096	23097
<b>Standard price</b>	<b>\$949.00</b>	<b>\$556.00</b>	<b>\$672.00</b>	<b>\$774.00</b>	<b>\$847.00</b>	<b>\$862.00</b>	<b>\$935.00</b>
dimensions (wxd)	78.75 x 31.5	35.45 x 35.45	47.25 x 35.45	55.15 x 35.45	63 x 35.45	70.9 x 35.45	78.75 x 35.45
table height 15.75 (No. 0 white)	0.00	0.00	0.00	0.00	0.00	0.00	0.00
table height 20.9 (No. 2 violet)	0.00	0.00	0.00	0.00	0.00	0.00	0.00
table height 23.25 (No. 3 yellow)	0.00	0.00	0.00	0.00	0.00	0.00	0.00
table height 25.2 (No. 4 red)	0.00	0.00	0.00	0.00	0.00	0.00	0.00
table height 28 (No. 5 green)	0.00	0.00	0.00	0.00	0.00	0.00	0.00
table height 29.15*	0.00	0.00	0.00	0.00	0.00	0.00	0.00
table height 29.95 (No. 6 blue)	0.00	0.00	0.00	0.00	0.00	0.00	0.00
table height 32.3 (No. 7 brown)	0.00	0.00	0.00	0.00	0.00	0.00	0.00
step height adjustment 23.25 to 32.3	68.00	68.00	68.00	68.00	68.00	68.00	68.00
metal color M1	0.00	0.00	0.00	0.00	0.00	0.00	0.00
top 19mm chipboard laminated (CPL), 2.5mm KU edge, color laminate L2	0.00	0.00	0.00	0.00	0.00	0.00	0.00
with grid channel	155.00	68.00	82.00	97.00	126.00	132.00	155.00
cable outlet left, outside	30.00	30.00	30.00	30.00	30.00	30.00	30.00
cable outlet left, inside	30.00	30.00	30.00	30.00	30.00	30.00	30.00
cable outlet right, outside	30.00	30.00	30.00	30.00	30.00	30.00	30.00
cable outlet right, inside	30.00	30.00	30.00	30.00	30.00	30.00	30.00
1 cable outlet centered	30.00	30.00	30.00	30.00	30.00	30.00	30.00
with 11.88 modesty screen in LIGNOpal L3	117.00	73.00	82.00	88.00	111.00	111.00	117.00
plastic glides	0.00	0.00	0.00	0.00	0.00	0.00	0.00
adjustable plastic glides	0.00	0.00	0.00	0.00	0.00	0.00	0.00
felt glides	0.00	0.00	0.00	0.00	0.00	0.00	0.00
adjustable felt glides	0.00	0.00	0.00	0.00	0.00	0.00	0.00
2-component glides	0.00	0.00	0.00	0.00	0.00	0.00	0.00
mobile	50.00	50.00	50.00	50.00	50.00	50.00	50.00
2 casters left, 2 plastic glides	27.00	27.00	27.00	27.00	27.00	27.00	27.00
2 casters left, 2 felt glides	30.00	30.00	30.00	30.00	30.00	30.00	30.00
2 casters left, 2 component glides	27.00	27.00	27.00	27.00	27.00	27.00	27.00

\*29.15" table height cannot be combined with casters.

Veneers available upon request.

**Material overview**

**Metal Colors**

- M1 030 terra grey
- 032 light blue
- 033 light green
- 041 turquoise
- 045 broom yellow
- 059 arctic
- 063 anthracite
- 065 black (RAL 9011)
- 071 sapphire blue (RAL 5003)
- 084 oxblood
- 091 white

**Laminate Colors**

- L2 027 natural beech laminate
- 028 natural maple laminate
- 031 grey white
- 035 andes grey
- 328 white
- L3 017 astral silver
- 018 anthracite
- 019 plain black
- 027 natural beech laminate
- 028 natural maple laminate
- 029 natural walnut laminate
- 031 grey white
- 035 andes grey
- 328 white
- 340 natural oak laminate
- 415 terra grey

**EcoTable-R**  
Trapezoidal and semi-circular table with round tubular legs.



Model	23014	23079	23089
<b>Standard price</b>	<b>\$629.00</b>	<b>\$745.00</b>	<b>\$804.00</b>
dimensions (wxd)	51.2 x 25.6	55.15 x 27.6	63 x 31.5
table height 15.75 (No. 0 white)	0.00	0.00	0.00
table height 20.9 (No. 2 violet)	0.00	0.00	0.00
table height 23.25 (No. 3 yellow)	0.00	0.00	0.00
table height 25.2 (No. 4 red)	0.00	0.00	0.00
table height 28 (No. 5 green)	0.00	0.00	0.00
table height 29.15*	0.00	0.00	0.00
table height 29.95 (No. 6 blue)	0.00	0.00	0.00
table height 32.38 (No. 7 brown)	0.00	0.00	0.00
step height adjustment 23.25 to 32.3	68.00	68.00	68.00
metal color M1	0.00	0.00	0.00
top 19mm chipboard laminated (CPL), 2.5mm KU edge, color laminate L2	0.00	0.00	0.00
metal grid bookshelf	18.00	--	--
satchel hooks	6.00	--	--
plastic glides	0.00	0.00	0.00
adjustable plastic glides	0.00	0.00	0.00
felt glides	0.00	0.00	0.00
adjustable felt glides	0.00	0.00	0.00
2-component glides	0.00	0.00	0.00
2 left casters, 2 plastic glides	27.00	27.00	27.00
2 left casters, 2 felt glides	30.00	30.00	30.00
2 left casters, 2 component glides	27.00	27.00	27.00

\*29.15" table height cannot be combined with casters.

Veneers available upon request.

**Material overview**

**Metal Colors**

- M1 030 terra grey
- 032 light blue
- 033 light green
- 041 turquoise
- 045 broom yellow
- 059 arctic
- 063 anthracite
- 065 black (RAL 9011)
- 071 sapphire blue (RAL 5003)
- 084 oxblood
- 091 white

**Laminate Colors**

- L2 027 natural beech laminate
- 028 natural maple laminate
- 031 grey white
- 035 andes grey
- 328 white

**EcoTable-R**  
Trapezoidal and semi-circular table with round tubular legs.

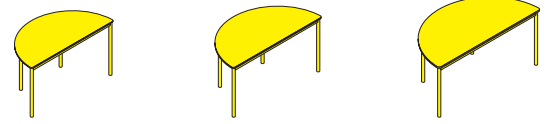

Model	23015	23078	23088
<b>Standard price</b>	<b>\$669.00</b>	<b>\$699.00</b>	<b>\$786.00</b>
dimensions (wxd)	51.2 x 25.6	55.15 x 27.6	63 x 31.5
table height 15.75 (No. 0 white)	0.00	0.00	0.00
table height 20.9 (No. 2 violet)	0.00	0.00	0.00
table height 23.25 (No. 3 yellow)	0.00	0.00	0.00
table height 25.2 (No. 4 red)	0.00	0.00	0.00
table height 28 (No. 5 green)	0.00	0.00	0.00
table height 29.15*	0.00	0.00	0.00
table height 29.95 (No. 6 blue)	0.00	0.00	0.00
table height 32.3 (No. 7 brown)	0.00	0.00	0.00
step height adjustment 23.25 to 32.3	68.00	68.00	68.00
metal color M1	0.00	0.00	0.00
top 19mm chipboard laminated (CPL), 2.5mm KU edge, color laminate L2	0.00	0.00	0.00
metal grid bookshelf	--	--	--
satchel hooks	--	--	--
plastic glides	0.00	0.00	0.00
adjustable plastic glides	0.00	0.00	0.00
felt glides	0.00	0.00	0.00
adjustable felt glides	0.00	0.00	0.00
2-component glides	0.00	0.00	0.00
2 left casters, 2 plastic glides	27.00	27.00	27.00
2 left casters, 2 felt glides	30.00	30.00	30.00
2 left casters, 2 component glides	27.00	27.00	27.00

\*29.15" table height cannot be combined with casters.

Veneers available upon request.

**Material overview**

**Metal Colors**

- M1 030 terra grey
- 032 light blue
- 033 light green
- 041 turquoise
- 045 broom yellow
- 059 arctic
- 063 anthracite
- 065 black (RAL 9011)
- 071 sapphire blue (RAL 5003)
- 084 oxblood
- 091 white

**Laminate Colors**

- L2 027 natural beech laminate
- 028 natural maple laminate
- 031 grey white
- 035 andes grey
- 328 white

**EcoTable-R**  
Round table with round tubular legs.

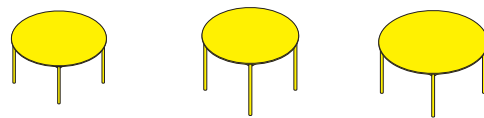

Model	23050	23051	23053
<b>Standard price</b>	<b>\$701.00</b>	<b>\$716.00</b>	<b>\$935.00</b>
dimensions (wxd) (Ø)	35.45	39.4	47.25
table height 15.75 (No. 0 white)	0.00	0.00	0.00
table height 20.9 (No. 2 violet)	0.00	0.00	0.00
table height 23.25 (No. 3 yellow)	0.00	0.00	0.00
table height 25.2 (No. 4 red)	0.00	0.00	0.00
table height 28 (No. 5 green)	0.00	0.00	0.00
table height 29.15*	0.00	0.00	0.00
table height 29.95 (No. 6 blue)	0.00	0.00	0.00
table height 32.3 (No. 7 brown)	0.00	0.00	0.00
step height adjustment 23.25 to 32.3	68.00	68.00	68.00
metal color M1	0.00	0.00	0.00
top 19mm chipboard laminated (CPL), 2.5mm KU edge, color laminate L2	0.00	0.00	0.00
metal grid bookshelf	--	--	--
satchel hooks	--	--	--
plastic glides	0.00	0.00	0.00
adjustable plastic glides	12.00	12.00	12.00
felt glides	0.00	0.00	0.00
adjustable felt glides	12.00	12.00	12.00
2-component glides	0.00	0.00	0.00
mobile	50.00	50.00	50.00
2 casters, 2 plastic glides	35.00	35.00	35.00
2 casters, 2 felt glides	41.00	41.00	41.00
2 casters, 2 component glides	35.00	35.00	35.00

\*29.15" table height cannot be combined with casters.

Veneers available upon request.

### Material overview

#### Metal Colors

M1	030	terra grey
	032	light blue
	033	light green
	041	turquoise
	045	broom yellow
	059	arctic
	063	anthracite
	065	black (RAL 9011)
	071	sapphire blue (RAL 5003)
	084	oxblood
	091	white

#### Laminate Colors

L2	027	natural beech laminate
	028	natural maple laminate
	031	grey white
	035	andes grey
	328	white

**EcoTable-R**  
Teacher's table with round tubular legs.

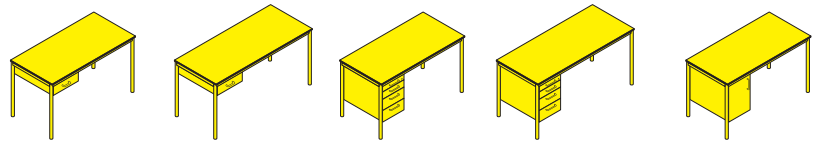

Model	23020	23030	23021	23031	23022
<b>Standard price</b>	<b>\$1,226.00</b>	<b>\$1,241.00</b>	<b>\$1,562.00</b>	<b>\$1,708.00</b>	<b>\$891.00</b>
dimensions (wxd)	51.2 x 25.6	59.1 x 25.6	51.2 x 25.6	59.1 x 25.6	51.2 x 25.6
table height 29.15	0.00	0.00	0.00	0.00	0.00
table height 29.95 (No. 6 blue)	0.00	0.00	0.00	0.00	0.00
metal color M1	0.00	0.00	0.00	0.00	0.00
top 19mm chipboard laminated (CPL), 2.5mm KU edge, color laminate L2	0.00	0.00	0.00	0.00	0.00
pedestal on left hand side	0.00	0.00	0.00	0.00	0.00
pedestal on right hand side	0.00	0.00	0.00	0.00	0.00
body color LIGNOpal L9	0.00	0.00	0.00	0.00	0.00
front color LIGNOpal L6, 1.5mm plastic edge L6	--	--	0.00	0.00	0.00
without lock	0.00	0.00	--	--	--
unified locking 18001	0.00	0.00	0.00	0.00	0.00
locking as indicated	0.00	0.00	0.00	0.00	0.00
locking plan, site installat.	56.00	56.00	30.00	56.00	56.00
flush handle, oval (dark grey)	12.00	6.00	6.00	27.00	6.00
flush handle, oval (nickel plated)	12.00	12.00	50.00	50.00	12.00
metal bow handle (nickel- or chrome-plated)	0.00	0.00	0.00	0.00	0.00
enclosed with 21.25 screens on three sides, LIGNOpal color to match body	167.00	167.00	167.00	167.00	167.00
Orga drawer with partial pull out	--	--	0.00	0.00	--
Orga drawer with full pull out	--	--	117.00	117.00	--
with soft-close mechanism	--	--	88.00	88.00	--
without organization accessories	--	--	0.00	0.00	--
with organization set no. 9	--	--	44.00	44.00	--
adjustable shelf 1, same as body	--	--	--	--	24.00
plastic glides	0.00	0.00	0.00	0.00	0.00
adjustable plastic glides	0.00	0.00	0.00	0.00	0.00
felt glides	0.00	0.00	0.00	0.00	0.00
adjustable felt glides	0.00	0.00	0.00	0.00	0.00
2-component glides	0.00	0.00	0.00	0.00	0.00

**Material overview**

**Metal Colors**

M1	030	terra grey
	032	light blue
	033	light green
	041	turquoise
	045	broom yellow
	059	arctic
	063	anthracite
	065	black (RAL 9011)
	071	sapphire blue (RAL 5003)
	084	oxblood
	091	white

**Laminate Colors**

L2	027	natural beech laminate
	028	natural maple laminate
	031	grey white
	035	andes grey
	328	white

L6	017	astral silver
	018	anthracite
	019	plain black
	027	natural beech laminate
	028	natural maple laminate
	029	natural walnut laminate
	031	grey white
	035	andes grey
	328	white
	340	natural oak laminate
	415	terra grey

L9	027	natural beech laminate
	028	natural maple laminate
	035	andes grey
	328	white

**EcoTable-R**  
Teacher's table with round tubular legs.

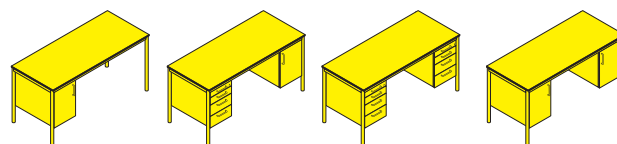

Model	23032	23033	23034	23035
<b>Standard price</b>	<b>\$1,066.00</b>	<b>\$2,233.00</b>	<b>\$2,845.00</b>	<b>\$1,766.00</b>
dimensions (wxd)	59.1 x 25.6	59.1 x 25.6	59.1 x 25.6	59.1 x 25.6
table height 29,15	0.00	0.00	0.00	0.00
table height 29,95 (No. 6 blue)	0.00	0.00	0.00	0.00
metal color M1	0.00	0.00	0.00	0.00
top 19mm chipboard laminated (CPL), 2.5mm KU edge, color laminate L2	0.00	0.00	0.00	0.00
pedestal on left hand side	0.00	0.00	0.00	0.00
pedestal on right hand side	0.00	0.00	0.00	0.00
body color LIGNOpal L9	0.00	0.00	0.00	0.00
front color LIGNOpal L6, 1.5mm plastic edge L6	0.00	0.00	0.00	0.00
without lock	--	--	--	--
unified locking 18001	0.00	0.00	0.00	0.00
locking as indicated	6.00	6.00	6.00	6.00
locking plan, site installat.	56.00	56.00	56.00	56.00
flush handle, oval (dark grey)	6.00	35.00	50.00	12.00
flush handle, oval (nickel plated)	12.00	62.00	103.00	27.00
metal bow handle (nickel- or chrome-plated)	0.00	0.00	0.00	0.00
enclosed with 21.25 screens on three sides, LIGNOpal color to match body	167.00	167.00	167.00	167.00
Orga drawer with partial pull out	--	0.00	0.00	--
Orga drawer with full pull out	--	117.00	234.00	--
with soft-close mechanism	--	88.00	175.00	--
without organization accessories	--	0.00	0.00	--
with organization set no. 9	--	44.00	88.00	--
adjustable shelf 1, same as body	24.00	24.00	--	47.00
plastic glides	0.00	0.00	0.00	0.00
adjustable plastic glides	0.00	0.00	0.00	0.00
felt glides	0.00	0.00	0.00	0.00
adjustable felt glides	0.00	0.00	0.00	0.00
2-component glides	0.00	0.00	0.00	0.00

**Material overview**

**Metal Colors**

M1 030	terra grey
032	light blue
033	light green
041	turquoise
045	broom yellow
059	arctic
063	anthracite
065	black (RAL 9011)
071	sapphire blue (RAL 5003)
084	oxblood
091	white

**Laminate Colors**

L2 027	natural beech laminate
028	natural maple laminate
031	grey white
035	andes grey
328	white

L6 017	astral silver
018	anthracite
019	plain black
027	natural beech laminate
028	natural maple laminate
029	natural walnut laminate
031	grey white
035	andes grey
328	white
340	natural oak laminate
415	terra grey

L9 027	natural beech laminate
028	natural maple laminate
035	andes grey
328	white

**EcoTable-Q**  
Student's table with square tubular legs.

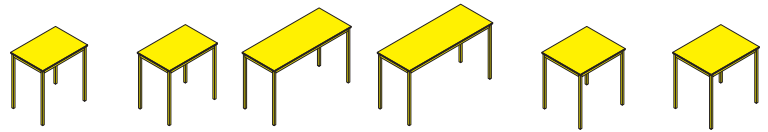

Model	23100	23101	23102	23103	23105	23106
<b>Standard price</b>	<b>\$343.00</b>	<b>\$349.00</b>	<b>\$459.00</b>	<b>\$491.00</b>	<b>\$407.00</b>	<b>\$401.00</b>
dimensions (wxd)	27.6 x 19.7	29.55 x 19.7	47.25 x 19.7	51.2 x 19.7	27.6 x 23.65	29.55 x 23.6
table height 15.75 (No. 0 white)	0.00	0.00	0.00	0.00	0.00	0.00
table height 20.9 (No. 2 violet)	0.00	0.00	0.00	0.00	0.00	0.00
table height 23.25 (No. 3 yellow)	0.00	0.00	0.00	0.00	0.00	0.00
table height 25.2 (No. 4 red)	0.00	0.00	0.00	0.00	0.00	0.00
table height 28 (No. 5 green)	0.00	0.00	0.00	0.00	0.00	0.00
table height 29.15*	--	--	--	--	0.00	0.00
table height 29.95 (No. 6 blue)	0.00	0.00	0.00	0.00	0.00	0.00
table height 32.3 (No. 7 brown)	0.00	0.00	0.00	0.00	0.00	0.00
metal color M1	0.00	0.00	0.00	0.00	0.00	0.00
top 19mm chipboard laminated (CPL), 2.5mm KU edge, color laminate L2	0.00	0.00	0.00	0.00	0.00	0.00
metal grid bookshelf	18.00	18.00	35.00	35.00	18.00	18.00
guide rails ONLY for 3 in. box	47.00	47.00	94.00	94.00	47.00	47.00
with plastic box 3 in. high, plastic color C3	65.00	65.00	126.00	126.00	65.00	65.00
with plastic box 3 in. high, plastic color C3 with cover	77.00	77.00	138.00	138.00	77.00	77.00
satchel hooks	6.00	6.00	12.00	12.00	6.00	6.00
with 11.88 modesty screen in LIGNOpal L3	73.00	73.00	82.00	88.00	73.00	73.00
with grid channel	--	--	--	--	68.00	68.00
cable outlet left, outside	--	--	--	--	30.00	30.00
cable outlet left, inside	--	--	--	--	30.00	30.00
cable outlet right, outside	--	--	--	--	30.00	30.00
cable outlet right, inside	--	--	--	--	30.00	30.00
1 cable outlet centered	--	--	--	--	30.00	30.00
plastic glides	0.00	0.00	0.00	0.00	0.00	0.00
adjustable plastic glides	0.00	0.00	0.00	0.00	0.00	0.00
felt glides	0.00	0.00	0.00	0.00	0.00	0.00
adjustable felt glides	0.00	0.00	0.00	0.00	0.00	0.00
2-component glides	0.00	0.00	0.00	0.00	0.00	0.00
mobile	50.00	50.00	50.00	50.00	50.00	50.00
2 rear casters, 2 plastic glides	27.00	27.00	27.00	27.00	27.00	27.00
2 rear casters, 2 felt glides	27.00	27.00	30.00	30.00	27.00	27.00
2 rear casters, 2 component glides	27.00	27.00	27.00	27.00	27.00	27.00

\*29.15" table height cannot be combined with casters.

**Material overview**

**Metal Colors**

M1	030	terra grey
	032	light blue
	033	light green
	041	turquoise
	045	broom yellow
	059	arctic
	063	anthracite
	065	black (RAL 9011)
	071	sapphire blue (RAL 5003)
	084	oxblood
	091	white

**Plastic Colors**

C3	001	red
	014	anthracite
	016	translucent
	030	dark red
	031	dark blue
	032	light blue
	033	light green
	038	turquoise
	039	broom yellow

**Laminate Colors**

L2	027	natural beech laminate	029	natural walnut laminate
	028	natural maple laminate	031	grey white
	031	grey white	035	andes grey
	035	andes grey	328	white
	328	white	340	natural oak laminate
			415	terra grey
L3	017	astral silver		
	018	anthracite		
	019	plain black		
	027	natural beech laminate		
	028	natural maple laminate		

**EcoTable-Q**  
Student's table with square tubular legs.

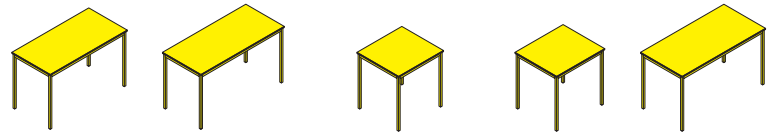

Model	23107	23108	23110	23111	23113
<b>Standard price</b>	<b>\$556.00</b>	<b>\$561.00</b>	<b>\$381.00</b>	<b>\$392.00</b>	<b>\$666.00</b>
dimensions (wxd)	47.25 x 23.65	51.2 x 23.65	27.6 x 25.6	29.55 x 25.6	51.2 x 25.6
table height 15.75 (No. 0 white)	0.00	0.00	0.00	0.00	0.00
table height 20.9 (No. 2 violet)	0.00	0.00	0.00	0.00	0.00
table height 23.25 (No. 3 yellow)	0.00	0.00	0.00	0.00	0.00
table height 25.2 (No. 4 red)	0.00	0.00	0.00	0.00	0.00
table height 28 (No. 5 green)	0.00	0.00	0.00	0.00	0.00
table height 29.15*	0.00	0.00	--	--	--
table height 29.95 (No. 6 blue)	0.00	0.00	0.00	0.00	0.00
table height 32.3 (No. 7 brown)	0.00	0.00	0.00	0.00	0.00
metal color M1	0.00	0.00	0.00	0.00	0.00
top 19mm chipboard laminated (CPL), 2.5mm KU edge, color laminate L2	0.00	0.00	0.00	0.00	0.00
metal grid bookshelf	35.00	35.00	18.00	18.00	35.00
guide rails ONLY for 3 in. box	94.00	94.00	47.00	47.00	94.00
with plastic box 3 in. high, plastic color C3	126.00	126.00	65.00	76.00	126.00
with plastic box 3 in. high, plastic color C3 with cover	138.00	138.00	77.00	77.00	138.00
satchel hooks	12.00	12.00	6.00	6.00	12.00
with 11.88 modesty screen in LIGNOpal L3	82.00	88.00	73.00	73.00	88.00
with grid channel	82.00	82.00	68.00	68.00	82.00
cable outlet left, outside	30.00	30.00	30.00	30.00	30.00
cable outlet left, inside	30.00	30.00	30.00	30.00	30.00
cable outlet right, outside	30.00	30.00	30.00	30.00	30.00
cable outlet right, inside	30.00	30.00	30.00	30.00	30.00
1 cable outlet centered	30.00	30.00	30.00	30.00	30.00
plastic glides	0.00	0.00	0.00	0.00	0.00
adjustable plastic glides	0.00	0.00	0.00	0.00	0.00
felt glides	0.00	0.00	0.00	0.00	0.00
adjustable felt glides	0.00	0.00	0.00	0.00	0.00
2-component glides	0.00	0.00	0.00	0.00	0.00
mobile	50.00	50.00	50.00	50.00	50.00
2 rear casters, 2 plastic glides	27.00	27.00	30.00	27.00	27.00
2 rear casters, 2 felt glides	30.00	30.00	30.00	27.00	30.00
2 rear casters, 2 component glides	27.00	27.00	30.00	27.00	27.00

\*29.15" table height cannot be combined with casters.

**Material overview**

**Metal Colors**

M1	030	terra grey
	032	light blue
	033	light green
	041	turquoise
	045	broom yellow
	059	arctic
	063	anthracite
	065	black (RAL 9011)
	071	sapphire blue (RAL 5003)
	084	oxblood
	091	white

**Plastic Colors**

C3	001	red
	014	anthracite
	016	translucent
	030	dark red
	031	dark blue
	032	light blue
	033	light green
	038	turquoise
	039	broom yellow

**Laminate Colors**

L2	027	natural beech laminate	029	natural walnut laminate
	028	natural maple laminate	031	grey white
	031	grey white	035	andes grey
	035	andes grey	328	white
	328	white	340	natural oak laminate
			415	terra grey
L3	017	astral silver		
	018	anthracite		
	019	plain black		
	027	natural beech laminate		
	028	natural maple laminate		

**EcoTable-Q**  
Office desk with square tubular legs.

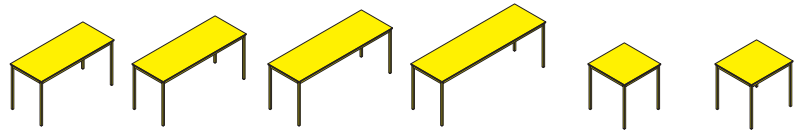

Model	23164	23165	23166	23167	23170	23171
<b>Standard price</b>	<b>\$596.00</b>	<b>\$655.00</b>	<b>\$678.00</b>	<b>\$742.00</b>	<b>\$419.00</b>	<b>\$419.00</b>
dimensions (wxd)	55.15 x 23.65	63 x 23.65	70.9 x 23.65	78.75 x 23.65	27.6 x 27.6	31.5 x 27.6
table height 15.75 (No. 0 white)	0.00	0.00	0.00	0.00	0.00	0.00
table height 20.9 (No. 2 violet)	0.00	0.00	0.00	0.00	0.00	0.00
table height 23.25 (No. 3 yellow)	0.00	0.00	0.00	0.00	0.00	0.00
table height 25.2 (No. 4 red)	0.00	0.00	0.00	0.00	0.00	0.00
table height 28 (No. 5 green)	0.00	0.00	0.00	0.00	0.00	0.00
table height 29.15*	0.00	0.00	0.00	0.00	0.00	0.00
table height 29.95 (No. 6 blue)	0.00	0.00	0.00	0.00	0.00	0.00
table height 32.3 (No. 7 brown)	0.00	0.00	0.00	0.00	0.00	0.00
metal color M1	0.00	0.00	0.00	0.00	0.00	0.00
top 19mm chipboard laminated (CPL), 2.5mm KU edge, color laminate L2	0.00	0.00	0.00	0.00	0.00	0.00
with grid channel	97.00	126.00	132.00	155.00	68.00	68.00
cable outlet left, outside	30.00	30.00	30.00	30.00	30.00	30.00
cable outlet left, inside	30.00	30.00	30.00	30.00	30.00	30.00
cable outlet right, outside	30.00	30.00	30.00	30.00	30.00	30.00
cable outlet right, inside	30.00	30.00	30.00	30.00	30.00	30.00
1 cable outlet centered	30.00	30.00	30.00	30.00	30.00	30.00
with 11.88 modesty screen in LIGNOpal L3	88.00	111.00	111.00	117.00	73.00	73.00
plastic glides	0.00	0.00	0.00	0.00	0.00	0.00
adjustable plastic glides	0.00	0.00	0.00	0.00	0.00	0.00
felt glides	0.00	0.00	0.00	0.00	0.00	0.00
adjustable felt glides	0.00	0.00	0.00	0.00	0.00	0.00
2-component glides	0.00	0.00	0.00	0.00	0.00	0.00
mobile	50.00	50.00	50.00	50.00	50.00	50.00
2 casters left, 2 plastic glides	27.00	27.00	27.00	27.00	27.00	27.00
2 casters left, 2 felt glides	30.00	30.00	30.00	30.00	30.00	30.00
2 casters left, 2 component glides	27.00	27.00	27.00	27.00	27.00	27.00

\*29.15" table height cannot be combined with casters.

Veneers available upon request.

**Material overview**

**Metal Colors**

- M1 030 terra grey
- 032 light blue
- 033 light green
- 041 turquoise
- 045 broom yellow
- 059 arctic
- 063 anthracite
- 065 black (RAL 9011)
- 071 sapphire blue (RAL 5003)
- 084 oxblood
- 091 white

**Laminate Colors**

- L2 027 natural beech laminate
- 028 natural maple laminate
- 031 grey white
- 035 andes grey
- 328 white
- L3 017 astral silver
- 018 anthracite
- 019 plain black
- 027 natural beech laminate
- 028 natural maple laminate
- 029 natural walnut laminate
- 031 grey white
- 035 andes grey
- 328 white
- 340 natural oak laminate
- 415 terra grey

**EcoTable-Q**  
Office desk with square tubular legs.

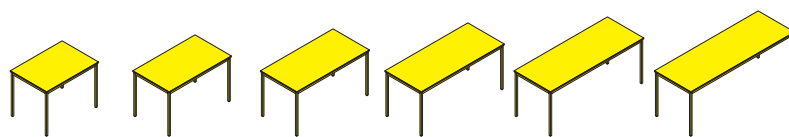

Model	23172	23173	23174	23175	23176	23177
<b>Standard price</b>	<b>\$497.00</b>	<b>\$570.00</b>	<b>\$643.00</b>	<b>\$649.00</b>	<b>\$731.00</b>	<b>\$789.00</b>
dimensions (wxd)	39.4 x 27.6	47.25 x 27.6	55.15 x 27.6	63 x 27.6	70.9 x 27.6	78.75 x 27.6
table height 15.75 (No. 0 white)	0.00	0.00	0.00	0.00	0.00	0.00
table height 20.9 (No. 2 violet)	0.00	0.00	0.00	0.00	0.00	0.00
table height 23.25 (No. 3 yellow)	0.00	0.00	0.00	0.00	0.00	0.00
table height 25.2 (No. 4 red)	0.00	0.00	0.00	0.00	0.00	0.00
table height 28 (No. 5 green)	0.00	0.00	0.00	0.00	0.00	0.00
table height 29.15*	0.00	0.00	0.00	0.00	0.00	0.00
table height 29.95 (No. 6 blue)	0.00	0.00	0.00	0.00	0.00	0.00
table height 32.3 (No. 7 brown)	0.00	0.00	0.00	0.00	0.00	0.00
metal color M1	0.00	0.00	0.00	0.00	0.00	0.00
top 19mm chipboard laminated (CPL), 2.5mm KU edge, color laminate L2	0.00	0.00	0.00	0.00	0.00	0.00
with grid channel	68.00	68.00	97.00	126.00	132.00	155.00
cable outlet left, outside	30.00	30.00	30.00	30.00	30.00	30.00
cable outlet left, inside	30.00	30.00	30.00	30.00	30.00	30.00
cable outlet right, outside	30.00	30.00	30.00	30.00	30.00	30.00
cable outlet right, inside	30.00	30.00	30.00	30.00	30.00	30.00
1 cable outlet centered	30.00	30.00	30.00	30.00	30.00	30.00
with 11.88 modesty screen in LIGNOpal L3	73.00	82.00	88.00	111.00	111.00	117.00
plastic glides	0.00	0.00	0.00	0.00	0.00	0.00
adjustable plastic glides	0.00	0.00	0.00	0.00	0.00	0.00
felt glides	0.00	0.00	0.00	0.00	0.00	0.00
adjustable felt glides	0.00	0.00	0.00	0.00	0.00	0.00
2-component glides	0.00	0.00	0.00	0.00	0.00	0.00
mobile	50.00	50.00	50.00	50.00	50.00	50.00
2 casters left, 2 plastic glides	27.00	27.00	27.00	27.00	27.00	27.00
2 casters left, 2 felt glides	30.00	30.00	30.00	30.00	30.00	30.00
2 casters left, 2 component glides	27.00	27.00	27.00	27.00	27.00	27.00

\*29.15" table height cannot be combined with casters.

Veneers available upon request.

### Material overview

#### Metal Colors

M1	030	terra grey
	032	light blue
	033	light green
	041	turquoise
	045	broom yellow
	059	arctic
	063	anthracite
	065	black (RAL 9011)
	071	sapphire blue (RAL 5003)
	084	oxblood
	091	white

#### Laminate Colors

L2	027	natural beech laminate	031	grey white
	028	natural maple laminate	035	andes grey
	031	grey white	328	white
	035	andes grey	340	natural oak laminate
	328	white	415	terra grey
L3	017	astral silver		
	018	anthracite		
	019	plain black		
	027	natural beech laminate		
	028	natural maple laminate		
	029	natural walnut laminate		

**EcoTable-Q**  
Office desk with square tubular legs.

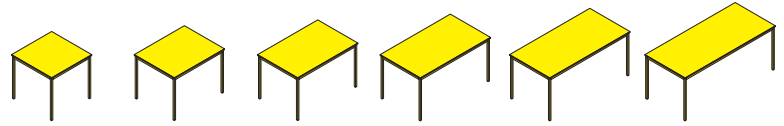

Model	23181	23182	23183	23184	23185	23186
<b>Standard price</b>	<b>\$547.00</b>	<b>\$626.00</b>	<b>\$664.00</b>	<b>\$722.00</b>	<b>\$769.00</b>	<b>\$742.00</b>
dimensions (wxd)	31.5 x 31.5	39.4 x 31.5	47.25 x 31.5	55.15 x 31.5	63 x 31.5	70.9 x 31.5
table height 15.75 (No. 0 white)	0.00	0.00	0.00	0.00	0.00	0.00
table height 20.9 (No. 2 violet)	0.00	0.00	0.00	0.00	0.00	0.00
table height 23.25 (No. 3 yellow)	0.00	0.00	0.00	0.00	0.00	0.00
table height 25.2 (No. 4 red)	0.00	0.00	0.00	0.00	0.00	0.00
table height 28 (No. 5 green)	0.00	0.00	0.00	0.00	0.00	0.00
table height 29.15*	0.00	0.00	0.00	0.00	0.00	0.00
table height 29.95 (No. 6 blue)	0.00	0.00	0.00	0.00	0.00	0.00
table height 32.3 (No. 7 brown)	0.00	0.00	0.00	0.00	0.00	0.00
metal color M1	0.00	0.00	0.00	0.00	0.00	0.00
top 19mm chipboard laminated (CPL), 2.5mm KU edge, color laminate L2	0.00	0.00	0.00	0.00	0.00	0.00
with grid channel	68.00	68.00	68.00	97.00	126.00	132.00
cable outlet left, outside	30.00	30.00	30.00	30.00	30.00	30.00
cable outlet left, inside	30.00	30.00	30.00	30.00	30.00	30.00
cable outlet right, outside	30.00	30.00	30.00	30.00	30.00	30.00
cable outlet right, inside	30.00	30.00	30.00	30.00	30.00	30.00
1 cable outlet centered	30.00	30.00	30.00	30.00	30.00	30.00
with 11.88 modesty screen in LIGNOpal L3	73.00	73.00	82.00	88.00	111.00	111.00
plastic glides	0.00	0.00	0.00	0.00	0.00	0.00
adjustable plastic glides	0.00	0.00	0.00	0.00	0.00	0.00
felt glides	0.00	0.00	0.00	0.00	0.00	0.00
adjustable felt glides	0.00	0.00	0.00	0.00	0.00	0.00
2-component glides	0.00	0.00	0.00	0.00	0.00	0.00
mobile	50.00	50.00	50.00	50.00	50.00	50.00
2 casters left, 2 plastic glides	27.00	27.00	27.00	27.00	27.00	27.00
2 casters left, 2 felt glides	30.00	30.00	30.00	30.00	30.00	30.00
2 casters left, 2 component glides	27.00	27.00	27.00	27.00	27.00	27.00

\*29.15" table height cannot be combined with casters.

Veneers available upon request.

**Material overview**

**Metal Colors**

- M1 030 terra grey
- 032 light blue
- 033 light green
- 041 turquoise
- 045 broom yellow
- 059 arctic
- 063 anthracite
- 065 black (RAL 9011)
- 071 sapphire blue (RAL 5003)
- 084 oxblood
- 091 white

**Laminate Colors**

- L2 027 natural beech laminate
- 028 natural maple laminate
- 031 grey white
- 035 andes grey
- 328 white
- L3 017 astral silver
- 018 anthracite
- 019 plain black
- 027 natural beech laminate
- 028 natural maple laminate
- 029 natural walnut laminate
- 031 grey white
- 035 andes grey
- 328 white
- 340 natural oak laminate
- 415 terra grey

**EcoTable-Q**  
Office desk with square tubular legs.

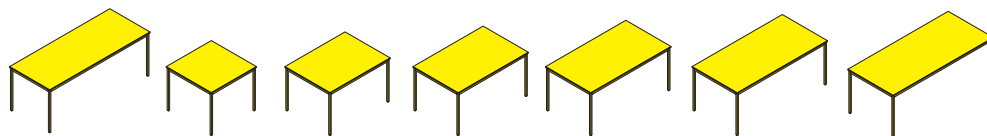

Model	23187	23191	23193	23194	23195	23196	23197
<b>Standard price</b>	<b>\$964.00</b>	<b>\$570.00</b>	<b>\$687.00</b>	<b>\$789.00</b>	<b>\$862.00</b>	<b>\$876.00</b>	<b>\$935.00</b>
dimensions (wxd)	78.75 x 31.5	35.45 x 35.45	47.25 x 35.45	55.15 x 35.45	63 x 35.45	70.9 x 35.45	78.75 x 35.45
table height 15.75 (No. 0 white)	0.00	0.00	0.00	0.00	0.00	0.00	0.00
table height 20.9 (No. 2 violet)	0.00	0.00	0.00	0.00	0.00	0.00	0.00
table height 23.25 (No. 3 yellow)	0.00	0.00	0.00	0.00	0.00	0.00	0.00
table height 25.2 (No. 4 red)	0.00	0.00	0.00	0.00	0.00	0.00	0.00
table height 28 (No. 5 green)	0.00	0.00	0.00	0.00	0.00	0.00	0.00
table height 29.15*	0.00	0.00	0.00	0.00	0.00	0.00	0.00
table height 29.95 (No. 6 blue)	0.00	0.00	0.00	0.00	0.00	0.00	0.00
table height 32.3 (No. 7 brown)	0.00	0.00	0.00	0.00	0.00	0.00	0.00
metal color M1	0.00	0.00	0.00	0.00	0.00	0.00	0.00
top 19mm chipboard laminated (CPL), 2.5mm KU edge, color laminate L2	0.00	0.00	0.00	0.00	0.00	0.00	0.00
with grid channel	155.00	68.00	68.00	97.00	126.00	132.00	155.00
cable outlet left, outside	30.00	30.00	30.00	30.00	30.00	30.00	30.00
cable outlet left, inside	30.00	30.00	30.00	30.00	30.00	30.00	30.00
cable outlet right, outside	30.00	30.00	30.00	30.00	30.00	30.00	30.00
cable outlet right, inside	30.00	30.00	30.00	30.00	30.00	30.00	30.00
1 cable outlet centered	30.00	30.00	30.00	30.00	30.00	30.00	30.00
with 11.88 modesty screen in LIGNOpal L3	117.00	73.00	82.00	88.00	111.00	111.00	117.00
plastic glides	0.00	0.00	0.00	0.00	0.00	0.00	0.00
adjustable plastic glides	0.00	0.00	0.00	0.00	0.00	0.00	0.00
felt glides	0.00	0.00	0.00	0.00	0.00	0.00	0.00
adjustable felt glides	0.00	0.00	0.00	0.00	0.00	0.00	0.00
2-component glides	0.00	0.00	0.00	0.00	0.00	0.00	0.00
mobile	50.00	50.00	50.00	50.00	50.00	50.00	50.00
2 casters left, 2 plastic glides	27.00	27.00	27.00	27.00	27.00	27.00	27.00
2 casters left, 2 felt glides	30.00	30.00	30.00	30.00	30.00	30.00	30.00
2 casters left, 2 component glides	27.00	27.00	27.00	27.00	27.00	27.00	27.00

\*29.15" table height cannot be combined with casters.

Veneers available upon request.

**Material overview**

**Metal Colors**

- M1 030 terra grey
- 032 light blue
- 033 light green
- 041 turquoise
- 045 broom yellow
- 059 arctic
- 063 anthracite
- 065 black (RAL 9011)
- 071 sapphire blue (RAL 5003)
- 084 oxblood
- 091 white

**Laminate Colors**

- L2 027 natural beech laminate
- 028 natural maple laminate
- 031 grey white
- 035 andes grey
- 328 white
- L3 017 astral silver
- 018 anthracite
- 019 plain black
- 027 natural beech laminate
- 028 natural maple laminate
- 029 natural walnut laminate
- 031 grey white
- 035 andes grey
- 328 white
- 340 natural oak laminate
- 415 terra grey

**EcoTable-Q**

Trapezoidal and semi-circular table with square tubular legs.



Model	23114	23179	23189
<b>Standard price</b>	<b>\$643.00</b>	<b>\$760.00</b>	<b>\$818.00</b>
dimensions (wxd)	51.2 x 25.6	55.15 x 27.6	63 x 31.5
table height 15.75 (No. 0 white)	0.00	0.00	0.00
table height 20.9 (No. 2 violet)	0.00	0.00	0.00
table height 23.25 (No. 3 yellow)	0.00	0.00	0.00
table height 25.2 (No. 4 red)	0.00	0.00	0.00
table height 28 (No. 5 green)	0.00	0.00	0.00
table height 29.15*	0.00	0.00	0.00
table height 29.95 (No. 6 blue)	0.00	0.00	0.00
table height 32.3 (No. 7 brown)	0.00	0.00	0.00
metal color M1	0.00	0.00	0.00
top 19mm chipboard laminated (CPL), 2.5mm KU edge, color laminate L2	0.00	0.00	0.00
metal grid bookshelf	18.00	--	--
satchel hooks	6.00	--	--
plastic glides	0.00	0.00	0.00
adjustable plastic glides	0.00	0.00	0.00
felt glides	0.00	0.00	0.00
adjustable felt glides	0.00	0.00	0.00
2-component glides	0.00	0.00	0.00
2 left casters, 2 plastic glides	27.00	27.00	27.00
2 left casters, 2 felt glides	30.00	30.00	30.00
2 left casters, 2 component glides	27.00	27.00	27.00

\*29.15" table height cannot be combined with casters.

Veneers available upon request.

**Material overview**

**Metal Colors**

- M1 030 terra grey
- 032 light blue
- 033 light green
- 041 turquoise
- 045 broom yellow
- 059 arctic
- 063 anthracite
- 065 black (RAL 9011)
- 071 sapphire blue (RAL 5003)
- 084 oxblood
- 091 white

**Laminate Colors**

- L2 027 natural beech laminate
- 028 natural maple laminate
- 031 grey white
- 035 andes grey
- 328 white

**EcoTable-Q**  
Trapezoidal and semi-circular table with square tubular legs.

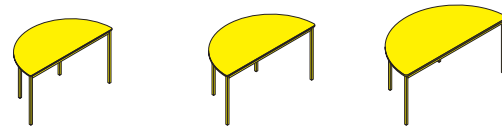

Model	23115	23178	23188
<b>Standard price</b>	<b>\$684.00</b>	<b>\$713.00</b>	<b>\$801.00</b>
dimensions (wxd)	51.2 x 25.6	55.15 x 27.6	63 x 31.5
table height 15.75 (No. 0 white)	0.00	0.00	0.00
table height 20.9 (No. 2 violet)	0.00	0.00	0.00
table height 23.25 (No. 3 yellow)	0.00	0.00	0.00
table height 25.2 (No. 4 red)	0.00	0.00	0.00
table height 28 (No. 5 green)	0.00	0.00	0.00
table height 29.15*	0.00	0.00	0.00
table height 29.95 (No. 6 blue)	0.00	0.00	0.00
table height 32.3 (No. 7 brown)	0.00	0.00	0.00
metal color M1	0.00	0.00	0.00
top 19mm chipboard laminated (CPL), 2.5mm KU edge, color laminate L2	0.00	0.00	0.00
metal grid bookshelf	--	--	--
satchel hooks	--	--	--
plastic glides	0.00	0.00	0.00
adjustable plastic glides	0.00	0.00	0.00
felt glides	0.00	0.00	0.00
adjustable felt glides	0.00	0.00	0.00
2-component glides	0.00	0.00	0.00
2 left casters, 2 plastic glides	27.00	27.00	27.00
2 left casters, 2 felt glides	30.00	30.00	30.00
2 left casters, 2 component glides	27.00	27.00	27.00

\*29.15" table height cannot be combined with casters.

Veneers available upon request.

**Material overview**

**Metal Colors**

- M1 030 terra grey
- 032 light blue
- 033 light green
- 041 turquoise
- 045 broom yellow
- 059 arctic
- 063 anthracite
- 065 black (RAL 9011)
- 071 sapphire blue (RAL 5003)
- 084 oxblood
- 091 white

**Laminate Colors**

- L2 027 natural beech laminate
- 028 natural maple laminate
- 031 grey white
- 035 andes grey
- 328 white

**EcoTable-Q**  
 Round table with square tubular legs.

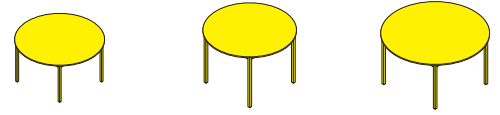

Model	23150	23151	23153
<b>Standard price</b>	<b>\$716.00</b>	<b>\$731.00</b>	<b>\$949.00</b>
dimensions (wxd) (Ø)	35.45	39.4	47.25
table height 15.75 (No. 0 white)	0.00	0.00	0.00
table height 20.9 (No. 2 violet)	0.00	0.00	0.00
table height 23.25 (No. 3 yellow)	0.00	0.00	0.00
table height 25.2 (No. 4 red)	0.00	0.00	0.00
table height 28 (No. 5 green)	0.00	0.00	0.00
table height 29.15*	0.00	0.00	0.00
table height 29.95 (No. 6 blue)	0.00	0.00	0.00
table height 32.3 (No. 7 brown)	0.00	0.00	0.00
metal color M1	0.00	0.00	0.00
top 19mm chipboard laminated (CPL), 2.5mm KU edge, color laminate L2	0.00	0.00	0.00
metal grid bookshelf	--	--	--
satchel hooks	--	--	--
plastic glides	0.00	0.00	0.00
adjustable plastic glides	12.00	12.00	12.00
felt glides	0.00	0.00	0.00
adjustable felt glides	12.00	12.00	12.00
2-component glides	0.00	0.00	0.00
mobile	50.00	50.00	50.00
2 casters, 2 plastic glides	35.00	35.00	35.00
2 casters, 2 felt glides	41.00	41.00	41.00
2 casters, 2 component glides	35.00	35.00	35.00

\*29.15" table height cannot be combined with casters.

Veneers available upon request.

**Material overview**

**Metal Colors**

- M1 030 terra grey
- 032 light blue
- 033 light green
- 041 turquoise
- 045 broom yellow
- 059 arctic
- 063 anthracite
- 065 black (RAL 9011)
- 071 sapphire blue (RAL 5003)
- 084 oxblood
- 091 white

**Laminate Colors**

- L2 027 natural beech laminate
- 028 natural maple laminate
- 031 grey white
- 035 andes grey
- 328 white

**EcoTable-Q**  
Teacher's table with square tubular legs.



Model	23120	23130	23121	23131	23122
<b>Standard price</b>	<b>\$1,241.00</b>	<b>\$1,256.00</b>	<b>\$1,576.00</b>	<b>\$1,722.00</b>	<b>\$906.00</b>
dimensions (wxd)	51.2 x 25.6	59.1 x 25.6	51.2 x 25.6	59.1 x 25.6	51.2 x 25.6
table height 29.15	0.00	0.00	0.00	0.00	0.00
table height 29.95 (No. 6 blue)	0.00	0.00	0.00	0.00	0.00
metal color M1	0.00	0.00	0.00	0.00	0.00
top 19mm chipboard laminated (CPL), 2.5mm KU edge, color laminate L2	0.00	0.00	0.00	0.00	0.00
pedestal on left hand side	0.00	0.00	0.00	0.00	0.00
pedestal on right hand side	0.00	0.00	0.00	0.00	0.00
body color LIGNOpal L9	0.00	0.00	0.00	0.00	0.00
front color LIGNOpal L6, 1.5mm plastic edge L6	--	--	0.00	0.00	0.00
without lock	0.00	0.00	--	--	--
unified locking 18001	0.00	0.00	0.00	0.00	0.00
locking as indicated	0.00	0.00	0.00	0.00	6.00
locking plan, site installat.	56.00	56.00	56.00	56.00	56.00
flush handle, oval (dark grey)	6.00	6.00	27.00	27.00	12.00
flush handle, oval (nickel plated)	12.00	12.00	50.00	50.00	24.00
metal bow handle (nickel- or chrome-plated)	0.00	0.00	0.00	0.00	0.00
enclosed with 21.25 screens on three sides, LIGNOpal color to match body	167.00	167.00	167.00	167.00	167.00
Orga drawer with partial pull out	--	--	0.00	0.00	--
Orga drawer with full pull out	--	--	117.00	117.00	--
with soft-close mechanism	--	--	88.00	88.00	--
without organization accessories	--	--	0.00	0.00	--
with organization set no. 9	--	--	44.00	44.00	--
adjustable shelf 1, same as body	--	--	--	--	24.00
plastic glides	0.00	0.00	0.00	0.00	0.00
adjustable plastic glides	0.00	0.00	0.00	0.00	0.00
felt glides	0.00	0.00	0.00	0.00	0.00
adjustable felt glides	0.00	0.00	0.00	0.00	0.00
2-component glides	0.00	0.00	0.00	0.00	0.00

**Material overview**

**Metal Colors**

M1	030	terra grey
	032	light blue
	033	light green
	041	turquoise
	045	broom yellow
	059	arctic
	063	anthracite
	065	black (RAL 9011)
	071	sapphire blue (RAL 5003)
	084	oxblood
	091	white

**Laminate Colors**

L2	027	natural beech laminate
	028	natural maple laminate
	031	grey white
	035	andes grey
	328	white

L6	017	astral silver
	018	anthracite
	019	plain black
	027	natural beech laminate
	028	natural maple laminate
	029	natural walnut laminate
	031	grey white
	035	andes grey
	328	white
	340	natural oak laminate
	415	terra grey

L9	027	natural beech laminate
	028	natural maple laminate
	035	andes grey
	328	white

**EcoTable-Q**  
Teacher's table with square tubular legs.

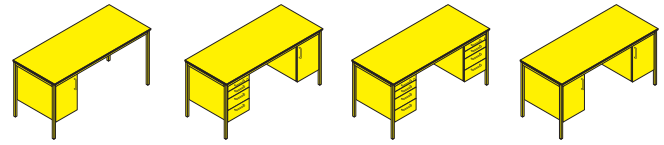

Model	23132	23133	23134	23135
<b>Standard price</b>	<b>\$1,081.00</b>	<b>\$2,247.00</b>	<b>\$2,860.00</b>	<b>\$1,781.00</b>
dimensions (wxd)	59.1 x 25.6	59.1 x 25.6	59.1 x 25.6	59.1 x 25.6
table height 29.15	0.00	0.00	0.00	0.00
table height 29.95 (No. 6 blue)	0.00	0.00	0.00	0.00
metal color M1	0.00	0.00	0.00	0.00
top 19mm chipboard laminated (CPL), 2.5mm KU edge, color laminate L2	0.00	0.00	0.00	0.00
pedestal on left hand side	0.00	0.00	0.00	0.00
pedestal on right hand side	0.00	0.00	0.00	0.00
body color LIGNOpal L9	0.00	0.00	0.00	0.00
front color LIGNOpal L6, 1.5mm plastic edge L6	0.00	0.00	0.00	0.00
without lock	--	--	--	--
unified locking 18001	0.00	0.00	0.00	0.00
locking as indicated	6.00	6.00	6.00	6.00
locking plan, site installat.	56.00	56.00	56.00	56.00
flush handle, oval (dark grey)	12.00	33.00	50.00	12.00
flush handle, oval (nickel plated)	24.00	65.00	103.00	27.00
metal bow handle (nickel- or chrome-plated)	0.00	0.00	0.00	0.00
enclosed with 21.25 screens on three sides, LIGNOpal color to match body	167.00	167.00	167.00	167.00
Orga drawer with partial pull out	--	0.00	0.00	--
Orga drawer with full pull out	--	117.00	234.00	--
with soft-close mechanism	--	88.00	175.00	--
without organization accessories	--	0.00	0.00	--
with organization set no. 9	--	44.00	88.00	--
adjustable shelf 1, same as body	24.00	24.00	--	47.00
plastic glides	0.00	0.00	0.00	0.00
adjustable plastic glides	0.00	0.00	0.00	0.00
felt glides	0.00	0.00	0.00	0.00
adjustable felt glides	0.00	0.00	0.00	0.00
2-component glides	0.00	0.00	0.00	0.00

**Material overview**

**Metal Colors**

M1	030	terra grey
	032	light blue
	033	light green
	041	turquoise
	045	broom yellow
	059	arctic
	063	anthracite
	065	black (RAL 9011)
	071	sapphire blue (RAL 5003)
	084	oxblood
	091	white

**Laminate Colors**

L2	027	natural beech laminate
	028	natural maple laminate
	031	grey white
	035	andes grey
	328	white

L6	017	astral silver
	018	anthracite
	019	plain black
	027	natural beech laminate
	028	natural maple laminate
	029	natural walnut laminate
	031	grey white
	035	andes grey
	328	white
	340	natural oak laminate
	415	terra grey

L9	027	natural beech laminate
	028	natural maple laminate
	035	andes grey
	328	white

**EcoTable-Q**  
Elevated table for mobile storage access.

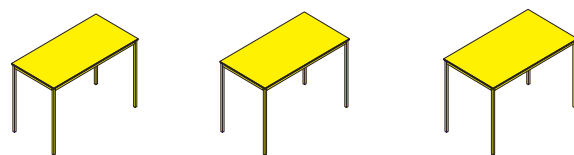

Model	A2556	A2557	A2558
<b>Standard price</b>	<b>\$643.00</b>	<b>\$672.00</b>	<b>\$731.00</b>
dimensions (wxd)	47.25 x 23.65	47.25 x 29.55	47.25 x 35.45
table height 42.15	0.00	0.00	0.00
metal color M1	0.00	0.00	0.00
top 19mm chipboard laminated (CPL), 2.5mm KU edge, color laminate L2	0.00	0.00	0.00
top 19mm chipboard laminated (CPL) writeable, 2.5mm KU edge in white	82.00	85.00	94.00
cable outlet left, outside	30.00	30.00	30.00
cable outlet left, inside	30.00	30.00	30.00
cable outlet right, outside	30.00	30.00	30.00
cable outlet right, inside	30.00	30.00	30.00
1 cable outlet centered	30.00	30.00	30.00
plastic glides	0.00	0.00	0.00
adjustable plastic glides	0.00	0.00	0.00
felt glides	0.00	0.00	0.00
adjustable felt glides	0.00	0.00	0.00
2-component glides	0.00	0.00	0.00
mobile	50.00	50.00	50.00
2 casters, 2 plastic glides	27.00	27.00	27.00
2 casters, 2 felt glides	27.00	27.00	27.00
2 casters, 2 2-component glides	27.00	27.00	27.00

Please contact your Sales Support for confirmation of how many of which storage units will fit under one table.

**Material overview**

**Metal Colors**

- M1 030 terra grey
- 032 light blue
- 033 light green
- 041 turquoise
- 045 broom yellow
- 059 arctic
- 063 anthracite
- 065 black (RAL 9011)
- 071 sapphire blue (RAL 5003)
- 084 oxblood
- 091 white

**Laminate Colors**

- L2 027 natural beech laminate
- 028 natural maple laminate
- 031 grey white
- 035 andes grey
- 328 white

- Mx 060 chrome-plated

**LiteTable-ST**  
Stackable lightweight table.

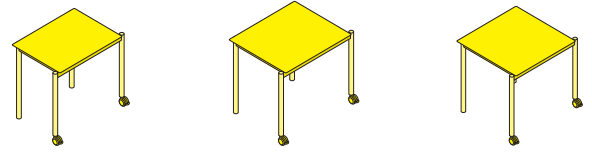

Model	21090	21091	21092
<b>Standard price</b>	<b>\$398.00</b>	<b>\$430.00</b>	<b>\$439.00</b>
dimensions (wxd)	27.6 x 21.7	29.55 x 25.6	27.6 x 27.6
max. number stackable	8	8	8
table height 15.75 (No. 0 white)	0.00	0.00	0.00
table height 20.9 (No. 2 violet)	0.00	0.00	0.00
table height 23.25 (No. 3 yellow)	0.00	0.00	0.00
table height 25.2 (No. 4 red)	0.00	0.00	0.00
table height 28 (No. 5 green)	0.00	0.00	0.00
table height 29.15	0.00	0.00	0.00
table height 29.95 (No. 6 blue)	0.00	0.00	0.00
table height 32.3 (No. 7 brown)	0.00	0.00	0.00
metal color M1	0.00	0.00	0.00
top 19mm chipboard laminated (CPL), 2.5mm KU edge, color laminate L2	0.00	0.00	0.00
top 19mm chipboard laminated (CPL) writeable, 2.5mm KU edge in white	76.00	88.00	88.00
plastic glides	2.00	2.00	2.00
2 casters, 2 plastic glides	0.00	0.00	0.00
felt glides	2.00	2.00	2.00
2 casters, 2 felt glides	3.00	3.00	3.00
2-component glides	2.00	2.00	2.00
2 casters, 2-component glides	0.00	0.00	0.00

**Material overview**

**Metal Colors**

- M1 030 terra grey
- 032 light blue
- 033 light green
- 041 turquoise
- 045 broom yellow
- 059 arctic
- 063 anthracite
- 065 black (RAL 9011)
- 071 sapphire blue (RAL 5003)
- 084 oxblood
- 091 white

**Laminate Colors**

- L2 027 natural beech laminate
- 028 natural maple laminate
- 031 grey white
- 035 andes grey
- 328 white

**LiteTable-ST**  
Stackable lightweight table.

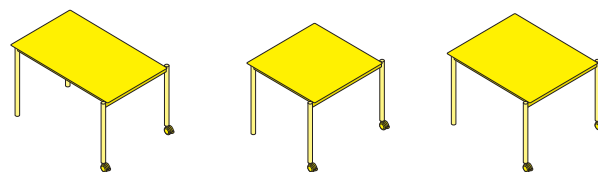

Model	21093	21094	21095
<b>Standard price</b>	<b>\$629.00</b>	<b>\$483.00</b>	<b>\$585.00</b>
dimensions (wxd)	55.15 x 27.6	31.5 x 31.5	47.25 x 31.5
max. number stackable	8	8	8
table height 15.75 (No. 0 white)	0.00	0.00	0.00
table height 20.9 (No. 2 violet)	0.00	0.00	0.00
table height 23.25 (No. 3 yellow)	0.00	0.00	0.00
table height 25.2 (No. 4 red)	0.00	0.00	0.00
table height 28 (No. 5 green)	0.00	0.00	0.00
table height 29.15	0.00	0.00	0.00
table height 29.95 (No. 6 blue)	0.00	0.00	0.00
table height 32.3 (No. 7 brown)	0.00	0.00	0.00
metal color M1	0.00	0.00	0.00
top 19mm chipboard laminated (CPL), 2.5mm KU edge, color laminate L2	0.00	0.00	0.00
top 19mm chipboard laminated (CPL) writeable, 2.5mm KU edge in white	117.00	103.00	117.00
plastic glides	2.00	2.00	2.00
2 casters, 2 plastic glides	0.00	0.00	0.00
felt glides	2.00	2.00	2.00
2 casters, 2 felt glides	3.00	3.00	3.00
2-component glides	2.00	2.00	2.00
2 casters, 2-component glides	0.00	0.00	0.00

**Material overview**

**Metal Colors**

M1	030	terra grey
	032	light blue
	033	light green
	041	turquoise
	045	broom yellow
	059	arctic
	063	anthracite
	065	black (RAL 9011)
	071	sapphire blue (RAL 5003)
	084	oxblood
	091	white

**Laminate Colors**

L2	027	natural beech laminate
	028	natural maple laminate
	031	grey white
	035	andes grey
	328	white

**LiteTable-ST**  
Stackable lightweight table.

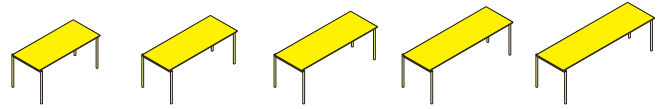

Model	21053	21054	21055	21056	21057
<b>Standard price</b>	<b>\$629.00</b>	<b>\$701.00</b>	<b>\$731.00</b>	<b>\$774.00</b>	<b>\$789.00</b>
dimensions (wxd)	63 x 27.6	70.9 x 27.6	78.75 x 27.6	86.65 x 27.6	94.5 x 27.6
max. number stackable	4	4	4	4	4
table height 15.75 (No. 0 white)	0.00	0.00	0.00	0.00	0.00
table height 20.9 (No. 2 violet)	0.00	0.00	0.00	0.00	0.00
table height 23.25 (No. 3 yellow)	0.00	0.00	0.00	0.00	0.00
table height 25.2 (No. 4 red)	0.00	0.00	0.00	0.00	0.00
table height 28 (No. 5 green)	0.00	0.00	0.00	0.00	0.00
table height 29.15	0.00	0.00	0.00	0.00	0.00
table height 29.95 (No. 6 blue)	0.00	0.00	0.00	0.00	0.00
table height 32.3 (No. 7 brown)	0.00	0.00	0.00	0.00	0.00
metal color M1	0.00	0.00	0.00	0.00	0.00
top 19mm chipboard laminated (CPL), 2.5mm KU edge, color laminate L2	0.00	0.00	0.00	0.00	0.00
top 19mm chipboard laminated (CPL) writeable, 2.5mm KU edge in white	135.00	135.00	164.00	164.00	193.00
plastic glides	2.00	2.00	2.00	2.00	2.00
2 casters, 2 plastic glides	0.00	0.00	0.00	0.00	0.00
felt glides	2.00	2.00	2.00	2.00	2.00
2 casters, 2 felt glides	3.00	3.00	3.00	3.00	3.00
2-component glides	2.00	2.00	2.00	2.00	2.00
2 casters, 2-component glides	0.00	0.00	0.00	0.00	0.00

**Material overview**

**Metal Colors**

- M1 030 terra grey
- 032 light blue
- 033 light green
- 041 turquoise
- 045 broom yellow
- 059 arctic
- 063 anthracite
- 065 black (RAL 9011)
- 071 sapphire blue (RAL 5003)
- 084 oxblood
- 091 white

**Laminate Colors**

- L2 027 natural beech laminate
- 028 natural maple laminate
- 031 grey white
- 035 andes grey
- 328 white

**LiteTable-ST**  
Stackable lightweight table.

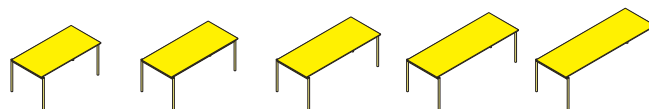

Model	21083	21084	21085	21086	21087
<b>Standard price</b>	<b>\$716.00</b>	<b>\$818.00</b>	<b>\$833.00</b>	<b>\$906.00</b>	<b>\$964.00</b>
dimensions (wxd)	63 x 31.5	70.9 x 31.5	78.75 x 31.5	86.65 x 31.5	94.5 x 31.5
max. number stackable	4	4	4	4	4
table height 15.75 (No. 0 white)	0.00	0.00	0.00	0.00	0.00
table height 20.9 (No. 2 violet)	0.00	0.00	0.00	0.00	0.00
table height 23.25 (No. 3 yellow)	0.00	0.00	0.00	0.00	0.00
table height 25.2 (No. 4 red)	0.00	0.00	0.00	0.00	0.00
table height 28 (No. 5 green)	0.00	0.00	0.00	0.00	0.00
table height 29.15	0.00	0.00	0.00	0.00	0.00
table height 29.95 (No. 6 blue)	0.00	0.00	0.00	0.00	0.00
table height 32.3 (No. 7 brown)	0.00	0.00	0.00	0.00	0.00
metal color M1	0.00	0.00	0.00	0.00	0.00
top 19mm chipboard laminated (CPL), 2.5mm KU edge, color laminate L2	0.00	0.00	0.00	0.00	0.00
top 19mm chipboard laminated (CPL) writeable, 2.5mm KU edge in white	164.00	164.00	193.00	193.00	219.00
plastic glides	2.00	2.00	2.00	2.00	2.00
2 casters, 2 plastic glides	0.00	0.00	0.00	0.00	0.00
felt glides	2.00	2.00	2.00	2.00	2.00
2 casters, 2 felt glides	3.00	3.00	3.00	3.00	3.00
2-component glides	2.00	2.00	2.00	2.00	2.00
2 casters, 2-component glides	0.00	0.00	0.00	0.00	0.00

**Material overview**

**Metal Colors**

M1	030	terra grey
	032	light blue
	033	light green
	041	turquoise
	045	broom yellow
	059	arctic
	063	anthracite
	065	black (RAL 9011)
	071	sapphire blue (RAL 5003)
	084	oxblood
	091	white

**Laminate Colors**

L2	027	natural beech laminate
	028	natural maple laminate
	031	grey white
	035	andes grey
	328	white

**LiteTable-ST**  
Stackable trapezoidal table.

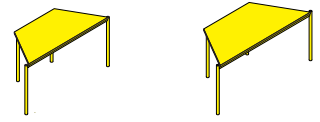

Model	21096	21097
<b>Standard price</b>	<b>\$789.00</b>	<b>\$862.00</b>
dimensions (wxd)	55.15 x 27.6	63 x 31.5
max. number stackable	4	4
table height 15.75 (No. 0 white)	0.00	0.00
table height 20.9 (No. 2 violet)	0.00	0.00
table height 23.25 (No. 3 yellow)	0.00	0.00
table height 25.2 (No. 4 red)	0.00	0.00
table height 28 (No. 5 green)	0.00	0.00
table height 29.15	0.00	0.00
table height 29.95 (No. 6 blue)	0.00	0.00
table height 32.3 (No. 7 brown)	0.00	0.00
metal color M1	0.00	0.00
top 19mm chipboard laminated (CPL), 2.5mm KU edge, color laminate L2	0.00	0.00
top 19mm chipboard laminated (CPL) writeable, 2.5mm KU edge in white	79.00	94.00
plastic glides	0.00	0.00
2 casters, 2 plastic glides	27.00	27.00
felt glides	0.00	0.00
2 casters, 2 felt glides	27.00	27.00
2-component glides	0.00	0.00
2 casters, 2-component glides	27.00	27.00

**Material overview**

**Metal Colors**

M1	030	terra grey
	032	light blue
	033	light green
	041	turquoise
	045	broom yellow
	059	arctic
	063	anthracite
	065	black (RAL 9011)
	071	sapphire blue (RAL 5003)
	084	oxblood
	091	white

**Laminate Colors**

L2	027	natural beech laminate
	028	natural maple laminate
	031	grey white
	035	andes grey
	328	white

**LiteTable-ST**  
Stackable semi-circular table.

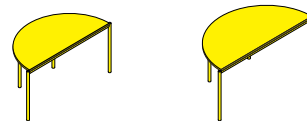

Model	21098	21099
<b>Standard price</b>	<b>\$789.00</b>	<b>\$862.00</b>
dimensions (wxd)	55.15 x 27.6	63 x 31.5
max. number stackable	4	4
table height 15.75 (No. 0 white)	0.00	0.00
table height 20.9 (No. 2 violet)	0.00	0.00
table height 23.25 (No. 3 yellow)	0.00	0.00
table height 25.2 (No. 4 red)	0.00	0.00
table height 28 (No. 5 green)	0.00	0.00
table height 29.15	0.00	0.00
table height 29.95 (No. 6 blue)	0.00	0.00
table height 32.3 (No. 7 brown)	0.00	0.00
metal color M1	0.00	0.00
top 19mm chipboard laminated (CPL), 2.5mm KU edge, color laminate L2	0.00	0.00
top 19mm chipboard laminated (CPL) writeable, 2.5mm KU edge in white	79.00	94.00
plastic glides	0.00	0.00
2 casters, 2 plastic glides	27.00	27.00
felt glides	0.00	0.00
2 casters, 2 felt glides	27.00	27.00
2-component glides	0.00	0.00
2 casters, 2-component glides	27.00	27.00

**Material overview**

**Metal Colors**

M1	030	terra grey
	032	light blue
	033	light green
	041	turquoise
	045	broom yellow
	059	arctic
	063	anthracite
	065	black (RAL 9011)
	071	sapphire blue (RAL 5003)
	084	oxblood
	091	white

**Laminate Colors**

L2	027	natural beech laminate
	028	natural maple laminate
	031	grey white
	035	andes grey
	328	white

**LiteTable-LIGNOdur**  
Table with extremely durable top.

Set of 2x

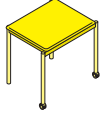
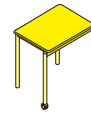

Model	21003	A2512	A2513
<b>Standard price</b>	<b>\$19.00</b>	<b>\$407.00</b>	<b>\$433.00</b>
dimensions (wxd)	--	27.6 x 19.7	29.55 x 25.6
max. number stackable	--	4	4
table height 20.9 (No. 2 violet)	--	0.00	0.00
table height 23.25 (No. 3 yellow)	--	0.00	0.00
table height 25.2 (No. 4 red)	--	0.00	0.00
table height 28 (No. 5 green)	--	0.00	0.00
table height 29.95 (No. 6 blue)	--	0.00	0.00
table height 32.3 (No. 7 brown)	--	0.00	0.00
step height adjustment from 23.25 - 32.3	--	68.00	68.00
metal color M1	--	0.00	0.00
top LIGNOdur color laminate L1	--	0.00	0.00
plastic glides	--	2.00	2.00
2 casters, 2 plastic glides	--	0.00	0.00
felt glides	--	2.00	2.00
2 casters, 2 felt glides	--	3.00	3.00
2-component glides	--	2.00	2.00
2 casters, 2-component glides	--	0.00	0.00
casters	--	50.00	50.00

*It is not recommended to move stacked LiteTables.*

**Material overview**

**Metal Colors**

- M1 030 terra grey
- 032 light blue
- 033 light green
- 041 turquoise
- 045 broom yellow
- 059 arctic
- 063 anthracite
- 065 black (RAL 9011)
- 071 sapphire blue (RAL 5003)
- 084 oxblood
- 091 white

**Laminate Colors**

- L1 027 natural beech laminate
- 028 natural maple laminate
- 031 grey white
- 035 andes grey

**TriTable-III**  
Triangle table.

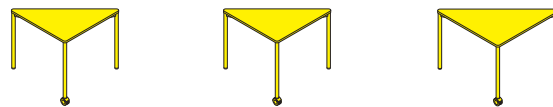

Model	01426	01427	01428
<b>Standard price</b>	<b>\$432.00</b>	<b>\$445.00</b>	<b>\$451.00</b>
dimensions (wxd)	43.75 / 31.5 x 31.5	46.55 / 33.5 x 33.5	49.3 / 35.45 x 35.45
max. number stackable	8	8	8
table height 15.75 (No. 0 white)	0.00	0.00	0.00
table height 20.9 (No. 2 violet)	0.00	0.00	0.00
table height 23.25 (No. 3 yellow)	0.00	0.00	0.00
table height 25.2 (No. 4 red)	0.00	0.00	0.00
table height 28 (No. 5 green)	0.00	0.00	0.00
table height 29.95 (No. 6 blue)	0.00	0.00	0.00
table height 32.3 (No. 7 brown)	0.00	0.00	0.00
step height adjustment from 23.25 - 32.3	68.00	68.00	68.00
metal color M1	0.00	0.00	0.00
top 19mm chipboard laminated (CPL) color laminate L2	0.00	0.00	0.00
top 19mm chipboard laminated (CPL) writeable, 2.5mm KU edge in white	111.00	111.00	111.00
plastic glides	0.00	0.00	0.00
1 caster, 2 plastic glides	0.00	0.00	0.00
felt glides	0.00	0.00	0.00
1 caster, 2 felt glides	0.00	0.00	0.00
2-component glides	0.00	0.00	0.00
1 caster, 2-component glides	0.00	0.00	0.00
3 casters	41.00	41.00	41.00
with plastic bin 3in, C3	88.00	88.00	88.00
with plastic bin 3in with lid, C3	100.00	100.00	100.00
with rails, without plastic bin	59.00	59.00	59.00

**Material overview**

**Metal Colors**

M1	030	terra grey
	032	light blue
	033	light green
	041	turquoise
	045	broom yellow
	059	arctic
	063	anthracite
	065	black (RAL 9011)
	071	sapphire blue (RAL 5003)
	084	oxblood
	091	white

**Laminate Colors**

L2	027	natural beech laminate
	028	natural maple laminate
	031	grey white
	035	andes grey
	328	white

**Plastic Colors**

C3	001	red
	014	anthracite
	016	translucent
	030	dark red
	031	dark blue
	032	light blue
	033	light green
	038	turquoise
	039	broom yellow

**TriCurve**  
**Triangular table with rounded edges.**

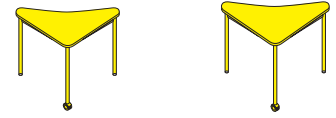

Model	A2516	A2515
<b>Standard price</b>	<b>\$366.00</b>	<b>\$395.00</b>
dimensions (wxd)	42.7 / 28 x 28	37.1 / 31.9 x 31.9
max. number stackable	4	4
table height 20.9 (No. 2 violet)	0.00	0.00
table height 23.25 (No. 3 yellow)	0.00	0.00
table height 25.2 (No. 4 red)	0.00	0.00
table height 28 (No. 5 green)	0.00	0.00
table height 29.95 (No. 6 blue)	0.00	0.00
table height 32.3 (No. 7 brown)	0.00	0.00
step height adjustment from 23.25 - 32.3	68.00	68.00
metal color M1	0.00	0.00
top LIGNOpal (2.5mm KU edge) color laminate L4	0.00	0.00
plastic glides	0.00	0.00
1 caster, 2 plastic glides	0.00	0.00
2-component glides	0.00	0.00
1 caster, 2-component glides	0.00	0.00
felt glides	0.00	0.00
1 caster, 2 felt glides	3.00	3.00
metal grid bookshelf	--	18.00
satchel hooks	6.00	6.00

**Material overview**

**Metal Colors**

- M1 030 terra grey
- 032 light blue
- 033 light green
- 041 turquoise
- 045 broom yellow
- 059 arctic
- 063 anthracite
- 065 black (RAL 9011)
- 071 sapphire blue (RAL 5003)
- 084 oxblood
- 091 white

**Laminate Colors**

- L4 027 natural beech laminate
- 028 natural maple laminate
- 029 natural walnut laminate
- 031 grey white
- 035 andes grey
- 328 white
- 340 natural oak laminate
- 415 terra grey

**RondoSit-R**

Sit-at table with round tube column and round plate base.

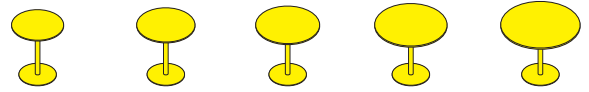

Model	22204	22205	22206*	22207*	22208*
<b>Standard price</b>	<b>\$920.00</b>	<b>\$938.00</b>	<b>\$1,177.00</b>	<b>\$1,276.00</b>	<b>\$1,384.00</b>
dimensions (wxd) (Ø)	27.6	31.5	35.45	39.4	47.25
table height 28	0.00	0.00	0.00	0.00	0.00
table height 29.15	0.00	0.00	0.00	0.00	0.00
round base plate (Ø)	24	24	24	24	24
metal color M2	0.00	0.00	0.00	0.00	0.00
top 19mm chipboard laminated (CPL), 2.5mm KU edge, color laminate L2	0.00	0.00	0.00	0.00	0.00
top 19mm chipboard laminated (CPL) writeable, 2.5mm KU edge in white	94.00	97.00	117.00	135.00	181.00
adjustable plastic glides	0.00	0.00	0.00	0.00	0.00
adjustable glides with felt	0.00	0.00	0.00	0.00	0.00

*\*Knocked-down delivery for marked models.*

*Veneers available upon request.*

**Material overview**

**Metal Colors**

- M2 059 arctic
- 063 anthracite
- 065 black (RAL 9011)
- 091 white

**Laminate Colors**

- L2 027 natural beech laminate
- 028 natural maple laminate
- 031 grey white
- 035 andes grey
- 328 white

**RondoStand-R**  
Stand-at table with round tube column and round plate base.

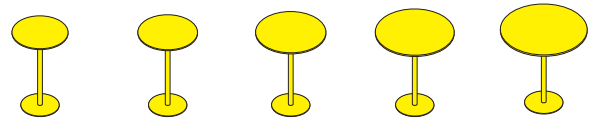

Model	22214	22215	22216*	22217*	22218*
<b>Standard price</b>	<b>\$984.00</b>	<b>\$990.00</b>	<b>\$1,256.00</b>	<b>\$1,308.00</b>	<b>\$1,789.00</b>
dimensions (wxd) (Ø)	27.6	31.5	35.45	39.4	47.25
table height	41.75	41.75	41.75	41.75	41.75
round base plate (Ø)	24	24	24	24	24
metal color M2	0.00	0.00	0.00	0.00	0.00
top 19mm chipboard laminated (CPL), 2.5mm KU edge, color laminate L2	0.00	0.00	0.00	0.00	0.00
top 19mm chipboard laminated (CPL) writeable, 2.5mm KU edge in white	94.00	97.00	117.00	135.00	181.00
adjustable plastic glides	0.00	0.00	0.00	0.00	0.00
adjustable glides with felt	0.00	0.00	0.00	0.00	0.00

*\*Knocked-down delivery for marked models.*

*Veneers available upon request.*

**Material overview**

**Metal Colors**

- M2 059 arctic
- 063 anthracite
- 065 black (RAL 9011)
- 091 white

**Laminate Colors**

- L2 027 natural beech laminate
- 028 natural maple laminate
- 031 grey white
- 035 andes grey
- 328 white

**RondoLift-R**  
 Height-adjustable sitting/standing table with round tube column and base.

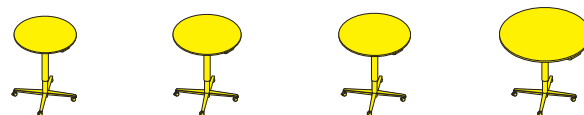

Model	22235	22236	22237	22238
<b>Standard price</b>	<b>\$1,620.00</b>	<b>\$2,029.00</b>	<b>\$2,234.00</b>	<b>\$2,496.00</b>
dimensions (Ø)	31.5	35.45	39.4	47.25
table height	27.6 - 44.3	27.6 - 44.3	27.6 - 44.3	27.6 - 44.3
star foot (Ø)	33½	33½	41	41
metal color M2	0.00	0.00	0.00	0.00
top 19mm chipboard laminated (CPL), 2.5mm KU edge, color laminate L2	0.00	0.00	0.00	0.00
top 19mm chipboard laminated (CPL) writeable, 2.5mm KU edge in white	88.00	111.00	155.00	175.00
with 13.75" high modesty screen in LIGNOpal L3	--	--	--	--
with 13.75" high modesty screen (HPL solid core) L4	--	--	--	--
adjustable plastic glides	0.00	0.00	0.00	0.00
adjustable glides with felt	0.00	0.00	0.00	0.00
casters	0.00	0.00	0.00	0.00
lock unified locking 18001	--	56.00	56.00	56.00
fixed tabletop	0.00	0.00	0.00	0.00
hinged tabletop	--	0.00	0.00	0.00

Veneers available upon request.

**Material overview**

**Metal Colors**

- M2 059 arctic
- 063 anthracite
- 065 black (RAL 9011)
- 091 white

**Laminate Colors**

- |  |  |   |   |
|--|--|---|---|
| <ul style="list-style-type: none"> <li>L2 027 natural beech laminate</li> <li>028 natural maple laminate</li> <li>031 grey white</li> <li>035 andes grey</li> <li>328 white</li> </ul> | <ul style="list-style-type: none"> <li>L3 017 astral silver</li> <li>018 anthracite</li> <li>019 plain black</li> <li>027 natural beech laminate</li> <li>028 natural maple laminate</li> <li>029 natural walnut laminate</li> <li>031 grey white</li> <li>035 andes grey</li> </ul> | <ul style="list-style-type: none"> <li>328 white</li> <li>340 natural oak laminate</li> <li>415 terra grey</li> </ul> | <ul style="list-style-type: none"> <li>L4 027 natural beech laminate</li> <li>028 natural maple laminate</li> <li>029 natural walnut laminate</li> <li>031 grey white</li> <li>035 andes grey</li> <li>328 white</li> <li>340 natural oak laminate</li> <li>415 terra grey</li> </ul> |
|--|--|---|---|

**RondoLift-R**  
 Height-adjustable sit-at and stand-at table with round tube column and round plate base.

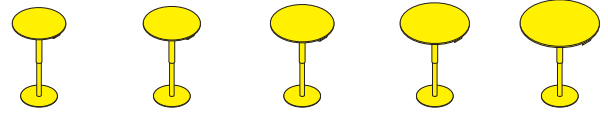

Model	22224	22225	22226*	22227*	22228*
<b>Standard price</b>	<b>\$1,708.00</b>	<b>\$1,722.00</b>	<b>\$1,970.00</b>	<b>\$2,189.00</b>	<b>\$2,729.00</b>
dimensions (wxd) (Ø)	27.6	31.5	35.45	39.4	47.25
table height	27.6 - 44.3	27.6 - 44.3	27.6 - 44.3	27.6 - 44.3	27.6 - 44.3
round base plate (Ø)	24	24	24	24	24
metal color M2	0.00	0.00	0.00	0.00	0.00
top 19mm chipboard laminated (CPL), 2.5mm KU edge, color laminate L2	0.00	0.00	0.00	0.00	0.00
top 19mm chipboard laminated (CPL) writeable, 2.5mm KU edge in white	94.00	97.00	117.00	135.00	181.00
adjustable plastic glides	0.00	0.00	0.00	0.00	0.00
adjustable glides with felt	0.00	0.00	0.00	0.00	0.00

*\*Knocked-down delivery for marked models.*

*Veneers available upon request.*

**Material overview**

**Metal Colors**

- M2 059 arctic
- 063 anthracite
- 065 black (RAL 9011)
- 091 white

**Laminate Colors**

- L2 027 natural beech laminate
- 028 natural maple laminate
- 031 grey white
- 035 andes grey
- 328 white

**RondoLift-R**  
**Height-adjustable teacher's desk in sitting/standing height**  
**with round tube column and base.**



Model	22241	22242	22240
<b>Standard price</b>	<b>\$1,985.00</b>	<b>\$2,072.00</b>	<b>\$1,810.00</b>
dimensions (wxd) (Ø)	51.2 x 33.1	47.25 x 33.1	47.25 x 27.6
table height	27.6 - 44.3	27.6 - 44.3	27.6 - 44.3
star foot (wxd) (Ø)	37.8 x 26.4	37.8 x 26.4	37.8 x 26.4
metal color M2	0.00	0.00	0.00
top 19mm chipboard laminated (CPL), 2.5mm KU edge, color laminate L2	0.00	0.00	0.00
top 19mm chipboard laminated (CPL) writeable, 2.5mm KU edge in white	149.00	135.00	126.00
with 13.75" high modesty screen in LIGNOpal L3	111.00	120.00	120.00
with 13.75" high modesty screen (HPL solid core) L4	301.00	269.00	269.00
1 drawer centered, front laminate L3	292.00	--	292.00
1 drawer left or right, black	--	292.00	--
2 drawers, black	--	584.00	--
cable conduit, left or right	--	97.00	--
unified locking 18001	0.00	0.00	0.00
locking as indicated	0.00	0.00	0.00
metal bow handle, Ni- or Cr- plated	0.00	0.00	0.00
adjustable plastic glides	0.00	0.00	0.00
adjustable glides with felt	0.00	0.00	0.00
casters	0.00	0.00	0.00

Veneers available upon request.

**Material overview**

**Metal Colors**

- M2 059 arctic
- 063 anthracite
- 065 black (RAL 9011)
- 091 white

**Laminate Colors**

- |  |   |   |
|--|---|---|
| <ul style="list-style-type: none"> <li>L2 027 natural beech laminate</li> <li>028 natural maple laminate</li> <li>031 grey white</li> <li>035 andes grey</li> <li>328 white</li> </ul>   | <ul style="list-style-type: none"> <li>328 white</li> <li>340 natural oak laminate</li> <li>415 terra grey</li> </ul> | <ul style="list-style-type: none"> <li>L4 027 natural beech laminate</li> <li>028 natural maple laminate</li> <li>029 natural walnut laminate</li> <li>031 grey white</li> <li>035 andes grey</li> <li>328 white</li> <li>340 natural oak laminate</li> <li>415 terra grey</li> </ul> |
| <ul style="list-style-type: none"> <li>L3 017 astral silver</li> <li>018 anthracite</li> <li>019 plain black</li> <li>027 natural beech laminate</li> <li>028 natural maple laminate</li> <li>029 natural walnut laminate</li> <li>031 grey white</li> <li>035 andes grey</li> </ul> |   |   |

**RondoSit-Q**

Sit-at table with square tubular column and square plate base.



Model	22200	22201	22202*	22203*
<b>Standard price</b>	<b>\$1,116.00</b>	<b>\$1,148.00</b>	<b>\$1,200.00</b>	<b>\$1,226.00</b>
dimensions (wxd) (Ø)	27.6 x 27.6	31.5 x 31.5	35.45 x 35.45	39.4 x 39.4
table height 28	0.00	0.00	0.00	0.00
table height 29.15	0.00	0.00	0.00	0.00
square base plate (Ø)	21.7 x 21.7	21.7 x 21.7	21.7 x 21.7	21.7 x 21.7
metal color M2	0.00	0.00	0.00	0.00
top 19mm chipboard laminated (CPL), 2.5mm KU edge, color laminate L2	0.00	0.00	0.00	0.00
top 19mm chipboard laminated (CPL) writeable, 2.5mm KU edge in white	94.00	97.00	117.00	135.00
adjustable plastic glides	0.00	0.00	0.00	0.00
adjustable glides with felt	0.00	0.00	0.00	0.00

*\*Knocked-down delivery for marked models.*

*Veneers available upon request.*

**Material overview**

**Metal Colors**

- M2 059 arctic
- 063 anthracite
- 065 black (RAL 9011)
- 091 white

**Laminate Colors**

- L2 027 natural beech laminate
- 028 natural maple laminate
- 031 grey white
- 035 andes grey
- 328 white

**RondoStand-Q**  
Stand-at table with square tubular column and square plate base.

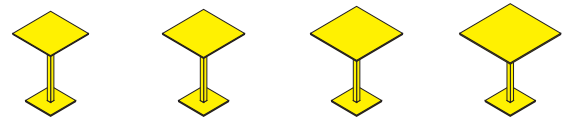

Model	22210	22211	22212*	22213*
<b>Standard price</b>	<b>\$1,043.00</b>	<b>\$1,110.00</b>	<b>\$1,221.00</b>	<b>\$1,273.00</b>
dimensions (wxd) (Ø)	27.6 x 27.6	31.5 x 31.5	35.45 x 35.45	39.4 x 39.4
table height	41.75	41.75	41.75	41.75
square base plate (Ø)	21.7 x 21.7	21.7 x 21.7	21.7 x 21.7	21.7 x 21.7
metal color M2	0.00	0.00	0.00	0.00
top 19mm chipboard laminated (CPL), 2.5mm KU edge, color laminate L2	0.00	0.00	0.00	0.00
top 19mm chipboard laminated (CPL) writeable, 2.5mm KU edge in white	94.00	97.00	117.00	135.00
adjustable plastic glides	0.00	0.00	0.00	0.00
adjustable glides with felt	0.00	0.00	0.00	0.00

*\*Knocked-down delivery for marked models.*

*Veneers available upon request.*

**Material overview**

**Metal Colors**

M2 059 arctic  
063 anthracite  
065 black (RAL 9011)  
091 white

**Laminate Colors**

L2 027 natural beech laminate  
028 natural maple laminate  
031 grey white  
035 andes grey  
328 white

**RondoLift-Q**  
 Height-adjustable sitting/standing table with square tube column and base.



Model	22231	22232	22233
<b>Standard price</b>	<b>\$1,722.00</b>	<b>\$2,131.00</b>	<b>\$2,146.00</b>
dimensions (wxd) (Ø)	31.5 x 31.5	35.45 x 35.45	39.4 x 39.4
table height	27.6 - 44.3	27.6 - 44.3	27.6 - 44.3
star foot (Ø)	41	41	41
metal color M2	0.00	0.00	0.00
top 19mm chipboard laminated (CPL), 2.5mm KU edge, color laminate L2	0.00	0.00	0.00
top 19mm chipboard laminated (CPL) writeable, 2.5mm KU edge in white	111.00	111.00	117.00
with 13.75" high modesty screen in LIGNOpal L3	111.00	111.00	117.00
with 13.75" high modesty screen (HPL solid core) L4	208.00	225.00	245.00
adjustable plastic glides	0.00	0.00	0.00
adjustable glides with felt casters	0.00	0.00	0.00
lock unified locking 18001	--	56.00	56.00
fixed tabletop	0.00	0.00	0.00
hinged tabletop	--	0.00	0.00

Veneers available upon request.

**Material overview**

**Metal Colors**

- M2 059 arctic
- 063 anthracite
- 065 black (RAL 9011)
- 091 white

**Laminate Colors**

- |  |   |  |   |
|--|---|--|---|
| <ul style="list-style-type: none"> <li>L2 027 natural beech laminate</li> <li>028 natural maple laminate</li> <li>031 grey white</li> <li>035 andes grey</li> <li>328 white</li> </ul>   | <ul style="list-style-type: none"> <li>L3 017 astral silver</li> <li>018 anthracite</li> <li>019 plain black</li> <li>027 natural beech laminate</li> <li>028 natural maple laminate</li> <li>029 natural walnut laminate</li> <li>031 grey white</li> <li>035 andes grey</li> <li>328 white</li> </ul> | <ul style="list-style-type: none"> <li>340 natural oak laminate</li> <li>415 terra grey</li> </ul> |   |
| <table border="0"> <tr> <td style="vertical-align: top;"> <ul style="list-style-type: none"> <li>L4 027 natural beech laminate</li> <li>028 natural maple laminate</li> <li>029 natural walnut laminate</li> <li>031 grey white</li> <li>035 andes grey</li> <li>328 white</li> <li>340 natural oak laminate</li> <li>415 terra grey</li> </ul> </td> </tr> </table> |   |  | <ul style="list-style-type: none"> <li>L4 027 natural beech laminate</li> <li>028 natural maple laminate</li> <li>029 natural walnut laminate</li> <li>031 grey white</li> <li>035 andes grey</li> <li>328 white</li> <li>340 natural oak laminate</li> <li>415 terra grey</li> </ul> |
| <ul style="list-style-type: none"> <li>L4 027 natural beech laminate</li> <li>028 natural maple laminate</li> <li>029 natural walnut laminate</li> <li>031 grey white</li> <li>035 andes grey</li> <li>328 white</li> <li>340 natural oak laminate</li> <li>415 terra grey</li> </ul>  |   |  |   |

**RondoLift-Q**  
 Height-adjustable sit-at and stand-at table with square tubular column and square plate base.

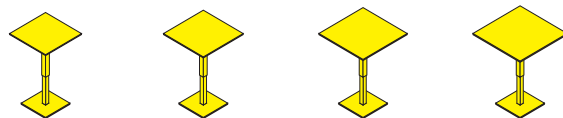

Model	22220	22221	22222*	22223*
<b>Standard price</b>	<b>\$1,431.00</b>	<b>\$2,072.00</b>	<b>\$2,101.00</b>	<b>\$2,131.00</b>
dimensions (wxd) (Ø)	27.6 x 27.6	31.5 x 31.5	35.45 x 35.45	39.4 x 39.4
table height	27.6 - 44.3	27.6 - 44.3	27.6 - 44.3	27.6 - 44.3
square base plate (Ø)	21.7 - 21.7	21.7 - 21.7	21.7 - 21.7	21.7 - 21.7
metal color M2	0.00	0.00	0.00	0.00
top 19mm chipboard laminated (CPL), 2.5mm KU edge, color laminate L2	0.00	0.00	0.00	0.00
top 19mm chipboard laminated (CPL) writeable, 2.5mm KU edge in white	94.00	97.00	117.00	135.00
adjustable plastic glides	0.00	0.00	0.00	0.00
adjustable glides with felt	0.00	0.00	0.00	0.00

*\*Knocked-down delivery for marked models.*

*Veneers available upon request.*

**Material overview**

**Metal Colors**

- M2 059 arctic
- 063 anthracite
- 065 black (RAL 9011)
- 091 white

**Laminate Colors**

- L2 027 natural beech laminate
- 028 natural maple laminate
- 031 grey white
- 035 andes grey
- 328 white

**RondoLift-Q**  
 Height-adjustable teacher's desk in sitting/standing height  
 with square tube column and base.



Model	22246	22247	22245
<b>Standard price</b>	<b>\$1,883.00</b>	<b>\$1,970.00</b>	<b>\$1,693.00</b>
dimensions (wxd) (Ø)	51.2 x 33.1	47.25 x 33.1	47.25 x 27.6
table height	27.6 - 44.3	27.6 - 44.3	27.6 - 44.3
star foot (wxd) (Ø)	37.8 x 26.4	37.8 x 26.4	37.8 x 26.4
metal color M2	0.00	0.00	0.00
top 19mm chipboard laminated (CPL), 2.5mm KU edge, color laminate L2	0.00	0.00	0.00
top 19mm chipboard laminated (CPL) writeable, 2.5mm KU edge in white	149.00	135.00	126.00
with 13.75" high modesty screen in LIGNOpal L3	111.00	120.00	120.00
with 13.75" high modesty screen (HPL solid core) L4	301.00	269.00	269.00
1 drawer centered, front laminate L3	292.00	--	292.00
1 drawer left or right, black	--	292.00	--
2 drawers, black	--	584.00	--
cable conduit, left or right	--	97.00	--
unified locking 18001	0.00	0.00	0.00
locking as indicated	0.00	0.00	0.00
metal bow handle, Ni- or Cr- plated	0.00	0.00	0.00
adjustable plastic glides	0.00	0.00	0.00
adjustable glides with felt	0.00	0.00	0.00
casters	0.00	0.00	0.00

Veneers available upon request.

**Material overview**

**Metal Colors**

- M2 059 arctic
- 063 anthracite
- 065 black (RAL 9011)
- 091 white

**Laminate Colors**

- |  |  |   |   |
|--|--|---|---|
| <ul style="list-style-type: none"> <li>L2 027 natural beech laminate</li> <li>028 natural maple laminate</li> <li>031 grey white</li> <li>035 andes grey</li> <li>328 white</li> </ul>   | <ul style="list-style-type: none"> <li>L3 017 astral silver</li> <li>018 anthracite</li> <li>019 plain black</li> <li>027 natural beech laminate</li> <li>028 natural maple laminate</li> <li>029 natural walnut laminate</li> <li>031 grey white</li> <li>035 andes grey</li> </ul> | <ul style="list-style-type: none"> <li>328 white</li> <li>340 natural oak laminate</li> <li>415 terra grey</li> </ul> |   |
| <table border="0"> <tr> <td style="vertical-align: top;"> <ul style="list-style-type: none"> <li>L4 027 natural beech laminate</li> <li>028 natural maple laminate</li> <li>029 natural walnut laminate</li> <li>031 grey white</li> <li>035 andes grey</li> <li>328 white</li> <li>340 natural oak laminate</li> <li>415 terra grey</li> </ul> </td> </tr> </table> |  |   | <ul style="list-style-type: none"> <li>L4 027 natural beech laminate</li> <li>028 natural maple laminate</li> <li>029 natural walnut laminate</li> <li>031 grey white</li> <li>035 andes grey</li> <li>328 white</li> <li>340 natural oak laminate</li> <li>415 terra grey</li> </ul> |
| <ul style="list-style-type: none"> <li>L4 027 natural beech laminate</li> <li>028 natural maple laminate</li> <li>029 natural walnut laminate</li> <li>031 grey white</li> <li>035 andes grey</li> <li>328 white</li> <li>340 natural oak laminate</li> <li>415 terra grey</li> </ul>  |  |   |   |

**FlipTable-RU**  
**Standing and sitting table with round tube frame and folding top.**

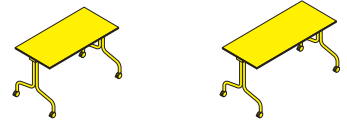

Model	22102	22103
<b>Standard price</b>	<b>\$999.00</b>	<b>\$1,016.00</b>
dimensions (wxd)	51.2 x 25.6	59.1 x 25.6
table height 25.2 (No. 4 red)	0.00	0.00
table height 28 (No. 5 green)	0.00	0.00
table height 29.15	0.00	0.00
table height 29.95 (No. 6 blue)	0.00	0.00
table height 34.65	41.00	41.00
table height 41.75	65.00	65.00
step height adjustment from 29.15 - 38.2	94.00	94.00
step height adjustment from 25.2 - 29.95	94.00	94.00
metal color legs M1	0.00	0.00
metal color legs M060	175.00	175.00
top 19mm chipboard laminated (CPL) (2.5mm KU edge) L2	0.00	0.00
top 19mm chipboard laminated (CPL) writeable, 2.5mm KU edge in white	120.00	135.00
table connector	73.00	73.00

*Veneers available upon request.*

**Material overview**

**Metal Colors**

- M1 030 terra grey
- 032 light blue
- 033 light green
- 041 turquoise
- 045 broom yellow
- 059 arctic
- 063 anthracite
- 065 black (RAL 9011)
- 071 sapphire blue (RAL 5003)
- 084 oxblood
- 091 white

- Mx 060 chrome-plated

**Laminate Colors**

- L2 027 natural beech laminate
- 028 natural maple laminate
- 031 grey white
- 035 andes grey
- 328 white

**FlipTable-RU**  
 Standing and sitting table with round tube  
 frame and folding top.

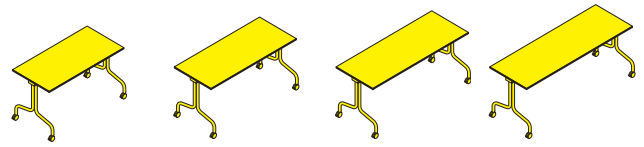

Model	22105	22106	22107	22108
<b>Standard price</b>	<b>\$976.00</b>	<b>\$1,016.00</b>	<b>\$1,072.00</b>	<b>\$1,078.00</b>
dimensions (wxd)	55.15 x 27.6	63 x 27.6	70.9 x 27.6	78.75 x 27.6
table height 25.2 (No. 4 red)	0.00	0.00	0.00	0.00
table height 28 (No. 5 green)	0.00	0.00	0.00	0.00
table height 29.15	0.00	0.00	0.00	0.00
table height 29.95 (No. 6 blue)	0.00	0.00	0.00	0.00
table height 34.65	41.00	41.00	41.00	41.00
table height 41.75	65.00	65.00	65.00	65.00
step height adjustment from 29.15 - 38.2	94.00	94.00	94.00	94.00
step height adjustment from 25.2 - 29.95	94.00	94.00	94.00	94.00
metal color legs M1	0.00	0.00	0.00	0.00
metal color legs M060	175.00	175.00	175.00	175.00
top 19mm chipboard laminated (CPL) (2.5mm KU edge) L2	0.00	0.00	0.00	0.00
top 19mm chipboard laminated (CPL) writeable, 2.5mm KU edge in white	135.00	143.00	155.00	170.00
table connector	73.00	73.00	73.00	73.00

Veneers available upon request.

**Material overview**

**Metal Colors**

- M1 030 terra grey
- 032 light blue
- 033 light green
- 041 turquoise
- 045 broom yellow
- 059 arctic
- 063 anthracite
- 065 black (RAL 9011)
- 071 sapphire blue (RAL 5003)
- 084 oxblood
- 091 white

**Laminate Colors**

- L2 027 natural beech laminate
- 028 natural maple laminate
- 031 grey white
- 035 andes grey
- 328 white

- Mx 060 chrome-plated

**FlipTable-RU**  
 Standing and sitting table with round tube frame and folding top.

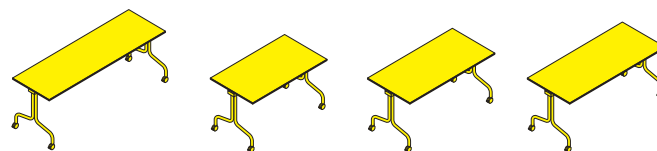

Model	22109	22110	22111	22112
<b>Standard price</b>	<b>\$1,081.00</b>	<b>\$1,037.00</b>	<b>\$1,072.00</b>	<b>\$1,078.00</b>
dimensions (wxd)	86.65 x 27.6	55.15 x 31.5	63 x 31.5	70.9 x 31.5
table height 25.2 (No. 4 red)	0.00	--	--	--
table height 28 (No. 5 green)	0.00	0.00	0.00	0.00
table height 29.15	0.00	0.00	0.00	0.00
table height 29.95 (No. 6 blue)	0.00	0.00	0.00	0.00
table height 34.65	41.00	41.00	41.00	41.00
table height 41.75	65.00	65.00	65.00	65.00
step height adjustment from 29.15 - 38.2	94.00	94.00	94.00	94.00
step height adjustment from 25.2 - 29.95	94.00	--	--	--
step height adjustment from 28 - 29.95	--	94.00	94.00	94.00
metal color legs M1	0.00	0.00	0.00	0.00
metal color legs M060	175.00	175.00	175.00	175.00
top 19mm chipboard laminated (CPL) (2.5mm KU edge) L2	0.00	0.00	0.00	0.00
top 19mm chipboard laminated (CPL) writeable, 2.5mm KU edge in white	187.00	135.00	155.00	170.00
table connector	73.00	73.00	73.00	73.00

*Veneers available upon request.*

**Material overview**

**Metal Colors**

- M1 030 terra grey
- 032 light blue
- 033 light green
- 041 turquoise
- 045 broom yellow
- 059 arctic
- 063 anthracite
- 065 black (RAL 9011)
- 071 sapphire blue (RAL 5003)
- 084 oxblood
- 091 white

**Laminate Colors**

- L2 027 natural beech laminate
- 028 natural maple laminate
- 031 grey white
- 035 andes grey
- 328 white

- Mx 060 chrome-plated

**FlipTable-RU**  
**Standing and sitting table with round tube frame and folding top.**

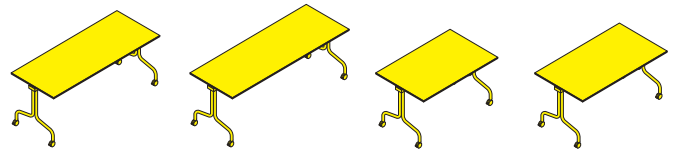

Model	22113	22114	22115	22116
<b>Standard price</b>	<b>\$1,116.00</b>	<b>\$1,142.00</b>	<b>\$1,060.00</b>	<b>\$1,066.00</b>
dimensions (wxd)	78.75 x 31.5	86.65 x 31.5	55.15 x 35.45	63 x 35.45
table height 28 (No. 5 green)	0.00	0.00	0.00	0.00
table height 29.15	0.00	0.00	0.00	0.00
table height 29.95 (No. 6 blue)	0.00	0.00	0.00	0.00
table height 34.65	41.00	41.00	41.00	41.00
table height 41.75	65.00	65.00	65.00	65.00
step height adjustment from 29.15 - 38.2	94.00	94.00	94.00	94.00
step height adjustment from 25.2 - 29.95	--	--	--	--
step height adjustment from 28 - 29.95	94.00	94.00	94.00	94.00
metal color legs M1	0.00	0.00	0.00	0.00
metal color legs M060	175.00	175.00	175.00	175.00
top 19mm chipboard laminated (CPL) (2.5mm KU edge) color laminate L2	0.00	0.00	0.00	0.00
top 19mm chipboard laminated (CPL) writeable, 2.5mm KU edge in white	187.00	202.00	149.00	164.00
table connector	73.00	73.00	73.00	73.00

Veneers available upon request.

**Material overview**

**Metal Colors**

- M1 030 terra grey
- 032 light blue
- 033 light green
- 041 turquoise
- 045 broom yellow
- 059 arctic
- 063 anthracite
- 065 black (RAL 9011)
- 071 sapphire blue (RAL 5003)
- 084 oxblood
- 091 white

**Laminate Colors**

- L2 027 natural beech laminate
- 028 natural maple laminate
- 031 grey white
- 035 andes grey
- 328 white

- Mx 060 chrome-plated

**FlipTable-RU**  
 Standing and sitting table with round tube  
 frame and folding top.

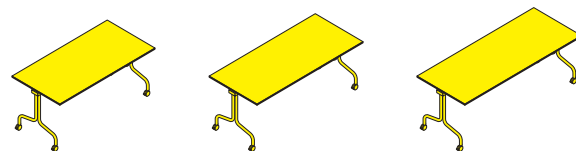

Model	22117	22118	22119
<b>Standard price</b>	<b>\$1,142.00</b>	<b>\$1,154.00</b>	<b>\$1,183.00</b>
dimensions (wxd)	70.9 x 35.45	78.75 x 35.45	86.65 x 35.45
table height 28 (No. 5 green)	0.00	0.00	0.00
table height 29.15	0.00	0.00	0.00
table height 29.95 (No. 6 blue)	0.00	0.00	0.00
table height 34.65	41.00	41.00	41.00
table height 41.75	65.00	65.00	65.00
step height adjustment from 29.15 - 38.2	94.00	94.00	94.00
step height adjustment from 25.2 - 29.95	--	--	--
step height adjustment from 28 - 29.95	94.00	94.00	94.00
metal color legs M1	0.00	0.00	0.00
metal color legs M060	175.00	175.00	175.00
top 19mm chipboard laminated (CPL) (2.5mm KU edge) color laminate L2	0.00	0.00	0.00
top 19mm chipboard laminated (CPL) writeable, 2.5mm KU edge in white	187.00	202.00	219.00
table connector	73.00	73.00	73.00

*Veneers available upon request.*

**Material overview**

**Metal Colors**

- M1 030 terra grey
- 032 light blue
- 033 light green
- 041 turquoise
- 045 broom yellow
- 059 arctic
- 063 anthracite
- 065 black (RAL 9011)
- 071 sapphire blue (RAL 5003)
- 084 oxblood
- 091 white

**Laminate Colors**

- L2 027 natural beech laminate
- 028 natural maple laminate
- 031 grey white
- 035 andes grey
- 328 white

- Mx 060 chrome-plated

**FlipTable-TR**  
**Standing and sitting table with T-foot and round tube column and folding top.**

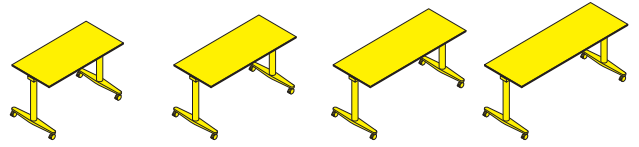

Model	22125	22126	22127	22128
<b>Standard price</b>	<b>\$1,133.00</b>	<b>\$1,142.00</b>	<b>\$1,200.00</b>	<b>\$1,200.00</b>
dimensions (wxd)	55.15 x 27.6	63 x 27.6	70.9 x 27.6	78.75 x 27.6
table height 25.2 (No. 4 red)	0.00	0.00	0.00	0.00
table height 28 (No. 5 green)	0.00	0.00	0.00	0.00
table height 29.15	0.00	0.00	0.00	0.00
table height 29.95 (No. 6 blue)	0.00	0.00	0.00	0.00
table height 34.65	41.00	41.00	41.00	41.00
table height 41.75	65.00	65.00	65.00	65.00
metal color legs M1	0.00	0.00	0.00	0.00
metal color foot M060, black post/leg	394.00	394.00	394.00	394.00
top 19mm chipboard laminated (CPL) (2.5mm KU edge) L2	0.00	0.00	0.00	0.00
top 19mm chipboard laminated (CPL) writeable, 2.5mm KU edge in white	135.00	143.00	155.00	170.00
table connector	73.00	73.00	73.00	73.00

Veneers available upon request.

**Material overview**

**Metal Colors**

- M1 030 terra grey
- 032 light blue
- 033 light green
- 041 turquoise
- 045 broom yellow
- 059 arctic
- 063 anthracite
- 065 black (RAL 9011)
- 071 sapphire blue (RAL 5003)
- 084 oxblood
- 091 white

**Laminate Colors**

- L2 027 natural beech laminate
- 028 natural maple laminate
- 035 andes grey
- 031 grey white
- 328 white

- Mx 060 chrome-plated

**FlipTable-TR**  
 Standing and sitting table with T-foot and round  
 tube column and folding top.

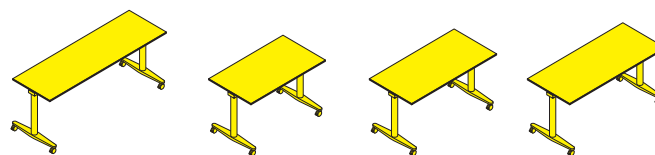

Model	22129	22130	22131	22132
<b>Standard price</b>	<b>\$1,215.00</b>	<b>\$1,148.00</b>	<b>\$1,174.00</b>	<b>\$1,203.00</b>
dimensions (wxd)	86.65 x 27.6	55.15 x 31.5	63 x 31.5	70.9 x 31.5
table height 25.2 (No. 4 red)	0.00	0.00	0.00	0.00
table height 28 (No. 5 green)	0.00	0.00	0.00	0.00
table height 29.15	0.00	0.00	0.00	0.00
table height 29.95 (No. 6 blue)	0.00	0.00	0.00	0.00
table height 34.65	41.00	41.00	41.00	41.00
table height 41.75	65.00	65.00	65.00	65.00
metal color legs M1	0.00	0.00	0.00	0.00
metal color foot M060, black post/leg	394.00	394.00	394.00	394.00
top 19mm chipboard laminated (CPL) (2.5mm KU edge) L2	0.00	0.00	0.00	0.00
top 19mm chipboard laminated (CPL) writeable, 2.5mm KU edge in white	187.00	135.00	155.00	170.00
table connector	73.00	73.00	73.00	73.00

Veneers available upon request.

**Material overview**

**Metal Colors**

- M1 030 terra grey
- 032 light blue
- 033 light green
- 041 turquoise
- 045 broom yellow
- 059 arctic
- 063 anthracite
- 065 black (RAL 9011)
- 071 sapphire blue (RAL 5003)
- 084 oxblood
- 091 white

**Laminate Colors**

- L2 027 natural beech laminate
- 028 natural maple laminate
- 031 grey white
- 035 andes grey
- 328 white

- Mx 060 chrome-plated

**FlipTable-TR**  
**Standing and sitting table with T-foot and round tube column and folding top.**

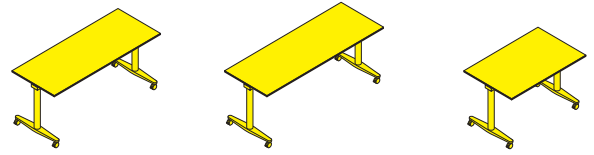

Model	22133	22134	22135
<b>Standard price</b>	<b>\$1,238.00</b>	<b>\$1,241.00</b>	<b>\$1,171.00</b>
dimensions (wxd)	78.75 x 31.5	86.65 x 31.5	55.15 x 35.45
table height 25.2 (No. 4 red)	0.00	--	--
table height 28 (No. 5 green)	0.00	0.00	0.00
table height 29.15	0.00	0.00	0.00
table height 29.95 (No. 6 blue)	0.00	0.00	0.00
table height 34.65	41.00	41.00	41.00
table height 41.75	65.00	65.00	65.00
metal color legs M1	0.00	0.00	0.00
metal color foot M060, black post/leg	394.00	394.00	394.00
top 19mm chipboard laminated (CPL) (2.5mm KU edge) L2	0.00	0.00	0.00
top 19mm chipboard laminated (CPL) writeable, 2.5mm KU edge in white	187.00	202.00	149.00
table connector	73.00	73.00	73.00

*Veneers available upon request.*

**Material overview**

**Metal Colors**

- M1 030 terra grey
- 032 light blue
- 033 light green
- 041 turquoise
- 045 broom yellow
- 059 arctic
- 063 anthracite
- 065 black (RAL 9011)
- 071 sapphire blue (RAL 5003)
- 084 oxblood
- 091 white

**Laminate Colors**

- L2 027 natural beech laminate
- 028 natural maple laminate
- 031 grey white
- 035 andes grey
- 328 white

- Mx 060 chrome-plated

**FlipTable-TR**  
 Standing and sitting table with T-foot and round  
 tube column and folding top.

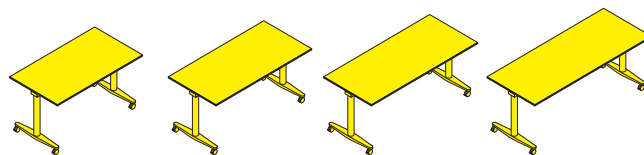

Model	22136	22137	22138	22139
<b>Standard price</b>	<b>\$1,189.00</b>	<b>\$1,200.00</b>	<b>\$1,343.00</b>	<b>\$1,369.00</b>
dimensions (wxd)	63 x 35.45	70.9 x 35.45	78.75 x 35.45	86.65 x 35.45
table height 25.2 (No. 4 red)	0.00	0.00	0.00	0.00
table height 28 (No. 5 green)	0.00	0.00	0.00	0.00
table height 29.15	0.00	0.00	0.00	0.00
table height 29.95 (No. 6 blue)	0.00	0.00	0.00	0.00
table height 34.65	41.00	41.00	41.00	41.00
table height 41.75	65.00	65.00	65.00	65.00
metal color legs M1	0.00	0.00	0.00	0.00
metal color foot M060, black post/leg	394.00	394.00	394.00	394.00
top 19mm chipboard laminated (CPL) (2.5mm KU edge) L2	0.00	0.00	0.00	0.00
top 19mm chipboard laminated (CPL) writeable, 2.5mm KU edge in white	164.00	187.00	202.00	219.00
table connector	73.00	73.00	73.00	73.00

*Veneers available upon request.*

**Material overview**

**Metal Colors**

- M1 030 terra grey
- 032 light blue
- 033 light green
- 041 turquoise
- 045 broom yellow
- 059 arctic
- 063 anthracite
- 065 black (RAL 9011)
- 071 sapphire blue (RAL 5003)
- 084 oxblood
- 091 white

**Laminate Colors**

- L2 027 natural beech laminate
- 028 natural maple laminate
- 031 grey white
- 035 andes grey
- 328 white

- Mx 060 chrome-plated

**FlipTable-TQ**  
 Standing and sitting table with T-foot and square tube column and folding top.

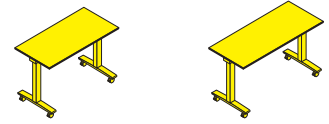

Model	22142	22143
<b>Standard price</b>	<b>\$1,081.00</b>	<b>\$1,119.00</b>
dimensions (wxd)	51.2 x 25.6	59.1 x 25.6
table height 25.2 (No. 4 red)	0.00	0.00
table height 28 (No. 5 green)	0.00	0.00
table height 29.15	0.00	0.00
table height 29.95 (No. 6 blue)	0.00	0.00
table height 34.65	41.00	41.00
table height 41.75	65.00	65.00
metal color legs M1	0.00	0.00
metal color legs M060	307.00	307.00
top 19mm chipboard laminated (CPL) (2.5mm KU edge) L2	0.00	0.00
top 19mm chipboard laminated (CPL) writeable, 2.5mm KU edge in white	111.00	126.00
table connector	73.00	73.00

Veneers available upon request.

**Material overview**

**Metal Colors**

- M1 030 terra grey
- 032 light blue
- 033 light green
- 041 turquoise
- 045 broom yellow
- 059 arctic
- 063 anthracite
- 065 black (RAL 9011)
- 071 sapphire blue (RAL 5003)
- 084 oxblood
- 091 white

**Laminate Colors**

- L2 027 natural beech laminate
- 028 natural maple laminate
- 031 grey white
- 035 andes grey
- 328 white

- Mx 060 chrome-plated

**FlipTable-TQ**  
 Standing and sitting table with T-foot and square tube column and folding top.

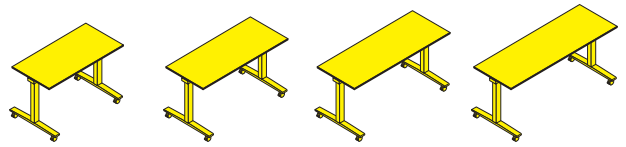

Model	22145	22146	22147	22148
<b>Standard price</b>	<b>\$1,081.00</b>	<b>\$1,110.00</b>	<b>\$1,148.00</b>	<b>\$1,162.00</b>
dimensions (wxd)	55.15 x 27.6	63 x 27.6	70.9 x 27.6	78.75 x 27.6
table height 25.2 (No. 4 red)	0.00	0.00	0.00	0.00
table height 28 (No. 5 green)	0.00	0.00	0.00	0.00
table height 29.15	0.00	0.00	0.00	0.00
table height 29.95 (No. 6 blue)	0.00	0.00	0.00	0.00
table height 34.65	41.00	41.00	41.00	41.00
table height 41.75	65.00	65.00	65.00	65.00
metal color legs M1	0.00	0.00	0.00	0.00
metal color foot M060, black post/leg	307.00	307.00	307.00	307.00
top 19mm chipboard laminated (CPL) (2.5mm KU edge) L2	0.00	0.00	0.00	0.00
top 19mm chipboard laminated (CPL) writeable, 2.5mm KU edge in white	126.00	143.00	155.00	158.00
table connector	73.00	73.00	73.00	73.00

*Veneers available upon request.*

**Material overview**

**Metal Colors**

- M1 030 terra grey
- 032 light blue
- 033 light green
- 041 turquoise
- 045 broom yellow
- 059 arctic
- 063 anthracite
- 065 black (RAL 9011)
- 071 sapphire blue (RAL 5003)
- 084 oxblood
- 091 white

- Mx 060 chrome-plated

**Laminate Colors**

- L2 027 natural beech laminate
- 028 natural maple laminate
- 031 grey white
- 035 andes grey
- 328 white

**FlipTable-TQ**  
 Standing and sitting table with T-foot and square tube column and folding top.

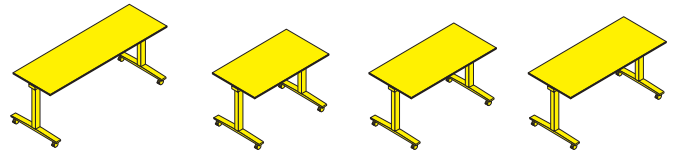

Model	22149	22150	22151	22152
<b>Standard price</b>	<b>\$1,183.00</b>	<b>\$1,154.00</b>	<b>\$1,183.00</b>	<b>\$1,197.00</b>
dimensions (wxd)	86.65 x 27.6	55.15 x 31.5	63 x 31.5	70.9 x 31.5
table height 25.2 (No. 4 red)	0.00	0.00	0.00	0.00
table height 28 (No. 5 green)	0.00	0.00	0.00	0.00
table height 29.15	0.00	0.00	0.00	0.00
table height 29.95 (No. 6 blue)	0.00	0.00	0.00	0.00
table height 34.65	41.00	41.00	41.00	41.00
table height 41.75	65.00	65.00	65.00	65.00
metal color legs M1	0.00	0.00	0.00	0.00
metal color foot M060, black post/leg	394.00	394.00	394.00	394.00
top 19mm chipboard laminated (CPL) (2.5mm KU edge) L2	0.00	0.00	0.00	0.00
top 19mm chipboard laminated (CPL) writeable, 2.5mm KU edge in white	187.00	135.00	155.00	170.00
table connector	73.00	73.00	73.00	73.00

Veneers available upon request.

**Material overview**

**Metal Colors**

- M1 030 terra grey
- 032 light blue
- 033 light green
- 041 turquoise
- 045 broom yellow
- 059 arctic
- 063 anthracite
- 065 black (RAL 9011)
- 071 sapphire blue (RAL 5003)
- 084 oxblood
- 091 white

**Laminate Colors**

- L2 027 natural beech laminate
- 028 natural maple laminate
- 031 grey white
- 035 andes grey
- 328 white

- Mx 060 chrome-plated

**FlipTable-TQ**  
 Standing and sitting table with T-foot and square tube column and folding top.

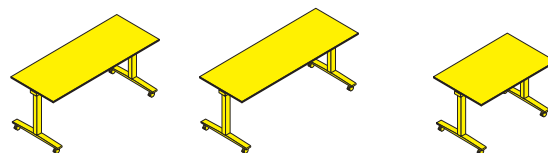

Model	22153	22154	22155
<b>Standard price</b>	<b>\$1,244.00</b>	<b>\$1,294.00</b>	<b>\$1,191.00</b>
dimensions (wxd)	78.75 x 31.5	86.65 x 31.5	55.15 x 35.45
table height 25.2 (No. 4 red)	0.00	0.00	0.00
table height 28 (No. 5 green)	0.00	0.00	0.00
table height 29.15	0.00	0.00	0.00
table height 29.95 (No. 6 blue)	0.00	0.00	0.00
table height 34.65	41.00	41.00	41.00
table height 41.75	65.00	65.00	65.00
metal color legs M1	0.00	0.00	0.00
metal color foot M060, black post/leg	394.00	394.00	394.00
top 19mm chipboard laminated (CPL) (2.5mm KU edge) L2	0.00	0.00	0.00
top 19mm chipboard laminated (CPL) writeable, 2.5mm KU edge in white	187.00	202.00	149.00
table connector	73.00	73.00	73.00

Veneers available upon request.

**Material overview**

**Metal Colors**

- M1 030 terra grey
- 032 light blue
- 033 light green
- 041 turquoise
- 045 broom yellow
- 059 arctic
- 063 anthracite
- 065 black (RAL 9011)
- 071 sapphire blue (RAL 5003)
- 084 oxblood
- 091 white

**Laminate Colors**

- L2 027 natural beech laminate
- 028 natural maple laminate
- 031 grey white
- 035 andes grey
- 328 white

- Mx 060 chrome-plated

**FlipTable-TQ**  
 Standing and sitting table with T-foot and square tube column and folding top.

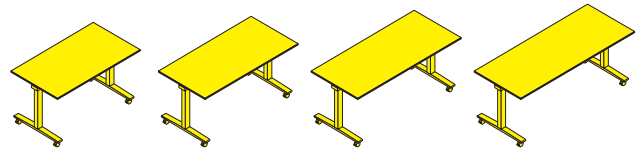

Model	22156	22157	22158	22159
<b>Standard price</b>	<b>\$1,206.00</b>	<b>\$1,285.00</b>	<b>\$1,311.00</b>	<b>\$1,337.00</b>
dimensions (wxd)	63 x 35.45	70.9 x 35.45	78.75 x 35.45	86.65 x 35.45
table height 25.2 (No. 4 red)	0.00	0.00	0.00	0.00
table height 28 (No. 5 green)	0.00	0.00	0.00	0.00
table height 29.15	0.00	0.00	0.00	0.00
table height 29.95 (No. 6 blue)	0.00	0.00	0.00	0.00
table height 34.65	41.00	41.00	41.00	41.00
table height 41.75	65.00	65.00	65.00	65.00
metal color legs M1	0.00	0.00	0.00	0.00
metal color foot M060, black post/leg	394.00	394.00	394.00	394.00
top 19mm chipboard laminated (CPL) (2.5mm KU edge) L2	0.00	0.00	0.00	0.00
top 19mm chipboard laminated (CPL) writeable, 2.5mm KU edge in white	164.00	181.00	202.00	219.00
table connector	73.00	73.00	73.00	73.00

Veneers available upon request.

**Material overview**

**Metal Colors**

- M1 030 terra grey
- 032 light blue
- 033 light green
- 041 turquoise
- 045 broom yellow
- 059 arctic
- 063 anthracite
- 065 black (RAL 9011)
- 071 sapphire blue (RAL 5003)
- 084 oxblood
- 091 white

**Laminate Colors**

- L2 027 natural beech laminate
- 028 natural maple laminate
- 031 grey white
- 035 andes grey
- 328 white

- Mx 060 chrome-plated

**InteractiveTeach**  
Teachers' desk, AV-table.

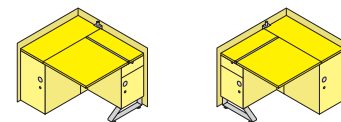

Model	04441	04442
<b>Standard price</b>	<b>\$3,151.00</b>	<b>\$3,151.00</b>
dimensions (wxd)	40.95 x 37.05	40.95 x 37.05
table height 29,15	0.00	0.00
metal color M1	0.00	0.00
body LIGNOpal, L4	0.00	0.00
cheek LIGNOpal with laminate, L6	0.00	0.00
cheek beech veneer natural	832.00	832.00
cheek beech veneer stained, H1	920.00	920.00
unified locking 18001	0.00	0.00
locking as indicated	12.00	12.00
locking plan, site installat.	56.00	56.00
flush handle, nickel-plated	0.00	0.00
comfort monitor arm	730.00	730.00

**Material overview**

**Metal Colors**

M1	030	terra grey
	032	light blue
	033	light green
	041	turquoise
	045	broom yellow
	059	arctic
	063	anthracite
	065	black (RAL 9011)
	071	sapphire blue (RAL 5003)
	084	oxblood
	091	white

**Wood Stain Colors**

H1	011	black
	021	light green
	022	light blue
	023	light grey
	027	dark red
	029	dark blue
	037	traffic red
	041	turquoise
	045	broom yellow
	051	polar white

**Laminate Colors**

L4	017	astral silver
	018	anthracite
	019	plain black
	027	natural beech laminate
	028	natural maple laminate
	029	natural walnut laminate
	031	grey white
	035	andes grey
	328	white
	340	natural oak laminate
	415	terra grey

L6	017	astral silver
	018	anthracite
	019	plain black
	027	natural beech laminate
	028	natural maple laminate
	029	natural walnut laminate
	031	grey white
	035	andes grey
	328	white
	340	natural oak laminate
	415	terra grey

**Puzzle**  
**Freely-shaped table for schools.**

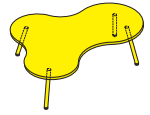

Model	01470
<b>Standard price</b>	<b>\$868.00</b>
dimensions (wxd)	65 x 44.9
table height 20.9 (No. 2 violet)	0.00
table height 23.25 (No. 3 yellow)	0.00
table height 25.2 (No. 4 red)	0.00
table height 28 (No. 5 green)	0.00
table height 29.95 (No. 6 blue)	0.00
table height 32.3 (No. 7 brown)	0.00
metal color M1	0.00
top 25mm chipboard décor LIGNOpal, 2.5mm KU edge, color laminate L6	0.00
adjustable plastic glides	0.00
adjustable glides with felt	12.00

**Material overview**

**Metal Colors**

M1	030	terra grey
	032	light blue
	033	light green
	041	turquoise
	045	broom yellow
	059	arctic
	063	anthracite
	065	black (RAL 9011)
	071	sapphire blue (RAL 5003)
	084	oxblood
	091	white

**Laminate Colors**

L6	017	astral silver
	018	anthracite
	019	plain black
	027	natural beech laminate
	028	natural maple laminate
	029	natural walnut laminate
	031	grey white
	035	andes grey
	328	white
	340	natural oak laminate
	415	terra grey

**TeamTable**  
Freeform stand-at table.



Model	01471
<b>Standard price</b>	<b>\$1,197.00</b>
dimensions (wxd)	65 x 44.9
table height	40.6 / 43.35
metal color M1	0.00
top 25mm chipboard décor LIGNOpal, 2.5mm KU edge, color laminate L6	0.00
adjustable plastic glides	0.00
adjustable glides with felt	12.00
shelves storage shelf LIGNOpal	0.00
shelf color laminate L6	0.00

Veneers and Linoleum available upon request.

**Material overview**

**Metal Colors**

M1	030	terra grey
	032	light blue
	033	light green
	041	turquoise
	045	broom yellow
	059	arctic
	063	anthracite
	065	black (RAL 9011)
	071	sapphire blue (RAL 5003)
	084	oxblood
	091	white

**Laminate Colors**

L6	017	astral silver
	018	anthracite
	019	plain black
	027	natural beech laminate
	028	natural maple laminate
	029	natural walnut laminate
	031	grey white
	035	andes grey
	328	white
	340	natural oak laminate
	415	terra grey

**TriUnion**  
Stand-at table for students.

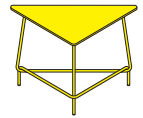
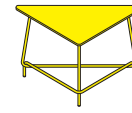
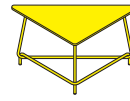

Model	01475	01476	01477
<b>Standard price</b>	<b>\$1,154.00</b>	<b>\$1,226.00</b>	<b>\$1,299.00</b>
dimensions (wxd)	64.1 / 46.25 x 46.25	64.1 / 46.25 x 46.25	64.1 / 46.25 x 46.25
table height	34.7	41.75	47.25
metal color M1	0.00	0.00	0.00
foot support M1	0.00	0.00	0.00
foot support, chrome-plated	47.00	47.00	47.00
top 25mm chipboard décor LIGNOpal, 2.5mm KU edge, color laminate L4	0.00	0.00	0.00
top 13mm phenolic (HPL), rounded black edge, color laminate L4	289.00	289.00	289.00
plastic glides	0.00	0.00	--
felt glides	0.00	0.00	--
mobile casters	0.00	0.00	0.00
table connector	73.00	73.00	73.00
foot support with grip tape	56.00	56.00	56.00

*Veneers and Linoleum available upon request.*

**Material overview**

**Metal Colors**

- M1 030 terra grey
- 032 light blue
- 033 light green
- 041 turquoise
- 045 broom yellow
- 059 arctic
- 063 anthracite
- 065 black (RAL 9011)
- 071 sapphire blue (RAL 5003)
- 084 oxblood
- 091 white

**Laminate Colors**

- L4 027 natural beech laminate
- 028 natural maple laminate
- 029 natural walnut laminate
- 031 grey white
- 035 andes grey
- 328 white
- 340 natural oak laminate
- 415 terra grey

- Mx 060 chrome-plated

**DROP**  
Indoor/outdoor table.

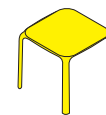
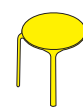

Model	09365	09366
<b>Standard price</b>	<b>\$643.00</b>	<b>\$643.00</b>
table top dimensions (wxd) (Ø)	27.6	28.75 x 28.75
total dimensions (wxd) (Ø)	32.55	40.85
table height 28.35	0.00	0.00
max. number stackable	5	5
plastic glides	0.00	0.00

*Knocked-down delivery for tables on this page.*

**Material overview**

**Plastic Colors**

- Cx 031 white
- 078 dolphin grey

**JUMPER Studio Table**  
Stackable table with rectangular steel legs.

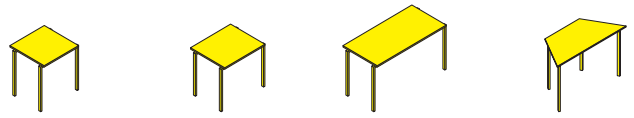

Model	22440	22441	22442	22443
<b>Standard price</b>	<b>\$416.00</b>	<b>\$486.00</b>	<b>\$649.00</b>	<b>\$713.00</b>
dimensions (wxd)	25.6 x 25.6	29.55 x 25.6	51.2 x 25.6	51.2 x 25.6
max. number stackable size 0-4	8	8	8	--
max. number stackable size 5-7	6	6	6	--
table height 15.75 (No. 0 white)	0.00	0.00	0.00	0.00
table height 20.9 (No. 2 violet)	0.00	0.00	0.00	0.00
table height 23.25 (No. 3 yellow)	0.00	0.00	0.00	0.00
table height 25.2 (No. 4 red)	0.00	0.00	0.00	0.00
table height 28 (No. 5 green)	0.00	0.00	0.00	0.00
table height 29.15	0.00	0.00	0.00	0.00
table height 29.95 (No. 6 blue)	0.00	0.00	0.00	0.00
table height 32.3 (No. 7 brown)	0.00	0.00	0.00	0.00
metal color legs M1	0.00	0.00	0.00	0.00
metal color legs M060	394.00	429.00	505.00	377.00
top 19mm chipboard laminated (CPL), 2.5mm KU edge, color laminate L2	0.00	0.00	0.00	0.00
top 19mm chipboard laminated (CPL) writeable, 2.5mm KU edge in white	65.00	65.00	97.00	105.00
plastic glides	0.00	0.00	0.00	0.00
adjustable plastic glides	0.00	0.00	0.00	0.00
felt glides	0.00	0.00	0.00	0.00
adjustable felt glides	12.00	12.00	12.00	12.00
2-component glides	0.00	0.00	0.00	0.00

**Material overview**

**Metal Colors**

- M1 030 terra grey
- 032 light blue
- 033 light green
- 041 turquoise
- 045 broom yellow
- 059 arctic
- 063 anthracite
- 065 black (RAL 9011)
- 071 sapphire blue (RAL 5003)
- 084 oxblood
- 091 white

**Laminate Colors**

- L2 027 natural beech laminate
- 028 natural maple laminate
- 031 grey white
- 035 andes grey
- 328 white

- Mx 060 chrome-plated

**M-Table**  
Side table – sitting height option.

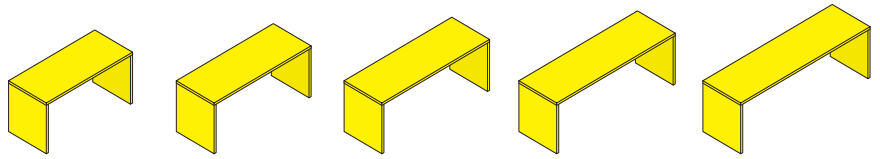

Model	20403	20404	20405	20406	20407
<b>Standard price</b>	<b>\$1,970.00</b>	<b>\$2,087.00</b>	<b>\$2,189.00</b>	<b>\$2,291.00</b>	<b>\$2,393.00</b>
dimensions (wxd)	63 x 27.6	70.9 x 27.6	78.75 x 27.6	86.65 x 27.6	94.5 x 27.6
table height 29.15	0.00	0.00	0.00	0.00	0.00
table height 29.95 (No. 6 blue)	0.00	0.00	0.00	0.00	0.00
top color laminate L4	0.00	0.00	0.00	0.00	0.00
side panels color laminate L4	0.00	0.00	0.00	0.00	0.00
cable outlet left	82.00	82.00	82.00	82.00	82.00
cable outlet right	82.00	82.00	82.00	82.00	82.00
cable outlet centered	82.00	82.00	82.00	82.00	82.00
plastic glides	0.00	0.00	0.00	0.00	0.00
felt glides	9.00	9.00	9.00	9.00	9.00
with floor attachment kit	111.00	111.00	111.00	111.00	111.00
corresponding bench model	30213	30214	30215	30216	30217

*Knocked-down delivery for all M-Table models on this and the next page.*

*Veneers available upon request.*

**Material overview**

**Laminate Colors**

- L4 027 natural beech laminate
- 028 natural maple laminate
- 029 natural walnut laminate
- 031 grey white
- 035 andes grey
- 328 white
- 340 natural oak laminate
- 415 terra grey

**M-Table**  
Side table – sitting height option.

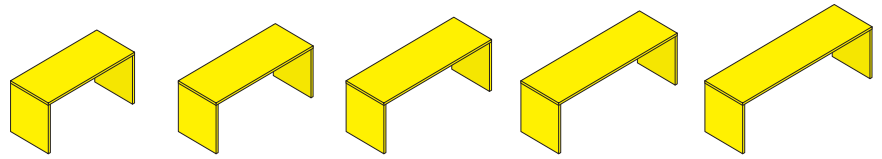

Model	20413	20414	20415	20416	20417
<b>Standard price</b>	<b>\$2,087.00</b>	<b>\$2,189.00</b>	<b>\$2,306.00</b>	<b>\$2,393.00</b>	<b>\$2,510.00</b>
dimensions (wxd)	63 x 31.5	70.9 x 31.5	78.75 x 31.5	86.65 x 31.5	94.5 x 31.5
table height 29.15	0.00	0.00	0.00	0.00	0.00
table height 29.95 (No. 6 blue)	0.00	0.00	0.00	0.00	0.00
top color laminate L4	0.00	0.00	0.00	0.00	0.00
side panels color laminate L4	0.00	0.00	0.00	0.00	0.00
cable outlet left	82.00	82.00	82.00	82.00	82.00
cable outlet right	82.00	82.00	82.00	82.00	82.00
cable outlet centered	82.00	82.00	82.00	82.00	82.00
plastic glides	0.00	0.00	0.00	0.00	0.00
felt glides	9.00	9.00	9.00	9.00	9.00
with floor attachment kit	111.00	111.00	111.00	111.00	111.00
corresponding bench model	30213	30214	30215	30216	30217

*Knocked-down delivery for all M-Table models on this and the next page.*

*Veneers available upon request.*

**Material overview**

**Laminate Colors**

- L4 027 natural beech laminate
- 028 natural maple laminate
- 029 natural walnut laminate
- 031 grey white
- 035 andes grey
- 328 white
- 340 natural oak laminate
- 415 terra grey

**M-Table**  
Side table – standing height option.

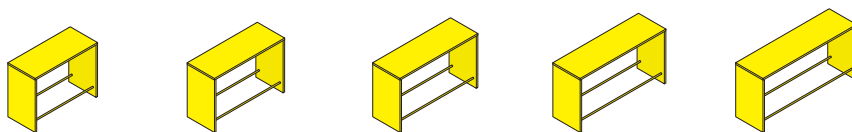

Model	20423	20424	20425	20426	20427
<b>Standard price</b>	<b>\$2,743.00</b>	<b>\$2,801.00</b>	<b>\$2,845.00</b>	<b>\$2,904.00</b>	<b>\$3,006.00</b>
dimensions (wxd)	63 x 27.6	70.9 x 27.6	78.75 x 27.6	86.65 x 27.6	94.5 x 27.6
table height 34.65 (No. 4 red Stand-At)	<b>-52.00</b>	<b>-52.00</b>	<b>-52.00</b>	<b>-52.00</b>	<b>-52.00</b>
table height 41.75 (No. 6 blue Stand-At)	0.00	0.00	0.00	0.00	0.00
table height 47.25 (No. 7 brown Stand-At)	62.00	62.00	62.00	62.00	62.00
foot support M1	0.00	0.00	0.00	0.00	0.00
foot support, chrome-plated without foot support*	88.00 <b>-189.00</b>	88.00 <b>-189.00</b>	88.00 <b>-189.00</b>	88.00 <b>-189.00</b>	88.00 <b>-189.00</b>
top color laminate L4	0.00	0.00	0.00	0.00	0.00
side panels color laminate L4	0.00	0.00	0.00	0.00	0.00
cable outlet left	82.00	82.00	82.00	82.00	82.00
cable outlet right	82.00	82.00	82.00	82.00	82.00
cable outlet centered	82.00	82.00	82.00	82.00	82.00
plastic glides	0.00	0.00	0.00	0.00	0.00
felt glides	9.00	9.00	9.00	9.00	9.00
with floor attachment kit	111.00	111.00	111.00	111.00	111.00
foot support with grip tape	56.00	56.00	56.00	56.00	56.00

\*Only available for table height 34.65 (No. 4 red Stand-At)

Knocked-down delivery for all M-Table models on this and the next page.

Veneers available upon request.

**Material overview**

**Laminate Colors**

L4	027	natural beech laminate
	028	natural maple laminate
	029	natural walnut laminate
	031	grey white
	035	andes grey
	328	white
	340	natural oak laminate
	415	terra grey

**M-Table**  
Side table – standing height option.

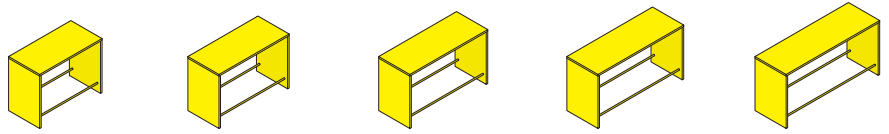

Model	20433	20434	20435	20436	20437
<b>Standard price</b>	<b>\$2,772.00</b>	<b>\$2,874.00</b>	<b>\$2,976.00</b>	<b>\$3,079.00</b>	<b>\$3,195.00</b>
dimensions (wxd)	63 x 31.5	70.9 x 31.5	78.75 x 31.5	86.65 x 31.5	94.5 x 31.5
table height 34.65 (No. 4 red Stand-At)	<b>-52.00</b>	<b>-52.00</b>	<b>-52.00</b>	<b>-52.00</b>	<b>-52.00</b>
table height 41.75 (No. 6 blue Stand-At)	0.00	0.00	0.00	0.00	0.00
table height 47.25 (No. 7 brown Stand-At)	62.00	62.00	62.00	62.00	62.00
foot support M1	0.00	0.00	0.00	0.00	0.00
foot support, chrome-plated	88.00	88.00	88.00	88.00	88.00
without foot support*	<b>-189.00</b>	<b>-189.00</b>	<b>-189.00</b>	<b>-189.00</b>	<b>-189.00</b>
top color laminate L4	0.00	0.00	0.00	0.00	0.00
side panels color laminate L4	0.00	0.00	0.00	0.00	0.00
cable outlet left	82.00	82.00	82.00	82.00	82.00
cable outlet right	82.00	82.00	82.00	82.00	82.00
cable outlet centered	82.00	82.00	82.00	82.00	82.00
plastic glides	0.00	0.00	0.00	0.00	0.00
felt glides	9.00	9.00	9.00	9.00	9.00
with floor attachment kit	111.00	111.00	111.00	111.00	111.00
foot support with grip tape	56.00	56.00	56.00	56.00	56.00

\*Only available for table height 34.65 (No. 4 red Stand-At)

Knocked-down delivery for all M-Table models on this and the next page.

Veneers available upon request.

**Material overview**

**Laminate Colors**

- L4 027 natural beech laminate
- 028 natural maple laminate
- 029 natural walnut laminate
- 031 grey white
- 035 andes grey
- 328 white
- 340 natural oak laminate
- 415 terra grey



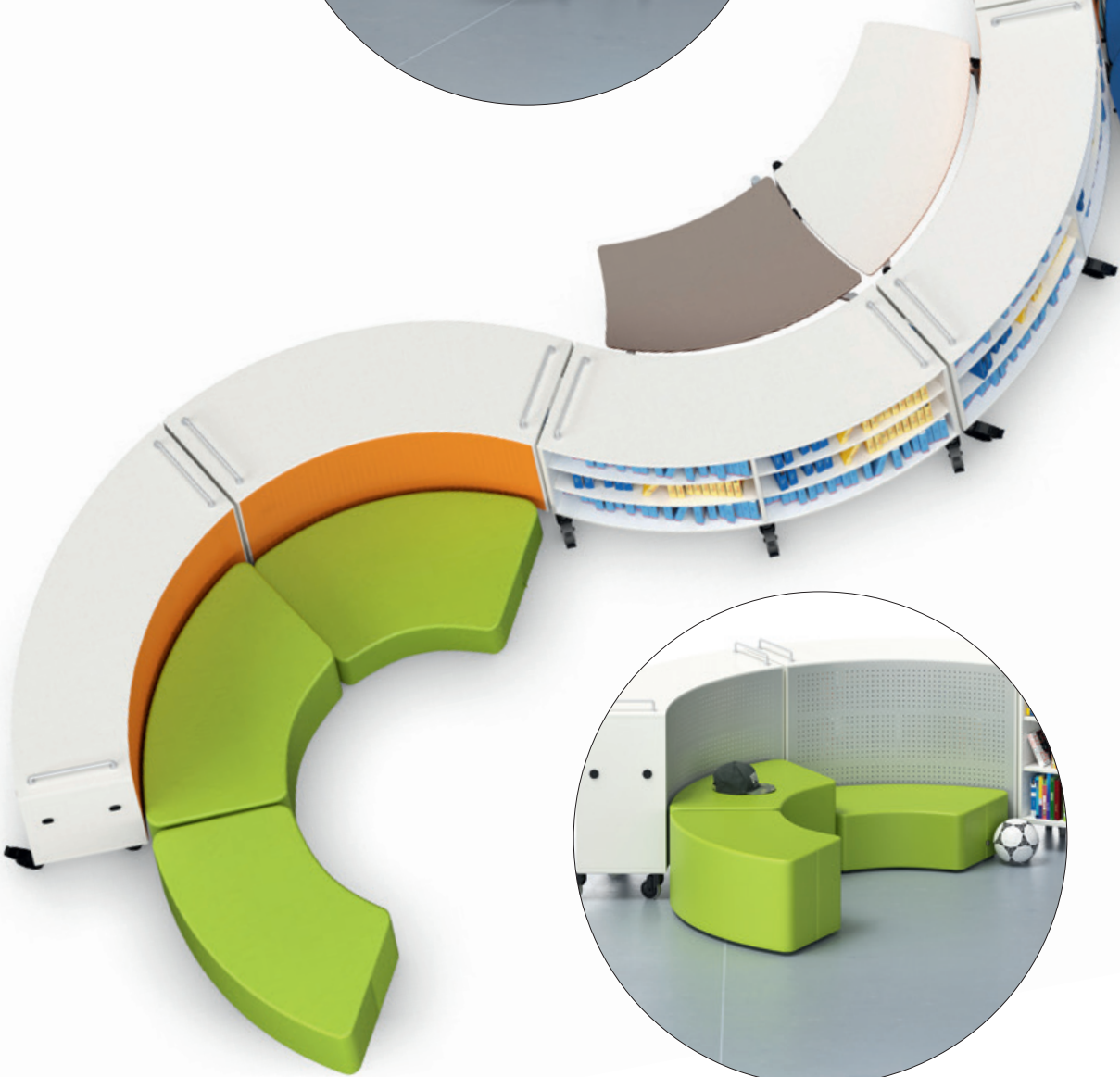
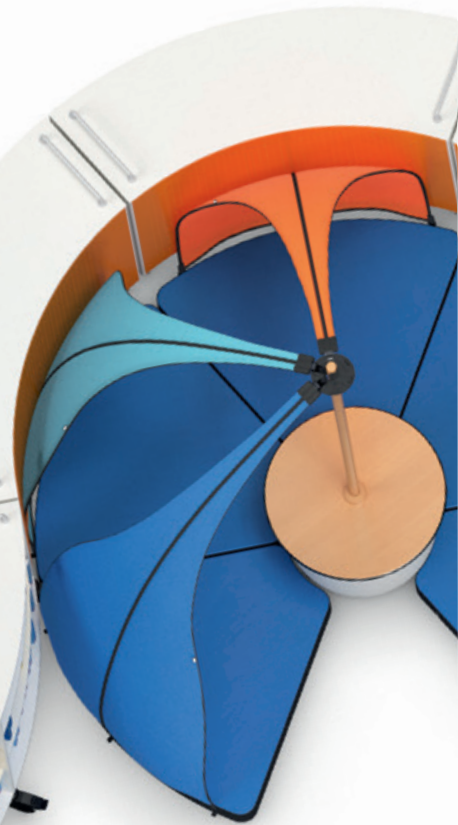



**Shift+**

**Shift+ ThumbPrint  
Stackable desk.**

Convex



Concave



Model	01440	01441
Standard price	\$468.00	\$468.00
dimensions (wxd)	38.15 x 21.3 / 15.4	38.8 x 21.3 / 15.35
table height 15.75 (No. 0 white)	0.00	0.00
table height 20.9 (No. 2 violet)	0.00	0.00
table height 23.25 (No. 3 yellow)	0.00	0.00
table height 25.2 (No. 4 red)	0.00	0.00
table height 28 (No. 5 green)	0.00	0.00
table height 29.95 (No. 6 blue)	0.00	0.00
table height 32.3 (No. 7 brown)	0.00	0.00
step height adjustment from 23.25 - 32.3	68.00	68.00
max. number stackable	6	6
metal color M1	0.00	0.00
top 19mm chipboard laminated (CPL), 2.5mm KU edge, color laminate L2	0.00	0.00
top 19mm chipboard laminated (CPL) writeable, 2.5mm KU edge in white	111.00	111.00
plastic glides	2.00	2.00
2-component glides	2.00	2.00
felt glides	2.00	2.00
2 casters / 2 plastic glides	0.00	0.00
2 casters / 2 2-component glides	0.00	0.00
2 casters / 2 felt glides	0.00	0.00

**Material overview**

**Metal Colors**

- M1 030 terra grey
- 032 light blue
- 033 light green
- 041 turquoise
- 045 broom yellow
- 059 arctic
- 063 anthracite
- 065 black (RAL 9011)
- 071 sapphire blue (RAL 5003)
- 084 oxblood
- 091 white

**Laminate Colors**

- L2 027 natural beech laminate
- 028 natural maple laminate
- 031 grey white
- 035 andes grey
- 328 white

**Shift+ Fusion Table**  
Four-legged table and stackable four-legged table.

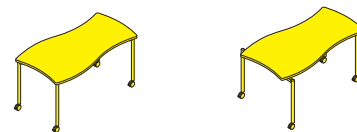

Model	01445	01448
<b>Standard price</b>	<b>\$736.00</b>	<b>\$780.00</b>
dimensions (wxd)	55.45 x 31.05	55.45 x 31.05
table height 15.75 (No. 0 white)	0.00	0.00
table height 20.9 (No. 2 violet)	0.00	0.00
table height 23.25 (No. 3 yellow)	0.00	0.00
table height 25.2 (No. 4 red)	0.00	0.00
table height 28 (No. 5 green)	0.00	0.00
table height 29.95 (No. 6 blue)	0.00	0.00
table height 32.3 (No. 7 brown)	0.00	0.00
step height adjustment from 23.25 - 32.3	68.00	68.00
max. number stackable	--	8
metal color M1	0.00	0.00
top 19mm chipboard laminated (CPL), 2.5mm KU edge, color laminate L2	0.00	0.00
top 19mm chipboard laminated (CPL) writeable, 2.5mm KU edge in white	111.00	111.00
plastic glides	0.00	0.00
2-component glides	0.00	0.00
felt glides	9.00	9.00
mobile	0.00	0.00

**Material overview**

**Metal Colors**

M1	030	terra grey
	032	light blue
	033	light green
	041	turquoise
	045	broom yellow
	059	arctic
	063	anthracite
	065	black (RAL 9011)
	071	sapphire blue (RAL 5003)
	084	oxblood
	091	white

**Laminate Colors**

L2	027	natural beech laminate
	028	natural maple laminate
	031	grey white
	035	andes grey
	328	white

**Shift+ FusionFlip**  
**Table with folding top.**



Model	01451
<b>Standard price</b>	<b>\$1,031.00</b>
dimensions (wxd)	55.45 x 31.05
table height 25.2 (No. 4 red)	0.00
table height 28 (No. 5 green)	0.00
table height 29.15	0.00
table height 29.95 (No. 6 blue)	0.00
table height 34.65	41.00
table height 41.75	65.00
step height adjustment from 29.15 - 38.2	94.00
step height adjustment from 25.2 - 29.95	94.00
metal color M1	0.00
top 19mm chipboard laminated (CPL), 2.5mm KU edge, color laminate L2	0.00
top 19mm chipboard laminated (CPL) writeable, 2.5mm KU edge in white	111.00
mobile	0.00

**Material overview**

**Metal Colors**

M1	030	terra grey
	032	light blue
	033	light green
	041	turquoise
	045	broom yellow
	059	arctic
	063	anthracite
	065	black (RAL 9011)
	071	sapphire blue (RAL 5003)
	084	oxblood
	091	white

**Laminate Colors**

L2	027	natural beech laminate
	028	natural maple laminate
	031	grey white
	035	andes grey
	328	white

**Shift+ BaseStation**  
**Mobile half-round table.**

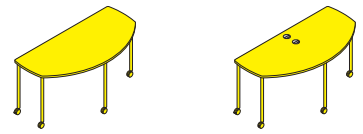

Model	01442	01443*
<b>Standard price</b>	<b>\$964.00</b>	<b>\$1,226.00</b>
dimensions (wxd)	63 x 30.75	63 x 30.75
table height 15.75 (No. 0 white)	0.00	0.00
table height 20.9 (No. 2 violet)	0.00	0.00
table height 23.25 (No. 3 yellow)	0.00	0.00
table height 25.2 (No. 4 red)	0.00	0.00
table height 28 (No. 5 green)	0.00	0.00
table height 29.95 (No. 6 blue)	0.00	0.00
table height 32.3 (No. 7 brown)	0.00	0.00
step height adjustment from 23.25 - 32.3	68.00	68.00
metal color M1	0.00	0.00
top 19mm chipboard laminated (CPL), 2.5mm KU edge, color laminate L2	0.00	0.00
top 19mm chipboard laminated (CPL) writeable, 2.5mm KU edge in white	146.00	146.00
unified locking 18001	--	0.00
locking as indicated	--	6.00
plastic glides	0.00	0.00
felt glides	9.00	9.00
2-component glides	0.00	0.00
mobile	0.00	0.00
2 grommets with cable holder	--	0.00
lockable cpu storage tray	--	0.00
comfort monitor arm	--	730.00

\*Base model 01443 includes one grommet

**Material overview**

**Metal Colors**

- M1 030 terra grey
- 032 light blue
- 033 light green
- 041 turquoise
- 045 broom yellow
- 059 arctic
- 063 anthracite
- 065 black (RAL 9011)
- 071 sapphire blue (RAL 5003)
- 084 oxblood
- 091 white

**Laminate Colors**

- L2 027 natural beech laminate
- 028 natural maple laminate
- 031 grey white
- 035 andes grey
- 328 white

**Shift+ Interact**  
 Height adjustable sit-at/stand-at lectern/table.  
 Fixed height stand-at lectern.

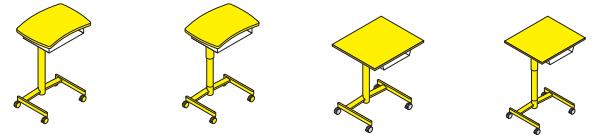

Model	01454	01455	01452	01453
<b>Standard price</b>	<b>\$760.00</b>	<b>\$1,197.00</b>	<b>\$760.00</b>	<b>\$1,197.00</b>
dimensions (wxd)	26.4 x 19.9	26.4 x 19.9	29.55 x 25.6	29.55 x 25.6
table height 36.05	0.00	--	0.00	--
table height 43.4	0.00	--	0.00	--
adjustable height 28 - 44.9	--	0.00	--	0.00
metal color M2	0.00	0.00	0.00	0.00
top 19mm chipboard laminated (CPL), 2.5mm KU edge, color laminate L2	0.00	0.00	0.00	0.00
top 19mm chipboard laminated (CPL) writeable, 2.5mm KU edge in white	111.00	111.00	111.00	111.00
with modesty screen (19mm chipboard panel) L4	--	--	85.00	85.00
with modesty screen (HPL solid core) L4	--	--	219.00	219.00
without book box	<b>-44.00</b>	--	<b>-44.00</b>	--
mobile	0.00	0.00	0.00	0.00

**Material overview**

**Metal Colors**

- M2 059 arctic
- 063 anthracite
- 065 black (RAL 9011)
- 091 white

**Laminate Colors**

- L2 027 natural beech laminate
- 028 natural maple laminate
- 031 grey white
- 035 andes grey
- 328 white
- L9 027 natural beech laminate
- 028 natural maple laminate
- 035 andes grey
- 328 white
- L4 027 natural beech laminate
- 028 natural maple laminate
- 029 natural walnut laminate
- 031 grey white
- 035 andes grey
- 328 white
- 340 natural oak laminate
- 415 terra grey

**Shift+ Landscape**  
Soft seating.

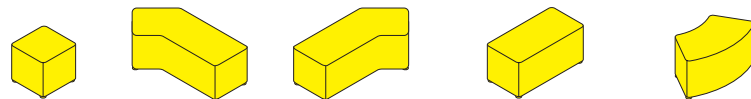

Model	09325	09326*	09327*	09328	09329
<b>Standard price</b>	<b>\$582.00</b>	<b>\$1,323.00</b>	<b>\$1,323.00</b>	<b>\$961.00</b>	<b>\$961.00</b>
dimensions (wxd)	20.8 x 20.8	55.45 x 28.55	55.45 x 28.55	41.55 x 20.8	43.35 x 20.8
seat height 11.85 (No. 2 violet)	0.00	0.00	0.00	0.00	0.00
seat height 15 (No. 4 red)	149.00	245.00	245.00	184.00	184.00
seat height 18.15 (No. 6 blue)	208.00	479.00	479.00	330.00	330.00
cover S40	0.00	0.00	0.00	0.00	0.00
cover S64	0.00	0.00	0.00	0.00	0.00
cover S82	0.00	0.00	0.00	0.00	0.00
plastic glides	0.00	0.00	0.00	0.00	0.00
felt glides	0.00	0.00	0.00	0.00	0.00
2-component glides	0.00	0.00	0.00	0.00	0.00

\*Side depth = 20.8", Exterior width before bend = 41.55"

**Material overview**

**Fabrics**

- S40 Stamskin Top
- S64 Mover
- S82 Evida

**Shift+ Landscape**  
Floor seating.

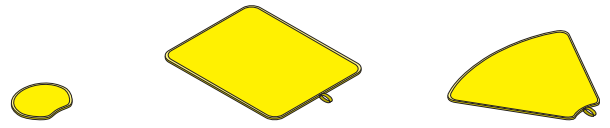

Model	09440	09441	09442
<b>Standard price</b>	<b>\$19.00</b>	<b>\$109.00</b>	<b>\$124.00</b>
dimensions (wxhxd) (Ø)	16.15 x 0.3 x 13.15	41.35 x 0.3 x 33.541.85	(9.45) x 0.3 x 34.65
with tent attachment	--	--	--
cover S40	--	--	--
cover S64	--	--	--
cover S82	--	--	--

**Material overview**

- Fabrics**  
 S40 Stamskin Top  
 S64 Mover  
 S82 Evida

**Shift+ Landscape  
Floor seating.**

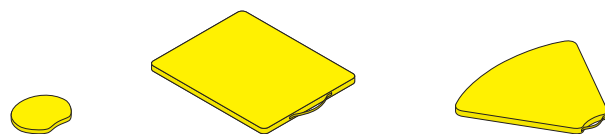

Model	09445	09446	09447
<b>Standard price</b>	<b>\$98.00</b>	<b>\$526.00</b>	<b>\$526.00</b>
dimensions (wxhxd) (Ø)	16.15 x 1.2 x 13.15	41.35 x 3.15 x 33.5	41.85 (9.45) x 3.15 x 34.35
with tent attachment	--	88.00	88.00
cover S40	0.00	0.00	0.00
cover S64	0.00	0.00	0.00
cover S82	0.00	0.00	0.00

**Material overview**

**Fabrics**

S40 Stamskin Top

S64 Mover

S82 Evida

**Shift+ Landscape Storage.**

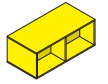

Model	45297	45298
<b>Standard price</b>	<b>\$804.00</b>	<b>\$716.00</b>
dimensions (wxhxd)	43.3 x 16.5 x 20.8	41.55 x 16.5 x 20.75
metal color back M1	0.00	0.00
laminate back panel L4	--	<b>-145.00</b>
body color LIGNOpal L4	0.00	0.00
plastic glides	0.00	0.00
felt glides	0.00	0.00
2-component glides	0.00	0.00

**Material overview**

**Metal Colors**

- M1 030 terra grey
- 032 light blue
- 033 light green
- 041 turquoise
- 045 broom yellow
- 059 arctic
- 063 anthracite
- 065 black (RAL 9011)
- 071 sapphire blue (RAL 5003)
- 084 oxblood
- 091 white

**Laminate Colors**

- L4 027 natural beech laminate
- 028 natural maple laminate
- 029 natural walnut laminate
- 031 grey white
- 035 andes grey
- 328 white
- 340 natural oak laminate
- 415 terra grey

**Shift+ Transfer Teach**  
**Mobile cabinet elements.**

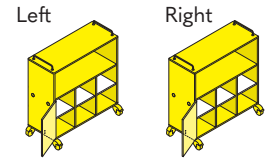

<b>Model</b>	<b>45319</b>
<b>Standard price</b>	<b>\$1,751.00</b>
dimensions (wxhxd)	41.55 x 43.4 x 16.75
metal color handle M1	0.00
metal color back M1	0.00
front color LIGNOpal L4	0.00
body color LIGNOpal L4	0.00
mobile spec. casters d= 4in adjustable feet	0.00 50.00
locking 18001 or as indicated	0.00
metal bow handle Ni- or Cr-plated	0.00
flush handle Ni-plated	30.00
with turning knob, lockable	0.00
1 pull-out	88.00
1 pull-out w. suspension frame	135.00
without magnet for linking	<b>-14.00</b>
without sliding handle	<b>-35.00</b>

**Material overview**

**Metal Colors**

M1	030	terra grey
	032	light blue
	033	light green
	041	turquoise
	045	broom yellow
	059	arctic
	063	anthracite
	065	black (RAL 9011)
	071	sapphire blue (RAL 5003)
	084	oxblood
	091	white

**Laminate Colors**

L4	027	natural beech laminate
	028	natural maple laminate
	029	natural walnut laminate
	031	grey white
	035	andes grey
	328	white
	340	natural oak laminate
	415	terra grey

**Shift+ Transfer**  
**Mobile shelving elements.**  
**Single-sided.**

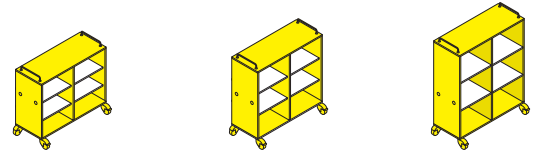

Model	45317	45318	45333
<b>Standard price</b>	<b>\$1,533.00</b>	<b>\$1,591.00</b>	<b>\$1,781.00</b>
dimensions (wxhxd)	41.55 x 36.05 x 16.75	41.55 x 43.4 x 16.75	41.55 x 50.8 x 16.75
metal color handle M1	0.00	0.00	0.00
metal color back M1	0.00	0.00	0.00
body color LIGNOpal L4	0.00	0.00	0.00
mobile spec. casters d = 4in	0.00	0.00	0.00
adjustable feet	50.00	50.00	50.00
without magnet for linking	<b>-14.00</b>	<b>-14.00</b>	<b>-14.00</b>
without sliding handle	<b>-35.00</b>	<b>-35.00</b>	<b>-35.00</b>
Column 1 adjustable shelf 1, same as body	<b>-17.00</b>	<b>-17.00</b>	<b>-17.00</b>
Column 1 adjustable shelf 2, same as body	0.00	0.00	0.00
Column 1 adjustable shelf 3, same as body	35.00	35.00	35.00
Column 1 with wardrobe hook, 4-way	--	<b>-17.00</b>	<b>-17.00</b>
Column 1 with wardrobe hook, 8-way	--	<b>-17.00</b>	<b>-17.00</b>
Column 1 holes for adjustable shelf inserts	<b>-49.00</b>	<b>-49.00</b>	<b>-49.00</b>
Column 2 adjustable shelf 1, same as body	<b>-17.00</b>	<b>-17.00</b>	<b>-17.00</b>
Column 2 adjustable shelf 2, same as body	0.00	0.00	0.00
Column 2 adjustable shelf 3, same as body	35.00	35.00	35.00
Column 2 with wardrobe hook, 4-way	--	<b>-17.00</b>	<b>-17.00</b>
Column 2 with wardrobe hook, 8-way	--	<b>-17.00</b>	<b>-17.00</b>
Column 2 holes for adjustable shelf inserts	<b>-49.00</b>	<b>-49.00</b>	<b>-49.00</b>

**Material overview**

**Metal Colors**

- M1 030 terra grey
- 032 light blue
- 033 light green
- 041 turquoise
- 045 broom yellow
- 059 arctic
- 063 anthracite
- 065 black (RAL 9011)
- 071 sapphire blue (RAL 5003)
- 084 oxblood
- 091 white

**Laminate Colors**

- L4 027 natural beech laminate
- 028 natural maple laminate
- 029 natural walnut laminate
- 031 grey white
- 035 andes grey
- 328 white
- 340 natural oak laminate
- 415 terra grey

**Shift+ Transfer**  
**Mobile shelving elements.**  
**Double-sided.**

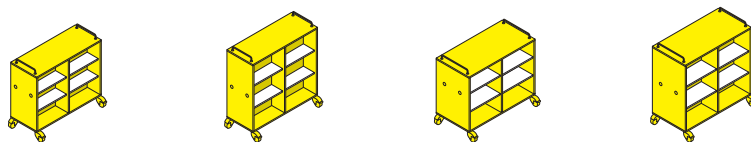

Model	45300	45301	45302	45303
<b>Standard price</b>	<b>\$1,620.00</b>	<b>\$1,649.00</b>	<b>\$1,693.00</b>	<b>\$1,751.00</b>
dimensions (wxhxd)	41.55 x 36.05 x 16.75	41.55 x 43.4 x 16.75	41.55 x 36.05 x 20.75	41.55 x 43.4 x 20.75
metal color handle M1	0.00	0.00	0.00	0.00
metal color back M1	0.00	0.00	0.00	0.00
LIGNOpal laminate back (match body)	<b>-128.00</b>	<b>-189.00</b>	<b>-128.00</b>	<b>-189.00</b>
body color LIGNOpal L4	0.00	0.00	0.00	0.00
mobile spec. casters d = 4in	0.00	0.00	0.00	0.00
adjustable feet	50.00	50.00	50.00	50.00
without magnet for linking	<b>-14.00</b>	<b>-14.00</b>	<b>-14.00</b>	<b>-14.00</b>
without sliding handle	<b>-35.00</b>	<b>-35.00</b>	<b>-35.00</b>	<b>-35.00</b>
adjustable shelf 4, same as body	<b>-72.00</b>	<b>-72.00</b>	<b>-72.00</b>	<b>-72.00</b>
adjustable shelf 8, same as body	0.00	0.00	0.00	0.00
adjustable shelf 12, same as body	135.00	135.00	135.00	135.00
adjustable shelf none	<b>-175.00</b>	<b>-175.00</b>	<b>-175.00</b>	<b>-175.00</b>

**Material overview**

**Metal Colors**

M1 030	terra grey
032	light blue
033	light green
041	turquoise
045	broom yellow
059	arctic
063	anthracite
065	black (RAL 9011)
071	sapphire blue (RAL 5003)
084	oxblood
091	white

**Laminate Colors**

L4 027	natural beech laminate
028	natural maple laminate
029	natural walnut laminate
031	grey white
035	andes grey
328	white
340	natural oak laminate
415	terra grey

**Shift+ Transfer**  
**Mobile shelving elements.**  
**Double-sided.**

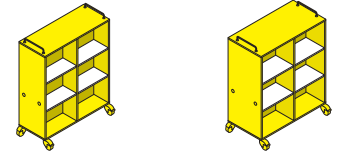

Model	45334	45335
<b>Standard price</b>	<b>\$1,883.00</b>	<b>\$1,999.00</b>
dimensions (wxhxd)	41.55 x 50.8 x 16.75	41.55 x 50.8 x 20.75
metal color handle M1	0.00	0.00
metal color back M1	0.00	0.00
LIGNOpal laminate back (match body)	<b>-189.00</b>	<b>-189.00</b>
body color LIGNOpal L4	0.00	0.00
mobile spec. casters d = 4in	0.00	0.00
adjustable feet	50.00	50.00
without magnet for linking	<b>-14.00</b>	<b>-14.00</b>
without sliding handle	<b>-35.00</b>	<b>-35.00</b>
adjustable shelf 4, same as body	<b>-78.00</b>	<b>-78.00</b>
adjustable shelf 8, same as body	0.00	0.00
adjustable shelf 12, same as body	111.00	111.00
adjustable shelf none	<b>-119.00</b>	<b>-119.00</b>

**Material overview**

**Metal Colors**

- M1 030 terra grey
- 032 light blue
- 033 light green
- 041 turquoise
- 045 broom yellow
- 059 arctic
- 063 anthracite
- 065 black (RAL 9011)
- 071 sapphire blue (RAL 5003)
- 084 oxblood
- 091 white

**Laminate Colors**

- L4 027 natural beech laminate
- 028 natural maple laminate
- 029 natural walnut laminate
- 031 grey white
- 035 andes grey
- 328 white
- 340 natural oak laminate
- 415 terra grey

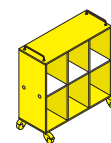

**Shift+ Transfer**  
**Mobile storage cabinets.**

<b>Model</b>	<b>45332</b>
<b>Standard price</b>	<b>\$2,131.00</b>
dimensions (wxhxd)	41.55 x 43.4 x 16.75
metal color handle M1	0.00
metal color back M1	0.00
body color LIGNOpal L4	0.00
mobile spec. casters d = 4in adjustable feet	0.00 50.00
without magnet for linking	<b>-14.00</b>
without sliding handle	<b>-35.00</b>
with rubber protector mats	149.00

**Material overview**

**Metal Colors**

M1	030	terra grey
	032	light blue
	033	light green
	041	turquoise
	045	broom yellow
	059	arctic
	063	anthracite
	065	black (RAL 9011)
	071	sapphire blue (RAL 5003)
	084	oxblood
	091	white

**Laminate Colors**

L4	027	natural beech laminate
	028	natural maple laminate
	029	natural walnut laminate
	031	grey white
	035	andes grey
	328	white
	340	natural oak laminate
	415	terra grey

**Shift+ Transfer Box**  
**Mobile storage cabinets.**  
**Single-sided.**

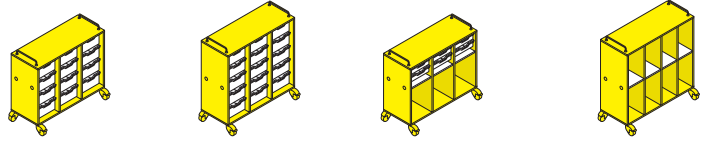

Model	45320	45325	45321	45330
<b>Standard price</b>	<b>\$1,839.00</b>	<b>\$1,999.00</b>	<b>\$1,329.00</b>	<b>\$1,431.00</b>
dimensions (wxhxd)	41.55 x 36.05 x 16.75	41.55 x 43.4 x 16.75	41.55 x 36.05 x 16.75	41.55 x 43.4 x 16.75
metal color handle M1	0.00	0.00	0.00	0.00
metal color back M1	0.00	0.00	0.00	0.00
body color LIGNOpal L4	0.00	0.00	0.00	0.00
mobile spec. casters d = 4in	0.00	0.00	0.00	0.00
adjustable feet	50.00	50.00	50.00	50.00
without magnet for linking	<b>-14.00</b>	<b>-14.00</b>	<b>-14.00</b>	<b>-14.00</b>
without sliding handle	<b>-35.00</b>	<b>-35.00</b>	<b>-35.00</b>	<b>-35.00</b>
with rubber protector mats	--	--	117.00	231.00
Column 1 adjustable shelf 2, same as body	<b>-8.00</b>	<b>-14.00</b>	--	--
Column 1 with wardrobe hook, 4-way	--	<b>-17.00</b>	--	--
Column 1 with wardrobe hook, 8-way	--	<b>-17.00</b>	--	--
Column 1 guide plates ONLY	0.00	0.00	0.00	--
Column 1 plastic boxes 3 in. high C3	132.00	155.00	35.00	--
Column 1 plastic boxes 3 in. high, with lids C3	202.00	243.00	59.00	--
Column 1 plastic boxes 6 in. high C3	88.00	105.00	24.00	--
Column 1 plastic boxes 6 in. high, with lids C3	123.00	149.00	36.00	--
Column 2 adjustable shelf 2, same as body	<b>-8.00</b>	<b>-14.00</b>	--	--
Column 2 with wardrobe hook, 4-way	--	<b>-17.00</b>	--	--
Column 2 with wardrobe hook, 8-way	--	<b>-17.00</b>	--	--
Column 2 guide plates ONLY	0.00	0.00	0.00	--
Column 2 plastic boxes 3 in. high C3	132.00	155.00	35.00	--
Column 2 plastic boxes 3 in. high, with lids C3	202.00	243.00	59.00	--
Column 2 plastic boxes 6 in. high C3	88.00	105.00	24.00	--
Column 2 plastic boxes 6 in. high, with lids C3	123.00	149.00	36.00	--
Column 3 adjustable shelf 2, same as body	<b>-8.00</b>	<b>-14.00</b>	--	--
Column 3 with wardrobe hook, 4-way	--	<b>-17.00</b>	--	--
Column 3 with wardrobe hook, 8-way	--	<b>-17.00</b>	--	--
Column 3 guide plates ONLY	0.00	0.00	0.00	--
Column 3 plastic boxes 3 in. high C3	132.00	155.00	35.00	--
Column 3 plastic boxes 3 in. high, with lids C3	202.00	243.00	59.00	--
Column 3 plastic boxes 6 in. high C3	88.00	105.00	24.00	--
Column 3 plastic boxes 6 in. high, with lids C3	123.00	149.00	36.00	--

**Material overview**

**Metal Colors**

M1 030 terra grey	071 sapphire blue (RAL 5003)
032 light blue	084 oxblood
033 light green	091 white
041 turquoise	
045 broom yellow	
059 arctic	
063 anthracite	
065 black (RAL 9011)	

**Laminate Colors**

L4 027 natural beech laminate
028 natural maple laminate
029 natural walnut laminate
031 grey white
035 andes grey
328 white
340 natural oak laminate
415 terra grey

**Plastic Colors**

C3 001 red
014 anthracite
016 translucent
030 dark red
031 dark blue
032 light blue
033 light green
038 turquoise
039 broom yellow

**Shift+ Transfer Box**  
**Mobile storage cabinets.**  
**Single-sided.**

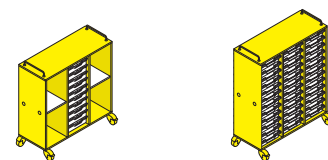

Model	45326	45339
Standard price	\$1,401.00	\$2,101.00
dimensions (wxhxd)	41.55 x 43.4 x 16.75	41.55 x 50.8 x 16.75
metal color handle M1	0.00	0.00
metal color back M1	0.00	0.00
body color LIGNOpal L4	0.00	0.00
mobile spec. casters d = 4in adjustable feet	0.00 50.00	0.00 50.00
without magnet for linking	<b>-14.00</b>	<b>-14.00</b>
without sliding handle	<b>-35.00</b>	<b>-35.00</b>
with rubber protector mats	149.00	--
Column 1 adjustable shelf 2, same as body	--	<b>-17.00</b>
Column 1 with wardrobe hook, 4-way	--	<b>-17.00</b>
Column 1 with wardrobe hook, 8-way	--	<b>-17.00</b>
Column 1 guide plates ONLY	--	0.00
Column 1 plastic boxes 3 in. high C3	--	196.00
Column 1 plastic boxes 3 in. high, with lids C3	--	296.00
Column 1 plastic boxes 6 in. high C3	--	143.00
Column 1 plastic boxes 6 in. high, with lids C3	--	193.00
Column 2 adjustable shelf 2, same as body	--	<b>-17.00</b>
Column 2 with wardrobe hook, 4-way	<b>-17.00</b>	<b>-17.00</b>
Column 2 with wardrobe hook, 8-way	<b>-17.00</b>	<b>-17.00</b>
Column 2 guide plates ONLY	0.00	0.00
Column 2 plastic boxes 3 in. high C3	155.00	196.00
Column 2 plastic boxes 3 in. high, with lids C3	243.00	296.00
Column 2 plastic boxes 6 in. high C3	105.00	143.00
Column 2 plastic boxes 6 in. high, with lids C3	149.00	193.00
Column 3 adjustable shelf 2, same as body	--	<b>-17.00</b>
Column 3 with wardrobe hook, 4-way	--	<b>-17.00</b>
Column 3 with wardrobe hook, 8-way	--	<b>-17.00</b>
Column 3 guide plates ONLY	--	0.00
Column 3 plastic boxes 3 in. high C3	--	196.00
Column 3 plastic boxes 3 in. high, with lids C3	--	296.00
Column 3 plastic boxes 6 in. high C3	--	143.00
Column 3 plastic boxes 6 in. high, with lids C3	--	193.00

**Material overview**

**Metal Colors**

M1	030 terra grey	071 sapphire blue (RAL 5003)
	032 light blue	084 oxblood
	033 light green	091 white
	041 turquoise	
	045 broom yellow	
	059 arctic	
	063 anthracite	
	065 black (RAL 9011)	

**Laminate Colors**

L4	027 natural beech laminate
	028 natural maple laminate
	029 natural walnut laminate
	031 grey white
	035 andes grey
	328 white
	340 natural oak laminate
	415 terra grey

**Plastic Colors**

C3	001 red
	014 anthracite
	016 translucent
	030 dark red
	031 dark blue
	032 light blue
	033 light green
	038 turquoise
	039 broom yellow

**Shift+ Transfer 60**  
**Mobile shelving elements.**  
**Single-sided.**

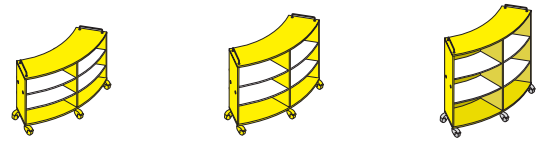

Model	45292	45293	45336
<b>Standard price</b>	<b>\$2,218.00</b>	<b>\$2,276.00</b>	<b>\$3,166.00</b>
dimensions (wxhxd)	60.1 x 36.05 x 16.75	60.1 x 43.4 x 16.75	60.1 x 50.8 x 16.75
metal color handle M1	0.00	0.00	0.00
metal color back M1	0.00	0.00	0.00
body color LIGNOpal L4	0.00	0.00	0.00
mobile spec. casters d = 4in	0.00	0.00	0.00
adjustable feet	50.00	50.00	50.00
without magnet for linking	<b>-14.00</b>	<b>-14.00</b>	<b>-14.00</b>
without sliding handle	<b>-35.00</b>	<b>-35.00</b>	<b>-35.00</b>
Column 1 adjustable shelf 1, same as body	<b>-58.00</b>	<b>-58.00</b>	<b>-78.00</b>
Column 1 adjustable shelf 2, same as body	0.00	0.00	0.00
Column 1 adjustable shelf 3, same as body	88.00	88.00	88.00
Column 1 with wardrobe hook, 4-way	--	<b>-17.00</b>	<b>-17.00</b>
Column 1 with wardrobe hook, 8-way	--	<b>-17.00</b>	<b>-17.00</b>
Column 1 holes for adjustable shelf inserts	<b>-148.00</b>	<b>-148.00</b>	<b>-99.00</b>
Column 2 adjustable shelf 1, same as body	<b>-58.00</b>	<b>-58.00</b>	<b>-78.00</b>
Column 2 adjustable shelf 2, same as body	0.00	0.00	0.00
Column 2 adjustable shelf 3, same as body	88.00	88.00	88.00
Column 2 with wardrobe hook, 4-way	--	<b>-17.00</b>	<b>-17.00</b>
Column 2 with wardrobe hook, 8-way	--	<b>-17.00</b>	<b>-17.00</b>
Column 2 holes for adjustable shelf inserts	<b>-148.00</b>	<b>-148.00</b>	<b>-99.00</b>

**Material overview**

**Metal Colors**

- M1 030 terra grey
- 032 light blue
- 033 light green
- 041 turquoise
- 045 broom yellow
- 059 arctic
- 063 anthracite
- 065 black (RAL 9011)
- 071 sapphire blue (RAL 5003)
- 084 oxblood
- 091 white

**Laminate Colors**

- L4 027 natural beech laminate
- 028 natural maple laminate
- 029 natural walnut laminate
- 031 grey white
- 035 andes grey
- 328 white
- 340 natural oak laminate
- 415 terra grey

**Shift+ Transfer 60**  
Mobile shelving elements.  
Double-sided.

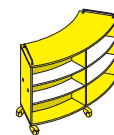
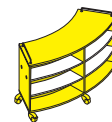

Model	45304	45305	45306	45307
<b>Standard price</b>	<b>\$2,743.00</b>	<b>\$2,801.00</b>	<b>\$3,006.00</b>	<b>\$3,035.00</b>
dimensions (wxhxd)	60.1 x 36.05 x 16.75	60.1 x 43.4 x 16.75	64.1 x 36.05 x 20.75	64.1 x 43.75 x 20.75
metal color handle M1	0.00	0.00	0.00	0.00
metal color back M1	0.00	0.00	0.00	0.00
body color LIGNOpal L4	0.00	0.00	0.00	0.00
mobile spec. casters d = 4in	0.00	0.00	0.00	0.00
adjustable feet	50.00	50.00	50.00	50.00
without magnet for linking	<b>-14.00</b>	<b>-14.00</b>	<b>-14.00</b>	<b>-14.00</b>
without sliding handle	<b>-35.00</b>	<b>-35.00</b>	<b>-35.00</b>	<b>-35.00</b>
adjustable shelf 4, same as body	<b>-274.00</b>	<b>-274.00</b>	<b>-274.00</b>	<b>-274.00</b>
adjustable shelf 8, same as body	0.00	0.00	0.00	0.00
adjustable shelf 12, same as body	406.00	406.00	406.00	406.00
adjustable shelf none	<b>-525.00</b>	<b>-525.00</b>	<b>-525.00</b>	<b>-525.00</b>

### Material overview

#### Metal Colors

M1	030	terra grey
	032	light blue
	033	light green
	041	turquoise
	045	broom yellow
	059	arctic
	063	anthracite
	065	black (RAL 9011)
	071	sapphire blue (RAL 5003)
	084	oxblood
	091	white

#### Laminate Colors

L4	027	natural beech laminate
	028	natural maple laminate
	029	natural walnut laminate
	031	grey white
	035	andes grey
	328	white
	340	natural oak laminate
	415	terra grey

**Shift+ Transfer 60**  
**Mobile shelving elements.**  
**Double-sided.**

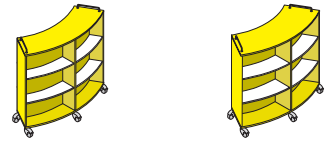

<b>Model</b>	<b>45337</b>	<b>45338</b>
<b>Standard price</b>	<b>\$3,720.00</b>	<b>\$3,808.00</b>
dimensions (wxhxd)	60.1 x 50.8 x 16.75	64.1 x 50.8 x 16.75
metal color handle M1	0.00	0.00
metal color back M1	0.00	0.00
body color LIGNOpal L4	0.00	0.00
mobile spec. casters d = 4in	0.00	0.00
adjustable feet	50.00	50.00
without magnet for linking	<b>-14.00</b>	<b>-14.00</b>
without sliding handle	<b>-35.00</b>	<b>-35.00</b>
adjustable shelf 4, same as body	<b>-250.00</b>	<b>-250.00</b>
adjustable shelf 8, same as body	0.00	0.00
adjustable shelf 12, same as body	403.00	435.00
adjustable shelf none	<b>-501.00</b>	<b>-501.00</b>

**Material overview**

**Metal Colors**

- M1 030 terra grey
- 032 light blue
- 033 light green
- 041 turquoise
- 045 broom yellow
- 059 arctic
- 063 anthracite
- 065 black (RAL 9011)
- 071 sapphire blue (RAL 5003)
- 084 oxblood
- 091 white

**Laminate Colors**

- L4 027 natural beech laminate
- 028 natural maple laminate
- 029 natural walnut laminate
- 031 grey white
- 035 andes grey
- 328 white
- 340 natural oak laminate
- 415 terra grey

**Shift+ Transfer Mobile Cabinet**  
Mobile cabinet elements with doors.

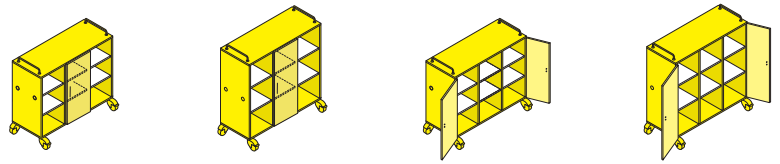

Model	45324	45329	45323	45328
<b>Standard price</b>	<b>\$1,708.00</b>	<b>\$1,810.00</b>	<b>\$1,912.00</b>	<b>\$2,014.00</b>
dimensions (wxhxd)	41.55 x 36.05 x 16.75	41.55 x 43.4 x 16.75	41.55 x 36.05 x 16.75	41.55 x 43.4 x 16.75
metal color handle M1	0.00	0.00	0.00	0.00
front color LIGNOpal L4	0.00	0.00	0.00	0.00
body color LIGNOpal L4	0.00	0.00	0.00	0.00
metal color back M1	0.00	0.00	0.00	0.00
mobile spec. casters d = 4in	0.00	0.00	0.00	0.00
adjustable feet	50.00	50.00	50.00	50.00
without magnet for linking	<b>-14.00</b>	<b>-14.00</b>	<b>-14.00</b>	<b>-14.00</b>
without sliding handle	<b>-35.00</b>	<b>-35.00</b>	<b>-35.00</b>	<b>-35.00</b>
locking 18001 or as indicated	0.00	0.00	0.00	0.00
locking plan site installat.	56.00	56.00	56.00	56.00
metal bow handle Ni- or Cr-plated	0.00	0.00	0.00	0.00
flush handle Ni-plated	35.00	35.00	68.00	68.00
with turning knob, lockable 18001 or as indicated	30.00	30.00	56.00	56.00
with turning knob, lockable locking plan site installat.	50.00	50.00	79.00	79.00
Column 1 adjustable shelf 2, same as body	0.00	0.00	0.00	0.00
Column 1 guide plates ONLY	18.00	18.00	18.00	18.00
Column 1 plastic boxes 3 in. high C3	155.00	193.00	155.00	193.00
Column 1 plastic boxes 3 in. high, with lids C3	225.00	281.00	225.00	281.00
Column 1 plastic boxes 6 in. high C3	105.00	132.00	105.00	132.00
Column 1 plastic boxes 6 in. high, with lids C3	140.00	176.00	140.00	176.00
Column 2 adjustable shelf 2, same as body	0.00	0.00	0.00	0.00
Column 2 guide plates ONLY	18.00	18.00	18.00	18.00
Column 2 plastic boxes 3 in. high C3	155.00	178.00	155.00	193.00
Column 2 plastic boxes 3 in. high, with lids C3	225.00	254.00	225.00	281.00
Column 2 plastic boxes 6 in. high C3	105.00	123.00	105.00	132.00
Column 2 plastic boxes 6 in. high, with lids C3	140.00	164.00	140.00	176.00
Column 3 adjustable shelf 2, same as body	0.00	0.00	0.00	0.00
Column 3 guide plates ONLY	18.00	18.00	18.00	18.00
Column 3 plastic boxes 3 in. high C3	155.00	178.00	155.00	193.00
Column 3 plastic boxes 3 in. high, with lids C3	225.00	254.00	225.00	281.00
Column 3 plastic boxes 6 in. high C3	105.00	123.00	105.00	132.00
Column 3 plastic boxes 6 in. high, with lids C3	140.00	164.00	140.00	176.00

**Material overview**

**Metal Colors**

M1	030 terra grey	063 anthracite
	032 light blue	065 black (RAL 9011)
	033 light green	071 sapphire blue (RAL 5003)
	041 turquoise	084 oxblood
	045 broom yellow	091 white
	059 arctic	

**Laminate Colors**

L4	027 natural beech laminate
	028 natural maple laminate
	029 natural walnut laminate
	031 grey white
	035 andes grey
	328 white
	340 natural oak laminate
	415 terra grey

**Plastic Colors**

C3	001 red
	014 anthracite
	016 translucent
	030 dark red
	031 dark blue
	032 light blue
	033 light green
	038 turquoise
	039 broom yellow

**Shift+ Transfer Mobile Cabinet**  
Mobile cabinet elements with doors.

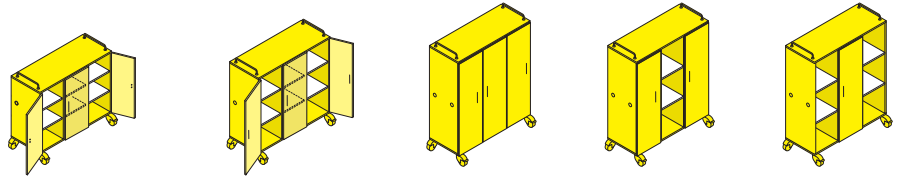

Model	45322	45327	45340	45341	45342
<b>Standard price</b>	<b>\$1,547.00</b>	<b>\$2,247.00</b>	<b>\$1,999.00</b>	<b>\$1,941.00</b>	<b>\$1,883.00</b>
dimensions (wxhxd)	41.55 x 36.05 x 16.75	41.55 x 43.4 x 16.75	41.55 x 50.8 x 16.75	41.55 x 50.8 x 16.75	41.55 x 50.8 x 16.75
metal color handle M1	0.00	0.00	0.00	0.00	0.00
front color LIGNOpal L4	0.00	0.00	0.00	0.00	0.00
body color LIGNOpal L4	0.00	0.00	0.00	0.00	0.00
metal color back M1	0.00	0.00	0.00	0.00	0.00
mobile spec. casters d= 4in adjustable feet	0.00 50.00	0.00 50.00	0.00 50.00	0.00 50.00	0.00 50.00
without magnet for linking	<b>-14.00</b>	<b>-14.00</b>	<b>-14.00</b>	<b>-14.00</b>	<b>-14.00</b>
without sliding handle	<b>-35.00</b>	<b>-35.00</b>	<b>-35.00</b>	<b>-35.00</b>	<b>-35.00</b>
locking 18001 or as indicated	0.00	0.00	0.00	0.00	0.00
locking plan site installat.	56.00	56.00	56.00	56.00	56.00
metal bow handle Ni- or Cr-plated	0.00	0.00	0.00	0.00	0.00
flush handle Ni-plated	97.00	97.00	30.00	18.00	12.00
with turning knob, lockable 18001 or as indicated	79.00	79.00	56.00	30.00	18.00
with turning knob, lockable locking plan site installat.	97.00	97.00	79.00	50.00	41.00
Column 1 adjustable shelf 2, same as body	0.00	0.00	0.00	0.00	0.00
Column 1 guide plates ONLY	18.00	18.00	0.00	0.00	0.00
Column 1 plastic boxes 3 in. high C3	155.00	193.00	219.00	219.00	219.00
Column 1 plastic boxes 3 in. high, with lids C3	225.00	281.00	319.00	319.00	319.00
Column 1 plastic boxes 6 in. high C3	105.00	132.00	149.00	149.00	149.00
Column 1 plastic boxes 6 in. high, with lids C3	140.00	176.00	199.00	199.00	199.00
Column 2 adjustable shelf 2, same as body	0.00	0.00	0.00	0.00	0.00
Column 2 guide plates ONLY	18.00	18.00	0.00	0.00	0.00
Column 2 plastic boxes 3 in. high C3	155.00	193.00	219.00	219.00	219.00
Column 2 plastic boxes 3 in. high, with lids C3	225.00	281.00	319.00	319.00	319.00
Column 2 plastic boxes 6 in. high C3	105.00	132.00	149.00	149.00	149.00
Column 2 plastic boxes 6 in. high, with lids C3	140.00	176.00	199.00	199.00	199.00
Column 3 adjustable shelf 2, same as body	0.00	0.00	0.00	0.00	0.00
Column 3 guide plates ONLY	18.00	18.00	0.00	0.00	0.00
Column 3 plastic boxes 3 in. high C3	155.00	193.00	219.00	219.00	219.00
Column 3 plastic boxes 3 in. high, with lids C3	225.00	281.00	319.00	319.00	319.00
Column 3 plastic boxes 6 in. high C3	105.00	132.00	149.00	149.00	149.00
Column 3 plastic boxes 6 in. high, with lids C3	140.00	176.00	199.00	199.00	199.00

**Material overview**

Metal Colors		Laminate Colors			Plastic Colors		
M1	030 terra grey	063 anthracite	L4	027 natural beech laminate	C3	001 red	
	032 light blue	065 black (RAL 9011)		028 natural maple laminate		014 anthracite	
	033 light green	071 sapphire blue (RAL 5003)		029 natural walnut laminate		016 translucent	
	041 turquoise	084 oxblood		031 grey white		030 dark red	
	045 broom yellow	091 white		035 andes grey		031 dark blue	
	059 arctic			328 white		032 light blue	
				340 natural oak laminate		033 light green	
				415 terra grey		038 turquoise	
						039 broom yellow	

**Shift+ Drum**  
Storage unit.



<b>Model</b>	<b>01486</b>
<b>Standard price</b>	<b>\$731.00</b>
dimensions (wxd) (Ø)	24.85 (25.05)
table height	15.7
top HPL solid core 13mm L4	0.00
base in black grey/white plastic	0.00
with tent pole	336.00
with pen holder	21.00

*A total of 30x model 9440 or 20x model 9445 can be stored inside the Drum table.*

**Material overview**

**Laminate Colors**

L4	027	natural beech laminate
	028	natural maple laminate
	029	natural walnut laminate
	031	grey white
	035	andes grey
	328	white
	340	natural oak laminate
	415	terra grey

**Leaf**  
Tent element for floor-level learning.

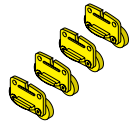
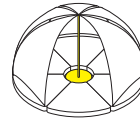
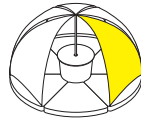

Model	09448	09449	09450	09444
<b>Standard price</b>	<b>\$328.00</b>	<b>\$658.00</b>	<b>\$109.00</b>	<b>\$45.00</b>
dimensions (wxd) (Ø)	approx. 89 x 37.8	67.75 x 18.15	42.55 x 15.75	2 x 0.05
cover S77	0.00	--	--	--

**Material overview**

**Fabrics**  
S77 Mirage E

Shift+ Drum and Leaf Kit  
Complete Drum and tent element  
system for floor-level learning.

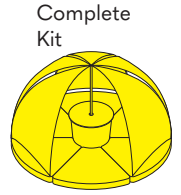
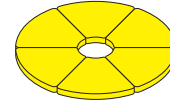
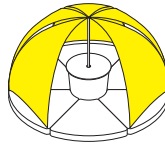
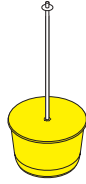

Model	01486*	09448 (x5)	09447 (x6)	Total List Kit
Standard price	\$1,067.00	\$1,640.00 (\$328.00 each)	\$3,684.00 (\$526.00 + \$88.00 each)	\$6,391.00

\*Base price + tent pole accessory.

**Material overview**

**Laminate Colors**

- L4 027 natural beech laminate
- 028 natural maple laminate
- 029 natural walnut laminate
- 031 grey white
- 035 andes grey
- 328 white
- 340 natural oak laminate
- 415 terra grey

**Shift+ Magnetic Board  
Accessories.**

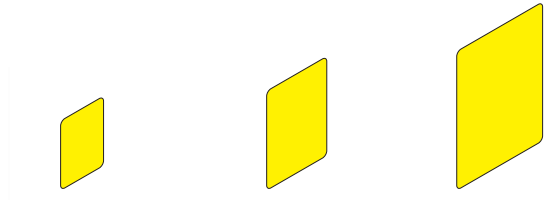

Model	45273	45274	45275
<b>Standard price</b>	<b>\$389.00</b>	<b>\$174.00</b>	<b>\$281.00</b>
dimensions (wxd)	A3 (11.7 x 16.55)	A2 (16.5 x 23.4)	A1 (23.4 x 33.1)
packaging unit	set of 10x	set of 2x	set of 2x

**Shift+ Up**  
**Table bench stand for presentations and floor-level learning.**

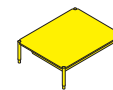

<b>Model</b>	<b>09451</b>	<b>09452</b>
<b>Standard price</b>	<b>\$629.00</b>	<b>\$512.00</b>
dimensions (wxd)	41.55 x 33.5	40.95 x 40.95
height	12.6	12.6
height of two stacked platforms	23.25	23.25
stacking capacity	--	--
metal color legs M1	0.00	0.00
reversible table top black (one side smooth, other side anti-slip)	0.00	0.00
guide rails only	94.00	47.00
plastic boxes 3 in. high C3	187.00	94.00
plastic boxes 3 in. high, with lid C3	199.00	106.00
plastic boxes 6 in. high C3	143.00	73.00
plastic boxes 6 in. high, with lid C3	155.00	85.00

*If specified with plastic boxes, model 09451 receives two Gratnell bins and model 09452 one Gratnell bin.*

**Material overview**

**Metal Colors**

- M1 030 terra grey
- 032 light blue
- 033 light green
- 041 turquoise
- 045 broom yellow
- 059 arctic
- 063 anthracite
- 065 black (RAL 9011)
- 071 sapphire blue (RAL 5003)
- 084 oxblood
- 091 white

**Plastic Colors**

- C3 001 red
- 014 anthracite
- 016 translucent
- 030 dark red
- 031 dark blue
- 032 light blue
- 033 light green
- 038 turquoise
- 039 broom yellow

**Laminate Colors**

- Lx 019 plain black

**Shift+ Up**  
**Table bench stand for presentations and floor-level learning.**



Model	09453	09454	09456	09457	09455
<b>Standard price</b>	<b>\$60.00</b>	<b>\$63.00</b>	<b>\$3,210.00</b>	<b>\$45.00</b>	<b>\$7.00</b>
dimensions (wxd)	30.55	38.6	68.75 x 32.7	--	--
height	9	9	36	--	--
height of two stacked platforms	--	--	--	--	--
stacking capacity	--	--	6 platforms	--	--
metal color legs M1	--	--	--	--	--
reversible table top black (one side smooth, other side anti-slip)	--	--	--	--	--
guide rails only	--	--	--	--	--
plastic boxes 3 in. high C3	--	--	--	--	--
plastic boxes 3 in. high, with lid C3	--	--	--	--	--
plastic boxes 6 in. high C3	--	--	--	--	--
plastic boxes 6 in. high, with lid C3	--	--	--	--	--

**Material overview**

**Metal Colors**

M1	030	terra grey
	032	light blue
	033	light green
	041	turquoise
	045	broom yellow
	059	arctic
	063	anthracite
	065	black (RAL 9011)
	071	sapphire blue (RAL 5003)
	084	oxblood
	091	white

**Plastic Colors**

C3	001	red
	014	anthracite
	016	translucent
	030	dark red
	031	dark blue
	032	light blue
	033	light green
	038	turquoise
	039	broom yellow

**Laminate Colors**

Lx	019	plain black
----	-----	-------------







**Storage**

**SpaceWalk**

**Double-sided mobile storage element with rails for Certwood bins.**

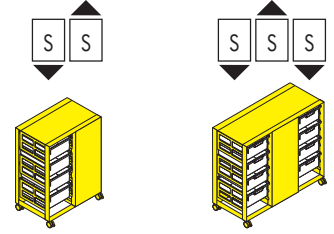

<b>Model</b>	<b>45413</b>	<b>45414</b>
<b>Standard price</b>	<b>\$1,635.00</b>	<b>\$2,218.00</b>
dimensions (wxhxd)	28.05 x 39.25 x 19.05	41.7 x 39.25 x 19.05
metal color frame M1	0.00	0.00
metal color top cover M1	0.00	0.00
with back panel M1 (required)	0.00	0.00
with side panels on both sides M1	161.00	161.00
with locking doors (includes side/back panels) M1	777.00	1074.00
locking 18001 or as specified	0.00	0.00
Column 1 receives QTY 9x 3" bins C9	0.00	0.00
Column 1 receives QTY 4x 6" bins, 1x 3" SINGLE bin C9	0.00	0.00
Column 1 receives QTY 3x 9" bins C9	0.00	0.00
Column 1 receives QTY 2x 12" bins, 1x 3" SINGLE bin C9	0.00	0.00
Column 1 receives bin kit 1 C9	0.00	0.00
Column 1 receives bin kit 2 C9	0.00	0.00
Column 1 receives bin kit 3 C9	0.00	0.00
Column 1 bins with lids	94.00	94.00
Column 2 receives QTY 9x 3" bins C9	0.00	0.00
Column 2 receives QTY 4x 6" bins, 1x 3" SINGLE bin C9	0.00	0.00
Column 2 receives QTY 3x 9" bins C9	0.00	0.00
Column 2 receives QTY 2x 12" bins, 1x 3" bin C9	0.00	0.00
Column 2 receives bin kit 1 C9	0.00	0.00
Column 2 receives bin kit 2 C9	0.00	0.00
Column 2 receives bin kit 3 C9	0.00	0.00
Column 2 bins with lids	94.00	94.00
Column 3 receives QTY 9x 3" bins C9	--	0.00
Column 3 receives QTY 4x 6" bins, 1x 3" bin C9	--	0.00
Column 3 receives QTY 3x 9" bins C9	--	0.00
Column 3 receives QTY 2x 12" bins, 1x 3" bin C9	--	0.00
Column 3 receives bin kit 1 C9	--	0.00
Column 3 receives bin kit 2 C9	--	0.00
Column 3 receives bin kit 3 C9	--	0.00
Column 3 bins with lids	--	94.00

**SpaceWalk****Double-sided mobile storage element with rails for Certwood bins.****Continued from previous page...***Certwood Bin Kit Configurations: Kit 1 (x3 single/3",x3 double/6"), Kit 2 (x2 single/3", x2 double/6", x1 triple/9"), and Kit 3 (x1 double/6", x1 triple/9", x1 quad/12")**Certwood bins are shipped separately from VSA warehouse.**Bin opening: "S" is standard bin width 12.25" and "B" is book bin width 9"***Material overview****Metal Colors**

M1	030	terra grey
	032	light blue
	033	light green
	041	turquoise
	045	broom yellow
	059	arctic
	063	anthracite
	065	black (RAL 9011)
	071	sapphire blue (RAL 5003)
	084	oxblood
	091	white

**Plastic Colors**

C9	300	clear
	301	tinted blue

**SpaceWalk**

Double-sided mobile storage element with rails for Certwood bins.

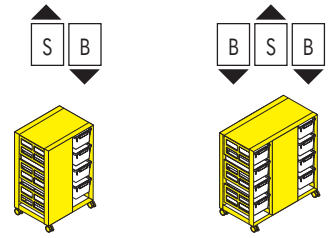

Model	45433	45434
Standard price	\$1,504.00	\$2,087.00
dimensions (wxhxd)	24.8 x 39.25 x 19.05	35.15 x 39.25 x 19.05
metal color frame M1	0.00	0.00
metal color top cover M1	0.00	0.00
with back panel M1 (required)	0.00	0.00
with side panels on both sides M1	161.00	161.00
with locking doors (includes side/back panels) M1	759.00	1042.00
locking 18001 or as specified	0.00	0.00
Column 1 receives QTY 9x 3" bins C9	0.00	--
Column 1 receives QTY 4x 6" bins, 1x 3" bin C9	0.00	--
Column 1 receives QTY 3x 9" bins C9	0.00	--
Column 1 receives QTY 2x 12" bins, 1x 3" bin C9	0.00	--
Column 1 receives bin kit 1 C9	0.00	--
Column 1 receives bin kit 2 C9	0.00	--
Column 1 receives bin kit 3 C9	0.00	--
Column 1 receives QTY 4x book boxes C9, no removable divider(s)	--	0.00
Column 1 receives QTY 4x book boxes C9, 1 removable divider(s)	--	15.00
Column 1 receives QTY 4x book boxes C9, 2 removable divider(s)	--	30.00
Column 1 receives QTY 4x book boxes C9, 3 removable divider(s)	--	44.00
Column 1 bins with lids	94.00	--
Column 2 receives QTY 9x 3" bins C9	--	0.00
Column 2 receives QTY 4x 6" bins, 1x 3" bin C9	--	0.00
Column 2 receives QTY 3x 9" bins C9	--	0.00
Column 2 receives QTY 2x 12" bins, 1x 3" bin C9	--	0.00
Column 2 receives bin kit 1 C9	--	0.00
Column 2 receives bin kit 2 C9	--	0.00
Column 2 receives bin kit 3 C9	--	0.00
Column 2 receives QTY 4x book boxes C9, no removable divider(s)	0.00	--
Column 2 receives QTY 4x boxes C9, 1 removable divider(s)	15.00	--
Column 2 receives QTY 4x book boxes C9, 2 removable divider(s)	30.00	--
Column 2 receives QTY 4x book boxes C9, 3 removable divider(s)	44.00	--
Column 2 bins with lids	--	94.00
Column 3 receives QTY 9x 3" bins C9	--	--
Column 3 receives QTY 4x 6" bins, 1x 3" bin C9	--	--
Column 3 receives QTY 3x 9" bins C9	--	--
Column 3 receives QTY 2x 12" bins, 1x 3" bin C9	--	--
Column 3 receives bin kit 1 C9	--	--
Column 3 receives bin kit 2 C9	--	--
Column 3 receives bin kit 3 C9	--	--
Column 3 receives QTY 4x book boxes C9, no removable divider(s)	--	0.00
Column 3 receives QTY 4x book boxes C9, 1 removable divider(s)	--	15.00
Column 3 receives QTY 4x book boxes C9, 2 removable divider(s)	--	30.00
Column 3 receives QTY 4x book boxes C9, 3 removable divider(s)	--	44.00
Column 3 bins with lids	--	--

**SpaceWalk****Double-sided mobile storage element with rails for Certwood bins.****Continued from previous page...***Certwood Bin Kit Configurations: Kit 1 (x3 single/3",x3 double/6"), Kit 2 (x2 single/3", x2 double/6", x1 triple/9"), and Kit 3 (x1 double/6", x1 triple/9", x1 quad/12")**Certwood bins are shipped separately from VSA warehouse.**Bin opening: "S" is standard bin width 12.25" and "B" is book bin width 9"***Material overview****Metal Colors**

M1	030	terra grey
	032	light blue
	033	light green
	041	turquoise
	045	broom yellow
	059	arctic
	063	anthracite
	065	black (RAL 9011)
	071	sapphire blue (RAL 5003)
	084	oxblood
	091	white

**Plastic Colors**

C9	300	clear
	301	tinted blue

**SpaceWalk**

Double-sided mobile storage element with rails for Certwood bins.

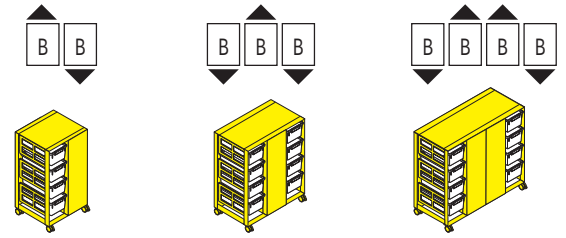

Model	45423	45424	45425
<b>Standard price</b>	<b>\$1,387.00</b>	<b>\$1,941.00</b>	<b>\$2,437.00</b>
dimensions (wxhxd)	21.5 x 39.25 x 19.05	31.9 x 39.25 x 19.05	42.25 x 39.25 x 19.05
metal color frame M1	0.00	0.00	0.00
metal color top cover M1	0.00	0.00	0.00
with back panel M1 (required)	0.00	0.00	0.00
with side panels on both sides M1	161.00	161.00	161.00
with locking doors (includes side/back panels) M1	745.00	1028.00	1328.00
locking 18001 or as specified	0.00	0.00	0.00
Column 1 receives QTY 4x book boxes C9, no removable divider(s)	0.00	0.00	0.00
Column 1 receives QTY 4x book boxes C9, 1 removable divider(s)	15.00	15.00	15.00
Column 1 receives QTY 4x book boxes C9, 2 removable divider(s)	30.00	30.00	30.00
Column 1 receives QTY 4x book boxes C9, 3 removable divider(s)	44.00	44.00	44.00
Column 2 receives QTY 4x book boxes C9, no removable divider(s)	0.00	0.00	0.00
Column 2 receives QTY 4x boxes C9, 1 removable divider(s)	15.00	15.00	15.00
Column 2 receives QTY 4x book boxes C9, 2 removable divider(s)	30.00	30.00	30.00
Column 2 receives QTY 4x book boxes C9, 3 removable divider(s)	44.00	44.00	44.00
Column 3 receives QTY 4x book boxes C9, no removable divider(s)	--	0.00	0.00
Column 3 receives QTY 4x book boxes C9, 1 removable divider(s)	--	15.00	15.00
Column 3 receives QTY 4x book boxes C9, 2 removable divider(s)	--	30.00	30.00
Column 3 receives QTY 4x book boxes C9, 3 removable divider(s)	--	44.00	44.00
Column 4 receives QTY 4x book boxes C9, no removable divider(s)	--	--	0.00
Column 4 receives QTY 4x book boxes C9, 1 removable divider(s)	--	--	15.00
Column 4 receives QTY 4x book boxes C9, 2 removable divider(s)	--	--	30.00
Column 4 receives QTY 4x book boxes C9, 3 removable divider(s)	--	--	44.00

*Certwood Bin Kit Configurations: Kit 1 (x3 single/3",x3 double/6"), Kit 2 (x2 single/3", x2 double/6", x1 triple/9"), and Kit 3 (x1 double/6", x1 triple/9", x1 quad/12")*

*Certwood bins are shipped separately from VSA warehouse.*

*Bin opening: "S" is standard bin width 12.25" and "B" is book bin width 9"*

**Material overview**

**Metal Colors**

- M1 030 terra grey
- 032 light blue
- 033 light green
- 041 turquoise
- 045 broom yellow
- 059 arctic
- 063 anthracite
- 065 black (RAL 9011)
- 071 sapphire blue (RAL 5003)
- 084 oxblood
- 091 white

**Plastic Colors**

- C9 300 clear
- 301 tinted blue

**SpaceWalk**  
Single-sided mobile storage element with rails for Certwood bins.

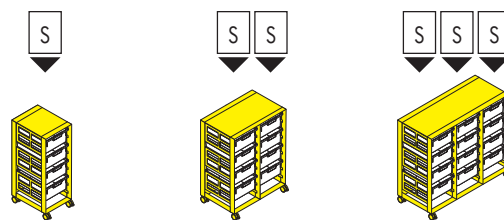

Model	45410	45411	45412
<b>Standard price</b>	<b>\$906.00</b>	<b>\$1,489.00</b>	<b>\$1,999.00</b>
dimensions (wxhxd)	14.45 x 39.25 x 19.05	28.05 x 39.25 x 19.05	41.7 x 39.25 x 19.05
metal color frame M1	0.00	0.00	0.00
metal color top cover M1	0.00	0.00	0.00
with back panel M1	73.00	143.00	222.00
with side panels on both sides M1	161.00	161.00	161.00
with locking doors (includes side/back panels) M1	535.00	920.00	1296.00
locking 18001 or as specified	0.00	0.00	0.00
Column 1 receives QTY 9x 3" bins C9	0.00	0.00	0.00
Column 1 receives QTY 4x 6" bins, 1x 3" bin C9	0.00	0.00	0.00
Column 1 receives QTY 3x 9" bins C9	0.00	0.00	0.00
Column 1 receives QTY 2x 12" bins, 1x 3" bin C9	0.00	0.00	0.00
Column 1 receives bin kit 1 C9	0.00	0.00	0.00
Column 1 receives bin kit 2 C9	0.00	0.00	0.00
Column 1 receives bin kit 3 C9	0.00	0.00	0.00
Column 1 bins with lids	94.00	94.00	94.00
Column 2 receives QTY 9x 3" bins C9	--	0.00	0.00
Column 2 receives QTY 4x 6" bins, 1x 3" bin C9	--	0.00	0.00
Column 2 receives QTY 3x 9" bins C9	--	0.00	0.00
Column 2 receives QTY 2x 12" bins, 1x 3" bin C9	--	0.00	0.00
Column 2 receives bin kit 1 C9	--	0.00	0.00
Column 2 receives bin kit 2 C9	--	0.00	0.00
Column 2 receives bin kit 3 C9	--	0.00	0.00
Column 2 bins with lids	--	94.00	94.00
Column 3 receives QTY 9x 3" bins C9	--	--	0.00
Column 3 receives QTY 4x 6" bins, 1x 3" bin C9	--	--	0.00
Column 3 receives QTY 3x 9" bins C9	--	--	0.00
Column 3 receives QTY 2x 12" bins, 1x 3" bin C9	--	--	0.00
Column 3 receives bin kit 1 C9	--	--	0.00
Column 3 receives bin kit 2 C9	--	--	0.00
Column 3 receives bin kit 3 C9	--	--	0.00
Column 3 bins with lids	--	--	94.00

Certwood Bin Kit Configurations: Kit 1 (x3 single/3", x3 double/6"), Kit 2 (x2 single/3", x2 double/6", x1 triple/9"), and Kit 3 (x1 double/6", x1 triple/9", x1 quad/12")

Certwood bins are shipped separately from VSA warehouse.

Bin opening: "S" is standard bin width 12.25" and "B" is book bin width 9"

**Material overview**

**Metal Colors**

M1 030 terra grey	063 anthracite
032 light blue	065 black (RAL 9011)
033 light green	071 sapphire blue (RAL 5003)
041 turquoise	084 oxblood
045 broom yellow	091 white
059 arctic	

**Plastic Colors**

C9 300 clear
301 tinted blue

**SpaceWalk**  
**Single-sided mobile storage element with rails for Certwood bins.**

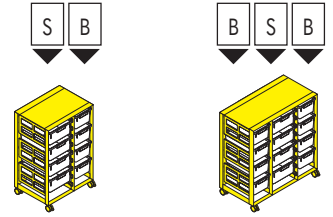

Model	45430	45431
Standard price	\$1,358.00	\$1,897.00
dimensions (wxhxd)	24.8 x 39.25 x 19.05	35.15 x 39.25 x 19.05
metal color frame M1	0.00	0.00
metal color top cover M1	0.00	0.00
with back panel M1	135.00	190.00
with side panels on both sides M1	161.00	161.00
with locking doors (includes side/back panels) M1	894.00	1232.00
locking 18001 or as specified	0.00	0.00
Column 1 receives QTY 9x 3" bins C9	0.00	--
Column 1 receives QTY 4x 6" bins, 1x 3" bin C9	0.00	--
Column 1 receives QTY 3x 9" bins C9	0.00	--
Column 1 receives QTY 2x 12" bins, 1x 3" bin C9	0.00	--
Column 1 receives bin kit 1 C9	0.00	--
Column 1 receives bin kit 2 C9	0.00	--
Column 1 receives bin kit 3 C9	0.00	--
Column 1 receives QTY 4x book boxes C9, no removable divider(s)	--	0.00
Column 1 receives QTY 4x book boxes C9, 1 removable divider(s)	--	15.00
Column 1 receives QTY 4x book boxes C9, 2 removable divider(s)	--	30.00
Column 1 receives QTY 4x book boxes C9, 3 removable divider(s)	--	44.00
Column 1 bins with lids	94.00	--
Column 2 receives QTY 9x 3" bins C9	--	0.00
Column 2 receives QTY 4x 6" bins, 1x 3" bin C9	--	0.00
Column 2 receives QTY 3x 9" bins C9	--	0.00
Column 2 receives QTY 2x 12" bins, 1x 3" bin C9	--	0.00
Column 2 receives bin kit 1 C9	--	0.00
Column 2 receives bin kit 2 C9	--	0.00
Column 2 receives bin kit 3 C9	--	0.00
Column 2 receives QTY 4x book boxes C9, no removable divider(s)	0.00	--
Column 2 receives QTY 4x boxes C9, 1 removable divider(s)	15.00	--
Column 2 receives QTY 4x book boxes C9, 2 removable divider(s)	30.00	--
Column 2 receives QTY 4x book boxes C9, 3 removable divider(s)	44.00	--
Column 2 bins with lids	--	94.00
Column 3 receives QTY 9x 3" bins C9	--	--
Column 3 receives QTY 4x 6" bins, 1x 3" bin C9	--	--
Column 3 receives QTY 3x 9" bins C9	--	--
Column 3 receives QTY 2x 12" bins, 1x 3" bin C9	--	--
Column 3 receives bin kit 1 C9	--	--
Column 3 receives bin kit 2 C9	--	--
Column 3 receives bin kit 3 C9	--	--
Column 3 receives QTY 4x book boxes C9, no removable divider(s)	--	0.00
Column 3 receives QTY 4x book boxes C9, 1 removable divider(s)	--	15.00
Column 3 receives QTY 4x book boxes C9, 2 removable divider(s)	--	30.00
Column 3 receives QTY 4x book boxes C9, 3 removable divider(s)	--	44.00
Column 3 bins with lids	--	--

**SpaceWalk****Single-sided mobile storage element with rails for Certwood bins.****Continued from previous page...***Certwood Bin Kit Configurations: Kit 1 (x3 single/3",x3 double/6"), Kit 2 (x2 single/3", x2 double/6", x1 triple/9"), and Kit 3 (x1 double/6", x1 triple/9", x1 quad/12")**Certwood bins are shipped separately from VSA warehouse.**Bin opening: "S" is standard bin width 12.25" and "B" is book bin width 9"***Material overview****Metal Colors**

M1	030	terra grey
	032	light blue
	033	light green
	041	turquoise
	045	broom yellow
	059	arctic
	063	anthracite
	065	black (RAL 9011)
	071	sapphire blue (RAL 5003)
	084	oxblood
	091	white

**Plastic Colors**

C9	300	clear
	301	tinted blue

**SpaceWalk**  
Single-sided mobile storage element with rails for Certwood bins.

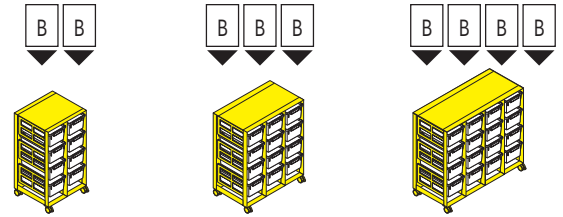

Model	45420	45421	45422
<b>Standard price</b>	<b>\$1,270.00</b>	<b>\$1,751.00</b>	<b>\$2,189.00</b>
dimensions (wxhxd)	21.5 x 39.25 x 19.05	31.9 x 39.25 x 19.05	42.25 x 39.25 x 19.05
metal color frame M1	0.00	0.00	0.00
metal color top cover M1	0.00	0.00	0.00
with back panel M1	126.00	190.00	251.00
with side panels on both sides M1	161.00	161.00	161.00
with locking doors (includes side/back panels) M1	871.00	1218.00	1579.00
locking 18001 or as specified	0.00	0.00	0.00
Column 1 receives QTY 4x book boxes C9, no removable divider(s)	0.00	0.00	0.00
Column 1 receives QTY 4x book boxes C9, 1 removable divider(s)	15.00	15.00	15.00
Column 1 receives QTY 4x book boxes C9, 2 removable divider(s)	30.00	30.00	30.00
Column 1 receives QTY 4x book boxes C9, 3 removable divider(s)	44.00	44.00	44.00
Column 2 receives QTY 4x book boxes C9, no removable divider(s)	0.00	0.00	0.00
Column 2 receives QTY 4x boxes C9, 1 removable divider(s)	15.00	15.00	15.00
Column 2 receives QTY 4x book boxes C9, 2 removable divider(s)	30.00	30.00	30.00
Column 2 receives QTY 4x book boxes C9, 3 removable divider(s)	44.00	44.00	44.00
Column 3 receives QTY 4x book boxes C9, no removable divider(s)	--	0.00	0.00
Column 3 receives QTY 4x book boxes C9, 1 removable divider(s)	--	15.00	15.00
Column 3 receives QTY 4x book boxes C9, 2 removable divider(s)	--	30.00	30.00
Column 3 receives QTY 4x book boxes C9, 3 removable divider(s)	--	44.00	44.00
Column 4 receives QTY 4x book boxes C9, no removable divider(s)	--	--	0.00
Column 4 receives QTY 4x book boxes C9, 1 removable divider(s)	--	--	15.00
Column 4 receives QTY 4x book boxes C9, 2 removable divider(s)	--	--	30.00
Column 4 receives QTY 4x book boxes C9, 3 removable divider(s)	--	--	44.00

*Certwood Bin Kit Configurations: Kit 1 (x3 single/3",x3 double/6"), Kit 2 (x2 single/3", x2 double/6", x1 triple/9"), and Kit 3 (x1 double/6", x1 triple/9", x1 quad/12")*

*Certwood bins are shipped separately from VSA warehouse.*

*Bin opening: "S" is standard bin width 12.25" and "B" is book bin width 9"*

**Material overview**

**Metal Colors**

- M1 030 terra grey
- 032 light blue
- 033 light green
- 041 turquoise
- 045 broom yellow
- 059 arctic
- 063 anthracite
- 065 black (RAL 9011)
- 071 sapphire blue (RAL 5003)
- 084 oxblood
- 091 white

**Plastic Colors**

- C9 300 clear
- 301 tinted blue

**SpaceStation**  
 Stationary, wall-mounted storage element with rails for Certwood bins.

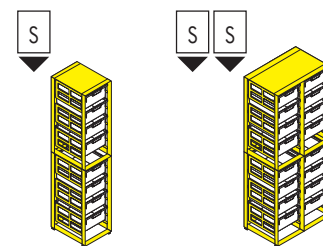

Model	45416	45417
<b>Standard price</b>	<b>\$1,664.00</b>	<b>\$2,874.00</b>
dimensions (wxhxd)	14.45 x 72.4 x 19.05	28.05 x 72.4 x 19.05
metal color frame M1	0.00	0.00
metal color top cover M1	0.00	0.00
with back panel M1	143.00	283.00
with side panels on left M1	161.00	161.00
with side panels on right M1	161.00	161.00
with side panels on both sides M1	321.00	321.00
with locking doors M1	616.00	1225.00
locking 18001 or as specified	0.00	0.00
Column 1 receives QTY 18x 3" bins C9	0.00	0.00
Column 1 receives QTY 8x 6" bins, 2x 3" bin C9	0.00	0.00
Column 1 receives QTY 6x 9" bins C9	0.00	0.00
Column 1 receives QTY 4x 12" bins, 2x 3" bin C9	0.00	0.00
Column 1 receives bin kit 1 C9	0.00	0.00
Column 1 receives bin kit 2 C9	0.00	0.00
Column 1 receives bin kit 3 C9	0.00	0.00
Column 1 bins with lids	187.00	187.00
Column 2 receives QTY 18x 3" bins C9	--	0.00
Column 2 receives QTY 8x 6" bins, 2x 3" bin C9	--	0.00
Column 2 receives QTY 6x 9" bins C9	--	0.00
Column 2 receives QTY 4x 12" bins, 2x 3" bin C9	--	0.00
Column 2 receives bin kit 1 C9	--	0.00
Column 2 receives bin kit 2 C9	--	0.00
Column 2 receives bin kit 3 C9	--	0.00
Column 2 bins with lids	--	187.00
with ganging hardware	0.00	0.00

*Certwood Bin Kit Configurations: Kit 1 (x6 single/3",x6 double/6"), Kit 2 (x4 single/3", x4 double/6", x2 triple/9"), and Kit 3 (x2 double/6", x2 triple/9", x2 quad/12")*

*Certwood bins are shipped separately from VSA warehouse.*

*Bin opening: "S" is standard bin width 12.25" and "B" is book bin width 9"*

**Material overview**

**Metal Colors**

- M1 030 terra grey
- 032 light blue
- 033 light green
- 041 turquoise
- 045 broom yellow
- 059 arctic
- 063 anthracite
- 065 black (RAL 9011)
- 071 sapphire blue (RAL 5003)
- 084 oxblood
- 091 white

**Plastic Colors**

- C9 300 clear
- 301 tinted blue

**SpaceStation**

Stationary, wall-mounted storage element with rails for Certwood bins.

<b>Model</b>	<b>45436</b>
<b>Standard price</b>	<b>\$2,758.00</b>
dimensions (wxhxd)	24.8 x 72.4 x 19.05
metal color frame M1	0.00
metal color top cover M1	0.00
with back panel M1	269.00
with side panels on left M1	161.00
with side panels on right M1	161.00
with side panels on both sides M1	321.00
with locking doors M1	1193.00
locking 18001 or as specified	0.00
Column 1 receives QTY 18x 3" bins C9	0.00
Column 1 receives QTY 8x 6" bins, 2x 3" bin C9	0.00
Column 1 receives QTY 6x 9" bins C9	0.00
Column 1 receives QTY 4x 12" bins, 2x 3" bin C9	0.00
Column 1 receives bin kit 1 C9	0.00
Column 1 receives bin kit 2 C9	0.00
Column 1 receives bin kit 3 C9	0.00
Column 1 bins with lids	187.00
Column 2 receives QTY 8x book boxes C9, no removable divider(s)	0.00
Column 2 receives QTY 8x book boxes C9, 1 removable divider(s)	30.00
Column 2 receives QTY 8x book boxes C9, 2 removable divider(s)	59.00
Column 2 receives QTY 8x book boxes C9, 3 removable divider(s)	88.00
with ganging hardware	0.00

*Certwood Bin Kit Configurations: Kit 1 (x6 single/3", x6 double/6"), Kit 2 (x4 single/3", x4 double/6", x2 triple/9"), and Kit 3 (x2 double/6", x2 triple/9", x2 quad/12")*

*Certwood bins are shipped separately from VSA warehouse.*

*Bin opening: "S" is standard bin width 12.25" and "B" is book bin width 9"*

**Material overview****Metal Colors**

M1	030	terra grey
	032	light blue
	033	light green
	041	turquoise
	045	broom yellow
	059	arctic
	063	anthracite
	065	black (RAL 9011)
	071	sapphire blue (RAL 5003)
	084	oxblood
	091	white

**Plastic Colors**

C9	300	clear
	301	tinted blue

**SpaceStation**  
 Stationary, wall-mounted storage element with rails for Certwood bins.

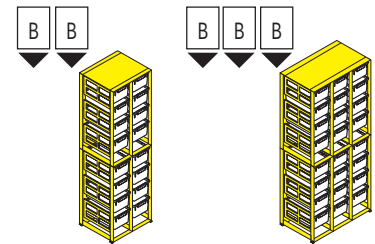

Model	45426	45427
<b>Standard price</b>	<b>\$2,349.00</b>	<b>\$3,254.00</b>
dimensions (wxhxd)	21.5 x 72.4 x 19.05	31.9 x 72.4 x 19.05
metal color frame M1	0.00	0.00
metal color top cover M1	0.00	0.00
with back panel M1	251.00	380.00
with side panels on left M1	161.00	161.00
with side panels on right M1	161.00	161.00
with side panels on both sides M1	321.00	321.00
with locking doors M1	1167.00	1745.00
locking 18001 or as specified	0.00	0.00
Column 1 receives QTY 8x book boxes C9, no removable divider(s)	0.00	0.00
Column 1 receives QTY 8x book boxes C9, 1 removable divider(s)	30.00	30.00
Column 1 receives QTY 8x book boxes C9, 2 removable divider(s)	59.00	59.00
Column 1 receives QTY 8x book boxes C9, 3 removable divider(s)	88.00	88.00
Column 2 receives QTY 8x book boxes C9, no removable divider(s)	0.00	0.00
Column 2 receives QTY 8x book boxes C9, 1 removable divider(s)	30.00	30.00
Column 2 receives QTY 8x book boxes C9, 2 removable divider(s)	59.00	59.00
Column 2 receives QTY 8x book boxes C9, 3 removable divider(s)	88.00	88.00
Column 3 receives QTY 8x book boxes C9, no removable divider(s)	--	0.00
Column 3 receives QTY 8x book boxes C9, 1 removable divider(s)	--	30.00
Column 3 receives QTY 8x book boxes C9, 2 removable divider(s)	--	59.00
Column 3 receives QTY 8x book boxes C9, 3 removable divider(s)	--	88.00
with ganging hardware	0.00	0.00

*Certwood Bin Kit Configurations: Kit 1 (x6 single/3", x6 double/6"), Kit 2 (x4 single/3", x4 double/6", x2 triple/9"), and Kit 3 (x2 double/6", x2 triple/9", x2 quad/12")*

*Certwood bins are shipped separately from VSA warehouse.*

*Bin opening: "S" is standard bin width 12.25" and "B" is book bin width 9"*

**Material overview**





**Metal Colors**

- M1 030 terra grey
- 032 light blue
- 033 light green
- 041 turquoise
- 045 broom yellow
- 059 arctic
- 063 anthracite
- 065 black (RAL 9011)
- 071 sapphire blue (RAL 5003)
- 084 oxblood
- 091 white

**Plastic Colors**









- C9 300 clear
- 301 tinted blue

**SpaceCraft**  
**Plastic Certwood bins for the SpaceStation and SpaceWalk storage elements.**

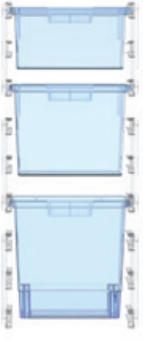
	single	double	triple	quad
				
<b>Model</b>	<b>45490</b>	<b>45491</b>	<b>45492</b>	<b>45494</b>
<b>Base price</b>	<b>\$25.00</b>	<b>\$36.00</b>	<b>\$48.00</b>	<b>\$57.00</b>
dimensions (wxhxd)	12.25 x 3 x 16.75	12.25 x 6 x 16.75	12.25 x 9 x 16.75	12.25 x 12 x 16.75
plastic color C9	0.00	0.00	0.00	0.00
color	--	--	--	--

**BIN KIT CONFIGURATIONS**

Standard bins available in 7 combinations per one vertical row, bookbin available in 1 combination per one vertical row:

							
Kit 1 (3) single/3 (3) double/6	Kit 2 (2) single/3 (2) double/6 (1) triple/9	Kit 3 (1) double/6 (1) triple/9 (1) quad/12	(9) single/3	(1) single/3 (4) double/6	(3) triple/9	(1) single/3 (2) quad/12	Bookbin Kit (4) bookbin/6

**Material overview**

**Plastic Colors**

- C9 300 clear
- 301 tinted blue

**SpaceCraft**  
**Plastic Certwood bins for the SpaceStation**  
**and SpaceWalk storage elements.**

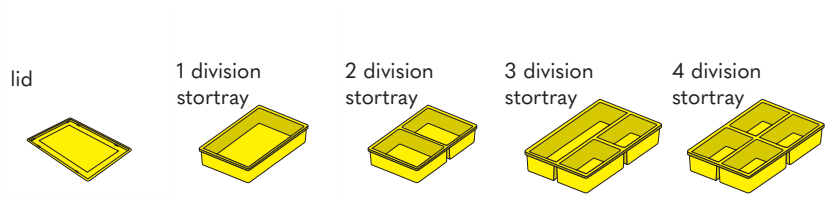

Model	45496	45489	45485	45487	45488
<b>Base price</b>	<b>\$10.00</b>	<b>\$10.00</b>	<b>\$10.00</b>	<b>\$10.00</b>	<b>\$10.00</b>
dimensions (wxhxd)	12.25 x 16.75	11.25 x 7.75 x 2.5	11.25 x 7.75 x 2.5	11.25 x 7.75 x 2.5	11.25 x 7.75 x 2.5
plastic color C9	--	--	--	--	--
color	clear	light grey	light grey	light grey	light grey

**Material overview**

**Plastic Colors**

- C9 300 clear
- 301 tinted blue

**SpaceCraft**  
**Plastic Certwood bins for the SpaceStation and SpaceWalk storage elements.**

bookbin

book bin divider



Model	45493	45495
<b>Base price</b>	<b>\$36.00</b>	<b>\$4.00</b>
dimensions (wxhxd)	9 x 6 x 16.75	n/a
plastic color C9	0.00	--
color	--	clear

**Material overview**

**Plastic Colors**

- C9 300 clear
- 301 tinted blue

**SpaceWalk-G**  
Mobile storage element with rails for Gratnells boxes.

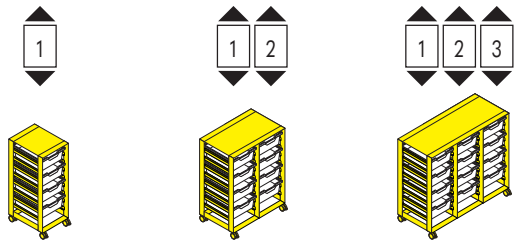

Model	45400	45401	45402
Standard price	\$906.00	\$1,489.00	\$1,999.00
dimensions (wxhxd)	14.45 x 39.25 x 19.05	28.05 x 39.25 x 19.05	41.7 x 39.25 x 19.05
metal color frame M1	0.00	0.00	0.00
metal color top cover M1	0.00	0.00	0.00
with back panel M1	65.00	126.00	173.00
with side panels on both sides M1	161.00	161.00	161.00
with locking doors (includes side/back panels) M1	301.00	616.00	913.00
locking 18001 or as specified	0.00	0.00	0.00
Column 1 guide rails ONLY	0.00	0.00	0.00
Column 1 receives 9x 3" bins C3	0.00	0.00	0.00
Column 1 receives 4x 6" bins C3	0.00	0.00	0.00
Column 1 bins with lids	38.00	38.00	38.00
Column 2 guide rails ONLY	--	0.00	0.00
Column 2 receives 9x 3" bins C3	--	0.00	0.00
Column 2 receives 4x 6" bins C3	--	0.00	0.00
Column 2 bins with lids	--	38.00	38.00
Column 3 guide rails ONLY	--	--	0.00
Column 3 receives 9x 3" bins C3	--	--	0.00
Column 3 receives 4x 6" bins C3	--	--	0.00
Column 3 bins with lids	--	--	38.00

**Material overview**

**Metal Colors**

- M1 030 terra grey
- 032 light blue
- 033 light green
- 041 turquoise
- 045 broom yellow
- 059 arctic
- 063 anthracite
- 065 black (RAL 9011)
- 071 sapphire blue (RAL 5003)
- 084 oxblood
- 091 white

**Plastic Colors**

- C3 001 red
- 014 anthracite
- 016 translucent
- 030 dark red
- 031 dark blue
- 032 light blue
- 033 light green
- 038 turquoise
- 039 broom yellow

**SpaceWalk-G**  
 Mobile storage element with rails for Gratnells boxes.

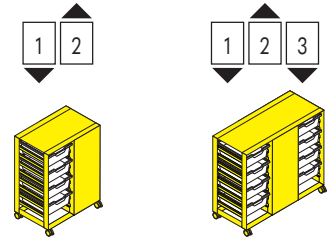

Model	45403	45404
Standard price	\$1,489.00	\$1,999.00
dimensions (wxhxd)	28.05 x 39.25 x 19.05	41.7 x 39.25 x 19.05
metal color frame M1	0.00	0.00
metal color top cover M1	0.00	0.00
with back panel M1 (required)	0.00	0.00
with side panels on both sides M1	161.00	161.00
with locking doors (includes side/back panels) M1	777.00	1074.00
locking 18001 or as specified	0.00	0.00
Column 1 guide rails ONLY	0.00	0.00
Column 1 receives 9x 3" bins C3	0.00	0.00
Column 1 receives 4x 6" bins C3	0.00	0.00
Column 1 bins with lids	38.00	38.00
Column 2 guide rails ONLY	0.00	0.00
Column 2 receives 9x 3" bins C3	0.00	0.00
Column 2 receives 4x 6" bins C3	0.00	0.00
Column 2 bins with lids	38.00	38.00
Column 3 guide rails ONLY	--	0.00
Column 3 receives 9x 3" bins C3	--	0.00
Column 3 receives 4x 6" bins C3	--	0.00
Column 3 bins with lids	--	38.00

**Material overview**

**Metal Colors**

M1	030	terra grey
	032	light blue
	033	light green
	041	turquoise
	045	broom yellow
	059	arctic
	063	anthracite
	065	black (RAL 9011)
	071	sapphire blue (RAL 5003)
	084	oxblood
	091	white

**Plastic Colors**

C3	001	red
	014	anthracite
	016	translucent
	030	dark red
	031	dark blue
	032	light blue
	033	light green
	038	turquoise
	039	broom yellow

**SpaceStation-G**  
 Stationary, wall-mounted storage element with rails for Grattells boxes.

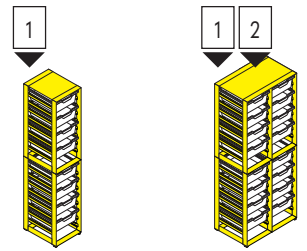

Model	45406	45407
<b>Standard price</b>	<b>\$1,664.00</b>	<b>\$2,874.00</b>
dimensions (wxhxd)	14.45 x 72.4 x 19.05	28.05 x 72.4 x 19.05
metal color frame M1	0.00	0.00
metal color top cover M1	0.00	0.00
with back panel M1	143.00	283.00
with side panels on left M1	161.00	161.00
with side panels on right M1	161.00	161.00
with side panels on both sides M1	321.00	321.00
with locking doors M1	616.00	1225.00
locking 18001 or as specified	0.00	0.00
Column 1 guide rails ONLY	0.00	0.00
Column 1 receives 18x 3" bins C3	0.00	0.00
Column 1 receives 8x 6" bins C3	0.00	0.00
Column 1 bins with lids	76.00	76.00
Column 2 guide rails ONLY	--	0.00
Column 2 receives 18x 3" bins C3	--	0.00
Column 2 receives 8x 6" bins C3	--	0.00
Column 2 bins with lids	--	76.00
with ganging hardware	0.00	0.00

**Material overview**

**Metal Colors**

M1	030	terra grey
	032	light blue
	033	light green
	041	turquoise
	045	broom yellow
	059	arctic
	063	anthracite
	065	black (RAL 9011)
	071	sapphire blue (RAL 5003)
	084	oxblood
	091	white

**Plastic Colors**

C3	001	red
	014	anthracite
	016	translucent
	030	dark red
	031	dark blue
	032	light blue
	033	light green
	038	turquoise
	039	broom yellow

**Space Craft**  
**Plastic Gratonell bins for the SpaceStation and SpaceWalk storage elements.**

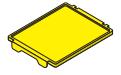
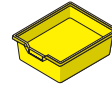
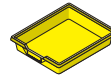

Model	48565	48566	48568
<b>Base price</b>	<b>\$28.00</b>	<b>\$34.00</b>	<b>\$7.00</b>
dimensions (wxhxd)	12.3 x 3 x 14.85	12.3 x 5.95 x 14.85	12.3 x 14.8
plastic color C3	0.00	0.00	--
color	--	--	translucent

**Material overview**

**Plastic Colors**

- C3 001 red
- 014 anthracite
- 016 translucent
- 030 dark red
- 031 dark blue
- 032 light blue
- 033 light green
- 038 turquoise
- 039 broom yellow

**Series 600**  
Cupboard for paper and handicraft.

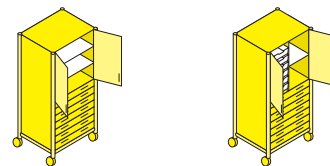

Model	45246	45243
<b>Standard price</b>	<b>\$3,458.00</b>	<b>\$3,662.00</b>
dimensions (wxhxd) <sup>1)</sup>	33.5 x 62.45 x 25.6	33.5 x 62.45 x 25.6
metal color frame M1	0.00	0.00
metal color frame M060	1310.00	1310.00
Front LIGNOpal color laminate 017 astral silver	0.00	0.00
body color steel M1	0.00	0.00
unified locking 18001	68.00	68.00
locking as indicated	68.00	68.00
locking plan, site installat.	56.00	56.00
metal bow handle, chrome-plated	0.00	0.00
adj. foot 3 + with KU glides	56.00	56.00
adj. foot 3.95 + KU-gl. h+1.5	68.00	68.00
design casters d = 3	0.00	0.00
design casters d = 3.95, h+1.5	111.00	111.00
technical casters d = 3, h+0.6	50.00	50.00
technical casters d = 3.95, h+1.5	18.00	18.00
shelves LIGNOpal	0.00	0.00
one or two shelves	0.00	--
shelf color laminate 017 astral silver	0.00	0.00

<sup>1)</sup>Standard height includes 3" design casters

**Material overview**

**Metal Colors**

M1 030 terra grey  
 032 light blue  
 033 light green  
 041 turquoise  
 045 broom yellow  
 059 arctic  
 063 anthracite  
 065 black (RAL 9011)  
 071 sapphire blue (RAL 5003)  
 084 oxblood  
 091 white





**Laminate Colors**

Lx 017 astral silver

Mx 060 chrome-plated

**Series 600 Bins**  
Cupboard for paper and handicraft.

Drawer Divider

				
<b>Model</b>	<b>09196*</b>	<b>09197*</b>	<b>09198*</b>	<b>45247</b>
<b>Standard price</b>	<b>\$34.00</b>	<b>\$51.00</b>	<b>\$69.00</b>	<b>\$89.00</b>
dimensions (wxhxd) <sup>1)</sup>	12.3 x 3 x 16.85	12.3 x 5.95 x 16.85	12.3 x 11.85 x 16.85	--
metal color frame M1	--	--	--	--
metal color frame M060	--	--	--	--
Front LIGNOpal color laminate 017 astral silver	--	--	--	--
body color steel M1	--	--	--	--
unified locking 18001	--	--	--	--
locking as indicated	--	--	--	--
locking plan, site installat.	--	--	--	--
metal bow handle, chrome-plated	--	--	--	--
adj. foot 3 + with KU glides	--	--	--	--
adj. foot 3.95 + KU-gl. h+1.5	--	--	--	--
design casters d = 3	--	--	--	--
design casters d = 3.95, h+1.5	--	--	--	--
technical casters d = 3, h+0.6	--	--	--	--
technical casters d = 3.95, h+1.5	--	--	--	--
shelves LIGNOpal	--	--	--	--
shelf color laminate 017 astral silver	--	--	--	--

\* Colors: 09196 (red, blue, green, yellow), 09197 (red, blue green, yellow), 09198 (green)

**Prices for plastic bins only valid if ordered with a storage unit.**

**Material overview**

**Metal Colors**

- M1 030 terra grey
- 032 light blue
- 033 light green
- 041 turquoise
- 045 broom yellow
- 059 arctic
- 063 anthracite
- 065 black (RAL 9011)
- 071 sapphire blue (RAL 5003)
- 084 oxblood
- 091 white

**Laminate Colors**

- Lx 017 astral silver

- Mx 060 chrome-plated

**Series 600**  
Clothes, shoes and satchel cupboard.

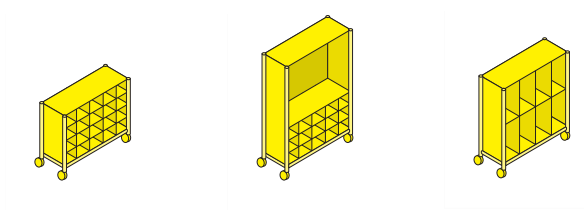

Model	45232	45233	45234
<b>Standard price</b>	<b>\$1,956.00</b>	<b>\$2,393.00</b>	<b>\$1,999.00</b>
dimensions (wxhxd) <sup>1)</sup>	49.25 x 34.9 x 18.9	49.25 x 62.45 x 18.9	49.25 x 48.7 x 18.9
metal color frame M1	0.00	0.00	0.00
body color steel M1	0.00	0.00	0.00
adj. foot 3 + with KU glides	56.00	56.00	56.00
adj. foot 3.95 + KU-gl. h+1.5	68.00	68.00	68.00
design casters d = 3	0.00	0.00	0.00
design casters d = 3.95, h+1.5	111.00	111.00	111.00
technical casters d = 3, h+0.6	50.00	50.00	50.00
technical casters d = 3.95, h+1.5	18.00	18.00	18.00
shelves LIGNOpal	0.00	0.00	0.00
with rubber protector mats	--	--	272.00

<sup>1)</sup>Standard height includes 3" design casters

**Material overview**

**Metal Colors**

M1	030	terra grey
	032	light blue
	033	light green
	041	turquoise
	045	broom yellow
	059	arctic
	063	anthracite
	065	black (RAL 9011)
	071	sapphire blue (RAL 5003)
	084	oxblood
	091	white

**Series 600**  
Clothes, shoes and satchel cupboard.

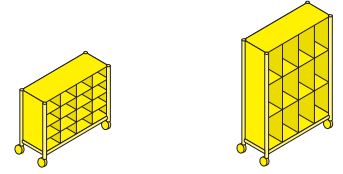

Model	45236	45237
<b>Standard price</b>	<b>\$1,839.00</b>	<b>\$2,437.00</b>
dimensions (wxhxd) <sup>1)</sup>	49.25 x 34.9 x 18.9	49.25 x 62.45 x 18.9
metal color frame M1	0.00	0.00
body color steel M1	0.00	0.00
adj. foot 3 + with KU glides	56.00	56.00
adj. foot 3.95 + KU-gl. h+1.5	68.00	68.00
design casters d = 3	0.00	0.00
design casters d = 3.95, h+1.5	111.00	111.00
technical casters d = 3, h+0.6	50.00	50.00
technical casters d = 3.95, h+1.5	18.00	18.00
shelves LIGNOpal	0.00	0.00
with rubber protector mats	--	403.00

**Material overview**

**Metal Colors**

- M1 030 terra grey
- 032 light blue
- 033 light green
- 041 turquoise
- 045 broom yellow
- 059 arctic
- 063 anthracite
- 065 black (RAL 9011)
- 071 sapphire blue (RAL 5003)
- 084 oxblood
- 091 white

**Series 600**  
**Storage module.**

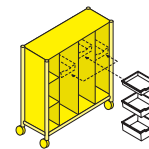
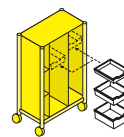
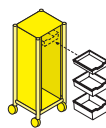

Model	45244**	45242**	45245**
<b>Standard price</b>	<b>\$1,329.00</b>	<b>\$1,737.00</b>	<b>\$2,087.00</b>
dimensions (wxhxd) <sup>1)</sup>	18.9 x 48.7 x 18.9	33.5 x 48.7 x 18.9	49.25 x 48.7 x 18.9
metal color frame M1	0.00	0.00	0.00
metal color frame M060	569.00	1310.00	1310.00
body color steel M1	0.00	0.00	0.00
adj. foot 3 + with KU glides	56.00	56.00	56.00
adj. foot 3.95 + KU-gl. h+1.5	68.00	68.00	68.00
design casters d = 3	0.00	0.00	0.00
design casters d = 3.95, h+1.5	111.00	111.00	111.00
technical casters d = 3, h+0.6	50.00	50.00	50.00
technical casters d = 3.95, h+1.5	18.00	18.00	18.00
shelves LIGNOpal color 017 astral silver	0.00	0.00	0.00

<sup>1)</sup>Standard height includes 3" design casters

\* Colors: 09196 (red, blue, green, yellow), 09197 (red, blue green, yellow), 09198 (green)

\*\* Bins ordered separately

1x Vertical Column

12x 3" height bins

6x 6" height bins

3x 12" height bins

**Material overview**

**Metal Colors**



- M1 030 terra grey
- 032 light blue
- 033 light green
- 041 turquoise
- 045 broom yellow
- 059 arctic
- 063 anthracite
- 065 black (RAL 9011)
- 071 sapphire blue (RAL 5003)
- 084 oxblood
- 091 white

**Laminate Colors**

- Lx 017 astral silver

- Mx 060 chrome-plated

**Series 600**  
Storage module.

			
<b>Model</b>	<b>09196*</b>	<b>09197*</b>	<b>09198*</b>
<b>Standard price</b>	<b>\$34.00</b>	<b>\$51.00</b>	<b>\$69.00</b>
dimensions (wxhxd) <sup>1)</sup>	12.3 x 3 x 16.85	12.3 x 5.95 x 16.85	12.3 x 11.85 x 16.85
metal color frame M1	--	--	--
metal color frame M060			
body color steel M1	--	--	--
adj. foot 3 + with KU glides	--	--	--
adj. foot 3.95 + KU-gl. h+1.5	--	--	--
design casters d = 3	--	--	--
design casters d = 3.95, h+1.5	--	--	--
technical casters d = 3, h+0.6	--	--	--
technical casters d = 3.95, h+1.5	--	--	--
shelves LIGNOpal color 017 astral silver	--	--	--

**Material overview**

**Metal Colors**

- M1 030 terra grey
- 032 light blue
- 033 light green
- 041 turquoise
- 045 broom yellow
- 059 arctic
- 063 anthracite
- 065 black (RAL 9011)
- 071 sapphire blue (RAL 5003)
- 084 oxblood
- 091 white

- Mx 060 chrome-plated

**Laminate Colors**

- Lx 017 astral silver

**Series 600**  
**Cupboard. Open cupboard.**  
**Storage module.**

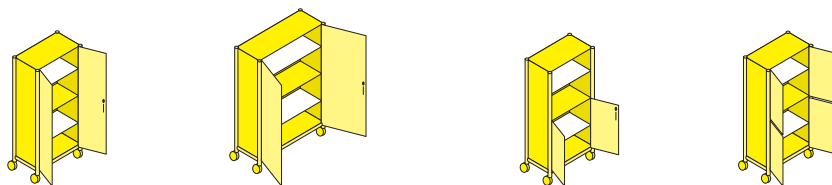

Model	45240	45241	45230	45231
<b>Standard price</b>	<b>\$2,029.00</b>	<b>\$2,743.00</b>	<b>\$1,999.00</b>	<b>\$2,276.00</b>
dimensions (wxhxd) <sup>1)</sup>	33.5 x 62.45 x 18.9	49.25 x 62.45 x 18.9	33.5 x 62.45 x 18.9	33.5 x 62.45 x 18.9
metal color frame M1	0.00	0.00	0.00	0.00
front LIGNOpal color laminate 017 astral silver	0.00	0.00	0.00	0.00
body color steel M1	0.00	0.00	0.00	0.00
locking as indicated or 18001	0.00	0.00	0.00	0.00
locking plan, site installat.	56.00	56.00	56.00	56.00
metal bow handle, chrome-plated	0.00	0.00	0.00	0.00
flush handle, nickel-plated	12.00	12.00	12.00	18.00
adj. foot 3 + with KU glides	56.00	56.00	56.00	56.00
adj. foot 3.95 + KU-gl. h+1.5	68.00	68.00	68.00	68.00
design casters d = 3	0.00	0.00	0.00	0.00
design casters d = 3.95, h+1.5	111.00	111.00	111.00	111.00
technical casters d = 3, h+0.6	50.00	50.00	50.00	50.00
technical casters d = 3.95, h+1.5	18.00	18.00	18.00	18.00
shelves LIGNOpal, 017 astral silver	0.00	--	0.00	0.00
shelves steel M2	--	0.00	--	--
equipment rubber mat	--	--	--	--
lower body shelf steel	--	--	--	--
extra lower body shelf LIGNOpal	--	--	--	--

<sup>1)</sup>Standard height includes 3" design casters

### Material overview

#### Metal Colors

M1	030 terra grey	M2	059 arctic
	032 light blue		063 anthracite
	033 light green		065 black (RAL 9011)
	041 turquoise		091 white
	045 broom yellow		
	059 arctic		
	063 anthracite		
	065 black (RAL 9011)		
	071 sapphire blue (RAL 5003)		
	084 oxblood		

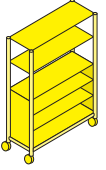

**Series 600**  
**Cupboard. Open cupboard.**  
**Storage module.**

Model	45235
<b>Standard price</b>	<b>\$2,393.00</b>
dimensions (wxhxd) <sup>1)</sup>	49.25 x 62.45 x 18.9
metal color frame M1	0.00
front LIGNOpal color laminate 017 astral silver	--
body color steel M1	0.00
locking as indicated or 18001	--
locking plan, site installat.	--
metal bow handle, chrome-plated	--
flush handle, nickel-plated	--
adj. foot 3 + with KU glides	56.00
adj. foot 3.95 + KU-gl. h+1.5	68.00
design casters d = 3	0.00
design casters d = 3.95, h+1.5	111.00
technical casters d = 3, h+0.6	50.00
technical casters d = 3.95, h+1.5	18.00
shelves LIGNOpal, 017 astral silver	0.00
shelves steel M2	0.00
equipment rubber mat	292.00
lower body shelf steel	--
extra lower body shelf LIGNOpal	--

**Material overview**

**Metal Colors**

M1	030 terra grey	M2	059 arctic
	032 light blue		063 anthracite
	033 light green		065 black (RAL 9011)
	041 turquoise		091 white
	045 broom yellow		
	059 arctic		
	063 anthracite		
	065 black (RAL 9011)		
	071 sapphire blue (RAL 5003)		
	084 oxblood		

**MyCaddy**  
Stand-at module.

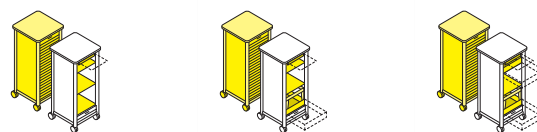

Model	45108	45109	45110
<b>Standard price</b>	<b>\$2,218.00</b>	<b>\$2,422.00</b>	<b>\$2,685.00</b>
dimensions (wxd)	19.2 x 19.2	19.2 x 19.2	19.2 x 19.2
height	43.75	43.75	43.75
metal color frame M1	0.00	0.00	0.00
metal color frame M060	840.00	840.00	840.00
tambours C017	0.00	0.00	0.00
body LIGNOpal	0.00	0.00	0.00
body color laminate L6	0.00	0.00	0.00
top LIGNOpal (2.5mm plastic edge) color laminate	0.00	0.00	0.00
adj. foot 3 + with KU glides	56.00	56.00	56.00
adj. foot 3.95 + KU-gl. h+1.5	68.00	68.00	68.00
design casters d = 3	0.00	0.00	0.00
design casters d = 3.95, h+1.5	111.00	111.00	111.00
technical casters d = 3, h+0.6	50.00	50.00	50.00
technical casters d = 3.95, h+1.5	18.00	18.00	18.00
coathanger handle on left or right	126.00	126.00	126.00
handle on left or right	44.00	44.00	44.00
name plate on left or right	12.00	12.00	12.00
post box on left or right	30.00	30.00	30.00
unified locking 18001	0.00	0.00	0.00
locking as indicated	6.00	6.00	6.00
locking plan, site installat.	56.00	56.00	56.00
filing frame for US letter format	--	0.00	0.00

*Veneers and Linoleum available upon request.*

**Material overview**

**Metal Colors**

- M1 030 terra grey
- 032 light blue
- 033 light green
- 041 turquoise
- 045 broom yellow
- 059 arctic
- 063 anthracite
- 065 black (RAL 9011)
- 071 sapphire blue (RAL 5003)
- 084 oxblood
- 091 white

**Laminate Colors**

- L6 017 astral silver
- 018 anthracite
- 019 plain black
- 027 natural beech laminate
- 028 natural maple laminate
- 029 natural walnut laminate
- 031 grey white
- 035 andes grey
- 328 white
- 340 natural oak laminate
- 415 terra grey

**Plastic Colors**

- Cx 017 astral silver

- Mx 060 chrome-plated

**Series 600**  
Stand-at module.

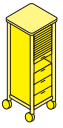
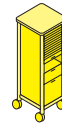
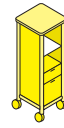

Model	45100	45104	45105
<b>Standard price</b>	<b>\$2,247.00</b>	<b>\$2,714.00</b>	<b>\$3,151.00</b>
dimensions (wxhxd) <sup>1)</sup>	19.2 x 43.75 x 19.2	19.2 x 43.75 x 19.2	19.2 x 43.75 x 19.2
metal color frame M1	0.00	0.00	0.00
metal color frame M060	569.00	569.00	569.00
Front steel M1	0.00	0.00	0.00
body perforated metal M1	0.00	0.00	0.00
top LIGNOpal (2.5mm edge) color laminate L6	0.00	0.00	0.00
locking as indicated or 18001	0.00	0.00	0.00
locking plan, site installat.	56.00	56.00	56.00
adj. foot 3 + with KU glides	56.00	56.00	56.00
adj. foot 3.95 + KU-gl. h+1.5	68.00	68.00	68.00
design casters d = 3	0.00	0.00	0.00
design casters d = 3.95, h+1.5	111.00	111.00	111.00
technical casters d = 3, h+0.6	50.00	50.00	50.00
technical casters d = 3.95, h+1.5	18.00	18.00	18.00
coathanger handle attachment, left or right	126.00	126.00	126.00
with nameplate	12.00	12.00	12.00
metal bow handle, nickel or chrome-plated	0.00	0.00	0.00
filing frame for US letter format	0.00	0.00	--

<sup>1)</sup>Standard height includes 3" design casters

Veneers and Linoleum available upon request.

**Material overview**

**Metal Colors**

- M1 030 terra grey
- 032 light blue
- 033 light green
- 041 turquoise
- 045 broom yellow
- 059 arctic
- 063 anthracite
- 065 black (RAL 9011)
- 071 sapphire blue (RAL 5003)
- 084 oxblood
- 091 white

**Laminate Colors**

- L6 017 astral silver
- 018 anthracite
- 019 plain black
- 027 natural beech laminate
- 028 natural maple laminate
- 029 natural walnut laminate
- 031 grey white
- 035 andes grey
- 328 white
- 340 natural oak laminate
- 415 terra grey

**Plastic Colors**

- Cx 017 astral silver

- Mx 060 chrome-plated

**Series 600**  
Stand-at module.

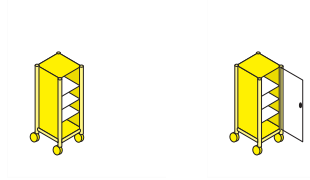

Model	45141	45142
<b>Standard price</b>	<b>\$1,226.00</b>	<b>\$1,766.00</b>
dimensions (wxhxd) <sup>1)</sup>	18.9 x 42.85 x 18.9	18.9 x 42.85 x 18.9
metal color frame M1	0.00	0.00
metal color frame M060	569.00	569.00
Front glass	--	0.00
glass type one-pane safety glass frosted	--	0.00
body color steel M1	0.00	0.00
locking as indicated or 18001	--	6.00
locking plan, site installat.	--	56.00
adj. foot 3 + with KU glides	56.00	56.00
adj. foot 3.95 + KU-gl. h+1.5	68.00	68.00
design casters d = 3	0.00	0.00
design casters d = 3.95, h+1.5	111.00	111.00
technical casters d = 3, h+0.6	50.00	50.00
technical casters d = 3.95, h+1.5	18.00	18.00
lower body shelf steel	0.00	0.00
extra lower body shelf LIGNOpal	62.00	62.00
shelf color laminate L6	0.00	0.00

<sup>1)</sup>Standard height includes 3" design casters

Veneers and Linoleum available upon request.

**Material overview**

**Metal Colors**

- M1 030 terra grey
- 032 light blue
- 033 light green
- 041 turquoise
- 045 broom yellow
- 059 arctic
- 063 anthracite
- 065 black (RAL 9011)
- 071 sapphire blue (RAL 5003)
- 084 oxblood
- 091 white

**Laminate Colors**

- L6 017 astral silver
- 018 anthracite
- 019 plain black
- 027 natural beech laminate
- 028 natural maple laminate
- 029 natural walnut laminate
- 031 grey white
- 035 andes grey
- 328 white
- 340 natural oak laminate
- 415 terra grey

**Plastic Colors**

- Cx 017 astral silver

- Mx 060 chrome-plated

**Series 600**  
**Open cupboard.**

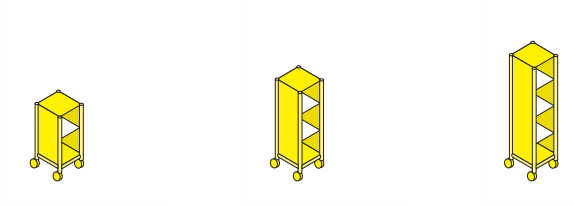

<b>Model</b>	<b>45150</b>	<b>45151</b>	<b>45152</b>
<b>Standard price</b>	<b>\$1,051.00</b>	<b>\$1,197.00</b>	<b>\$1,518.00</b>
dimensions (wxhxd) <sup>1)</sup>	18.9 x 34.9 x 18.9	18.9 x 48.7 x 18.9	18.9 x 62.45 x 18.9
metal color frame M1	0.00	0.00	0.00
metal color frame M060	569.00	569.00	569.00
body color steel M1	0.00	0.00	0.00
adj. foot 3 + with KU glides	56.00	56.00	56.00
adj. foot 3.95 + KU-gl. h+1.5	68.00	68.00	68.00
design casters d = 3	0.00	0.00	0.00
design casters d = 3.95, h+1.5	111.00	111.00	111.00
technical casters d = 3, h+0.6	50.00	50.00	50.00
technical casters d = 3.95, h+1.5	18.00	18.00	18.00
shelves LIGNOpal	0.00	0.00	0.00
shelf and top panel color laminate L6	0.00	0.00	0.00
lower body shelf steel	0.00	0.00	0.00
extra lower body shelf LIGNOpal	62.00	62.00	62.00

<sup>1)</sup>Standard height includes 3" design casters

**Material overview**

**Metal Colors**

- M1 030 terra grey
- 032 light blue
- 033 light green
- 041 turquoise
- 045 broom yellow
- 059 arctic
- 063 anthracite
- 065 black (RAL 9011)
- 071 sapphire blue (RAL 5003)
- 084 oxblood
- 091 white
- Mx 060 chrome-plated

**Laminate Colors**

- L6 017 astral silver
- 018 anthracite
- 019 plain black
- 027 natural beech laminate
- 028 natural maple laminate
- 029 natural walnut laminate
- 031 grey white
- 035 andes grey
- 328 white
- 340 natural oak laminate
- 415 terra grey

**Series 600**  
Open cupboard.

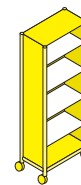
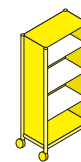
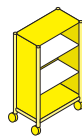
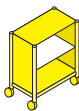

Model	45155	45156	45157	45158
<b>Standard price</b>	<b>\$1,183.00</b>	<b>\$1,401.00</b>	<b>\$1,897.00</b>	<b>\$2,218.00</b>
dimensions (wxhxd) <sup>1)</sup>	33.5 x 34.9 x 18.9	33.5 x 48.7 x 18.9	33.5 x 62.45 x 18.9	33.5 x 76.25 x 18.9
metal color frame M1	0.00	0.00	0.00	0.00
metal color frame M060	1310.00	1310.00	1310.00	1310.00
body color steel M1	0.00	0.00	0.00	0.00
adj. foot 3 + with KU glides	56.00	56.00	56.00	56.00
adj. foot 3.95 + KU-gl. h+1.5	68.00	68.00	68.00	68.00
design casters d = 3	0.00	0.00	0.00	0.00
design casters d = 3.95, h+1.5	111.00	111.00	111.00	111.00
technical casters d = 3, h+0.6	50.00	50.00	50.00	--
technical casters d = 3.95, h+1.5	18.00	18.00	18.00	18.00
shelves LIGNOpal	0.00	0.00	0.00	0.00
shelf and top panel color laminate L6	0.00	0.00	0.00	0.00
lower body shelf steel	0.00	0.00	0.00	0.00
extra lower body shelf LIGNOpal	73.00	73.00	73.00	73.00

<sup>1)</sup>Standard height includes 3" design casters

**Material overview**

**Metal Colors**

- M1 030 terra grey
- 032 light blue
- 033 light green
- 041 turquoise
- 045 broom yellow
- 059 arctic
- 063 anthracite
- 065 black (RAL 9011)
- 071 sapphire blue (RAL 5003)
- 084 oxblood
- 091 white

- Mx 060 chrome-plated

**Laminate Colors**

- L6 017 astral silver
- 018 anthracite
- 019 plain black
- 027 natural beech laminate
- 028 natural maple laminate
- 029 natural walnut laminate
- 031 grey white
- 035 andes grey
- 328 white
- 340 natural oak laminate
- 415 terra grey

**Series 600**  
**Open cupboard.**

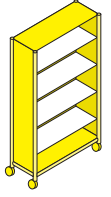
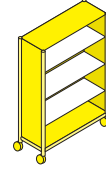
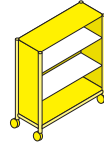
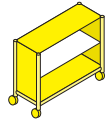

Model	45160	45161	45162	45163
<b>Standard price</b>	<b>\$1,533.00</b>	<b>\$2,189.00</b>	<b>\$2,626.00</b>	<b>\$3,093.00</b>
dimensions (wxhxd) <sup>1)</sup>	49.25 x 34.9 x 18.9	49.25 x 48.7 x 18.9	49.25 x 62.45 x 18.9	49.25 x 76.25 x 18.9
metal color frame M1	0.00	0.00	0.00	0.00
metal color frame M060	1310.00	1310.00	1310.00	1310.00
body color steel M1	0.00	0.00	0.00	0.00
adj. foot 3 + with KU glides	56.00	56.00	56.00	56.00
adj. foot 3.95 + KU-gl. h+1.5	68.00	68.00	68.00	68.00
design casters d = 3	0.00	0.00	0.00	0.00
design casters d = 3.95, h+1.5	111.00	111.00	111.00	111.00
technical casters d = 3, h+0.6	50.00	50.00	50.00	--
technical casters d = 3.95, h+1.5	18.00	18.00	18.00	18.00
shelves steel M2	0.00	0.00	0.00	0.00
lower body shelf steel	0.00	0.00	0.00	0.00
extra lower body shelf LIGNOpal	88.00	88.00	88.00	88.00

<sup>1)</sup>Standard height includes 3" design casters

**Material overview**

**Metal Colors**

- M1 030 terra grey
- 032 light blue
- 033 light green
- 041 turquoise
- 045 broom yellow
- 059 arctic
- 063 anthracite
- 065 black (RAL 9011)
- 071 sapphire blue (RAL 5003)
- 084 oxblood
- 091 white
  
- M2 059 arctic
- 063 anthracite
- 065 black (RAL 9011)
- 091 white
  
- Mx 060 chrome-plated

## Series 600 Cupboard.

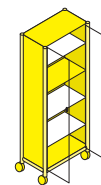
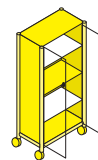
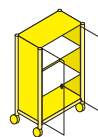
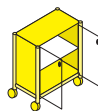

Model	45170	45171	45172	45173
<b>Standard price</b>	<b>\$2,451.00</b>	<b>\$2,729.00</b>	<b>\$3,195.00</b>	<b>\$3,983.00</b>
dimensions (wxhxd) <sup>1)</sup>	33.5 x 34.9 x 18.9	33.5 x 48.7 x 18.9	33.5 x 62.45 x 18.9	33.5 x 76.25 x 18.9
metal color frame M1	0.00	0.00	0.00	0.00
metal color frame M060	1310.00	1310.00	1310.00	1310.00
Front glass	0.00	0.00	0.00	0.00
glass type one-pane safety glass frosted	0.00	0.00	0.00	0.00
body color steel M1	0.00	0.00	0.00	0.00
unified locking 18001	0.00	0.00	0.00	0.00
locking as indicated	6.00	6.00	6.00	6.00
locking plan, site installat.	56.00	56.00	56.00	56.00
adj. foot 3 + with KU glides	56.00	56.00	56.00	56.00
adj. foot 3.95 + KU-gl. h+1.5	68.00	68.00	68.00	68.00
design casters d = 3	0.00	0.00	0.00	0.00
design casters d = 3.95, h+1.5	111.00	111.00	111.00	111.00
technical casters d = 3, h+0.6	50.00	50.00	50.00	--
technical casters d = 3.95, h+1.5	18.00	18.00	18.00	18.00
shelves LIGNOpal	0.00	0.00	0.00	0.00
shelf color laminate L6	0.00	0.00	0.00	0.00
lower body shelf steel	0.00	0.00	0.00	0.00
extra lower body shelf LIGNOpal	73.00	73.00	73.00	73.00

<sup>1)</sup>Standard height includes 3" design casters

### Material overview

#### Metal Colors

M1 030	terra grey
032	light blue
033	light green
041	turquoise
045	broom yellow
059	arctic
063	anthracite
065	black (RAL 9011)
071	sapphire blue (RAL 5003)
084	oxblood
091	white

#### Laminate Colors

L6 017	astral silver
018	anthracite
019	plain black
027	natural beech laminate
028	natural maple laminate
029	natural walnut laminate
031	grey white
035	andes grey
328	white
340	natural oak laminate
415	terra grey

#### Glass Colors

G2 001	TSG satin-frosted
--------	-------------------

Mx 060 chrome-plated

**Series 600  
Tambour cupboard.**

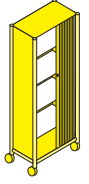
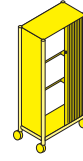
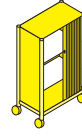
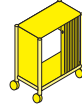

Model	45180	45181	45182	45183
<b>Standard price</b>	<b>\$1,926.00</b>	<b>\$2,262.00</b>	<b>\$2,656.00</b>	<b>\$3,108.00</b>
dimensions (wxhxd) <sup>1)</sup>	36.45 x 34.9 x 18.9	36.45 x 48.7 x 18.9	36.45 x 62.45 x 18.9	36.45 x 76.25 x 18.9
metal color frame M1	0.00	0.00	0.00	0.00
metal color frame M060	1310.00	1310.00	1310.00	1310.00
Tambours C 017 astral silver	0.00	0.00	0.00	0.00
Tambours acoustically effective	205.00	321.00	438.00	555.00
body LIGNOpal laminate color Lx	0.00	0.00	0.00	0.00
18001	0.00	0.00	0.00	0.00
locking as indicated	6.00	6.00	6.00	6.00
locking plan, site installat.	56.00	56.00	56.00	56.00
adj. foot 3 + with KU glides	56.00	56.00	56.00	56.00
adj. foot 3.95 + KU-gl. h+1.5	68.00	68.00	68.00	68.00
design casters d = 3	0.00	0.00	0.00	0.00
design casters d = 3.95, h+1.5	111.00	111.00	111.00	111.00
technical casters d = 3, h+0.6	50.00	50.00	50.00	--
technical casters d = 3.95, h+1.5	18.00	18.00	18.00	18.00
shelves LIGNOpal	0.00	0.00	0.00	0.00
shelf color laminate Lx	0.00	0.00	0.00	0.00

<sup>1)</sup>Standard height includes 3" design casters

**Material overview**

**Metal Colors**

- M1 030 terra grey
- 032 light blue
- 033 light green
- 041 turquoise
- 045 broom yellow
- 059 arctic
- 063 anthracite
- 065 black (RAL 9011)
- 071 sapphire blue (RAL 5003)
- 084 oxblood
- 091 white

**Laminate Colors**

- Lx 017 astral silver
- 018 anthracite
- 019 plain black

**Plastic Colors**

- Cx 017 astral silver

- Mx 060 chrome-plated

**Profil-800**  
**Half-cupboard with small compartments for wooden trays.**

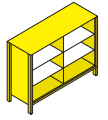

<b>Model</b>	<b>48135</b>
<b>Base price</b>	<b>\$1,474.00</b>
dimensions (wxhxd)	49.65 x 37.45 x 17.55
wooden parts beech 010 natural	0.00
body color laminate L5	0.00
personal property box, natural*	668.00
pers.prop.box, assorted.colors*	989.00
adjustable shelf 4, same as body	0.00
box stain H1	--

\* Price based on box (09194). Model 48135 gets 2 boxes per cubby.

**Material overview**

**Wood Stain Colors**

H1	011	black
	021	light green
	022	light blue
	023	light grey
	027	dark red
	029	dark blue
	037	traffic red
	041	turquoise
	045	broom yellow
	051	polar white

Hx	010	natural
----	-----	---------

**Laminate Colors**

L5	017	astral silver
	018	anthracite
	019	plain black
	027	natural beech laminate
	031	grey white
	035	andes grey
	328	white
	415	terra grey

**Profil-800**  
**Half-cupboard with small compartments for wooden trays.**



Model	48137	48138
<b>Base price</b>	<b>\$1,329.00</b>	<b>\$1,474.00</b>
dimensions (wxhxd)	49.65 x 37.45 x 17.55	49.65 x 37.45 x 17.55
wooden parts beech 010 natural	0.00	0.00
body color laminate L5	0.00	0.00
personal property box, natural*	660.00	870.00
pers.prop.box, assorted.colors*	940.00	1260.00
adjustable shelf 4, same as body	--	--
adjustable shelf 6, same as body	--	--
adjustable shelf 8, same as body	0.00	--
adjustable shelf 12, same as body	--	0.00

\* Price based on box (09194). Models 48137/48138 get 1 box per cubby.

**Material overview**

**Wood Stain Colors**

- H1 011 black
- 021 light green
- 022 light blue
- 023 light grey
- 027 dark red
- 029 dark blue
- 037 traffic red
- 041 turquoise
- 045 broom yellow
- 051 polar white

**Laminate Colors**

- L5 017 astral silver
- 018 anthracite
- 019 plain black
- 027 natural beech laminate
- 031 grey white
- 035 andes grey
- 328 white
- 415 terra grey

- Hx 010 natural

**Profil-800**  
**Wooden trays.**



Model	09193	09194
<b>Base price</b>	<b>\$60.00</b>	<b>\$69.00</b>
dimensions (wxhxd)	9.1 x 5.55 x 13.4	10.25 x 5.55 x 14.2
wooden parts beech 010 natural	0.00	0.00
body color laminate L5	--	--
personal property box, natural*	--	--
pers.prop.box, assorted.colors*	--	--
adjustable shelf 4, same as body	--	--
adjustable shelf 6, same as body	--	--
adjustable shelf 8, same as body	--	--
adjustable shelf 12, same as body	--	--
box stain H1	41.00	41.00

**Material overview**

**Wood Stain Colors**

- H1 011 black
- 021 light green
- 022 light blue
- 023 light grey
- 027 dark red
- 029 dark blue
- 037 traffic red
- 041 turquoise
- 045 broom yellow
- 051 polar white

**Profil-800**  
Half-cupboard with small compartments for plastic trays.



Model	48132	48133	48134
<b>Base price</b>	<b>\$1,051.00</b>	<b>\$1,358.00</b>	<b>\$1,679.00</b>
dimensions (wxhxd)	30.55 x 37.45 x 17.55	43.9 x 37.45 x 17.55	57.5 x 37.45 x 17.55
hardware without guide bow	--	--	--
hardware with guide bow	--	--	--
wooden parts beech H010 natural	0.00	0.00	0.00
body color laminate L5	0.00	0.00	0.00
Column 1 guideplates for bins	0.00	0.00	0.00
Column 1 plastic boxes 3 in. high	155.00	155.00	155.00
Column 1 plastic boxes 6 in. high	117.00	117.00	117.00
Column 2 guideplates for bins	0.00	0.00	0.00
Column 2 plastic boxes 3 in. high	155.00	155.00	155.00
Column 2 plastic boxes 6 in. high	117.00	117.00	117.00
Column 3 guideplates for bins	--	0.00	0.00
Column 3 plastic boxes 3 in. high	--	155.00	155.00
Column 3 plastic boxes 6 in. high	--	117.00	117.00
Column 4 guideplates for bins	--	--	0.00
Column 4 plastic boxes 3 in. high	--	--	155.00
Column 4 plastic boxes 6 in. high	--	--	117.00

1x Vertical Column  
8x 48565 bins  
4x 48566 bins

**Material overview**

**Wood Stain Colors**  
Hx 010 natural

**Laminate Colors**

L5 017 astral silver  
018 anthracite  
019 plain black  
027 natural beech laminate  
031 grey white  
035 andes grey  
328 white  
415 terra grey

**Plastic Colors**

C3 001 red  
014 anthracite  
016 translucent  
030 dark red  
031 dark blue  
032 light blue  
033 light green  
038 turquoise  
039 broom yellow

**Profil-800**  
**Plastic trays for half-cupboard.**

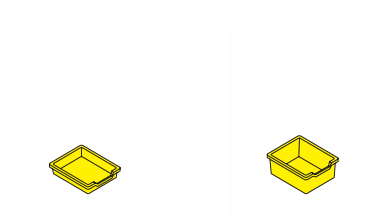

Model	48565	48566
<b>Base price</b>	<b>\$28.00</b>	<b>\$34.00</b>
dimensions (wxhxd)	12.3 x 3 x 14.85	12.3 x 5.95 x 14.85
plastic color C3	0.00	0.00
color	--	--

*Prices for plastic bins only valid if ordered with a storage unit.*

**Material overview**

**Plastic Colors**

- C3 001 red
- 014 anthracite
- 016 translucent
- 030 dark red
- 031 dark blue
- 032 light blue
- 033 light green
- 038 turquoise
- 039 broom yellow

**Series 800  
Shelving cabinets.**

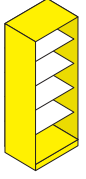

Model	44035	44335	44038	44338
<b>Base price</b>	<b>\$526.00</b>	<b>\$629.00</b>	<b>\$1,066.00</b>	<b>\$1,343.00</b>
overall dimensions (wxhxd)*	31.5 x 33.3 x 16.75	31.5 x 33.3 x 22.85	31.5 x 77.6 x 16.75	31.5 x 77.6 x 22.85
body color LIGNOpal L6	0.00	0.00	0.00	0.00
kick plate LIGNOpal L6	79.00	79.00	79.00	79.00
with wardrobe	--	--	--	68.00
LIGNOpal shelf 1, same as body	0.00	0.00	<b>-177.00</b>	<b>-239.00</b>
LIGNOpal shelf 2, same as body	88.00	117.00	<b>-113.00</b>	<b>-148.00</b>
LIGNOpal shelf 3, same as body	164.00	225.00	<b>-52.00</b>	<b>-78.00</b>
LIGNOpal shelf 4, same as body	--	--	0.00	0.00
LIGNOpal shelf 5, same as body	--	--	88.00	120.00
LIGNOpal shelf 6, same as body	--	--	164.00	225.00
base flush with back	0.00	0.00	0.00	0.00
with 3/4 inch cut-out base	0.00	0.00	0.00	0.00
with back panel to match body color	120.00	120.00	187.00	225.00

\*includes base of cabinet

**Material overview**

**Laminate Colors**

- L6 017 astral silver
- 018 anthracite
- 019 plain black
- 027 natural beech laminate
- 028 natural maple laminate
- 029 natural walnut laminate
- 031 grey white
- 035 andes grey
- 328 white
- 340 natural oak laminate
- 415 terra grey

\*\*Additional sizes and configurations available on request.\*\*

**Series 800  
Shelving cabinets.**

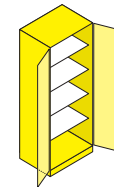
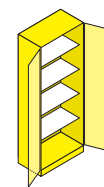
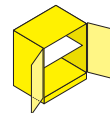
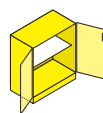

Model	44010	44310	44020	44320
<b>Base price</b>	<b>\$774.00</b>	<b>\$876.00</b>	<b>\$1,474.00</b>	<b>\$1,708.00</b>
overall dimensions (wxhxd)*	31.5 x 33.3 x 17.55	31.5 x 33.3 x 23.65	31.5 x 77.6 x 17.55	31.5 x 77.6 x 23.65
front color LIGNOpal L3	0.00	0.00	0.00	0.00
body color LIGNOpal L6	0.00	0.00	0.00	0.00
kick plate LIGNOpal L6	79.00	79.00	79.00	79.00
with wardrobe	--	--	--	225.00
LIGNOpal shelf 1, same as body	0.00	0.00	<b>-177.00</b>	<b>-239.00</b>
LIGNOpal shelf 2, same as body	88.00	117.00	<b>-113.00</b>	<b>-148.00</b>
LIGNOpal shelf 3, same as body	164.00	225.00	<b>-52.00</b>	<b>-78.00</b>
LIGNOpal shelf 4, same as body	--	--	0.00	0.00
LIGNOpal shelf 5, same as body	--	--	88.00	120.00
LIGNOpal shelf 6, same as body	--	--	164.00	225.00
base flush with back	0.00	0.00	0.00	0.00
with 3/4 inch cut-out base	0.00	0.00	0.00	0.00
with back panel to match body color	120.00	120.00	187.00	187.00
unified locking 18001 or as indicated	44.00	44.00	44.00	44.00
metal bow handle, Ni- or Cr-plated	0.00	0.00	0.00	0.00
with turning knob, lockable	44.00	44.00	44.00	44.00
hinges visible, 270° opening angle	0.00	0.00	0.00	0.00
hinges concealed, 110° opening angle, damped	0.00	0.00	0.00	0.00

\*includes base of cabinet and door

**Material overview**

**Laminate Colors**

L3	017	astral silver	L6	017	astral silver
	018	anthracite		018	anthracite
	019	plain black		019	plain black
	027	natural beech laminate		027	natural beech laminate
	028	natural maple laminate		028	natural maple laminate
	029	natural walnut laminate		029	natural walnut laminate
	031	grey white		031	grey white
	035	andes grey		035	andes grey
	328	white		328	white
	340	natural oak laminate		340	natural oak laminate
	415	terra grey		415	terra grey

\*\*Additional sizes and configurations available on request.\*\*

**Series 800-Mobil**  
Mobile shelving cabinets.

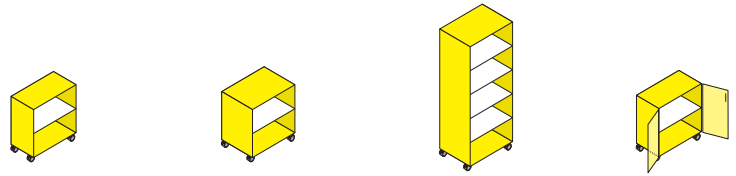

Model	47450	47550	47559	47400
<b>Base price</b>	<b>\$774.00</b>	<b>\$906.00</b>	<b>\$1,547.00</b>	<b>\$1,008.00</b>
overall dimensions (wxhxd)*	31.5 x 34.75 x 16.75	31.5 x 34.75 x 22.85	31.5 x 79.05 x 22.85	31.5 x 34.75 x 17.55
front color LIGNOpal L3	--	--	--	0.00
body color LIGNOpal L6	0.00	0.00	0.00	0.00
LIGNOpal shelf 1, same as body	0.00	0.00	-239.00	0.00
LIGNOpal shelf 2, same as body	68.00	88.00	-160.00	68.00
LIGNOpal shelf 3, same as body	132.00	175.00	-78.00	132.00
LIGNOpal shelf 4, same as body	--	--	0.00	--
LIGNOpal shelf 5, same as body	--	--	88.00	--
LIGNOpal shelf 6, same as body	--	--	175.00	--
mobile on casters	0.00	0.00	0.00	0.00
unified locking 18001 or as indicated	--	--	--	0.00
metal bow handle, Ni- or Cr-plated	--	--	--	0.00
with turning knob, locking 18001 or as indicated	--	--	--	12.00
with turning knob, locking plan site installat.	--	--	--	35.00
hinges visible, 270° opening angle	--	--	--	0.00
hinges concealed, 110° opening angle, damped	--	--	--	0.00

\*includes base of cabinet and door

**Material overview**

**Laminate Colors**

L3	017	astral silver	L6	017	astral silver
	018	anthracite		018	anthracite
	019	plain black		019	plain black
	027	natural beech laminate		027	natural beech laminate
	028	natural maple laminate		028	natural maple laminate
	029	natural walnut laminate		029	natural walnut laminate
	031	grey white		031	grey white
	035	andes grey		035	andes grey
	328	white		328	white
	340	natural oak laminate		340	natural oak laminate
	415	terra grey		415	terra grey

\*\*Additional sizes and configurations available on request.\*\*

**Series 800-Mobil**  
**Mobile shelving cabinets.**

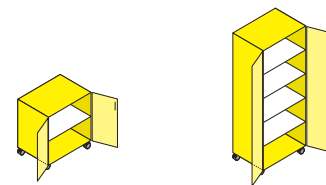

Model	47500	47509
<b>Base price</b>	<b>\$1,197.00</b>	<b>\$2,131.00</b>
overall dimensions (wxhxd)*	31.5 x 34.75 x 23.65	31.5 x 79.05 x 23.65
front color LIGNOpal L3	0.00	0.00
body color LIGNOpal L6	0.00	0.00
LIGNOpal shelf 1, same as body	0.00	<b>-177.00</b>
LIGNOpal shelf 2, same as body	88.00	<b>-119.00</b>
LIGNOpal shelf 3, same as body	175.00	<b>-58.00</b>
LIGNOpal shelf 4, same as body	--	0.00
LIGNOpal shelf 5, same as body	--	88.00
LIGNOpal shelf 6, same as body	--	175.00
mobile on casters	0.00	0.00
unified locking 18001 or as indicated	0.00	0.00
metal bow handle, Ni- or Cr-plated	0.00	0.00
with turning knob, locking 18001 or as indicated	12.00	12.00
with turning knob, locking plan site installat.	35.00	35.00
hinges visible, 270° opening angle	0.00	0.00
hinges concealed, 110° opening angle, damped	0.00	0.00

\*includes base of cabinet and door

**Material overview**

**Laminate Colors**

L3	017	astral silver	L6	017	astral silver
	018	anthracite		018	anthracite
	019	plain black		019	plain black
	027	natural beech laminate		027	natural beech laminate
	028	natural maple laminate		028	natural maple laminate
	029	natural walnut laminate		029	natural walnut laminate
	031	grey white		031	grey white
	035	andes grey		035	andes grey
	328	white		328	white
	340	natural oak laminate		340	natural oak laminate
	415	terra grey		415	terra grey

**Series 800-Mobil**  
Mobile shelving cabinets.

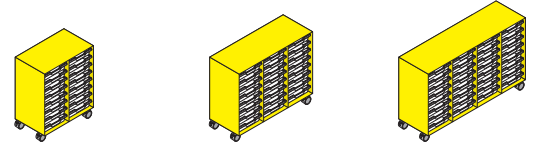

Model	47440	47441	47442
<b>Standard price</b>	<b>\$804.00</b>	<b>\$1,110.00</b>	<b>\$1,445.00</b>
overall dimensions (wxhxd)*	28 x 34.75 x 16.75	41.55 x 34.75 x 16.75	55.15 x 34.75 x 16.75
body color LIGNOpl L6	0.00	0.00	0.00
metal bow handle Ni- or Cr-plated	--	--	--
flush handle Ni-plated	--	--	--
with turning knob, lockable 18001 or as indicated	--	--	--
with turning knob, lockable locking plan site installat.	--	--	--
Column 1 guide plates ONLY	0.00	0.00	0.00
Column 1 plastic boxes 3 in. high C3 or assorted colors	120.00	120.00	120.00
Column 1 plastic boxes 3 in. high, with lids C3 or assorted colors	179.00	179.00	179.00
Column 1 plastic boxes 6 in. high C3 or assorted colors	82.00	82.00	82.00
Column 1 plastic boxes 6 in. high, with lids C3 or assorted colors	112.00	112.00	112.00
Column 2 guide plates ONLY	0.00	0.00	0.00
Column 2 plastic boxes 3 in. high C3 or assorted colors	120.00	120.00	120.00
Column 2 plastic boxes 3 in. high, with lids C3 or assorted colors	179.00	179.00	179.00
Column 2 plastic boxes 6 in. high C3 or assorted colors	82.00	82.00	82.00
Column 2 plastic boxes 6 in. high, with lids C3 or assorted colors	112.00	112.00	112.00
Column 3 guide plates ONLY	--	0.00	0.00
Column 3 plastic boxes 3 in. high C3 or assorted colors	--	120.00	120.00
Column 3 plastic boxes 3 in. high, with lids C3 or assorted colors	--	179.00	179.00
Column 3 plastic boxes 6 in. high C3 or assorted colors	--	82.00	82.00
Column 3 plastic boxes 6 in. high, with lids C3 or assorted colors	--	112.00	112.00
Column 4 guide plates ONLY	--	--	0.00
Column 4 plastic boxes 3 in. high C3 or assorted colors	--	--	120.00
Column 4 plastic boxes 3 in. high, with lids C3 or assorted colors	--	--	179.00
Column 4 plastic boxes 6 in. high C3 or assorted colors	--	--	82.00
Column 4 plastic boxes 6 in. high, with lids C3 or assorted colors	--	--	112.00
mobile on casters	0.00	0.00	0.00
number of 3" (model 48565) bins per column	8	8	8
number of 6" (model 48566) bins per column	4	4	4

\*includes base of cabinet and door

**Material overview**

**Plastic Colors**

- C3 001 red
- 014 anthracite
- 016 translucent
- 030 dark red
- 031 dark blue
- 032 light blue
- 033 light green
- 038 turquoise
- 039 broom yellow

**Laminate Colors**

- L6 017 astral silver
- 018 anthracite
- 019 plain black
- 027 natural beech laminate
- 028 natural maple laminate
- 029 natural walnut laminate
- 031 grey white
- 035 andes grey
- 328 white
- 340 natural oak laminate
- 415 terra grey

\*\*Additional sizes and configurations available on request.\*\*

**Series 800-Mobil**  
Mobile shelving cabinets.

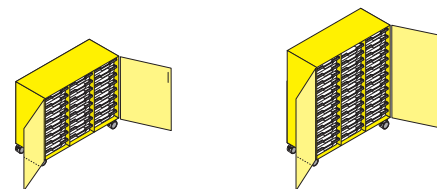

Model	47443	47444
Standard price	\$1,314.00	\$1,708.00
overall dimensions (wxhxd)*	41.55 x 34.75 x 17.55	41.55 x 49.5 x 17.55
body color LIGNOpal L6	0.00	0.00
metal bow handle Ni- or Cr-plated	0.00	0.00
flush handle Ni-plated	0.00	0.00
with turning knob, lockable 18001 or as indicated	12.00	12.00
with turning knob, lockable locking plan site installat.	35.00	35.00
Column 1 guide plates ONLY	0.00	0.00
Column 1 plastic boxes 3 in. high C3 or assorted colors	120.00	117.00
Column 1 plastic boxes 3 in. high, with lids C3 or assorted colors	179.00	205.00
Column 1 plastic boxes 6 in. high C3 or assorted colors	82.00	117.00
Column 1 plastic boxes 6 in. high, with lids C3 or assorted colors	112.00	161.00
Column 2 guide plates ONLY	0.00	0.00
Column 2 plastic boxes 3 in. high C3 or assorted colors	120.00	117.00
Column 2 plastic boxes 3 in. high, with lids C3 or assorted colors	179.00	205.00
Column 2 plastic boxes 6 in. high C3 or assorted colors	82.00	117.00
Column 2 plastic boxes 6 in. high, with lids C3 or assorted colors	112.00	161.00
Column 3 guide plates ONLY	0.00	0.00
Column 3 plastic boxes 3 in. high C3 or assorted colors	120.00	117.00
Column 3 plastic boxes 3 in. high, with lids C3 or assorted colors	179.00	205.00
Column 3 plastic boxes 6 in. high C3 or assorted colors	82.00	117.00
Column 3 plastic boxes 6 in. high, with lids C3 or assorted colors	112.00	161.00
Column 4 guide plates ONLY	--	--
Column 4 plastic boxes 3 in. high C3 or assorted colors	--	--
Column 4 plastic boxes 3 in. high, with lids C3 or assorted colors	--	--
Column 4 plastic boxes 6 in. high C3 or assorted colors	--	--
Column 4 plastic boxes 6 in. high, with lids C3 or assorted colors	--	--
mobile on casters	0.00	0.00
number of 3" (model 48565) bins per column	8	12
number of 6" (model 48566) bins per column	4	6

\*includes base of cabinet and door

**Material overview**

**Plastic Colors**

C3 001	red
014	anthracite
016	translucent
030	dark red
031	dark blue
032	light blue
033	light green
038	turquoise
039	broom yellow

**Laminate Colors**

L6 017	astral silver
018	anthracite
019	plain black
027	natural beech laminate
028	natural maple laminate
029	natural walnut laminate
031	grey white
035	andes grey
328	white
340	natural oak laminate
415	terra grey

\*\*Additional sizes and configurations available on request.\*\*

**Series 800  
Shelving cabinets.**

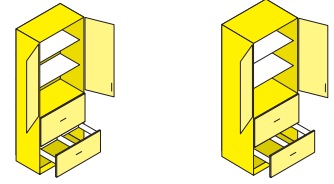

Model	47604	47704
<b>Base price</b>	<b>\$2,495.00</b>	<b>\$2,976.00</b>
overall dimensions (wxhxd)*	31.5 x 77.6 x 17.55	31.5 x 77.6 x 23.65
front color LIGNOpal L3	0.00	0.00
body color LIGNOpal L6	0.00	0.00
without kick plate	0.00	0.00
kick plate LIGNOpal L6	79.00	79.00
LIGNOpal shelf 1, same as body	<b>-49.00</b>	<b>-70.00</b>
LIGNOpal shelf 2, same as body	0.00	0.00
LIGNOpal shelf 3, same as body	73.00	94.00
LIGNOpal shelf 4, same as body	143.00	187.00
LIGNOpal shelf 5, same as body	--	--
LIGNOpal shelf 6, same as body	--	--
base flush with back	0.00	0.00
with 3/4 inch cut-out base	0.00	0.00
without back panel	0.00	0.00
with back panel to match body color	155.00	155.00
drawer for hanging files	0.00	0.00
standard flat drawer	56.00	56.00
filing frame for US letter format	0.00	0.00
unified locking 18001 or as indicated	0.00	0.00
metal bow handle, Ni- or Cr-plated	0.00	0.00
with turning knob, lockable	62.00	62.00
hinges visible, 270° opening angle	0.00	0.00
hinges concealed, 110° opening angle, damped	0.00	0.00

\*includes base of cabinet and door

Veneers available upon request.

**Material overview**

**Laminate Colors**

L3	017	astral silver	L6	017	astral silver
	018	anthracite		018	anthracite
	019	plain black		019	plain black
	027	natural beech laminate		027	natural beech laminate
	028	natural maple laminate		028	natural maple laminate
	029	natural walnut laminate		029	natural walnut laminate
	031	grey white		031	grey white
	035	andes grey		035	andes grey
	328	white		328	white
	340	natural oak laminate		340	natural oak laminate
	415	terra grey		415	terra grey

\*\*Additional sizes and configurations available on request.\*\*

**OfficeBox**  
Mobile containers (short).



Model	40500	40503
<b>Base price</b>	<b>\$1,051.00</b>	<b>\$1,066.00</b>
	pencil drawer, box, file (1.5+ 2+ 6 HU)	pencil drawer, box, file (1,5+ 3+ 6 HU)
dimensions (wxhxd)	16.95 x 21.7 x 23.65	16.95 x 23.65 x 23.65
front color LIGNOpal L3	0.00	0.00
body color LIGNOpal L6	0.00	0.00
without seat cushion	0.00	0.00
with seat cushion, upholstery S46/54	205.00	205.00
with seat cushion, upholstery S51	249.00	249.00
with seat cushion, upholstery S74	205.00	205.00
with seat cushion, upholstery S78	217.00	217.00
with seat cushion, upholstery S79	246.00	246.00
with swivel handle on top	263.00	263.00
unified locking 18001 or as indicated	0.00	0.00
locking plan, site installat.	56.00	56.00
combination lock, fix code	62.00	62.00
metal bow handle, Ni- or Cr-plated	0.00	0.00
Orga drawer w.partial pull out	0.00	0.00
Orga drawer with full pull out	0.00	0.00
with soft-close mechanism	73.00	73.00
without organization accessories	0.00	0.00
with organization set no. 1	12.00	12.00
filing frame for US letter format	0.00	0.00

Veneers available upon request.

More drawer pull options available upon request.

**Material overview**

**Laminate Colors**

- L3 017 astral silver
- 018 anthracite
- 019 plain black
- 027 natural beech laminate
- 028 natural maple laminate
- 029 natural walnut laminate
- 031 grey white
- 035 andes grey
- 328 white
- 340 natural oak laminate
- 415 terra grey

- L6 017 astral silver
- 018 anthracite
- 019 plain black
- 027 natural beech laminate
- 028 natural maple laminate
- 029 natural walnut laminate
- 031 grey white
- 035 andes grey
- 328 white
- 340 natural oak laminate
- 415 terra grey

**Fabrics**

- S46/S54 Xtreme
- S51 Blazer
- S74 Era
- S78 Step/StepMelange
- S79 Trevi D

**OfficeBox**  
Mobile containers (long).

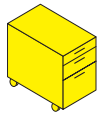
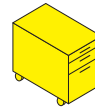

Model	40510	40513
<b>Base price</b>	<b>\$1,183.00</b>	<b>\$1,153.00</b>
	pencil drawer, box, file (1.5+ 2+ 6 HU)	pencil drawer, box, file (1,5+ 3+ 6 HU)
dimensions (wxhxd)	16.95 x 21.7 x 31.5	16.95 x 23.65 x 31.5
front color LIGNOpal L3	0.00	0.00
body color LIGNOpal L6	0.00	0.00
without seat cushion	0.00	0.00
with seat cushion, upholstery S46/S54	234.00	234.00
with seat cushion, upholstery S51	278.00	278.00
with seat cushion, upholstery S74	234.00	234.00
with seat cushion, upholstery S78	246.00	246.00
with seat cushion, upholstery S79	275.00	275.00
with swivel handle on top	--	--
unified locking 18001 or as indicated	0.00	0.00
locking plan, site installat.	56.00	56.00
combination lock, fix code	62.00	62.00
metal bow handle, Ni- or Cr-plated	0.00	0.00
Orga drawer w.partial pull out	0.00	0.00
Orga drawer with full pull out	0.00	0.00
with soft-close mechanism	73.00	73.00
without organization accessories	0.00	0.00
with organization set no. 3	18.00	18.00
filing frame for US letter format	0.00	0.00

Veneers available upon request.

More drawer pull options available upon request.

**Material overview**

**Laminate Colors**

- L3 017 astral silver
- 018 anthracite
- 019 plain black
- 027 natural beech laminate
- 028 natural maple laminate
- 029 natural walnut laminate
- 031 grey white
- 035 andes grey
- 328 white
- 340 natural oak laminate
- 415 terra grey

- L6 017 astral silver
- 018 anthracite
- 019 plain black
- 027 natural beech laminate
- 028 natural maple laminate
- 029 natural walnut laminate
- 031 grey white
- 035 andes grey
- 328 white
- 340 natural oak laminate
- 415 terra grey

**Fabrics**

- S46/S54 Xtreme
- S51 Blazer
- S74 Era
- S78 Step/StepMelange
- S79 Trevi D

**LearnBox**  
Storage for student workstations.

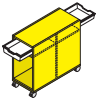

Model	40050	40051*
<b>Base price</b>	<b>\$570.00</b>	<b>\$629.00</b>
dimensions (wxhxd)	14.4 x 29.95 x 27.6 (31.5)	14.4 x 29.95 x 31.5
body color LIGNOpal L6	0.00	0.00
prepared for add-on cabinet	0.00	0.00
with cover plate 19mm LIGNOpal, 2.5mm KU edge, color laminate L6	30.00	30.00
Gratnell box 3 in. high C3	0.00	0.00
Gratnell box 3 in. high C3, with lid	0.00	0.00
with rubber protector mats	56.00	56.00
mobile on casters	0.00	0.00
adjustable feet	0.00	0.00

*\*accessible from both sides, includes 2x Gratnell bins*

Two standard depths available for model 40050: 27.6" or 31.5"

**Material overview**

**Plastic Colors**

- C3 001 red
- 014 anthracite
- 016 translucent
- 030 dark red
- 031 dark blue
- 032 light blue
- 033 light green
- 038 turquoise
- 039 broom yellow

**Laminate Colors**

- L6 017 astral silver
- 018 anthracite
- 019 plain black
- 027 natural beech laminate
- 028 natural maple laminate
- 029 natural walnut laminate
- 031 grey white
- 035 andes grey
- 328 white
- 340 natural oak laminate
- 415 terra grey

**LearnBox**  
Storage for student workstations.

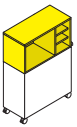
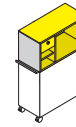
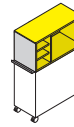

Model	40055	40056	40057
<b>Base price</b>	<b>\$483.00</b>	<b>\$599.00</b>	<b>\$483.00</b>
dimensions (wxhxd)	14.4 x 15 x 27.6 (31.5)	14.4 x 15 x 27.6 (31.5)	14.4 x 15 x 27.6 (31.5)
metal color M1	0.00	0.00	0.00
body color LIGNOpal L6	0.00	0.00	0.00
front color LIGNOpal L6	--	0.00	--
alignment to user	left	left	right
with grommet in body	18.00	18.00	18.00
linking vertical standard - option for one-time linking	0.00	0.00	0.00
linking vertical with sleeve - option for repeated linking	18.00	18.00	18.00
locking 18001 as indicated	--	0.00	--

Two standard depths available for models 40055, 40056, 40057: 27.6" or 31.5"

**Material overview**

**Metal Colors**

- M1 030 terra grey
- 032 light blue
- 033 light green
- 041 turquoise
- 045 broom yellow
- 059 arctic
- 063 anthracite
- 065 black (RAL 9011)
- 071 sapphire blue (RAL 5003)
- 084 oxblood
- 091 white

**Laminate Colors**

- L6 017 astral silver
- 018 anthracite
- 019 plain black
- 027 natural beech laminate
- 028 natural maple laminate
- 029 natural walnut laminate
- 031 grey white
- 035 andes grey
- 328 white
- 340 natural oak laminate
- 415 terra grey

**LearnBox**  
Storage for student workstations.

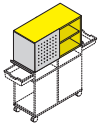
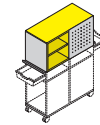
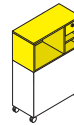

Model	40058	40059*	40060*
<b>Base price</b>	<b>\$599.00</b>	<b>\$591.00</b>	<b>\$591.00</b>
dimensions (wxhxd)	14.4 x 15 x 27.6 (31.5)	14.4 x 15 x 31.5	14.4 x 15 x 31.5
metal color M1	0.00	0.00	0.00
body color LIGNOpal L6	0.00	0.00	0.00
front color LIGNOpal L6	0.00	--	--
alignment to user	right	left	right
with grommet in body	18.00	--	--
linking vertical standard - option for one-time linking	0.00	0.00	0.00
linking vertical with sleeve - option for repeated linking	18.00	18.00	18.00
locking 18001 as indicated	0.00	--	--

*\*accessible from both sides*

**Two standard depths available for model 40058: 27.6" or 31.5"**

**Material overview**

**Metal Colors**

- M1 030 terra grey
- 032 light blue
- 033 light green
- 041 turquoise
- 045 broom yellow
- 059 arctic
- 063 anthracite
- 065 black (RAL 9011)
- 071 sapphire blue (RAL 5003)
- 084 oxblood
- 091 white

**Laminate Colors**

- L6 017 astral silver
- 018 anthracite
- 019 plain black
- 027 natural beech laminate
- 028 natural maple laminate
- 029 natural walnut laminate
- 031 grey white
- 035 andes grey
- 328 white
- 340 natural oak laminate
- 415 terra grey

**LearnBox**  
Storage for teacher workstations.



Model	40052	40053*	40054
Base price	\$935.00	\$1,270.00	\$1,693.00
dimensions (wxhxd)	14.4 x 29.95 x 27.6 (31.5)	14.4 x 29.95 x 27.6 (31.5)	14.4 x 29.95 x 27.6 (31.5)
body color LIGNOpal L6	0.00	0.00	0.00
front color LIGNOpal L6	0.00	0.00	0.00
door on left	0.00	0.00	0.00
door on right	0.00	0.00	0.00
prepared for add-on cabinet	0.00	0.00	0.00
with cover plate 19mm LIGNOpal, 2.5mm KU edge, color laminate L6	30.00	30.00	30.00
unified locking 18001 or as indicated	0.00	0.00	0.00
locking plan, site installat.	0.00	0.00	0.00
metal bow handle, Ni- or Cr-plated	0.00	0.00	0.00
hinges visible, 270° opening angle	0.00	0.00	0.00
hinges concealed, 110° opening angle, damped	0.00	0.00	0.00
upper drawer with material tray	132.00	132.00	132.00
mobile on casters	0.00	0.00	0.00
adjustable feet	0.00	0.00	0.00

*\*filing frame for bottom drawer to be ordered separately, see model 40068*

**Two standard depths available for models 40052, 40053, 40054: 27.6" or 31.5"**

**Material overview**

**Laminate Colors**

- L6 017 astral silver
- 018 anthracite
- 019 plain black
- 027 natural beech laminate
- 028 natural maple laminate
- 029 natural walnut laminate
- 031 grey white
- 035 andes grey
- 328 white
- 340 natural oak laminate
- 415 terra grey

**LearnBox**  
Storage for student workstations.

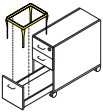

<b>Model</b>	<b>40068</b>
<b>Base price</b>	<b>\$45.00</b>

**LearnBox**  
Storage for teacher workstations.

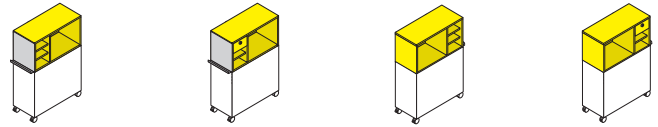

Model	40055	40056	40057	40058
<b>Base price</b>	<b>\$483.00</b>	<b>\$599.00</b>	<b>\$483.00</b>	<b>\$599.00</b>
dimensions (wxhxd)	14.4 x 15 x 27.6 (31.5)	14.4 x 15 x 27.6 (31.5)	14.4 x 15 x 27.6 (31.5)	14.4 x 15 x 27.6 (31.5)
metal color M1	0.00	0.00	0.00	0.00
body color LIGNOpal L6	0.00	0.00	0.00	0.00
front color LIGNOpal L6	--	0.00	--	0.00
alignment to user	left	left	right	right
with grommet in body	18.00	18.00	18.00	18.00
linking vertical standard - option for one-time linking	0.00	0.00	0.00	0.00
linking vertical with sleeve - option for repeated linking	18.00	18.00	18.00	18.00
locking 18001 as indicated	--	0.00	--	0.00

Two standard depths available for models 40055, 40056, 40057, 40058: 27.6" or 31.5"

**Material overview**

**Metal Colors**

- M1 030 terra grey
- 032 light blue
- 033 light green
- 041 turquoise
- 045 broom yellow
- 059 arctic
- 063 anthracite
- 065 black (RAL 9011)
- 071 sapphire blue (RAL 5003)
- 084 oxblood
- 091 white

**Laminate Colors**

- L6 017 astral silver
- 018 anthracite
- 019 plain black
- 027 natural beech laminate
- 028 natural maple laminate
- 029 natural walnut laminate
- 031 grey white
- 035 andes grey
- 328 white
- 340 natural oak laminate
- 415 terra grey

**MediaBox**  
Storage element for teacher workplaces.



Model	04418	04419
<b>Standard price</b>	<b>\$2,189.00</b>	<b>\$2,189.00</b>
overall dimensions (wxhxd)	15.95 x 30.45 x 40.4	15.95 x 30.45 x 40.4
body LIGNOpal, L6	0.00	0.00
top panel LIGNOpal, L6	0.00	0.00
cheek LIGNOpal, L3	0.00	0.00
unified locking 18001	0.00	0.00
locking as indicated	0.00	0.00
locking plan, site installat.	0.00	0.00
metal bow handle Ni- or Cr-plated	0.00	0.00
flush handle Ni-plated	0.00	0.00
with turning knob, lockable 18001 or as indicated	0.00	0.00
with turning knob, lockable locking plan site installat.	0.00	0.00
prepared for monitor arm	103.00	103.00
with monitor arm	730.00	730.00
with plastic bin 3in, C3	0.00	0.00
with plastic bin 6in, C3	0.00	0.00
with rails, without plastic bin	0.00	0.00
with cable outlet integrated in side panel	0.00	0.00

Veneers available upon request.

**Material overview**

**Plastic Colors**

- C3 001 red
- 014 anthracite
- 016 translucent
- 030 dark red
- 031 dark blue
- 032 light blue
- 033 light green
- 038 turquoise
- 039 broom yellow

**Laminate Colors**

- L3 017 astral silver
- 018 anthracite
- 019 plain black
- 027 natural beech laminate
- 028 natural maple laminate
- 029 natural walnut laminate
- 031 grey white
- 035 andes grey
- 328 white
- 340 natural oak laminate
- 415 terra grey

- L6 017 astral silver
- 018 anthracite
- 019 plain black
- 027 natural beech laminate
- 028 natural maple laminate
- 029 natural walnut laminate
- 031 grey white
- 035 andes grey
- 328 white
- 340 natural oak laminate
- 415 terra grey

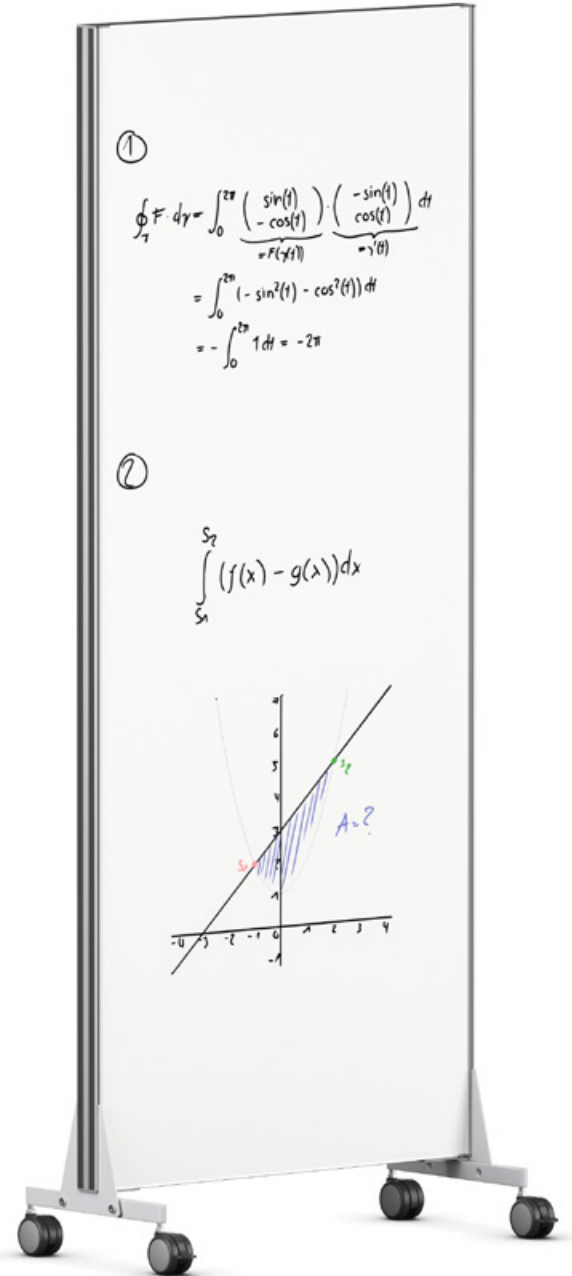



**Screens**

**LinkUp**  
Mobile partition wall.

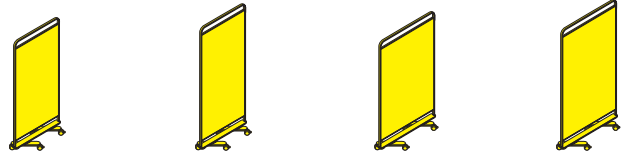

Model	05593	05591	05594	05592
<b>Base price</b>	<b>\$1,372.00</b>	<b>\$1,431.00</b>	<b>\$1,401.00</b>	<b>\$1,489.00</b>
dimensions (wxhxd)	32.3 x 60.25 x 12.6	32.3 x 68.15 x 12.6	40.2 x 60.25 x 12.6	40.2 x 68.15 x 12.6
frame made of metal Mx	0.00	0.00	0.00	0.00
surface steel enamel (magnetic whiteboard), white	0.00	0.00	0.00	0.00
surface cork board, natural	-204.00	-204.00	-204.00	-204.00
surface cork board with fabric S72	-87.00	-87.00	-87.00	-87.00
surface acoustically effective filling, fabric S46/54, S74	0.00	0.00	0.00	0.00
surface acoustically effective filling, fabric S51, S79	175.00	175.00	175.00	175.00
surface acoustically effective filling, fabric S78	117.00	117.00	117.00	117.00
with 2x linking magnets	0.00	0.00	0.00	0.00
without linking magnets	-145.00	-145.00	-145.00	-145.00
mobile on casters	0.00	0.00	0.00	0.00

*Knocked-down delivery for all items on this page.*

**Material overview**

**Metal Colors**

- Mx 059 arctic
- 065 black (RAL 9011)

**Fabrics**

- S46 Xtreme
- S51 Blazer
- S72 Sonos
- S74 Era
- S78 Step/StepMelange
- S79 Trevi D











# Soft Seating

**Series Lounge**  
Linear seating elements.

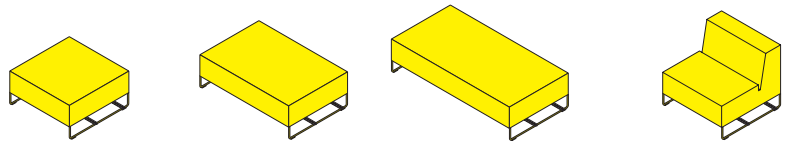

Model	30120	30121	30122	30125
<b>Standard price</b>	<b>\$1,781.00</b>	<b>\$2,101.00</b>	<b>\$2,422.00</b>	<b>\$2,422.00</b>
total dimensions (wxd)	31.5 x 31.5	47.25 x 31.5	63 x 31.5	31.5 x 31.5
seat height 15.75	0.00	0.00	0.00	0.00
seat height 18.15	35.00	35.00	35.00	35.00
metal color black RAL 9011	0.00	0.00	0.00	0.00
metal color M060	0.00	0.00	0.00	0.00
cover S40	0.00	0.00	0.00	0.00
cover S46/54	0.00	0.00	0.00	0.00
cover S51	135.00	170.00	202.00	213.00
cover S74	0.00	0.00	0.00	0.00
cover S78	88.00	105.00	126.00	126.00
cover S79	231.00	283.00	330.00	345.00
plastic glides	0.00	0.00	0.00	0.00
felt glides	9.00	9.00	9.00	9.00
2-component glides	12.00	12.00	12.00	12.00

**Material overview**

**Metal Colors**

Mx 065 black (RAL 9011)  
060 chrome-plated

**Fabrics**

S40 Stamskin  
S46/S54 Xtreme  
S51 Blazer  
S74 Era  
S78 Step/StepMelange  
S79 Trevi D

**Series Lounge**  
Linear seating elements.

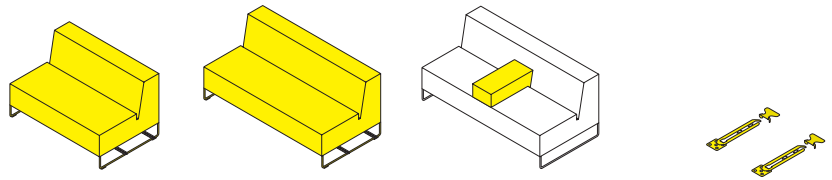

Model	30126	30127	30191	30190
<b>Standard price</b>	<b>\$3,020.00</b>	<b>\$3,210.00</b>	<b>\$439.00</b>	<b>\$54.00</b>
total dimensions (wxd)	47.25 x 31.5	63 x 31.5	10.25 x 20.65	--
seat height 15.75	0.00	0.00	--	--
seat height 18.15	35.00	35.00	--	--
metal color black RAL 9011	0.00	0.00	--	--
metal color M060	0.00	0.00	--	--
cover S40	0.00	0.00	0.00	--
cover S46/54	0.00	0.00	0.00	--
cover S51	263.00	327.00	62.00	--
cover S74	0.00	0.00	0.00	--
cover S78	126.00	196.00	41.00	--
cover S79	429.00	534.00	111.00	--
plastic glides	0.00	0.00	--	--
felt glides	9.00	9.00	--	--
2-component glides	12.00	12.00	--	--

**Material overview**

**Metal Colors**

Mx 065 black (RAL 9011)  
060 chrome-plated

**Fabrics**

S40 Stamskin  
S46/S54 Xtreme  
S51 Blazer  
S74 Era  
S78 Step/StepMelange  
S79 Trevi D

**Series Lounge**  
Chaise lounge and corner elements.

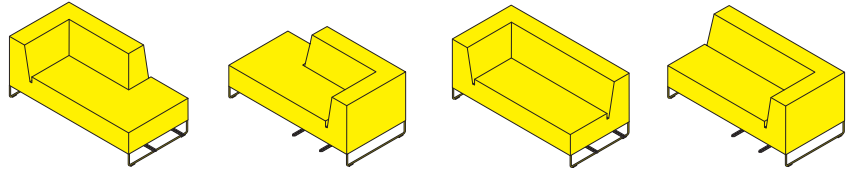

Model	30130	30131	30132	30133
<b>Standard price</b>	<b>\$4,056.00</b>	<b>\$4,056.00</b>	<b>\$4,056.00</b>	<b>\$4,056.00</b>
total dimensions (wxd)	63 x 31.5	63 x 31.5	63 x 31.5	63 x 31.5
seat height 15.75	0.00	0.00	0.00	0.00
seat height 18.15	35.00	35.00	35.00	35.00
metal color black RAL 9011	0.00	0.00	0.00	0.00
metal color M060	0.00	0.00	0.00	0.00
cover S40	0.00	0.00	0.00	0.00
cover S46/54	0.00	0.00	0.00	0.00
cover S51	397.00	397.00	412.00	412.00
cover S74	0.00	0.00	0.00	0.00
cover S78	254.00	254.00	245.00	245.00
cover S79	677.00	677.00	706.00	706.00
plastic glides	0.00	0.00	0.00	0.00
felt glides	9.00	9.00	9.00	9.00
2-component glides	12.00	12.00	12.00	12.00

**Material overview**

**Metal Colors**

- Mx 065 black (RAL 9011)
- 060 chrome-plated

**Fabrics**

- S40 Stamskin
- S46/S54 Xtreme
- S51 Blazer
- S74 Era
- S78 Step/StepMelange
- S79 Trevi D

**Series Lounge**  
Curved seating elements.

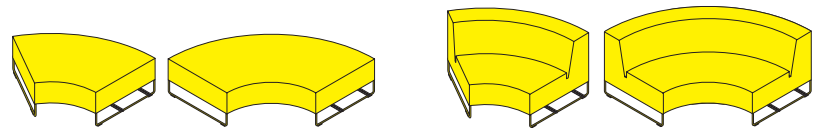

Model	30123	30124	30128	30129
<b>Standard price</b>	<b>\$2,583.00</b>	<b>\$3,224.00</b>	<b>\$3,574.00</b>	<b>\$4,770.00</b>
total dimensions (wxd)	55.15 x 31.5	78 <sup>3</sup> / <sub>4</sub> x 31.5	55.15 x 31.5	78.75 x 31.5
seat height 15.75	0.00	0.00	0.00	0.00
seat height 18.15	56.00	56.00	56.00	56.00
metal color black RAL 9011	0.00	0.00	0.00	0.00
metal color M060	0.00	0.00	0.00	0.00
cover S40	0.00	0.00	0.00	0.00
cover S46/54	0.00	0.00	0.00	0.00
cover S51	181.00	269.00	263.00	383.00
cover S74	0.00	0.00	0.00	0.00
cover S78	117.00	170.00	164.00	234.00
cover S79	301.00	441.00	429.00	630.00
plastic glides	0.00	0.00	0.00	0.00
felt glides	9.00	9.00	9.00	9.00
2-component glides	12.00	12.00	12.00	12.00

**Material overview**

**Metal Colors**

- Mx 065 black (RAL 9011)
- 060 chrome-plated

**Fabrics**

- S40 Stamskin
- S46/S54 Xtreme
- S51 Blazer
- S74 Era
- S78 Step/StepMelange
- S79 Trevi D

**Series Lounge**  
Curved seating elements.

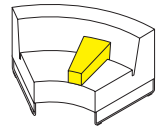

<b>Model</b>	<b>30192</b>
<b>Standard price</b>	<b>\$439.00</b>
total dimensions (wxd)	10.25 x 20.65
seat height 15.75	--
seat height 18.15	--
cover S40	0.00
cover S46/54	0.00
cover S51	62.00
cover S74	0.00
cover S78	41.00
cover S79	105.00
plastic glides	--
felt glides	--
2-component glides	--

**Material overview**

**Metal Colors**

Mx 060 chrome-plated

**Fabrics**

S40 Stamskin  
 S46/S54 Xtreme  
 S51 Blazer  
 S74 Era  
 S78 Step/StepMelange  
 S79 Trevi D

**Series Lounge**  
HiBack seating elements.

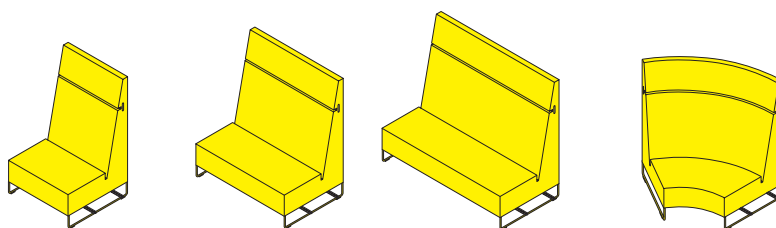

Model	30110	30113	30111	30112
<b>Standard price</b>	<b>\$4,406.00</b>	<b>\$4,843.00</b>	<b>\$5,587.00</b>	<b>\$5,368.00</b>
total dimensions (wxd)	31.5 x 31.5	47.25 x 31.5	63 x 31.5	55.15 x 31.5
seat height 15.75	0.00	0.00	0.00	0.00
seat height 18.15	35.00	35.00	35.00	56.00
metal color black RAL 9011	0.00	0.00	0.00	0.00
metal color M060	0.00	0.00	0.00	0.00
cover S40	0.00	0.00	0.00	0.00
cover S46/54	0.00	0.00	0.00	0.00
cover S51	263.00	345.00	467.00	383.00
cover S74	0.00	0.00	0.00	0.00
cover S78	155.00	208.00	283.00	234.00
cover S79	464.00	563.00	776.00	625.00
plastic glides	0.00	0.00	0.00	0.00
felt glides	9.00	9.00	9.00	9.00
2-component glides	12.00	12.00	12.00	12.00

**Material overview**

**Metal Colors**

Mx 065 black (RAL 9011)  
060 chrome-plated

**Fabrics**

S40 Stamskin  
S46/S54 Xtreme  
S51 Blazer  
S74 Era  
S78 Step/StepMelange  
S79 Trevi D

**Series Lounge Chair**  
Round chair.



<b>Model</b>	<b>30186</b>	<b>30188</b>
<b>Standard price</b>	<b>\$5,820.00</b>	<b>\$3,531.00</b>
seat height 16.95 (No. 5 green)	0.00	0.00
seat height 18.15 (No. 6 blue)	0.00	0.00
<hr/>		
metal color black RAL 9011	0.00	0.00
metal color M060	0.00	0.00
<hr/>		
cover S40	0.00	0.00
cover S46/54	0.00	0.00
cover S51	307.00	225.00
cover S78	155.00	117.00
cover S79	523.00	377.00
<hr/>		
plastic glides	0.00	0.00
felt glides	0.00	0.00
glides with steel cap	0.00	0.00
<hr/>		
with reset function	--	30.00

**Material overview**

**Metal Colors**

Mx 065 black (RAL 9011)  
060 chrome-plated

**Fabrics**

S40 Stamskin  
S46/S54 Xtreme  
S51 Blazer  
S78 Step/StepMelange  
S79 Trevi D

**Series Lounge/RondoLounge**  
Occasional tables.

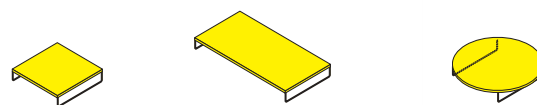

Model	20100	20102	20101
<b>Standard price</b>	<b>\$585.00</b>	<b>\$731.00</b>	<b>\$658.00</b>
dimensions (wxd) (Ø)	31.5 x 31.5	63 x 31.5	43.35
table height 7.5	0.00	0.00	0.00
table height 12.8	62.00	62.00	62.00
metal color black RAL 9011	0.00	0.00	0.00
metal color M060	35.00	35.00	35.00
top LIGNOpal with 2.5mm edge L6	0.00	0.00	0.00
plastic glides	0.00	0.00	0.00
felt glides	9.00	9.00	9.00
2-component glides	0.00	0.00	0.00

*Veneers and Linoleum available upon request.*

**Material overview**

**Metal Colors**

- Mx 065 black (RAL 9011)
- 060 chrome-plated

**Laminate Colors**

- L6 017 astral silver
- 018 anthracite
- 019 plain black
- 027 natural beech laminate
- 028 natural maple laminate
- 029 natural walnut laminate
- 031 grey white
- 035 andes grey
- 328 white
- 340 natural oak laminate
- 415 terra grey

**Series Lounge Tables**  
Occasional tables.

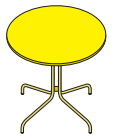
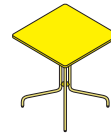
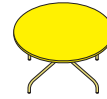
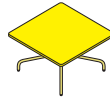

Model	20110	20111	20112	20113
<b>Standard price</b>	<b>\$847.00</b>	<b>\$949.00</b>	<b>\$979.00</b>	<b>\$1,008.00</b>
dimensions (wxd) (Ø)	23.65 x 23.65	27.6	23.65 x 23.65	27.6
table height	13.8	13.8	26.8	26.8
metal color black RAL 9011	0.00	0.00	0.00	0.00
metal color M060	464.00	464.00	464.00	464.00
top LIGNOpal with 2.5mm edge L6	0.00	0.00	0.00	0.00
plastic glides	0.00	0.00	0.00	0.00
felt glides	0.00	0.00	0.00	0.00
2-component glides	--	--	--	--
pivoted glides with steel cap	0.00	0.00	0.00	0.00

*Veneers available upon request.*

**Material overview**

Mx 065 black (RAL 9011)  
060 chrome-plated

**Laminate Colors**

L6 017 astral silver  
018 anthracite  
019 plain black  
027 natural beech laminate  
028 natural maple laminate  
029 natural walnut laminate  
031 grey white  
035 andes grey  
328 white  
340 natural oak laminate  
415 terra grey

**Series Lounge Tables**  
Occasional tables.

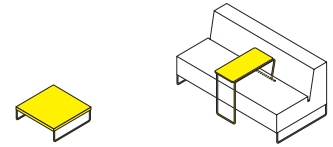

Model	20106	20114
<b>Standard price</b>	<b>\$847.00</b>	<b>\$818.00</b>
dimensions (wxd) (Ø)	23.65 x 23.65	25.6 x 11.85
table height	7.5 / 12.8	24.05 / 26.4
metal color black RAL 9011	0.00	0.00
metal color M060	94.00	0.00
top LIGNOpal with 2.5mm edge L6	0.00	0.00
plastic glides	0.00	0.00
felt glides	0.00	0.00
2-component glides	0.00	0.00
pivoted glides with steel cap	--	--

*Veneers available upon request.*

**Material overview**

Mx 065 black (RAL 9011)  
060 chrome-plated

**Laminate Colors**

L6 017 astral silver  
018 anthracite  
019 plain black  
027 natural beech laminate  
028 natural maple laminate  
029 natural walnut laminate  
031 grey white  
035 andes grey  
328 white  
340 natural oak laminate  
415 terra grey

**RondoLounge-R**  
 Lounge table with round tube column and round plate base.



Model	22254	22255	22256*
<b>Standard price</b>	<b>\$1,606.00</b>	<b>\$1,635.00</b>	<b>\$1,693.00</b>
dimensions (wxd) (Ø)	27.6	31.5	35.45
table height 15.4	0.00	0.00	0.00
table height 17.75	0.00	0.00	0.00
metal color M2	0.00	0.00	0.00
top 19mm chipboard laminated (CPL), 2.5mm KU edge, color laminate L2	0.00	0.00	0.00
top 19mm chipboard laminated (CPL) writeable, 2.5mm KU edge in white	82.00	103.00	120.00
adjustable plastic glides	0.00	0.00	0.00
adjustable glides with felt	0.00	0.00	0.00

*\*Knocked-down delivery for marked models.*

**Material overview**

**Metal Colors**

- M2 059 arctic
- 063 anthracite
- 065 black (RAL 9011)
- 091 white

**Laminate Colors**

- L2 027 natural beech laminate
- 028 natural maple laminate
- 031 grey white
- 035 andes grey
- 328 white

**RondoLounge-Q**  
 Lounge table with square tubular column and square plate base.

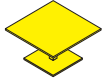

Model	22250	22251	22252*
<b>Standard price</b>	<b>\$1,431.00</b>	<b>\$1,460.00</b>	<b>\$1,547.00</b>
dimensions (wxd)	27.6 x 27.6	31.5 x 31.5	35.45 x 35.45
table height 15.4	0.00	0.00	0.00
table height 17.75	0.00	0.00	0.00
metal color M2	0.00	0.00	0.00
top 19mm chipboard laminated (CPL), 2.5mm KU edge, color laminate L2	0.00	0.00	0.00
top 19mm chipboard laminated (CPL) writeable, 2.5mm KU edge in white	82.00	91.00	103.00
adjustable plastic glides	0.00	0.00	0.00
adjustable glides with felt	0.00	0.00	0.00

*\*Knocked-down delivery for marked models.*

**Material overview**

**Metal Colors**

- M2 059 arctic
- 063 anthracite
- 065 black (RAL 9011)
- 091 white

**Laminate Colors**

- L2 027 natural beech laminate
- 028 natural maple laminate
- 031 grey white
- 035 andes grey
- 328 white

**AddLounge-R**  
 Lounge and laptop table with round tubular column.



<b>Model</b>	<b>20108</b>
<b>Standard price</b>	<b>\$462.00</b>
dimensions (wxd) (Ø)	19.7
table height 18.85	0.00
table height 26.7	0.00
metal color black (RAL 9011)	0.00
top 19mm chipboard laminated (CPL), 2.5mm KU edge, color laminate L2	0.00
top 19mm chipboard laminated (CPL) writeable, 2.5mm KU edge in white	33.00
felt glides	0.00

**Material overview**

**Metal Colors**

Mx 065 black (RAL 9011)

**Laminate Colors**

L2 027 natural beech laminate  
 028 natural maple laminate  
 031 grey white  
 035 andes grey  
 328 white

**AddLounge-Q**  
Lounge and laptop table with square tubular column.



Model	20107
<b>Standard price</b>	<b>\$462.00</b>
dimensions (wxd)	21.7 x 15.75
table height 18.85	0.00
table height 26.7	0.00
metal color black (RAL 9011)	0.00
top 19mm chipboard laminated (CPL), 2.5mm KU edge, color laminate L2	0.00
top 19mm chipboard laminated (CPL) writeable, 2.5mm KU edge in white	33.00
felt glides	0.00

**Material overview**

**Metal Colors**

Mx 065 black (RAL 9011)

**Laminate Colors**

L2 027 natural beech laminate  
 028 natural maple laminate  
 031 grey white  
 035 andes grey  
 328 white

**ClubLounge**  
Seat elements.

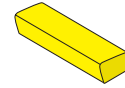

Model	09390	09391	09392	09393
<b>Standard price</b>	<b>\$818.00</b>	<b>\$1,168.00</b>	<b>\$1,372.00</b>	<b>\$1,256.00</b>
total dimensions (wxhxd)	20.9 x 13.4 x 21.5	41.75 x 13.4 x 21.5	62.6 x 13.4 x 21.5	20.9 x 25.6 x 24.6
seat height	13.4	13.4	13.4	13.4
cover S40	0.00	0.00	0.00	0.00
cover S64	0.00	0.00	0.00	0.00
cover S82	0.00	0.00	0.00	0.00
plastic glides	0.00	0.00	0.00	0.00
felt glides	0.00	0.00	0.00	0.00
2-component glides	0.00	0.00	0.00	0.00

**Material overview**

**Fabrics**

- S40 Stamskin Top
- S64 Mover
- S82 Evida

**ClubLounge**  
Seat elements.

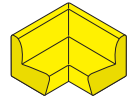
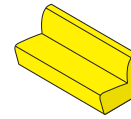
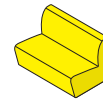

Model	09394	09395	09396
<b>Standard price</b>	<b>\$1,970.00</b>	<b>\$2,554.00</b>	<b>\$3,837.00</b>
total dimensions (wxhxd)	41.75 x 25.6 x 24.6	62.6 x 25.6 x 24.6	41.75 x 25.6 x 41.75
seat height	13.4	13.4	13.4
cover S40	0.00	0.00	0.00
cover S64	0.00	0.00	0.00
cover S82	0.00	0.00	0.00
plastic glides	0.00	0.00	0.00
felt glides	0.00	0.00	0.00
2-component glides	0.00	0.00	0.00

**Material overview**

**Fabrics**

S40 Stamskin Top

S64 Mover

S82 Evida

**ClubLounge**  
Seat elements.

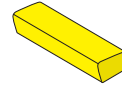

Model	09350	09351	09356	09352
<b>Standard price</b>	<b>\$935.00</b>	<b>\$1,591.00</b>	<b>\$2,218.00</b>	<b>\$1,562.00</b>
total dimensions (wxhxd)	25.6 x 16.55 x 22.05	51.2 x 16.55 x 22.05	70.9 x 16.55 x 22.05	26 x 31.5 x 34.65
seat height	16.55	16.55	16.55	16.55
cover S40	0.00	0.00	0.00	0.00
cover S64	0.00	0.00	0.00	0.00
cover S82	0.00	0.00	0.00	0.00
plastic glides	0.00	0.00	0.00	0.00
felt glides	0.00	0.00	0.00	0.00
2-component glides	0.00	0.00	0.00	0.00

**Material overview**

**Fabrics**

S40 Stamskin Top

S64 Mover

S82 Evida

**ClubLounge**  
Seat elements.

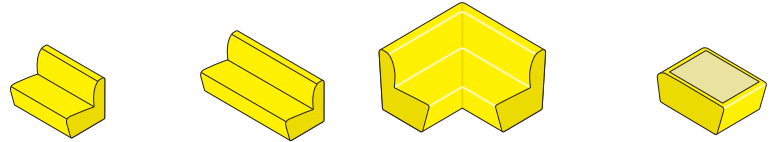

Model	09353	09357	09354	09355
<b>Standard price</b>	<b>\$2,656.00</b>	<b>\$3,749.00</b>	<b>\$4,683.00</b>	<b>\$1,504.00</b>
total dimensions (wxhxd)	51.2 x 31.5 x 34.65	70.9 x 31.5 x 34.65	51.2 x 32 x 51.2	33.5 x 16.55 x 25.6
seat height	16.55	16.55	16.55	16.55
cover S40	0.00	0.00	0.00	0.00
cover S64	0.00	0.00	0.00	0.00
cover S82	0.00	0.00	0.00	0.00
plastic glides	0.00	0.00	0.00	0.00
felt glides	0.00	0.00	0.00	0.00
2-component glides	0.00	0.00	0.00	0.00

**Material overview**

**Fabrics**

S40 Stamskin Top

S64 Mover

S82 Evida



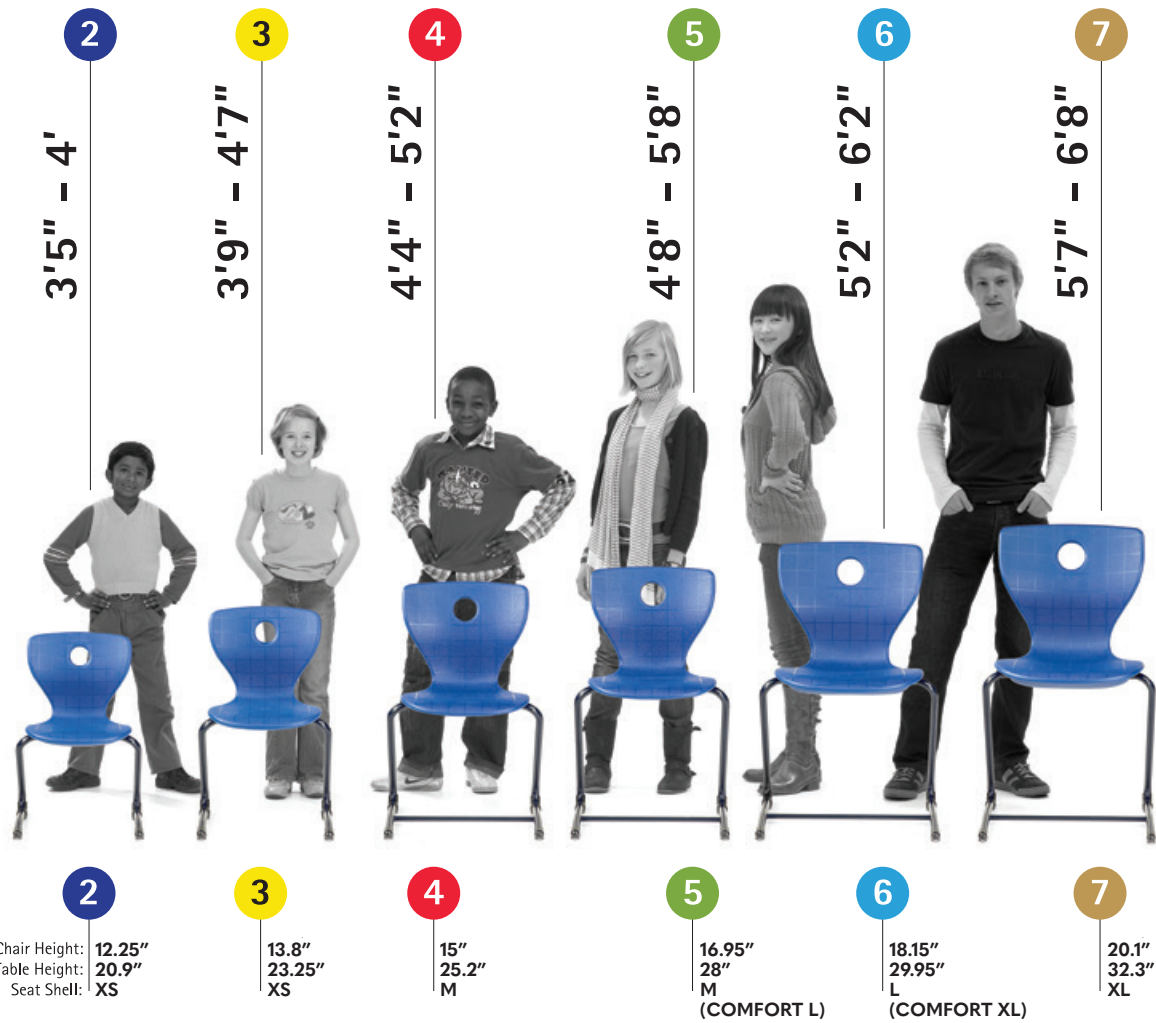

Size	Student height	Color code	Chair Height	Table Height	Standing Table Height	Seat Shell
2	3'5"-4'	violet	12.25"	20.9"	26.4"	S
3	3'9"-4'7"	yellow	13.8"	23.25"	29.95"	S
4	4'4"-5'2"	red	15"	25.2"	34.65"	M
5	4'8"-5'8"	green	16.95"	28"	39.4"	M (COMFORT L)
6	5'2"-6'2"	blue	18.15"	29.95"	41.75"	L (COMFORT XL)
7	5'7"-6'8"	brown	20.1"	32.3"	47.25"	XL

Seat shell sizes (w, d): S (12.65", 11"); M (14.65", 14.25"); L (17", 16.5"); XL (17.9", 17.75")



For additional information on products please visit [www.vsamerica.com](http://www.vsamerica.com) or contact VS America, Inc. at 704.378.6500.

All illustrations were up-to-date at the time of going to print. In the interests of product improvement, we reserve the right to make technical or design changes at any time.



Art-No. 010126 V01

**VS America, Inc.:**

**1940 Abbott Street  
Charlotte, NC 28203**

**Phone: 704.378.6500**

**Fax: 704.378.6005**

**info@vsamerica.com  
www.vsamerica.com**